



Staff Report for Item 10a

To: Chairman Bryan Green and Historic Architectural Review
Commission Members

From: Kelly Perkins
HARC Assistant Planner

Meeting Date: September 29, 2015

Applicant: FMH Builders, Inc.

Application Number: H15-01-1313

Address: #524 Elizabeth Street

Description of Work:

New exterior wood staircase.

Site Facts:

The two-story, frame structure is listed as a contributing resource in the survey and first appears on the 1912 Sanborn map. By 1926, an exterior staircase had been constructed on the south side of the building. The existing staircase is not a historic staircase and is in poor condition and needs to be replaced.

Guidelines Cited in Review:

Entrances, porches, and doors (pages 32-33), specifically guideline 13 and 14.

Staff Analysis

The Certificate of Appropriateness in review proposes the demolition of a non-historic staircase on the south side of a contributing structure and the construction of a new exterior staircase. The staircase is in poor condition and needs to be demolished according to the Chief Building Official.

Consistency with Guidelines

1. The staircase is not historic, but is necessary for the building to function as a multiple unit dwelling.
2. The proposed staircase will meet current safety codes.

It is staff's opinion that the proposed plan is consistent with the guidelines pertaining to exterior staircases under the Entrances, Porches, and Doors' section. The proposed staircase will mostly be in the same footprint with the same design, and will meet current safety codes.

APPLICATION

COMBINATION APPLICATION: FLOODPLAIN, CONSTRUCTION AND HARC

\$50.00 APPLICATION FEE NON-REFUNDABLE



City of Key West

3140 FLAGLER AVENUE
KEY WEST, FLORIDA 33040

Phone: 305.809.3956

HARC PERMIT NUMBER <i>15-01-1313</i>		BUILDING PERMIT NUMBER <i>15-3522</i>		INITIAL & DATE
FLOODPLAIN PERMIT				REVISION #
FLOOD ZONE	PANEL #	ELEV. L. FL.	SUBSTANTIAL IMPROVEMENT <input type="checkbox"/> YES <input type="checkbox"/> NO _____ %	

ADDRESS OF PROPOSED PROJECT:	524 ELIZABETH ST			# OF UNITS
RE # OR ALTERNATE KEY:	1009288			
NAME ON DEED:	KDC PROPERTIES OF KEY WEST LLC	PHONE NUMBER	305-296-6265	
OWNER'S MAILING ADDRESS:	PO BOX 4125	EMAIL		
	KEY WEST FL			
CONTRACTOR COMPANY NAME:	FMH BUILDERS, INC	PHONE NUMBER	305-797-2002	
CONTRACTOR'S CONTACT PERSON:	FRANK HERRADA	EMAIL		
ARCHITECT / ENGINEER'S NAME:		PHONE NUMBER		
ARCHITECT / ENGINEER'S ADDRESS:		EMAIL		

HARC: PROJECT LOCATED IN HISTORIC DISTRICT OR IS CONTRIBUTING. YES NO (SEE PART C FOR HARC APPLICATION.)

CONTRACT PRICE FOR PROJECT OR ESTIMATED TOTAL FOR MAT'L., LABOR & PROFIT: ~~25,000.00~~ **\$15,000**

FLORIDA STATUTE 837.06: WHOEVER KNOWINGLY MAKES A FALSE STATEMENT IN WRITING AND WITH THE INTENT TO MISLEAD A PUBLIC SERVANT IN THE PERFORMANCE OF HIS OR HER OFFICIAL DUTY SHALL BE GUILTY OF A MISDEMEANOR OF THE SECOND DEGREE PUNISHABLE PER SECTION 775.082 OR 775.083.

PROJECT TYPE:	<input type="checkbox"/> ONE OR TWO FAMILY	<input checked="" type="checkbox"/> MULTI-FAMILY	<input type="checkbox"/> COMMERCIAL	<input type="checkbox"/> NEW	<input checked="" type="checkbox"/> REMODEL
	<input type="checkbox"/> CHANGE OF USE / OCCUPANCY	<input type="checkbox"/> ADDITION	<input type="checkbox"/> SIGNAGE	<input type="checkbox"/> WITHIN FLOOD ZONE	
	<input type="checkbox"/> DEMOLITION	<input type="checkbox"/> SITE WORK	<input type="checkbox"/> INTERIOR	<input checked="" type="checkbox"/> EXTERIOR	<input type="checkbox"/> AFTER-THE-FACT

DETAILED PROJECT DESCRIPTION INCLUDING QUANTITIES, SQUARE FOOTAGE ETC., REMOVE EXISTING ROTTED STAIRS AND ROOF

AS PER DRAWING WTH NEW WOOD , PAINT WHITE (I MET WITH RON WAMPLER WE BOTH AGREED STAIRS NEED TO BE REPLACED)

I'VE OBTAINED ALL NECESSARY APPROVALS FROM ASSOCIATIONS, GOVT AGENCIES AND OTHER PARTIES AS APPLICABLE TO COMPLETE THE DESCRIBED PROJECT:	
OWNER PRINT NAME:	QUALIFIER PRINT NAME: FRANK HERRADA
OWNER SIGNATURE:	QUALIFIER SIGNATURE: <i>Frank Herrada</i>
Notary Signature as to owner:	Notary Signature as to qualifier: <i>Kimberly Ann Rogers</i>
STATE OF FLORIDA; COUNTY OF MONROE, SWORN TO AND SCRIBED BEFORE ME THIS <u>15</u> DAY OF <u>SEPTEMBER</u> , 20 <u>15</u>	STATE OF FLORIDA; COUNTY OF MONROE, SWORN TO AND SCRIBED BEFORE ME THIS <u>18</u> DAY OF <u>SEPTEMBER</u> , 20 <u>15</u>
Personally known or produced as identification.	Personally known or produced as identification.

12438-22979-OK 12438-22977-OK
 12438-22979-OK 12438-22977-OK

PART B: SUPPLEMENTARY PROJECT DETAILS TO AVOID DELAYS / CALL-BACKS

PROPERTY STRUCTURES AFFECTED BY PROJECT: MAIN STRUCTURE ACCESSORY STRUCTURE SITE

ACCESSORY STRUCTURES: GARAGE / CARPORT DECK FENCE OUTBUILDING / SHED

FENCE STRUCTURES: 4 FT. 6 FT. SOLID 6 FT. / TOP 2 FT. 50% OPEN

POOLS: INGROUND ABOVE GROUND SPA / HOT TUB PRIVATE PUBLIC

PUBLIC POOLS REQUIRE BD. OF HEALTH LICENSE APPLICATION AT TIME OF CITY APPLICATION.
PUBLIC POOLS REQUIRE BD. OF HEALTH LICENSE PRIOR TO RECEIVING THE CITY CERTIFICATE OF OCCUPANCY.

ROOFING: NEW ROOF-OVER TEAR-OFF REPAIR AWNING
 5 V METAL ASPLT. SHGLS. METAL SHGLS. BLT. UP TPO OTHER

FLORIDA ACCESSIBILITY CODE: 20% OF PROJECT FUNDS INVESTED IN ACCESSIBILITY FEATURES.

SIGNAGE: # OF SINGLE FACE # OF DOUBLE FACE REPLACE SKIN ONLY BOULEVARD ZONE
 POLE WALL PROJECTING AWNING HANGING WINDOW

SQ. FT. OF EACH SIGN FACE:

SUBCONTRACTORS / SPECIALTY CONTRACTORS SUPPLEMENTARY INFORMATION:

MECHANICAL: DUCTWORK COMMERCIAL EXH. HOOD INTAKE / EXH. FANS LPG TANKS
A / C: COMPLETE SYSTEM AIR HANDLER CONDENSER MINI-SPLIT

ELECTRICAL: LIGHTING RECEPTACLES HOOK-UP EQUIPMENT LOW VOLTAGE
SERVICE: OVERHEAD UNDERGROUND 1 PHASE 3 PHASE _____ AMPS

PLUMBING: ONE SEWER LATERAL PER BLDG. INGROUND GREASE INTCPTRS. LPG TANKS

RESTROOMS: MEN'S WOMEN'S UNISEX ACCESSIBLE

PART C: HARC APPLICATION FOR A CERTIFICATE OF APPROPRIATENESS

APPLICATION FEES: PAINTING SINGLE FAMILY: \$10 STAFF APPROVAL: \$50 COMMISSION REVIEW \$100

PLEASE ATTACH APPROPRIATE VARIANCES / RESOLUTIONS FROM HARC, PLANNING BOARD OR TREE COMMISSION.

ATTENTION: NO BUILDING PERMITS WILL BE ISSUED PRIOR TO HARC APPROVAL.

PLEASE SEND ELECTRONIC SUBMISSIONS TO: harc@cityofkeywest-fl.gov

INDICATE TYPE OF CERTIFICATE OF APPROPRIATENESS: GENERAL DEMOLITION SIGN PAINTING OTHER

ADDITIONAL INFORMATION: REPALCE ROTTED STAIRS LANDINGS AND ROOF _____

PROJECT SPECIFICATIONS: PLEASE PROVIDE PHOTOS OF EXISTING CONDITIONS, PLANS, PRODUCT SAMPLES, TECHNICAL DATA		
ARCHITECTURAL FEATURES TO BE ALTERED:	ORIGINAL MATERIAL:	PROPOSED MATERIAL:
NONE	WOOD	WOOD

DEMOLITION: PLEASE FILL OUT THE HARC APPENDIX FOR PROPOSED DEMOLITION.

DEMOLITION OF HISTORIC STRUCTURES IS NOT ENCOURAGED BY THE HISTORIC ARCHITECTURAL REVIEW COMMISSION.

SIGNAGE: (SEE PART B) BUSINESS SIGN BRAND SIGN OTHER: _____

BUSINESS LICENSE # _____ IF FAÇADE MOUNTED, SQ. FT. OF FAÇADE _____

SIGN SPECIFICATIONS		
SIGN COPY:	PROPOSED MATERIALS:	SIGNS WITH ILLUMINATION:
		TYPE OF LTG.:
		LTG. LINEAL FTG.:
MAX. HGT. OF FONTS:		COLOR AND TOTAL LUMENS:
IF USING LIGHT FIXTURES PLEASE INDICATE HOW MANY: INCLUDE SPEC. SHEET WITH LOCATIONS AND COLORS.		

OFFICIAL USE ONLY: HARC STAFF OR COMMISSION REVIEW		
<input type="checkbox"/> APPROVED	<input type="checkbox"/> NOT APPROVED	<input type="checkbox"/> DEFERRED FOR FUTURE CONSIDERATION <input type="checkbox"/> TABLED FOR ADD'L. INFO. <input type="checkbox"/>
HARC MEETING DATE:	HARC MEETING DATE:	HARC MEETING DATE:
REASONS OR CONDITIONS:		
STAFF REVIEW COMMENTS:		
HARC PLANNER SIGNATURE AND DATE:		HARC CHAIRPERSON SIGNATURE AND DATE:

PART D: STATE OF FLORIDA OFFICIAL NOTIFICATIONS AND WARNINGS

FLORIDA STATUTE 713.135: WARNING TO OWNER: YOUR FAILURE TO RECORD A 'NOTICE OF COMMENCEMENT' MAY RESULT IN YOUR PAYING TWICE FOR IMPROVEMENTS TO YOUR PROPERTY. A NOTICE OF COMMENCEMENT MUST BE RECORDED WITH THE COUNTY RECORDER AND A COPY POSTED ON THE JOB SITE BEFORE THE FIRST INSPECTION. IF YOU INTEND TO OBTAIN FINANCING CONSULT WITH YOUR LENDER OR AN ATTORNEY BEFORE RECORDING A NOTICE.

FLORIDA STATUTE 469: ABESTOS ABATEMENT. AS OWNER / CONTRACTOR / AGENT OF RECORD FOR THE CONSTRUCTION APPLIED FOR IN THIS APPLICATION, I AGREE THAT I WILL COMPLY WITH THE PROVISIONS F. S. 469.003 AND TO NOTIFY THE FLORIDA D. E. P. OF MY INTENT TO DEMOLISH / REMOVE ASBESTOS. IN ADDITION TO THE REQUIREMENTS OF THIS PERMIT APPLICATION, THERE MAY BE DEED RESTRICTIONS AND / OR ADDITIONAL RESTRICTIONS APPLICABLE TO THIS PROPERTY THAT MAY BE FOUND IN THE PUBLIC RECORDS OF MONROE COUNTY AND THERE MAY BE ADDITIONAL PERMITS REQUIRED FROM OTHER GOVERNMENT ENTITIES SUCH AS AQUADUCT AUTHORITY, FLORIDA DEP OR OTHER STATE AGENCIES; ARMY CORPS OF ENGINEERS OR OTHER FEDERAL AGENCIES.

FEDERAL LAW REQUIRES LEAD PAINT ABATEMENT PER THE STANDARDS OF THE USEP ON STRUCTURES BUILT PRIOR TO 1978.

OFFICIAL USE ONLY BY PLANS EXAMINER OR CHIEF BUILDING OFFICIAL:				CBO OR PL. EXAM. APPROVAL:
HARC FEES:	BLDG. FEES:	FIRE MARSHAL FEE:	IMPACT FEES:	DATE:
				Order: KEYWLD Date: 8/24/15 20 2015 1001313
				Type: BP Receipt no: 34654
				* BUILDING PERMITS-NEW
				Trans number: 1.00 \$100.00
				CK CHECK 3134 \$150.00
				Trans date: 8/21/15 Time: 16:26:26

*Planning
Approved
TD 8/29/15*

SANBORN MAPS

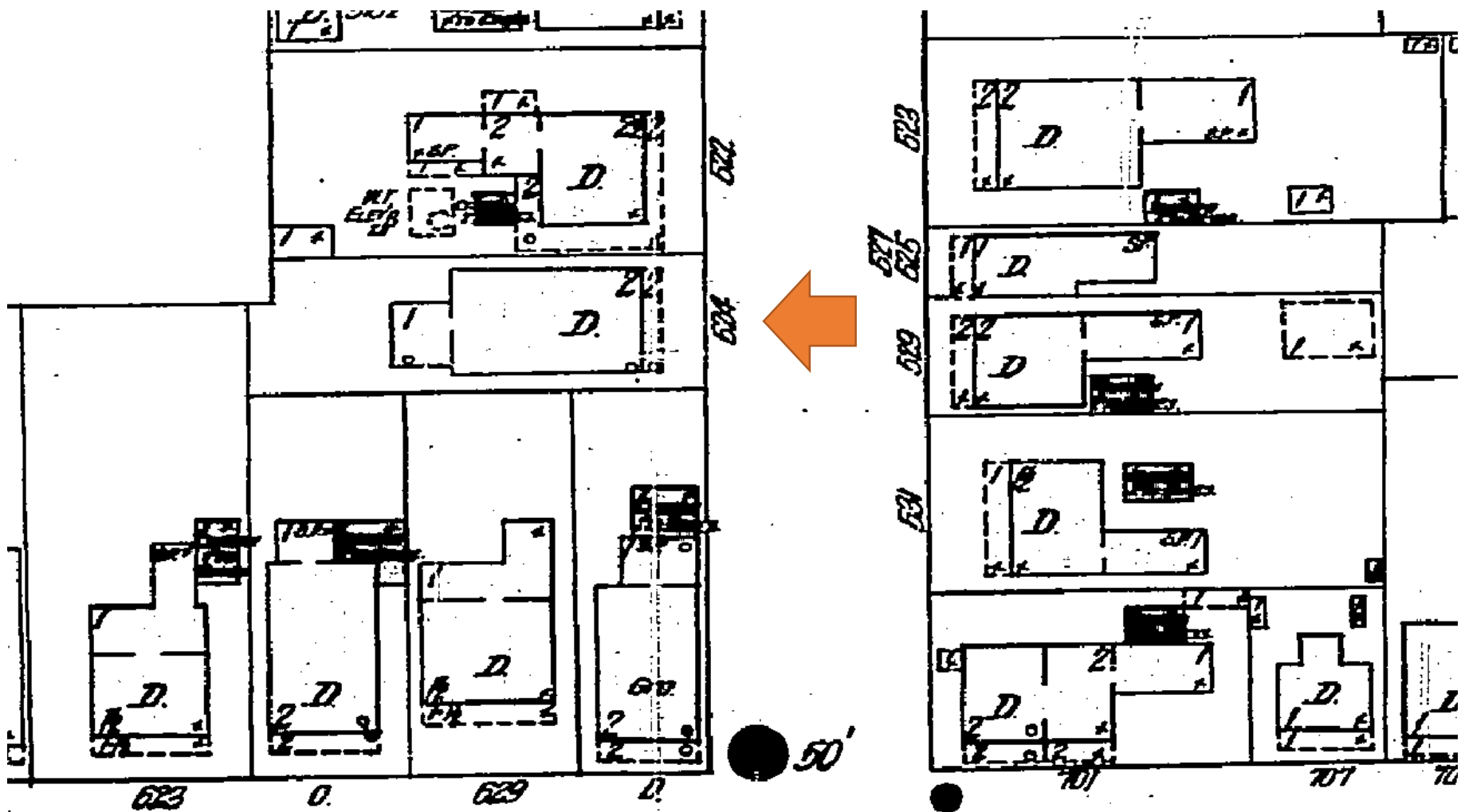

1912 Sanborn Map

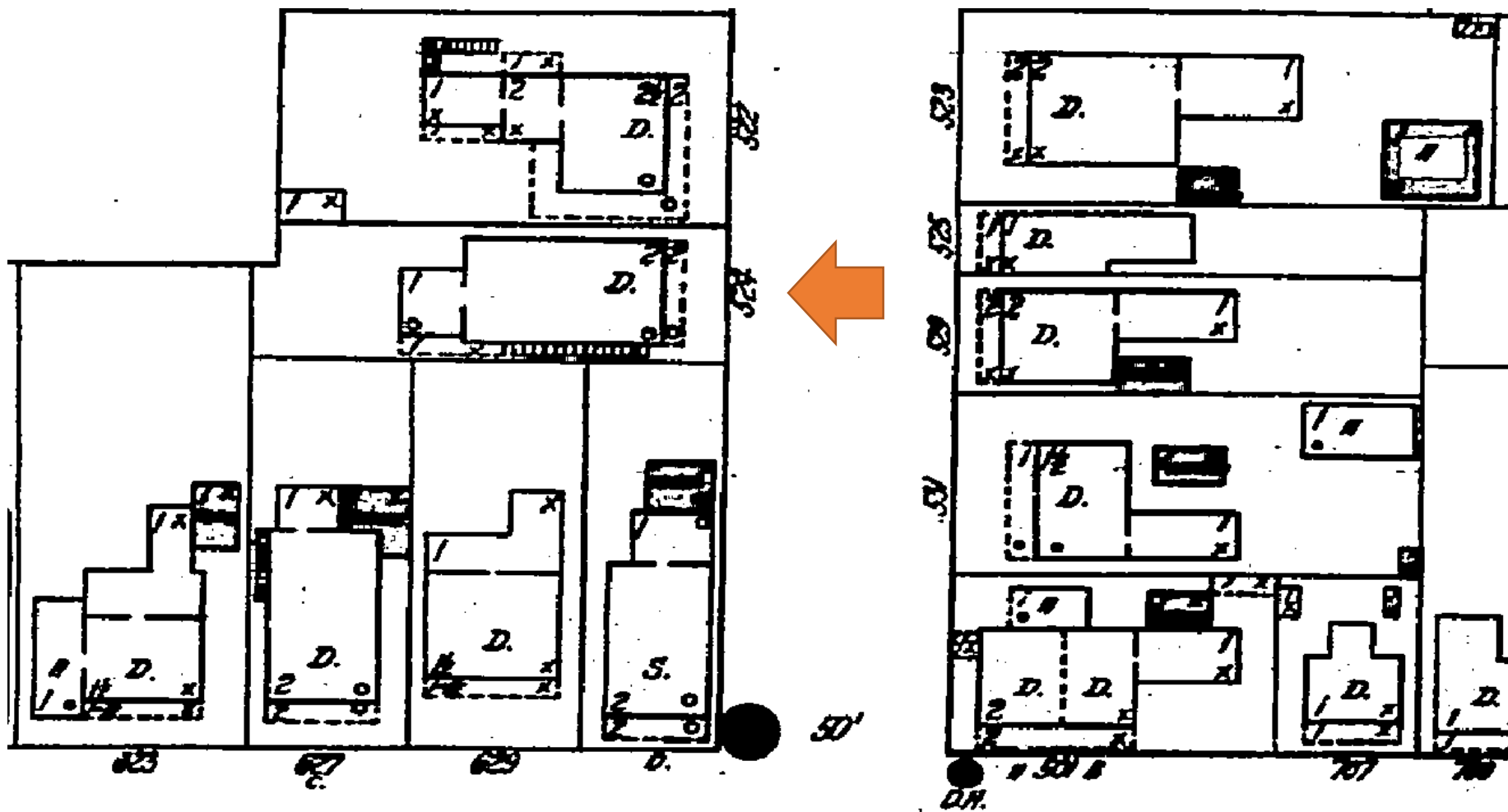

1926 Sanborn Map

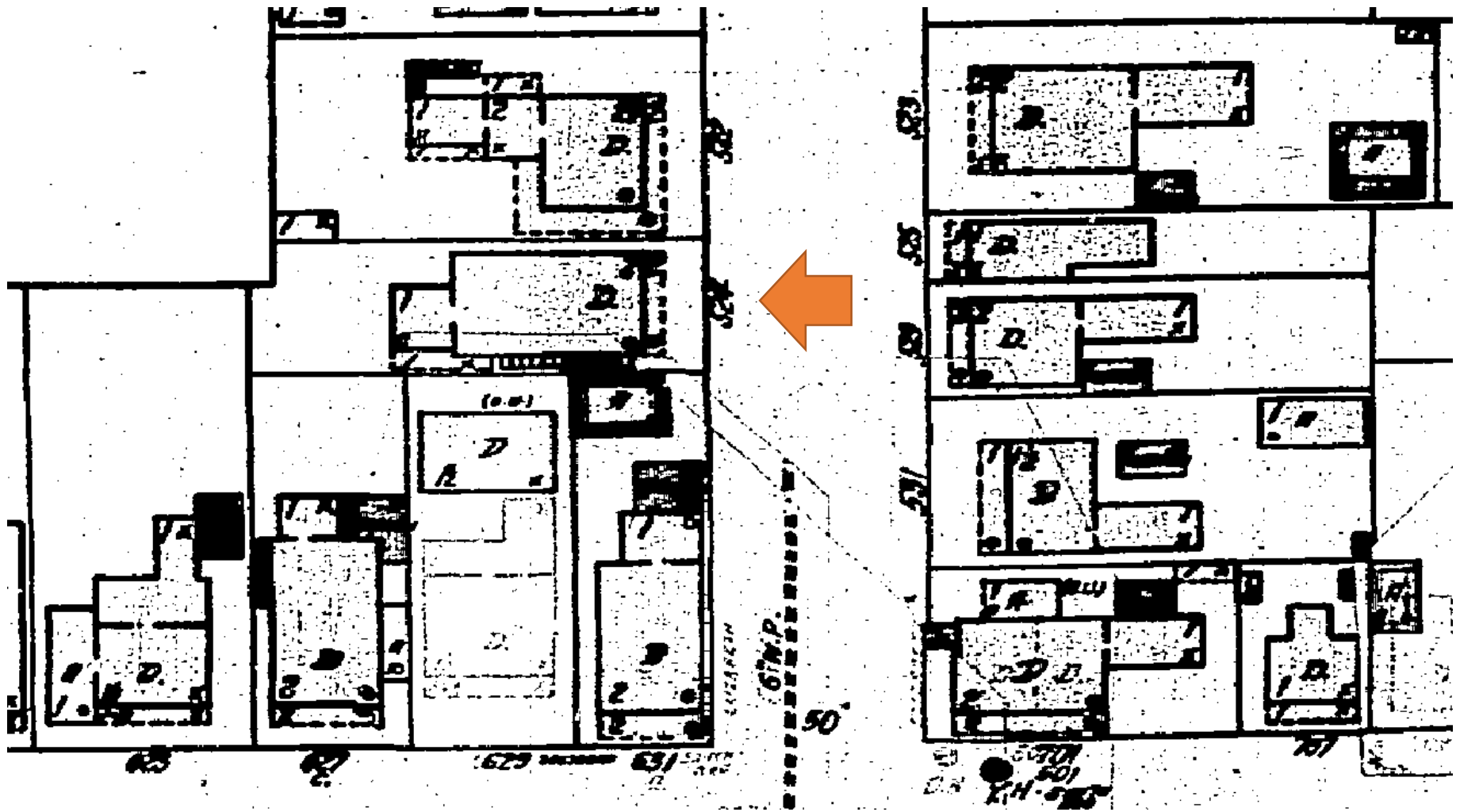

1948 Sanborn Map

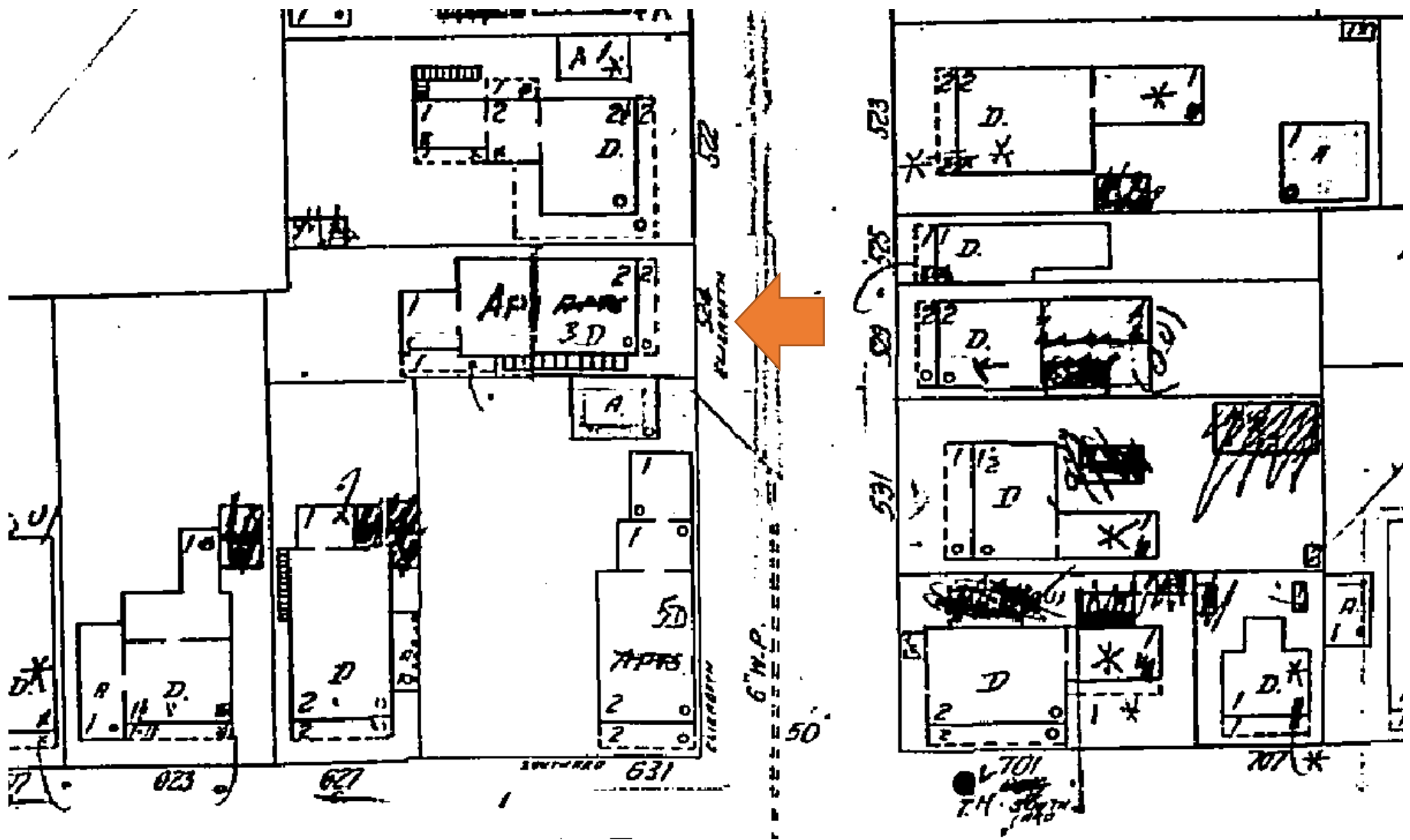

1962 Sanborn Map

PROJECT PHOTOS



Property Appraiser's Photograph, c. 1965. Monroe County Public Library.



PROPOSED DESIGN

SITE DATA

ZONING DISTRICT: HHDR
 FLOOD ZONE: X
 F.I.R.M. - COMMUNITY #120168; PANEL #1516; SUFFIX "K"; DATED: 02-18-2005
 LEGAL DESCRIPTION: PART OF LOT 1, SQUARE 49, ISLAND OF KEY WEST

DESIGN DATA

THE WORK DEPICTED HEREIN WAS DESIGNED TO MEET THE REQUIREMENTS OF THE FLORIDA BUILDING CODE, 5TH EDITION (2014).
 OCCUPANCY CLASSIFICATION: R2
 CONSTRUCTION TYPE: V
 THE FOLLOWING LOADINGS WERE USED:
 WIND LOAD: 180 MPH (ASCE 7-10) EXPOSURE D
 FLOOR LIVE LOAD: 60 PSF

INDEX OF DRAWINGS

T-1 - SITE DATA
 A-1 - ELEVATIONS
 S-1 - FOUNDATION PLAN / FRAMING PLANS / CONSTRUCTION DETAILS

GENERAL NOTES

- THESE PLANS ARE FOR THE WORK AT THE LOCATION SO DESIGNATED HEREIN.
- THE CONTRACTOR SHALL PROVIDE ALL MATERIAL, LABOR, EQUIPMENT AND SUPERVISION NECESSARY TO PROVIDE THE WORK COMPLETE AND READY FOR USE.
- THERE SHALL BE NO DEVIATION FROM THESE PLANS WITHOUT PRIOR APPROVAL FROM THE ENGINEER OF RECORD.
- THE CONTRACTOR SHALL VISIT THE SITE AND BECOME FAMILIAR WITH EXISTING CONDITIONS BEFORE BID. CHECK AND VERIFY ALL DIMENSIONS AND CONDITIONS OF THE WORK SITE AND REPORT ANY DISCREPANCIES, DIFFERENCES OR CONDITIONS THAT ARE UNSATISFACTORY OR UNSAFE.
- NOTIFY THE ENGINEER OF RECORD IMMEDIATELY OF ANY DISCREPANCIES, DIFFERENCES, UNSATISFACTORY OR UNSAFE CONDITIONS. ANY MODIFICATIONS OR CHANGES MADE WITHOUT PRIOR WRITTEN APPROVAL FROM THE OWNER AND ENGINEER OF RECORD SHALL NOT BE ALLOWED. ANY REWORK, RESTORATION OR OTHER IMPACT AS A RESULT OF NOT OBTAINING SUCH PRIOR APPROVAL WILL BE MADE BY THE CONTRACTOR WITHOUT ADDITIONAL COST OR COMPENSATION FROM THE OWNER.
- THE CONTRACTOR SHALL PROVIDE FOR THE SAFETY, PREVENTION OF INJURY OR OTHER LOSS AT THE JOB TO ALL PERSONS EMPLOYED IN THE WORK, PERSONS VISITING THE WORK AND THE GENERAL PUBLIC. THE CONTRACTOR SHALL ALSO BE RESPONSIBLE FOR THE PREVENTION OF DAMAGE, DUE TO THE WORK, TO MATERIALS OR EQUIPMENT AND OTHER PROPERTY AT THE SITE OR ADJACENT THERETO.
- NO RESEARCH AS TO THE PRESENCE OF UNDERGROUND UTILITIES HAS BEEN INCLUDED ON OR PERFORMED FOR THIS PROJECT. CONTRACTOR SHALL BE RESPONSIBLE FOR CALLING SUNSHINE UTILITY LOCATE SERVICE PRIOR TO ANY CONSTRUCTION WITHIN ANY PUBLIC RIGHT-OF-WAY OR OTHER AREAS WHERE UNDERGROUND UTILITIES MAY BE PRESENT (I.E. IN AND AROUND UTILITY EASEMENTS, ETC.)
- THE GENERAL CONTRACTOR SHALL PROVIDE AN ON-SITE DUMPSTER IN A LOCATION COORDINATED WITH THE OWNER FOR THE DISPOSAL OF REMOVED MATERIAL AND CONSTRUCTION DEBRIS. THE DUMPSTER SHALL BE EMPTIED AT APPROPRIATE INTERVALS TO PREVENT OVERFLOW AND UNSIGHTLY CONDITIONS.
- THE CONTRACTOR SHALL PERFORM ALL WORK IN STRICT CONFORMANCE WITH THE PLANS, 2010 FLORIDA BUILDING CODE, LOCAL CODES AND ORDINANCES, MANUFACTURER RECOMMENDATIONS AND ACCEPTABLE TRADE PRACTICES. ANY CONFLICT BETWEEN THESE REQUIREMENTS AND THE MOST STRINGENT REQUIREMENTS SHALL GOVERN THE WORK.
- SHOP DRAWINGS OF ALL PREFABRICATED STRUCTURAL FLOOR AND ROOF SYSTEMS AND MECHANICAL SYSTEMS SHALL BEAR THE SEAL OF A FLORIDA PROFESSIONAL ENGINEER AS REQUIRED BY THE 2010 FLORIDA BUILDING CODE AND SHALL BE SUBMITTED TO THE ENGINEER OF RECORD BY THE CONTRACTOR FOR APPROVAL PRIOR TO FABRICATION AND INSTALLATION.
- THE CONTRACTOR SHALL NOT SCALE DRAWINGS. ANY INFORMATION THAT THE CONTRACTOR CANNOT OBTAIN FROM DIMENSIONS, DETAIL OR SCHEDULE SHALL BE OBTAINED FROM THE ENGINEER OF RECORD.
- THE CONTRACTOR SHALL COORDINATE THE WORK OF ALL TRADES TO PREVENT ANY CONFLICTS.
- THE CONTRACTOR SHALL FURNISH ALL SUBCONTRACTORS WITH A COMPLETE SET OF PLANS. ALL CHANGES SHALL BE NOTED ON THE DRAWINGS AND (2) COMPLETE AS-BUILT SETS SHALL BE DELIVERED TO THE OWNER AFTER COMPLETION OF WORK.

BALCONY REPAIR

524 ELIZABETH STREET KEY WEST, FLORIDA

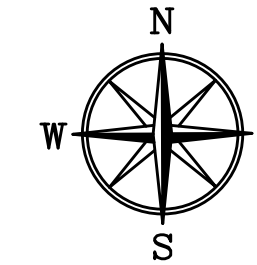

LOCATION MAP

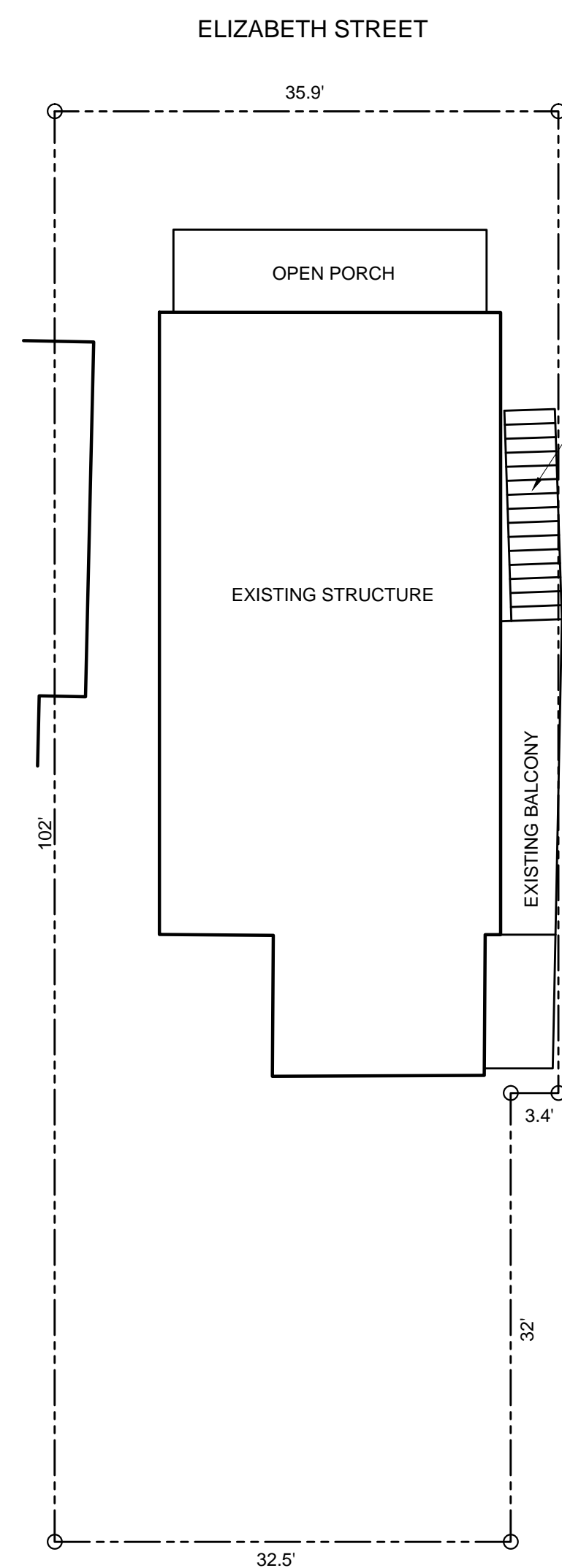

EXISTING SITE PLAN

SCALE: 1"=10'-0"

AREA OF WORK:
 DETERIORATED WOODEN
 BALCONY, RAILINGS &
 STAIRS TO BE REPLACED

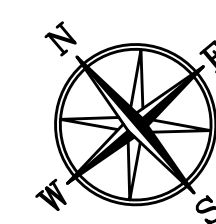
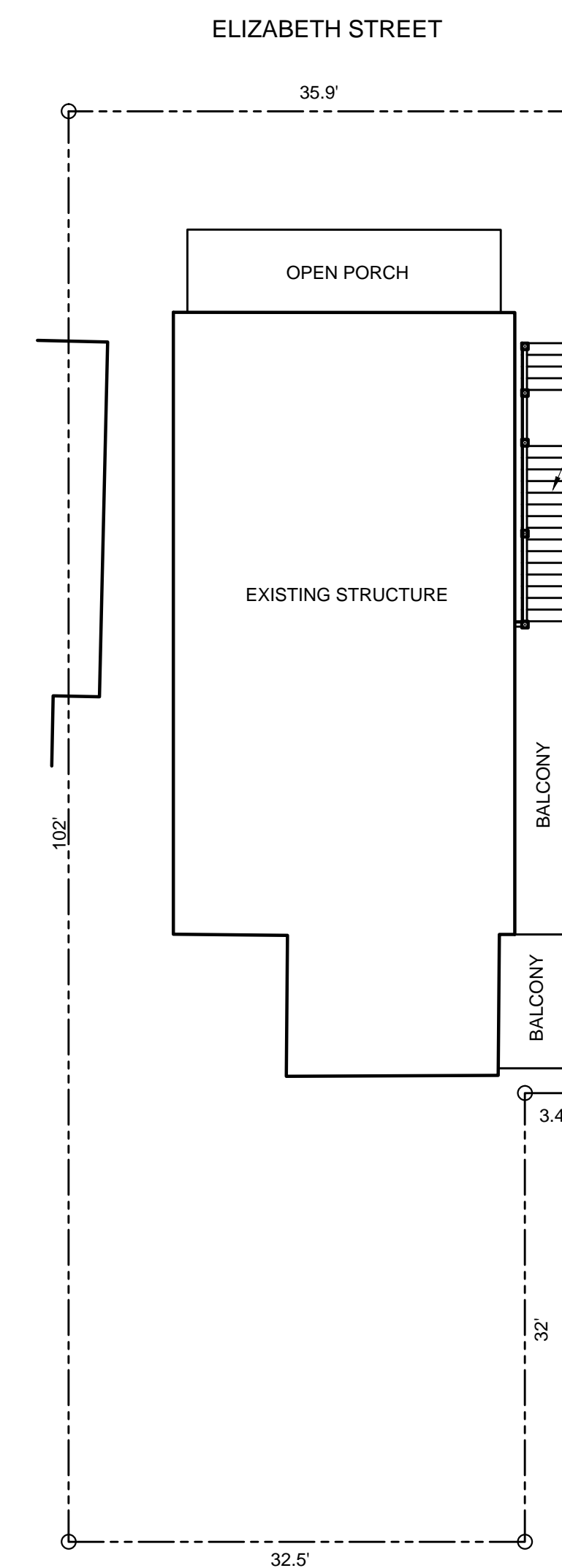

PROPOSED SITE PLAN

SCALE: 1"=10'-0"

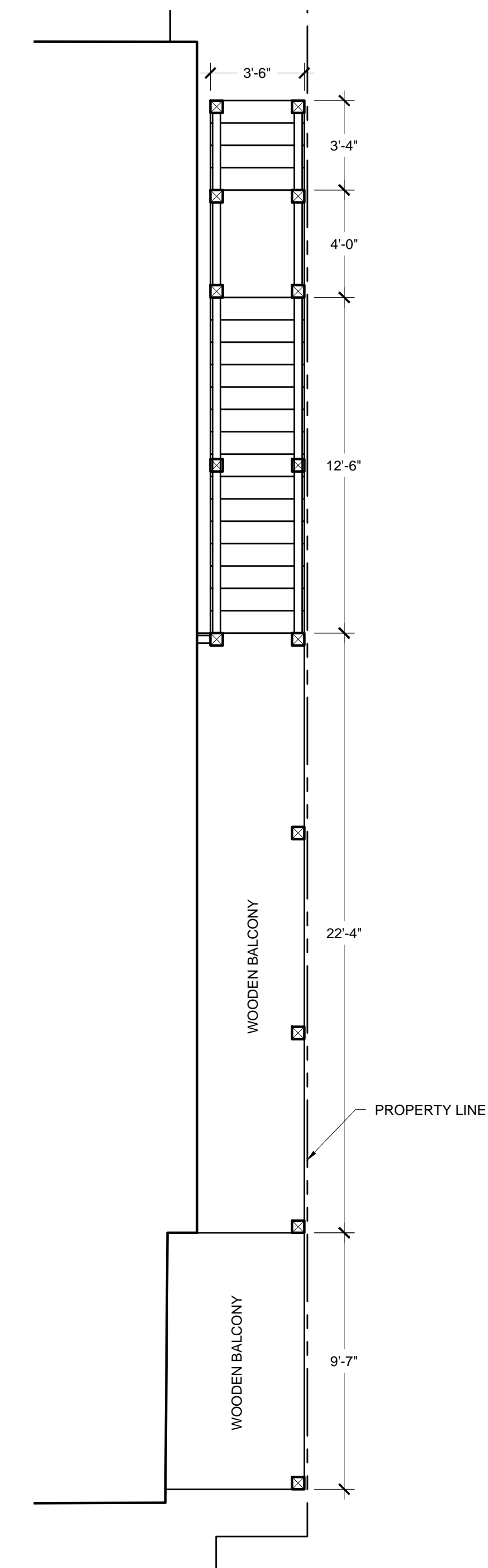

SCALE: 1/4"=1'-0"

PAUL R. SEAMES, P.E.
 Florida P.E. NO. 44137
 July 15, 2015

ORIGINAL:

REVISIONS:

1	
2	
3	
4	
5	
6	

BALCONY REPAIRS

KDC PROPERTIES
 524 ELIZABETH STREET
 KEY WEST, FL 33040

JOB NO. 151008
 DRAWN BGO
 DESIGNED AEP
 CHECKED AEP
 QC
 SHEET

T-1

CIVIL ENGINEERING • REGULATORY PERMITTING • CONSTRUCTION MANAGEMENT
PEREZ ENGINEERING
 & DEVELOPMENT, INC.
 CERTIFICATE OF AUTHORIZATION No. 8579
 KEY WEST OFFICE
 1010 EAST KENNEDY DRIVE, SUITE 201
 KEY WEST, FLORIDA 33040
 TEL: (305) 293-9440 FAX: (305) 296-0243



EXISTING FRONT ELEVATION

SCALE: 1/4" = 1'-0"



EXISTING SIDE ELEVATION

SCALE: 1/4" = 1'-0"



PROPOSED FRONT ELEVATION

SCALE: 1/4" = 1'-0"



PROPOSED SIDE ELEVATION

SCALE: 1/4" = 1'-0"

ORIGINAL:	
REVISIONS:	
1	
2	
3	
4	
5	
6	

BALCONY REPAIRS

KDC PROPERTIES
 524 ELIZABETH STREET
 KEY WEST, FL 33040

JOB NO.	151008
DRAWN	BGO
DESIGNED	AEP
CHECKED	AEP
QC	
SHEET	

DEMOLITION NOTES

1. PRIOR TO SUBMITTING A BID, VERIFY ALL EXISTING CONDITIONS AND DIMENSIONS ON THE JOB SITE, AND ALSO AFTER AWARD, BUT PRIOR TO THE START OF CONSTRUCTION.
2. ALL DEMOLISHED MATERIAL SHALL BECOME THE PROPERTY OF THE CONTRACTOR, UNLESS SPECIFICALLY NOTED OTHERWISE, AND SHALL BE PROPERLY REMOVED FROM THE SITE, COMPLY WITH ALL APPLICABLE LAWS, CODES AND REGULATIONS OF GOVERNMENTAL AGENCIES HAVING JURISDICTION OVER THE PROJECT.
3. ALL COST OF DEMOLITION INCLUDING PERMIT FEES, DISPOSAL FEES, ETC. ARE THE RESPONSIBILITY OF THE CONTRACTOR.
4. IT IS THE CONTRACTOR'S RESPONSIBILITY TO BE AWARE OF AND TO CONFORM WITH ALL APPLICABLE DEMOLITION AND DISPOSAL CODES, SAFETY REQUIREMENT, AND ENVIRONMENTAL PROTECTION REGULATIONS OF ANY GOVERNMENTAL BODY HAVING JURISDICTION OVER THE WORK.
5. PROVIDE SAFETY BARRICADES AS REQUIRED TO PROTECT THE SAFETY OF THE GENERAL PUBLIC AND WORKERS ASSOCIATED WITH THE PROJECT.
6. PROVIDE BRACING AND SHORING AS REQUIRED TO TEMPORARILY SUPPORT STRUCTURAL MEMBERS DURING CONSTRUCTION. BRACING & SHORING OF STRUCTURAL MEMBERS SHALL BE DESIGNED AND/OR APPROVED BY A PROFESSIONAL ENGINEER.
7. DEMOLISHED MATERIAL CLASSIFIED AS CLEAN FILL MAY BE DISTRIBUTED ONSITE WHEN SPECIFICALLY APPROVED BY THE ENGINEER.

WOOD AND FRAMING NOTES

1. EXCEPT WHERE NOTED OTHERWISE, ALL FRAMING LUMBER SHALL BE SOUTHERN PINE, MC 19%, NO. 2 DENSE, AS GRADED BY THE SOUTHERN PINE INSPECTION BUREAU.
2. ALL TIMBER CONSTRUCTION SHALL CONFORM TO THE LATEST EDITION AFC.
3. ALL WOOD SHALL BE PRESSURE TREATED WITH CHEMICALS TO PROTECT FROM INSECTS AND DECAY AS REQUIRED. ALLOW TO DRY AFTER TREATMENT. PROVIDE CONNECTORS AND FASTENERS COMPATIBLE WITH PRESSURE TREATED WOOD FRAMING. PROVIDE SEPARATION BARRIER SUCH AS BUILDING PAPER FOR NON-COMPATIBLE COMPONENTS SUCH AS ALUMINUM WINDOW FRAMES.
4. ALL WOOD CONNECTIONS SHALL HAVE SIMPSON STRONG-TIE CO. OR EQUAL CONNECTORS. ALL CONNECTORS SHALL BE INSTALLED WITH MANUFACTURER RECOMMENDED FASTENERS BEFORE LOADING.
5. CUTTING AND NOTCHING OF FLOOR JOISTS SHALL CONFORM TO THE FOLLOWING:
 - A. NOTCH DEPTH IN THE TOP OR BOTTOM OF THE JOISTS AND BEAMS SHALL NOT EXCEED ONE-SIXTH OF THE DEPTH OF THE MEMBER AND SHALL NOT BE LOCATED IN THE MIDDLE ONE-THIRD OF THE SPAN. (INCLUDING BIRDS MOUTH CUTS).
 - B. NOTCH DEPTH AT THE ENDS OF THE MEMBER SHALL NOT EXCEED ONE-FOURTH THE DEPTH OF THE MEMBER.
 - C. THE TENSION SIDE OF BEAMS, JOISTS AND RAFTERS OF FOUR INCHES OR GREATER NOMINAL THICKNESS SHALL NOT BE NOTCHED, EXCEPT AT ENDS OF MEMBERS.
 - D. HOLES BORED OR CUT INTO JOISTS SHALL NOT BE CLOSER THAN TWO INCHES TO THE TOP OF BOTTOM OF THE JOISTS. THE DIAMETER OF THE HOLE SHALL NOT EXCEED ONE-THIRD THE MEMBER DEPTH.
6. PROVIDE BLOCKING BETWEEN ALL JOISTS 2 X 6 OR GREATER AT INTERVALS NOT TO EXCEED 8 FEET AND AT ALL SUPPORTS.
7. SOLID DECKING SHALL BE TONGUE & GROOVE, SOUTHERN PINE, SELECT GRADE OF 3/4" X 6", NOMINAL SIZE AND PLACED IN A CONTINUOUS RANDOM LAY-UP. THE 3/4" X 6'S SHALL BE TOE-NAILED THROUGH THE TONGUE AND FACE-NAILED WITH TWO NAILS PER SUPPORT USING 16D COMMON NAILS.

FOUNDATION & CONCRETE NOTES

1. ALL FOOTINGS ARE TO BE PLACED ON FIRM, UNDISTURBED, NATURAL ROCK UNLESS OTHERWISE NOTED.
2. AUGER PILE DIAMETERS AND EMBEDMENT INTO ROCK SHALL BE NO LESS THAN 16" DIAMETER NOR LESS THAN 3' INTO ROCK WITH (4) 2"x4" #4 BENT BARS WITH SHORT LEG TIED TO #6'S AND LONG LEG EXTENDED INTO SLAB IN FOUR DIRECTIONS UNLESS OTHERWISE NOTED. CONCRETE SHALL NOT BE MIXED IN PLACE IN A WET AUGER HOLE.
3. CENTER ALL FOOTINGS UNDER WALLS, COLUMNS OR GRID LINES UNLESS OTHERWISE NOTED.
4. CONTRACTOR SHALL FURNISH FIELD DENSITY TESTS ON COMPACTED FILL UNDER FOOTINGS AND SLABS PRIOR TO PLACING CONCRETE. A MINIMUM OF 3 REPRESENTATIVE TESTS SHALL BE TAKEN FOR EACH FOOTING AND SLAB POUR.
5. ALL CAST-IN-PLACE CONCRETE SHALL BE MADE WITH TYPE I PORTLAND CEMENT, STONE AGGREGATE AND SHALL DEVELOP AT LEAST 4000 PSI COMPRESSIVE STRENGTH IN 28 DAYS. (UNLESS OTHERWISE NOTED.)
6. SLABS, TOPPING, FOOTINGS AND WALLS SHALL NOT HAVE JOINTS IN THE HORIZONTAL PLANE. ANY STOP IN CONCRETE WORK MUST BE MADE AT THE CENTER OF SPAN WITH VERTICAL BULKHEADS AND SHEAR KEYS UNLESS OTHERWISE NOTED. ALL CONSTRUCTION JOINTS SHALL BE AS DETAILED OR OTHERWISE APPROVED BY THE ENGINEER.
7. ALL CONCRETE WORK AND REINFORCING DETAILS SHALL BE CONSTRUCTED IN ACCORDANCE WITH ACI 318. EXPOSED EDGES OF CONCRETE SHALL HAVE 1/2" CHAMFER. USE STANDARD HOOKS ON DOWELS UNLESS OTHERWISE NOTED.
8. CONCRETE FORMS SHALL BE WETTED IMMEDIATELY PRIOR TO PLACING CONCRETE.
9. MIXING, PLACING AND CURING OF ALL CONCRETE MUST BE IN ACCORDANCE WITH ACI 305R. HOT WEATHER CONCRETING, NEW CONCRETE EXPOSED TO DIRECT SUNLIGHT SHALL BE SPRAYED OR MOPPED WITH A CURING COMPOUND TO SEAL IN MOISTURE AFTER THE FINISH HAS SET, OR THE CONCRETE COVERED AND SPRAYED.
10. PROVIDE PLASTIC SLIEVES IN MASONRY PARTITIONS AND CONCRETE FOUNDATIONS AS INDICATED AND REQUIRED FOR UTILITY SERVICES. NO OTHER PIPE, CONDUIT OR ACCESSORY SHALL BE PLACED IN STRUCTURAL SLABS, COLUMNS OR BEAMS UNLESS SPECIFICALLY SHOWN ON STRUCTURAL DRAWINGS.
11. PROVIDE MASONRY FILLED CELL OR CONCRETE COLUMN WITH (1) #6 REBAR FROM BEAM TO BEAM ON BOTH SIDES OF ALL EXTERIOR OPENINGS.
12. ALL REINFORCING SHALL BE HIGH STRENGTH DEFORMED BARS CONFORMING TO ASTM A-615, GRADE 60.
13. WELDED WIRE FABRIC SHALL CONFORM TO ASTM A-185 AND SHALL BE LAPPED ONE FULL MESH AND AT SIDE AND END SPLICES AND WIRED TOGETHER.
14. REINFORCEMENT COVERAGE SHALL BE 2" MINIMUM WHEN FORMS ARE USED AND 3" MINIMUM WHEN POURED AGAINST THE EARTH, UNLESS OTHERWISE NOTED.
15. LAP SPLICES SHALL BE A MINIMUM OF 48 BAR DIAMETERS. MAKE ALL BARS CONTINUOUS AROUND CORNERS.
16. PROVIDE ALL ACCESSORIES NECESSARY TO SECURE REINFORCING IN PROPER POSITION AS INDICATED ON THE DRAWINGS AND IN ACCORDANCE WITH ACI 318. ALL ACCESSORIES TO BE GALVANIZED.
17. ALL UNIT MASONRY CONSTRUCTION AND DETAILS SHALL BE IN ACCORDANCE WITH ACI 530.
18. CONCRETE BLOCK SHALL CONFORM WITH ASTM C90. MORTAR SHALL BE TYPE S, ASTM C270.
19. ANCHOR BOLTS, NUTS AND WASHERS SHALL BE MINIMUM 3/4" GALVANIZED STEEL AND EMBEDDED MINIMUM 7" INTO CONCRETE AND SPACED MAXIMUM 4" CC.
20. MANUFACTURED STRAPS AND ANCHORS SHALL BE GALVANIZED AND SHALL BE FASTENED PER THE MANUFACTURER RECOMMENDATIONS. IN NO EVENT SHALL A STRUCTURAL MEMBER SUCH AS PIER, SILL, JOIST, PLATE, RAFTER OR TRUSS BE WITHOUT ANCHORAGE DEVICES FOR HURRICANE PROTECTION, UNLESS SPECIFICALLY NOTED AND ADDRESSED BY OTHER MEANS.

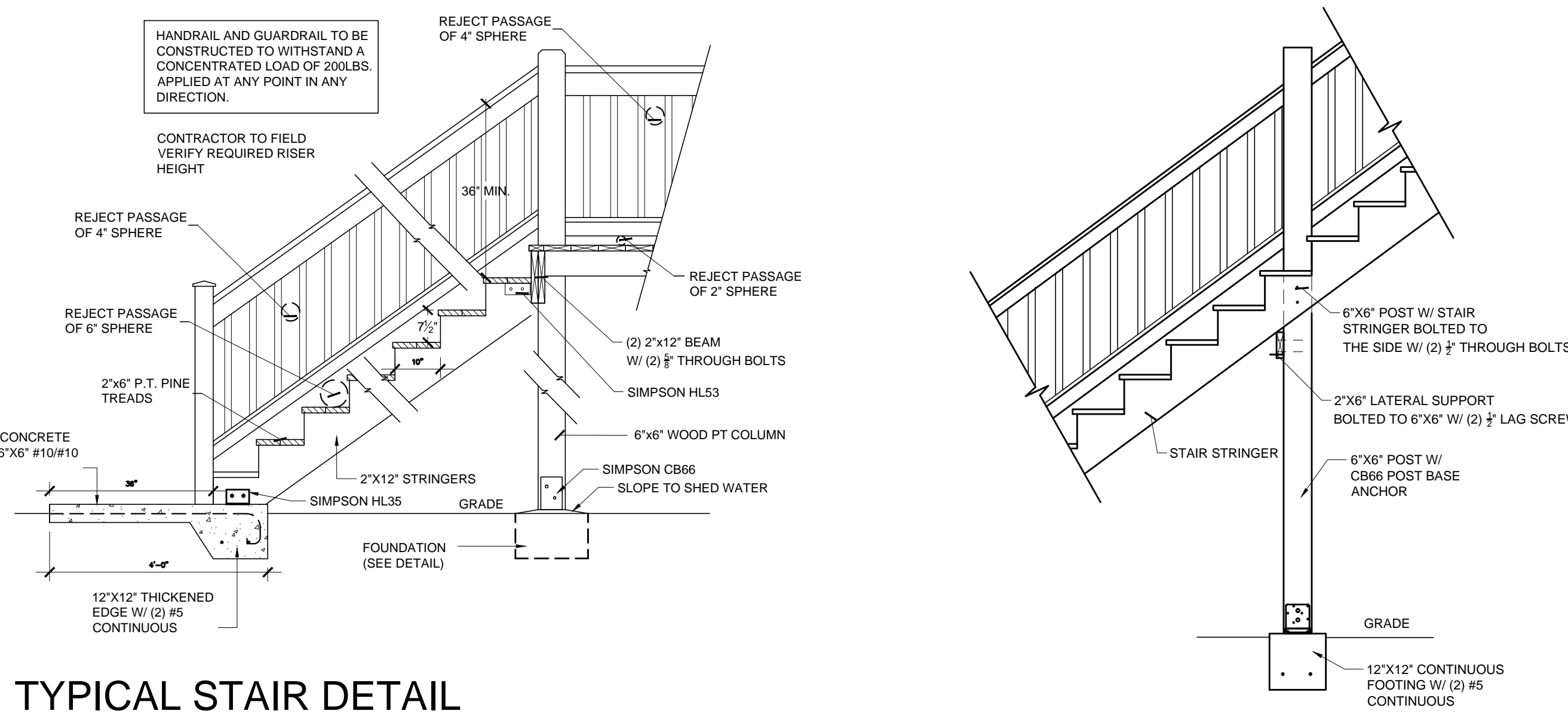

TYPICAL STAIR DETAIL

SCALE: N.T.S.

MID SPAN STAIR SUPPORT

SCALE: N.T.S.

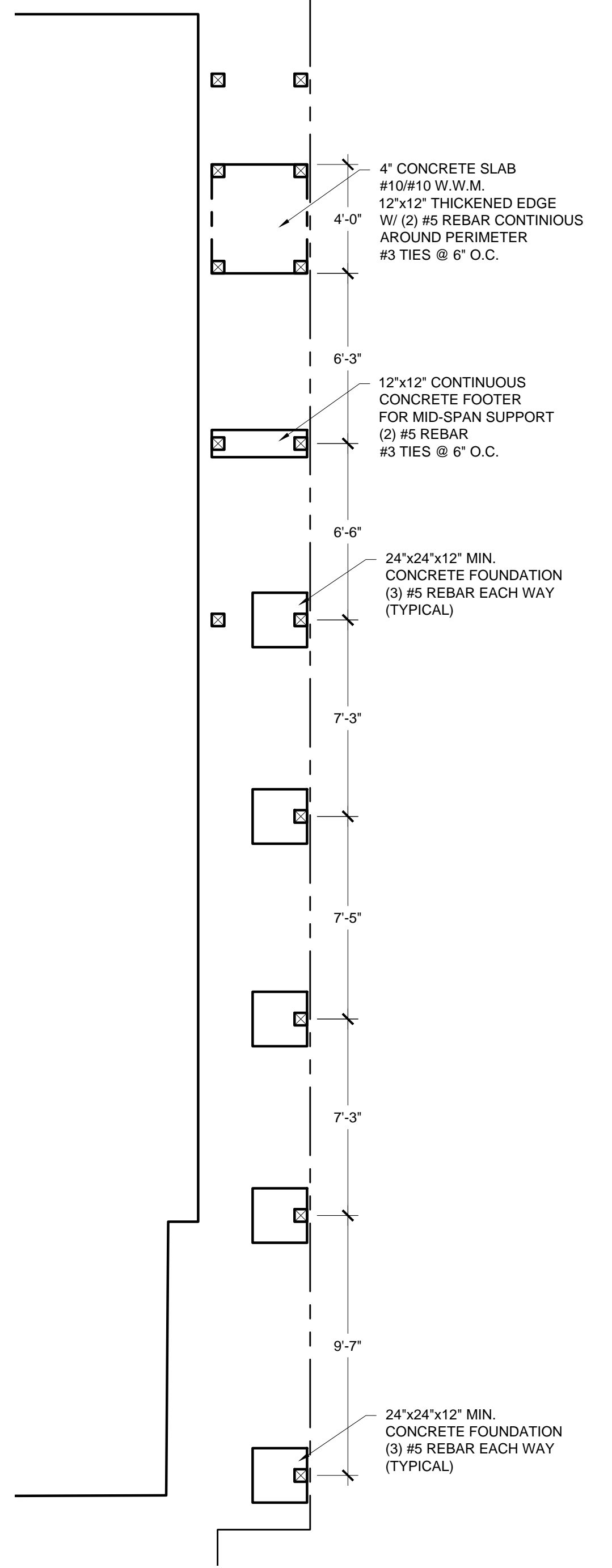

FOUNDATION PLAN

SCALE: 1/4" = 1'-0"

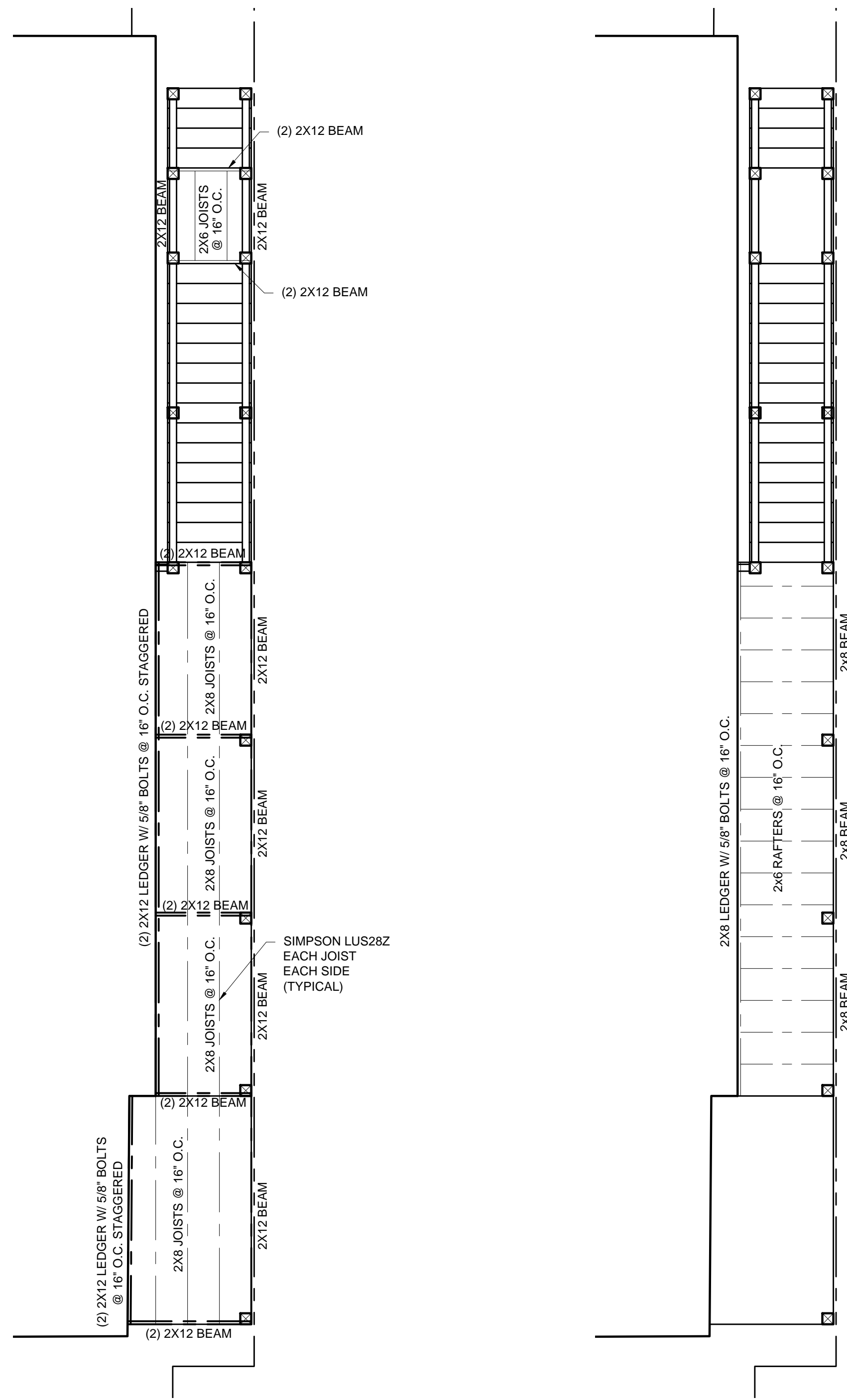

DECK FRAMING PLAN

SCALE: 1/4" = 1'-0"

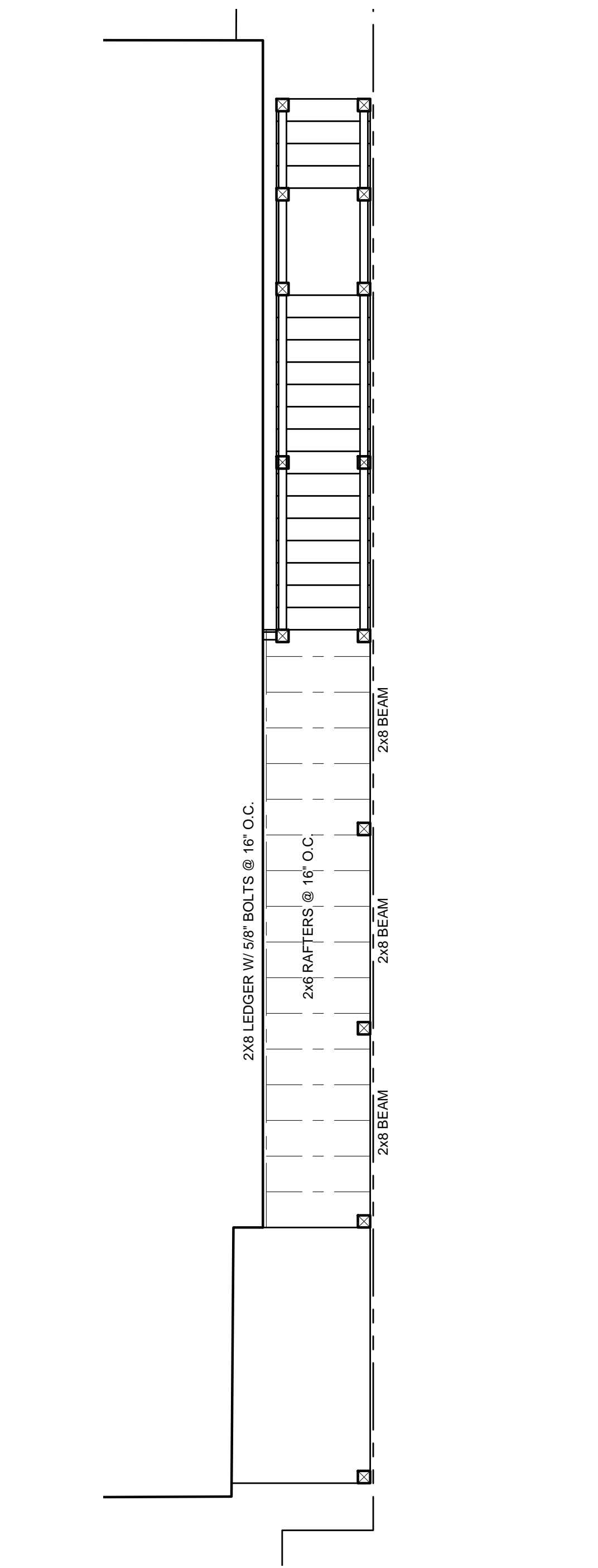

ROOF FRAMING PLAN

SCALE: 1/4" = 1'-0"

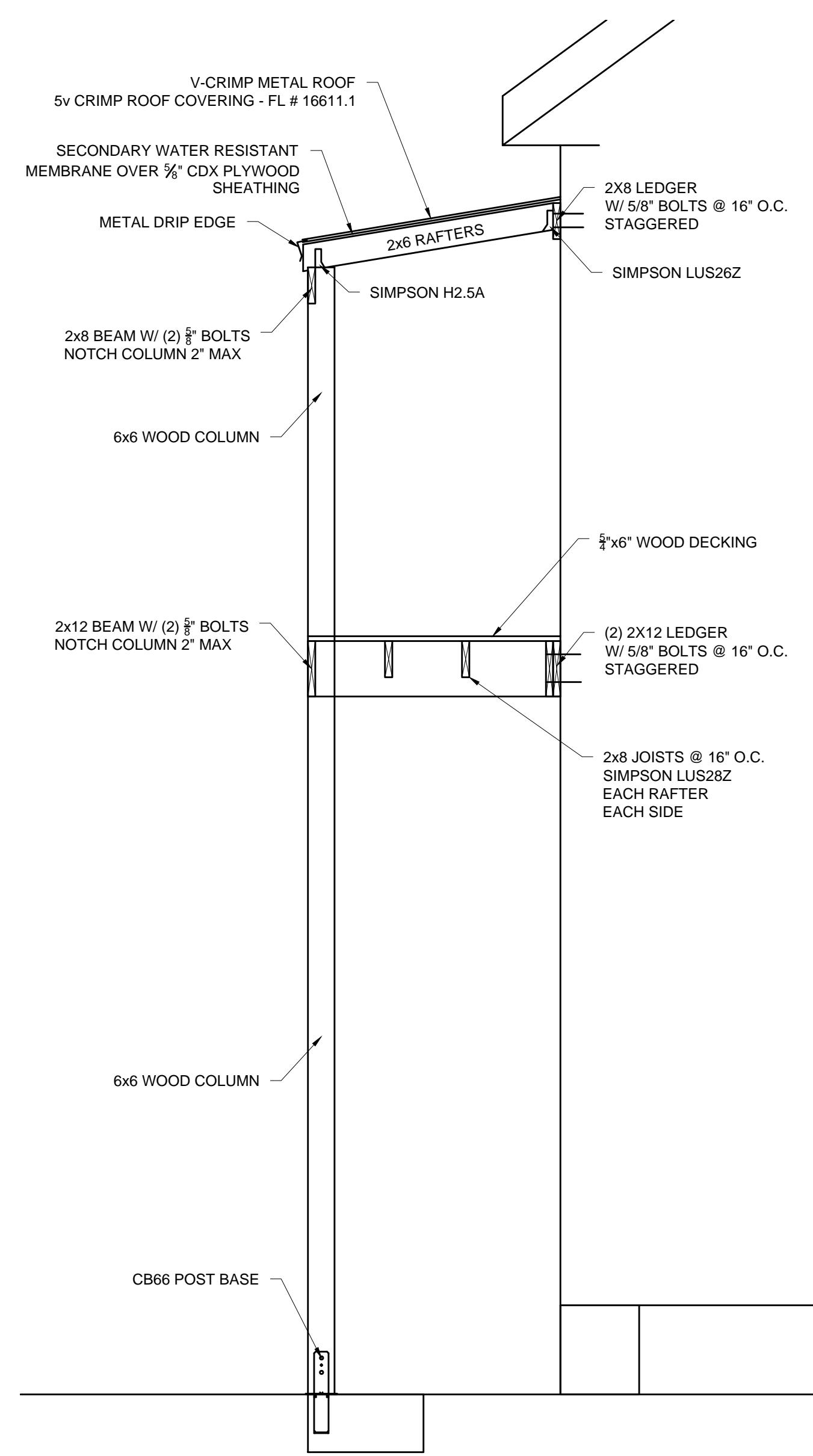

DECK SECTION

SCALE: 1/4" = 1'-0"

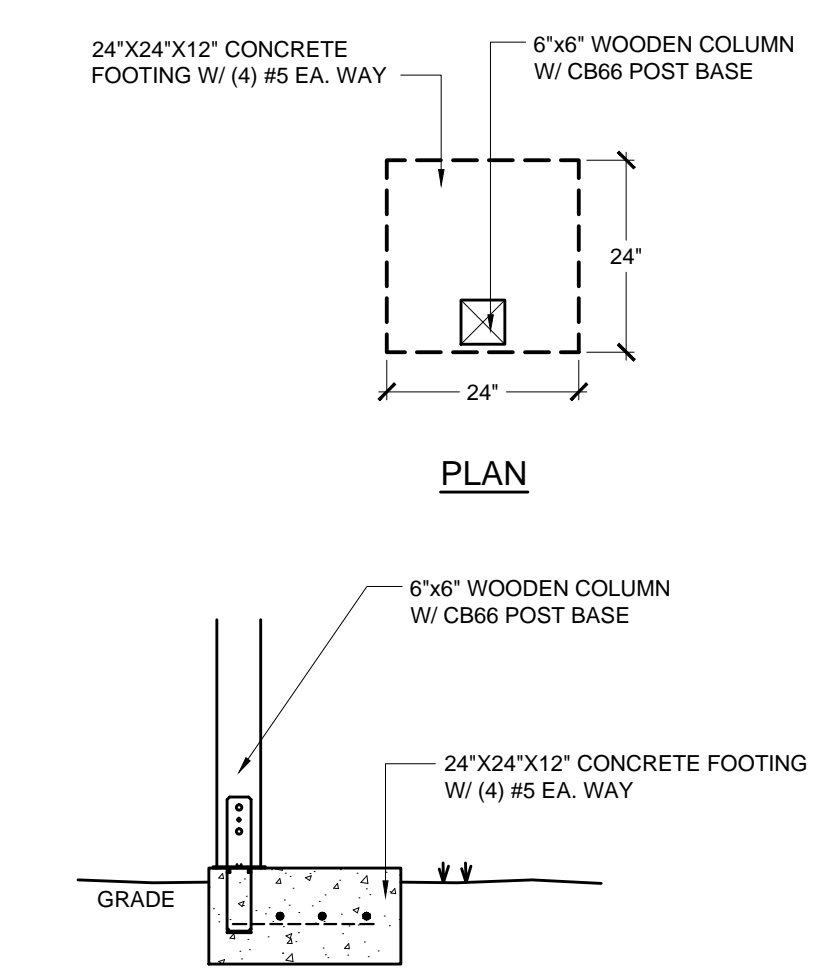

FOUNDATION DETAILS

SCALE: N.T.S.

CIVIL ENGINEERING • REGULATORY PERMITTING • CONSTRUCTION MANAGEMENT

PEREZ ENGINEERING & DEVELOPMENT, INC.

KEY WEST OFFICE
1010 EAST KENNEDY DRIVE, SUITE 201
KEY WEST, FLORIDA 33040
TEL: (305) 293-9440 FAX: (305) 296-0243

PAUL R. SEAMES, P.E.
Florida P.E. NO. 44137
July 15, 2015

ORIGINAL:	
REVISIONS:	
1	
2	
3	
4	
5	
6	

BALCONY REPAIRS	
1	
2	
3	
4	
5	
6	

KDC PROPERTIES	
524 ELIZABETH STREET	
KEY WEST, FL 33040	

JOB NO.	151008
DRAWN	BGO
DESIGNED	AEP
CHECKED	AEP
QC	
SHEET	S-1

NOTICING

Public Meeting Notice

The Historic Architectural Review Commission will hold a public hearing at 5:30 p.m., September 29, 2015 at Old City Hall, 510 Greene Street, Key West, Florida. The purpose of the hearing will be to consider a request for:

**NEW WOOD EXTERIOR STAIRCASE.
DEMOLITION OF EXTERIOR WOOD STAIRCASE.**

FOR- #524 ELIZABETH STREET

Applicant – FMH Builders Inc.

Application #H15-01-1313

If you wish to see the application or have any questions, you may visit the Planning Department during regular office hours at 3140 Flagler Avenue, call 305-809-3975 or visit our website at www.cityofkeywest-fl.gov.

THIS NOTICE CAN NOT BE REMOVED FROM THE SITE UNTIL HARC FINAL DETERMINATION

ADA ASSISTANCE: It is the policy of the City of Key West to comply with all requirements of the Americans with Disabilities Act (ADA). Please call the TTY number at 800-955-8771 or 800-955-8770 (Voice) or the ADA Coordinator at 305-809-3731 at least five business days in advance for sign language interpreters, assistive listening devices, or materials in accessible format.

PROPERTY APPRAISER INFORMATION



Scott P. Russell, CFA
Property Appraiser
Monroe County, Florida

Key West (305) 292-3420
 Marathon (305) 289-2550
 Plantation Key (305) 852-7130

Property Record Card -

Maps are now launching the new map application version.

Alternate Key: 1009288 Parcel ID: 00009020-000000

Ownership Details

Mailing Address:

KDC PROPERTIES OF KEY WEST LLC
 PO BOX 4125
 KEY WEST, FL 33041-4125

Property Details

PC Code: 08 - MULTI FAMILY LESS THAN 10UNITS

Millage Group: 10KW

Affordable Housing: No

**Section-Township-
Range:** 06-68-25

Property Location: 524 ELIZABETH ST KEY WEST

Legal Description: KW PT LOT 1 SQR 49 COC 63 TT-365 COUNTY JUDGE'S DOCKET 11-206 OR783-1394Q OR1036-2036
 OR1042-1845 OR2557-1719/24

Click Map Image to open interactive viewer



Land Details

Land Use Code	Frontage	Depth	Land Area
010D - RESIDENTIAL DRY	33	101	3,548.00 SF

Building Summary

Number of Buildings: 1

Number of Commercial Buildings: 0

Total Living Area: 2184

Year Built: 1933

Building 1 Details

Building Type R4

Effective Age 25

Year Built 1933

Functional Obs 0

Condition P

Perimeter 292

Special Arch 0

Economic Obs 0

Quality Grade 550

Depreciation % 32

Grnd Floor Area 2,184

Inclusions: R4 includes 4 3-fixture baths and 4 kitchens.

Roof Type GABLE/HIP

Roof Cover METAL

Foundation WD CONC PADS

Heat 1 NONE

Heat 2 NONE

Bedrooms 3

Heat Src 1 NONE

Heat Src 2 NONE

Extra Features:

2 Fix Bath 0

Vacuum 0

3 Fix Bath 0

Garbage Disposal 0

4 Fix Bath 0

Compactor 0

5 Fix Bath 0

Security 0

6 Fix Bath 0

Intercom 0

7 Fix Bath 0

Fireplaces 0

Extra Fix 0

Dishwasher 0

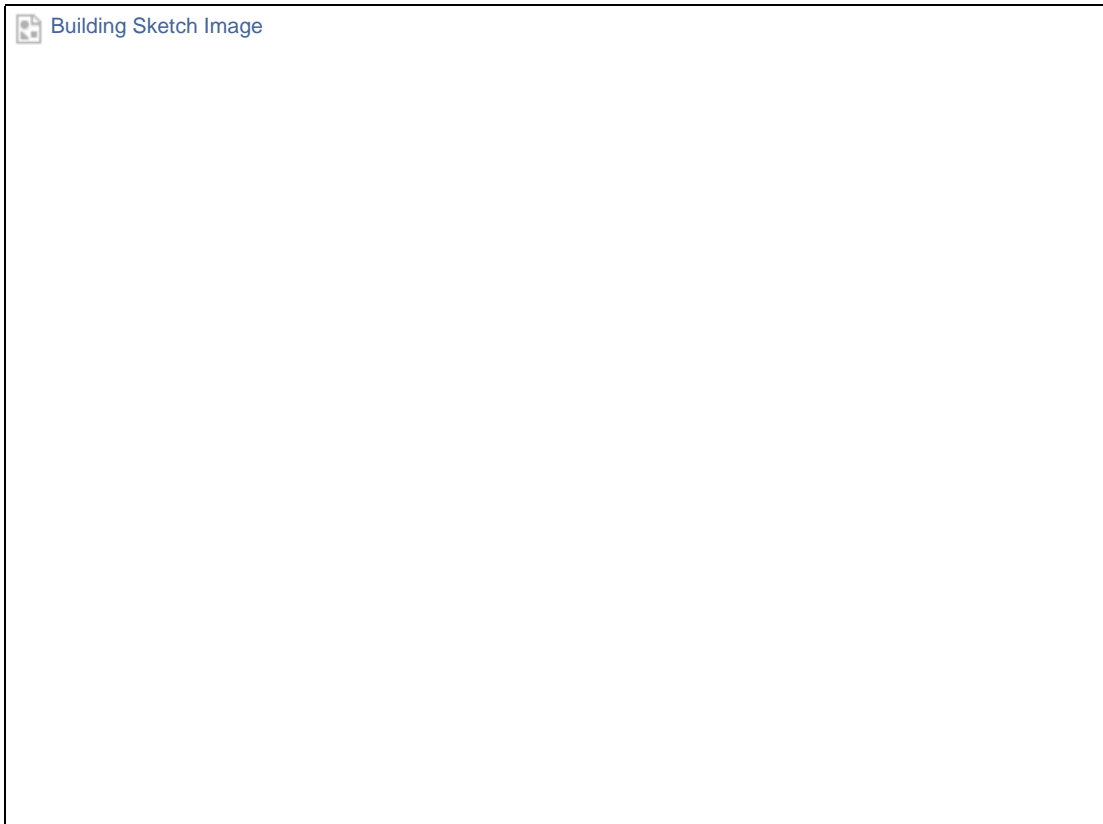

Sections:

Nbr	Type	Ext Wall	# Stories	Year Built	Attic A/C	Basement %	Finished Basement %	Area
1	<u>FLA</u>	12:ABOVE AVERAGE WOOD	1	1932	N N	0.00	0.00	1,092
2	<u>OPF</u>		1	1932		0.00	0.00	126
3	<u>FLA</u>	12:ABOVE AVERAGE WOOD	1	1932	N N	0.00	0.00	1,092
4	<u>OUF</u>		1	1932		0.00	0.00	150
5	<u>OUU</u>		1	1932		0.00	0.00	40

Misc Improvement Details

Nbr	Type	# Units	Length	Width	Year Built	Roll Year	Grade	Life
1	UB3:LC UTIL BLDG	216 SF	0	0	1939	1940	1	30

2	RW2:RETAINING WALL	48 SF	0	0	1949	1950	3	50
3	PT3:PATIO	45 SF	0	0	1959	1960	1	50
4	WD2:WOOD DECK	384 SF	0	0	1990	1991	1	40

Appraiser Notes

TPP AK-8765843.

HURRICANE DAMAGES

Building Permits

Bldg Number	Date Issued	Date Completed	Amount	Description	Notes
1	96-1107	03/01/1996	08/01/1996	400 Residential	ELECTRICAL
2	96-2223	05/01/1996	08/01/1996	750 Residential	RENOVATIONS
3	97-3070	10/07/1997	01/01/1999	1,100 Residential	REPLACE DECK & PORCH
4	97-4203	12/15/1997	01/01/1999	6,800 Residential	EXTERIOR PAINTING
5	06-3889	06/27/2006	07/24/2006	20,000 Residential	REPLACE 20 SQS OF CONCH SHINGLES
6	08-0061	01/10/2008	01/30/2008	1,800 Residential	REMOVE 140 SF OF BATHROOM & KITCHEN FLOORS TO FIND WATER LEAK
7	08-0244	02/06/2008	02/29/2008	9,500 Residential	TO ROUGH IN AND SET ONE TUB, ONE LAVATORY, ONE TOILET, ONE WATER HEATER, ONE KITCHEN SINK

Parcel Value History

Certified Roll Values.

[View Taxes for this Parcel.](#)

Roll Year	Total Bldg Value	Total Misc Improvement Value	Total Land Value	Total Just (Market) Value	Total Assessed Value	School Exempt Value	School Taxable Value
2015	227,111	1,878	365,228	594,217	468,213	0	594,217
2014	229,020	1,785	233,240	464,045	425,649	0	464,045
2013	232,339	1,836	216,967	451,142	386,954	0	451,142
2012	232,339	1,914	117,524	351,777	351,777	0	351,777
2011	235,658	1,966	162,725	400,349	392,410	0	400,349
2010	238,977	2,044	115,716	356,737	356,737	0	356,737
2009	266,259	2,096	311,200	579,555	579,555	0	579,555
2008	248,686	2,173	354,800	605,659	605,659	0	605,659
2007	264,114	2,225	585,420	851,759	851,759	0	851,759
2006	409,476	2,303	337,060	707,891	707,891	0	707,891
2005	362,679	2,355	301,580	666,614	666,614	0	666,614
2004	255,008	2,433	248,360	505,801	505,801	0	505,801
2003	284,151	2,484	124,180	410,815	410,815	0	410,815
2002	263,441	2,562	124,180	390,183	390,183	0	390,183
2001	233,771	2,614	124,180	360,565	360,565	0	360,565

2000	215,839	2,413	67,412	285,664	285,664	0	285,664
1999	205,516	2,339	67,412	275,267	275,267	0	275,267
1998	121,676	1,948	67,412	191,036	191,036	0	191,036
1997	111,811	1,897	60,316	174,024	174,024	0	174,024
1996	84,563	1,546	60,316	146,424	146,424	0	146,424
1995	81,431	1,513	60,316	143,260	143,260	0	143,260
1994	68,903	1,312	60,316	130,531	130,531	0	130,531
1993	76,040	0	60,316	136,356	136,356	0	136,356
1992	92,768	0	60,316	153,085	153,085	0	153,085
1991	92,768	0	63,864	156,633	156,633	0	156,633
1990	90,971	0	57,655	148,626	148,626	0	148,626
1989	82,701	0	56,768	139,469	139,469	0	139,469
1988	70,338	0	46,124	116,462	116,462	0	116,462
1987	69,403	0	26,433	95,836	95,836	0	95,836
1986	69,783	0	25,546	95,329	95,329	0	95,329
1985	67,541	0	14,475	82,016	82,016	0	82,016
1984	62,943	0	14,475	77,418	77,418	0	77,418
1983	62,943	0	14,475	77,418	77,418	0	77,418
1982	64,251	0	14,475	78,726	78,726	0	78,726

Parcel Sales History

NOTE: Sales do not generally show up in our computer system until about two to three months after the date of sale. If a recent sale does not show up in this list, please allow more time for the sale record to be processed. Thank you for your patience and understanding.

Sale Date	Official Records Book/Page	Price	Instrument	Qualification
12/30/2011	2557 / 1719	100	<u>QC</u>	<u>11</u>

This page has been visited 256,862 times.

Monroe County Property Appraiser
 Scott P. Russell, CFA
 P.O. Box 1176 Key West, FL 33041-1176