

Ocean Walk Apartments

3900 S. Roosevelt Boulevard
Key West, Florida

TRAFFIC STUDY

prepared for:
Ocean Walk Key West Owner, LLC

KBP CONSULTING, INC.

October 2015
February 2017

Ocean Walk Apartments

3900 S. Roosevelt Boulevard

Key West, Florida

Traffic Study

October 2015

Updated February 2017

Prepared for:

Ocean Walk Key West Owner, LLC

Prepared by:

KBP Consulting, Inc.
8400 N. University Drive, Suite 309
Tamarac, Florida 33321
Phone: (954) 560-7103

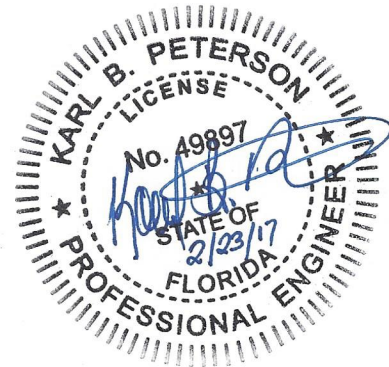

Karl B. Peterson, P.E.
Florida Registration Number 49897
KBP Consulting, Inc.
8400 N. University Drive, Suite 309
Tamarac, Florida 33321
CA # 29939

TABLE OF CONTENTS

INTRODUCTION	1
INVENTORY	3
Existing Land Use and Access	3
Proposed Land Use and Access.....	3
EXISTING CONDITIONS	4
Existing Roadway Network.....	4
Existing Traffic Conditions	4
Pedestrian & Bicyclist Activity	6
TRAFFIC COUNTS	6
TRIP GENERATION	9
TRIP DISTRIBUTION AND TRAFFIC ASSIGNMENT	11
FUTURE TRAFFIC VOLUMES	15
TRAFFIC IMPACT ANALYSIS	20
Intersections Analyses	20
Link Analyses.....	20
ALTERNATIVE MODES OF TRANSPORTATION	22
SUMMARY & CONCLUSIONS	23

LIST OF FIGURES

FIGURE 1 – Project Location Map.....	2
FIGURE 2 – Existing Roadway Network and Geometry	5
FIGURE 3 – Existing AM Peak Hour Traffic Counts.....	7
FIGURE 4 – Existing PM Peak Hour Traffic Counts	8
FIGURE 5 – Trip Distribution	12
FIGURE 6 – New Project Traffic Assignment – AM Peak Hour.....	13
FIGURE 7 – New Project Traffic Assignment – PM Peak Hour	14
FIGURE 8 – Future Background (w/out Project) AM Peak Hour Traffic Volumes	16
FIGURE 9 – Future Background (w/out Project) PM Peak Hour Traffic Volumes	17
FIGURE 10 – Future Total (w/Project) AM Peak Hour Traffic Volumes	18
FIGURE 11 – Future Total (w/Project) PM Peak Hour Traffic Volumes	19

LIST OF TABLES

TABLE 1 – Average Annual Daily Traffic (AADT) Volumes	6
TABLE 2 – Trip Generation Summary	9
TABLE 3 – Intersection Levels of Service.....	20
TABLES 4A & 4B – Roadway Link Levels of Service	21

INTRODUCTION

Ocean Walk Apartments is an existing residential apartment community located at 3900 S. Roosevelt Boulevard (State Road A1A) in the City of Key West, Monroe County, Florida. The subject site is located at the intersection of S. Roosevelt Boulevard and Seaside Drive. The location of the Ocean Walk Apartments community is illustrated in Figure 1 on the following page.

KBP Consulting, Inc. has been retained by Ocean Walk Key West Owner, LLC to prepare a traffic impact study in connection with the proposed expansion of this residential community. This study addresses the trip generation characteristics of the current and proposed development intensities and the resulting impacts of the additional traffic on the surrounding roadway network.

This traffic study is divided into nine (9) sections as listed below:

1. Inventory
2. Existing Conditions
3. Traffic Counts
4. Trip Generation
5. Trip Distribution and Traffic Assignment
6. Future Traffic Volumes
7. Traffic Impact Analysis
8. Alternative Modes of Transportation
9. Summary & Conclusions



INVENTORY

Existing Land Use and Access

The Ocean Walk Apartments community currently consists of 296 residential dwelling units. Vehicular access to this site is provided by Seaside Drive which connects to S. Roosevelt Boulevard (State Road A1A). This access is shared with several other residential communities that comprise the area known as SeaSide.

Proposed Land Use and Access

In accordance with the proposed plan, the number of dwelling units at the Ocean Walk Apartments community will increase by 80. This increase will occur in two (2) phases of 40 dwelling units each. Access to the site will be provided via the existing roadway network and connections to Seaside Drive which leads to S. Roosevelt Boulevard. Appendix A contains the preliminary site plan for this project.

EXISTING CONDITIONS

This section of the report addresses the existing roadway network in the project study area and the general traffic conditions.

Existing Roadway Network

One (1) major roadway (S. Roosevelt Boulevard / State Road A1A) is located to the east and south of the site. This roadway is a state-maintained principal arterial facility and consists of a four-lane section with two (2) lanes in each direction. Based upon a review of the study area and discussions with the City's traffic consultant, the following intersections were selected to be evaluated:

- Seaside Drive & S. Roosevelt Boulevard (State Road A1A)
- Seaside Drive & Roundabout (400 feet west of S. Roosevelt Boulevard)

Figure 2 on the following page depicts the lane geometry and type of intersection control at each of the study intersections within the project study area.

Existing Traffic Conditions

The Florida Department of Transportation (FDOT) collects and reports historical traffic data at two (2) traffic count stations within the immediate proximity of the study area. Traffic volume data recorded over the past five (5) year period at these stations is summarized in Table 1 on page 6 of this report. This traffic data indicates that traffic volumes in the immediate study area for the past five (5) year period (2010 to 2015) have been relatively steady. As a result, a background growth rate of 1.0% per year (compounded) has been applied for this traffic impact study. Appendix B contains the historical traffic data published by FDOT.

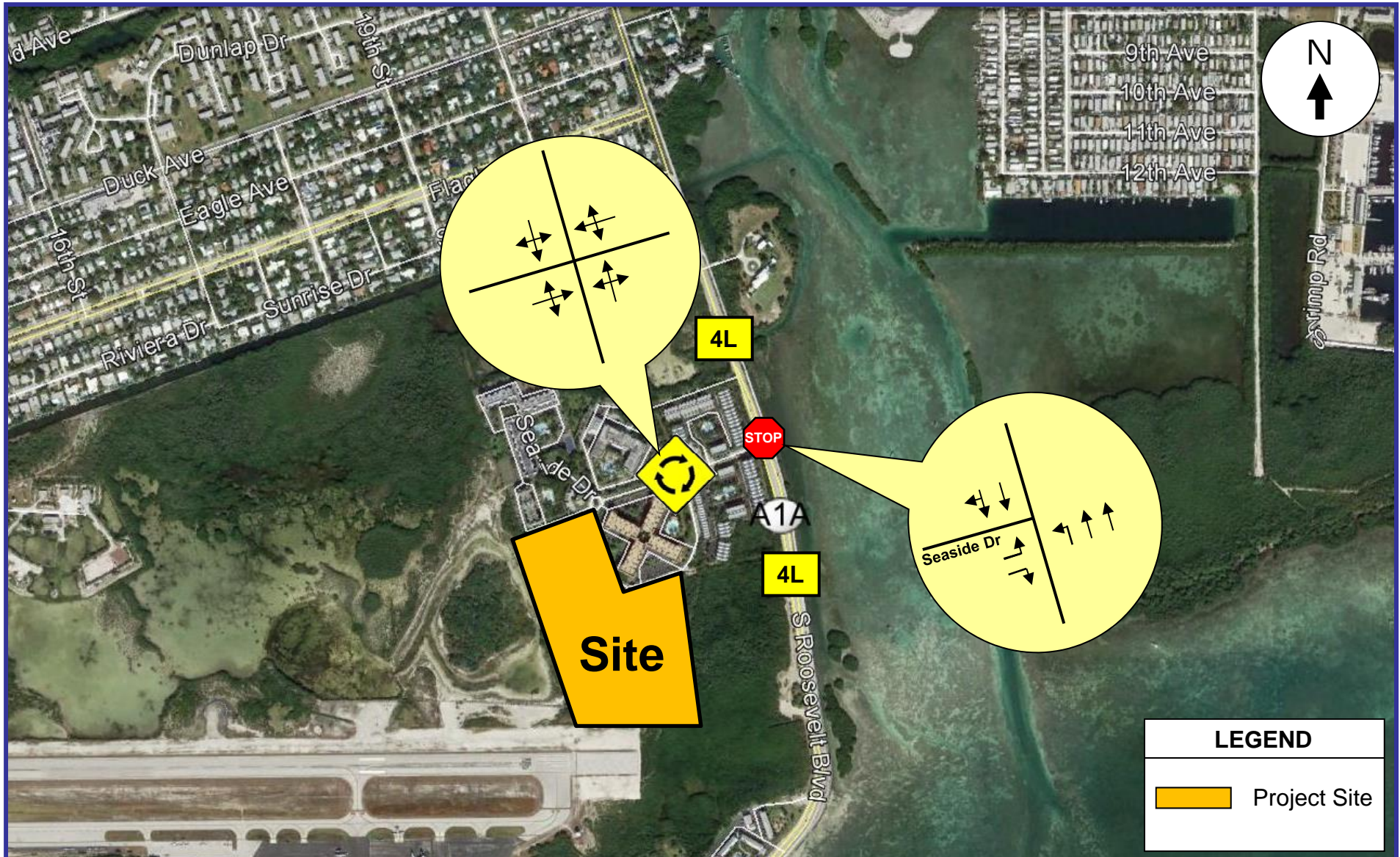

Table 1
Ocean Walk Apartments
Average Annual Daily Traffic (AADT) Volumes
Key West, Florida

Year	Average Annual Daily Traffic (AADT) Volumes	
	Station #905017	Station #905027
2015	10,900	11,400
2014	9,600	14,300
2013	9,800	10,400
2012	10,500	10,600
2011	10,500	12,100
2010	11,700	11,900

Station #905017 - Flagler Ave, 200' W of S. Roosevelt Blvd.
Station #905027 - S. Roosevelt Blvd 300' S of Flagler Ave

Source: Florida Department of Transportation
Compiled by: KBP Consulting, Inc. (February 2017)

KBP Consulting, Inc., in association with Trident Engineering, collected morning (7:00 AM to 9:00 AM) and afternoon (4:00 PM – 6:00 PM) peak period turning movement counts at the following intersections on Wednesday, February 8, 2017:

- ❑ Seaside Drive & S. Roosevelt Boulevard
- ❑ Seaside Drive & Roundabout (400 feet west of S. Roosevelt Boulevard)

Forty-eight (48) hour directional counts were also collected on S. Roosevelt Boulevard north and south of Seaside Drive and on Seaside Drive west of S. Roosevelt Boulevard. Figures 3 and 4 summarize the existing (Year 2017) AM and PM peak hour turning movement counts and link volumes (average of the 48-hour counts). Appendix C contains the results of this traffic data collection effort.

Pedestrian & Bicyclist Activity

There is an existing pedestrian crosswalk located on S. Roosevelt Boulevard immediately north of Seaside Drive. Activity at this location was noted during the intersection turning movement count. In summary, there were 38 pedestrian / bicyclist crossings during the AM peak hour (7:15 to 8:15) and 24 pedestrian / bicyclist crossings during the PM peak hour (4:30 to 5:30).

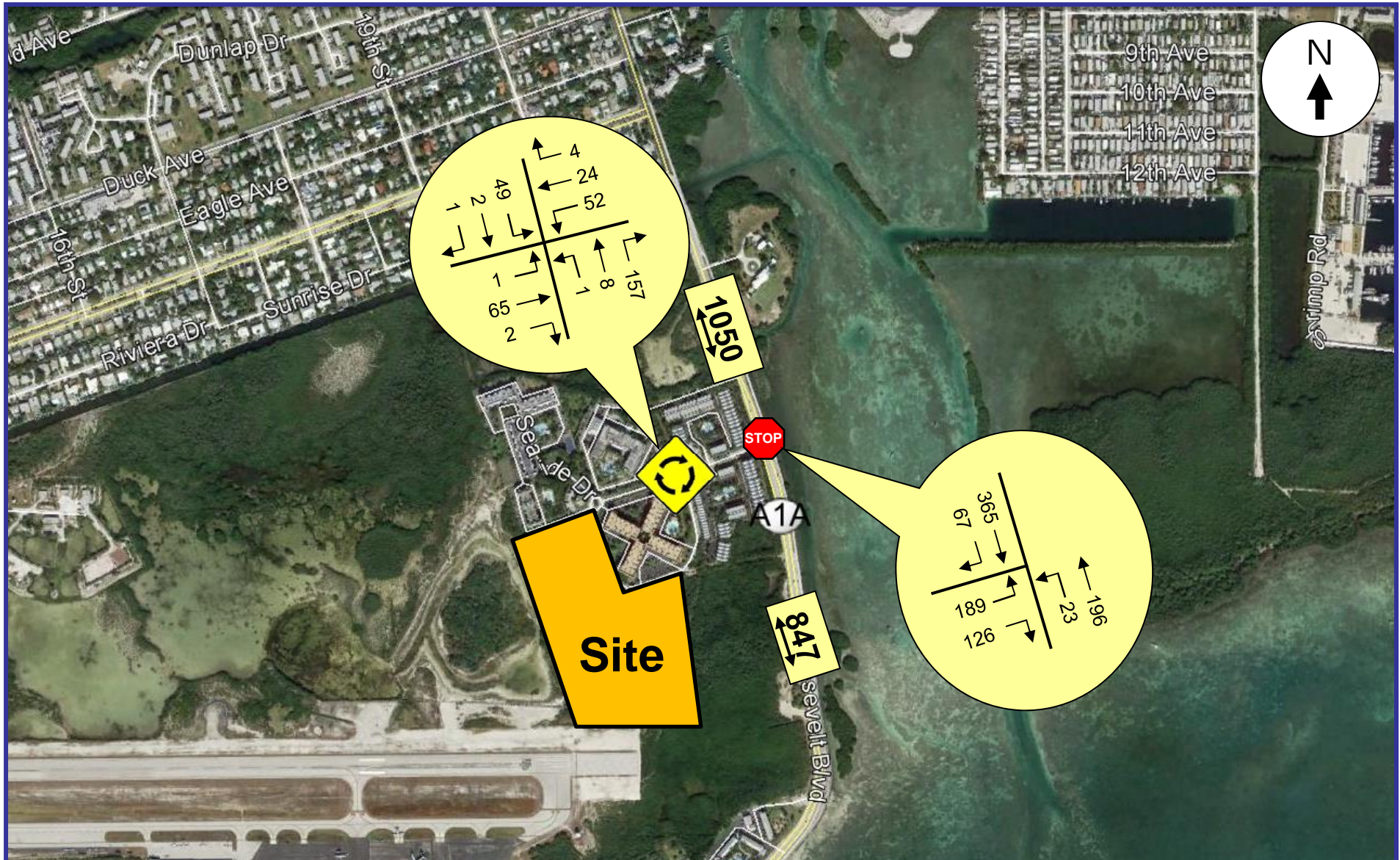

KBP
CONSULTING, INC.

Existing (Year 2017) AM Peak Hour Traffic Counts

Source: Trident Engineering – February 8, 2017

FIGURE 3
Ocean Walk Apartments
Key West, Florida

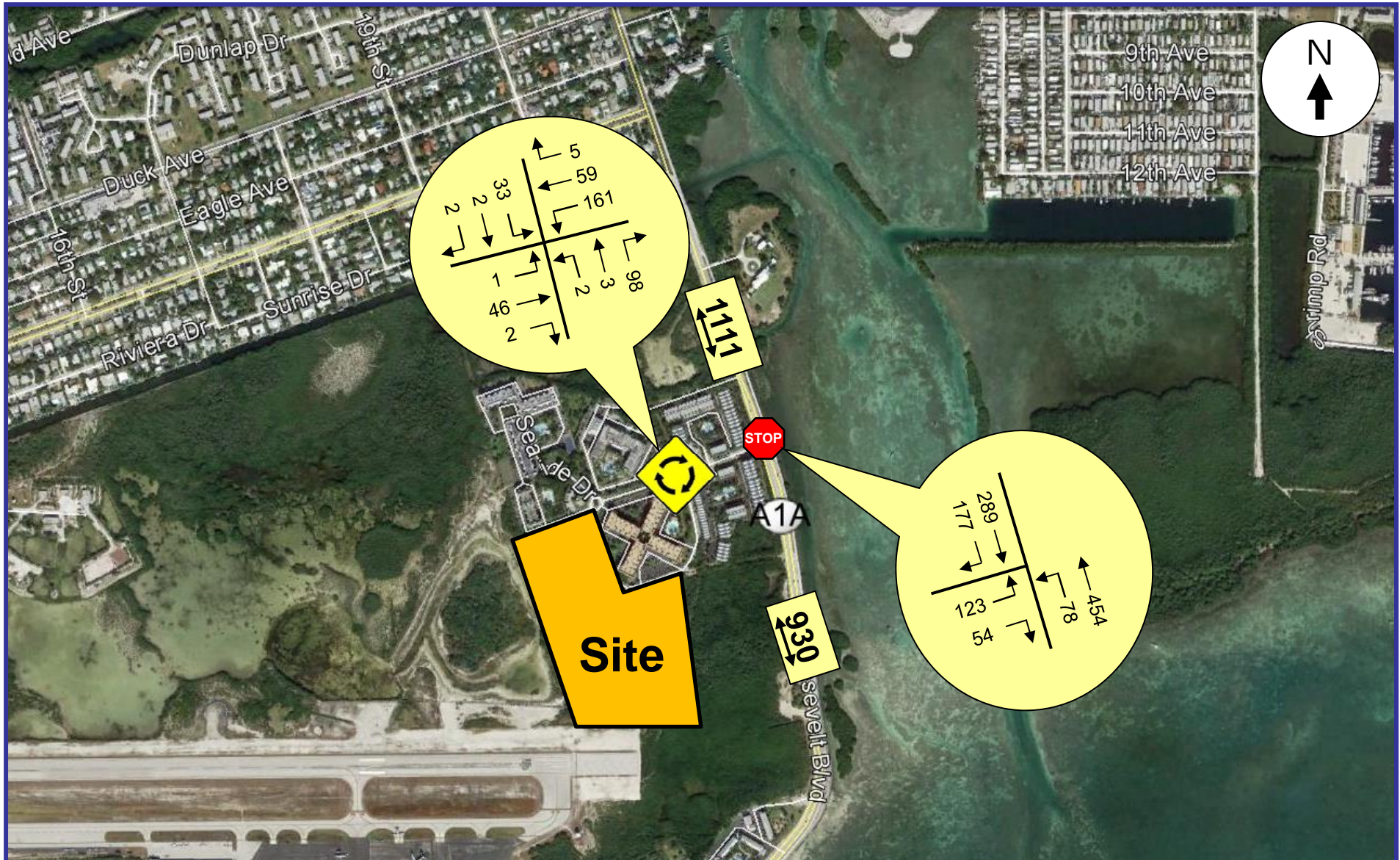

KBP
CONSULTING, INC.

Existing (Year 2017) PM Peak Hour Traffic Counts

Source: Trident Engineering – February 8, 2017

FIGURE 4
Ocean Walk Apartments
Key West, Florida

TRIP GENERATION

A trip generation analysis has been conducted for the proposed increase in the number of dwelling units at the Ocean Walk Apartments development. The analysis was performed using the trip generation rates and equations published in the Institute of Transportation Engineer’s (ITE) *Trip Generation Manual (9th Edition)*. The trip generation analysis was undertaken for daily, AM peak hour, and PM peak hour conditions. According to the ITE report, the most appropriate “land use” category for this development is as follows:

Apartment – ITE Land Use #220

- Daily: $T = 6.06 (X) + 123.56$
- AM Peak Hour: $T = 0.49 (X) + 3.73$ (20% in / 80% out)
- PM Peak Hour: $T = 0.55 (X) + 17.65$ (65% in / 35% out)

where T = number of trips and X = number of dwelling units

Utilizing the above-listed trip generation rates from the referenced ITE document, a trip generation analysis was undertaken for the existing and proposed development intensities at the Ocean Walk Apartments community. The results of this effort are documented in Table 2 below.

Table 2								
Ocean Walk Apartments								
Trip Generation Analysis								
Key West, Florida								
Land Use	Size	Daily Trips	AM Peak Hour Trips			PM Peak Hour Trips		
			In	Out	Total	In	Out	Total
<i>Existing</i> Apartment	296 DU	1,917	30	119	149	117	63	180
<i>Proposed</i> Apartment	376 DU	2,402	38	150	188	146	78	224
Difference	80 DU	485	8	31	39	29	15	44

Compiled by: KBP Consulting, Inc. (February 2017).

Source: ITE Trip Generation (9th Edition) Report.

As indicated in Table 2, the expanded Ocean Walk Apartments community is estimated to generate approximately 2,402 daily vehicle trips, 188 AM peak hour vehicle trips (38 inbound and 150 outbound) and approximately 224 vehicle trips (146 inbound and 78 outbound) during the typical afternoon peak hour. When compared with the existing development intensity (i.e. 296 dwelling units), this represents an increase of 485 daily vehicle trips, 39 AM peak hour vehicle trips, and 44 PM peak hour vehicle trips.

TRIP DISTRIBUTION AND TRAFFIC ASSIGNMENT

The trip distribution for the Ocean Walk Apartments project was developed based upon knowledge of the study area, examination of the surrounding roadway network characteristics, review of current traffic volumes, and existing land use patterns. The trip distribution for the project is summarized below:

- 60% to and from the north via S. Roosevelt Boulevard (State Road A1A)
- 40% to and from the south via S. Roosevelt Boulevard (State Road A1A)

The trip distribution for the Ocean Walk Apartments project is presented graphically in Figure 5 on the following page. The net new AM and PM peak hour traffic generated by the project was assigned to the study area transportation network utilizing this trip distribution pattern. The resulting project traffic assignment is summarized in Figures 6 and 7.



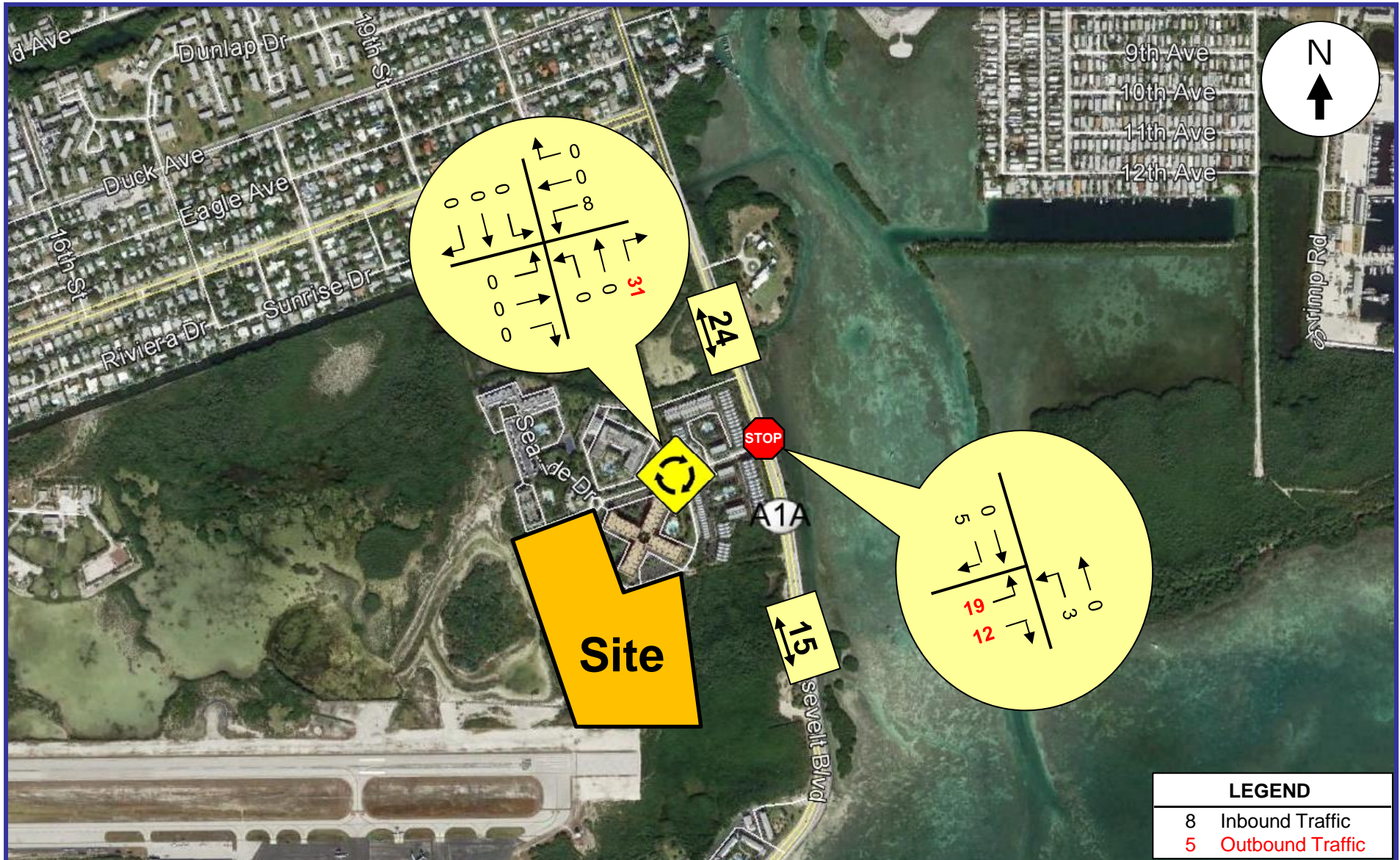

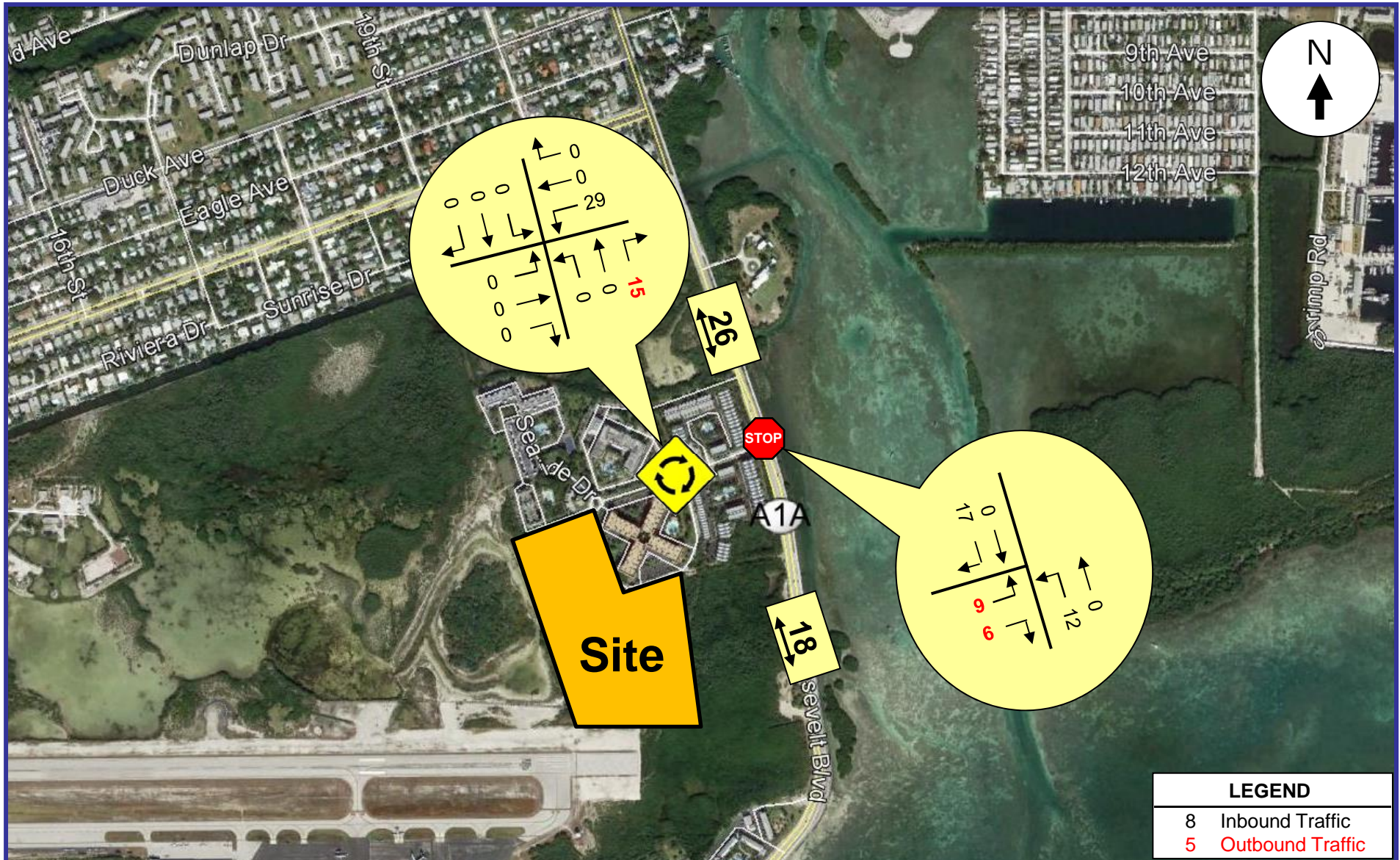

KBP
CONSULTING, INC.

New PM Peak Hour Project Traffic Assignment

FIGURE 7
Ocean Walk Apartments
Key West, Florida

FUTURE TRAFFIC VOLUMES

This section of the report involves the development of future (2019) traffic volumes within the project study area both with and without the additional residential units at Ocean Walk Apartments community. The traffic volumes were developed in the following manner:

- **Average Peak Season Conversion Factor:** Traffic data collected on February 8-10, 2017 was reviewed with respect to average peak season conditions. FDOT's Peak Season Factor Category report (see Appendix D) was consulted for this analysis. The peak season adjustment factor reported for Monroe County for this time period (traffic counts collected between February 8th and 14th) is 1.00.

- **Historic Traffic Growth:** As indicated in the Existing Conditions section of this report, historic FDOT traffic data for the project study area indicates minimal growth in traffic volumes for the past five (5) year period (2010 to 2015). Accordingly, a background growth rate of 1.0% per year (compounded annually) has been applied for this traffic impact study.

The future traffic calculations (including peak season adjustments, background traffic growth, and the traffic associated with the Ocean Walk Apartments project) for the study intersections and roadway links are contained in Appendix E in tabular format. Figures 8 and 9 include future background traffic only (without the proposed increase in dwelling units in the Ocean Walk Apartments community) and Figures 10 and 11 include the additional traffic anticipated to be generated by the new residences in the Ocean Walk Apartments community.

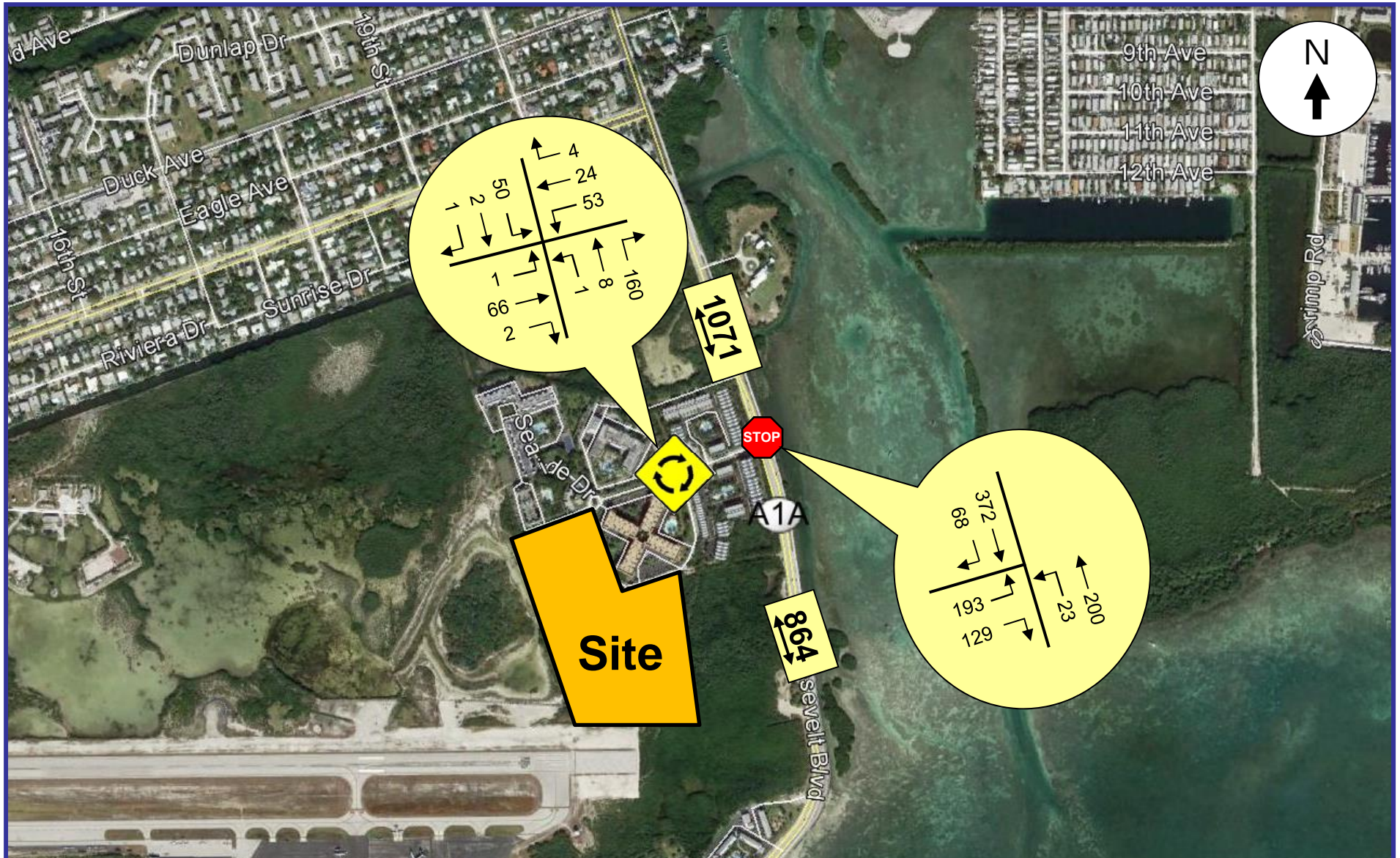

**Future (Year 2019) AM Peak Hour
Background Traffic Volumes**

FIGURE 8
Ocean Walk Apartments
Key West, Florida

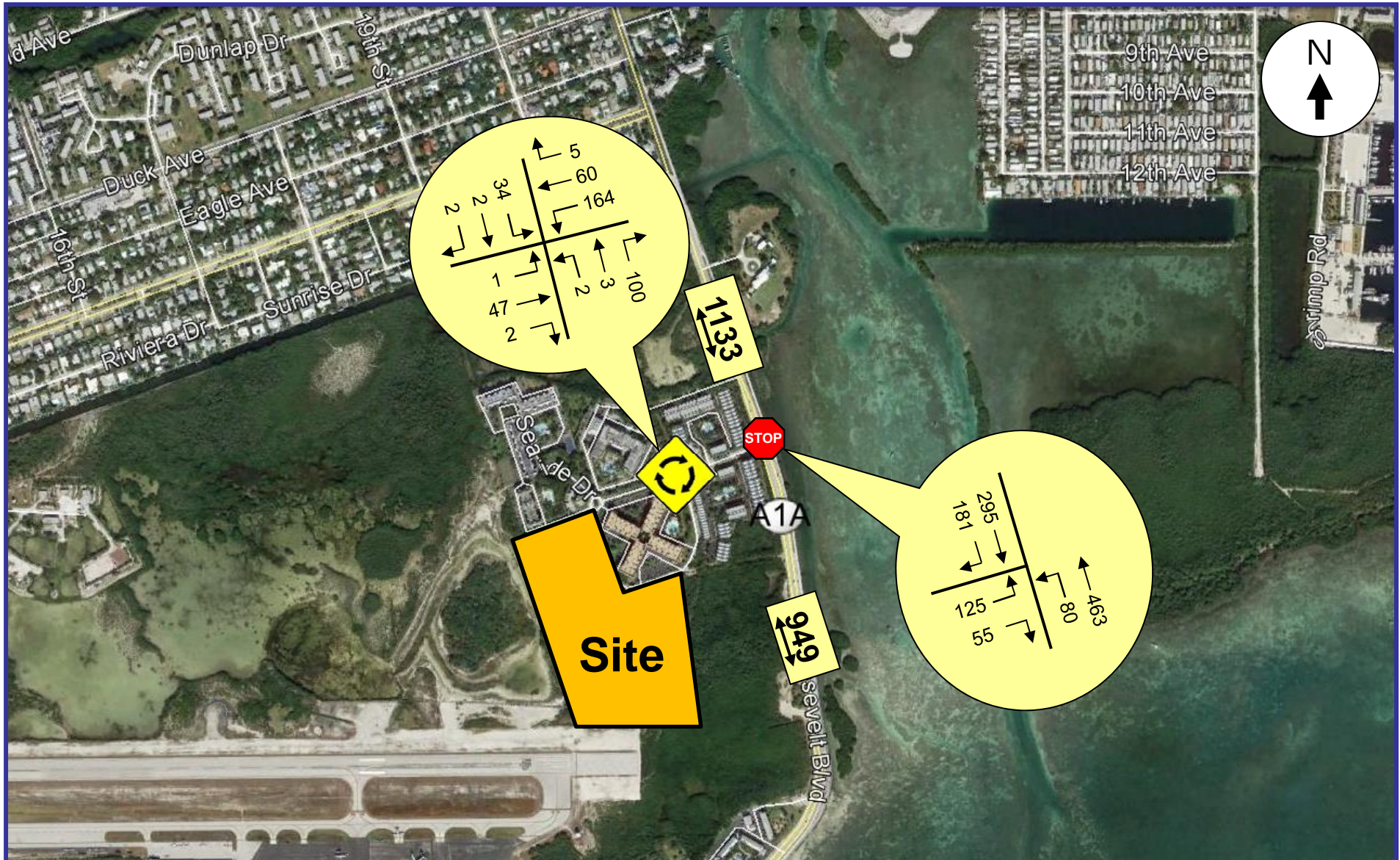

**Future (Year 2019) PM Peak Hour
Background Traffic Volumes**

FIGURE 9
Ocean Walk Apartments
Key West, Florida

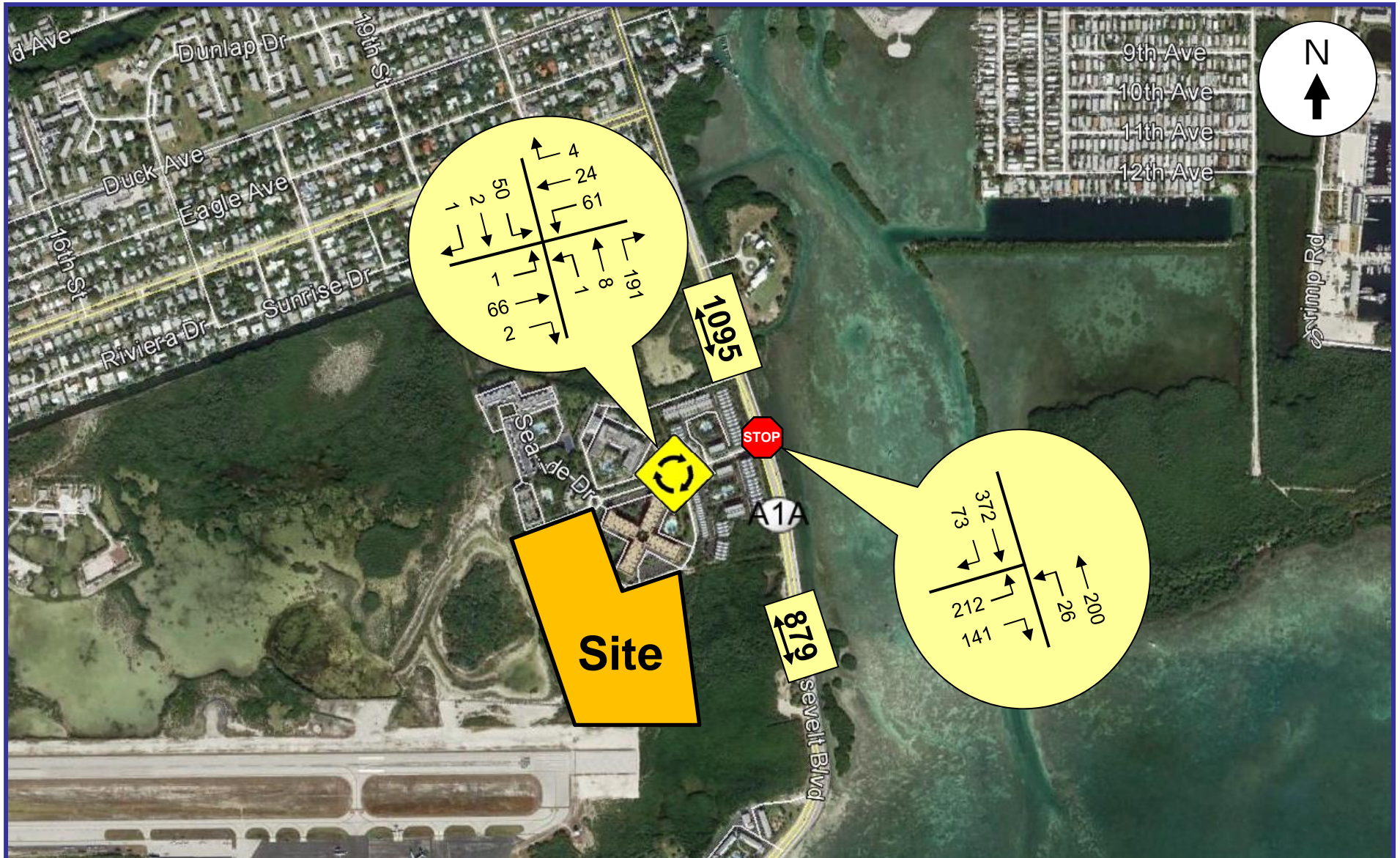

KBP
CONSULTING, INC.

**Future (Year 2019) AM Peak Hour
Total Traffic Volumes**

FIGURE 10
Ocean Walk Apartments
Key West, Florida

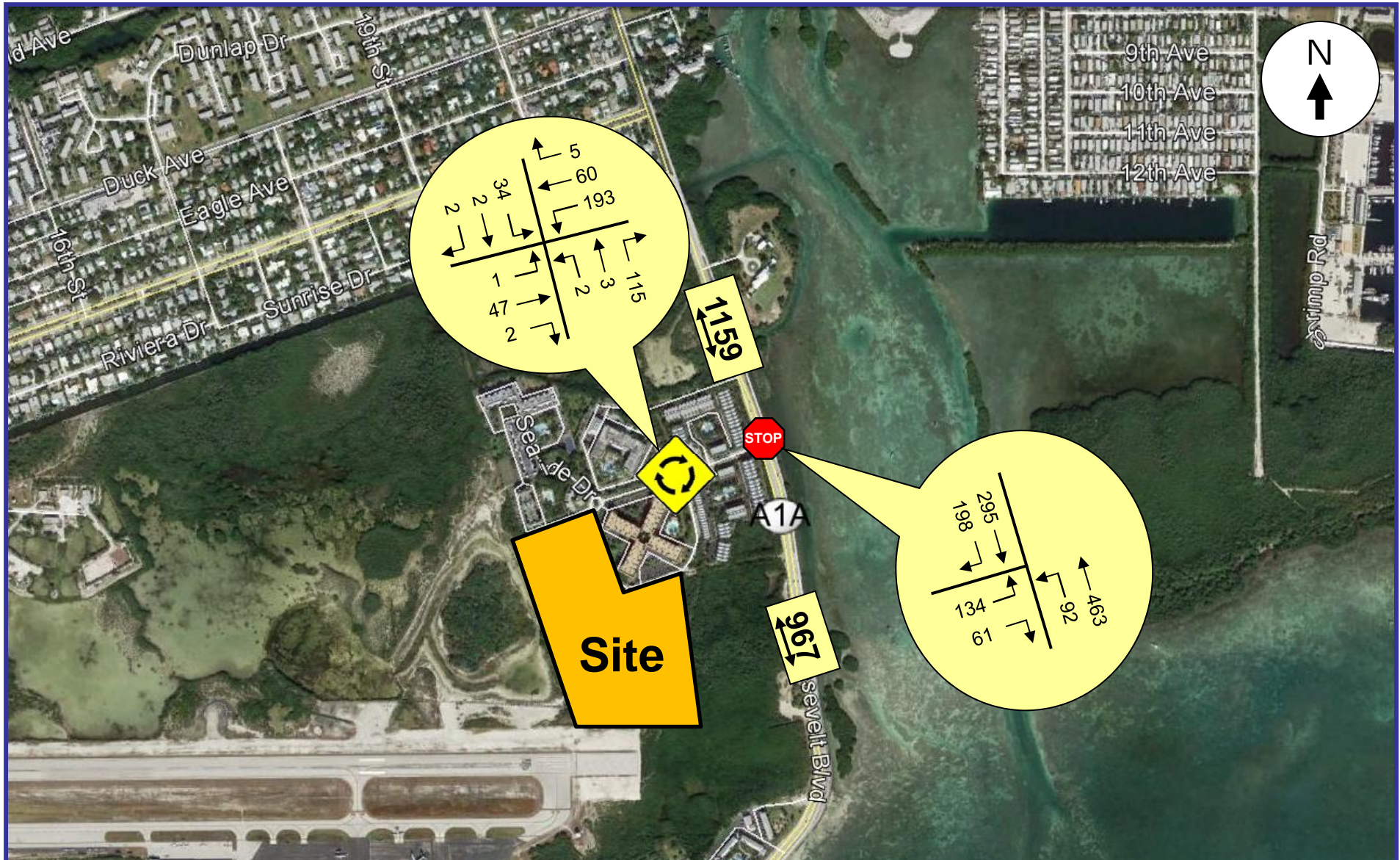

KBP
CONSULTING, INC.

**Future (Year 2019) PM Peak Hour
Total Traffic Volumes**

FIGURE 11
Ocean Walk Apartments
Key West, Florida

TRAFFIC IMPACT ANALYSIS

This section of the traffic report is divided into two parts: 1) intersection analyses, and 2) link analyses.

Intersection Analyses

Intersection capacity/level of service (LOS) analyses were conducted for the two (2) study intersections for existing conditions (2017), future background conditions (2019) without project traffic, and future conditions (2019) with project traffic. These analyses were undertaken following the capacity / level of service procedures outlined in the Highway Capacity Manual (HCM) using the SYNCHRO software. The results of these capacity analyses are summarized in Table 3 below.

Table 3 Ocean Walk Apartments Intersection Levels of Service Key West, Florida						
Intersection / Movement	Existing (2017) Conditions		Future (2019) Conditions Without Project Traffic		Future (2019) Conditions With Project Traffic	
	AM Peak Hour	PM Peak Hour	AM Peak Hour	PM Peak Hour	AM Peak Hour	PM Peak Hour
S. Roosevelt / Seaside Dr *	C (18.1)	C (23.4)	C (18.7)	C (24.5)	C (20.6)	D (28.7)
Seaside Dr / Roundabout **	A (4.6)	A (4.9)	A (4.7)	A (4.9)	A (4.9)	A (5.2)

Source: Highway Capacity Manual and SYNCHRO.

Legend: D (37.7) = LOS (Average Delay - Seconds / Vehicle)

* At stop-control intersections, the LOS for the critical movement is documented in this table.

** At roundabout intersections, the LOS for the intersection as a whole is documented in this table.

As indicated in Table 3, each of the study intersections is currently operating at an acceptable Level of Service (LOS) and they are expected to continue operating at an acceptable LOS in the project design year (2019) both with and without the project traffic. The SYNCHRO output for the intersection analyses is presented in Appendix F.

Link Analyses

Roadway link levels of service were evaluated in accordance with the Florida Department of Transportation's (FDOT) 2012 Quality/Level of Service Handbook Tables (see Appendix G). The results of these analyses are summarized in Tables 4A and 4B on the following page.

Table 4A Ocean Walk Apartments Roadway Link Levels of Service - AM Peak Hour Key West, Florida										
Roadway Section	Lanes	LOS "C" Volume	LOS "D" Volume	LOS "E" Volume	Existing (2017) Conditions		Future (2019) Conditions w/out Project Traffic		Future (2019) Conditions with Project Traffic	
					Volume (vph)	LOS	Volume (vph)	LOS	Volume (vph)	LOS
S. Roosevelt Blvd (Overseas Hwy to Seaside Drive) ¹	4L	1,245	2,775	2,890	1,050	C	1,071	C	1,095	C
S. Roosevelt Blvd (Seaside Drive to Bertha Street) ¹	4L	1,245	2,775	2,890	847	C	864	C	879	C

Source: FDOT 2012 Quality / Level of Service (LOS) Handbook Tables.

¹ Roadway classified as Class II (35 mph or slower posted speed limit) with a capacity adjustment of -5% per referenced FDOT Table for undivided roadway with exclusive left turn lanes but no exclusive right turn lanes.

Table 4B Ocean Walk Apartments Roadway Link Levels of Service - PM Peak Hour Key West, Florida										
Roadway Section	Lanes	LOS "C" Volume	LOS "D" Volume	LOS "E" Volume	Existing (2017) Conditions		Future (2019) Conditions w/out Project Traffic		Future (2019) Conditions with Project Traffic	
					Volume (vph)	LOS	Volume (vph)	LOS	Volume (vph)	LOS
S. Roosevelt Blvd (Overseas Hwy to Seaside Drive) ¹	4L	1,245	2,775	2,890	1,111	C	1,133	C	1,159	C
S. Roosevelt Blvd (Seaside Drive to Bertha Street) ¹	4L	1,245	2,775	2,890	930	C	949	C	967	C

Source: FDOT 2012 Quality / Level of Service (LOS) Handbook Tables.

¹ Roadway classified as Class II (35 mph or slower posted speed limit) with a capacity adjustment of -5% per referenced FDOT Table for undivided roadway with exclusive left turn lanes but no exclusive right turn lanes.

As indicated in Tables 4A and 4B, both roadway links within the project study area are currently operating at an acceptable level of service (LOS) and will continue to operate at an acceptable LOS in 2019 with and without the project traffic associated with the additional units in the Ocean Walk Apartments community.

ALTERNATIVE MODES OF TRANSPORTATION

The Ocean Walk Apartments study area is well served by the City of Key West Transit service. The Blue and Green Routes have a bus stop within the Ocean Walk / Las Salinas community. These routes provide service along Roosevelt Boulevard, throughout Key West, and on Stock Island. Additionally, the general study area is bicycle and pedestrian friendly. The SeaSide community has an extensive pedestrian network and there is a multi-use path on the ocean side of S. Roosevelt Boulevard. The expansion at the Ocean Walk Apartments community will include bicycle racks and additional sidewalks that will promote these alternative modes of transportation.

SUMMARY & CONCLUSIONS

Ocean Walk Apartments is an existing residential apartment community located at 3900 S. Roosevelt Boulevard (State Road A1A) in the City of Key West, Monroe County, Florida. The subject site is located at the intersection of S. Roosevelt Boulevard and Seaside Drive. The Ocean Walk Apartments community currently consists of 296 residential dwelling units and vehicular access to this site is provided by Seaside Drive which connects to S. Roosevelt Boulevard. This project involves the addition of 80 dwelling units within this community.

According to the trip generation analysis, the expanded Ocean Walk Apartments community is estimated to generate approximately 2,402 daily vehicle trips, 188 AM peak hour vehicle trips (38 inbound and 150 outbound), and approximately 224 vehicle trips (146 inbound and 78 outbound) during the typical afternoon peak hour. When compared with the existing development intensity (i.e. 296 dwelling units), this represents an increase of 485 daily vehicle trips, 39 AM peak hour vehicle trips and 44 PM peak hour vehicle trips.

The results of the intersection and link analyses indicate that the nearby intersections and roadway links will continue to operate at an acceptable level of service with the additional residential dwelling units at the Ocean Walk Apartments community.

APPENDIX A

Ocean Walk Apartments Site Plan

SITE DATA TABLE				
GENERAL				
Ocean Walk - 3900 S. Roosevelt Blvd.				
GENERAL	CODE REQUIREMENT	EXISTING (*A)	PROPOSED	VARIANCE REQUESTED
ZONING			High Density Residential District (HD9)	
FLOOD ZONE			ZONE AE EL 8	
SIZE OF SITE	43,500.00 SF (1.00 ACRE) MIN	745,312.00 SF (17.11 ACRES)	745,312.00 SF (17.11 ACRES)	NONE
MINIMUM LOT WIDTH	80'-0"	134'-0"	134'-0"	NONE
MINIMUM LOT DEPTH	100'-0"	492'-0"	492'-0"	NONE
IMPERVIOUS SURFACE	60% MAX	48.5% (163,171 SQ FT)	49.8% (172,238 SQ FT)	NONE
OPEN SPACE LANDSCAPING	30% MIN	50% (167,630 SQ FT)	50.2% (174,547 SQ FT)	NONE
DENSITY	22 DU PER ACRE	296 UNITS (17.30 PER ACRE)	376 UNITS (21.97 PER ACRE)	40 UNITS AWARDED DURING YEAR 2 BPAS. ADDITIONAL 40 UNITS WILL BE SUBMITTED FOR YEAR 4 BPAS APPLICATION

SITE SETBACKS (Existing and proposed setback numbers based on worst case scenario)				
SETBACK 1 - FRONT	30'-0"	140'-8.5"	140'-10"	NONE
SETBACK 2 - SIDE	25'-0"	30'-5"	30'-5"	NONE
SETBACK 3 - STREET SIDE	25'-0"	52'-11"	52'-11"	NONE
SETBACK 4 - REAR	25'-0"	29'-3"	29'-3"	NONE

HEIGHTS				
HEIGHT OF EXISTING BUILDINGS				
BUILDING 1	40'-0"	16.7 FT	TO BE DEMOLISHED	
BUILDING 2	40'-0"	28.6 FT	N/A	NONE
BUILDING 3	40'-0"	23.1 FT	N/A	NONE
BUILDING 4	40'-0"	12.5 FT	N/A	NONE
BUILDING 5	40'-0"	43.5 FT	N/A	NONE
BUILDING 6	40'-0"	23.1 FT	N/A	NONE
HEIGHTS OF PROPOSED BUILDINGS MEASURED FROM CROWN OF ROAD, CROWN OF ROAD MEASURED TO 3'-0" BASED ON AVERAGE OF SPOT ELEVATIONS THROUGH THE CENTER OF THE ROADS				
BUILDING 6	40'-0"	N/A	40'-0"	NONE
BUILDING 8	40'-0"	N/A	40'-0"	NONE

BUILDING COVERAGE EXISTING				
BUILDING 1		2,900 SQ. FT.	2,900 SQ. FT.	
BUILDING 2		97,522 SQ. FT.		
BUILDING 3		806 SQ. FT.		
BUILDING 4		505 SQ. FT.		
BUILDING 5		43,963 SQ. FT.		
BUILDING 6		806 SQ. FT.		
TOTAL	40% MAX	113.5 % (185,989 SQ. FT.)		NONE

BUILDING COVERAGE PROPOSED				
BUILDING 6		15,263.2 SQ. FT.		
BUILDING 8		18,963.2 SQ. FT.		
TOTAL	40% MAX	4.3 % (134,622.6 SQ. FT.)		NONE

TOTAL BUILDING COVERAGE, EXISTING - DEMOLISHED + PROPOSED = 40% MAX [113.865 & SQ. FT.]

PARKING DATA TABLE

Existing Buildings				
	Existing Parking	Demolished	Proposed	
Auto	317	49	46	
H-Cap	8	2	3	
Bike	0	0	0	
Scoter	0	0	0	
Ratio (Car Parking/Unit) = 325/296 = 1.09				

New Buildings (A & B)

Proposed				
	Existing Parking	Demolished	Proposed	
Auto	100			
H-Cap	1			
Bike	173			
Scoter	0			

TOTAL PROPOSED PARKING

	Code Required	Proposed
Auto	767 (752 standard* + 15 ADA)**	426 (416 standard + 10 ADA)
Bike	273**	173
Scoter	0	0

Ratio (Car Parking/Unit) = 426/376 = 1.13 along with additional 173 bike parking spots.
 *General parking requirement based on 2 spaces per residential dwelling (Multi-Family outside historic district) per Sec. 108-572 of the code.
 **ADA parking requirement based on 2% of the total parking spaces for 501-1000 parking spaces per Sec. 108-400 of the code.
 ***Bicycle parking requirement based on 10% of motor vehicles per Sec. 108-572 of the code.

Environmental Site Data

Parcel Area - Total	745,312.00 sf
Upland Area Impact	39,799.16 sf
Wetland Impacts - Disturbed	14,380.20 sf

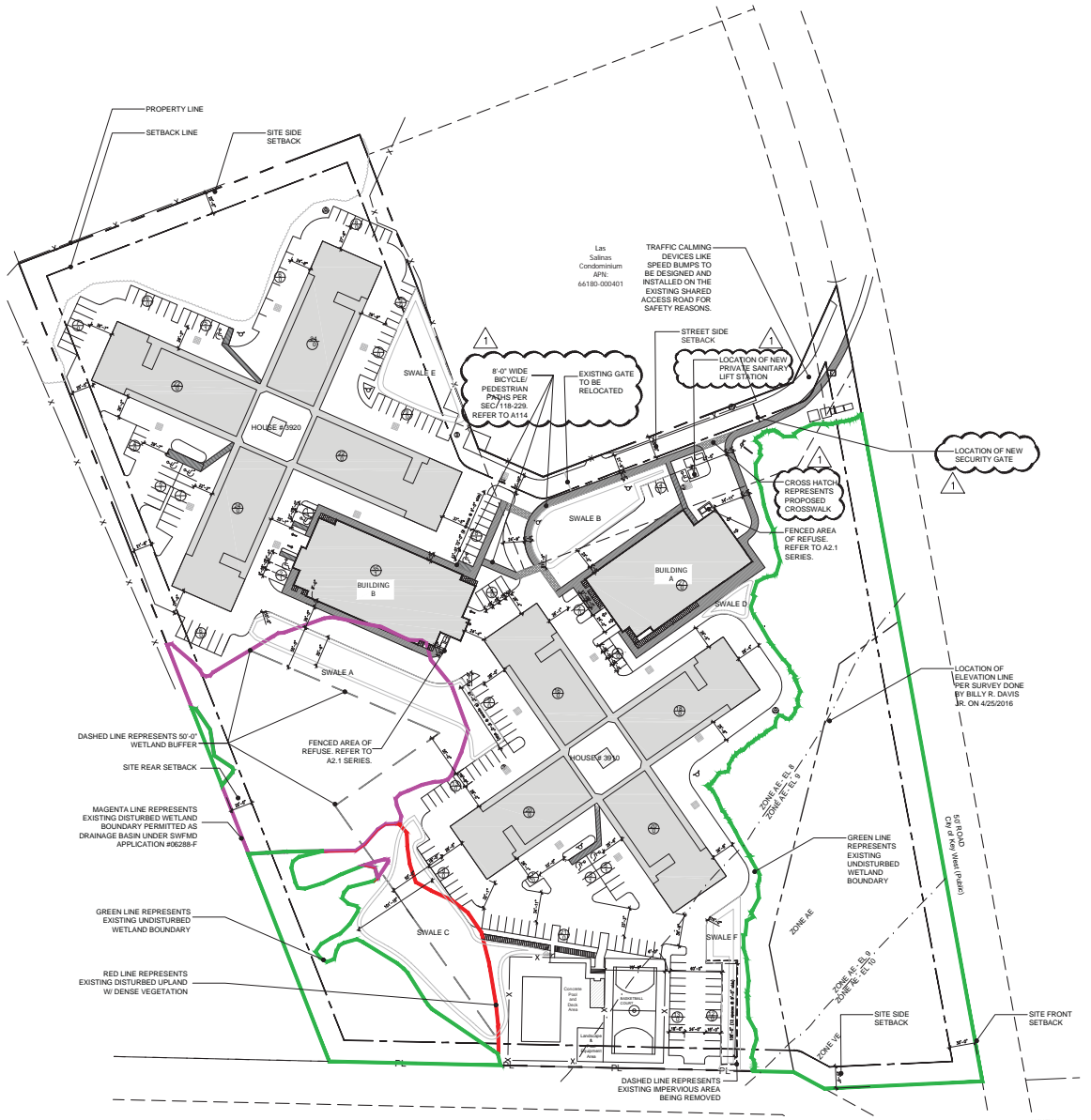

PROPOSED SITE PLAN
 SCALE: 1/64" = 1'-0"

OCEAN WALK APARTMENTS

3900 SOUTH ROOSEVELT BOULEVARD, KEY WEST, FL 33040 RESIDENTIAL NEW CONSTRUCTION-DEVELOPMENT AGREEMENT

APPENDIX B
Historic Traffic Counts

FLORIDA DEPARTMENT OF TRANSPORTATION
 TRANSPORTATION STATISTICS OFFICE
 2015 HISTORICAL AADT REPORT

COUNTY: 90 - MONROE

SITE: 5017 - FLAGLER AV, 200' W SR A1A/S ROOSEVELT BLVD

YEAR	AADT		DIRECTION 1		DIRECTION 2	*K FACTOR	D FACTOR	T FACTOR	
2015	10900	C	E	5500	W	5400	9.00	54.30	8.10
2014	9600	C	E	5000	W	4600	9.00	55.20	3.80
2013	9800	C	E	5000	W	4800	9.00	54.80	7.30
2012	10500	C	E	5400	W	5100	9.00	55.00	8.20
2011	10500	C	E	5500	W	5000	9.00	55.10	8.30
2010	11700	C	E	6100	W	5600	10.26	56.84	10.30
2009	11900	C	E	5800	W	6100	10.23	56.56	8.40
2008	9300	C	E	4800	W	4500	10.45	54.98	8.60
2007	11200	C	E	5700	W	5500	10.00	55.10	9.80
2006	12500	C	E	6200	W	6300	10.08	55.69	12.30
2005	9900	C	E	5400	W	4500	10.40	55.70	2.40
2004	10500	C	E	5300	W	5200	10.00	56.00	3.10
2003	11100	C	E	6000	W	5100	10.10	56.30	4.40
2002	10600	C	E	5700	W	4900	10.00	54.20	5.60
2001	11000	C	E	6000	W	5000	10.00	55.90	6.80
2000	10800	F	E	5700	W	5100	9.90	54.80	6.60

AADT FLAGS: C = COMPUTED; E = MANUAL ESTIMATE; F = FIRST YEAR ESTIMATE
 S = SECOND YEAR ESTIMATE; T = THIRD YEAR ESTIMATE; F = FOURTH YEAR ESTIMATE
 V = FIFTH YEAR ESTIMATE; 6 = SIXTH YEAR ESTIMATE; X = UNKNOWN

*K FACTOR: STARTING WITH YEAR 2011 IS STANDARDK, PRIOR YEARS ARE K30 VALUES

FLORIDA DEPARTMENT OF TRANSPORTATION
 TRANSPORTATION STATISTICS OFFICE
 2015 HISTORICAL AADT REPORT

COUNTY: 90 - MONROE

SITE: 5027 - SR A1A/S ROOSEVELT BLVD, 300' S FLAGLER AV

YEAR	AADT		DIRECTION 1		DIRECTION 2	*K FACTOR	D FACTOR	T FACTOR	
2015	11400	C	N	5600	S	5800	9.00	54.30	8.10
2014	14300	C	N	6600	S	7700	9.00	55.20	3.80
2013	10400	C	N	5400	S	5000	9.00	54.80	7.30
2012	10600	C	N	5200	S	5400	9.00	55.00	8.20
2011	12100	F	N	6100	S	6000	9.00	55.10	8.30
2010	11900	C	N	6000	S	5900	10.26	56.84	10.30
2009	11200	C	N	5700	S	5500	10.23	56.56	8.40
2008	10100	C	N	5200	S	4900	10.45	54.98	8.60
2007	9500	C	N	4700	S	4800	10.00	55.10	9.80
2006	10000	C	N	5200	S	4800	10.08	55.69	12.30
2005	12700	C	N	5900	S	6800	10.40	55.70	5.50
2004	13100	C	N	6500	S	6600	10.00	56.00	3.10
2003	13500	C	N		S		10.10	56.30	4.40
2002	13000	C	N	6400	S	6600	10.00	54.20	5.60
2001	11000	C	N		S		10.00	55.90	6.80
2000	9600	C	N	4900	S	4700	9.90	54.80	6.60

AADT FLAGS: C = COMPUTED; E = MANUAL ESTIMATE; F = FIRST YEAR ESTIMATE
 S = SECOND YEAR ESTIMATE; T = THIRD YEAR ESTIMATE; F = FOURTH YEAR ESTIMATE
 V = FIFTH YEAR ESTIMATE; 6 = SIXTH YEAR ESTIMATE; X = UNKNOWN

*K FACTOR: STARTING WITH YEAR 2011 IS STANDARDK, PRIOR YEARS ARE K30 VALUES

APPENDIX C
Current Traffic Counts

TRIDENT Engineering

CLIENT: KBP
 JOB No: 2017-00169
 PROJECT: TMC
 COUNTY: Monroe

10232 NW 47 Street
 Sunrise, FL 33351
 TEL: 954-815-3265

File Name: 20170208 TMC
 Site Code: -
 Count Date: 02/08/2017 (Wed.)
 Page No: 1 of 4

Groups Printed: Automobiles & Heavy Vehicles

Start Time	SR A1A Southbound				Westbound				SR A1A Northbound				Ocean Walk Eastbound				Int Total
	U-Turn	Left	Thru	Right	U-Turn	Left	Thru	Right	U-Turn	Left	Thru	Right	U-Turn	Left	Thru	Right	
06:00 AM																	
06:15 AM																	
06:30 AM																	
06:45 AM																	
Total																	
07:00 AM	0	0	75	12	0	0	0	0	0	4	39	0	0	46	0	39	215
07:15 AM	0	0	82	13	0	0	0	0	0	5	47	0	0	48	0	40	235
07:30 AM	0	0	108	13	0	0	0	0	0	5	64	0	0	49	0	36	275
07:45 AM	0	0	98	20	0	0	0	0	0	6	41	0	0	44	0	26	235
Total	0	0	363	58	0	0	0	0	0	20	191	0	0	187	0	141	960
08:00 AM	0	0	77	21	0	0	0	0	0	7	44	0	0	48	0	24	221
08:15 AM	0	0	59	11	0	0	0	0	0	5	45	0	0	45	0	23	188
08:30 AM	0	0	86	21	0	0	0	0	0	7	42	0	0	48	0	18	222
08:45 AM	0	0	60	21	0	0	0	0	0	7	46	0	0	34	0	12	180
Total	0	0	282	74	0	0	0	0	0	26	177	0	0	175	0	77	811
09:00 AM																	
09:15 AM																	
09:30 AM																	
09:45 AM																	
Total																	
10:00 AM																	
10:15 AM																	
10:30 AM																	
10:45 AM																	
Total																	
11:00 AM																	
11:15 AM																	
11:30 AM																	
11:45 AM																	
Total																	
12:00 PM																	
12:15 PM																	
12:30 PM																	
12:45 PM																	
Total																	
01:00 PM																	
01:15 PM																	
01:30 PM																	
01:45 PM																	
Total																	
02:00 PM																	
02:15 PM																	
02:30 PM																	
02:45 PM																	
Total																	
03:00 PM																	
03:15 PM																	
03:30 PM																	
03:45 PM																	
Total																	
04:00 PM	0	0	89	42	0	0	0	0	0	12	98	0	0	29	0	11	281
04:15 PM	0	0	69	38	0	0	0	0	0	15	113	0	0	24	0	12	271
04:30 PM	0	0	81	38	0	0	0	0	0	17	121	0	0	35	0	14	306
04:45 PM	0	0	68	27	0	0	0	0	0	14	100	0	0	23	0	11	243
Total	0	0	307	145	0	0	0	0	0	58	432	0	0	111	0	48	1101
05:00 PM	0	1	61	52	0	0	0	0	0	22	122	0	0	33	0	11	302
05:15 PM	0	0	78	60	0	0	0	0	0	25	111	0	0	32	0	18	324
05:30 PM	1	0	65	46	0	0	0	0	0	17	95	0	0	29	0	16	269
05:45 PM	0	0	70	47	0	0	0	0	0	14	78	0	0	36	0	18	263
Total	1	1	274	205	0	0	0	0	0	78	406	0	0	130	0	63	1158
06:00 PM																	
06:15 PM																	
06:30 PM																	
06:45 PM																	
Total																	

*****BREAK*****

*****BREAK*****

TRIDENT Engineering

10232 NW 47 Street
Sunrise, FL 33351
TEL: 954-815-3265

File Name: 20170208 TMC
Site Code: -
Count Date: 2/8/2017 (Wed.)
Page No: 2 of 4

CLIENT: KBP
JOB No: 2017-00169
PROJECT: TMC
COUNTY: Monroe

Groups Printed: Automobiles & Heavy Vehicles

Start Time	SR A1A Southbound				- Westbound				SR A1A Northbound				Ocean Walk Eastbound				Int Total
	U-Turn	Left	Thru	Right	U-Turn	Left	Thru	Right	U-Turn	Left	Thru	Right	U-Turn	Left	Thru	Right	
07:15 AM	0	0	82	13	0	0	0	0	0	5	47	0	0	48	0	40	235
07:30 AM	0	0	108	13	0	0	0	0	0	5	64	0	0	49	0	36	275
07:45 AM	0	0	98	20	0	0	0	0	0	6	41	0	0	44	0	26	235
08:00 AM	0	0	77	21	0	0	0	0	0	7	44	0	0	48	0	24	221
Total	0	0	365	67	0	0	0	0	0	23	196	0	0	189	0	126	966
PHF	0.000	0.000	0.845	0.798	0.000	0.000	0.000	0.000	0.000	0.821	0.766	0.000	0.000	0.964	0.000	0.788	0.88
Heavy Veh %	0%	0%	0%	0%	0%	0%	0%	0%	0%	0%	0%	0%	0%	0%	0%	0%	0%
App Vol %	0%	0%	84%	16%	0%	0%	0%	0%	0%	11%	89%	0%	0%	60%	0%	40%	

Intersection Peak Hour Analysis From 07:00 AM to 9:00 AM
Peak Hour for Entire Intersection Begins at : 07:15 AM to 08:15 AM

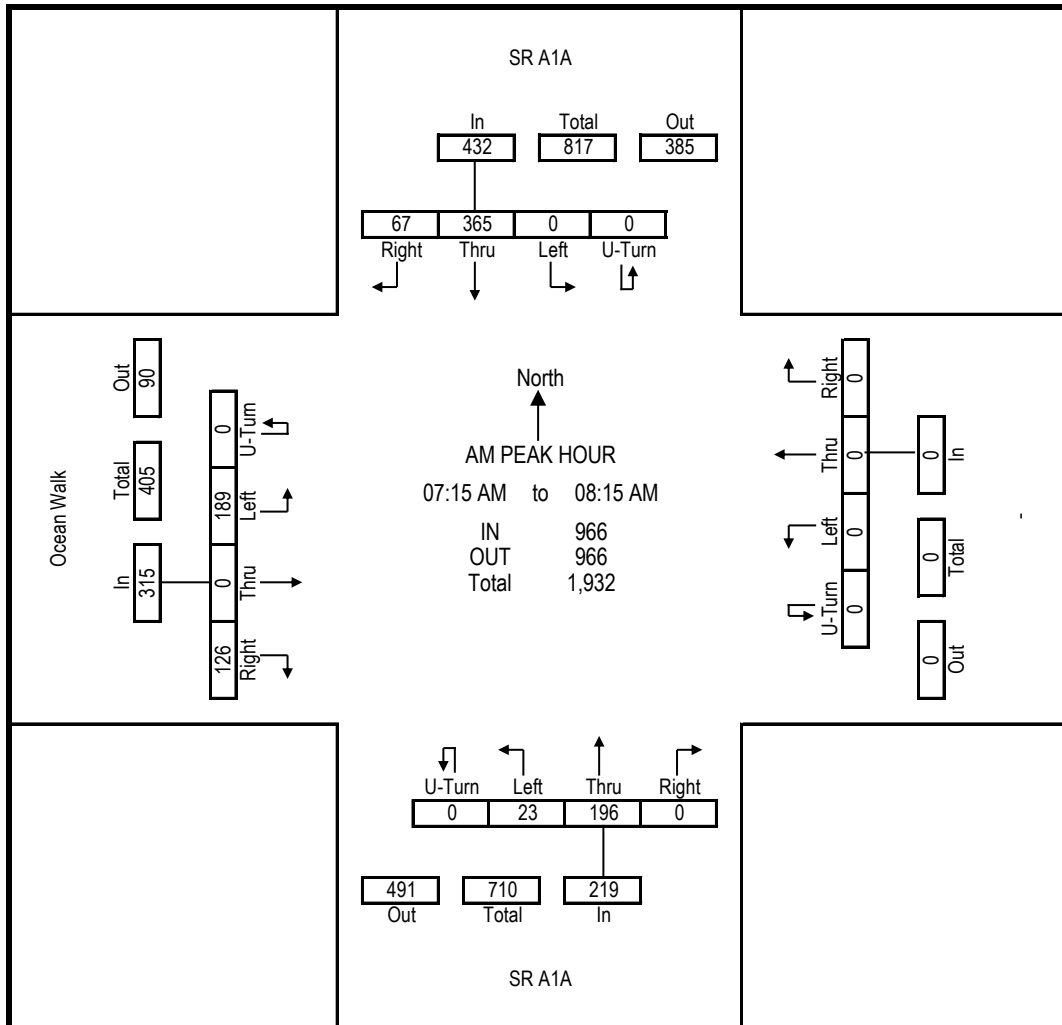

TRIDENT Engineering

10232 NW 47 Street
Sunrise, FL 33351
TEL: 954-815-3265

CLIENT: KBP
JOB No: 2017-00169
PROJECT: TMC
COUNTY: Monroe

File Name: 20170208 TMC
Site Code: -
Count Date: 2/8/2017 (Wed.)
Page No: 3 of 4

Groups Printed: Automobiles & Heavy Vehicles

Start Time	SR A1A Southbound				- Westbound				SR A1A Northbound				Ocean Walk Eastbound				Int Total
	U-Turn	Left	Thru	Right	U-Turn	Left	Thru	Right	U-Turn	Left	Thru	Right	U-Turn	Left	Thru	Right	
04:30 PM	0	0	81	38	0	0	0	0	0	17	121	0	0	35	0	14	306
04:45 PM	0	0	68	27	0	0	0	0	0	14	100	0	0	23	0	11	243
05:00 PM	0	1	61	52	0	0	0	0	0	22	122	0	0	33	0	11	302
05:15 PM	0	0	78	60	0	0	0	0	0	25	111	0	0	32	0	18	324
Total	0	1	288	177	0	0	0	0	0	78	454	0	0	123	0	54	1175
PHF	0.000	0.250	0.889	0.738	0.000	0.000	0.000	0.000	0.000	0.780	0.930	0.000	0.000	0.879	0.000	0.750	0.91
Heavy Veh %	0%	0%	0%	0%	0%	0%	0%	0%	0%	0%	0%	0%	0%	0%	0%	0%	0%
App Vol %	0%	0%	62%	38%	0%	0%	0%	0%	0%	15%	85%	0%	0%	69%	0%	31%	

Intersection Peak Hour Analysis From 04:00 PM to 06:00 PM

Peak Hour for Entire Intersection Begins at : 04:30 PM to 05:30 PM

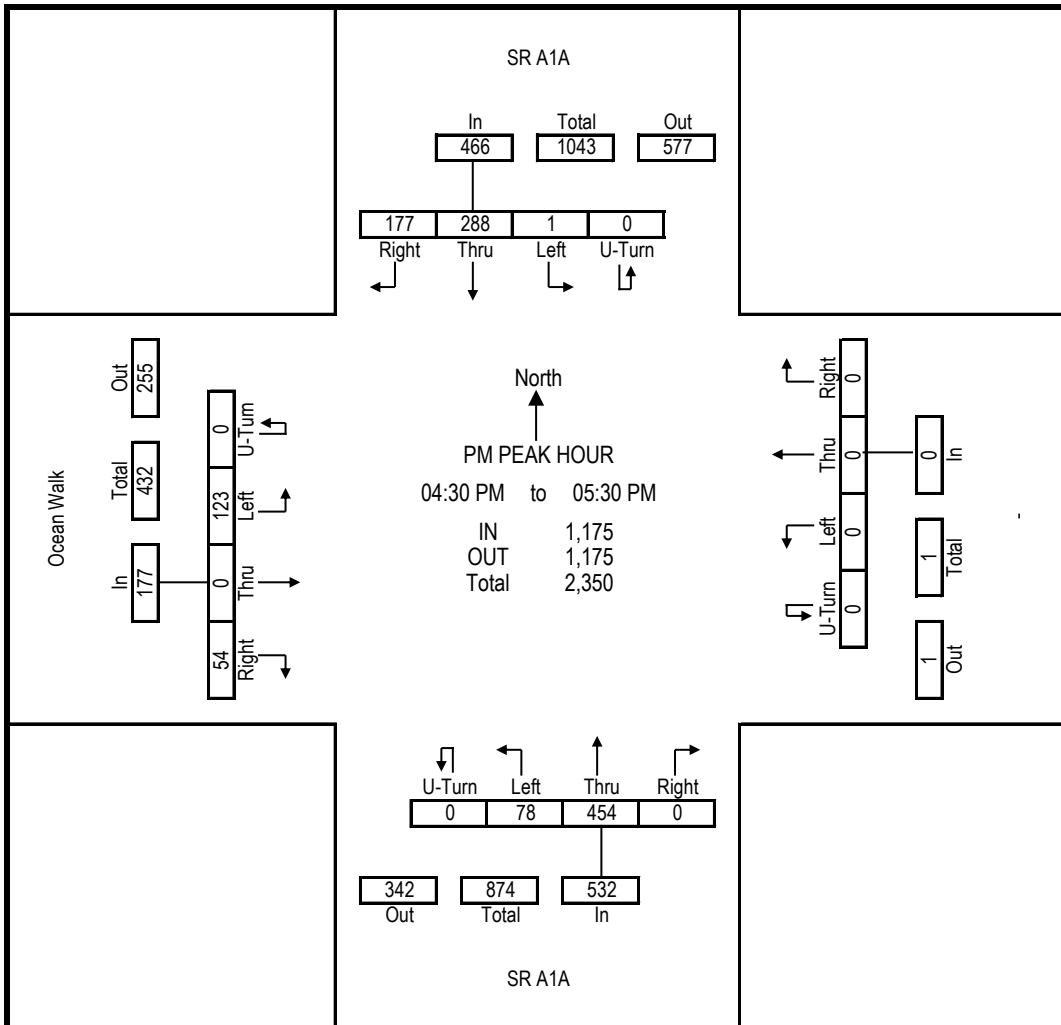

TRIDENT Engineering

CLIENT: KBP
 JOB No: 2017-00169
 PROJECT: TMC
 COUNTY: Monroe

10232 NW 47 Street
 Sunrise, FL 33351
 TEL: 954-815-3265

File Name: 20170208 TMC
 Site Code: -
 Count Date: 2/8/2017 (Wed.)
 Page No: 4 of 4

Groups Printed: Bicyclists & Pedestrians

Start Time	SR A1A (north/south)	Ocean Walk (Across SR A1A) (east/west)	SR A1A (north/south)	- (east/west)	Int Total
	Weast Side	North Side	East Side	South Side	
06:00 AM					
06:15 AM					
06:30 AM					
06:45 AM					
Total					
07:00 AM	0	10	0	0	10
07:15 AM	0	18	0	0	18
07:30 AM	0	6	0	0	6
07:45 AM	0	5	0	0	5
Total	0	39	0	0	39
08:00 AM	0	9	0	0	9
08:15 AM	0	15	0	0	15
08:30 AM	0	5	0	0	5
08:45 AM	0	2	0	0	2
Total	0	31	0	0	31
09:00 AM					
09:15 AM					
09:30 AM					
09:45 AM					
Total					
10:00 AM					
10:15 AM					
10:30 AM					
10:45 AM					
Total					
11:00 AM					
11:15 AM					
11:30 AM					
11:45 AM					
Total					
12:00 PM					
12:15 PM					
12:30 PM					
12:45 PM					
Total					
01:00 PM					
01:15 PM					
01:30 PM					
01:45 PM					
Total					
02:00 PM					
02:15 PM					
02:30 PM					
02:45 PM					
Total					
03:00 PM					
03:15 PM					
03:30 PM					
03:45 PM					
Total					
04:00 PM	0	7	0	0	7
04:15 PM	0	6	0	0	6
04:30 PM	0	4	0	0	4
04:45 PM	0	8	0	0	8
Total	0	25	0	0	25
05:00 PM	0	1	0	0	1
05:15 PM	0	11	0	0	11
05:30 PM	0	10	0	0	10
05:45 PM	0	2	0	0	2
Total	0	24	0	0	24
06:00 PM					
06:15 PM					
06:30 PM					
06:45 PM					
Total					

*****BREAK*****

*****BREAK*****

TRIDENT Engineering

CLIENT: KBP
 JOB No: 2017-00169
 PROJECT: TMC
 COUNTY: Monroe

10232 NW 47 Street
 Sunrise, FL 33351
 TEL: 954-815-3265

File Name: 20170208 TMC
 Site Code: -
 Count Date: 02/08/2017 (Wed.)
 Page No: 1 of 4

Groups Printed: Automobiles & Heavy Vehicles

Start Time	North D/W Southbound				Ocean Walk Westbound				South D/W Northbound				Ocean Walk Eastbound				Int Total
	U-Turn	Left	Thru	Right	U-Turn	Left	Thru	Right	U-Turn	Left	Thru	Right	U-Turn	Left	Thru	Right	
06:00 AM																	
06:15 AM																	
06:30 AM																	
06:45 AM																	
Total																	
07:00 AM	0	11	0	0	2	11	2	2	0	0	4	32	0	1	10	0	75
07:15 AM	0	14	0	0	2	10	4	1	0	0	2	38	0	0	16	0	87
07:30 AM	0	13	0	1	1	11	3	0	0	0	2	41	0	0	22	2	96
07:45 AM	0	9	0	0	4	10	8	2	0	1	1	38	0	1	14	0	88
Total	0	47	0	1	9	42	17	5	0	1	9	149	0	2	62	2	346
08:00 AM	0	13	2	0	1	13	9	1	0	0	3	40	0	0	13	0	95
08:15 AM	0	9	1	0	0	10	8	0	0	0	4	36	0	1	14	2	85
08:30 AM	0	15	0	0	4	14	6	1	0	2	1	31	0	0	12	0	86
08:45 AM	0	8	4	1	1	11	5	1	0	0	3	14	0	0	13	0	61
Total	0	45	7	1	6	48	28	3	0	2	11	121	0	1	52	2	327
09:00 AM																	
09:15 AM																	
09:30 AM																	
09:45 AM																	
Total																	
10:00 AM																	
10:15 AM																	
10:30 AM																	
10:45 AM																	
Total																	
11:00 AM																	
11:15 AM																	
11:30 AM																	
11:45 AM																	
Total																	
12:00 PM																	
12:15 PM																	
12:30 PM																	
12:45 PM																	
Total																	
01:00 PM																	
01:15 PM																	
01:30 PM																	
01:45 PM																	
Total																	
02:00 PM																	
02:15 PM																	
02:30 PM																	
02:45 PM																	
Total																	
03:00 PM																	
03:15 PM																	
03:30 PM																	
03:45 PM																	
Total																	
04:00 PM	0	11	0	1	3	31	15	2	0	0	2	26	0	1	6	1	99
04:15 PM	0	5	2	1	1	34	11	0	0	0	0	20	0	0	6	0	80
04:30 PM	0	13	1	1	0	33	11	4	0	1	2	15	0	0	14	0	95
04:45 PM	0	5	1	0	0	26	16	0	0	1	0	23	0	1	11	0	84
Total	0	34	4	3	4	124	53	6	0	2	4	84	0	2	37	1	358
05:00 PM	0	11	0	0	1	39	17	4	0	1	1	17	0	1	11	1	104
05:15 PM	0	5	1	1	0	41	17	1	0	0	0	32	0	0	12	0	110
05:30 PM	0	12	0	0	2	41	8	0	0	1	1	21	0	0	8	1	95
05:45 PM	0	5	1	1	0	37	17	0	0	0	1	28	0	0	15	0	105
Total	0	33	2	2	3	158	59	5	0	2	3	98	0	1	46	2	414
06:00 PM																	
06:15 PM																	
06:30 PM																	
06:45 PM																	
Total																	

*****BREAK*****

*****BREAK*****

TRIDENT Engineering

10232 NW 47 Street
Sunrise, FL 33351
TEL: 954-815-3265

CLIENT: KBP
JOB No: 2017-00169
PROJECT: TMC
COUNTY: Monroe

File Name: 20170208 TMC
Site Code: -
Count Date: 2/8/2017 (Wed.)
Page No: 2 of 4

Groups Printed: Automobiles & Heavy Vehicles

Start Time	North D/W Southbound				Ocean Walk Westbound				South D/W Northbound				Ocean Walk Eastbound				Int Total
	U-Turn	Left	Thru	Right	U-Turn	Left	Thru	Right	U-Turn	Left	Thru	Right	U-Turn	Left	Thru	Right	
07:15 AM	0	14	0	0	2	10	4	1	0	0	2	38	0	0	16	0	87
07:30 AM	0	13	0	1	1	11	3	0	0	0	2	41	0	0	22	2	96
07:45 AM	0	9	0	0	4	10	8	2	0	1	1	38	0	1	14	0	88
08:00 AM	0	13	2	0	1	13	9	1	0	0	3	40	0	0	13	0	95
Total	0	49	2	1	8	44	24	4	0	1	8	157	0	1	65	2	366
PHF	0.000	0.875	0.250	0.250	0.500	0.846	0.667	0.500	0.000	0.250	0.667	0.957	0.000	0.250	0.739	0.250	0.95
Heavy Veh %	0%	0%	0%	0%	0%	0%	0%	0%	0%	0%	0%	0%	0%	0%	0%	0%	0%
App Vol %	0%	94%	4%	2%	10%	55%	30%	5%	0%	1%	5%	95%	0%	1%	96%	3%	

Intersection Peak Hour Analysis From 07:00 AM to 9:00 AM
Peak Hour for Entire Intersection Begins at : 07:15 AM to 08:15 AM

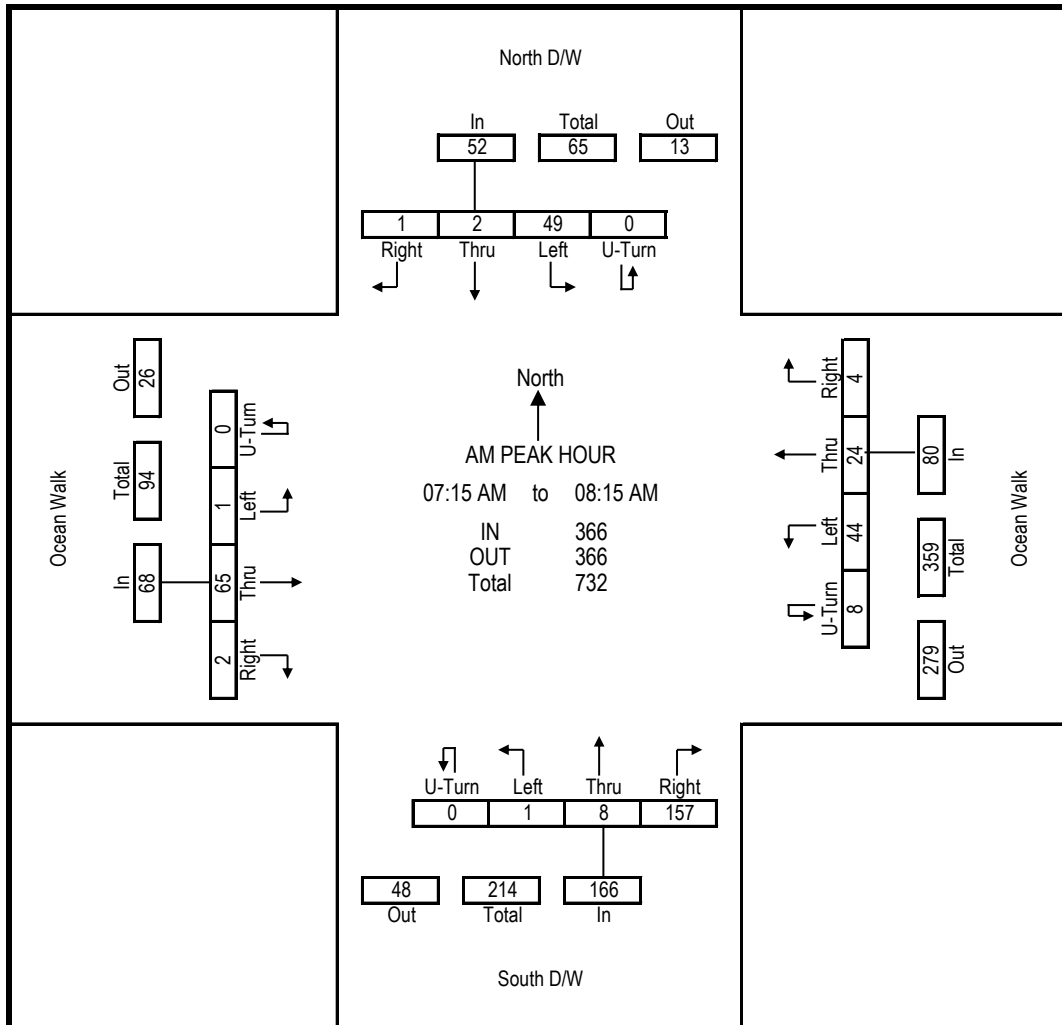

TRIDENT Engineering

10232 NW 47 Street
Sunrise, FL 33351
TEL: 954-815-3265

CLIENT: KBP
JOB No: 2017-00169
PROJECT: TMC
COUNTY: Monroe

File Name: 20170208 TMC
Site Code: -
Count Date: 2/8/2017 (Wed.)
Page No: 3 of 4

Groups Printed: Automobiles & Heavy Vehicles

Start Time	North D/W Southbound				Ocean Walk Westbound				South D/W Northbound				Ocean Walk Eastbound				Int Total
	U-Turn	Left	Thru	Right	U-Turn	Left	Thru	Right	U-Turn	Left	Thru	Right	U-Turn	Left	Thru	Right	
05:00 PM	0	11	0	0	1	39	17	4	0	1	1	17	0	1	11	1	104
05:15 PM	0	5	1	1	0	41	17	1	0	0	0	32	0	0	12	0	110
05:30 PM	0	12	0	0	2	41	8	0	0	1	1	21	0	0	8	1	95
05:45 PM	0	5	1	1	0	37	17	0	0	0	1	28	0	0	15	0	105
Total	0	33	2	2	3	158	59	5	0	2	3	98	0	1	46	2	414
PHF	0.000	0.688	0.500	0.500	0.375	0.963	0.868	0.313	0.000	0.500	0.750	0.766	0.000	0.250	0.767	0.500	0.94
Heavy Veh %	0%	0%	0%	0%	0%	0%	0%	0%	0%	0%	0%	0%	0%	0%	0%	0%	0%
App Vol %	0%	89%	5%	5%	1%	70%	26%	2%	0%	2%	3%	95%	0%	2%	94%	4%	

Intersection Peak Hour Analysis From 04:00 PM to 06:00 PM

Peak Hour for Entire Intersection Begins at : 05:00 PM to 06:00 PM

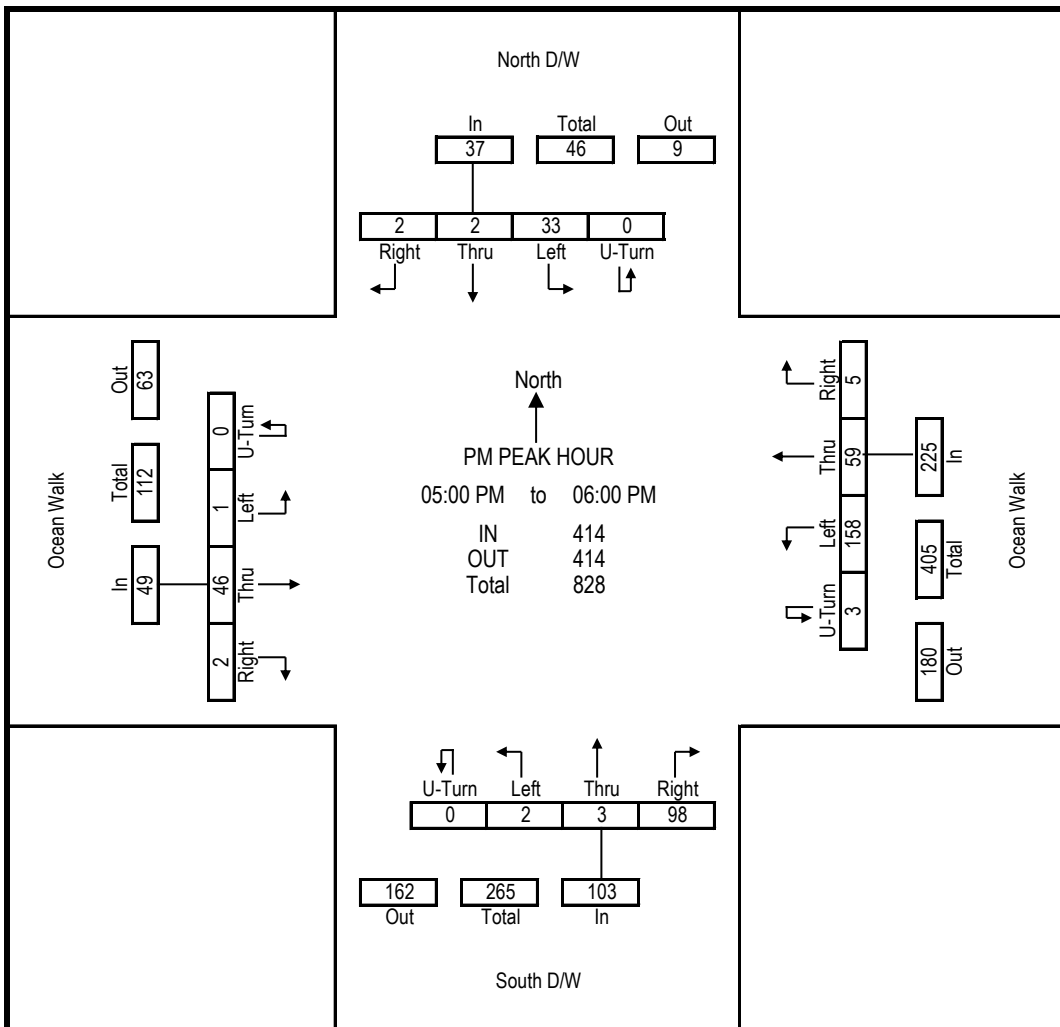

TRIDENT Engineering

CLIENT: KBP
 JOB No: 2017-00169
 PROJECT: TMC
 COUNTY: Monroe

10232 NW 47 Street
 Sunrise, FL 33351
 TEL: 954-815-3265

File Name: 20170208 TMC
 Site Code: -
 Count Date: 2/8/2017 (Wed.)
 Page No: 4 of 4

Groups Printed: Bicyclists & Pedestrians

Start Time	North D/W (north/south)	Ocean Walk (east/west)	South D/W (north/south)	Ocean Walk (east/west)	Int Total
	Weast Side	North Side	East Side	South Side	
06:00 AM					
06:15 AM					
06:30 AM					
06:45 AM					
Total					
07:00 AM	1	1	2	3	7
07:15 AM	0	3	15	10	28
07:30 AM	3	0	8	4	15
07:45 AM	1	0	3	2	6
Total	5	4	28	19	56
08:00 AM	0	2	3	2	7
08:15 AM	0	4	5	0	9
08:30 AM	0	6	1	2	9
08:45 AM	2	5	1	0	8
Total	2	17	10	4	33
09:00 AM					
09:15 AM					
09:30 AM					
09:45 AM					
Total					
10:00 AM					
10:15 AM					
10:30 AM					
10:45 AM					
Total					
11:00 AM					
11:15 AM					
11:30 AM					
11:45 AM					
Total					
12:00 PM					
12:15 PM					
12:30 PM					
12:45 PM					
Total					
01:00 PM					
01:15 PM					
01:30 PM					
01:45 PM					
Total					
02:00 PM					
02:15 PM					
02:30 PM					
02:45 PM					
Total					
03:00 PM					
03:15 PM					
03:30 PM					
03:45 PM					
Total					
04:00 PM	1	1	4	0	6
04:15 PM	4	1	7	1	13
04:30 PM	0	1	1	1	3
04:45 PM	1	1	3	0	5
Total	6	4	15	2	27
05:00 PM	3	0	8	0	11
05:15 PM	2	1	7	1	11
05:30 PM	0	4	2	0	6
05:45 PM	7	5	6	1	19
Total	12	10	23	2	47
06:00 PM					
06:15 PM					
06:30 PM					
06:45 PM					
Total					

*****BREAK*****

*****BREAK*****

TRIDENT Engineering, LLC

10232 NW 47 Street, Weston, FL 33351
954.815.3265

SR A1A (S. Roosevelt Blvd.) north Ocean Walk SB Volumes (2/8 - 2/10/2017)

Start Time	Thu 09-Feb-17	<-----Quarter		Hour----->		Hour Total	
		1st	2nd	3rd	4th		
12:00 AM		22	8	17	9	56	
01:00		9	7	6	3	25	
02:00		5	3	2	2	12	
03:00		0	5	4	5	14	
04:00		4	4	4	9	21	
05:00		10	8	16	27	61	
06:00		29	26	43	44	142	
07:00		74	74	97	120	365	
08:00		107	93	99	105	404	
09:00		98	89	96	102	385	
10:00		100	102	110	106	418	
11:00		128	123	130	158	539	
12:00 PM		136	115	130	151	532	
01:00		129	116	120	154	519	
02:00		129	134	138	136	537	
03:00		148	144	136	128	556	
04:00		150	134	154	148	586	
05:00		177	164	150	110	601	
06:00		100	116	108	102	426	
07:00		78	80	70	72	300	
08:00		59	56	40	52	207	
09:00		54	47	31	44	176	
10:00		36	35	35	33	139	
11:00		33	31	23	16	103	
Day Total						7124	

TRIDENT Engineering, LLC

10232 NW 47 Street, Weston, FL 33351
954.815.3265

SR A1A (S. Roosevelt Blvd.) north Ocean Walk SB Volumes (2/8 - 2/10/2017)

Start Time	Fri 10-Feb-17	<-----Quarter		Hour----->		Hour Total	
		1st	2nd	3rd	4th		
12:00 AM		14	11	14	13	52	
01:00		9	6	7	3	25	
02:00		4	3	3	5	15	
03:00		5	2	10	2	19	
04:00		3	5	5	10	23	
05:00		9	5	18	32	64	
06:00		28	29	42	62	161	
07:00		66	102	85	112	365	
08:00		100	92	107	104	403	
09:00		103	96	101	114	414	
10:00		128	111	116	123	478	
11:00		154	154	135	152	595	
12:00 PM		143	118	136	152	549	
01:00		148	150	140	148	586	
02:00		136	134	161	156	587	
03:00		148	152	134	147	581	
04:00		144	160	166	150	620	
05:00		166	169	128	119	582	
06:00		120	132	129	88	469	
07:00		93	86	70	85	334	
08:00		78	58	46	52	234	
09:00		56	64	46	31	197	
10:00		58	46	60	48	212	
11:00		38	36	30	25	129	
Day Total						7694	
Total						19119	
ADT		ADT 5,934		AADT 5,934			

TRIDENT Engineering, LLC

10232 NW 47 Street, Weston, FL 33351
954.815.3265

SR A1A (S. Roosevelt Blvd.) north Ocean Walk NB Volumes (2/8 - 2/10/2017)

Start Time	Thu 09-Feb-17	<-----Quarter		Hour----->		Hour Total	
		1st	2nd	3rd	4th		
12:00 AM		11	14	14	9	48	
01:00		12	10	4	3	29	
02:00		5	7	4	5	21	
03:00		8	4	1	2	15	
04:00		4	4	6	10	24	
05:00		11	12	12	21	56	
06:00		21	21	38	64	144	
07:00		80	77	104	120	381	
08:00		128	103	118	124	473	
09:00		82	76	78	74	310	
10:00		75	102	100	103	380	
11:00		94	114	113	106	427	
12:00 PM		112	115	113	122	462	
01:00		109	96	86	101	392	
02:00		104	111	98	101	414	
03:00		118	122	96	120	456	
04:00		111	122	114	141	488	
05:00		112	126	104	100	442	
06:00		106	101	98	76	381	
07:00		76	82	61	60	279	
08:00		52	51	54	52	209	
09:00		44	49	45	50	188	
10:00		48	40	37	45	170	
11:00		32	28	20	14	94	
Day Total						6283	

TRIDENT Engineering, LLC

10232 NW 47 Street, Weston, FL 33351
954.815.3265

SR A1A (S. Roosevelt Blvd.) north Ocean Walk NB Volumes (2/8 - 2/10/2017)

Start Time	Fri 10-Feb-17	<-----Quarter		Hour----->		Hour Total	
		1st	2nd	3rd	4th		
12:00 AM		18	15	11	11	55	
01:00		8	5	4	6	23	
02:00		5	7	10	8	30	
03:00		1	6	8	2	17	
04:00		8	4	7	13	32	
05:00		16	13	10	26	65	
06:00		23	32	44	56	155	
07:00		92	91	100	122	405	
08:00		135	110	80	94	419	
09:00		92	81	82	96	351	
10:00		87	90	120	110	407	
11:00		106	137	114	136	493	
12:00 PM		116	102	136	107	461	
01:00		128	118	110	136	492	
02:00		128	120	136	127	511	
03:00		110	119	110	96	435	
04:00		125	116	116	114	471	
05:00		112	132	126	97	467	
06:00		98	79	93	85	355	
07:00		86	73	64	56	279	
08:00		65	62	43	48	218	
09:00		63	31	44	56	194	
10:00		55	48	48	44	195	
11:00		27	40	35	16	118	
Day Total						6648	
Total						16637	
ADT		ADT 5,301		AADT 5,301			

TRIDENT Engineering, LLC

10232 NW 47 Street, Weston, FL 33351
954.815.3265

SR A1A (S. Roosevelt Blvd.) south Ocean Walk SB Volumes (2/8 - 2/10/2017)

Start Time	Thu 09-Feb-17	<-----Quarter		Hour----->		Hour Total	
		1st	2nd	3rd	4th		
12:00 AM		6	6	6	8	26	
01:00		8	4	3	0	15	
02:00		0	1	0	5	6	
03:00		1	4	1	0	6	
04:00		1	4	2	9	16	
05:00		10	16	13	22	61	
06:00		22	27	52	71	172	
07:00		90	92	128	142	452	
08:00		130	96	132	120	478	
09:00		80	71	85	89	325	
10:00		82	90	95	102	369	
11:00		88	108	102	92	390	
12:00 PM		96	88	102	110	396	
01:00		94	76	76	86	332	
02:00		92	91	78	85	346	
03:00		106	94	72	104	376	
04:00		98	102	94	100	394	
05:00		89	93	69	79	330	
06:00		94	64	68	45	271	
07:00		46	47	37	31	161	
08:00		29	30	27	29	115	
09:00		30	24	27	22	103	
10:00		27	25	21	32	105	
11:00		24	8	11	4	47	
Day Total						5292	

TRIDENT Engineering, LLC

10232 NW 47 Street, Weston, FL 33351
954.815.3265

SR A1A (S. Roosevelt Blvd.) south Ocean Walk SB Volumes (2/8 - 2/10/2017)

Start Time	Fri 10-Feb-17	<-----Quarter		Hour----->		Hour Total	
		1st	2nd	3rd	4th		
12:00 AM		7	5	4	2	18	■
01:00		2	1	3	1	7	
02:00		2	5	6	1	14	■
03:00		0	4	3	1	8	
04:00		4	1	3	8	16	■
05:00		13	20	14	28	75	■
06:00		20	36	46	66	168	■
07:00		96	112	124	136	468	■
08:00		130	106	86	94	416	■
09:00		86	87	75	98	346	■
10:00		86	94	108	110	398	■
11:00		94	116	92	125	427	■
12:00 PM		94	92	120	93	399	■
01:00		120	105	92	104	421	■
02:00		106	110	110	106	432	■
03:00		95	92	94	79	360	■
04:00		96	104	100	80	380	■
05:00		90	91	90	86	357	■
06:00		72	60	65	63	260	■
07:00		64	45	45	50	204	■
08:00		40	39	22	31	132	■
09:00		33	23	25	28	109	■
10:00		28	31	32	26	117	■
11:00		17	13	14	10	54	■
Day Total						5586	
Total						16246	
ADT		ADT 5,245		AADT 5,245			

TRIDENT Engineering, LLC

10232 NW 47 Street, Weston, FL 33351
954.815.3265

SR A1A (S. Roosevelt Blvd.) south Ocean Walk NB Volumes (2/8 - 2/10/2017)

Start Time	Thu 09-Feb-17	<-----Quarter		Hour----->		Hour Total	
		1st	2nd	3rd	4th		
12:00 AM		21	5	13	6	45	
01:00		8	3	6	2	19	
02:00		2	1	1	3	7	
03:00		1	0	4	5	10	
04:00		4	5	4	1	14	
05:00		5	2	8	19	34	
06:00		13	14	18	22	67	
07:00		28	44	47	72	191	
08:00		48	55	67	60	230	
09:00		70	64	79	60	273	
10:00		60	74	79	79	292	
11:00		94	84	77	95	350	
12:00 PM		112	64	95	100	371	
01:00		89	86	84	108	367	
02:00		94	91	96	108	389	
03:00		102	106	106	99	413	
04:00		118	112	136	124	490	
05:00		146	156	133	100	535	
06:00		79	83	85	77	324	
07:00		57	62	60	55	234	
08:00		36	46	39	37	158	
09:00		39	36	30	37	142	
10:00		23	27	32	22	104	
11:00		34	45	13	11	103	
Day Total						5162	

TRIDENT Engineering, LLC

10232 NW 47 Street, Weston, FL 33351
954.815.3265

SR A1A (S. Roosevelt Blvd.) south Ocean Walk NB Volumes (2/8 - 2/10/2017)

Start Time	Fri 10-Feb-17	<-----Quarter		Hour----->		Hour Total	
		1st	2nd	3rd	4th		
12:00 AM		10	10	7	9	36	
01:00		7	3	5	3	18	
02:00		2	1	4	3	10	
03:00		2	2	5	3	12	
04:00		2	2	4	4	12	
05:00		5	4	8	12	29	
06:00		13	13	17	25	68	
07:00		27	70	49	60	206	
08:00		59	44	70	56	229	
09:00		68	46	81	69	264	
10:00		96	73	74	86	329	
11:00		94	93	102	108	397	
12:00 PM		93	77	87	105	362	
01:00		93	104	98	107	402	
02:00		100	94	108	128	430	
03:00		105	109	111	116	441	
04:00		112	146	116	117	491	
05:00		142	156	118	80	496	
06:00		87	96	105	70	358	
07:00		70	60	60	74	264	
08:00		69	50	45	39	203	
09:00		48	42	35	28	153	
10:00		35	38	47	52	172	
11:00		37	35	19	17	108	
Day Total						5490	
Total						15801	
ADT		ADT 4,410	AADT 4,410				

APPENDIX D

**FDOT Peak Season
Conversion Factor Report**

2015 PEAK SEASON FACTOR CATEGORY REPORT - REPORT TYPE: ALL
 CATEGORY: 9000 MONROE COUNTYWIDE

MOCF: 0.94
 PSCF

WEEK	DATES	SF	PSCF
1	01/01/2015 - 01/03/2015	1.00	1.06
2	01/04/2015 - 01/10/2015	1.00	1.06
3	01/11/2015 - 01/17/2015	0.99	1.05
4	01/18/2015 - 01/24/2015	0.98	1.04
* 5	01/25/2015 - 01/31/2015	0.96	1.02
* 6	02/01/2015 - 02/07/2015	0.95	1.01
* 7	02/08/2015 - 02/14/2015	0.94	1.00
* 8	02/15/2015 - 02/21/2015	0.93	0.99
* 9	02/22/2015 - 02/28/2015	0.92	0.98
*10	03/01/2015 - 03/07/2015	0.91	0.97
*11	03/08/2015 - 03/14/2015	0.90	0.96
*12	03/15/2015 - 03/21/2015	0.92	0.98
*13	03/22/2015 - 03/28/2015	0.93	0.99
*14	03/29/2015 - 04/04/2015	0.95	1.01
*15	04/05/2015 - 04/11/2015	0.97	1.03
*16	04/12/2015 - 04/18/2015	0.97	1.03
*17	04/19/2015 - 04/25/2015	0.98	1.04
18	04/26/2015 - 05/02/2015	0.99	1.05
19	05/03/2015 - 05/09/2015	1.00	1.06
20	05/10/2015 - 05/16/2015	1.00	1.06
21	05/17/2015 - 05/23/2015	1.01	1.07
22	05/24/2015 - 05/30/2015	1.01	1.07
23	05/31/2015 - 06/06/2015	1.01	1.07
24	06/07/2015 - 06/13/2015	1.01	1.07
25	06/14/2015 - 06/20/2015	1.00	1.06
26	06/21/2015 - 06/27/2015	0.99	1.05
27	06/28/2015 - 07/04/2015	0.98	1.04
28	07/05/2015 - 07/11/2015	0.97	1.03
29	07/12/2015 - 07/18/2015	0.98	1.04
30	07/19/2015 - 07/25/2015	0.99	1.05
31	07/26/2015 - 08/01/2015	1.00	1.06
32	08/02/2015 - 08/08/2015	1.01	1.07
33	08/09/2015 - 08/15/2015	1.02	1.09
34	08/16/2015 - 08/22/2015	1.04	1.11
35	08/23/2015 - 08/29/2015	1.07	1.14
36	08/30/2015 - 09/05/2015	1.10	1.17
37	09/06/2015 - 09/12/2015	1.12	1.19
38	09/13/2015 - 09/19/2015	1.12	1.19
39	09/20/2015 - 09/26/2015	1.11	1.18
40	09/27/2015 - 10/03/2015	1.11	1.18
41	10/04/2015 - 10/10/2015	1.10	1.17
42	10/11/2015 - 10/17/2015	1.09	1.16
43	10/18/2015 - 10/24/2015	1.08	1.15
44	10/25/2015 - 10/31/2015	1.07	1.14
45	11/01/2015 - 11/07/2015	1.06	1.13
46	11/08/2015 - 11/14/2015	1.05	1.12
47	11/15/2015 - 11/21/2015	1.04	1.11
48	11/22/2015 - 11/28/2015	1.03	1.10
49	11/29/2015 - 12/05/2015	1.01	1.07
50	12/06/2015 - 12/12/2015	1.00	1.06
51	12/13/2015 - 12/19/2015	1.00	1.06
52	12/20/2015 - 12/26/2015	1.00	1.06
53	12/27/2015 - 12/31/2015	0.99	1.05

* PEAK SEASON

03-MAR-2016 11:19:37

830UPD

6_9000_PKSEASON.TXT

APPENDIX E

Future Traffic Volumes Spreadsheets

FUTURE TURNING MOVEMENT VOLUME ANALYSIS

**S. Roosevelt Blvd and Seaside Drive
AM Peak Hour**

Description	S. Roosevelt Blvd Northbound			S. Roosevelt Blvd Southbound			Seaside Dr Eastbound			Westbound		
	Left	Through	Right	Left	Through	Right	Left	Through	Right	Left	Through	Right
Existing Traffic (2/8/2017)	23	196	0	0	365	67	189	0	126	0	0	0
Season Adjustment Factor	1.00	1.00	1.00	1.00	1.00	1.00	1.00	1.00	1.00	1.00	1.00	1.00
2017 Peak Season Traffic	23	196	0	0	365	67	189	0	126	0	0	0
Annual Growth Rate	1.00%	1.00%	1.00%	1.00%	1.00%	1.00%	1.00%	1.00%	1.00%	1.00%	1.00%	1.00%
2019 Background Traffic	23	200	0	0	372	68	193	0	129	0	0	0
New Project Trips	3					5	19		12			
2019 Total Traffic	26	200	0	0	372	73	212	0	141	0	0	0

FUTURE TURNING MOVEMENT VOLUME ANALYSIS

**S. Roosevelt Blvd and Seaside Drive
PM Peak Hour**

Description	S. Roosevelt Blvd Northbound			S. Roosevelt Blvd Southbound			Seaside Dr Eastbound			Westbound		
	Left	Through	Right	Left	Through	Right	Left	Through	Right	Left	Through	Right
Existing Traffic (2/8/2017)	78	454	0	0	289	177	123	0	54	0	0	0
Season Adjustment Factor	1.00	1.00	1.00	1.00	1.00	1.00	1.00	1.00	1.00	1.00	1.00	1.00
2017 Peak Season Traffic	78	454	0	0	289	177	123	0	54	0	0	0
Annual Growth Rate	1.0%	1.0%	1.0%	1.0%	1.0%	1.0%	1.0%	1.0%	1.0%	1.0%	1.0%	1.0%
2019 Background Traffic	80	463	0	0	295	181	125	0	55	0	0	0
New Project Trips	12					17	9		6			
2019 Total Traffic	92	463	0	0	295	198	134	0	61	0	0	0

FUTURE TURNING MOVEMENT VOLUME ANALYSIS

Seaside Drive and Roundabout AM Peak Hour

Description	Ocean Walk Northbound			Ocean Walk Southbound			Roundabout Eastbound			Roundabout Westbound		
	Left	Through	Right	Left	Through	Right	Left	Through	Right	Left	Through	Right
Existing Traffic (2/8/2017)	1	8	157	49	2	1	1	65	2	52	24	4
Season Adjustment Factor	1.00	1.00	1.00	1.00	1.00	1.00	1.00	1.00	1.00	1.00	1.00	1.00
2017 Peak Season Traffic	1	8	157	49	2	1	1	65	2	52	24	4
Annual Growth Rate	1.00%	1.00%	1.00%	1.00%	1.00%	1.00%	1.00%	1.00%	1.00%	1.00%	1.00%	1.00%
2019 Background Traffic	1	8	160	50	2	1	1	66	2	53	24	4
New Project Trips			31							8		
2019 Total Traffic	1	8	191	50	2	1	1	66	2	61	24	4

FUTURE TURNING MOVEMENT VOLUME ANALYSIS

Seaside Drive and Roundabout PM Peak Hour

Description	Ocean Walk Northbound			Ocean Walk Southbound			Roundabout Eastbound			Roundabout Westbound		
	Left	Through	Right	Left	Through	Right	Left	Through	Right	Left	Through	Right
Existing Traffic (2/8/2017)	2	3	98	33	2	2	1	46	2	161	59	5
Season Adjustment Factor	1.00	1.00	1.00	1.00	1.00	1.00	1.00	1.00	1.00	1.00	1.00	1.00
2017 Peak Season Traffic	2	3	98	33	2	2	1	46	2	161	59	5
Annual Growth Rate	1.00%	1.00%	1.00%	1.00%	1.00%	1.00%	1.00%	1.00%	1.00%	1.00%	1.00%	1.00%
2019 Background Traffic	2	3	100	34	2	2	1	47	2	164	60	5
New Project Trips			15							29		
2019 Total Traffic	2	3	115	34	2	2	1	47	2	193	60	5

FUTURE LINK VOLUME ANALYSIS

AM Peak Hour

Description	S. Roosevelt Blvd Overseas Hwy to Seaside Dr Through	S. Roosevelt Blvd Seaside Dr to Bertha St Through	Through	Through
Existing Traffic (2/9-10/2017)	1,050	847	0	0
Season Adjustment Factor	1.00	1.00	1.00	1.00
2017 Peak Season Traffic	1,050	847	0	0
Annual Growth Rate	1.0%	1.0%	1.0%	1.0%
2019 Background Traffic	1,071	864	0	0
New Project Trips	24	15		
2019 Total Traffic	1,095	879	0	0

FUTURE LINK VOLUME ANALYSIS

PM Peak Hour

Description	S. Roosevelt Blvd Overseas Hwy to Seaside Dr Through	S. Roosevelt Blvd Seaside Dr to Bertha St Through	Through	Through
Existing Traffic (2/9-10/2017)	1,111	930	0	0
Season Adjustment Factor	1.00	1.00	1.00	1.00
2017 Peak Season Traffic	1,111	930	0	0
Annual Growth Rate	1.0%	1.0%	1.0%	1.0%
2019 Background Traffic	1,133	949	0	0
New Project Trips	26	18		
2019 Total Traffic	1,159	967	0	0

APPENDIX F
SYNCHRO Output

Existing (2017) SYNCHRO Output

Lanes, Volumes, Timings
 101: S. Roosevelt Blvd & Seaside Drive



Lane Group	EBL	EBR	NBL	NBT	SBT	SBR
Lane Configurations						
Traffic Volume (vph)	189	126	23	196	365	67
Future Volume (vph)	189	126	23	196	365	67
Ideal Flow (vphpl)	1900	1900	1900	1900	1900	1900
Storage Length (ft)	0	0	200			0
Storage Lanes	1	1	1			0
Taper Length (ft)	25		25			
Lane Util. Factor	1.00	1.00	1.00	0.95	0.95	0.95
Frt		0.850			0.977	
Flt Protected	0.950		0.950			
Satd. Flow (prot)	1770	1583	1770	3539	3458	0
Flt Permitted	0.950		0.950			
Satd. Flow (perm)	1770	1583	1770	3539	3458	0
Link Speed (mph)	30			30	30	
Link Distance (ft)	237			480	451	
Travel Time (s)	5.4			10.9	10.3	
Peak Hour Factor	0.88	0.88	0.88	0.88	0.88	0.88
Adj. Flow (vph)	215	143	26	223	415	76
Shared Lane Traffic (%)						
Lane Group Flow (vph)	215	143	26	223	491	0
Enter Blocked Intersection	No	No	No	No	No	No
Lane Alignment	Left	Right	Left	Left	Left	Right
Median Width(ft)	12			12	12	
Link Offset(ft)	0			0	0	
Crosswalk Width(ft)	16			16	16	
Two way Left Turn Lane						
Headway Factor	1.00	1.00	1.00	1.00	1.00	1.00
Turning Speed (mph)	15	9	15			9
Sign Control	Stop			Free	Free	

Intersection Summary

Area Type:	Other
Control Type:	Unsignalized
Intersection Capacity Utilization	36.0%
ICU Level of Service	A
Analysis Period (min)	15

HCM 2010 TWSC
 101: S. Roosevelt Blvd & Seaside Drive

Intersection

Int Delay, s/veh 6.1

















Movement	EBL	EBR	NBL	NBT	SBT	SBR
Lane Configurations	↘	↗	↘	↗	↗	↘
Traffic Vol, veh/h	189	126	23	196	365	67
Future Vol, veh/h	189	126	23	196	365	67
Conflicting Peds, #/hr	0	0	0	0	0	0
Sign Control	Stop	Stop	Free	Free	Free	Free
RT Channelized	-	None	-	None	-	None
Storage Length	0	0	200	-	-	-
Veh in Median Storage, #	0	-	-	0	0	-
Grade, %	0	-	-	0	0	-
Peak Hour Factor	88	88	88	88	88	88
Heavy Vehicles, %	2	2	2	2	2	2
Mvmt Flow	215	143	26	223	415	76

Major/Minor	Minor2	Major1		Major2
Conflicting Flow All	617	245	491	0
Stage 1	453	-	-	-
Stage 2	164	-	-	-
Critical Hdwy	6.84	6.94	4.14	-
Critical Hdwy Stg 1	5.84	-	-	-
Critical Hdwy Stg 2	5.84	-	-	-
Follow-up Hdwy	3.52	3.32	2.22	-
Pot Cap-1 Maneuver	422	755	1069	-
Stage 1	607	-	-	-
Stage 2	848	-	-	-
Platoon blocked, %				-
Mov Cap-1 Maneuver	412	755	1069	-
Mov Cap-2 Maneuver	412	-	-	-
Stage 1	607	-	-	-
Stage 2	827	-	-	-

Approach	EB	NB	SB
HCM Control Delay, s	18.1	0.9	0
HCM LOS	C		

Minor Lane/Major Mvmt	NBL	NBT	EBLn1	EBLn2	SBT	SBR
Capacity (veh/h)	1069	-	412	755	-	-
HCM Lane V/C Ratio	0.024	-	0.521	0.19	-	-
HCM Control Delay (s)	8.5	-	22.9	10.9	-	-
HCM Lane LOS	A	-	C	B	-	-
HCM 95th %tile Q(veh)	0.1	-	2.9	0.7	-	-

Lanes, Volumes, Timings
 102: N Driveway/S Driveway & Seaside Drive

												
Lane Group	EBL	EBT	EBR	WBL	WBT	WBR	NBL	NBT	NBR	SBL	SBT	SBR
Lane Configurations												
Traffic Volume (vph)	1	65	2	52	24	4	1	8	157	49	2	1
Future Volume (vph)	1	65	2	52	24	4	1	8	157	49	2	1
Ideal Flow (vphpl)	1900	1900	1900	1900	1900	1900	1900	1900	1900	1900	1900	1900
Lane Util. Factor	1.00	1.00	1.00	1.00	1.00	1.00	1.00	1.00	1.00	1.00	1.00	1.00
Frt		0.996			0.994			0.872			0.998	
Flt Protected		0.999			0.968						0.955	
Satd. Flow (prot)	0	1853	0	0	1792	0	0	1624	0	0	1775	0
Flt Permitted		0.999			0.968						0.955	
Satd. Flow (perm)	0	1853	0	0	1792	0	0	1624	0	0	1775	0
Link Speed (mph)		30			30			30			30	
Link Distance (ft)		143			161			171			124	
Travel Time (s)		3.3			3.7			3.9			2.8	
Peak Hour Factor	0.95	0.95	0.95	0.95	0.95	0.95	0.95	0.95	0.95	0.95	0.95	0.95
Adj. Flow (vph)	1	68	2	55	25	4	1	8	165	52	2	1
Shared Lane Traffic (%)												
Lane Group Flow (vph)	0	71	0	0	84	0	0	174	0	0	55	0
Enter Blocked Intersection	No	No	No	No	No	No	No	No	No	No	No	No
Lane Alignment	Left	Left	Right	Left	Left	Right	Left	Left	Right	Left	Left	Right
Median Width(ft)		0			0			0			0	
Link Offset(ft)		0			0			0			0	
Crosswalk Width(ft)		16			16			16			16	
Two way Left Turn Lane												
Headway Factor	1.00	1.00	1.00	1.00	1.00	1.00	1.00	1.00	1.00	1.00	1.00	1.00
Turning Speed (mph)	15		9	15		9	15		9	15		9
Sign Control		Yield			Yield			Yield			Yield	

Intersection Summary

Area Type:	Other
Control Type:	Roundabout
Intersection Capacity Utilization	34.6%
Analysis Period (min)	15
	ICU Level of Service A

HCM 2010 Roundabout
 102: N Driveway/S Driveway & Seaside Drive

Intersection				
Intersection Delay, s/veh	4.6			
Intersection LOS	A			
Approach	EB	WB	NB	SB
Entry Lanes	1	1	1	1
Conflicting Circle Lanes	1	1	1	1
Adj Approach Flow, veh/h	71	84	174	55
Demand Flow Rate, veh/h	72	86	177	56
Vehicles Circulating, veh/h	111	10	123	82
Vehicles Exiting, veh/h	27	290	60	13
Follow-Up Headway, s	3.186	3.186	3.186	3.186
Ped Vol Crossing Leg, #/h	0	0	0	0
Ped Cap Adj	1.000	1.000	1.000	1.000
Approach Delay, s/veh	4.3	3.9	5.3	4.0
Approach LOS	A	A	A	A
Lane	Left	Left	Left	Left
Designated Moves	LTR	LTR	LTR	LTR
Assumed Moves	LTR	LTR	LTR	LTR
RT Channelized				
Lane Util	1.000	1.000	1.000	1.000
Critical Headway, s	5.193	5.193	5.193	5.193
Entry Flow, veh/h	72	86	177	56
Cap Entry Lane, veh/h	1011	1119	999	1041
Entry HV Adj Factor	0.981	0.982	0.982	0.981
Flow Entry, veh/h	71	84	174	55
Cap Entry, veh/h	992	1099	981	1022
V/C Ratio	0.071	0.077	0.177	0.054
Control Delay, s/veh	4.3	3.9	5.3	4.0
LOS	A	A	A	A
95th %tile Queue, veh	0	0	1	0

Lanes, Volumes, Timings
 101: S. Roosevelt Blvd & Seaside Drive

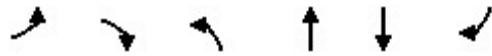

Lane Group	EBL	EBR	NBL	NBT	SBT	SBR
Lane Configurations						
Traffic Volume (vph)	123	54	78	454	289	177
Future Volume (vph)	123	54	78	454	289	177
Ideal Flow (vphpl)	1900	1900	1900	1900	1900	1900
Storage Length (ft)	0	0	200			0
Storage Lanes	1	1	1			0
Taper Length (ft)	25		25			
Lane Util. Factor	1.00	1.00	1.00	0.95	0.95	0.95
Frt		0.850			0.943	
Flt Protected	0.950		0.950			
Satd. Flow (prot)	1770	1583	1770	3539	3337	0
Flt Permitted	0.950		0.950			
Satd. Flow (perm)	1770	1583	1770	3539	3337	0
Link Speed (mph)	30			30	30	
Link Distance (ft)	237			480	451	
Travel Time (s)	5.4			10.9	10.3	
Peak Hour Factor	0.91	0.91	0.91	0.91	0.91	0.91
Adj. Flow (vph)	135	59	86	499	318	195
Shared Lane Traffic (%)						
Lane Group Flow (vph)	135	59	86	499	513	0
Enter Blocked Intersection	No	No	No	No	No	No
Lane Alignment	Left	Right	Left	Left	Left	Right
Median Width(ft)	12			12	12	
Link Offset(ft)	0			0	0	
Crosswalk Width(ft)	16			16	16	
Two way Left Turn Lane						
Headway Factor	1.00	1.00	1.00	1.00	1.00	1.00
Turning Speed (mph)	15	9	15			9
Sign Control	Stop			Free	Free	

Intersection Summary

Area Type:	Other
Control Type:	Unsignalized
Intersection Capacity Utilization	34.8%
ICU Level of Service	A
Analysis Period (min)	15

HCM 2010 TWSC
 101: S. Roosevelt Blvd & Seaside Drive

Intersection

















Int Delay, s/veh	4.1					
Movement	EBL	EBR	NBL	NBT	SBT	SBR
Lane Configurations						
Traffic Vol, veh/h	123	54	78	454	289	177
Future Vol, veh/h	123	54	78	454	289	177
Conflicting Peds, #/hr	0	0	0	0	0	0
Sign Control	Stop	Stop	Free	Free	Free	Free
RT Channelized	-	None	-	None	-	None
Storage Length	0	0	200	-	-	-
Veh in Median Storage, #	0	-	-	0	0	-
Grade, %	0	-	-	0	0	-
Peak Hour Factor	91	91	91	91	91	91
Heavy Vehicles, %	2	2	2	2	2	2
Mvmt Flow	135	59	86	499	318	195

Major/Minor	Minor2		Major1		Major2	
Conflicting Flow All	836	256	512	0	-	0
Stage 1	415	-	-	-	-	-
Stage 2	421	-	-	-	-	-
Critical Hdwy	6.84	6.94	4.14	-	-	-
Critical Hdwy Stg 1	5.84	-	-	-	-	-
Critical Hdwy Stg 2	5.84	-	-	-	-	-
Follow-up Hdwy	3.52	3.32	2.22	-	-	-
Pot Cap-1 Maneuver	306	743	1050	-	-	-
Stage 1	635	-	-	-	-	-
Stage 2	630	-	-	-	-	-
Platoon blocked, %				-	-	-
Mov Cap-1 Maneuver	281	743	1050	-	-	-
Mov Cap-2 Maneuver	281	-	-	-	-	-
Stage 1	635	-	-	-	-	-
Stage 2	578	-	-	-	-	-

Approach	EB	NB	SB
HCM Control Delay, s	23.4	1.3	0
HCM LOS	C		

Minor Lane/Major Mvmt	NBL	NBT	EBLn1	EBLn2	SBT	SBR
Capacity (veh/h)	1050	-	281	743	-	-
HCM Lane V/C Ratio	0.082	-	0.481	0.08	-	-
HCM Control Delay (s)	8.7	-	29.1	10.3	-	-
HCM Lane LOS	A	-	D	B	-	-
HCM 95th %tile Q(veh)	0.3	-	2.5	0.3	-	-

Lanes, Volumes, Timings
 102: N Driveway/S Driveway & Seaside Drive

												
Lane Group	EBL	EBT	EBR	WBL	WBT	WBR	NBL	NBT	NBR	SBL	SBT	SBR
Lane Configurations												
Traffic Volume (vph)	1	46	2	161	59	5	2	3	98	33	2	2
Future Volume (vph)	1	46	2	161	59	5	2	3	98	33	2	2
Ideal Flow (vphpl)	1900	1900	1900	1900	1900	1900	1900	1900	1900	1900	1900	1900
Lane Util. Factor	1.00	1.00	1.00	1.00	1.00	1.00	1.00	1.00	1.00	1.00	1.00	1.00
Frt		0.995			0.997			0.871			0.993	
Flt Protected		0.999			0.965			0.999			0.957	
Satd. Flow (prot)	0	1852	0	0	1792	0	0	1621	0	0	1770	0
Flt Permitted		0.999			0.965			0.999			0.957	
Satd. Flow (perm)	0	1852	0	0	1792	0	0	1621	0	0	1770	0
Link Speed (mph)		30			30			30			30	
Link Distance (ft)		143			161			171			124	
Travel Time (s)		3.3			3.7			3.9			2.8	
Peak Hour Factor	0.94	0.94	0.94	0.94	0.94	0.94	0.94	0.94	0.94	0.94	0.94	0.94
Adj. Flow (vph)	1	49	2	171	63	5	2	3	104	35	2	2
Shared Lane Traffic (%)												
Lane Group Flow (vph)	0	52	0	0	239	0	0	109	0	0	39	0
Enter Blocked Intersection	No	No	No	No	No	No	No	No	No	No	No	No
Lane Alignment	Left	Left	Right	Left	Left	Right	Left	Left	Right	Left	Left	Right
Median Width(ft)		0			0			0			0	
Link Offset(ft)		0			0			0			0	
Crosswalk Width(ft)		16			16			16			16	
Two way Left Turn Lane												
Headway Factor	1.00	1.00	1.00	1.00	1.00	1.00	1.00	1.00	1.00	1.00	1.00	1.00
Turning Speed (mph)	15		9	15		9	15		9	15		9
Sign Control		Yield			Yield			Yield			Yield	

Intersection Summary

Area Type:	Other
Control Type:	Roundabout
Intersection Capacity Utilization	34.4%
Analysis Period (min)	15
	ICU Level of Service A

HCM 2010 Roundabout
 102: N Driveway/S Driveway & Seaside Drive

Intersection				
Intersection Delay, s/veh	4.9			
Intersection LOS	A			
Approach	EB	WB	NB	SB
Entry Lanes	1	1	1	1
Conflicting Circle Lanes	1	1	1	1
Adj Approach Flow, veh/h	52	239	109	39
Demand Flow Rate, veh/h	53	243	111	40
Vehicles Circulating, veh/h	212	6	87	240
Vehicles Exiting, veh/h	68	192	178	9
Follow-Up Headway, s	3.186	3.186	3.186	3.186
Ped Vol Crossing Leg, #/h	0	0	0	0
Ped Cap Adj	1.000	1.000	1.000	1.000
Approach Delay, s/veh	4.5	5.2	4.5	4.6
Approach LOS	A	A	A	A
Lane	Left	Left	Left	Left
Designated Moves	LTR	LTR	LTR	LTR
Assumed Moves	LTR	LTR	LTR	LTR
RT Channelized				
Lane Util	1.000	1.000	1.000	1.000
Critical Headway, s	5.193	5.193	5.193	5.193
Entry Flow, veh/h	53	243	111	40
Cap Entry Lane, veh/h	914	1123	1036	889
Entry HV Adj Factor	0.982	0.982	0.981	0.974
Flow Entry, veh/h	52	239	109	39
Cap Entry, veh/h	897	1104	1017	866
V/C Ratio	0.058	0.216	0.107	0.045
Control Delay, s/veh	4.5	5.2	4.5	4.6
LOS	A	A	A	A
95th %tile Queue, veh	0	1	0	0

Future (2019) Background SYNCHRO Output

Lanes, Volumes, Timings
 101: S. Roosevelt Blvd & Seaside Drive



Lane Group	EBL	EBR	NBL	NBT	SBT	SBR
Lane Configurations						
Traffic Volume (vph)	193	129	23	200	372	68
Future Volume (vph)	193	129	23	200	372	68
Ideal Flow (vphpl)	1900	1900	1900	1900	1900	1900
Storage Length (ft)	0	0	200			0
Storage Lanes	1	1	1			0
Taper Length (ft)	25		25			
Lane Util. Factor	1.00	1.00	1.00	0.95	0.95	0.95
Frt		0.850			0.977	
Flt Protected	0.950		0.950			
Satd. Flow (prot)	1770	1583	1770	3539	3458	0
Flt Permitted	0.950		0.950			
Satd. Flow (perm)	1770	1583	1770	3539	3458	0
Link Speed (mph)	30			30	30	
Link Distance (ft)	237			480	451	
Travel Time (s)	5.4			10.9	10.3	
Peak Hour Factor	0.88	0.88	0.88	0.88	0.88	0.88
Adj. Flow (vph)	219	147	26	227	423	77
Shared Lane Traffic (%)						
Lane Group Flow (vph)	219	147	26	227	500	0
Enter Blocked Intersection	No	No	No	No	No	No
Lane Alignment	Left	Right	Left	Left	Left	Right
Median Width(ft)	12			12	12	
Link Offset(ft)	0			0	0	
Crosswalk Width(ft)	16			16	16	
Two way Left Turn Lane						
Headway Factor	1.00	1.00	1.00	1.00	1.00	1.00
Turning Speed (mph)	15	9	15			9
Sign Control	Stop			Free	Free	

Intersection Summary

Area Type:	Other
Control Type:	Unsignalized
Intersection Capacity Utilization	36.5%
	ICU Level of Service A
Analysis Period (min)	15

HCM 2010 TWSC
 101: S. Roosevelt Blvd & Seaside Drive

Intersection

Int Delay, s/veh 6.3

















Movement	EBL	EBR	NBL	NBT	SBT	SBR
Lane Configurations	↖	↗	↖	↗	↗	↖
Traffic Vol, veh/h	193	129	23	200	372	68
Future Vol, veh/h	193	129	23	200	372	68
Conflicting Peds, #/hr	0	0	0	0	0	0
Sign Control	Stop	Stop	Free	Free	Free	Free
RT Channelized	-	None	-	None	-	None
Storage Length	0	0	200	-	-	-
Veh in Median Storage, #	0	-	-	0	0	-
Grade, %	0	-	-	0	0	-
Peak Hour Factor	88	88	88	88	88	88
Heavy Vehicles, %	2	2	2	2	2	2
Mvmt Flow	219	147	26	227	423	77

Major/Minor	Minor2	Major1		Major2
Conflicting Flow All	627	250	500	0
Stage 1	461	-	-	-
Stage 2	166	-	-	-
Critical Hdwy	6.84	6.94	4.14	-
Critical Hdwy Stg 1	5.84	-	-	-
Critical Hdwy Stg 2	5.84	-	-	-
Follow-up Hdwy	3.52	3.32	2.22	-
Pot Cap-1 Maneuver	416	750	1060	-
Stage 1	601	-	-	-
Stage 2	846	-	-	-
Platoon blocked, %				-
Mov Cap-1 Maneuver	406	750	1060	-
Mov Cap-2 Maneuver	406	-	-	-
Stage 1	601	-	-	-
Stage 2	825	-	-	-

Approach	EB	NB	SB
HCM Control Delay, s	18.7	0.9	0
HCM LOS	C		

Minor Lane/Major Mvmt	NBL	NBT	EBLn1	EBLn2	SBT	SBR
Capacity (veh/h)	1060	-	406	750	-	-
HCM Lane V/C Ratio	0.025	-	0.54	0.195	-	-
HCM Control Delay (s)	8.5	-	23.8	11	-	-
HCM Lane LOS	A	-	C	B	-	-
HCM 95th %tile Q(veh)	0.1	-	3.1	0.7	-	-

Lanes, Volumes, Timings
 102: N Driveway/S Driveway & Seaside Drive

												
Lane Group	EBL	EBT	EBR	WBL	WBT	WBR	NBL	NBT	NBR	SBL	SBT	SBR
Lane Configurations												
Traffic Volume (vph)	1	66	2	53	24	4	1	8	160	50	2	1
Future Volume (vph)	1	66	2	53	24	4	1	8	160	50	2	1
Ideal Flow (vphpl)	1900	1900	1900	1900	1900	1900	1900	1900	1900	1900	1900	1900
Lane Util. Factor	1.00	1.00	1.00	1.00	1.00	1.00	1.00	1.00	1.00	1.00	1.00	1.00
Frt		0.996			0.994			0.872			0.998	
Flt Protected		0.999			0.968						0.955	
Satd. Flow (prot)	0	1853	0	0	1792	0	0	1624	0	0	1775	0
Flt Permitted		0.999			0.968						0.955	
Satd. Flow (perm)	0	1853	0	0	1792	0	0	1624	0	0	1775	0
Link Speed (mph)		30			30			30			30	
Link Distance (ft)		143			161			171			124	
Travel Time (s)		3.3			3.7			3.9			2.8	
Peak Hour Factor	0.95	0.95	0.95	0.95	0.95	0.95	0.95	0.95	0.95	0.95	0.95	0.95
Adj. Flow (vph)	1	69	2	56	25	4	1	8	168	53	2	1
Shared Lane Traffic (%)												
Lane Group Flow (vph)	0	72	0	0	85	0	0	177	0	0	56	0
Enter Blocked Intersection	No	No	No	No	No	No	No	No	No	No	No	No
Lane Alignment	Left	Left	Right	Left	Left	Right	Left	Left	Right	Left	Left	Right
Median Width(ft)		0			0			0			0	
Link Offset(ft)		0			0			0			0	
Crosswalk Width(ft)		16			16			16			16	
Two way Left Turn Lane												
Headway Factor	1.00	1.00	1.00	1.00	1.00	1.00	1.00	1.00	1.00	1.00	1.00	1.00
Turning Speed (mph)	15		9	15		9	15		9	15		9
Sign Control		Yield			Yield			Yield			Yield	

Intersection Summary

Area Type:	Other
Control Type:	Roundabout
Intersection Capacity Utilization	34.8%
Analysis Period (min)	15
	ICU Level of Service A

HCM 2010 Roundabout
 102: N Driveway/S Driveway & Seaside Drive

Intersection				
Intersection Delay, s/veh	4.7			
Intersection LOS	A			
Approach	EB	WB	NB	SB
Entry Lanes	1	1	1	1
Conflicting Circle Lanes	1	1	1	1
Adj Approach Flow, veh/h	72	85	177	56
Demand Flow Rate, veh/h	73	87	180	57
Vehicles Circulating, veh/h	113	10	125	83
Vehicles Exiting, veh/h	27	295	61	13
Follow-Up Headway, s	3.186	3.186	3.186	3.186
Ped Vol Crossing Leg, #/h	0	0	0	0
Ped Cap Adj	1.000	1.000	1.000	1.000
Approach Delay, s/veh	4.3	3.9	5.4	4.0
Approach LOS	A	A	A	A
Lane	Left	Left	Left	Left
Designated Moves	LTR	LTR	LTR	LTR
Assumed Moves	LTR	LTR	LTR	LTR
RT Channelized				
Lane Util	1.000	1.000	1.000	1.000
Critical Headway, s	5.193	5.193	5.193	5.193
Entry Flow, veh/h	73	87	180	57
Cap Entry Lane, veh/h	1009	1119	997	1040
Entry HV Adj Factor	0.981	0.983	0.982	0.982
Flow Entry, veh/h	72	85	177	56
Cap Entry, veh/h	990	1099	980	1021
V/C Ratio	0.072	0.078	0.181	0.055
Control Delay, s/veh	4.3	3.9	5.4	4.0
LOS	A	A	A	A
95th %tile Queue, veh	0	0	1	0

Lanes, Volumes, Timings
 101: S. Roosevelt Blvd & Seaside Drive



Lane Group	EBL	EBR	NBL	NBT	SBT	SBR
Lane Configurations						
Traffic Volume (vph)	125	55	80	463	295	181
Future Volume (vph)	125	55	80	463	295	181
Ideal Flow (vphpl)	1900	1900	1900	1900	1900	1900
Storage Length (ft)	0	0	200			0
Storage Lanes	1	1	1			0
Taper Length (ft)	25		25			
Lane Util. Factor	1.00	1.00	1.00	0.95	0.95	0.95
Frt		0.850			0.943	
Flt Protected	0.950		0.950			
Satd. Flow (prot)	1770	1583	1770	3539	3337	0
Flt Permitted	0.950		0.950			
Satd. Flow (perm)	1770	1583	1770	3539	3337	0
Link Speed (mph)	30			30	30	
Link Distance (ft)	237			480	451	
Travel Time (s)	5.4			10.9	10.3	
Peak Hour Factor	0.91	0.91	0.91	0.91	0.91	0.91
Adj. Flow (vph)	137	60	88	509	324	199
Shared Lane Traffic (%)						
Lane Group Flow (vph)	137	60	88	509	523	0
Enter Blocked Intersection	No	No	No	No	No	No
Lane Alignment	Left	Right	Left	Left	Left	Right
Median Width(ft)	12			12	12	
Link Offset(ft)	0			0	0	
Crosswalk Width(ft)	16			16	16	
Two way Left Turn Lane						
Headway Factor	1.00	1.00	1.00	1.00	1.00	1.00
Turning Speed (mph)	15	9	15			9
Sign Control	Stop			Free	Free	

Intersection Summary

Area Type:	Other
Control Type:	Unsignalized
Intersection Capacity Utilization	35.3%
ICU Level of Service	A
Analysis Period (min)	15

HCM 2010 TWSC
 101: S. Roosevelt Blvd & Seaside Drive

Intersection

Int Delay, s/veh 4.3

Movement	EBL	EBR	NBL	NBT	SBT	SBR
Lane Configurations	↖	↗	↖	↗	↕	↕
Traffic Vol, veh/h	125	55	80	463	295	181
Future Vol, veh/h	125	55	80	463	295	181
Conflicting Peds, #/hr	0	0	0	0	0	0
Sign Control	Stop	Stop	Free	Free	Free	Free
RT Channelized	-	None	-	None	-	None
Storage Length	0	0	200	-	-	-
Veh in Median Storage, #	0	-	-	0	0	-
Grade, %	0	-	-	0	0	-
Peak Hour Factor	91	91	91	91	91	91
Heavy Vehicles, %	2	2	2	2	2	2
Mvmt Flow	137	60	88	509	324	199

Major/Minor	Minor2	Major1		Major2	
Conflicting Flow All	854	262	523	0	0
Stage 1	424	-	-	-	-
Stage 2	430	-	-	-	-
Critical Hdwy	6.84	6.94	4.14	-	-
Critical Hdwy Stg 1	5.84	-	-	-	-
Critical Hdwy Stg 2	5.84	-	-	-	-
Follow-up Hdwy	3.52	3.32	2.22	-	-
Pot Cap-1 Maneuver	298	737	1040	-	-
Stage 1	628	-	-	-	-
Stage 2	624	-	-	-	-
Platoon blocked, %				-	-
Mov Cap-1 Maneuver	273	737	1040	-	-
Mov Cap-2 Maneuver	273	-	-	-	-
Stage 1	628	-	-	-	-
Stage 2	571	-	-	-	-

Approach	EB	NB	SB
HCM Control Delay, s	24.5	1.3	0
HCM LOS	C		

Minor Lane/Major Mvmt	NBL	NBT	EBLn1	EBLn2	SBT	SBR
Capacity (veh/h)	1040	-	273	737	-	-
HCM Lane V/C Ratio	0.085	-	0.503	0.082	-	-
HCM Control Delay (s)	8.8	-	30.8	10.3	-	-
HCM Lane LOS	A	-	D	B	-	-
HCM 95th %tile Q(veh)	0.3	-	2.6	0.3	-	-

Lanes, Volumes, Timings
 102: N Driveway/S Driveway & Seaside Drive

Lane Group	EBL	EBT	EBR	WBL	WBT	WBR	NBL	NBT	NBR	SBL	SBT	SBR
Lane Configurations												
Traffic Volume (vph)	1	47	2	164	60	5	2	3	100	34	2	2
Future Volume (vph)	1	47	2	164	60	5	2	3	100	34	2	2
Ideal Flow (vphpl)	1900	1900	1900	1900	1900	1900	1900	1900	1900	1900	1900	1900
Lane Util. Factor	1.00	1.00	1.00	1.00	1.00	1.00	1.00	1.00	1.00	1.00	1.00	1.00
Frt		0.995			0.997			0.871			0.993	
Flt Protected		0.999			0.965			0.999			0.957	
Satd. Flow (prot)	0	1852	0	0	1792	0	0	1621	0	0	1770	0
Flt Permitted		0.999			0.965			0.999			0.957	
Satd. Flow (perm)	0	1852	0	0	1792	0	0	1621	0	0	1770	0
Link Speed (mph)		30			30			30			30	
Link Distance (ft)		143			161			171			124	
Travel Time (s)		3.3			3.7			3.9			2.8	
Peak Hour Factor	0.94	0.94	0.94	0.94	0.94	0.94	0.94	0.94	0.94	0.94	0.94	0.94
Adj. Flow (vph)	1	50	2	174	64	5	2	3	106	36	2	2
Shared Lane Traffic (%)												
Lane Group Flow (vph)	0	53	0	0	243	0	0	111	0	0	40	0
Enter Blocked Intersection	No	No	No	No	No	No	No	No	No	No	No	No
Lane Alignment	Left	Left	Right	Left	Left	Right	Left	Left	Right	Left	Left	Right
Median Width(ft)		0			0			0			0	
Link Offset(ft)		0			0			0			0	
Crosswalk Width(ft)		16			16			16			16	
Two way Left Turn Lane												
Headway Factor	1.00	1.00	1.00	1.00	1.00	1.00	1.00	1.00	1.00	1.00	1.00	1.00
Turning Speed (mph)	15		9	15		9	15		9	15		9
Sign Control		Yield			Yield			Yield			Yield	

Intersection Summary

Area Type: Other

Control Type: Roundabout

Intersection Capacity Utilization 34.7% ICU Level of Service A

Analysis Period (min) 15

HCM 2010 Roundabout
 102: N Driveway/S Driveway & Seaside Drive

Intersection				
Intersection Delay, s/veh	4.9			
Intersection LOS	A			
Approach	EB	WB	NB	SB
Entry Lanes	1	1	1	1
Conflicting Circle Lanes	1	1	1	1
Adj Approach Flow, veh/h	53	243	111	40
Demand Flow Rate, veh/h	54	247	113	41
Vehicles Circulating, veh/h	216	6	89	244
Vehicles Exiting, veh/h	69	196	181	9
Follow-Up Headway, s	3.186	3.186	3.186	3.186
Ped Vol Crossing Leg, #/h	0	0	0	0
Ped Cap Adj	1.000	1.000	1.000	1.000
Approach Delay, s/veh	4.6	5.3	4.5	4.6
Approach LOS	A	A	A	A
Lane	Left	Left	Left	Left
Designated Moves	LTR	LTR	LTR	LTR
Assumed Moves	LTR	LTR	LTR	LTR
RT Channelized				
Lane Util	1.000	1.000	1.000	1.000
Critical Headway, s	5.193	5.193	5.193	5.193
Entry Flow, veh/h	54	247	113	41
Cap Entry Lane, veh/h	910	1123	1034	885
Entry HV Adj Factor	0.981	0.983	0.982	0.975
Flow Entry, veh/h	53	243	111	40
Cap Entry, veh/h	894	1104	1015	863
V/C Ratio	0.059	0.220	0.109	0.046
Control Delay, s/veh	4.6	5.3	4.5	4.6
LOS	A	A	A	A
95th %tile Queue, veh	0	1	0	0

Future (2019) Total SYNCHRO Output

Lanes, Volumes, Timings
 101: S. Roosevelt Blvd & Seaside Drive

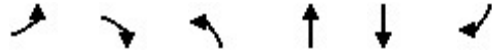

Lane Group	EBL	EBR	NBL	NBT	SBT	SBR
Lane Configurations						
Traffic Volume (vph)	212	141	26	200	372	73
Future Volume (vph)	212	141	26	200	372	73
Ideal Flow (vphpl)	1900	1900	1900	1900	1900	1900
Storage Length (ft)	0	0	200			0
Storage Lanes	1	1	1			0
Taper Length (ft)	25		25			
Lane Util. Factor	1.00	1.00	1.00	0.95	0.95	0.95
Frt		0.850			0.975	
Flt Protected	0.950		0.950			
Satd. Flow (prot)	1770	1583	1770	3539	3451	0
Flt Permitted	0.950		0.950			
Satd. Flow (perm)	1770	1583	1770	3539	3451	0
Link Speed (mph)	30			30	30	
Link Distance (ft)	237			480	451	
Travel Time (s)	5.4			10.9	10.3	
Peak Hour Factor	0.88	0.88	0.88	0.88	0.88	0.88
Adj. Flow (vph)	241	160	30	227	423	83
Shared Lane Traffic (%)						
Lane Group Flow (vph)	241	160	30	227	506	0
Enter Blocked Intersection	No	No	No	No	No	No
Lane Alignment	Left	Right	Left	Left	Left	Right
Median Width(ft)	12			12	12	
Link Offset(ft)	0			0	0	
Crosswalk Width(ft)	16			16	16	
Two way Left Turn Lane						
Headway Factor	1.00	1.00	1.00	1.00	1.00	1.00
Turning Speed (mph)	15	9	15			9
Sign Control	Stop			Free	Free	

Intersection Summary

Area Type:	Other
Control Type:	Unsignalized
Intersection Capacity Utilization	37.7%
	ICU Level of Service A
Analysis Period (min)	15

HCM 2010 TWSC
 101: S. Roosevelt Blvd & Seaside Drive

Intersection

Int Delay, s/veh 7.3

















Movement	EBL	EBR	NBL	NBT	SBT	SBR
Lane Configurations						
Traffic Vol, veh/h	212	141	26	200	372	73
Future Vol, veh/h	212	141	26	200	372	73
Conflicting Peds, #/hr	0	0	0	0	0	0
Sign Control	Stop	Stop	Free	Free	Free	Free
RT Channelized	-	None	-	None	-	None
Storage Length	0	0	200	-	-	-
Veh in Median Storage, #	0	-	-	0	0	-
Grade, %	0	-	-	0	0	-
Peak Hour Factor	88	88	88	88	88	88
Heavy Vehicles, %	2	2	2	2	2	2
Mvmt Flow	241	160	30	227	423	83

Major/Minor	Minor2	Major1		Major2
Conflicting Flow All	637	253	506	0
Stage 1	464	-	-	-
Stage 2	173	-	-	-
Critical Hdwy	6.84	6.94	4.14	-
Critical Hdwy Stg 1	5.84	-	-	-
Critical Hdwy Stg 2	5.84	-	-	-
Follow-up Hdwy	3.52	3.32	2.22	-
Pot Cap-1 Maneuver	410	746	1055	-
Stage 1	599	-	-	-
Stage 2	840	-	-	-
Platoon blocked, %				-
Mov Cap-1 Maneuver	398	746	1055	-
Mov Cap-2 Maneuver	398	-	-	-
Stage 1	599	-	-	-
Stage 2	816	-	-	-

Approach	EB	NB	SB
HCM Control Delay, s	20.6	1	0
HCM LOS	C		

Minor Lane/Major Mvmt	NBL	NBT	EBLn1	EBLn2	SBT	SBR
Capacity (veh/h)	1055	-	398	746	-	-
HCM Lane V/C Ratio	0.028	-	0.605	0.215	-	-
HCM Control Delay (s)	8.5	-	27	11.1	-	-
HCM Lane LOS	A	-	D	B	-	-
HCM 95th %tile Q(veh)	0.1	-	3.8	0.8	-	-

Lanes, Volumes, Timings
 102: N Driveway/S Driveway & Seaside Drive

												
Lane Group	EBL	EBT	EBR	WBL	WBT	WBR	NBL	NBT	NBR	SBL	SBT	SBR
Lane Configurations												
Traffic Volume (vph)	1	66	2	61	24	4	1	8	191	50	2	1
Future Volume (vph)	1	66	2	61	24	4	1	8	191	50	2	1
Ideal Flow (vphpl)	1900	1900	1900	1900	1900	1900	1900	1900	1900	1900	1900	1900
Lane Util. Factor	1.00	1.00	1.00	1.00	1.00	1.00	1.00	1.00	1.00	1.00	1.00	1.00
Frt		0.996			0.994			0.871			0.998	
Flt Protected		0.999			0.967						0.955	
Satd. Flow (prot)	0	1853	0	0	1790	0	0	1622	0	0	1775	0
Flt Permitted		0.999			0.967						0.955	
Satd. Flow (perm)	0	1853	0	0	1790	0	0	1622	0	0	1775	0
Link Speed (mph)		30			30			30			30	
Link Distance (ft)		143			161			171			124	
Travel Time (s)		3.3			3.7			3.9			2.8	
Peak Hour Factor	0.95	0.95	0.95	0.95	0.95	0.95	0.95	0.95	0.95	0.95	0.95	0.95
Adj. Flow (vph)	1	69	2	64	25	4	1	8	201	53	2	1
Shared Lane Traffic (%)												
Lane Group Flow (vph)	0	72	0	0	93	0	0	210	0	0	56	0
Enter Blocked Intersection	No	No	No	No	No	No	No	No	No	No	No	No
Lane Alignment	Left	Left	Right	Left	Left	Right	Left	Left	Right	Left	Left	Right
Median Width(ft)		0			0			0			0	
Link Offset(ft)		0			0			0			0	
Crosswalk Width(ft)		16			16			16			16	
Two way Left Turn Lane												
Headway Factor	1.00	1.00	1.00	1.00	1.00	1.00	1.00	1.00	1.00	1.00	1.00	1.00
Turning Speed (mph)	15		9	15		9	15		9	15		9
Sign Control		Yield			Yield			Yield			Yield	

Intersection Summary

Area Type:	Other
Control Type:	Roundabout
Intersection Capacity Utilization	37.2%
ICU Level of Service	A
Analysis Period (min)	15

HCM 2010 Roundabout
 102: N Driveway/S Driveway & Seaside Drive

Intersection				
Intersection Delay, s/veh	4.9			
Intersection LOS	A			
Approach	EB	WB	NB	SB
Entry Lanes	1	1	1	1
Conflicting Circle Lanes	1	1	1	1
Adj Approach Flow, veh/h	72	93	210	56
Demand Flow Rate, veh/h	73	95	214	57
Vehicles Circulating, veh/h	121	10	125	91
Vehicles Exiting, veh/h	27	329	69	13
Follow-Up Headway, s	3.186	3.186	3.186	3.186
Ped Vol Crossing Leg, #/h	0	0	0	0
Ped Cap Adj	1.000	1.000	1.000	1.000
Approach Delay, s/veh	4.3	4.0	5.8	4.0
Approach LOS	A	A	A	A
Lane	Left	Left	Left	Left
Designated Moves	LTR	LTR	LTR	LTR
Assumed Moves	LTR	LTR	LTR	LTR
RT Channelized				
Lane Util	1.000	1.000	1.000	1.000
Critical Headway, s	5.193	5.193	5.193	5.193
Entry Flow, veh/h	73	95	214	57
Cap Entry Lane, veh/h	1001	1119	997	1032
Entry HV Adj Factor	0.981	0.984	0.981	0.982
Flow Entry, veh/h	72	93	210	56
Cap Entry, veh/h	982	1101	978	1013
V/C Ratio	0.073	0.085	0.215	0.055
Control Delay, s/veh	4.3	4.0	5.8	4.0
LOS	A	A	A	A
95th %tile Queue, veh	0	0	1	0

Lanes, Volumes, Timings
 101: S. Roosevelt Blvd & Seaside Drive

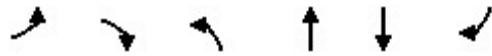

Lane Group	EBL	EBR	NBL	NBT	SBT	SBR
Lane Configurations						
Traffic Volume (vph)	134	61	92	463	295	198
Future Volume (vph)	134	61	92	463	295	198
Ideal Flow (vphpl)	1900	1900	1900	1900	1900	1900
Storage Length (ft)	0	0	200			0
Storage Lanes	1	1	1			0
Taper Length (ft)	25		25			
Lane Util. Factor	1.00	1.00	1.00	0.95	0.95	0.95
Frt		0.850			0.940	
Flt Protected	0.950		0.950			
Satd. Flow (prot)	1770	1583	1770	3539	3327	0
Flt Permitted	0.950		0.950			
Satd. Flow (perm)	1770	1583	1770	3539	3327	0
Link Speed (mph)	30			30	30	
Link Distance (ft)	237			480	451	
Travel Time (s)	5.4			10.9	10.3	
Peak Hour Factor	0.91	0.91	0.91	0.91	0.91	0.91
Adj. Flow (vph)	147	67	101	509	324	218
Shared Lane Traffic (%)						
Lane Group Flow (vph)	147	67	101	509	542	0
Enter Blocked Intersection	No	No	No	No	No	No
Lane Alignment	Left	Right	Left	Left	Left	Right
Median Width(ft)	12			12	12	
Link Offset(ft)	0			0	0	
Crosswalk Width(ft)	16			16	16	
Two way Left Turn Lane						
Headway Factor	1.00	1.00	1.00	1.00	1.00	1.00
Turning Speed (mph)	15	9	15			9
Sign Control	Stop			Free	Free	

Intersection Summary

Area Type:	Other
Control Type:	Unsignalized
Intersection Capacity Utilization	37.0%
ICU Level of Service	A
Analysis Period (min)	15

HCM 2010 TWSC
 101: S. Roosevelt Blvd & Seaside Drive

Intersection

Int Delay, s/veh 5.2

Movement	EBL	EBR	NBL	NBT	SBT	SBR
Lane Configurations						
Traffic Vol, veh/h	134	61	92	463	295	198
Future Vol, veh/h	134	61	92	463	295	198
Conflicting Peds, #/hr	0	0	0	0	0	0
Sign Control	Stop	Stop	Free	Free	Free	Free
RT Channelized	-	None	-	None	-	None
Storage Length	0	0	200	-	-	-
Veh in Median Storage, #	0	-	-	0	0	-
Grade, %	0	-	-	0	0	-
Peak Hour Factor	91	91	91	91	91	91
Heavy Vehicles, %	2	2	2	2	2	2
Mvmt Flow	147	67	101	509	324	218

Major/Minor	Minor2	Major1		Major2
Conflicting Flow All	890	271	542	0
Stage 1	433	-	-	-
Stage 2	457	-	-	-
Critical Hdwy	6.84	6.94	4.14	-
Critical Hdwy Stg 1	5.84	-	-	-
Critical Hdwy Stg 2	5.84	-	-	-
Follow-up Hdwy	3.52	3.32	2.22	-
Pot Cap-1 Maneuver	282	727	1023	-
Stage 1	621	-	-	-
Stage 2	604	-	-	-
Platoon blocked, %				-
Mov Cap-1 Maneuver	254	727	1023	-
Mov Cap-2 Maneuver	254	-	-	-
Stage 1	621	-	-	-
Stage 2	544	-	-	-

Approach	EB	NB	SB
HCM Control Delay, s	28.7	1.5	0
HCM LOS	D		

Minor Lane/Major Mvmt	NBL	NBT	EBLn1	EBLn2	SBT	SBR
Capacity (veh/h)	1023	-	254	727	-	-
HCM Lane V/C Ratio	0.099	-	0.58	0.092	-	-
HCM Control Delay (s)	8.9	-	37	10.5	-	-
HCM Lane LOS	A	-	E	B	-	-
HCM 95th %tile Q(veh)	0.3	-	3.3	0.3	-	-

Lanes, Volumes, Timings
 102: N Driveway/S Driveway & Seaside Drive

Lane Group	EBL	EBT	EBR	WBL	WBT	WBR	NBL	NBT	NBR	SBL	SBT	SBR
Lane Configurations												
Traffic Volume (vph)	1	47	2	193	60	5	2	3	115	34	2	2
Future Volume (vph)	1	47	2	193	60	5	2	3	115	34	2	2
Ideal Flow (vphpl)	1900	1900	1900	1900	1900	1900	1900	1900	1900	1900	1900	1900
Lane Util. Factor	1.00	1.00	1.00	1.00	1.00	1.00	1.00	1.00	1.00	1.00	1.00	1.00
Frt		0.995			0.998			0.870			0.993	
Flt Protected		0.999			0.964			0.999			0.957	
Satd. Flow (prot)	0	1852	0	0	1792	0	0	1619	0	0	1770	0
Flt Permitted		0.999			0.964			0.999			0.957	
Satd. Flow (perm)	0	1852	0	0	1792	0	0	1619	0	0	1770	0
Link Speed (mph)		30			30			30			30	
Link Distance (ft)		143			161			171			124	
Travel Time (s)		3.3			3.7			3.9			2.8	
Peak Hour Factor	0.94	0.94	0.94	0.94	0.94	0.94	0.94	0.94	0.94	0.94	0.94	0.94
Adj. Flow (vph)	1	50	2	205	64	5	2	3	122	36	2	2
Shared Lane Traffic (%)												
Lane Group Flow (vph)	0	53	0	0	274	0	0	127	0	0	40	0
Enter Blocked Intersection	No	No	No	No	No	No	No	No	No	No	No	No
Lane Alignment	Left	Left	Right	Left	Left	Right	Left	Left	Right	Left	Left	Right
Median Width(ft)		0			0			0			0	
Link Offset(ft)		0			0			0			0	
Crosswalk Width(ft)		16			16			16			16	
Two way Left Turn Lane												
Headway Factor	1.00	1.00	1.00	1.00	1.00	1.00	1.00	1.00	1.00	1.00	1.00	1.00
Turning Speed (mph)	15		9	15		9	15		9	15		9
Sign Control		Yield			Yield			Yield			Yield	

Intersection Summary

Area Type: Other

Control Type: Roundabout

Intersection Capacity Utilization 36.3% ICU Level of Service A

Analysis Period (min) 15

HCM 2010 Roundabout
 102: N Driveway/S Driveway & Seaside Drive

Intersection				
Intersection Delay, s/veh	5.2			
Intersection LOS	A			
Approach	EB	WB	NB	SB
Entry Lanes	1	1	1	1
Conflicting Circle Lanes	1	1	1	1
Adj Approach Flow, veh/h	53	274	127	40
Demand Flow Rate, veh/h	54	279	129	41
Vehicles Circulating, veh/h	248	6	89	276
Vehicles Exiting, veh/h	69	212	213	9
Follow-Up Headway, s	3.186	3.186	3.186	3.186
Ped Vol Crossing Leg, #/h	0	0	0	0
Ped Cap Adj	1.000	1.000	1.000	1.000
Approach Delay, s/veh	4.7	5.6	4.7	4.8
Approach LOS	A	A	A	A
Lane	Left	Left	Left	Left
Designated Moves	LTR	LTR	LTR	LTR
Assumed Moves	LTR	LTR	LTR	LTR
RT Channelized				
Lane Util	1.000	1.000	1.000	1.000
Critical Headway, s	5.193	5.193	5.193	5.193
Entry Flow, veh/h	54	279	129	41
Cap Entry Lane, veh/h	882	1123	1034	857
Entry HV Adj Factor	0.981	0.981	0.984	0.975
Flow Entry, veh/h	53	274	127	40
Cap Entry, veh/h	865	1102	1017	836
V/C Ratio	0.061	0.248	0.125	0.048
Control Delay, s/veh	4.7	5.6	4.7	4.8
LOS	A	A	A	A
95th %tile Queue, veh	0	1	0	0

APPENDIX G

FDOT 2013 Quality / LOS Handbook Excerpt

Generalized **Peak Hour Two-Way** Volumes for Florida's
Urbanized Areas¹

TABLE 4

12/18/12

INTERRUPTED FLOW FACILITIES						UNINTERRUPTED FLOW FACILITIES								
STATE SIGNALIZED ARTERIALS						FREEWAYS								
Class I (40 mph or higher posted speed limit)						Lanes	B	C	D	E				
Lanes	Median	B	C	D	E	4	4,120	5,540	6,700	7,190				
2	Undivided	*	1,510	1,600	**	6	6,130	8,370	10,060	11,100				
4	Divided	*	3,420	3,580	**	8	8,230	11,100	13,390	15,010				
6	Divided	*	5,250	5,390	**	10	10,330	14,040	16,840	18,930				
8	Divided	*	7,090	7,210	**	12	14,450	18,880	22,030	22,860				
Class II (35 mph or slower posted speed limit)						Freeway Adjustments								
Lanes	Median	B	C	D	E	Auxiliary Lanes			Ramp					
2	Undivided	*	660	1,330	1,410	Present in Both Directions			Metering					
4	Divided	*	1,310	2,920	3,040	+ 1,800			+ 5%					
6	Divided	*	2,090	4,500	4,590									
8	Divided	*	2,880	6,060	6,130									
Non-State Signalized Roadway Adjustments (Alter corresponding state volumes by the indicated percent.)														
Non-State Signalized Roadways - 10%														
Median & Turn Lane Adjustments														
Lanes	Median	Exclusive Left Lanes	Exclusive Right Lanes	Adjustment Factors										
2	Divided	Yes	No	+5%										
2	Undivided	No	No	-20%										
Multi	Undivided	Yes	No	-5%										
Multi	Undivided	No	No	-25%										
-	-	-	Yes	+ 5%										
One-Way Facility Adjustment Multiply the corresponding two-directional volumes in this table by 0.6														
BICYCLE MODE ² (Multiply motorized vehicle volumes shown below by number of directional roadway lanes to determine two-way maximum service volumes.)														
Paved Shoulder/Bicycle														
Lane Coverage	B	C	D	E										
0-49%	*	260	680	1,770										
50-84%	190	600	1,770	>1,770										
85-100%	830	1,770	>1,770	**										
PEDESTRIAN MODE ² (Multiply motorized vehicle volumes shown below by number of directional roadway lanes to determine two-way maximum service volumes.)														
Sidewalk Coverage	B	C	D	E										
0-49%	*	*	250	850										
50-84%	*	150	780	1,420										
85-100%	340	960	1,560	>1,770										
BUS MODE (Scheduled Fixed Route) ³ (Buses in peak hour in peak direction)														
Sidewalk Coverage	B	C	D	E										
0-84%	> 5	≥ 4	≥ 3	≥ 2										
85-100%	> 4	≥ 3	≥ 2	≥ 1										
						UNINTERRUPTED FLOW HIGHWAYS								
Lanes	Median	B	C	D	E									
2	Undivided	770	1,530	2,170	2,990									
4	Divided	3,300	4,660	5,900	6,530									
6	Divided	4,950	6,990	8,840	9,790									
Uninterrupted Flow Highway Adjustments														
Lanes	Median	Exclusive left lanes		Adjustment factors										
2	Divided	Yes		+5%										
Multi	Undivided	Yes		-5%										
Multi	Undivided	No		-25%										
						¹ Values shown are presented as peak hour two-way volumes for levels of service and are for the automobile/truck modes unless specifically stated. This table does not constitute a standard and should be used only for general planning applications. The computer models from which this table is derived should be used for more specific planning applications. The table and deriving computer models should not be used for corridor or intersection design, where more refined techniques exist. Calculations are based on planning applications of the Highway Capacity Manual and the Transit Capacity and Quality of Service Manual.								
						² Level of service for the bicycle and pedestrian modes in this table is based on number of motorized vehicles, not number of bicyclists or pedestrians using the facility.								
						³ Buses per hour shown are only for the peak hour in the single direction of the higher traffic flow.								
						* Cannot be achieved using table input value defaults.								
						** Not applicable for that level of service letter grade. For the automobile mode, volumes greater than level of service D become F because intersection capacities have been reached. For the bicycle mode, the level of service letter grade (including F) is not achievable because there is no maximum vehicle volume threshold using table input value defaults.								
						Source: Florida Department of Transportation Systems Planning Office www.dot.state.fl.us/planning/systems/sm/los/default.shtm								