



Historic Architectural Review Commission Staff Report for Item 7

To: Chairman Bryan Green and Historic Architectural Review
Commission Members

From: Enid Torregrosa-Silva, MSHP
Historic Preservation Planner

Meeting Date: October 27, 2021

Applicant: Artibus Design, Engineers

Application Number: H2021-0050

Address: 317 Whitehead Street

Description of Work:

Renovations to historic one-story wood frame structure. Construction of new two-story wood frame structure to replace existing cmu structure. Site improvements.

Site Facts:

The site under review consists of two historic buildings. The northernmost structure, originally known as 311 Whitehead Street, is a contributing resource build circa 1910 and it is a one-story frame structure used as an office in the past years. The building to the south is a CMU one-story structure with a two-story addition at its rear. The building was built circa 1960 and the rear addition is from 1975. The structure was built for offices until the previous owners sold it this year. Currently both buildings are attached.

A BPAS approval will be required for conversion of office space into residence.

Guidelines Cited on Review:

- Building Exteriors – Wood (page 24), specifically guideline 1.
- Roofing (page 26), specifically guideline 1.
- Windows (pages 29-30), specifically guidelines 2 and 3.

- New Construction (pages 38a-q), specifically guidelines 1, 2, 3 6, 8, 9, 11, 12, 13, 14, 17, 18, 22, 23, 24, and 25.
- Pools (page 39-a), specifically guideline 3.
- Fences and walls (pages 41-42), specifically guidelines 1, 3, 4, and 6.

Staff Analysis:

The Certificate of Appropriateness under review proposes the renovation of a single-story historic frame building, which includes restoration and replacement of missing wood siding matching existing, restoration and replacement of non-existing windows with wood units matching existing and the installation of metal sliders in the rear elevation. The building will be used as a part of the principal use of a new two-story detached house and will contain two bedrooms and bathrooms. The proposed design will maintain the front entry door and the concrete front porch floor. New metal shingles will replace the existing deteriorated ones.

The plan includes the construction of a two-story frame building that will replace the existing CMU structure located to the south side of the one-story historic building. The new building will have a front gable roof on its main core and a side gable roof over the rear portion. A one-story front porch with a hip roof is proposed in the front elevation. The new house will be based on traditional architecture found within the neighboring context but will not mimic any historic building. The house will be rectangular in footprint and will have wood siding, aluminum windows and shutters and metal shingles as the roofing finish material. The building will have a small roof covering an entry on the north elevation that will allow access to the south elevation of the historic house without been attached to it. The maximum height of the house will be 29'-11" from crown of the road.

The plan also includes a pool with deck at the rear portion of the site and not visible from Whitehead Street. Pavers are proposed to replace the existing concrete driveway. A wood fence will be installed at the rear and east side property lines.

Consistency with Cited Guidelines:

It is staff's opinion that the proposed renovations to the historic house are within the cited guidelines. Staff also finds the new two-story house to follow many of the cited guidelines. Although the building will be taller and scale wise larger than the adjacent one-story house, historic evidence proves that a two-story frame house used to be on that location and approximately the same setback than the proposed new house. Majority of surrounding buildings within the urban context are two-story houses. The only guideline that staff finds the new building will not meet is the requirement of "*For residential development, acceptable proposals must be located on the site no further forward than the front façade set back of existing adjacent property* (guideline 6 for new construction). Still staff finds that the neighboring principal building on the abutting south side has an unusual large street setback and away from the lot in question that its placement will be appropriate with the urban context.

Staff finds the proposed pool and rear deck to meet the guidelines and recommends the Commission to consider the first ten feet of the proposed north side picket fence to be four feet height from the front property line to meet fencing guidelines.

APPLICATION

HARC MAJOR PROJECTS CERTIFICATE OF APPROPRIATENESS

\$420 NON-REFUNDABLE BASE APPLICATION FEE - OTHER FEES MAY BE APPLICABLE Rev 12/14/2020 ET



City of Key West

1300 White Street
Key West, Florida 33040

HARC COA # <i>2021-0050</i>	REVISION #	INITIAL & DATE
FLOOD ZONE	ZONING DISTRICT	BLDG PERMIT #

A PRE-APPLICATION MEETING WITH HARC STAFF IS REQUIRED PRIOR TO SUBMITTAL

ADDRESS OF PROPOSED PROJECT:	317 Whitehead St	
NAME ON DEED:	Michael R Marceau	PHONE NUMBER
OWNER'S MAILING ADDRESS:	PO Box 584, Kennebunkport ME 04046	EMAIL
APPLICANT NAME:	Serge Mashtakov P.E.	PHONE NUMBER (305) 304-3512
APPLICANT'S ADDRESS:	3710 N Roosevelt Blvd, Key West, FL 33040	EMAIL Serge@artibusdesign.com
APPLICANT'S SIGNATURE:	<i>Serge Mashtakov</i>	DATE 08/10/2021

ANY PERSON THAT MAKES CHANGES TO AN APPROVED CERTIFICATE OF APPROPRIATENESS MUST SUBMIT A NEW APPLICATION.

FLORIDA STATUTE 837.06: WHOEVER KNOWINGLY MAKES A FALSE STATEMENT IN WRITING AND WITH THE INTENT TO MISLEAD A PUBLIC SERVANT IN THE PERFORMANCE OF HIS OR HER OFFICIAL DUTY SHALL BE GUILTY OF A MISDEMEANOR OF THE SECOND-DEGREE PUNISHABLE PER SECTION 775.082 OR 775.083. THE APPLICANT FURTHER HEREBY ACKNOWLEDGES THAT THE SCOPE OF WORK AS DESCRIBED IN THE APPLICATION SHALL BE THE SCOPE OF WORK THAT IS CONTEMPLATED BY THE APPLICANT AND THE CITY. THE APPLICANT FURTHER STIPULATES THAT SHOULD FURTHER ACTION BE TAKEN BY THE CITY FOR EXCEEDING THE SCOPE OF THE DESCRIPTION OF WORK, AS DESCRIBED HEREIN, AND IF THERE IS CONFLICTING INFORMATION BETWEEN THE DESCRIPTION OF WORK AND THE SUBMITTED PLANS, THE AFOREMENTIONED DESCRIPTION OF WORK SHALL BE CONTROLLING.

PROJECT INCLUDES: REPLACEMENT OF WINDOWS RELOCATION OF A STRUCTURE ___ ELEVATION OF A STRUCTURE ___
 PROJECT INVOLVES A CONTRIBUTING STRUCTURE: YES NO ___ INVOLVES A HISTORIC STRUCTURE: YES NO ___
 PROJECT INVOLVES A STRUCTURE THAT IS INDIVIDUALLY LISTED ON THE NATIONAL REGISTER: YES ___ NO

DETAILED PROJECT DESCRIPTION INCLUDING MATERIALS, HEIGHT, DIMENSIONS, SQUARE FOOTAGE, LOCATION, ETC.
GENERAL: Remodeling of the existing historic one story wood frame, restoration of the exterior siding, replacement and repairs to existing wood frame windows, replacement of roofing (victorian shingles), demolition of the existing CMU 2 story house with non-historic front porch enclosure, demolition of joining link, replacement with new detached principle structure 2 story wood frame Wood siding exterior, aluminum windows, wood front doors, victorian shingle metal roofing, +/- 29'-11" total height from crown of road.
MAIN BUILDING: Restoration of wood siding, windows and doors, on front and exposed side elevations, new aluminum sliding doors and window rear elevation, new interior build-out.
DEMOLITION (PLEASE FILL OUT AND ATTACH DEMOLITION APPENDIX):

**APPLICATIONS MUST BE SUBMITTED IN PERSON WITH HARD COPIES BY 3PM ON THE SCHEDULED DEADLINE
PLEASE SEND AN ELECTRONIC COPY OF ALL DOCUMENTS CITY_HARC@CITYOFKEYWEST-FL.GOV**

ACCESSORY STRUCTURE(S):	
PAVERS: HARC approved pavers, pervious style to replace existing concrete and provide better drainage for major tree located on the right property line.	FENCES: 6ft wood picket fences on rear and left side property lines HARC approved style. Existing fence on right side to remain.
DECKS: Existing concrete front porch to remain. New house wood frame front porches, historic style T&G decking Rear pool deck - composite over wood frame.	PAINTING: White paint both buildings or HARC approved pastel color
SITE (INCLUDING GRADING, FILL, TREES, ETC): No major grading is proposed.	POOLS (INCLUDING EQUIPMENT): 16ftx18ft pool in the rear of the property, pool equipment behind decorative fountain wall in the back.
ACCESSORY EQUIPMENT (GAS, A/C, VENTS, ETC): A/C equipment on the sides, 2 units together with trash and recycle area behind 6ft privacy fence on right side. One unit on left side	OTHER:

OFFICIAL USE ONLY:	HARC COMMISSION REVIEW	EXPIRES ON:
MEETING DATE:	___APPROVED ___NOT APPROVED ___DEFERRED FOR FUTURE CONSIDERATION	INITIAL:
MEETING DATE:	___APPROVED ___NOT APPROVED ___DEFERRED FOR FUTURE CONSIDERATION	INITIAL:
MEETING DATE:	___APPROVED ___NOT APPROVED ___DEFERRED FOR FUTURE CONSIDERATION	INITIAL:
REASONS OR CONDITIONS:		
STAFF REVIEW COMMENTS:		
FIRST READING FOR DEMO:	SECOND READING FOR DEMO:	
HARC STAFF SIGNATURE AND DATE:	HARC CHAIRPERSON SIGNATURE AND DATE:	

THIS APPLICATION MAY BE REVIEWED BY PLANNING DEPARTMENT STAFF.

HARC CERTIFICATE OF APPROPRIATENESS: DEMOLITION APPENDIX



City of Key West

1300 White Street
Key West, Florida 33040

HARC COA # <i>2021-0090</i>	INITIAL & DATE
ZONING DISTRICT	BLDG PERMIT #

ADDRESS OF PROPOSED PROJECT:	317 Whitehead St
PROPERTY OWNER'S NAME:	Michael R Marceau
APPLICANT NAME:	Serge Mashtakov P.E.

*I hereby certify I am the owner of record and that the work shall conform to all applicable laws of this jurisdiction. By receiving a Certificate of Appropriateness, I realize that this project will require a Building Permit approval **PRIOR to proceeding with the work outlined above** and that a final inspection is required under this application. I also understand that **any changes to an approved Certificate of Appropriateness must be submitted for review.***

PROPERTY OWNER'S SIGNATURE _____ DATE AND PRINT NAME _____

DETAILED PROJECT DESCRIPTION OF DEMOLITION

Demolish existing two story CMU structure with wood frame front porch enclosure and joining link between the historic 1 story wood frame structure and the CMU building. Manually demolish concrete drive to protect root system of the existing tree.

CRITERIA FOR DEMOLITION OF CONTRIBUTING OR HISTORIC STRUCTURES:

Before any Certificate of Appropriateness may be issued for a demolition request, the Historic Architectural Review Commission must find that the following requirements are met (please review and comment on each criterion that applies):

(1) If the subject of the application is a contributing or historic building or structure, then it should not be demolished unless its condition is irrevocably compromised by extreme deterioration or it does not meet any of the following criteria:

(a) The existing condition of the building or structure is irrevocably compromised by extreme deterioration.

The existing concrete structure is experiencing severe concrete spalling damage in many areas and shows signs of spalling propagation in others. It appears that the concrete used has high chlorine content (salt in the aggregate) and spalling damage will continue to propagate. Permit records show concrete repairs building permit back in 1995 of a small value which clearly wasn't effective.

(2) Or explain how the building or structure meets the criteria below:

(a) Embodies no distinctive characteristics of a type, period, or method of construction of aesthetic or historic significance in the city and is not a significant and distinguishable building entity whose components may lack individual distinction.

The building has strictly utilitarian office/commercial building look for a structure constructed in 1963. With later alterations and enclosure of the front porch to mimic the adjacent wood frame structure. Which in reality destroyed and altered any estetical value of the 1963 modern style front entry into the effoice. Later 2nd story addition further deteriorated the character of the building and is currently a nuisance to the otherwise beautiful neighborhood.

Nothing in this application is intended to alter the authority of the Building Official to condemn for demolition dangerous buildings, as provided in Section 102-218 of the Land Development Regulations and Chapter 14 of the Code of Ordinances.

(b) Is not specifically associated with events that have made a significant contribution to local, state, or national history.

No known events that made a significant contribution to local, state or national history have occurred in this building.

(c) Has no significant character, interest, or value as part of the development, heritage, or cultural characteristics of the city, state or nation, and is not associated with the life of a person significant in the past.

No known historically significant persons associated with this structure.

(d) Is not the site of a historic event with significant effect upon society.

The building wasn't a site of any historical event important to Key West society.

(e) Does not exemplify the cultural, political, economic, social, or historic heritage of the city.

Does not exemplify any cultural, political, economic, social or historic heritage of Key West.

(f) Does not portray the environment in an era of history characterized by a distinctive architectural style.

No distinctive character or architectural style can be assigned to what is left of the structure.

(g) If a part of or related to a square, park, or other distinctive area, nevertheless should not be developed or preserved according to a plan based on the area's historic, cultural, natural, or architectural motif.

N/A

(h) Does not have a unique location or singular physical characteristic which represents an established and familiar visual feature of its neighborhood or of the city and does not exemplify the best remaining architectural type in a neighborhood.

N/A

Nothing in this application is intended to alter the authority of the Building Official to condemn for demolition dangerous buildings, as provided in Section 102-218 of the Land Development Regulations and Chapter 14 of the Code of Ordinances.

(i) Has not yielded, and is not likely to yield, information important in history,
Not likely to yield any important historical information.

CRITERIA FOR DEMOLITION OF NON-CONTRIBUTING OR NON-HISTORIC STRUCTURES:

The following criteria will also be reviewed by the Historic Architectural Review Commission for proposed demolitions. The Commission shall not issue a Certificate of Appropriateness that would result in the following conditions (please review and comment on each criterion that applies):

(1) Removing buildings or structure that are important in defining the overall historic character of a district or neighborhood so that the character is diminished.
The building is not important to the overall historic character of a district. If anything it is a nuisance and a distraction to the neighborhood it is located in.
(2) Removing historic buildings or structures and thus destroying the historic relationship between buildings or structures and open space.
Proposed demolition actually restores historical accuracy by removing a link between one story wood frame historical structure and to be replaced with properly proportioned wood frame structure following the style of the district.
(3) Removing an historic building or structure in a complex; or removing a building façade; or removing a significant later addition that is important in defining the historic character of a site or the surrounding district or neighborhood.
The CMU structure, the joining link, the 2nd story rear addition nor later wood frame enclosure in the front are not important in defining the historic character of the site and are only obstructing the existing wood frame 1 story part of the compound.
(4) Removing buildings or structures that would otherwise qualify as contributing.
N/A

SANBORN MAPS

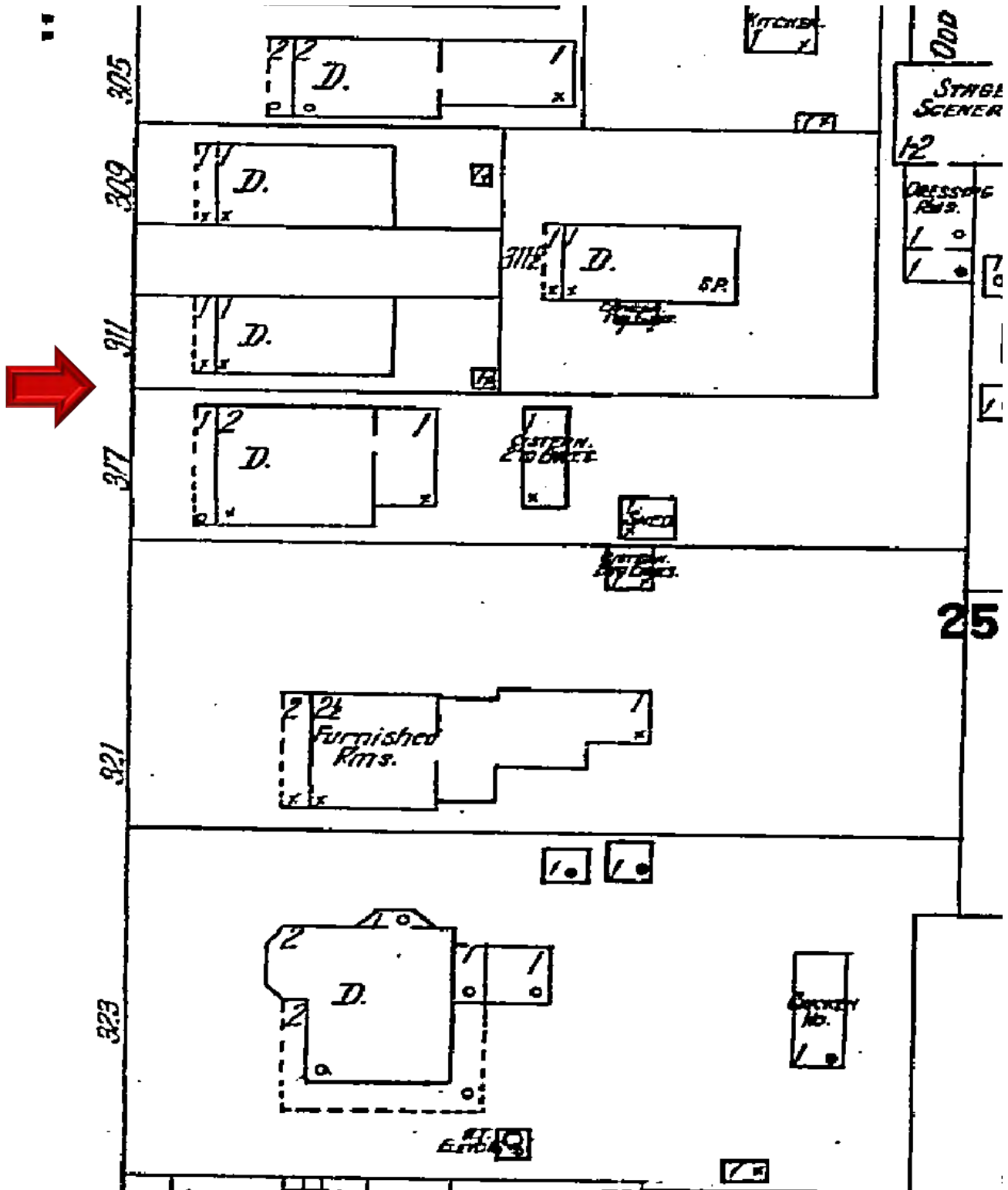

1912 Sanborn Map

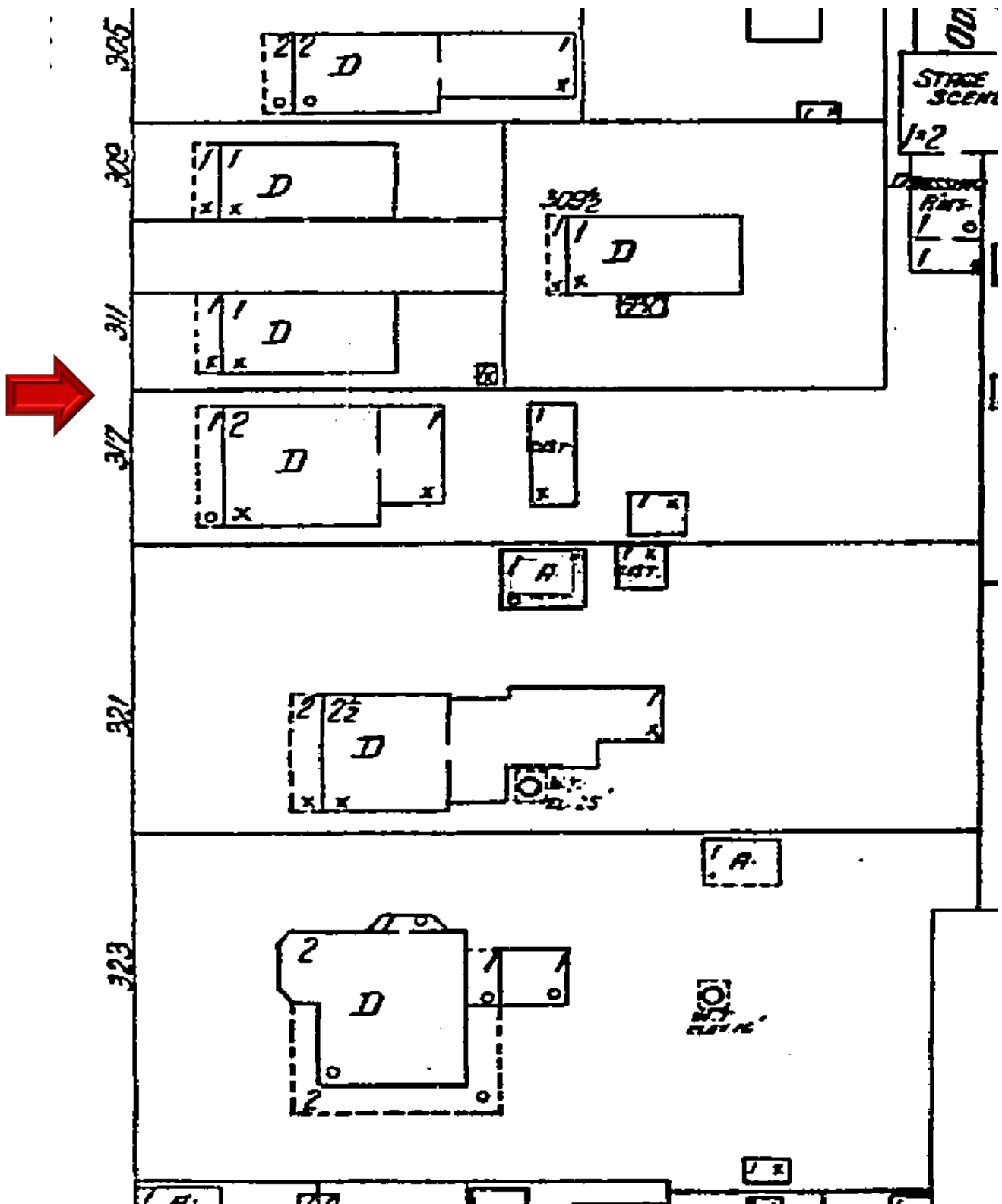

1926 Sanborn Map

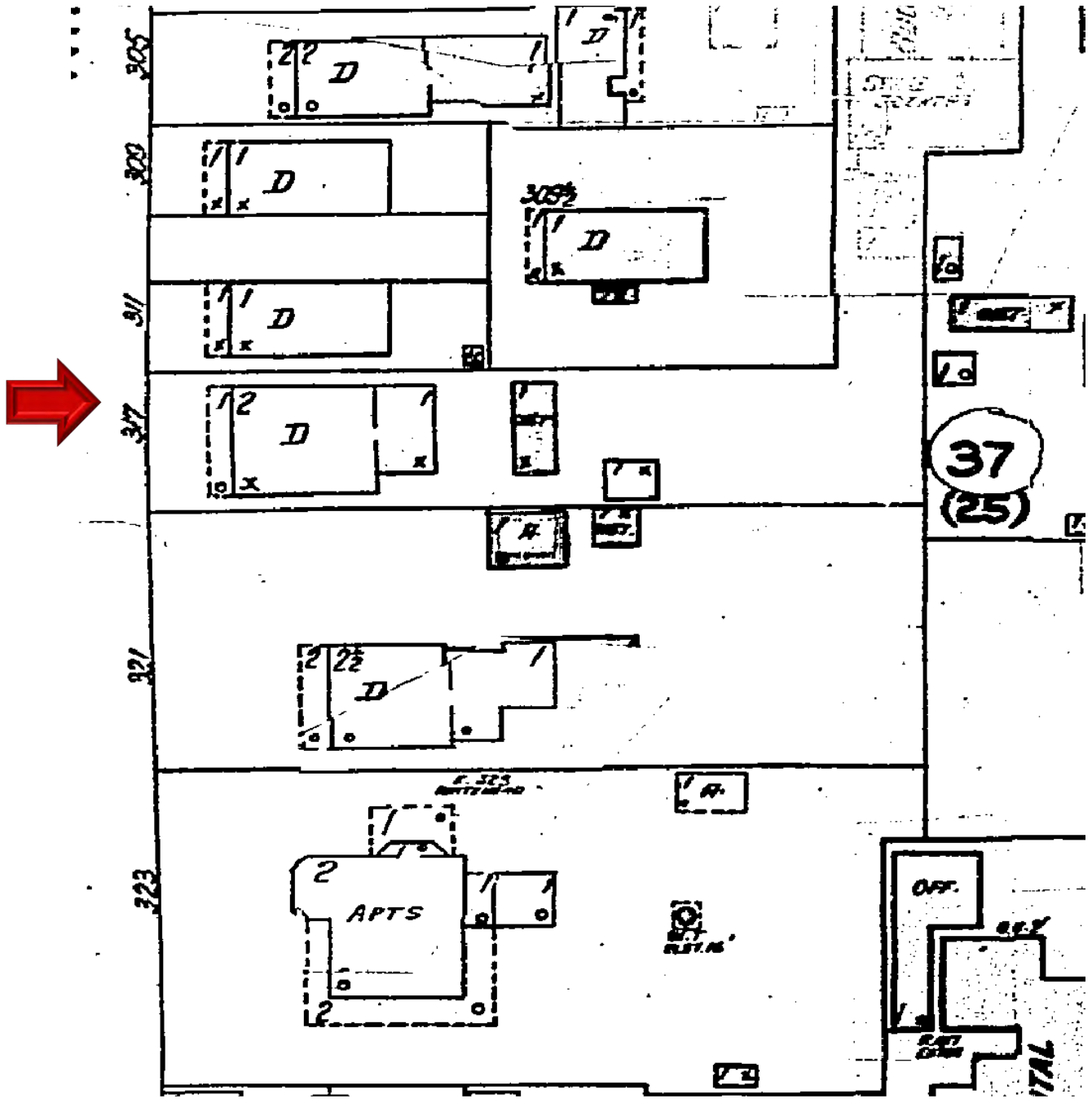

1948 Sanborn Map

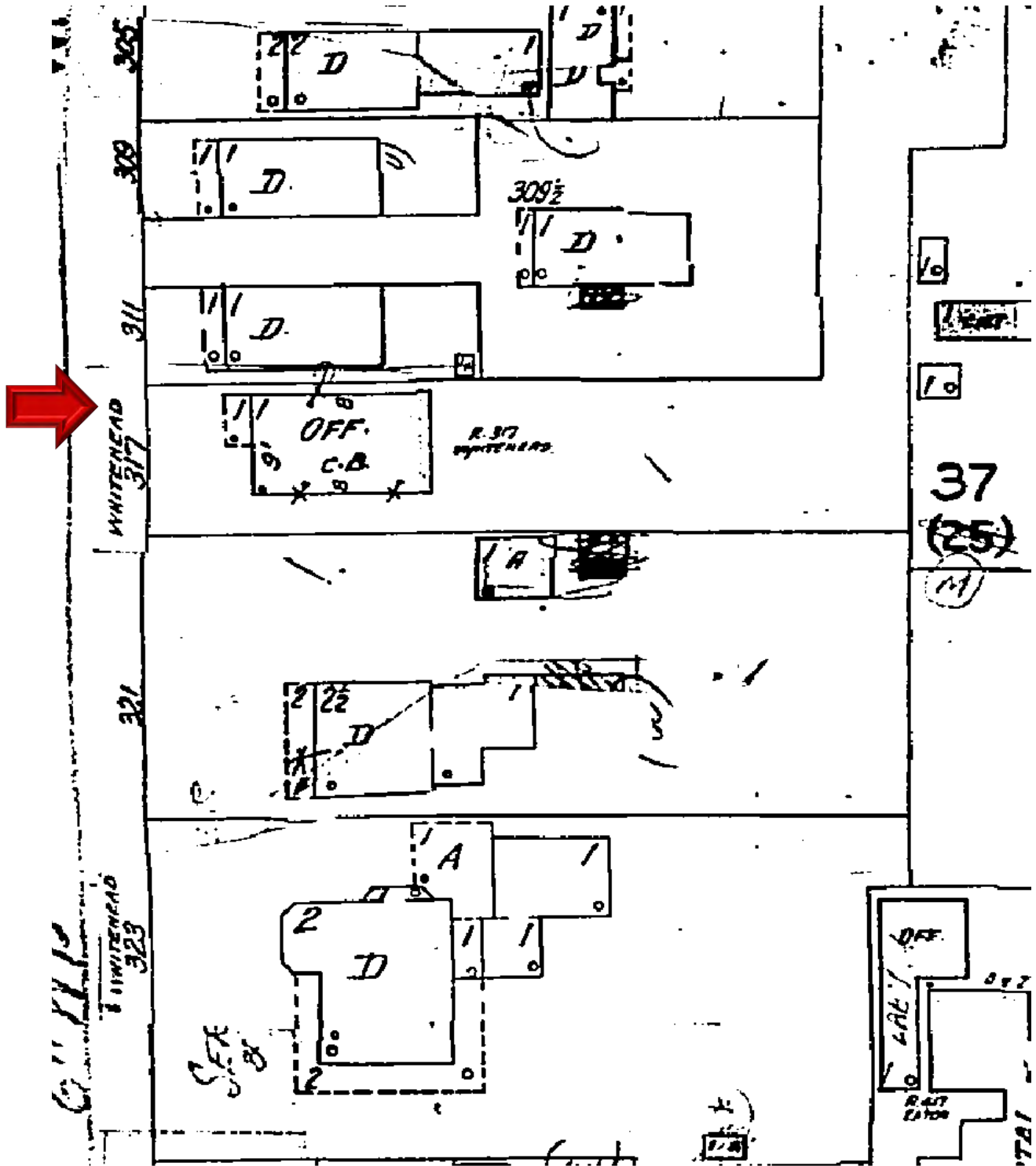

1962 Sanborn Map

PROJECT PHOTOS



311 Whitehead Street circa 1910. Monroe County Library.



1941 Aerial photo. Monroe County Library.



311 Whitehead Street. Monroe County Library.



317 Whitehead Street circa 1965. Monroe County Library.

309-317 WHITEHEAD ST.
HISTORICAL PHOTOS



311 WHITEHEAD STREET
(PART OF 317 NOW)



317 WHITEHEAD STREET

**317 WHITEHEAD ST.
EXISTING BUILDING PHOTOS**



**HISTORICAL BUILDING
FRONT SIDE VIEW**



**HISTORICAL BUILDING
LEFT SIDE VIEW**

**317 WHITEHEAD ST.
EXISTING BUILDING PHOTOS**



FRONT SIDE VIEW



**HISTORICAL BUILDING
REAR SIDE VIEW**

**317 WHITEHEAD ST.
EXISTING BUILDING PHOTOS**



LEFT SIDE VIEW



RIGHT SIDE VIEW

SURVEY

MAP OF BOUNDARY SURVEY

A PART OF LOT 3, SQUARE 25
WILLIAM A. WHITEHEAD'S MAP OF THE ISLAND OF KEY WEST
KEY WEST, MONROE COUNTY, FLORIDA

ADDRESS: 317 WHITEHEAD STREET
KEY WEST, FLORIDA 33040

CERTIFIED TO:
Michael R. Marceau
Spottswood, Spottswood, Spottswood & Sterling, PLLC
Chicago Title Insurance Company
Fidelity National Title Insurance Company

LEGAL DESCRIPTION:
On the Island of Key West, known on William A. Whitehead's map, delineated in February, A.D. 1829, as Part of Lot Three (3), in Square Twenty-Five (25), described by metes and bounds as follows: Beginning at a point on Whitehead Street, One Hundred Eighty-Five (185) feet from the corner of Caroline and Whitehead Streets; thence at right angles to Whitehead Street in a Northeasterly direction One Hundred (100) feet; thence at right angles in a Northwesterly direction Sixteen and One-Fourth (16.25) feet; thence at right angles in a Southwesterly direction Ten (10) feet; thence at right angles in a Northwesterly direction Sixteen and One-Fourth (16.25) feet; thence at right angles in a Southwesterly direction Ninety (90) feet to a point on Whitehead Street; thence at right angles in a Southeasterly direction along Whitehead Street Thirty-two and One-Half (32.50) feet to the Point of Beginning.

AND

On the Island of Key West, known on William A. Whitehead's map, delineated in February, A.D. 1829, as Part of Lot Three (3), in Square Twenty-Five (25), described by metes and bounds as follows: Commencing at a point on the Northeasterly side of Whitehead Street, distant One Hundred Eighty-Five (185) feet from the corner of the intersection of Whitehead Street and Caroline Street, and running thence at right angles to Whitehead Street in a Northeasterly direction One Hundred (100) feet; thence at right angles in a Southeasterly direction Thirty-Four (34) feet, Six (6) inches to the Northwesterly boundary of the land now owned by Virginia Lee Mock as described in deed recorded in Deed Book G-24, Pages 44 and 45, Monroe County, Florida Public Records; thence meandering the said Northwesterly boundary of the land of the said Virginia Lee Mock in a Southwesterly direction One Hundred (100) feet to Whitehead Street; thence in a Northwesterly direction along the Northeasterly line of Whitehead Street Thirty-Four (34) feet, Six (6) inches to the point or place of beginning.

SUBJECT TO (an easement for ingress and egress newly authored by the undersigned)

On the Island of Key West, Monroe County, Florida and being a part of Lot 3, Square 25, according to William A. Whitehead's Map of said Island, delineated in February, 1829 and being more particularly described as follows: COMMENCE at the intersection of the Northeasterly Right-of-Way Line of Whitehead Street and the Southeasterly Right of Way Line of Caroline Street; thence in a Southeasterly direction along the said Northeasterly Right-of-way line of Whitehead Street for 152.50 feet to the POINT OF BEGINNING; thence Northeasterly 90.00 feet; thence Southeasterly 5.00 feet; thence Southwesterly 90.00 feet; thence Northwesterly 5.00 feet to the Point of Beginning.

TOGETHER WITH (an easement for ingress and egress newly authored by the undersigned)

On the Island of Key West, Monroe County, Florida and being a part of Lot 3, Square 25, according to William A. Whitehead's Map of said Island, delineated in February, 1829 and being more particularly described as follows: COMMENCE at the intersection of the Northeasterly Right-of-Way Line of Whitehead Street and the Southeasterly Right of Way Line of Caroline Street; thence in a Southeasterly direction along the said Northeasterly Right-of-Way line of Whitehead Street for 152.50 feet to the POINT OF BEGINNING; thence Northeasterly 90.00 feet; thence Northwesterly 5.00 feet; thence Southwesterly 90.00 feet; thence Southeasterly 5.00 feet to the Point of Beginning.

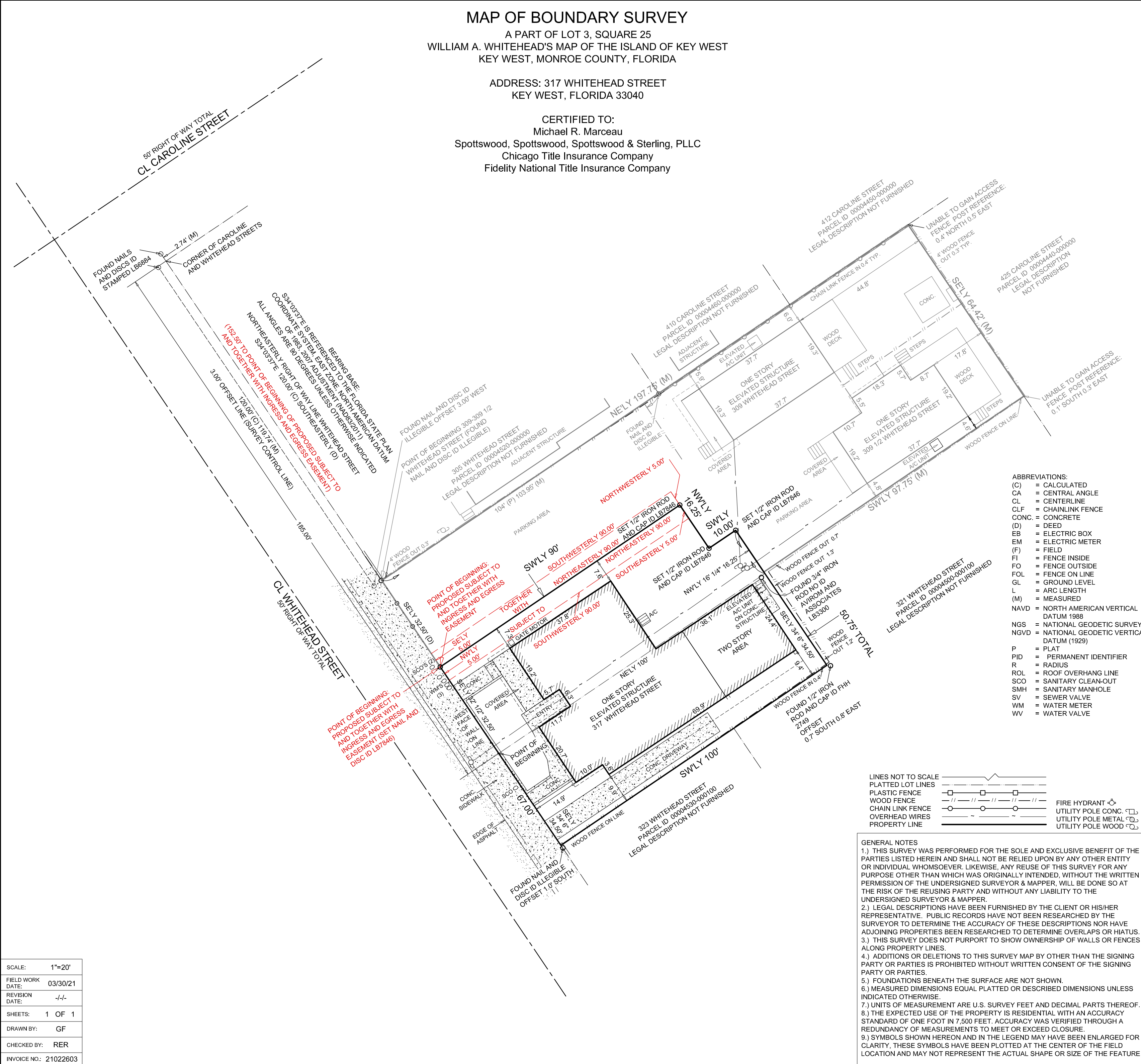

ABBREVIATIONS:

(C)	= CALCULATED
CA	= CENTRAL ANGLE
CL	= CENTERLINE
CLF	= CHAINLINK FENCE
CONC.	= CONCRETE
(D)	= DEED
EB	= ELECTRIC BOX
EM	= ELECTRIC METER
(F)	= FIELD
FI	= FENCE INSIDE
FO	= FENCE OUTSIDE
FOL	= FENCE ON LINE
GL	= GROUND LEVEL
L	= ARC LENGTH
(M)	= MEASURED
NAV D	= NORTH AMERICAN VERTICAL DATUM 1988
NGS	= NATIONAL GEODETIC SURVEY DATUM (1929)
NGVD	= NATIONAL GEODETIC VERTICAL DATUM (1929)
P	= PLAT
PID	= PERMANENT IDENTIFIER
R	= RADIUS
ROL	= ROOF OVERHANG LINE
SCO	= SANITARY CLEAN-OUT
SMH	= SANITARY MANHOLE
SV	= SEWER VALVE
WM	= WATER METER
WV	= WATER VALVE

GENERAL NOTES

- 1.) THIS SURVEY WAS PERFORMED FOR THE SOLE AND EXCLUSIVE BENEFIT OF THE PARTIES LISTED HEREIN AND SHALL NOT BE RELIED UPON BY ANY OTHER ENTITY OR INDIVIDUAL WHOMSOEVER. LIKEWISE, ANY REUSE OF THIS SURVEY FOR ANY PURPOSE OTHER THAN WHICH WAS ORIGINALLY INTENDED, WITHOUT THE WRITTEN PERMISSION OF THE UNDERSIGNED SURVEYOR & MAPPER, WILL BE DONE SO AT THE RISK OF THE REUSING PARTY AND WITHOUT ANY LIABILITY TO THE UNDERSIGNED SURVEYOR & MAPPER.
- 2.) LEGAL DESCRIPTIONS HAVE BEEN FURNISHED BY THE CLIENT OR HIS/HER REPRESENTATIVE. PUBLIC RECORDS HAVE NOT BEEN RESEARCHED BY THE SURVEYOR TO DETERMINE THE ACCURACY OF THESE DESCRIPTIONS NOR HAVE ADJOINING PROPERTIES BEEN RESEARCHED TO DETERMINE OVERLAPS OR HIATUS.
- 3.) THIS SURVEY DOES NOT PURPORT TO SHOW OWNERSHIP OF WALLS OR FENCES ALONG PROPERTY LINES.
- 4.) ADDITIONS OR DELETIONS TO THIS SURVEY MAP BY OTHER THAN THE SIGNING PARTY OR PARTIES IS PROHIBITED WITHOUT WRITTEN CONSENT OF THE SIGNING PARTY OR PARTIES.
- 5.) FOUNDATIONS BENEATH THE SURFACE ARE NOT SHOWN.
- 6.) MEASURED DIMENSIONS EQUAL PLATTED OR DESCRIBED DIMENSIONS UNLESS INDICATED OTHERWISE.
- 7.) UNITS OF MEASUREMENT ARE U.S. SURVEY FEET AND DECIMAL PARTS THEREOF.
- 8.) THE EXPECTED USE OF THE PROPERTY IS RESIDENTIAL WITH AN ACCURACY STANDARD OF ONE FOOT IN 7,500 FEET. ACCURACY WAS VERIFIED THROUGH A REDUNDANCY OF MEASUREMENTS TO MEET OR EXCEED CLOSURE.
- 9.) SYMBOLS SHOWN HEREON AND IN THE LEGEND MAY HAVE BEEN ENLARGED FOR CLARITY, THESE SYMBOLS HAVE BEEN PLOTTED AT THE CENTER OF THE FIELD LOCATION AND MAY NOT REPRESENT THE ACTUAL SHAPE OR SIZE OF THE FEATURE

REECE & ASSOCIATES
PROFESSIONAL SURVEYORS AND MAPPERS
LICENSED BUSINESS (LB) NO. 7846
127 INDUSTRIAL ROAD, BIG PINE KEY, FL. 33043
OFFICE (305) 872 - 1348
EMAIL: INFO@RECEESURVEYING.COM

I HEREBY CERTIFY THAT THIS SURVEY WAS MADE UNDER MY RESPONSIBLE CHARGE AND MEETS THE STANDARDS OF PRACTICE AS SET FORTH BY THE FLORIDA BOARD OF PROFESSIONAL SURVEYORS AND MAPPERS IN CHAPTER 5J-17, FLORIDA ADMINISTRATIVE CODE, PURSUANT TO SECTION 472.027, FLORIDA STATUTES. THIS SURVEY, WHEN SCHEDULE B HAS BEEN PROVIDED MEETS THE PROVISIONS OF FLORIDA ENDORSEMENT FORM 9, SUBPARAGRAPH 1(B) 1 (SETBACKS), 1(B)3 (ENCROACHMENTS), & 1(B)4 (EASEMENTS), SCHEDULE "B" HAS NOT BEEN PROVIDED.

SIGNED:  ROBERT E. REECE
PROFESSIONAL SURVEYOR AND MAPPER
FLORIDA LICENSE NO. LS 5632

NOT VALID WITHOUT THE SIGNATURE AND THE ORIGINAL RAISED SEAL OF A FLORIDA SURVEYOR AND MAPPER

SCALE:	1"=20'
FIELD WORK DATE:	03/30/21
REVISION DATE:	-/-
SHEETS:	1 OF 1
DRAWN BY:	GF
CHECKED BY:	RER
INVOICE NO.:	21022603

PROPOSED DESIGN

HARC PERMIT PLANS FOR 317 WHITEHEAD ST

SITE LOCATION



LOCATION MAP

PROJECT LOCATION:
317 WHITEHEAD ST,
KEY WEST, FL 33040

CLIENT:

MICHAEL R MARCEAU

REV	DESCRIPTION	BY	DATE
STATUS: FINAL			
ARTIBUS DESIGN 3710 N. ROSSEVELLY BLVD KEY WEST, FL 33040 (305) 304-3312 WWW.ARTIBUSDESIGN.COM CA # 30835			
THIS DRAWING IS NOT VALID WITHOUT THE SIGNATURE AND ORIGINAL SEAL.			
SIGNATURE: _____			
DATE: _____			
DESIGNER: MICHAEL R MARCEAU PROJECT: 317 WHITEHEAD ST TITLE: EXISTING SITE PLAN			
SCALE	DATE	DESIGN	CHECKED
AS SHOWN	09/29/21	CA	SMH
PROJECT NO.	DRAWING NO.	SHEET NO.	TOTAL SHEETS
2106-01	S-100	1	1
BRUCE MASHITACOV PROFESSIONAL ENGINEER STATE OF FLORIDA LICENSE NO 71480			

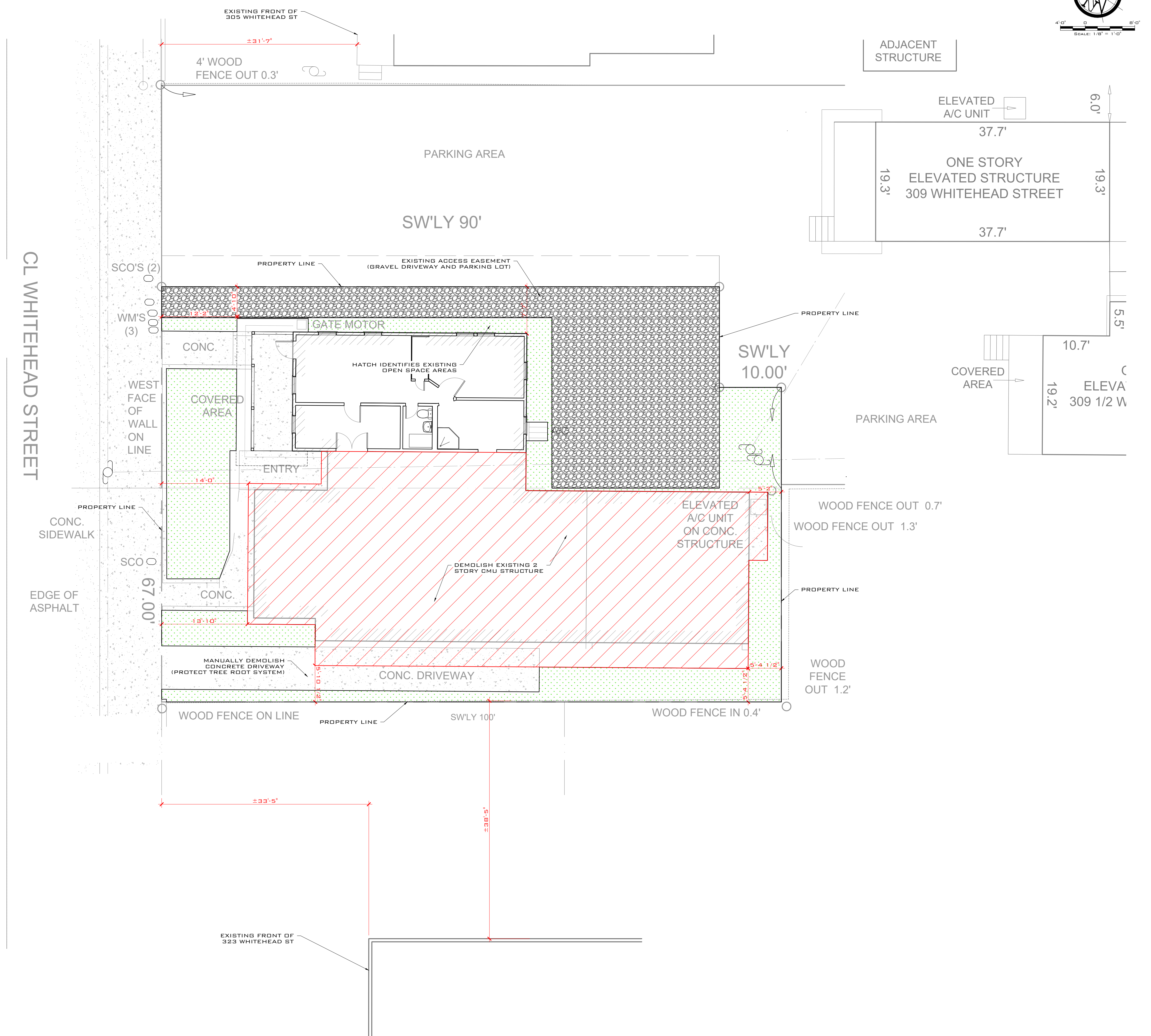
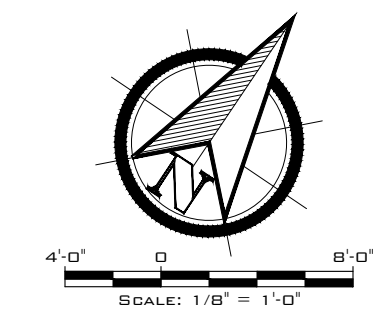

EXISTING SITE PLAN / DEMO
SCALE: 1/8" = 1'-0"

REV	DESCRIPTION	BY	DATE
STATUS: FINAL			
ARTIBUS DESIGN ENGINEERING AND PLANNING			
ARTIBUS DESIGN 3710 N. ROOSEVELT BLVD KEY WEST, FL 33040 (305) 304-3312 WWW.ARTIBUSDESIGN.COM CA # 30835			
DESIGNER	MICHAEL R MARCEAU		
PROJECT	317 WHITEHEAD ST		
DATE	317 WHITEHEAD ST KEY WEST, FL 33040		
TITLE	EXISTING SITE PLAN		
SIGNATURE		DATE	
DATE			
BRUCE MASHATAKY PROFESSIONAL ENGINEER STATE OF FLORIDA LICENSE NO. 71480			
PROJECT NO.	2106-01	DATE	09/29/21
SCALE	C-101	BY	SAH
REVISION			

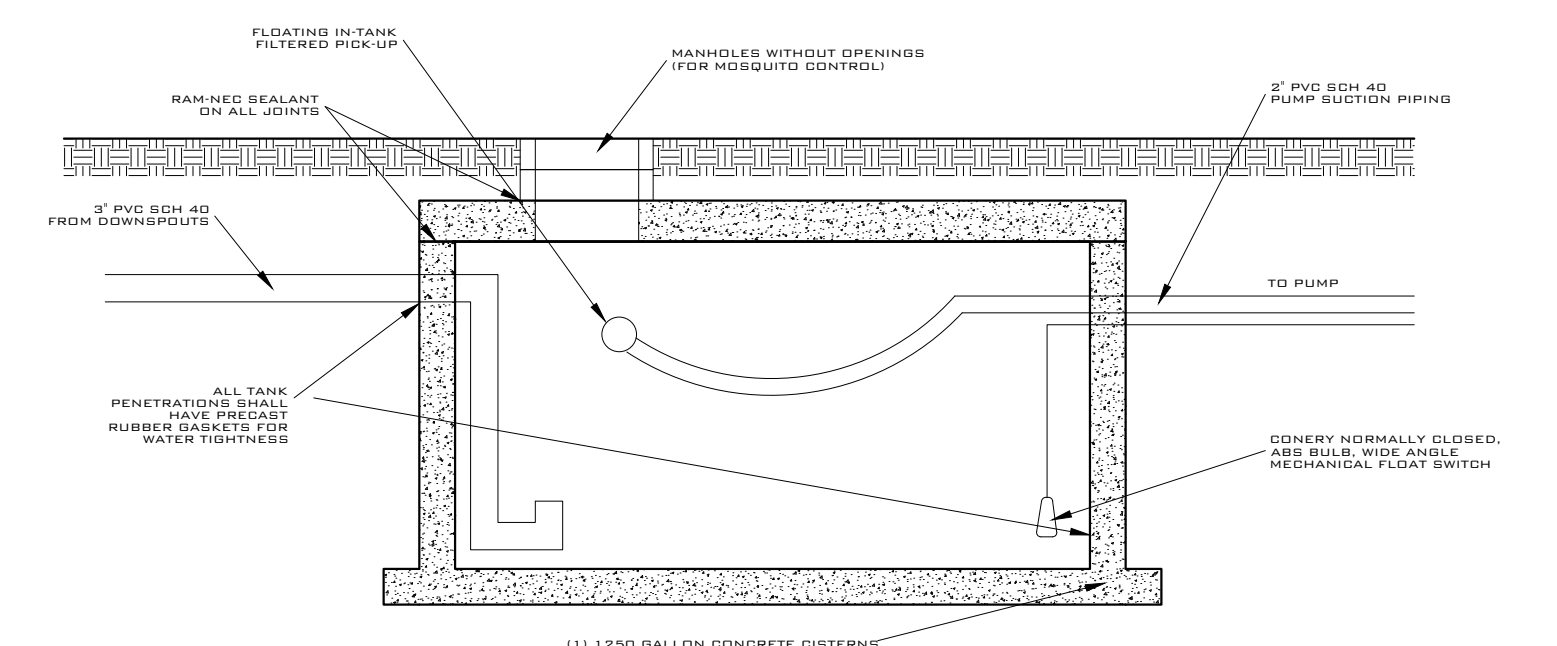
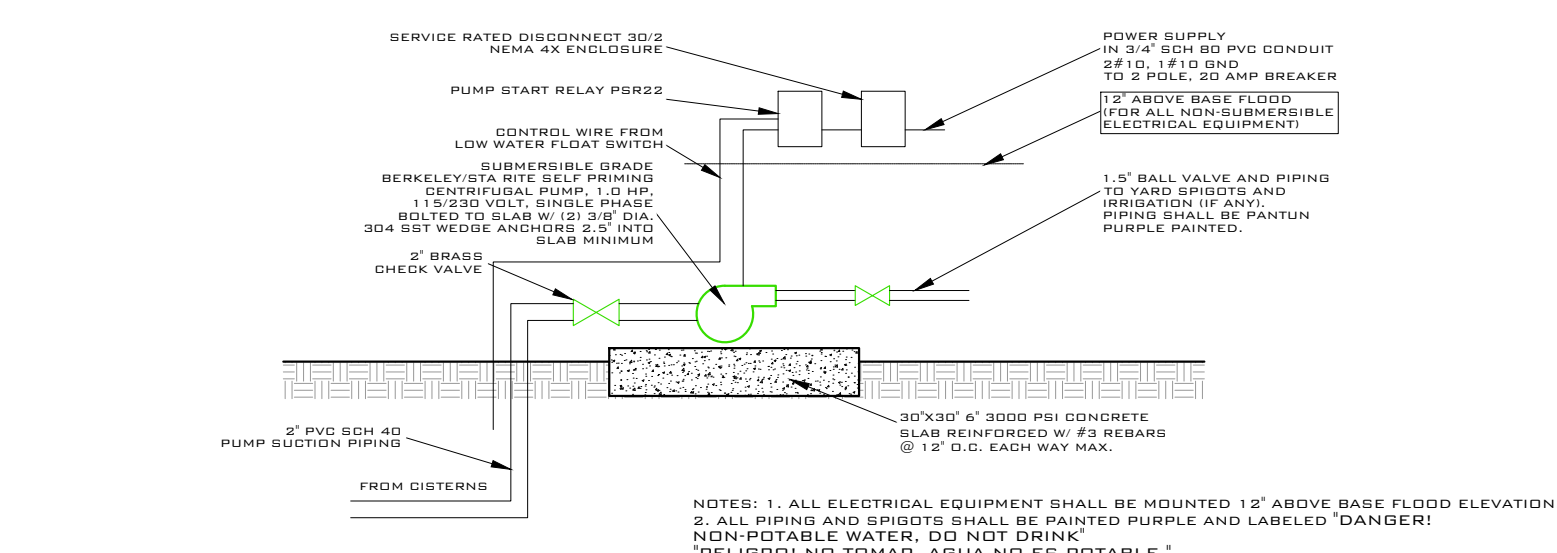
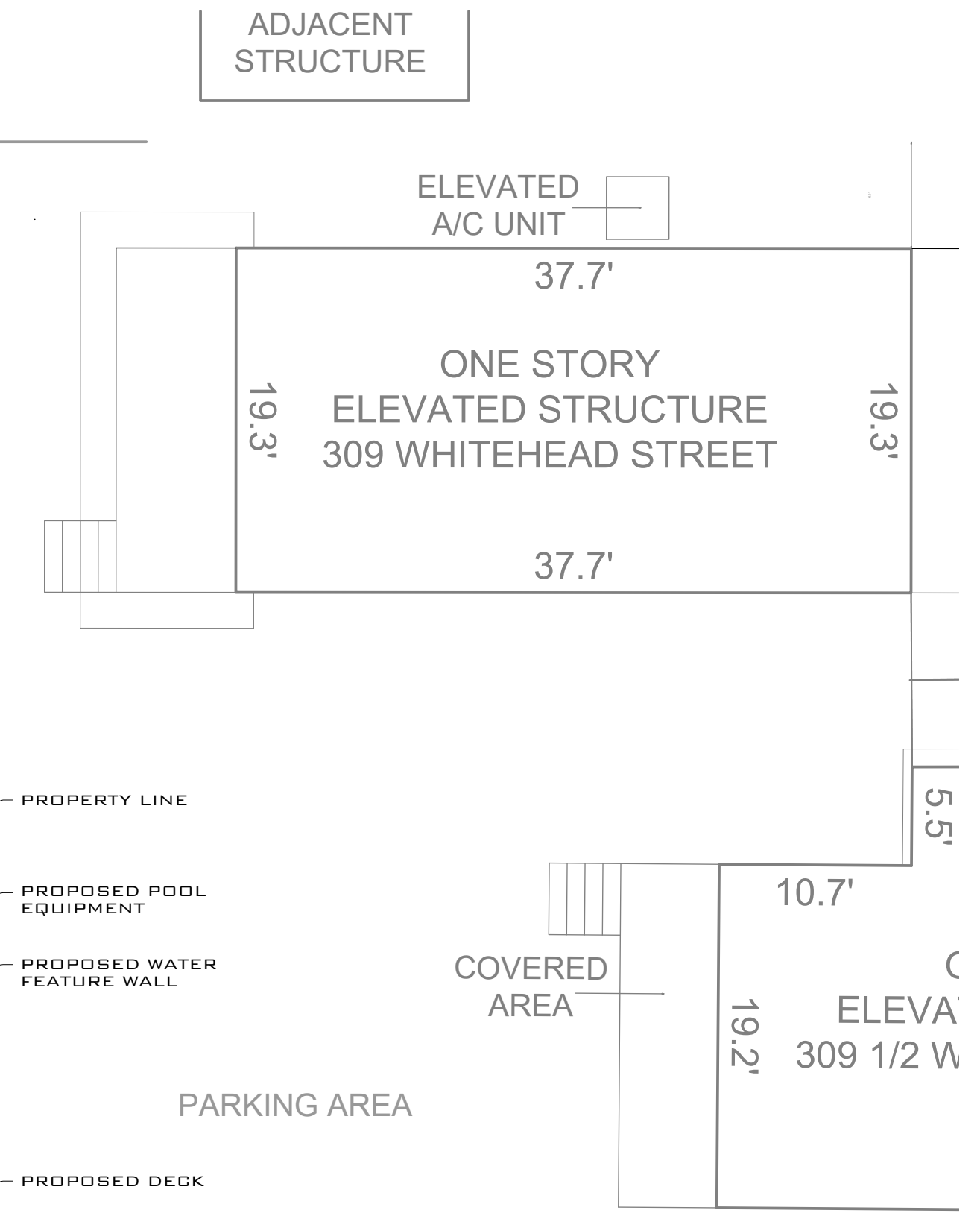
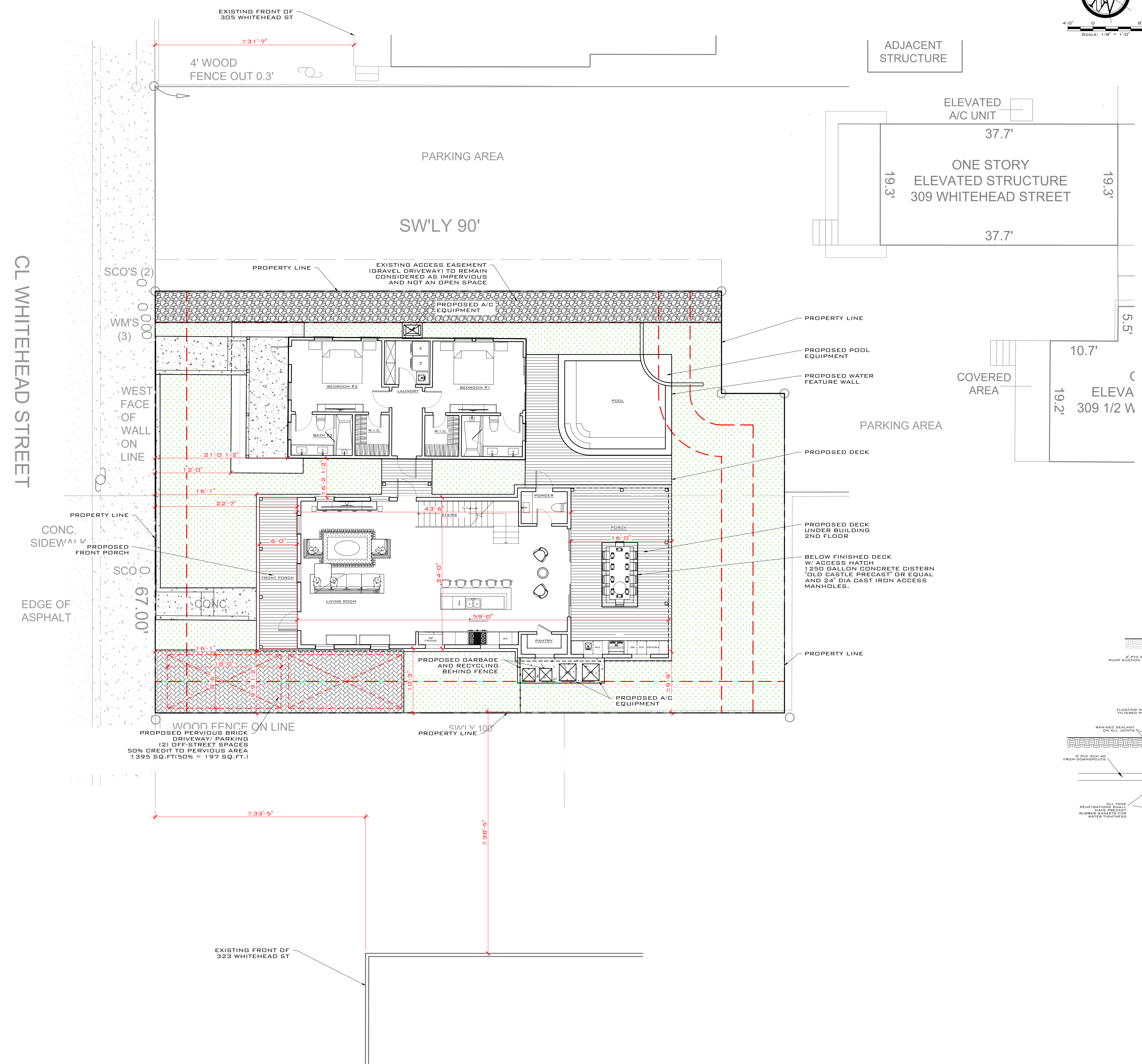
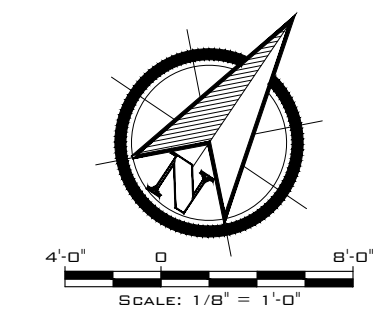

RAIN WATER HARVESTING SYSTEM SCHEMATICS
SCALE: NTS

PROPOSED SITE PLAN
SCALE: 1/8" = 1'-0"

REV. DESCRIPTION	BY	DATE
FINAL		
ARTIBUS DESIGN ENGINEERING AND PLANNING 3710 N. ROOSEVELT BLVD KEY WEST, FL 33040 (305) 304-3312 WWW.ARTIBUSDESIGN.COM CA # 30835		
DESIGNER	MICHAEL R MARCEAU	
PROJECT	317 WHITEHEAD ST	
SITE	317 WHITEHEAD ST	
TITLE	PROPOSED SITE PLAN	
SIGNATURE		
DATE	AS SHOWN 09/29/21	SCALE: 1/8" = 1'-0"
PROJECT NO.	2106-01	DATE: 09/29/21
	C-102	BY: SAH
		REVISION: 1
BRUCE MASHATZKY PROFESSIONAL ENGINEER STATE OF FLORIDA LICENSE NO. 71480		

THIS DRAWING IS NOT VALID WITHOUT THE SIGNATURE AND ORIGINAL SEAL.

SITE DATA:

TOTAL SITE AREA: ±6,537.39 SQ.FT

LAND USE: HRO
FLOOD ZONE: AE6

SETBACKS

FRONT:
REQUIRED 5'-0"
EXISTING 13'-6-1/2"
PROPOSED NO CHANGES

LEFT SIDE:
REQUIRED 5'-0"
EXISTING 4'-10"
PROPOSED NO CHANGES

RIGHT SIDE:
REQUIRED 5'-0"
EXISTING 5'-4-1/2"
PROPOSED ±6'-7"
IMPROVEMENT

REAR:
REQUIRED 10 FT
EXISTING 5'-2"
PROPOSED ±17'-11"
IMPROVEMENT

MAXIMUM IMPERVIOUS SURFACE RATIO:

REQUIRED: 60% (3,922.43 SQ.FT.)
EXISTING 79.81% (±5,517.89 SQ.FT.)
PROPOSED 58.43% (±3,820.39 SQ.FT.)
IMPROVEMENT

MAXIMUM BUILDING COVERAGE:

REQUIRED 50% (3,268.69 SQ.FT.)
EXISTING 52.21% (±3,413.7 SQ.FT.)
PROPOSED 41.68% (±2,725.0 SQ.FT.)
IMPROVEMENT

OPEN SPACE MINIMUM:

REQUIRED 35% (2,288.08 SQ.FT.)
EXISTING 20.18% (±1,319.5 SQ.FT.)
PROPOSED 35.07% (±2,293.0 SQ.FT.)
IMPROVEMENT

NO BUILDING ADDITIONAL COVERAGE
TO THE REAR SETBACK IS PROPOSED
NO CALCULATIONS ARE PROVIDED

REV	DESCRIPTION	BY	DATE
STATUS:	FINAL		
 ARTIBUS DESIGN ENGINEERING AND PLANNING			
3710 N. ROOSEVELT BLVD KEY WEST, FL 33040 (305) 304-3312 WWW.ARTIBUSDESIGN.COM CA # 30835			
DESIGNER:	MICHAEL R MARCEAU		
PROJECT:	317 WHITEHEAD ST		
DATE:	317 WHITEHEAD ST KEY WEST, FL 33040		
TITLE:	SITE DATA		
SIGNATURE:			
DATE:			
SCALE:			
PROJECT NO:	2106-01	DATE:	09/29/21
DESIGNER:	DA	CHECKED:	SAH
DRAWN:		DATE:	
SCALE:		PROJECT NO:	
STATE OF FLORIDA		PROFESSIONAL ENGINEER	
LICENSE NO 71480			

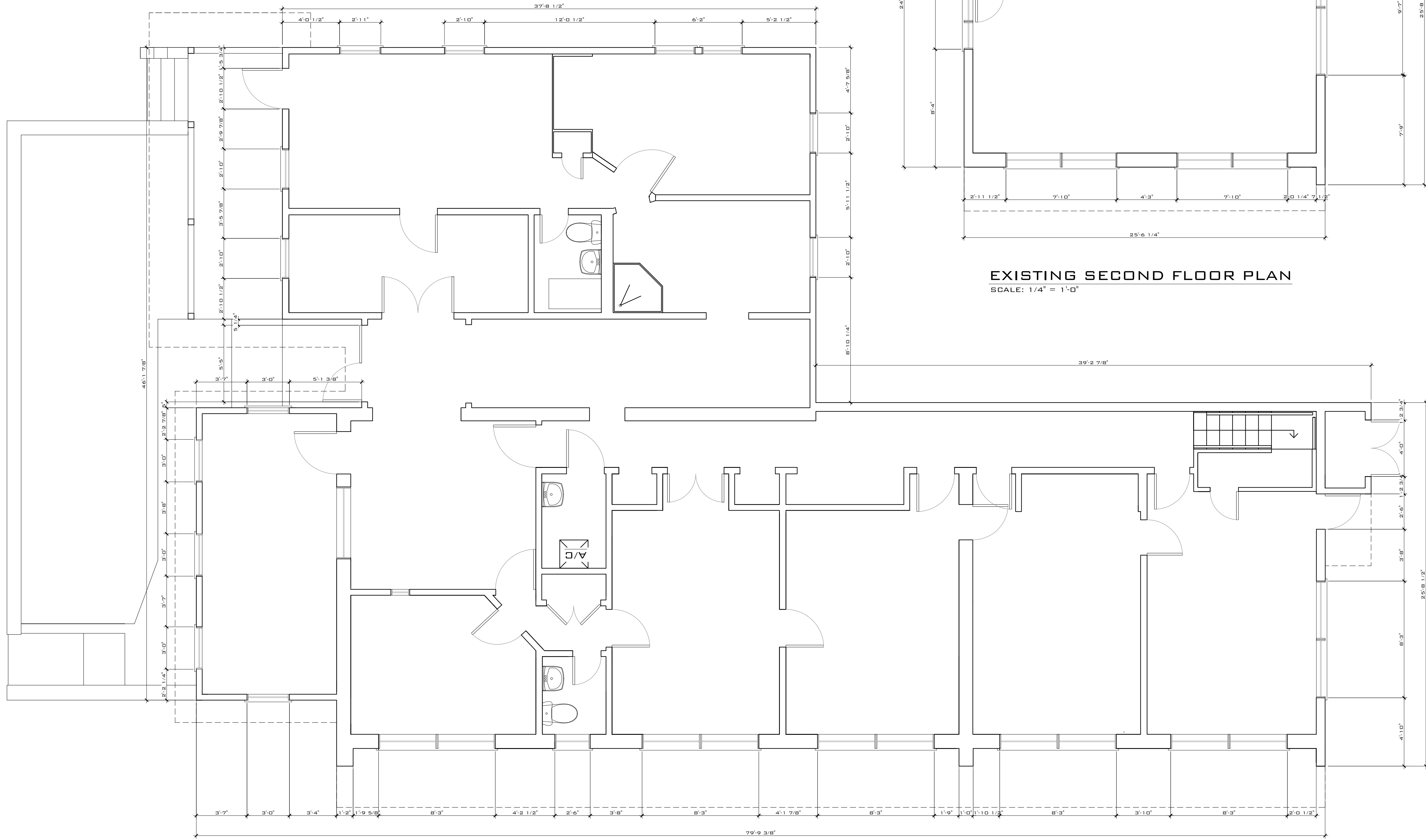

EXISTING FIRST FLOOR PLAN
SCALE: 1/4" = 1'-0"

EXISTING SECOND FLOOR PLAN
SCALE: 1/4" = 1'-0"

THIS DRAWING IS NOT VALID WITHOUT THE SIGNATURE AND ORIGINAL SEAL.

REV	DESCRIPTION	BY	DATE
FINAL			
ARTIBUS DESIGN ENGINEERING AND PLANNING 3710 N. ROOSEVELT BLVD KEY WEST, FL 33040 (305) 304-3312 WWW.ARTIBUSDESIGN.COM CA # 30835			
DESIGNER	MICHAEL R MARCEAU		
PROJECT	317 WHITEHEAD ST		
DATE	317 WHITEHEAD ST		
TITLE	EXISTING FLOOR PLANS		
DATE	DATE	DATE	DATE
AS SHOWN	09/29/21	DA	SAH
2106-01	A-101		1
BRUCE MASHUTACOV PROFESSIONAL ENGINEER STATE OF FLORIDA LICENSE NO 71480			

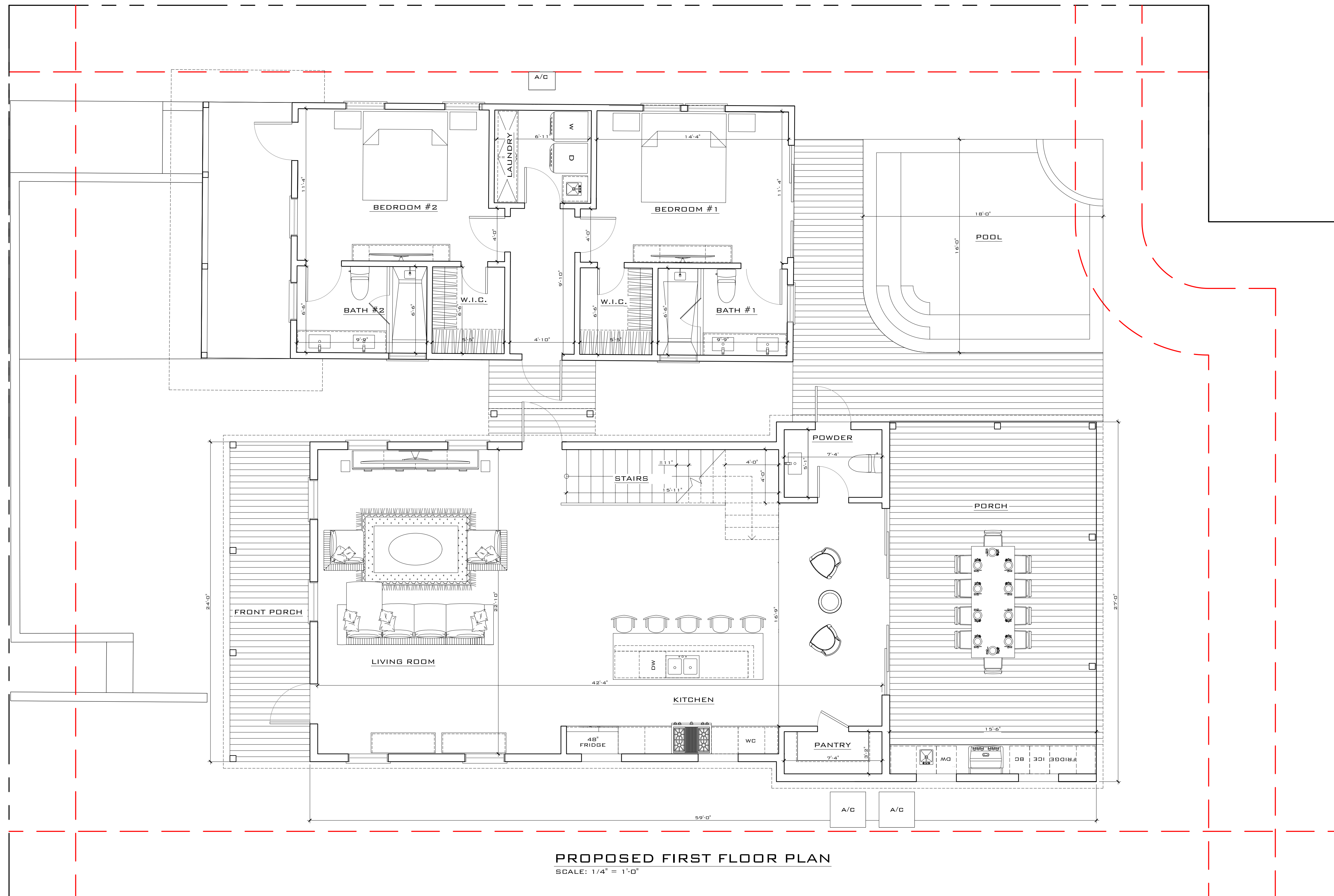

PROPOSED FIRST FLOOR PLAN
 SCALE: 1/4" = 1'-0"

THIS DRAWING IS NOT VALID WITHOUT THE SIGNATURE AND ORIGINAL SEAL.

SIGNATURE: _____
 DATE: _____

BRUCE MASHITACOV
 PROFESSIONAL ENGINEER
 STATE OF FLORIDA
 LICENSE NO. 71480

REV. DESCRIPTION	BY	DATE
FINAL		
ARTIBUS DESIGN ENGINEERING AND PLANNING 3710 N. ROOSEVELT BLVD KEY WEST, FL 33040 (305) 304-3312 WWW.ARTIBUSDESIGN.COM CA # 30835		
DESIGNER	MICHAEL R MARCEAU	
PROJECT	317 WHITEHEAD ST	
DATE	317 WHITEHEAD ST KEY WEST, FL 33040	
TITLE	PROPOSED FLOOR PLAN	
DATE	DATE	DATE
AS SHOWN	09/29/21	04
REVISION	09/29/21	04
2106-01	A-102	1

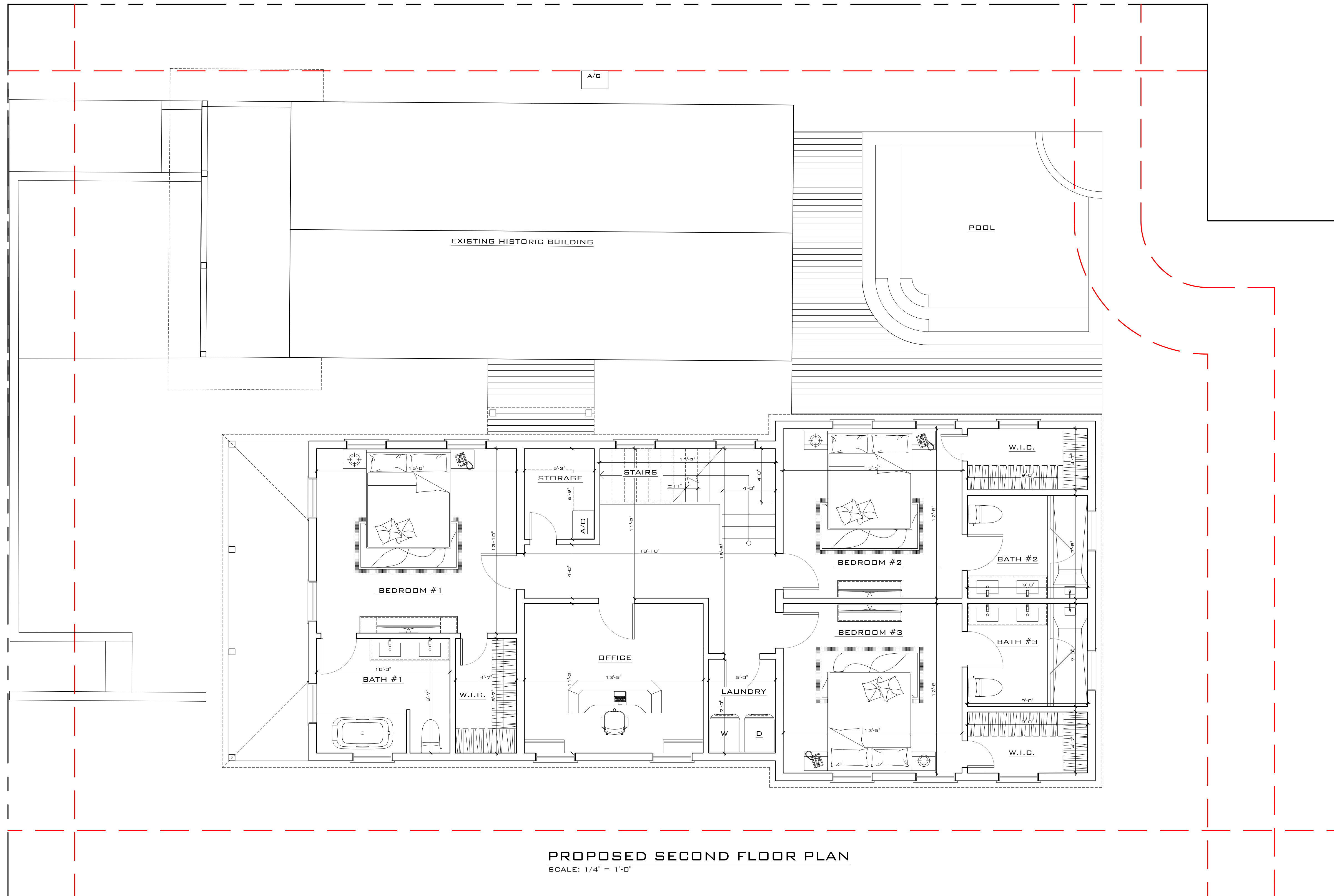

PROPOSED SECOND FLOOR PLAN
 SCALE: 1/4" = 1'-0"

THIS DRAWING IS NOT VALID WITHOUT THE SIGNATURE AND ORIGINAL SEAL.

SIGNATURE: _____
 DATE: _____

BRUCE MASHATAKY
 PROFESSIONAL ENGINEER
 STATE OF FLORIDA
 LICENSE NO. 71480

REV. DESCRIPTION	BY	DATE
STATUS: FINAL		
ARTIBUS DESIGN ENGINEERING AND PLANNING		
ARTIBUS DESIGN 3710 N. ROOSEVELT BLVD KEY WEST, FL 33040 (305) 304-3312 WWW.ARTIBUSDESIGN.COM CA # 30835		
DESIGNER:	MICHAEL R MARCEAU	
PROJECT:	317 WHITEHEAD ST	
DATE:	317 WHITEHEAD ST KEY WEST, FL 33040	
TITLE:	PROPOSED FLOOR PLAN	
DESIGNER/DATE:	DATE:	DESIGN/DATE:
AS SHOWN: 09/29/21	CA	SAM
PROJECT NO.: 2106-01	ISSUED FOR:	REVISION:
A-103		1



EXISTING WHITEHEAD SIDE STREETSCAPES
SCALE: 1/8" = 1'-0"



PROPOSED WHITEHEAD SIDE STREETSCAPES
SCALE: 1/8" = 1'-0"

THIS DRAWING IS NOT VALID WITHOUT THE SIGNATURE AND ORIGINAL SEAL.

SIGNATURE: _____
DATE: _____

BRUCE MASHITACOV
PROFESSIONAL ENGINEER
STATE OF FLORIDA
LICENSE NO. 71480

REV. DESCRIPTION	BY	DATE
FINAL		
ARTIBUS DESIGN ENGINEERING AND PLANNING 3710 N. ROOSEVELT BLVD KEY WEST, FL 33040 (305) 304-3312 WWW.ARTIBUSDESIGN.COM CA # 30835		
DESIGNER	MICHAEL R MARCEAU	
PROJECT	317 WHITEHEAD ST	
DATE	317 WHITEHEAD ST KEY WEST, FL 33040	
TITLE	STREETSCAPES	
DATE	DATE	DATE
AS SHOWN	09/29/21	CA
PROJECT NO.	2106-01	REVISION
	A-104	1



EXISTING FRONT ELEVATION
SCALE: 1/4" = 1'-0"



EXISTING REAR ELEVATION
SCALE: 1/4" = 1'-0"



PROPOSED FRONT ELEVATION
SCALE: 1/4" = 1'-0"

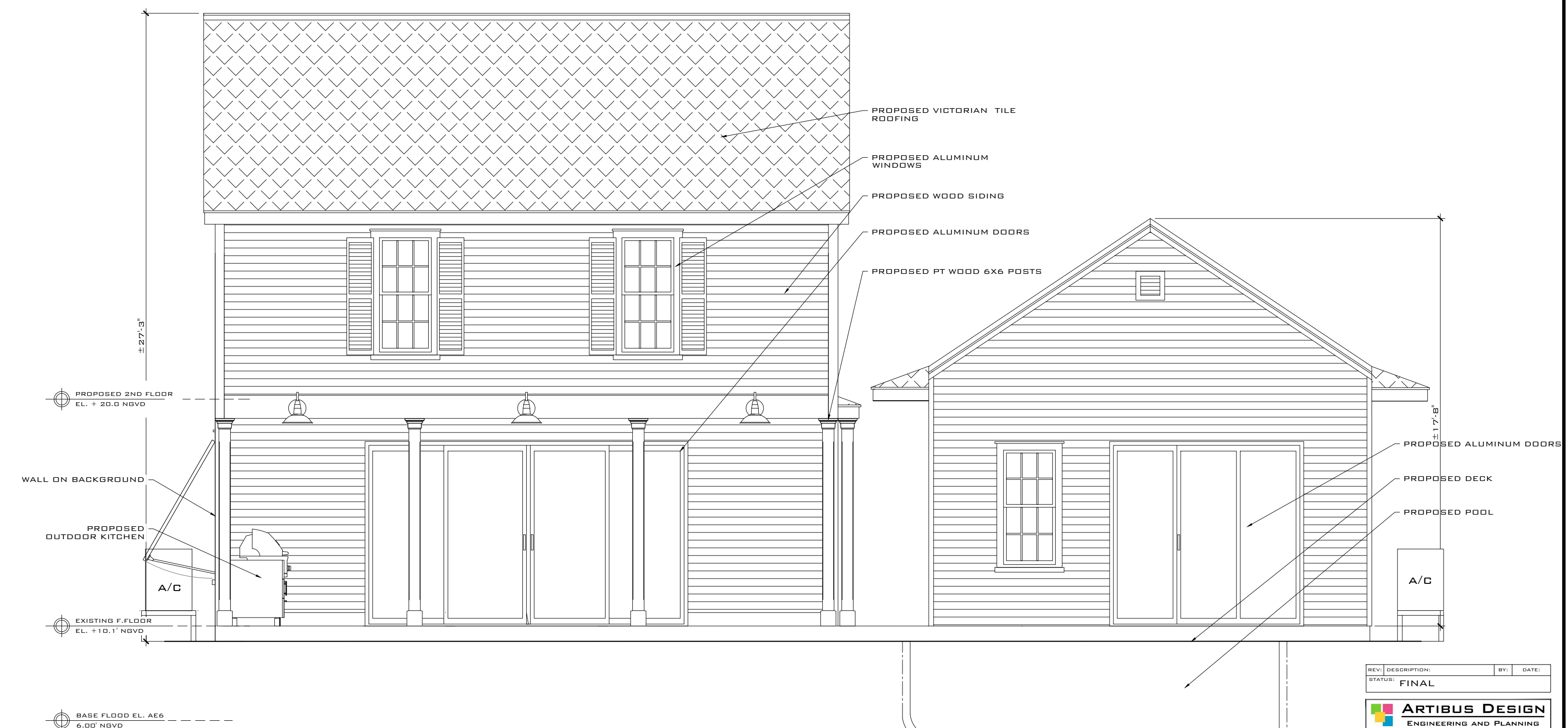

PROPOSED REAR ELEVATION
SCALE: 1/4" = 1'-0"

REV.	DESCRIPTION	BY	DATE
1	FINAL		

ARTIBUS DESIGN
ENGINEERING AND PLANNING
3710 N. ROOSEVELT BLVD
KEY WEST, FL 33040
(305) 304-3312
WWW.ARTIBUSDESIGN.COM
CA # 30835

DESIGNER: **MICHAEL R MARCEAU**

PROJECT: **317 WHITEHEAD ST**

DATE: **317 WHITEHEAD ST**

TITLE: **PROPOSED ELEVATIONS**

THIS DRAWING IS NOT VALID WITHOUT THE SIGNATURE AND ORIGINAL SEAL.

SIGNATURE: _____
DATE: _____
SEAL: _____
PROFESSIONAL ENGINEER
STATE OF FLORIDA
LICENSE NO. 71480

DATE	BY	CHKD.	DATE	BY	CHKD.
2106-01	A-105		09/29/21	CA	SAM

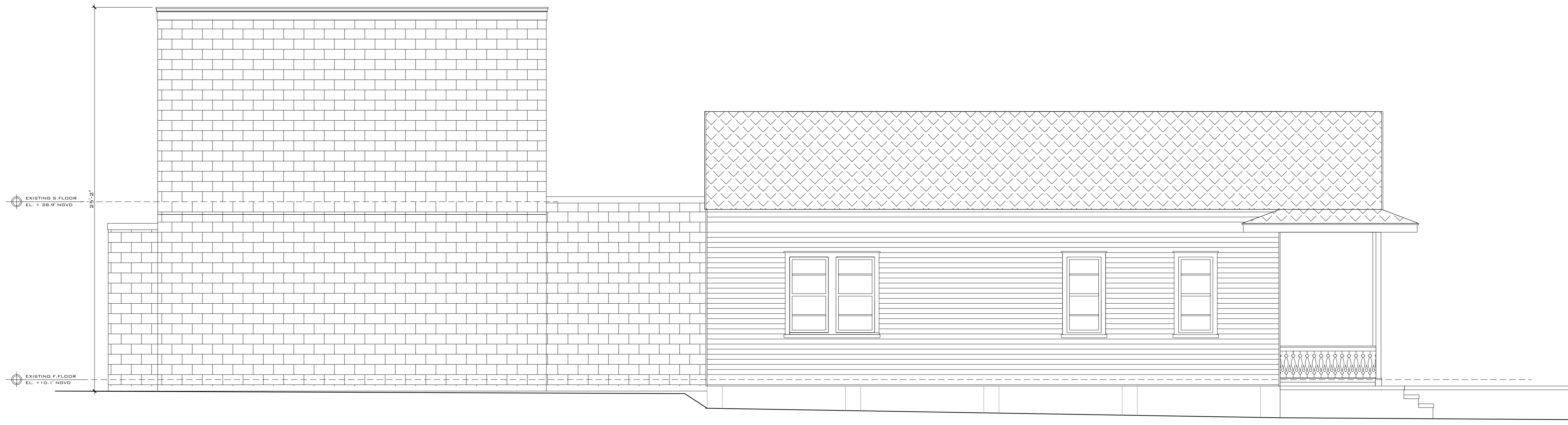

EXISTING LEFT ELEVATION
SCALE: 1/4" = 1'-0"



PROPOSED LEFT ELEVATION
SCALE: 1/4" = 1'-0"

THIS DRAWING IS NOT VALID WITHOUT THE SIGNATURE AND ORIGINAL SEAL.

SIGNATURE: _____
DATE: _____
BRUCE MASHYAKOV
PROFESSIONAL ENGINEER
STATE OF FLORIDA
LICENSE NO. 71480

REV	DESCRIPTION	BY	DATE
01	FINAL		

ARTIBUS DESIGN
ENGINEERING AND PLANNING

3710 N. ROOSEVELT BLVD
KEY WEST, FL 33040
(305) 304-3312
WWW.ARTIBUSDESIGN.COM
CA # 30835

DESIGNER: MICHAEL R MARCEAU
PROJECT: 317 WHITEHEAD ST
SITE: 317 WHITEHEAD ST
KEY WEST, FL 33040
TITLE: PROPOSED ELEVATIONS

DATE	SCALE	TITLE	DATE	DESIGN	DATE	DESIGN
2106-01	A-106	PROPOSED ELEVATIONS	09/29/21	DA	09/29/21	DA

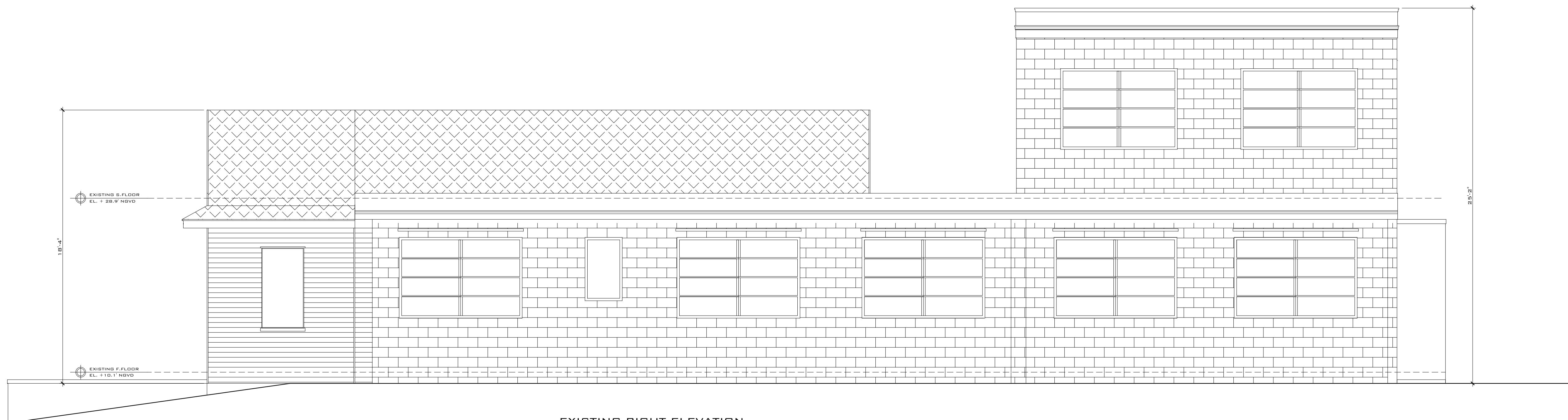

EXISTING RIGHT ELEVATION
SCALE: 1/4" = 1'-0"



PROPOSED RIGHT ELEVATION
SCALE: 1/4" = 1'-0"

REV	DESCRIPTION	BY	DATE
	FINAL		

ARTIBUS DESIGN
ENGINEERING AND PLANNING

ARTIBUS DESIGN
3710 N. ROOSEVELT BLVD
KEY WEST, FL 33040
(305) 304-3312
WWW.ARTIBUSDESIGN.COM
CA # 30835

DESIGNER: MICHAEL R MARCEAU

PROJECT: 317 WHITEHEAD ST

DATE: 317 WHITEHEAD ST
KEY WEST, FL 33040

TITLE: PROPOSED ELEVATIONS

DATE	BY	DATE	BY	DATE	BY
2106-01	AS SHOWN	09/29/21	DA	09/29/21	DA

SIGNATURE: _____
DATE: _____
BRUCE MASHATAKY
PROFESSIONAL ENGINEER
STATE OF FLORIDA
LICENSE NO. 71480



PROPOSED LEFT ELEVATION
(ONLY NEW STRUCTURE SHOWN)
 SCALE: 1/4" = 1'-0"

REV.	DESCRIPTION	BY	DATE
	FINAL		

ARTIBUS DESIGN
 ENGINEERING AND PLANNING

ARTIBUS DESIGN
 3710 N. ROOSEVELT BLVD
 KEY WEST, FL 33040
 (305) 304-3312
 WWW.ARTIBUSDESIGN.COM
 CA # 30835

DESIGNER: MICHAEL R MARCEAU
 PROJECT: 317 WHITEHEAD ST

DATE: 317 WHITEHEAD ST
 KEY WEST, FL 33040
 TITLE: PROPOSED ELEVATIONS

DATE:	DESIGNED BY:	DATE:	DESIGN:	DATE:	CHECK:	DATE:
2106-01	AS SHOWN	09/29/21	DA	09/29/21	DA	09/29/21

BRUCE MASHITACOV
 PROFESSIONAL ENGINEER
 STATE OF FLORIDA
 LICENSE NO. 71480

THIS DRAWING IS NOT VALID WITHOUT THE SIGNATURE AND ORIGINAL SEAL.

SIGNATURE:

NOTICING

Public Meeting Notice

The Historic Architectural Review Commission will hold a public meeting at **5:00 p.m., October 27, 2021 at City Hall, 1300 White Street**, Key West, Florida. In order to view the live feed of the meeting, you can tune in to Comcast channel 77, AT&T Uverse channel 99, or type this link into your browser:

http://keywestcity.granicus.com/MediaPlayer.php?publish_id=1&embed=1 If you wish to participate virtually, please contact HARC staff at 305-809-3975. The purpose of the hearing will be to consider a request for:

RENOVATIONS TO HISTORIC ONE-STORY WOOD FRAME STRUCTURE. CONSTRUCTION OF NEW TWO-STORY WOOD FRAME STRUCTURE TO REPLACE EXISTING CMU STRUCTURE. SITE IMPROVEMENTS. DEMOLITION OF CMU STRUCTURE. DEMOLITION OF CONNECTION TO HISTORIC ONE-STORY WOOD FRAME STRUCTURE.

#317 WHITEHEAD STREET

Applicant – Artibus Design

Application #H2021-0050

If you wish to see the application or have any questions, you may visit the Planning Department during regular office hours at 1300 White Street, call 305-809-3973 or visit our website at www.cityofkeywest-fl.gov.

THIS NOTICE CAN NOT BE REMOVED FROM THE SITE UNTIL HARC FINAL DETERMINATION

ADA ASSISTANCE: It is the policy of the City of Key West to comply with all requirements of the Americans with Disabilities Act (ADA). Please call the TTY number at 800-955-8771 or 800-955-8770 (Voice) or the ADA Coordinator at 305-809-3811 at least five business days in advance for sign language interpreters, assistive listening devices, or materials in accessible format.

PROPERTY APPRAISER INFORMATION

Disclaimer

The Monroe County Property Appraiser's office maintains data on property within the County solely for the purpose of fulfilling its responsibility to secure a just valuation for ad valorem tax purposes of all property within the County. The Monroe County Property Appraiser's office cannot guarantee its accuracy for any other purpose. Likewise, data provided regarding one tax year may not be applicable in prior or subsequent years. By requesting such data, you hereby understand and agree that the data is intended for ad valorem tax purposes only and should not be relied on for any other purpose.

By continuing into this site you assert that you have read and agree to the above statement.

Summary

Parcel ID 00004490-000000
 Account# 1004677
 Property ID 1004677
 Millage Group 10KW
 Location 317 WHITEHEAD St, KEY WEST
 Address
 Legal KW PT LT 3 SQR 25 G71-343/44 G72-528/29 A4-460/61 OR294-445/47 OR491-356/57 OR605-887 OR819-1809/12 OR819-1815/18 OR863-1434/35 OR877-1405 OR909-1035/36 OR2558-1823/24 OR3097-0350 OR3097-343
 Description
 (Note: Not to be used on legal documents.)
 Neighborhood 32020
 Property ONE STORY OFFICE (1700)
 Class
 Subdivision
 Sec/Twp/Rng 06/68/25
 Affordable No
 Housing



Owner

MARCEAU MICHAEL R
 PO Box 584
 Kennebunkport ME 04046

Valuation

	2021	2020	2019	2018
+ Market Improvement Value	\$196,353	\$196,353	\$205,854	\$0
+ Market Misc Value	\$2,215	\$2,235	\$2,256	\$0
+ Market Land Value	\$1,441,409	\$1,441,409	\$1,264,910	\$1,061,504
= Just Market Value	\$1,639,977	\$1,639,997	\$1,473,020	\$1,061,504
= Total Assessed Value	\$1,317,690	\$1,197,900	\$1,089,000	\$990,000
- School Exempt Value	\$0	\$0	\$0	\$0
= School Taxable Value	\$1,639,977	\$1,639,997	\$1,473,020	\$1,061,504

Land

Land Use	Number of Units	Unit Type	Frontage	Depth
(1700)	6,537.00	Square Foot	67	100

Commercial Buildings

Style OFFICE BLD-1 STORY / 17C
 Gross Sq Ft 3,799
 Finished Sq Ft 3,534
 Perimeter 0
 Stories 2
 Interior Walls
 Exterior Walls AB AVE WOOD SIDING
 Quality 300 ()
 Roof Type
 Roof Material
 Exterior Wall1 AB AVE WOOD SIDING
 Exterior Wall2
 Foundation
 Interior Finish
 Ground Floor Area
 Floor Cover
 Full Bathrooms 0
 Half Bathrooms 0
 Heating Type
 Year Built 1963
 Year Remodeled
 Effective Year Built 1991

Condition Code	Description	Sketch Area	Finished Area	Perimeter
OPX	EXC OPEN PORCH	133	0	0
FLA	FLOOR LIV AREA	3,534	3,534	0
OPU	OP PR UNFIN LL	102	0	0
OOU	OP PR UNFIN UL	30	0	0
TOTAL		3,799	3,534	0

Yard Items

Description	Year Built	Roll Year	Quantity	Units	Grade
RW2	1975	1976	1	157 SF	3
FENCES	1989	1990	1	500 SF	2
UTILITY BLDG	1994	1995	1	18 SF	4
FENCES	1994	1995	1	30 SF	4

Sales

Sale Date	Sale Price	Instrument	Instrument Number	Deed Book	Deed Page	Sale Qualification	Vacant or Improved
5/5/2021	\$1,150,000	Warranty Deed	2319413	3097	0350	01 - Qualified	Improved
5/5/2021	\$100	Quit Claim Deed	2319411	3097	343	11 - Unqualified	Improved
3/7/2012	\$0	Quit Claim Deed		2558	1823	11 - Unqualified	Improved
4/1/1983	\$75,000	Warranty Deed		877	1405	U - Unqualified	Improved
2/1/1975	\$40,000	Conversion Code		605	887	Q - Qualified	Improved

Permits

Number	Date Issued	Date Completed	Amount	Permit Type	Notes
15-4105	10/19/2015	5/13/2017	\$8,950	Commercial	REPLACE GRAVEL ROOF.
10-00000095	1/14/2010		\$500	Commercial	INSTALL SIGN
06-3374	6/5/2006	9/28/2006	\$2,000	Commercial	INSTALL TORCH DOWN MODIFIED RUBBER 1 1/2 SQRS.
05-4598	12/14/2005	12/31/2005	\$500	Commercial	RUN POWER FOR ARM ACROSS DRIVEWAY
05-4772	10/31/2005	12/31/2005	\$500	Commercial	EMERGENCY ELECTRIC REPAIR FROM WILMA
05-3183	10/7/2005	12/31/2005	\$5,415	Commercial	RELOCATE LIFTMASTER ARM AT BARRIER ENTRANCE
B953330	10/1/1995	12/1/1995	\$1,000	Commercial	CBS STORAGE BLDG/WALL
B953475	10/1/1995	12/1/1995	\$1,700	Commercial	CANVAS COVERED CARPORT
B951363	4/1/1995	8/1/1995	\$400	Commercial	REPAIR CONCRETE
B950502	2/1/1995	8/1/1995	\$1,200	Commercial	SCAPE/REPAINT BUILDING

View Tax Info

[View Taxes for this Parcel](#)

Sketches (click to enlarge)

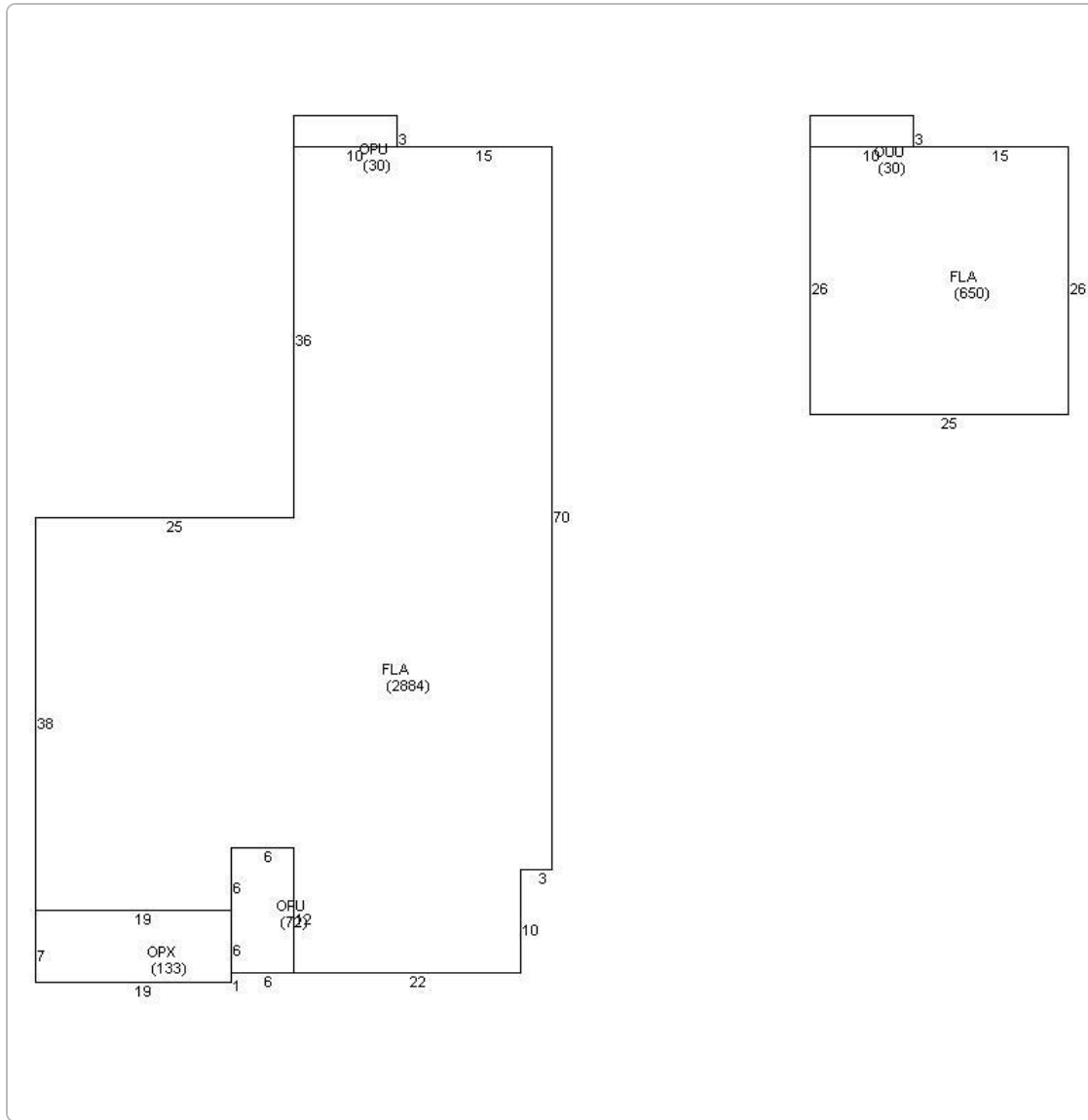

Photos



Map



TRIM Notice

2021 TRIM Notice (PDF)

2021 Notices Only

No data available for the following modules: Buildings, Mobile Home Buildings, Exemptions.

The Monroe County Property Appraiser's office maintains data on property within the County solely for the purpose of fulfilling its responsibility to secure a just valuation for ad valorem tax purposes of all property within the County. The Monroe County Property Appraiser's office cannot guarantee its accuracy for any other purpose. Likewise, data provided regarding one tax year may not be applicable in prior or subsequent years. By requesting such data, you hereby understand and agree that the [User Privacy Policy](#) and [GDPR Privacy Notice](#)



Last Data Upload: [10/13/2021, 3:12:36 AM](#)

Version 2.3.151