



Historic Architectural Review Commission Staff Report for Item 5

To: Acting Chairman Greg Oropeza and Historic Architectural Review
Commission Members

From: Enid Torregrosa-Silva, MSHP
Historic Preservation Planner

Meeting Date: August 23, 2022

Applicant: MTM Building and Roofing

Application Number: H2022-0033

Address: 1108 Fleming Street

Description of Work:

Replace existing metal roof on main gable with new standing seam metal system.

Site Facts:

The house under review is a one-story wood frame contributing resource to the historic district. The house, build circa 1906, has a front porch covered with metal shingles and a front gable roof that used to have 5 v-crimp metal panels. At the time of this report the applicant has removed the metal cover and installed a water shield membrane. No Certificate of Appropriateness has been issued at this time. The project was submitted originally for a Certificate of Appropriateness under a building permit, but staff opines that the proposed changes are contrary to the guidelines as standing seam is proposed to be a replacement for the 5 v-crimp metal system. The front porch has metal shingles.

SOIS and Guidelines and HARC Guidelines Cited on Review:

- U. S. Secretary of the Interior's Standards (pages 16-23), specifically Standards 2 and 6.
- Roofing (page 26), specifically first paragraph of page 26 and guidelines 2, and 4.
- U.S. Secretary of the Interior's Guidelines for Rehabilitating Historic Buildings (pages 15-16)

Recommended

Replacing in kind an entire feature of the roof that is too deteriorated to repair- if the overall form and detailing are still evidence-using the physical evidence to guide the new work. Examples can include a large section of roofing, or a dormer or chimney. If using the same kind of material is not technically or economically feasible, then a compatible substitute material may be considered.

Not Recommended

Using a substitute material for the replacement part that does not convey the visual appearance of the surviving parts of the roof or that is physically or chemically incompatible.

Staff Analysis:

The Certificate of Appropriateness under review proposes the replacement of previously installed 5 V-crimp metal roof with standing seam in same silver color. The profile of the proposed standing seam will be 1 5/8" on its highest point, regular 5 V-crimp is approximately .5" on its highest point. The tall profile of the seam makes ridge caps, hips, and flashings more prominent than those same elements over a 5 V-crimp which has a lower profile. The metal shingles at the front porch will stay in place.

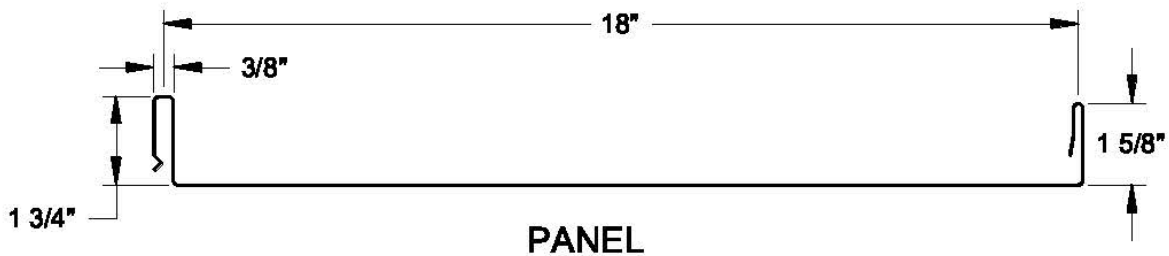

Profile of proposed standing seam.

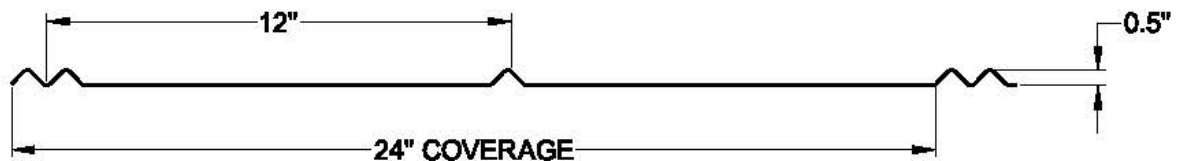

Profile of 5 V-crimp

Consistency with Cited Guidelines:

Staff finds the proposal of using standing seam as a replacement construction material to be inconsistent with cited regulations. Roofs and their forms, material, textures, and color all are character defining features of historic buildings in Key West. Staff finds that here is a noticeable different in the profile of both materials and this will change the visual character and look of the historic house. Copper roofing with standing seams is an old roofing material. There is pictorial evidence that some buildings in Key West’s roofs may had copper roofing with standing seams. Nevertheless, the low profile of historic copper with standing seams, flashings and gable rake and ridge seams were completely different from today’s standing seam. According to studied documents modern-day standing seam dates back to the 1960’s. V crimp metal panels are also an old roofing material in the United States, advertised in the 1890’s as old-style galvanized iron roofing material and has been a low profile seam.

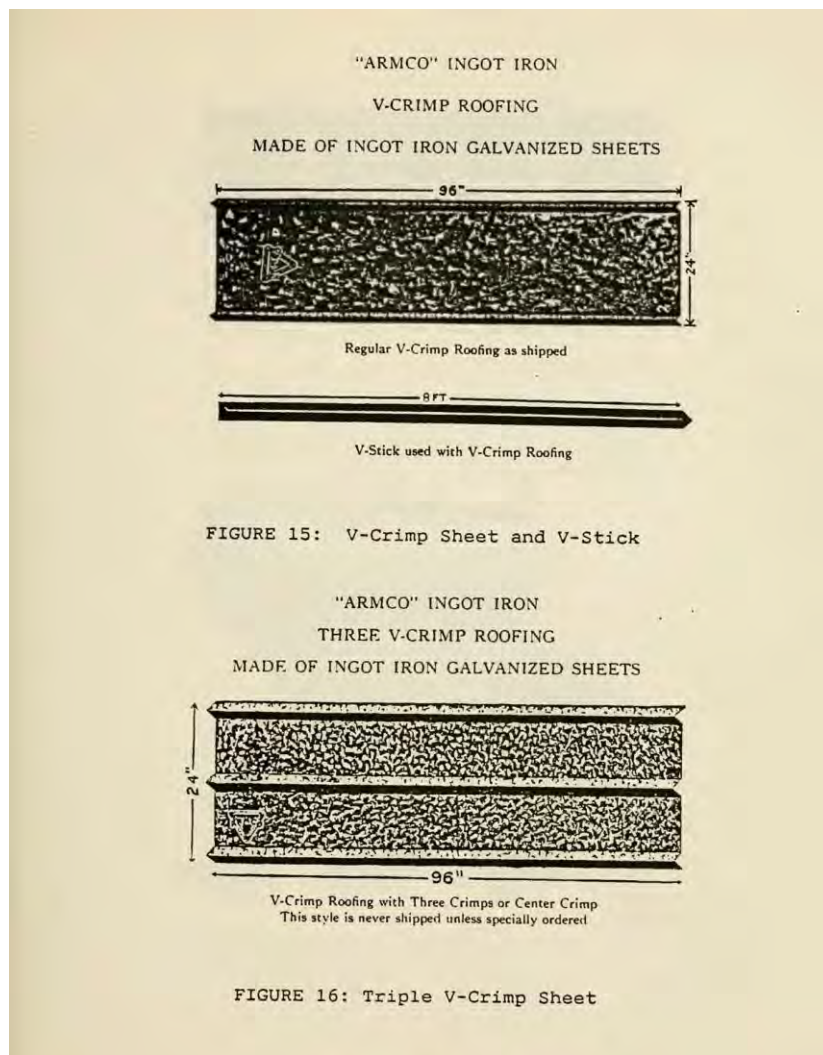



Example of a historic copper roof with standing seam.

It is staff's opinion that the texture and visual quality of modern standing seam as a roofing material detracts from the historic character of the streetscape, as seen in these before and after photographs of 1400 Virginia Street. The texture and high profile of the seams and finish elements gives a different character to a building and its streetscape.



1400 Virginia Street before with 5 V-crimp.



1400 Virginia Street after with standing seam.



Key West circa 1910. Monroe County Library.



Detail of 1910's photograph. Monroe County Library.

APPLICATION

HARC MAJOR PROJECTS CERTIFICATE OF APPROPRIATENESS

\$441 NON-REFUNDABLE BASE APPLICATION FEE - OTHER FEES MAY BE APPLICABLE Rev 09/27/2021 ET



City of Key West
1300 White Street
Key West, Florida 33040

HARC COA # <i>2022-0033</i>	REVISION #	INITIAL & DATE <i>TK</i>
FLOOD ZONE	ZONING DISTRICT	BLDG PERMIT #

A PRE-APPLICATION MEETING WITH HARC STAFF IS REQUIRED PRIOR TO SUBMITTAL

ADDRESS OF PROPOSED PROJECT:	1108 Fleming Street, Key West	
NAME ON DEED:	John Bruno	PHONE NUMBER 305-842-4446
OWNER'S MAILING ADDRESS:	15401 Windmill Pointe Drive	EMAIL jbrunoosu@aol.com
	Grosse Pointe Park, MI 48230	
APPLICANT NAME:	MTM Building & Roofing	PHONE NUMBER 305-504-4490
APPLICANT'S ADDRESS:	2117 Fogarty Avenue	EMAIL mtm.marissa@gmail.com
	Key West, FL 33040	
APPLICANT'S SIGNATURE:	<i>[Signature]</i>	DATE <i>7/7/2022</i>

ANY PERSON THAT MAKES CHANGES TO AN APPROVED CERTIFICATE OF APPROPRIATENESS MUST SUBMIT A NEW APPLICATION.

FLORIDA STATUTE 837.06: WHOEVER KNOWINGLY MAKES A FALSE STATEMENT IN WRITING AND WITH THE INTENT TO MISLEAD A PUBLIC SERVANT IN THE PERFORMANCE OF HIS OR HER OFFICIAL DUTY SHALL BE GUILTY OF A MISDEMEANOR OF THE SECOND-DEGREE PUNISHABLE PER SECTION 775.082 OR 775.083. THE APPLICANT FURTHER HEREBY ACKNOWLEDGES THAT THE SCOPE OF WORK AS DESCRIBED IN THE APPLICATION SHALL BE THE SCOPE OF WORK THAT IS CONTEMPLATED BY THE APPLICANT AND THE CITY THE APPLICANT FURTHER STIPULATES THAT SHOULD FURTHER ACTION BE TAKEN BY THE CITY FOR EXCEEDING THE SCOPE OF THE DESCRIPTION OF WORK, AS DESCRIBED HEREIN, AND IF THERE IS CONFLICTING INFORMATION BETWEEN THE DESCRIPTION OF WORK AND THE SUBMITTED PLANS, THE AFOREMENTIONED DESCRIPTION OF WORK SHALL BE CONTROLLING.

PROJECT INCLUDES: REPLACEMENT OF WINDOWS RELOCATION OF A STRUCTURE ELEVATION OF A STRUCTURE
 PROJECT INVOLVES A CONTRIBUTING STRUCTURE: YES NO INVOLVES A HISTORIC STRUCTURE: YES NO
 PROJECT INVOLVES A STRUCTURE THAT IS INDIVIDUALLY LISTED ON THE NATIONAL REGISTER: YES NO

DETAILED PROJECT DESCRIPTION INCLUDING MATERIALS, HEIGHT, DIMENSIONS, SQUARE FOOTAGE, LOCATION, ETC.
GENERAL: Replace 13SQ existing metal roofing with a new Standing Seam metal roofing system.
MAIN BUILDING:
DEMOLITION (PLEASE FILL OUT AND ATTACH DEMOLITION APPENDIX):

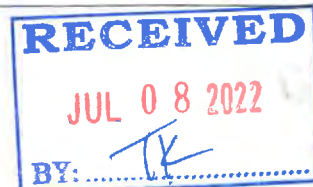

APPLICATIONS MUST BE SUBMITTED IN PERSON WITH HARD COPIES BY 3PM ON THE SCHEDULED DEADLINE
 PLEASE SEND AN ELECTRONIC COPY OF ALL DOCUMENTS CITY_HARC@CITYOFKEYWEST-FL.GOV

ACCESSORY STRUCTURE(S):	
PAVERS:	FENCES:
DECKS:	PAINTING:
SITE (INCLUDING GRADING, FILL, TREES, ETC):	POOLS (INCLUDING EQUIPMENT):
ACCESSORY EQUIPMENT (GAS, A/C, VENTS, ETC):	OTHER:

OFFICIAL USE ONLY:	HARC COMMISSION REVIEW	EXPIRES ON:
MEETING DATE	<input type="checkbox"/> APPROVED <input type="checkbox"/> NOT APPROVED <input type="checkbox"/> DEFERRED FOR FUTURE CONSIDERATION	INITIAL
MEETING DATE	<input type="checkbox"/> APPROVED <input type="checkbox"/> NOT APPROVED <input type="checkbox"/> DEFERRED FOR FUTURE CONSIDERATION	INITIAL
MEETING DATE	<input type="checkbox"/> APPROVED <input type="checkbox"/> NOT APPROVED <input type="checkbox"/> DEFERRED FOR FUTURE CONSIDERATION	INITIAL
REASONS OR CONDITIONS		
STAFF REVIEW COMMENTS		
FIRST READING FOR DEMO	SECOND READING FOR DEMO	
HARC STAFF SIGNATURE AND DATE	HARC CHAIRPERSON SIGNATURE AND DATE	

THIS APPLICATION MAY BE REVIEWED BY PLANNING DEPARTMENT STAFF.

SANBORN MAPS

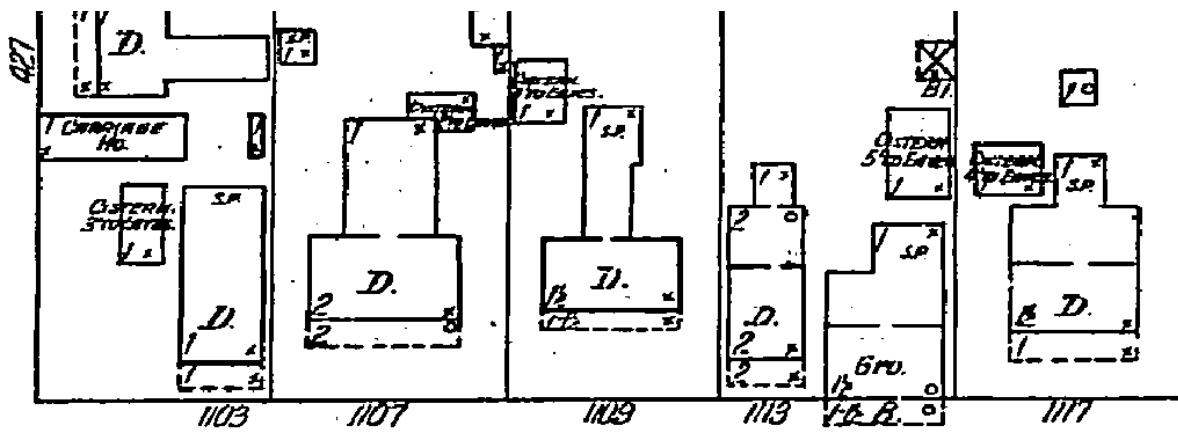

ERICK PAVED.

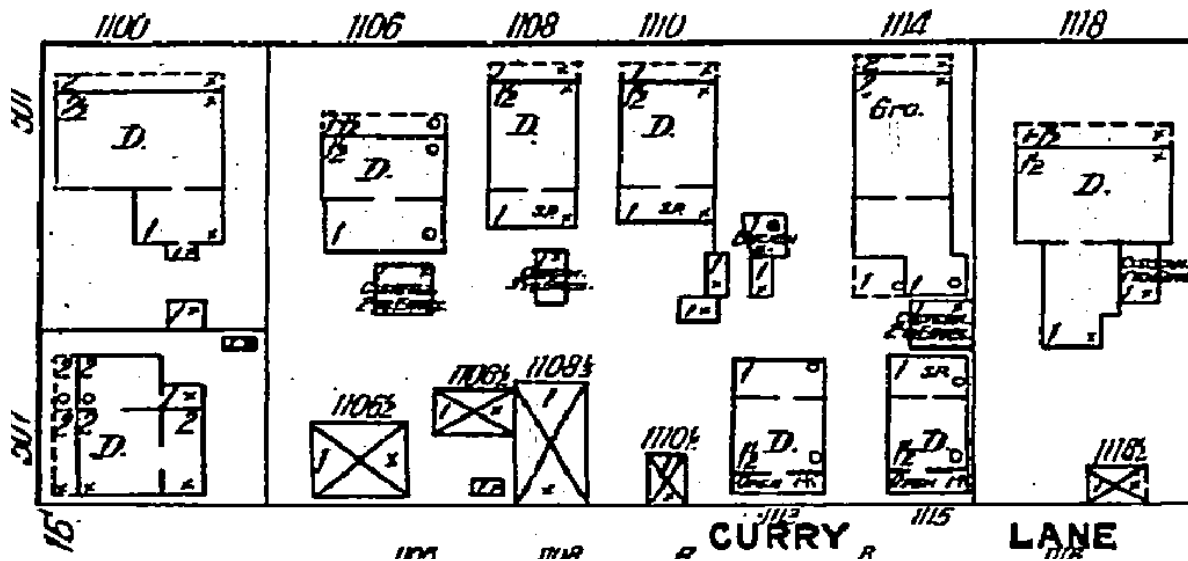

1912 Sanborn Map

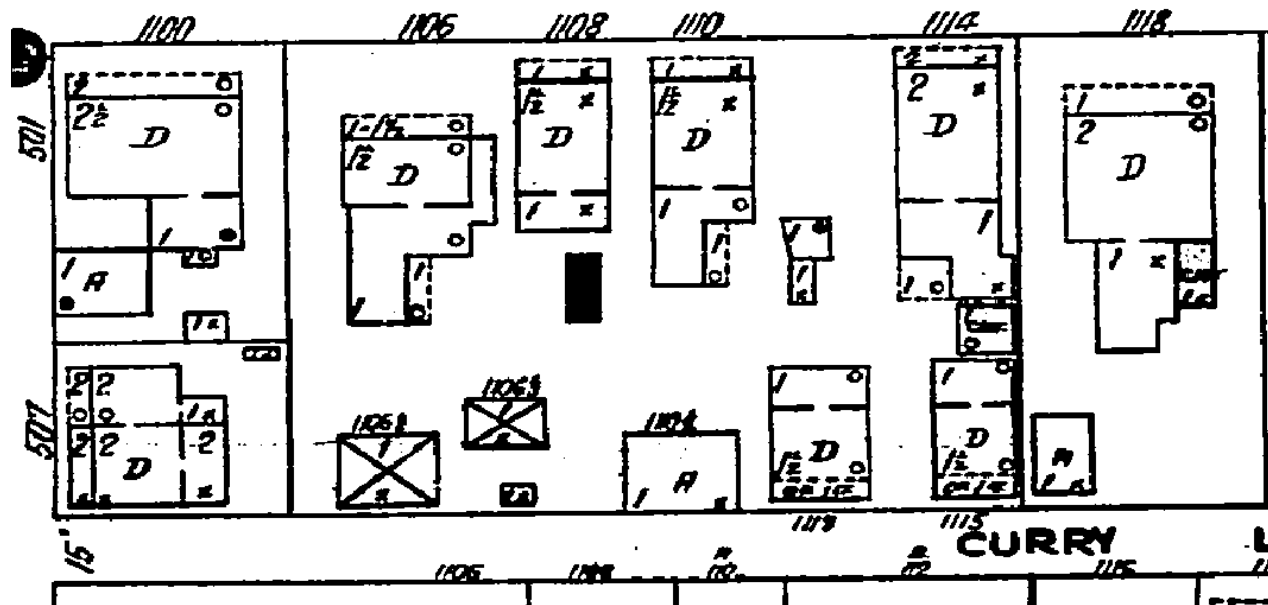
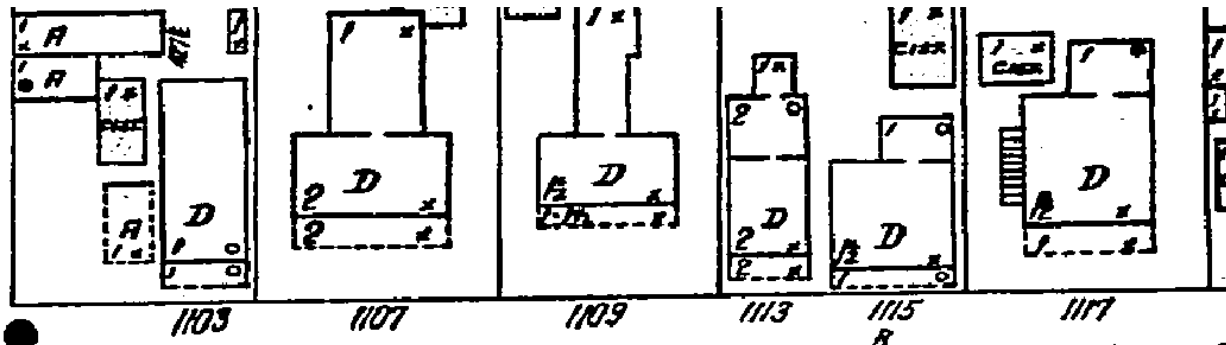

1926 Sanborn Map

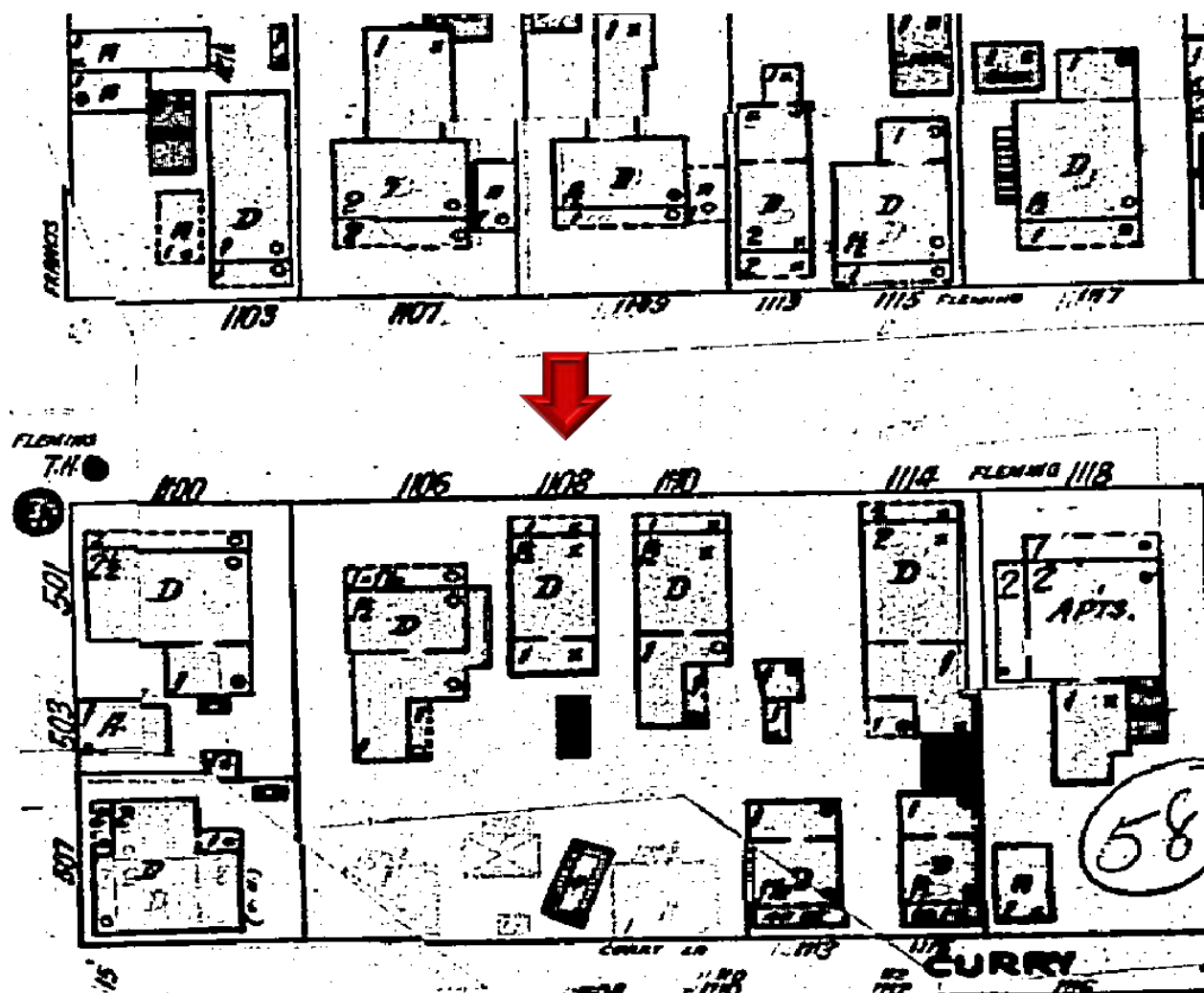

1948 Sanborn Map

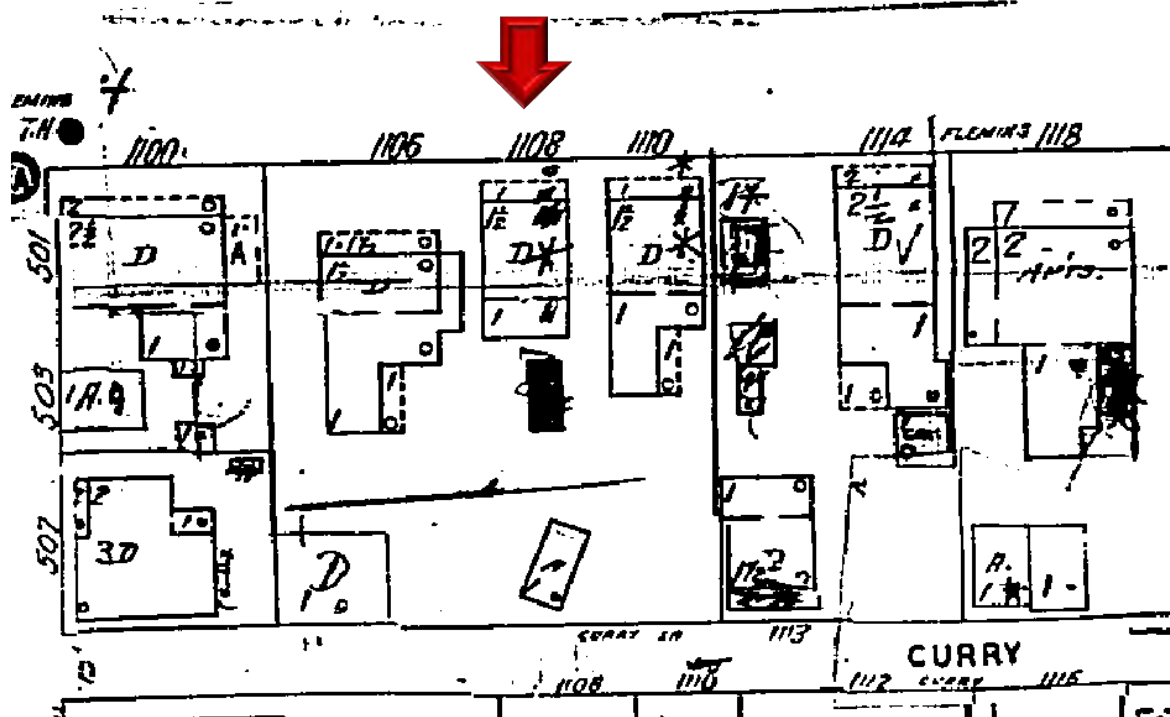
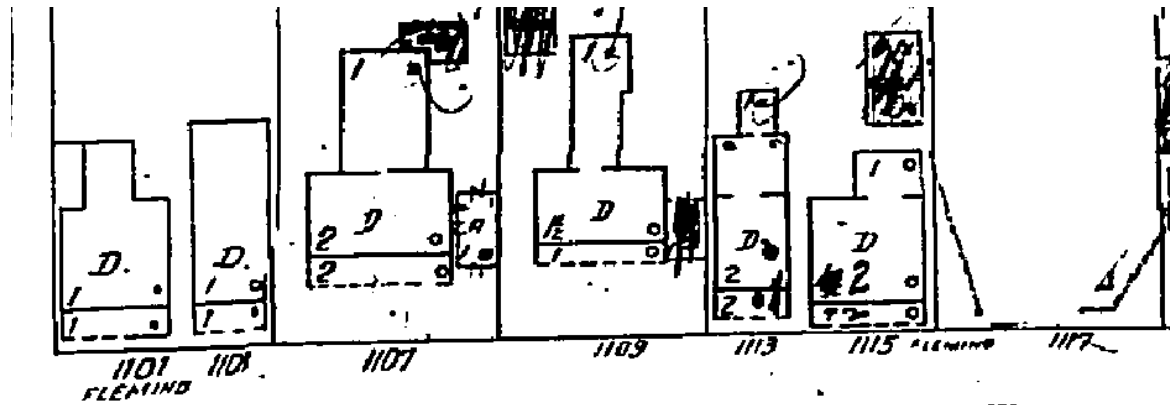

1962 Sanborn Map

PROJECT PHOTOS



1108 Fleming Street circa 1965. Monroe County Library.

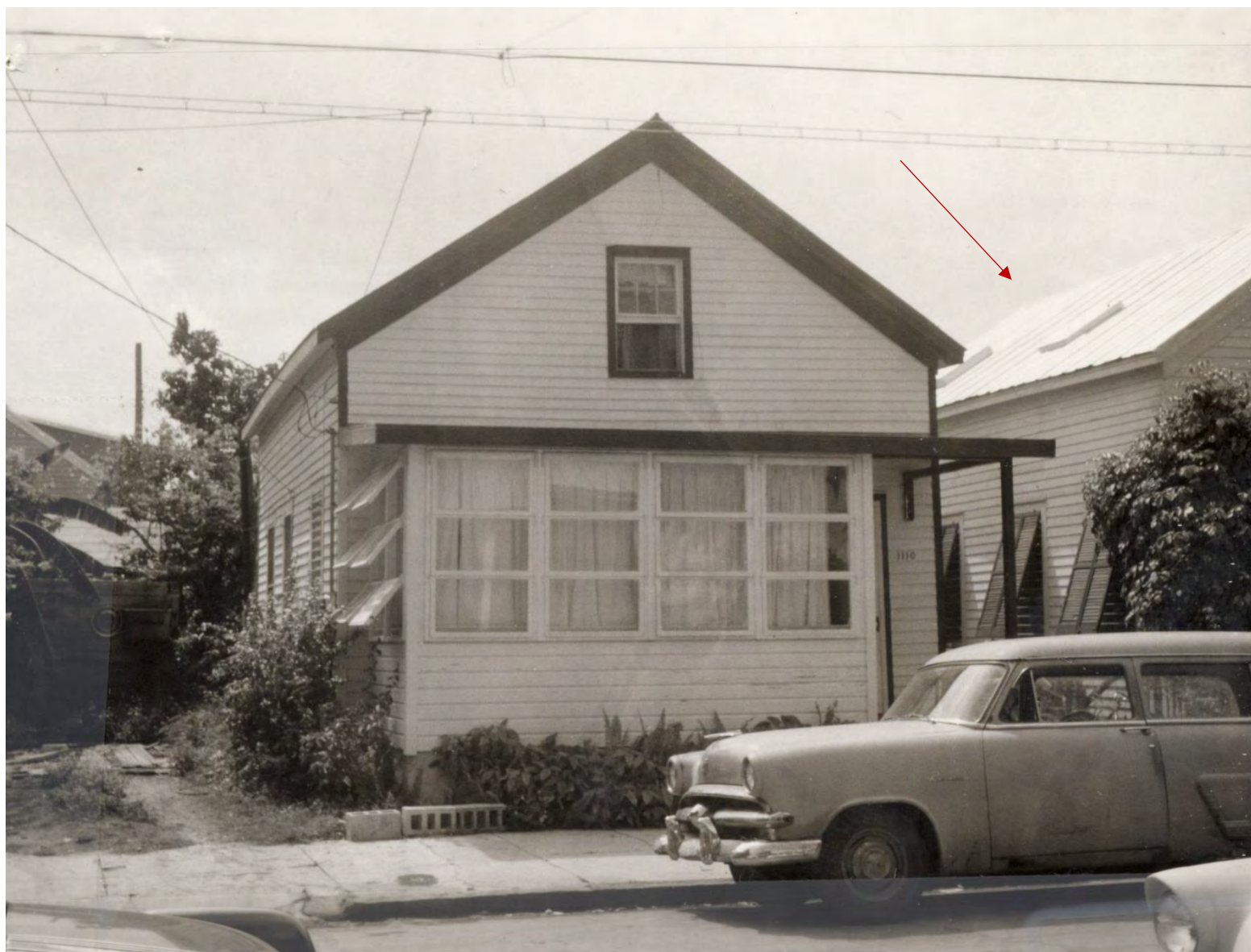

1110 Fleming Street circa 1965. Notice 1108 Fleming to the right side. Monroe County Library.



Detail of 1108 Fleming Street roof from circa 1965 photograph.



Current Conditions.











PROPOSED DESIGN



Replace existing roofing on main gable roof with new Standing Seam metal

1108 Fleming Street
Key West
MTM Building & Roofing



DEPARTMENT OF REGULATORY AND ECONOMIC RESOURCES (RER)
BOARD AND CODE ADMINISTRATION DIVISION

MIAMI-DADE COUNTY
PRODUCT CONTROL SECTION
11805 SW 26 Street, Room 208
Miami, Florida 33175-2474
T (786) 315-2590 F (786) 315-2599
www.miamidade.gov/economy

NOTICE OF ACCEPTANCE (NOA)

Extreme Metal Fabricators, LLC
2160 SW Poma Drive
Palm City, FL 34990

SCOPE:

This NOA is being issued under the applicable rules and regulations governing the use of construction materials. The documentation submitted has been reviewed and accepted by Miami-Dade County RER - Product Control Section to be used in Miami-Dade County and other areas where allowed by the Authority Having Jurisdiction (AHJ).

This NOA shall not be valid after the expiration date stated below. The Miami-Dade County Product Control Section (In Miami-Dade County) and/ or the AHJ (in areas other than Miami-Dade County) reserve the right to have this product or material tested for quality assurance purposes. If this product or material fails to perform in the accepted manner, the manufacturer will incur the expense of such testing and the AHJ may immediately revoke, modify, or suspend the use of such product or material within their jurisdiction. RER reserves the right to revoke this acceptance, if it is determined by Miami-Dade County Product Control Section that this product or material fails to meet the requirements of the applicable building code.

This product is approved as described herein, and has been designed to comply with the Florida Building Code including the High Velocity Hurricane Zone of the Florida Building Code.

DESCRIPTION: Series 2000 Steel Panel

LABELING: Each unit shall bear a permanent label with the manufacturer's name or logo, city, state and following statement: "Miami-Dade County Product Control Approved", unless otherwise noted herein.

RENEWAL of this NOA shall be considered after a renewal application has been filed and there has been no change in the applicable building code negatively affecting the performance of this product.

TERMINATION of this NOA will occur after the expiration date or if there has been a revision or change in the materials, use, and/ or manufacture of the product or process. Misuse of this NOA as an endorsement of any product, for sales, advertising or any other purposes shall automatically terminate this NOA. Failure to comply with any section of this NOA shall be cause for termination and removal of NOA.

ADVERTISEMENT: The NOA number preceded by the words Miami-Dade County, Florida, and followed by the expiration date may be displayed in advertising literature. If any portion of the NOA is displayed, then it shall be done in its entirety.

INSPECTION: A copy of this entire NOA shall be provided to the user by the manufacturer or its distributors and shall be available for inspection at the job site at the request of the Building Official.

This NOA renews NOA No. 13-0416.11 and consists of pages 1 through 5.

The submitted documentation was reviewed by *Freddy Semino* 



NOA No.: 18-0711.12
Expiration Date: 08/09/2023
Approval Date: 08/09/2018
Page 1 of 5

ROOFING ASSEMBLY APPROVAL:

Category: Roofing
Sub-Category: Non-Structural Metal Roofing
Material: Steel
Deck Type: Wood
Maximum Design Pressure See Table A

TRADE NAMES OF PRODUCTS MANUFACTURED OR LABELED BY APPLICANT:

<u>Product</u>	<u>Dimensions</u>	<u>Test Specifications</u>	<u>Product Description</u>
Series 2000	l = various w = 18" Thickness 24 ga. (0.02575") Min. Yield Strength: 60 ksi.	TAS 110 TAS 125	Corrosion resistant, galvanized, preformed, standing seam, coated, prefinished, metal panels.
Series 2000 Clip	min. 0.048" 3 1/2" long x 1 3/4" high	TAS 114	Corrosion resistant, formed, steel clips for metal panel installation.
Trim Pieces	l = varies w = varies Thickness 24 ga. (0.02575")	TAS 110	Standard flashing and trim pieces. Manufactured for each panel width.

EVIDENCE SUBMITTED:

<u>Test Agency</u>	<u>Test Identifier</u>	<u>Test Name/Report</u>	<u>Date</u>
Architectural Testing, Inc.	01-32796.01	TAS 100	Sep. 1998
Architectural Testing, Inc.	01-35899.01	TAS 125	Feb. 2000
Intertek/Architectural Testing	F5009.01-109-18	TAS 125	02/17/16



NOA No.: 18-0711.12
Expiration Date: 08/09/2023
Approval Date: 08/09/2018
Page 2 of 5

APPROVED ASSEMBLIES:

System: Englert Series 2000 Steel Panel
Deck Type: Wood, Non-Insulated
Deck Description: New Construction ¹⁹/₃₂" or greater plywood or wood plank.
Slope Range: 2": 12" or greater
Maximum Uplift Pressure: See Table A below

Deck Attachment: In accordance with applicable Building Code, but in no case shall it be less than 8d annular ring shank nails spaced 6" o.c. In reroofing, where the deck is less than ¹⁹/₃₂" thick (Minimum ¹⁵/₃₂"). The above attachment method must be in addition to existing attachment.

Underlayment: Minimum underlayment shall be a ASTM D 226 Type II installed with a minimum 4" side-laps and 6" end-laps. Underlayment shall be fastened with corrosion resistant tin-caps and 1¹/₄" annular ring-shank nails, spaced 6" o.c. at all laps and two staggered rows 12" o.c. in the field of the roll. Or, any Miami-Dade County Product Control Approved underlayment having a current NOA.

Fire Barrier Board: Any approved fire barrier having a current NOA. Refer to a current fire directory listing for fire ratings of this roofing system assembly as well as the location of the fire barrier within the assembly. See Limitation # 1.

Valleys: Valley construction shall be in compliance with Roofing Application Standard RAS 133 and with Englert's current published installation instructions.

Metal Panels and Accessories: Install the "Series 2000 Panel" and accessories in compliance with the current published installation instructions and details in Englert's Installation Manual. Flashings, penetrations, valley construction and other details shall be constructed in compliance with Roofing Application Standard RAS 133. Male leg of snap seam shall be caulked with a minimum ¹/₈" bead of elastomeric construction sealant prior to installation of female leg of panel.

Panels shall be installed with galvanized steel clips (3¹/₂" long x 2 ¹/₂" wide x 1³/₄" tall), attached to substrate with (2) two corrosion resistant #10-16 self-tapping pancake screws of sufficient length to penetrate through the sheathing a minimum of ³/₁₆". Clip fastening shall start 3" from panel end and shall be at maximum spacing as described below in Table A.

TABLE A		
MAXIMUM DESIGN PRESSURES		
Roof Areas	Field	Perimeter and Corner¹
Maximum Design Pressures	-62.5 psf	-165 psf
Maximum Clip Spacing	24" o.c.	8" o.c.
1. Extrapolation shall not be allowed		



SYSTEM LIMITATIONS

1. Fire classification is not part of this acceptance; refer to a current Approved Roofing Materials Directory for fire ratings of this product.
2. The maximum designed pressure listed herein shall be applicable to all roof pressure zones (i.e. field, perimeters, and corners). Neither rational analysis, nor extrapolation shall be permitted for enhanced fastening at enhanced pressure zones (i.e. perimeters, extended corners and corners).
3. Panels may be rolls formed in continuous lengths from eave to ridge. Maximum lengths shall be as described in Roofing Application Standard RAS 133
4. All panels shall be permanently labeled with the manufacturer's name and/or logo, and the following statement: "Miami-Dade County Product Control Approved" **or** with the Miami-Dade County Product Control Seal as seen below. All clips shall be permanently labeled with the manufacturer's name and/or logo, and/or model.



5. All products listed herein shall have a quality assurance audit in accordance with the Florida Building Code and Rule 61G20-3 of the Florida Administrative Code.
6. Panels may be jobsite roll formed with machine model # **10811107** from Englert, Inc.



DRAWINGS

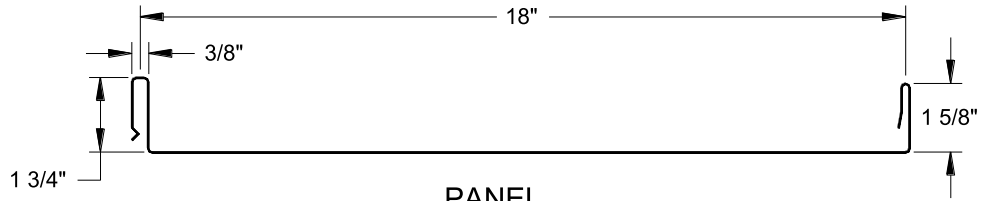

PANEL

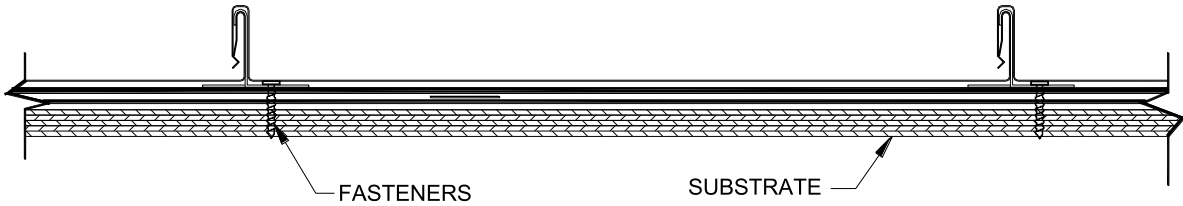
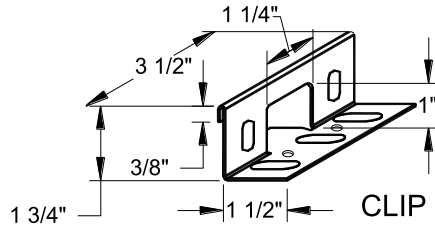

PANEL WITH CLIP & FASTENERS

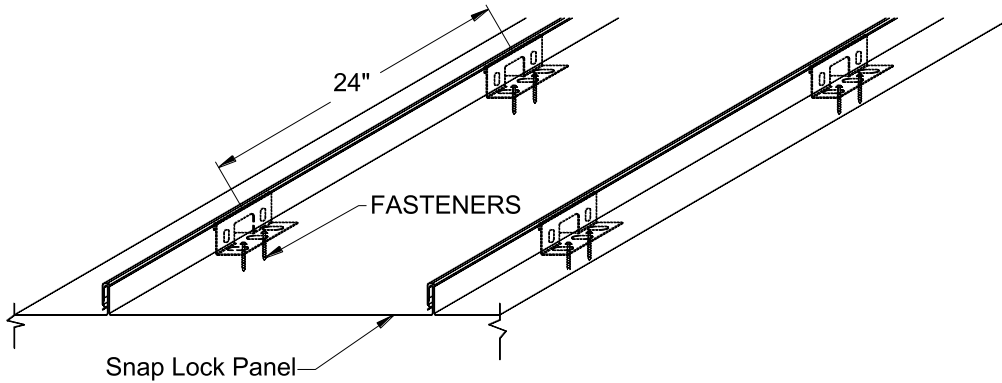

SERIES 2000 METAL PANEL

END OF THIS ACCEPTANCE



SITE DATA

SITE ADDRESS: 1108 FLEMING STREET, KEY WEST, FL 33040

RE: 00007040-000000

SECTION/TOWNSHIP/RANGE: 06/68/25

LEGAL DESCRIPTION: KW PT LOT 3 SQR 44 G31-79/80

SCOPE OF WORK: REPLACE 13SQ MAIN ROOF WITH NEW STANDING SEAM METAL ROOFING SYSTEM.

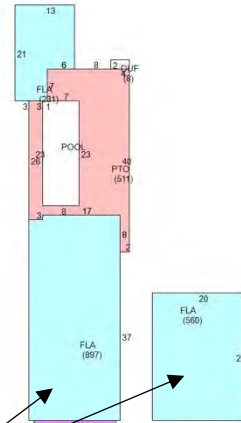

REPLACE MAIN ROOF WITH NEW STANDING SEAM

BUILDING DIMENSIONS



SCALE: N.T.S.

ASCE 7-16 WIND LOAD DATA

(2020 FL BLDG CODE CH. 28 & 30)

ULT WIND SPEED:	180 MPH	ROOF ZONES:	NOMINAL
RISK CATEGORY:	II	ZONE 1:	32.7/-76.7
EXPOSURE:	D	ZONE 2e:	32.7/-76.7
MEAN ROOF HGT:	18.0'	ZONE 2n:	32.7/-122.4
ROOF SLOPE:	5:12	ZONE 2r:	32.7/-122.4
ROOF TYPE:	GABLE	ZONE 3e:	32.7/-122.4
END ZONE WIDTH:	4.00'	ZONE 3r:	32.7/-157.8

This item has been digitally signed and sealed by Stephen L. Markey, P.E., using a digital signature. Printed copies of this document are not considered signed and sealed and the SHA authentication code must be verified on any electronic copies.

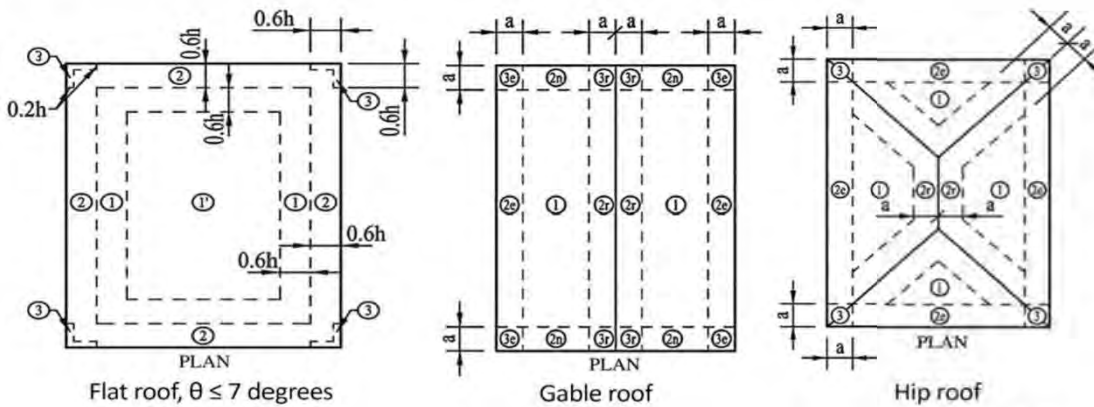

NOTES:

Flat roof, $\theta \leq 7$ degrees

Gable roof

Hip roof

- ASCE 7-16 WINDLOAD PRESSURE REQUIREMENTS ARE SHOWN IN THE PLAN CALLOUTS AND TABLE AS "MAX POSITIVE PRESSURE(+)/ MAX NEGATIVE PRESSURE (-)"; ALL PRESSURES ARE IN PSF.
- WIND PRESSURE CALCULATIONS AND IMPACT RATINGS ARE BASED ON ASCE 7-16 / ASTM E 1996-11, N.O., 180 MPH (3-SEC GUST), EXPOSURE C or D, AS NOTED.

SHEET TITLE: ROOF WIND PRESSURES	DRAWN BY: MS	PROJECT NO:	CAD FILE: ---
SHEET NUMBER: S-1.0 SHEET 1 OF 1	REVIEWED BY: SM	SCALE: AS NOTED	SHEET SIZE: ANSI A (8 1/2 x 11)

WIND PRESSURE CALCULATIONS

1108 Fleming Street, Key West

STEPHEN L. MARKEY
LICENSE No. 74560
May 12, 2022

SLIM ENGINEERING
CIVIL ENGINEERING SERVICES
KEY WEST, FL
(305) 509-2647

STATE OF FLORIDA
PROFESSIONAL ENGINEER
STEPHEN L. MARKEY
LICENSE NO. 74560
STATE OF FLORIDA

CERTIFICATE OF AUTHORIZATION #302001

PLANS NOT VALID FOR CONSTRUCTION UNLESS SIGNED AND SEALED IN THIS BLOCK

NOTICING

Public Meeting Notice

The Historic Architectural Review Commission will hold a public meeting at **5:00 p.m., August 23, 2022, at City Hall, 1300 White Street**, Key West, Florida. To view the live feed of the meeting, you can tune in to Comcast channel 77, AT&T Uverse channel 99. If you wish to participate virtually, please contact HARC staff at 305-809-3973. The purpose of the hearing will be to consider a request for:

REPLACE EXISTING METAL ROOF ON MAIN GABLE WITH NEW STANDING SEAM METAL SYSTEM.

#1108 FLEMING STREET

Applicant – MTM Building and Roofing Application #H2022-0033

If you wish to see the application or have any questions, you may visit the Planning Department during regular office hours at 1300 White Street, call 305-809-3973 or visit our website at www.cityofkeywest-fl.gov.

THIS NOTICE CAN NOT BE REMOVED FROM THE SITE UNTIL HARC FINAL DETERMINATION

ADA ASSISTANCE: It is the policy of the City of Key West to comply with all requirements of the Americans with Disabilities Act (ADA). Please call the TTY number at 800-955-8771 or 800-955-8770 (Voice) or the ADA Coordinator at 305-809-3811 at least five business days in advance for sign language interpreters, assistive listening devices, or materials in accessible format.



Public Meeting Notice

The County, Antiquarian Review Commission has been appointed by the Board of Supervisors to review the proposed project of
REPLACE EXISTING METAL ROOF ON MAIN GABLE WITH NEW STANDING SEAM METAL SYSTEM
4101 ELM STREET
Application # 18-002-0013

For more information on this project, please contact the Planning Department at 916.445.4300 or visit the website at www.ci.elm-street.ca.us



HARC POSTING AFFIDAVIT

STATE OF FLORIDA:
COUNTY OF MONROE:

BEFORE ME, the undersigned authority, personally appeared _____
Robert Chinnis of MTM Building & Roofing, who, first being duly sworn, on oath,
depose and says that the following statements are true and correct to the best of
his/her knowledge and belief:

1. That a legal notice for Public Notice of Hearing of the Historic Architectural Review Commission (HARC) was placed on the following address:
1108 Fleming Street, Key West on the
16th day of August, 2022.

This legal notice(s) contained an area of at least 8.5"x11".

The property was posted to notice a public hearing before the Key West Historic Architectural Review Commission to be held on August 23rd, 2022.

The legal notice(s) is/are clearly visible from the public street adjacent to the property.

The Certificate of Appropriateness number for this legal notice is #H2022-0033.

2. A photograph of that legal notice posted in the property is attached hereto.

Signed Name of Affiant:

Robert Chinnis
Date: 08/16/2022
Address: 2117 Fogarty Avenue
City: Key West
State, Zip: FL, 33040

The forgoing instrument was acknowledged before me on this 16th day of
August, 2022.

By (Print name of Affiant) Robert Chinnis who is
personally known to me or has produced _____ as
identification and who did take an oath.

NOTARY PUBLIC

Sign Name: Marissa Sawyer
Print Name: Marissa Sawyer
Notary Public - State of Florida (seal)
My Commission Expires: 8/26/23



PROPERTY APPRAISER INFORMATION

Disclaimer

The Monroe County Property Appraiser's office maintains data on property within the County solely for the purpose of fulfilling its responsibility to secure a just valuation for ad valorem tax purposes of all property within the County. The Monroe County Property Appraiser's office cannot guarantee its accuracy for any other purpose. Likewise, data provided regarding one tax year may not be applicable in prior or subsequent years. By requesting such data, you hereby understand and agree that the data is intended for ad valorem tax purposes only and should not be relied on for any other purpose.

By continuing into this site you assert that you have read and agree to the above statement.

Summary

Parcel ID 00007040-000000
Account# 1007293
Property ID 1007293
Millage Group 10KW
Location 1108 FLEMING St, KEY WEST
Address
Legal KW PT LOT 3 SQR 44 G31-79/80 OR396-425/27 OR925-2427/29 OR929-1389/94
Description OR930-547 OR956-452 OR1466-2055 OR1537-819 OR1549-1598 OR1618-235/36
 OR1631-2096/97 OR1876-1182/83 OR2013-532/33 OR2444-910/12 OR2686-45/47
 OR3078-2354
 (Note: Not to be used on legal documents.)
Neighborhood 6108
Property SINGLE FAMILY RESID (0100)
Class
Subdivision
Sec/Twp/Rng 06/68/25
Affordable No
Housing



Owner

BRUNO ELIZABETH
 15401 Windmill Pointe Dr
 Grosse Pointe Park MI 48230

BRUNO JOHN
 15401 Windmill Pointe Dr
 Grosse Pointe Park MI 48230

Valuation

	2022 Working Values	2021 Certified Values	2020 Certified Values	2019 Certified Values
+ Market Improvement Value	\$464,472	\$442,674	\$560,782	\$568,464
+ Market Misc Value	\$16,523	\$17,083	\$17,641	\$18,200
+ Market Land Value	\$716,494	\$529,935	\$525,879	\$554,269
= Just Market Value	\$1,197,489	\$989,692	\$1,104,302	\$1,140,933
= Total Assessed Value	\$1,197,489	\$989,692	\$1,104,302	\$1,140,933
- School Exempt Value	\$0	\$0	\$0	\$0
= School Taxable Value	\$1,197,489	\$989,692	\$1,104,302	\$1,140,933

Land

Land Use	Number of Units	Unit Type	Frontage	Depth
RES SUPERIOR DRY (01SD)	2,625.00	Square Foot	25	105

Buildings

Building ID	470	Exterior Walls	ABOVE AVERAGE WOOD
Style	2 STORY ELEV FOUNDATION	Year Built	1933
Building Type	S.F.R. - R1 / R1	EffectiveYearBuilt	2000
Gross Sq Ft	2297	Foundation	WD CONC PADS
Finished Sq Ft	1688	Roof Type	IRR/CUSTOM
Stories	2 Floor	Roof Coverage	METAL
Condition	AVERAGE	Flooring Type	SFT/HD WD
Perimeter	226	Heating Type	FCD/AIR DUCTED
Functional Obs	0	Bedrooms	3
Economic Obs	0	Full Bathrooms	3
Depreciation %	30	Half Bathrooms	0
Interior Walls	WALL BD/WD WAL	Grade	500
		Number of Fire Pl	0

Code	Description	Sketch Area	Finished Area	Perimeter
OPX	EXC OPEN PORCH	90	0	46
DUF	FIN DET UTILIT	8	0	12
FLA	FLOOR LIV AREA	1,688	1,688	294
PTO	PATIO	511	0	186
TOTAL		2,297	1,688	538

Yard Items

Description	Year Built	Roll Year	Quantity	Units	Grade
RES POOL	2000	2001	1	192 SF	5
BRICK PATIO	1999	2000	1	81 SF	2
FENCES	2000	2001	1	140 SF	2
FENCES	1999	2000	1	444 SF	2
BRICK PATIO	1999	2000	1	96 SF	2
FENCES	2010	2011	1	80 SF	2

Sales

Sale Date	Sale Price	Instrument	Instrument Number	Deed Book	Deed Page	Sale Qualification	Vacant or Improved
3/1/2021	\$1,250,000	Warranty Deed	2306480	3078	2354	01 - Qualified	Improved
5/21/2014	\$1,140,000	Warranty Deed		2686	45	02 - Qualified	Improved
11/30/2009	\$1,100,000	Warranty Deed		2444	910	02 - Qualified	Improved
5/25/2004	\$995,000	Warranty Deed		2013	0532	Q - Qualified	Improved
3/26/2003	\$675,000	Warranty Deed		1876	1182	Q - Qualified	Improved
2/15/2000	\$395,000	Warranty Deed		1618	0235	Q - Qualified	Improved
11/30/1998	\$210,300	Warranty Deed		1549	1598	Q - Qualified	Improved

Permits

Number	Date Issued	Date Completed	Amount	Permit Type	Notes
14-5737	12/23/2014	3/10/2016	\$2,400		REPLACE 2 INTERIOR DOORS, 60 LF OF TRIM, REMOVE 1 WINDOW AND REPLACE LAP SIDING ON WEST SIDE OF HOUSE
10-0808	3/18/2010	10/25/2010	\$1,500		4X4 POSTS, REPALCE 2X4 FRAMING FOR PICKETS ASSEMBLE FENCE 20lf OF 4"H
05-2180	6/7/2005	12/31/2005	\$3,511		INSTALL 400SF VCRIMP
04-1863	5/16/2005	12/31/2005	\$2,400		ALUMINUM SHUTTERS
05-1067	4/6/2005	12/31/2005	\$22,000		REMOVE SPX REPLACE WITH GARDEN ROOM
0002597	8/30/2000	11/6/2000	\$850		ROOF
0002057	8/25/2000	11/6/2000	\$8,450		FENCE /DECK /SHOWER
0002508	8/24/2000	11/6/2000	\$17,500		POOL
0000417	3/6/2000	7/19/2000	\$3,500		PAINT FRONT OF HOUSE
9803850	12/18/1999	8/13/1999	\$5,000		DEMO/RENOVATION
9900353	2/4/1999	8/13/1999	\$8,000		POOL/DECK
9900173	1/15/1999	8/13/1999	\$8,000		UPGRADE ELECTRIC
9900207	1/15/1999	8/13/1999	\$5,450		METAL ROOF
9801704	12/30/1998	8/13/1999	\$50,000		REWIRE/REPLUMB/RENOVATE
9803941	12/28/1998	8/13/1999	\$750		CONSTRUCT PORCH
9803953	12/15/1998	8/13/1999	\$250		TEMP SERVICE

View Tax Info

[View Taxes for this Parcel](#)

Sketches (click to enlarge)

Map

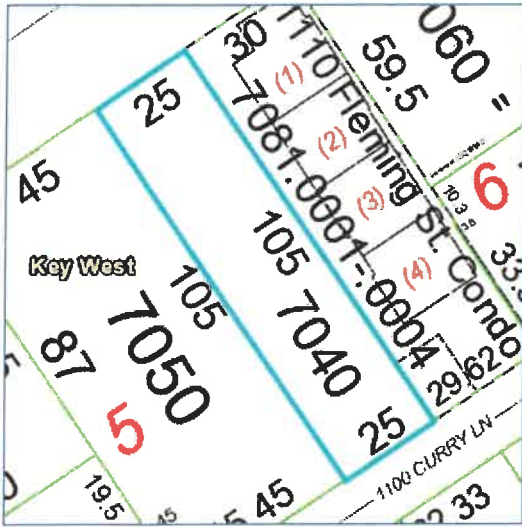

TRIM Notice

2021 TRIM Notice (PDF)

2021 Notices Only

The Monroe County Property Appraiser's office maintains data on property within the County solely for the purpose of fulfilling its responsibility to secure a just valuation for ad valorem tax purposes of all property within the County. The Monroe County Property Appraiser's office cannot guarantee its accuracy for any other purpose. Likewise, data provided regarding one tax year may not be applicable in prior or subsequent years. By requesting such data, you hereby understand and agree that the

[User Privacy Policy](#)
[GDPR Privacy Notice](#)



Last Data Upload: 7/8/2022, 1:51:22 PM

Version 2.3.206