



**Historic Architectural Review Commission
Staff Report for Item 13b**

To: Chairman Bryan Green and Historic Architectural Review
Commission Members

From: Enid Torregrosa, MSHP
Historic Preservation Planner

Meeting Date: September 29, 2015

Applicant: Michael B. Ingram, Architect

Application Number: H15-01-1370

Address: #845 Galveston Lane

Description of Work

Demolition of rear lean-to addition on contributing house.

Site Facts

The building in review is an eyebrow house listed as a contributing resource. The house pre-dates 1892 and shows many signs of decay due to many years of neglect. In the 1970's the front porch was altered by the installation of concrete floors and the back portion of the roof was altered to accommodate a full second floor. Also at that time a historic half-width back one- story attached structure was demolished and replaced by a full width addition. The house is in need of restoration and stabilization.

Ordinance Cited on Review

- Section 102-217 (2), demolition for non-contributing and non-historic structures of the Land Development Regulations.

Staff Analysis

The Certificate of Appropriateness in review is for the demolition of a non-historic one-story addition located on the back of an eyebrow house. The Sanborn maps that are part of the report can be used as evidence of the changes the house went through between its early

years of existence and today's condition; the existing back addition is not historic nor is original to the house.

Consistency with the Ordinance

It is staff's opinion that the proposed demolition will be for a non-historic portion of the house that cannot be considered contributing on a near future. Staff recommends to the Commission the consideration of such request as it is consistent with the ordinance for demolitions of non-historic and non-contributing structures. If approved, this will be the only reading for demolition. The submitted plans include the proposed development for the back portion of the site.

APPLICATION

COMBINATION APPLICATION: FLOODPLAIN, CONSTRUCTION AND HARC

\$50.00 APPLICATION FEE NON-REFUNDABLE

Bldg +

HARC



City of Key West

3140 FLAGLER AVENUE
KEY WEST, FLORIDA 33040

Phone: 305.809.3956

www.cityofkeywest-fl.gov

HARC PERMIT NUMBER 15-01-1370	BUILDING PERMIT NUMBER 15-3057	INITIALS & DATE 8/3/15 <i>[Signature]</i>
FLOODPLAIN PERMIT		REVISION #
FLOOD ZONE	PANEL #	ELEV. L. FL.
SUBSTANTIAL IMPROVEMENT		YES NO %

ADDRESS OF PROPOSED PROJECT:

RE # OR ALTERNATE KEY:

NAME ON DEED:

OWNER'S MAILING ADDRESS:

CONTRACTOR COMPANY NAME:

CONTRACTOR'S CONTACT PERSON:

ARCHITECT / ENGINEER'S NAME:

ARCHITECT / ENGINEER'S ADDRESS:

845 GALVESTON LANE		# OF UNITS 1
00019210-000000		
EVELYN DIANE MURPHY & GUSIAE		PHONE NUMBER
RACKLEY ESTATE T/C		EMAIL
N.A.		
N.A.		PHONE NUMBER
N.A.		EMAIL
MICHAEL B. INGRAM		PHONE NUMBER 305.320.0211
1001 WHITEHEAD STREET # 101		EMAIL MBINGRAMARCHITECT@GMAIL.COM
KEY WEST, FL. 33040		

HARC: PROJECT LOCATED IN HISTORIC DISTRICT OR IS CONTRIBUTING: YES NO (SEE PART C FOR HARC APPLICATION.)

CONTRACT PRICE FOR PROJECT OR ESTIMATED TOTAL FOR MAT'L., LABOR & PROFIT:

\$450,000

FLORIDA STATUTE 837.06: WHOEVER KNOWINGLY MAKES A FALSE STATEMENT IN WRITING AND WITH THE INTENT TO MISLEAD A PUBLIC SERVANT IN THE PERFORMANCE OF HIS OR HER OFFICIAL DUTY SHALL BE GUILTY OF A MISDEMEANOR OF THE SECOND DEGREE PUNISHABLE PER SECTION 775.082 OR 775.083.

PROJECT TYPE:	<input checked="" type="checkbox"/> ONE OR TWO FAMILY	<input type="checkbox"/> MULTI-FAMILY	<input type="checkbox"/> COMMERCIAL	<input type="checkbox"/> NEW	<input checked="" type="checkbox"/> REMODEL
	<input type="checkbox"/> CHANGE OF USE / OCCUPANCY	<input checked="" type="checkbox"/> ADDITION	<input type="checkbox"/> SIGNAGE	<input type="checkbox"/> WITHIN FLOOD ZONE	<input checked="" type="checkbox"/> X
	<input type="checkbox"/> DEMOLITION	<input checked="" type="checkbox"/> SITE WORK	<input checked="" type="checkbox"/> INTERIOR	<input checked="" type="checkbox"/> EXTERIOR	<input type="checkbox"/> AFTER-THE-FACT

DETAILED PROJECT DESCRIPTION INCLUDING QUANTITIES, SQUARE FOOTAGE ETC.,

COMPLETE REMODELING OF

'BIEBROW' HOUSE PLUS ONE STORY ADDITION; FOUNDATION, SIDING, ROOF, WINDOWS, FULL-
MEP, SITE WORK, FENCE, POOL. EXISTING = ± 1200 S.F. ENCLOSED; NEW = ± 1000 S.F. ENCLOSED
LOT SIZE = 5600 S.F.

I'VE OBTAINED ALL NECESSARY APPROVALS FROM ASSOCIATIONS, GOVT AGENCIES AND OTHER PARTIES AS APPLICABLE TO COMPLETE THE DESCRIBED PROJECT.	QUALIFIER PRINT NAME: MICHAEL B. INGRAM
OWNER PRINT NAME:	QUALIFIER SIGNATURE: <i>[Signature]</i>
OWNER SIGNATURE:	Notary Signature as to qualifier:
Notary Signature as to owner:	STATE OF FLORIDA; COUNTY OF MONROE, SWORN TO AND SCRIBED BEFORE ME THIS <u>3rd</u> DAY OF <u>Sept</u> , 20 <u>15</u> .
STATE OF FLORIDA; COUNTY OF MONROE, SWORN TO AND SCRIBED BEFORE ME THIS _____ DAY OF _____, 20_____.	
Personally known or produced _____ as identification.	Personally known or produced _____ as identification.

12608/14479 ok

D App Fee! GH

PART B: SUPPLEMENTARY PROJECT DETAILS TO AVOID DELAYS / CALL-BACKS

PROPERTY STRUCTURES AFFECTED BY PROJECT: MAIN STRUCTURE ACCESSORY STRUCTURE SITE

ACCESSORY STRUCTURES: GARAGE / CARPORT DECK FENCE OUTBUILDING / SHED

FENCE STRUCTURES: 4 FT. 6 FT. SOLID 6 FT. / TOP 2 FT. 50% OPEN

POOLS: INGROUND ABOVE GROUND SPA / HOT TUB PRIVATE PUBLIC
 PUBLIC POOLS REQUIRE BD. OF HEALTH LICENSE APPLICATION AT TIME OF CITY APPLICATION.
 PUBLIC POOLS REQUIRE BD. OF HEALTH LICENSE PRIOR TO RECEIVING THE CITY CERTIFICATE OF OCCUPANCY.

ROOFING: NEW ROOF-OVER TEAR-OFF REPAIR AWNING
 5 V METAL ASPLT. SHGLS. METAL SHGLS. BLT. UP TPO OTHER

N.A. FLORIDA ACCESSIBILITY CODE: 20% OF PROJECT FUNDS INVESTED IN ACCESSIBILITY FEATURES.

N.A. SIGNAGE: # OF SINGLE FACE # OF DOUBLE FACE REPLACE SKIN ONLY BOULEVARD ZONE
 POLE WALL PROJECTING AWNING HANGING WINDOW
 SQ. FT. OF EACH SIGN FACE: _____

SUBCONTRACTORS / SPECIALTY CONTRACTORS SUPPLEMENTARY INFORMATION:

MECHANICAL: DUCTWORK COMMERCIAL EXH. HOOD INTAKE / EXH. FANS LPG TANKS
 A/C: COMPLETE SYSTEM AIR HANDLER CONDENSER MINI-SPLIT

ELECTRICAL: LIGHTING RECEPTACLES HOOK-UP EQUIPMENT LOW VOLTAGE SERVICE: OVERHEAD UNDERGROUND 1 PHASE 3 PHASE 400 AMPS (ESTIMATE)

PLUMBING: ONE SEWER LATERAL PER BLDG. INGROUND GREASE INTCPTRS. LPG TANKS
 RESTROOMS: MEN'S WOMEN'S UNISEX ACCESSIBLE

PART C: HARC APPLICATION FOR A CERTIFICATE OF APPROPRIATENESS

APPLICATION FEES: PAINTING SINGLE FAMILY: \$10 STAFF APPROVAL: \$50 COMMISSION REVIEW \$100
 PLEASE ATTACH APPROPRIATE VARIANCES / RESOLUTIONS FROM HARC, PLANNING BOARD OR TREE COMMISSION.
 ATTENTION: NO BUILDING PERMITS WILL BE ISSUED PRIOR TO HARC APPROVAL.

PLEASE SEND ELECTRONIC SUBMISSIONS TO: harc@cityofkeywest-fl.gov

INDICATE TYPE OF CERTIFICATE OF APPROPRIATENESS: GENERAL DEMOLITION SIGN PAINTING OTHER

ADDITIONAL INFORMATION: HISTORIC STRUCTURE TO BE STRIPPED TO ALLOW FRAME/STRUCTURAL REPAIR

PROJECT SPECIFICATIONS: PLEASE PROVIDE PHOTOS OF EXISTING CONDITIONS, PLANS, PRODUCT SAMPLES, TECHNICAL DATA		
ARCHITECTURAL FEATURES TO BE ALTERED:	ORIGINAL MATERIAL:	PROPOSED MATERIAL:
HISTORIC WINDOWS REPLACEMENT	REMOVED & REPLACED W/ ALUMINIUM	WOOD TRUE-LITE! KOLBE
NEW ADDITION	—	OSI IMPACT RATED
SIDING HISTORIC	REPLACED W/ NON HISTORIC	WOOD CLAPBOARDS - 1" EXPOSURE
NEW	—	CEMENTITIOUS CLAPBOARD (4")

DEMOLITION: PLEASE FILL OUT THE HARC APPENDIX FOR PROPOSED DEMOLITION.

BOARD & BATTEN 16" SPACE.

DEMOLITION OF HISTORIC STRUCTURES IS NOT ENCOURAGED BY THE HISTORIC ARCHITECTURAL REVIEW COMMISSION.

SIGNAGE: (SEE PART B) BUSINESS SIGN BRAND SIGN OTHER: _____

BUSINESS LICENSE # _____ IF FAÇADE MOUNTED, SQ. FT. OF FAÇADE _____

Date: 9/15/16
 Drawn: KJ
 Check: 35733
 \$100.00
 \$50.00
 \$100.00
 9/15/16
 11:16:16

SIGN SPECIFICATIONS		
SIGN COPY:	PROPOSED MATERIALS:	SIGNS WITH ILLUMINATION:
N.A.		TYPE OF LTG.:
		LTG. LINEAL FTG.:
MAX. HGT. OF FONTS:		COLOR AND TOTAL LUMENS:
IF USING LIGHT FIXTURES PLEASE INDICATE HOW MANY: INCLUDE SPEC. SHEET WITH LOCATIONS AND COLORS.		

OFFICIAL USE ONLY:		HARC STAFF OR COMMISSION REVIEW	
<input type="checkbox"/> APPROVED	<input type="checkbox"/> NOT APPROVED	<input type="checkbox"/> DEFERRED FOR FUTURE CONSIDERATION	<input type="checkbox"/> TABLED FOR ADD'L. INFO.
HARC MEETING DATE:	HARC MEETING DATE:	HARC MEETING DATE:	
REASONS OR CONDITIONS:			
STAFF REVIEW COMMENTS:			
House is listed as contributing. Eyeknow house built 1935. Evidelines for additions / alterations Ordinance for demolition.			
HARC PLANNER SIGNATURE AND DATE:		HARC CHAIRPERSON SIGNATURE AND DATE:	

PART D: STATE OF FLORIDA OFFICIAL NOTIFICATIONS AND WARNINGS

FLORIDA STATUTE 713.135: WARNING TO OWNER: YOUR FAILURE TO RECORD A 'NOTICE OF COMMENCEMENT' MAY RESULT IN YOUR PAYING TWICE FOR IMPROVEMENTS TO YOUR PROPERTY. A NOTICE OF COMMENCEMENT MUST BE RECORDED WITH THE COUNTY RECORDER AND A COPY POSTED ON THE JOB SITE BEFORE THE FIRST INSPECTION. IF YOU INTEND TO OBTAIN FINANCING CONSULT WITH YOUR LENDER OR AN ATTORNEY BEFORE RECORDING A NOTICE.

FLORIDA STATUTE 469: ABESTOS ABATEMENT. AS OWNER / CONTRACTOR / AGENT OF RECORD FOR THE CONSTRUCTION APPLIED FOR IN THIS APPLICATION, I AGREE THAT I WILL COMPLY WITH THE PROVISIONS F. S. 469.003 AND TO NOTIFY THE FLORIDA D. E. P. OF MY INTENT TO DEMOLISH / REMOVE ASBESTOS. IN ADDITION TO THE REQUIREMENTS OF THIS PERMIT APPLICATION, THERE MAY BE DEED RESTRICTIONS AND / OR ADDITIONAL RESTRICTIONS APPLICABLE TO THIS PROPERTY THAT MAY BE FOUND IN THE PUBLIC RECORDS OF MONROE COUNTY AND THERE MAY BE ADDITIONAL PERMITS REQUIRED FROM OTHER GOVERNMENT ENTITIES SUCH AS AQUADUCT ATHORITY, FLORIDA DEP OR OTHER STATE AGENCIES; ARMY CORPS OF ENGINEERS OR OTHER FEDERAL AGENCIES.

FEDERAL LAW REQUIRES LEAD PAINT ABATEMENT PER THE STANDARDS OF THE USDEP ON STRUCTURES BUILT PRIOR TO 1978.

OFFICIAL USE ONLY BY PLANS EXAMINER OR CHIEF BUILDING OFFICIAL:				CBO OR PL. EXAM. APPROVAL:
HARC FEES:	BLDG. FEES:	FIRE MARSHAL FEE:	IMPACT FEES:	
				DATE:

CITY OF KEY WEST
CERTIFICATE OF APPROPRIATENESS
APPENDIX FOR DEMOLITIONS
 APPLICATION NUMBER H- _____



This document applies only to those properties located within the City of Key West Historic Zoning Districts, properties outside the historic zoning districts which are listed as contributing in the Historic Architectural Survey and or properties listed in the National Register of Historic Places.

Applications must meet or exceed the requirements outlined by the Secretary of the Interior's Standards for Rehabilitation and Guidelines for Rehabilitation and the Key West's Historic Architectural Guidelines. Once submitted, the application shall be reviewed by staff for completeness and scheduled for presentation to the Historic Architectural Review Commission for the next available meeting, unless the demolition request is for a *bona fide* Code Compliance case, in which case staff may review and approve the demolition request. **The applicant must be present at this meeting. Any person that makes changes to an approved Certificate of Appropriateness must submit a new application with such modifications.**

The filing of this application does not ensure approval as submitted. Applications that do not possess the required submittals or documentation will be considered incomplete and will not be reviewed for approval.

CRITERIA FOR DEMOLITIONS

Before any Certificate of Appropriateness may be issued for a demolition request, the Historic Architectural Review Commission must find that the following requirements are met (please review and comment on each criterion that applies);

- (1) If the subject of the application is a contributing or historic building or structure, then it should not be demolished unless its condition is irrevocably compromised by extreme deterioration or it does not meet any of the following criteria:

- (a) The existing condition of the building or structure is irrevocably compromised by extreme deterioration.

REMOVAL & REPLACEMENT OF FRONT 6'-0" ROOF & COLUMNS
REMOVAL OF "SALT BOX" LEAN TO ALLOWING ADDITION &
REPLACEMENT.

NOTE: ENTIRE STRUCTURE HAS BEEN MODIFIED & COMPROMISED
STRUCTURALLY. REQUIRES FULL REINFORCEMENT AFTER

OR THAT THE BUILDING OR STRUCTURE; "DISCOVERY" PHASES.

- (a) Embodies no distinctive characteristics of a type, period, or method of construction of aesthetic or historic significance in the city and is not a significant and distinguishable building entity whose components may lack individual distinction. N.A.

- (b) Is not specifically associated with events that have made a significant contribution to local, state, or national history. N.A.

- (c) Has no significant character, interest, or value as part of the development, heritage, or cultural characteristics of the city, state or nation, and is not associated with the life of a person significant in the past.

N.A.

- (d) Is not the site of a historic event with a significant effect upon society.

N.A.

- (e) Does not exemplify the cultural, political, economic, social, or historic heritage of the city.

N.A.

- (f) Does not portray the environment in an era of history characterized by a distinctive architectural style.

1930 BUILD OF 'BIRBROW' STYLE HOUSE. STYLE IS
UNIQUE TO KEY WEST

- (g) If a part of or related to a square, park, or other distinctive area, nevertheless should not be developed or preserved according to a plan based on the area's historic, cultural, natural, or architectural motif.

N.A.

- (h) Does not have a unique location or singular physical characteristic which represents an established and familiar visual feature of its neighborhood or of the city, and does not exemplify the best remaining architectural type in a neighborhood.

HOUSE FACES 'GALVESTON LANE' WHICH IS BUT 12'
WIDE. IT IS A SIGNIFICANT FEATURE AS OTHER
STRUCTURES ARE SMALLER OR FACE AWAY FROM LANE.

- (i) Has not yielded, and is not likely to yield, information important in history.

N.A.

CITY OF KEY WEST
CERTIFICATE OF APPROPRIATENESS
APPENDIX FOR DEMOLITIONS
APPLICATION NUMBER H- _____



(2) For a contributing historic or noncontributing building or structure, a complete construction plan for the site is approved by the Historic Architectural Review Commission.

(a) A complete construction plan for the site is included in this application ; CONCEPT FOR APPROVAL.

Yes Number of pages and date on plans 9/15

No Reason CONSTRUCTION DOCUMENTS TO BE DEVELOPED

The following criteria will also be reviewed by the Historic Architectural Review Commission for proposed demolitions. The Commission shall not issue a Certificate of Appropriateness that would result in the following conditions (please review and comment on each criterion that applies);

(1) Removing buildings or structures that are important in defining the overall historic character of a district or neighborhood so that the character is diminished.

N.A.

(2) Removing historic buildings or structures and thus destroying the historic relationship between buildings or structures and open space; and

N.A.

AND

(3) Removing an historic building or structure in a complex; or removing a building facade; or removing a significant later addition that is important in defining the historic character of a site or the surrounding district or neighborhood.

N.A.

(4) Removing buildings or structures that would otherwise qualify as contributing.

N.A.

Nothing in this application is intended to alter the authority of the Building Official to condemn for demolition dangerous buildings, as provided in Section 102-218 of the Land Development Regulations and Chapter 14 of the Code of Ordinances.

*I hereby certify I am the owner of record and that the work shall conform to all applicable laws of this jurisdiction. By receiving a Certificate of Appropriateness, I realize that this project will require a Building Permit, approval **PRIOR** to proceeding with the work outlined above and that there will be a final inspection required under this application. I also understand that any changes to an approved Certificate of Appropriateness must be submitted for review.*

<p><i>Michael Degan</i> Representative and Buyer.</p> <p>PROPERTY OWNER'S SIGNATURE:</p>	<p>8.31.15 <i>Michael Degan</i></p> <p>DATE AND PRINT NAME: MICHAEL B. INERAM.</p>
--	--

OFFICE USE ONLY

BUILDING DESCRIPTION:				
___ Contributing	Year built _____	Style _____	Listed in the NRHP _____	Year _____
___ Not listed	Year built _____	Comments _____		

<p>___ Reviewed by Staff on _____</p> <p>___ Notice of hearing posted _____</p> <p>First reading meeting date _____</p> <p>Second Reading meeting date _____</p> <p>TWO YEAR EXPIRATION DATE _____</p>	<p>Staff Comments</p>
---	---

**City of Key West
Planning Department**



Verification Form

(Where Authorized Representative is an individual)

I, MICHAEL B. INGRAM being duly sworn, depose and say that I am the Authorized Representative of the Owner (as appears on the deed), for the following property identified as the subject matter of this application:

845 GALVESTON LANE

Street address of subject property

All of the answers to the above questions, drawings, plans and any other attached data which make up the application, are true and correct to the best of my knowledge and belief. In the event the City or the Planning Department relies on any representation herein which proves to be untrue or incorrect, any action or approval based on said representation shall be subject to revocation.

Michael B. Ingram -
Signature of Authorized Representative

Subscribed and sworn to (or affirmed) before me on this 08/03/2015 by
MICHAEL B. INGRAM by
Name of Authorized Representative
date

He/She is personally known to me or has presented _____ as identification.

Stacy L. Gibson
Notary's Signature and Seal



STACY L. GIBSON
Name of Acknowledger typed, printed or stamped

FF 170806
Commission Number, if any

This Document Prepared By and Return to:

Evelyn Diane Murphy
845 Galveston Lane
Key West, Florida 33040

RCD Nov 25 2002 09:15AM
DANNY L KOLHAGE, CLERK

Parcel ID Number: 0001921000000010101/1019895

DEED DOC STAMP 0.70
11/25/2002 DEP CLK

Quitclaim Deed

This Quitclaim Deed, Made this 20th day of November, 2002 A.D. Between Sylvester Murphy, Sr., a single man, of the County of Monroe, State of Florida, grantor, and Sylvester Murphy, Sr., a single man, and Evelyn Diane Murphy, a single woman, as joint tenants with full rights of survivorship, whose address is: 845 Galveston Lane, Key West Florida 33040, the County of Monroe, State of Florida, grantees.

Witnesseth that the GRANTOR, for and in consideration of the sum of Ten Dollars (\$10.00) DOLLARS and other good and valuable consideration to GRANTOR in hand paid by Grantee, the receipt whereof is hereby acknowledged, has granted, bargained and quitclaimed to the said GRANTEE and GRANTEE'S heirs, successors and assigns forever, the following described land, situate, lying and being in the County of Monroe State of Florida to wit:

On the Island of Key West, known and described as part of Tract Five (5) according to William A. Whitehead's plan of said Island, but better known and described by reference to diagram of said tract of land laid over into lost by B Windsor Smith, and recorded in Book "E" Page 733, of Monroe County, Florida Records, as Lot No 36; said Lot commencing at a point Fifty (50) feet from Olivia Street on a alleyway parallel with Elizabeth Street and running thence along said alleyway Fifty (50) feet in a Northwesterly direction and extending back at right angles therewith a Northwesterly direction one hundred (100) feet.

THIS DOCUMENT WAS PREPARED WITHOUT BENEFIT OF TITL SEARCH OR ABSTRACT OF TITLE EXAMINATION AND ID BASED ON FACTS PROVIDED BY EITHER OF THE PARTIES.

***This deed is being re-executed and re-recorded in order to correct that prior deed between the parties filed in Official Records Book 1718, Page 311, wherein said deed transferred all of Sylvester Murphy Sr.'s interest to Evelyn Diane Murphy in lieu of transferring interest to both Sylvester and Evelyn as joint tenants with full rights of survivorship.

To Have and to Hold the same together with all and singular the appurtenances therunto belonging or in anywise appertaining, and all the estate, right, title, interest, lien, equity and claim whatsoever of grantor, either in law or equity, for the use, benefit and profit of the said grantee forever.

In Witness whereof, the grantor has hereunto set hand and seal the day and year first above written.

Signed, sealed and delivered in our presence:

Jeffrey Humbert
Printed name KENNETH RAHMING

Sylvester Murphy, Sr.
Sylvester Murphy, Sr.

X
Printed name Sylvester Murphy

STATE OF FLORIDA)

COUNTY OF MONROE)

The foregoing instrument was acknowledged before me this 23 day of November, 2002, by Sylvester Murphy, Sr. who is personally known to me or who has produced a Florida driver's license as identification and did take an oath.

My commission expires:



Jose H. Planas
Notary Public, State of Florida
JOSE H. PLANAS



THE CITY OF KEY WEST

Building Department
P.O.Box 1409, Key West, FL 33040

2015

Homeowner Agent Authorization Letter

Property Address: 845 Galveston Lane, Key West, FL 33040

Homeowner Name: Evelyn Diane Murphy

Agent Name(s): _____

I, Evelyn Diane Murphy, hereby authorize the above listed agent(s) to sign
Homeowner name

for permits for _____, for the calendar year ending
project name/address, or unlimited

December 31, 2015.

The undersigned understands the liabilities involved in the granting of this authority and accepts full responsibility (thus holding the City of Key West harmless) for any and all of the actions of the agent(s) named related to the acquisition of permits for the contracting company listed above.

Further the homeowner acknowledges all rules and restrictions set forth in the disclosure statement pursuant to Florida Statute 489.103(7).

Evelyn Diane Murphy
Signature of Homeowner

State of Florida
County of Monroe

Subscribed and sworn to before me this 19th day of August, 2015.

Patricia A. Eables
Notary Public (seal)

Patricia A. Eables

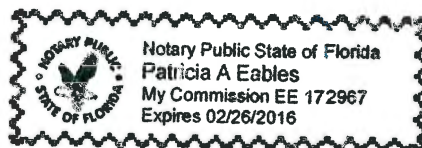

SANBORN MAPS

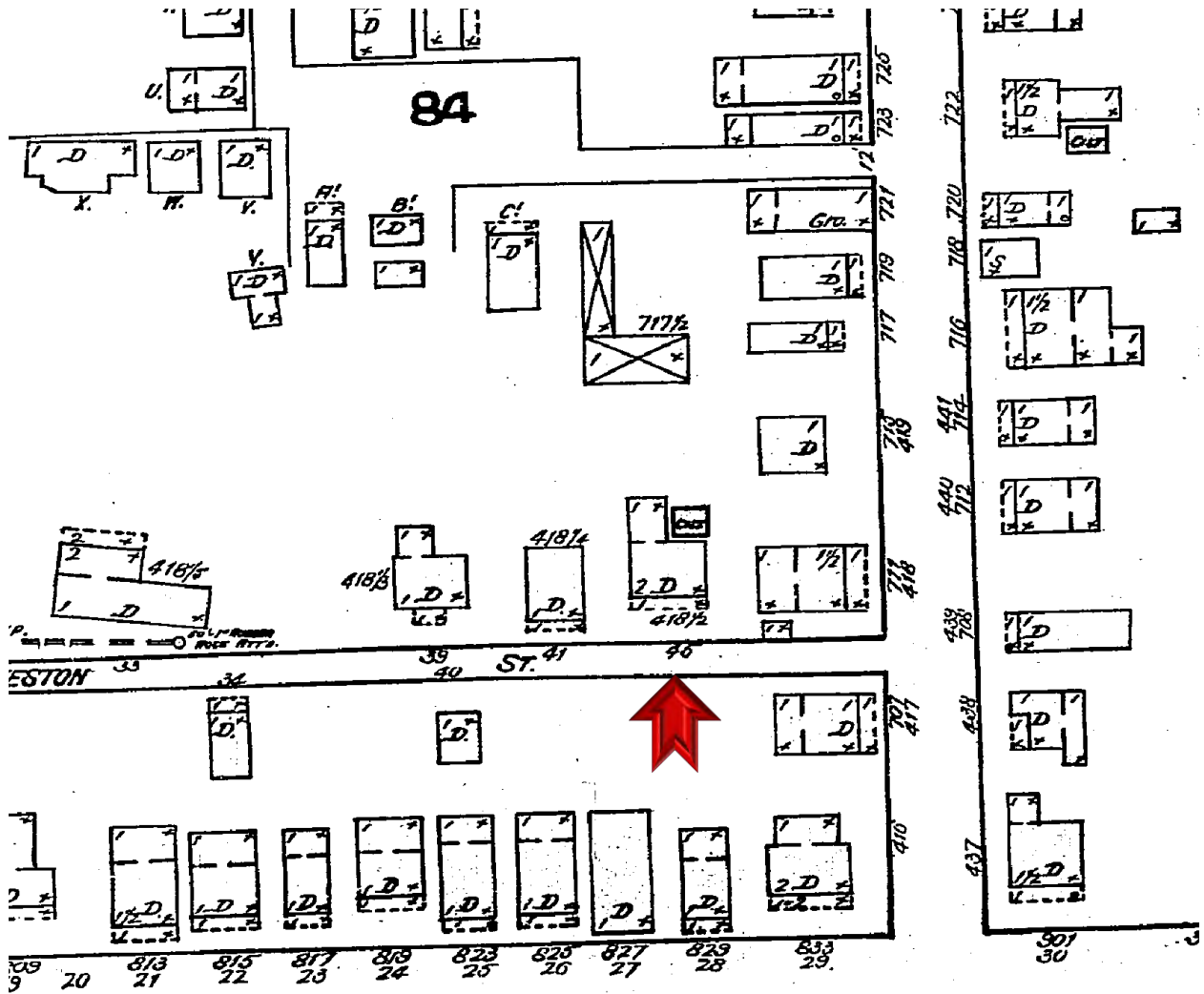

#845 Galveston Lane Sanborn map 1892

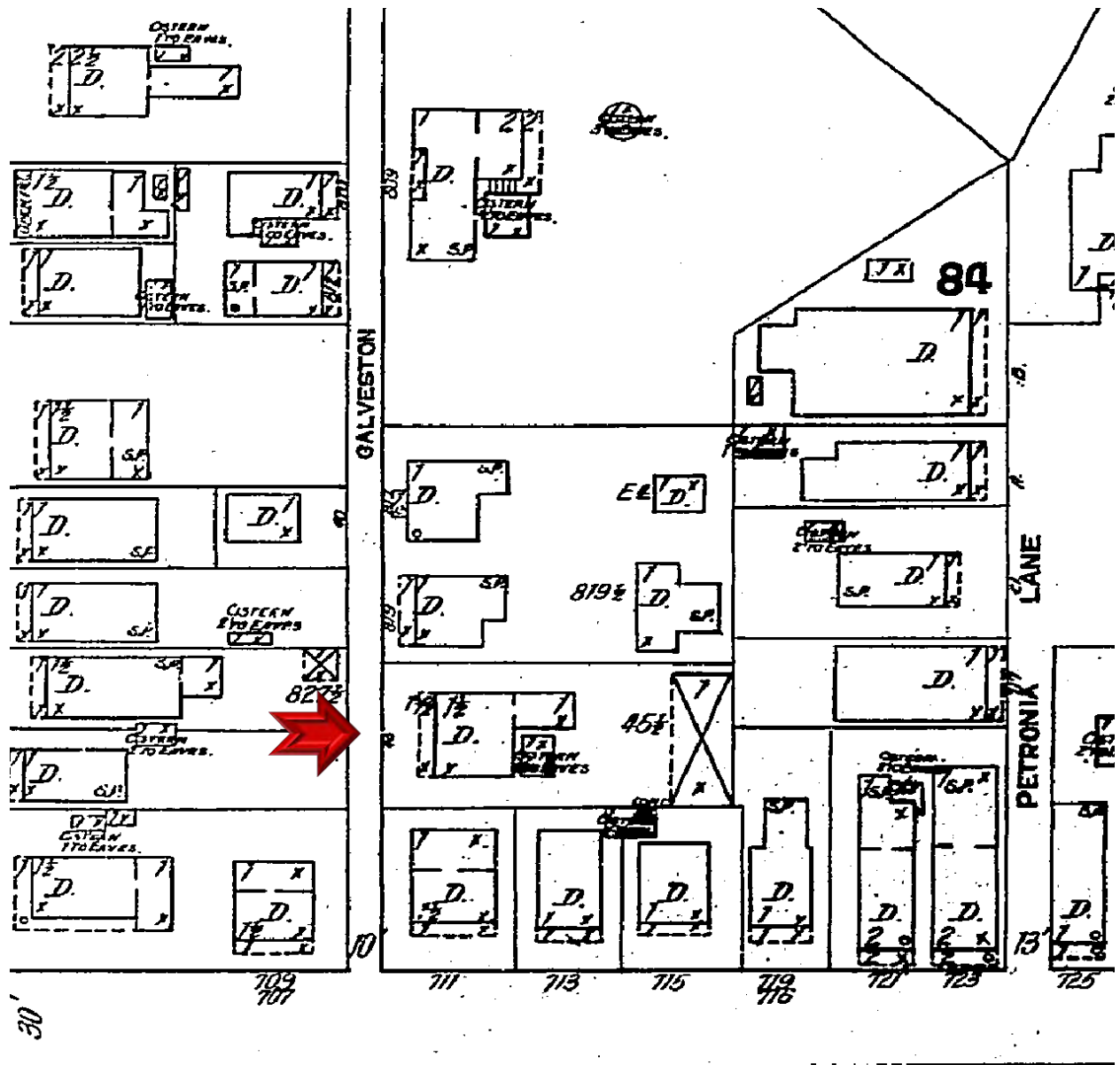

#845 Galveston Lane Sanborn map 1912

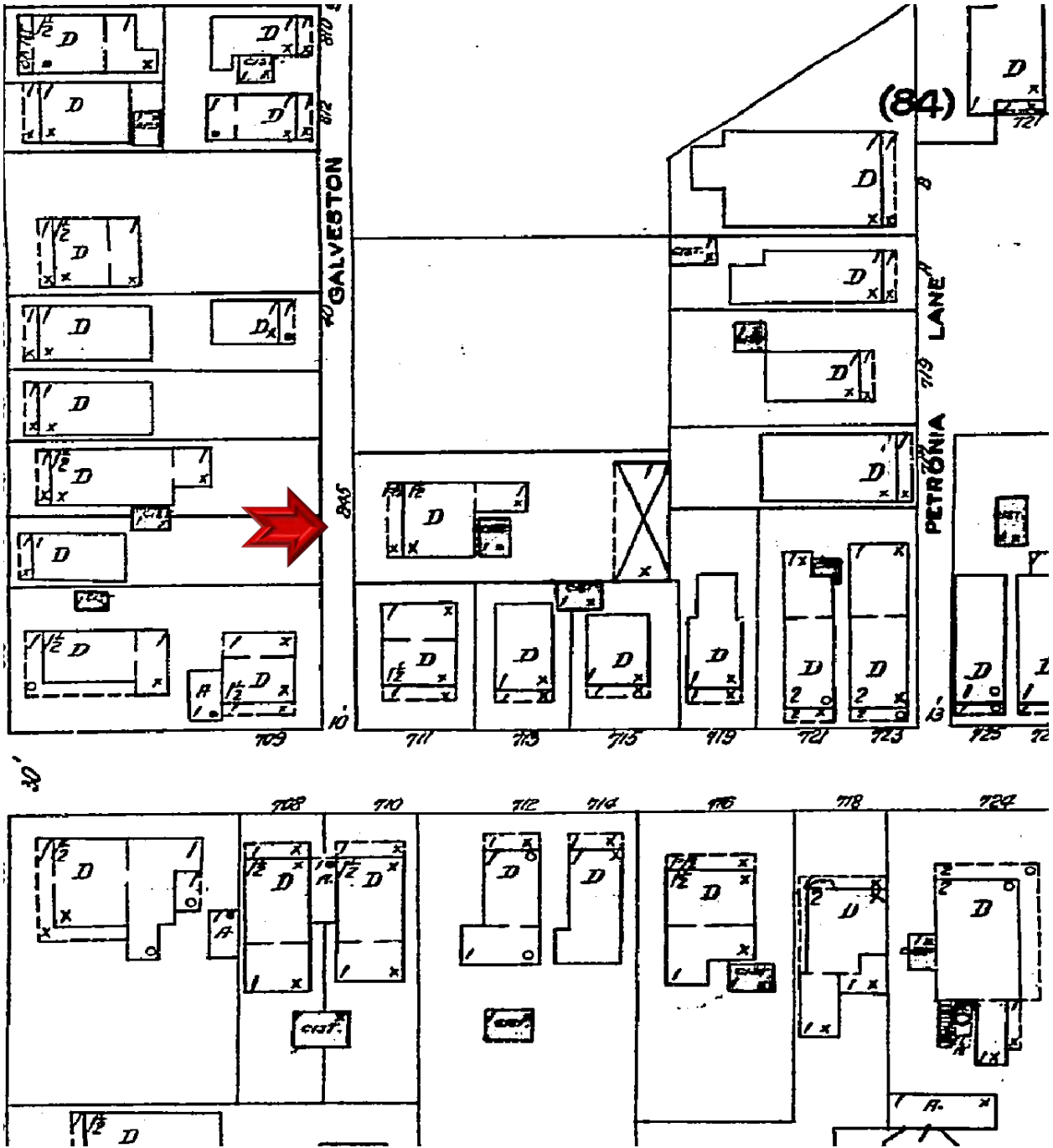

#845 Galveston Lane Sanborn map 1926

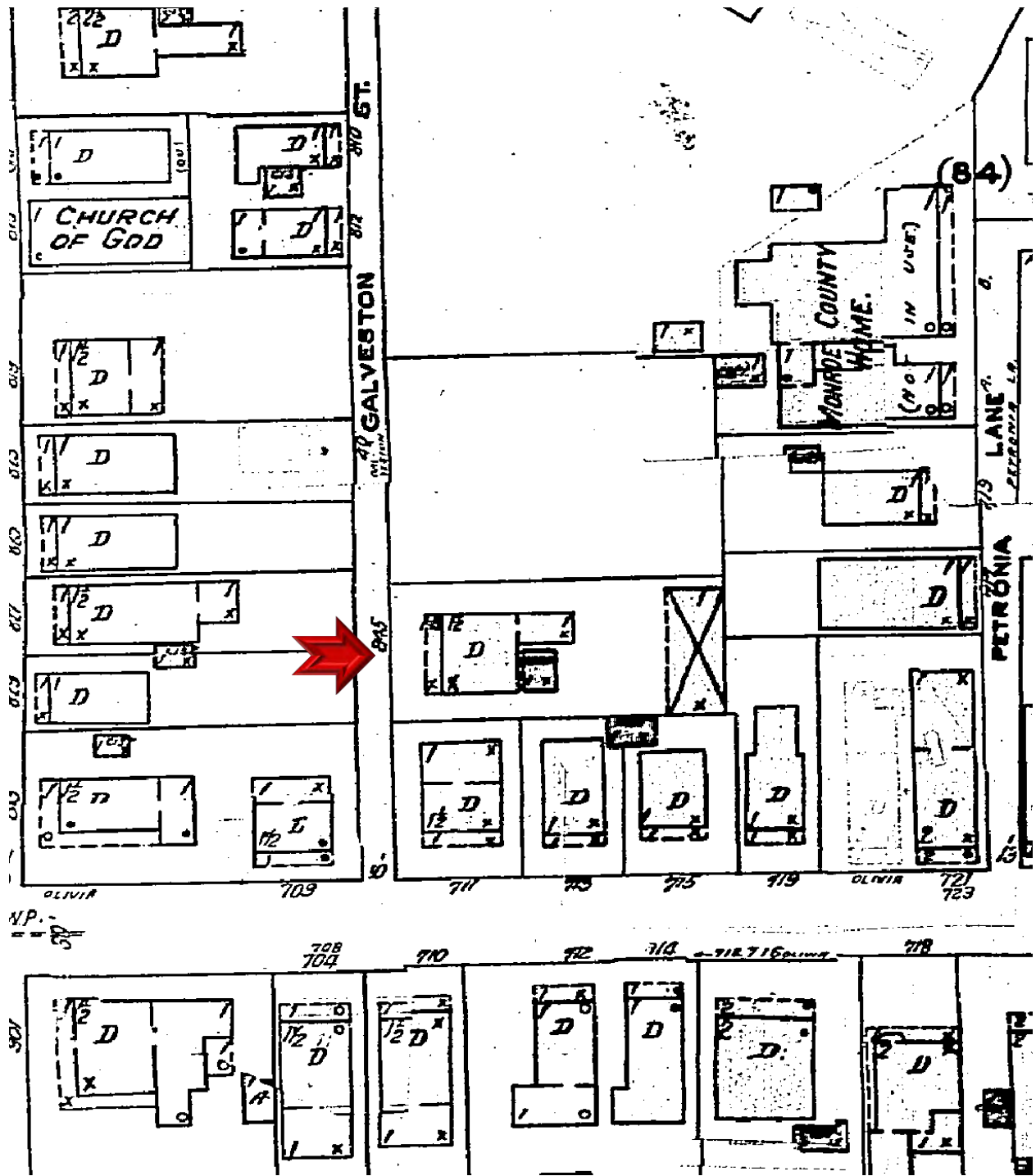

#845 Galveston Lane Sanborn map 1948

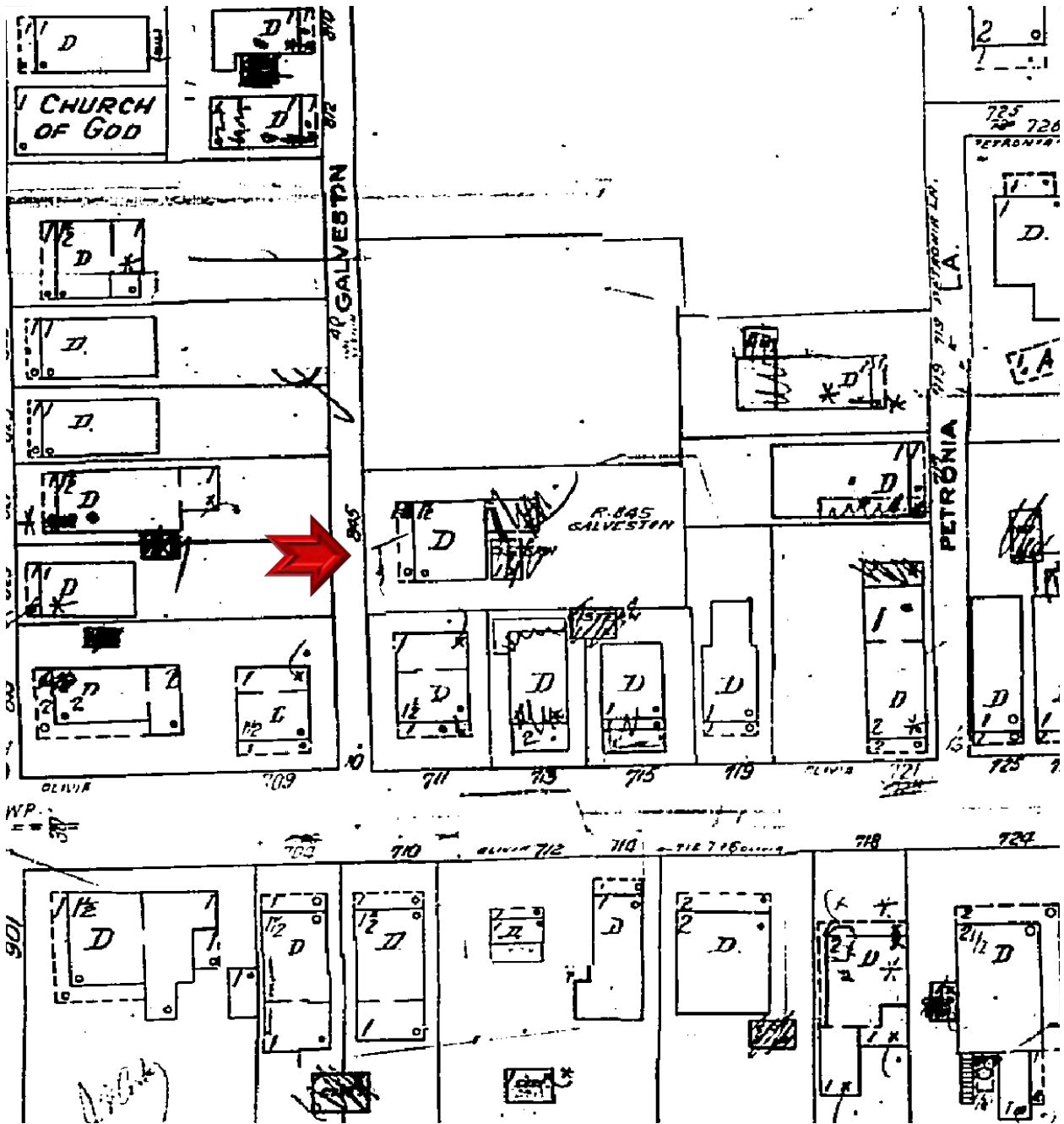

#845 Galveston Lane Sanborn map 1962

PROJECT PHOTOS



#845 Galveston Lane circa 1965. Monroe County Library



845



























NO
TRUCKS

SURVEY

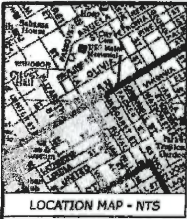

**MAP OF BOUNDARY & TOPOGRAPHIC SURVEY
PART OF TRACT FIVE
WILLIAM A WHITEHEAD'S MAP
KEY WEST, FLORIDA**



NORTH
ASSUMED FROM PLAT
OR LEGAL DESCRIPTION

SCALE: 1" = 10'

BENCHMARK:
SET NAIL & DISC
LB7846 IN UPC
EL. = 8.00', NGVD29

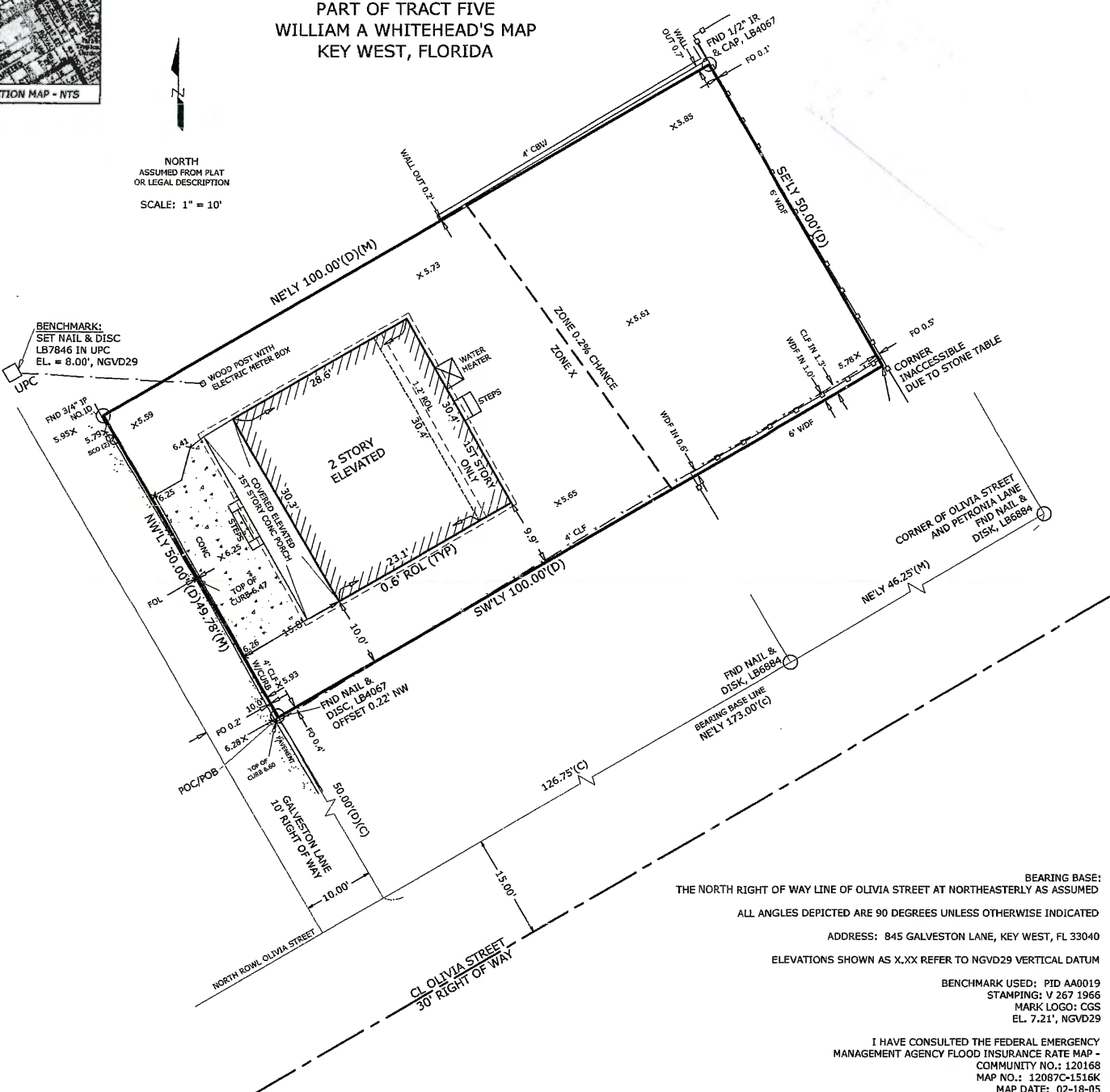

BEARING BASE:
THE NORTH RIGHT OF WAY LINE OF OLIVIA STREET AT NORTHEASTERLY AS ASSUMED

ALL ANGLES DEPICTED ARE 90 DEGREES UNLESS OTHERWISE INDICATED

ADDRESS: 845 GALVESTON LANE, KEY WEST, FL 33040

ELEVATIONS SHOWN AS X.XX REFER TO NGVD29 VERTICAL DATUM

BENCHMARK USED: PID A0019
STAMPING: V 267 1966
MARK LOGO: CGS
EL. 7.21', NGVD29

I HAVE CONSULTED THE FEDERAL EMERGENCY
MANAGEMENT AGENCY FLOOD INSURANCE RATE MAP -
COMMUNITY NO.: 120168
MAP NO.: 12087C-1516K
MAP DATE: 02-18-05
REVISED EFFECTIVE DATE: 06-05-15
THE HERON DESCRIBED PROPERTY APPEARS
TO BE IN - FLOOD ZONE: ZONE X
BASE ELEVATION: NA NGVD 29 DATUM.

This parcel crosses more than one National Flood Insurance Program Flood Zone line(s), the approximate location of which are shown hereon. These lines are approximate in their location, as scaled from F.E.M.A. Flood Insurance Rate Map, Panel No. 1516, last revised on 02/18/05. The flood map is at a scale of 1" = 500' &. At this scale the line itself is 1/8" in width. In addition to the small scale the map is extremely vague, making precise location of the subject parcel impossible. These lines are shown hereon for informational purposes only, and should not be used as the sole criteria for determining construction limits. The location of these lines should be verified by the appropriate authorities prior to construction.

LEGAL DESCRIPTION -

On the Island of Key West, known and described as part of Tract Five(5) according to William A. Whitehead's plan of said Island, but better known and described by reference to diagram of said tract of land laid over into lost by B Winslow Smith, and recorded in Book "E" Page 733, of Monroe County, Florida Records, as Lot No. 36; said Lot commencing at a point Fifty(50) feet from Olivia Street on an alleyway parallel with Elizabeth Street and running thence along said alleyway Fifty(50) feet in a Northwesterly direction and extending back at right angles therewith a Northeasterly direction one hundred (100) feet.

CERTIFIED TO -

Stones & Cardenas
Chicago Title Insurance Company
Wayne Larsen & Michael Ingram

SCALE: 1"=10'
FIELD WORK DATE: 06/18/15
REVISION DATE: -/-
SHEET 1 OF 1
DRAWN BY: KK
CHECKED BY: RER
INVOICE #: 15072701

I HEREBY CERTIFY THAT THIS SURVEY WAS MADE UNDER MY RESPONSIBLE CHARGE AND MEETS THE STANDARDS OF PRACTICE AS SET FORTH BY THE FLORIDA BOARD OF PROFESSIONAL SURVEYORS AND MAPPERS IN CHAPTER 55-17, FLORIDA ADMINISTRATIVE CODE, PURSUANT TO SECTION 473.022, FLORIDA STATUTES. THIS SURVEY, WHEN SCHEDULE B HAS BEEN PROVIDED MEETS THE PROVISIONS OF FLORIDA ENDORSEMENT FORM B. SUBPROGRAM 110 (115 TRACKS), 100(ENDORSEMENTS), & 1(6)(EASEMENTS), SCHEDULE "B" HAS NOT BEEN PROVIDED.

SIGNED: [Signature]
[Signature]

NOT VALID WITHOUT THE SIGNATURE AND THE ORIGINAL BASED SEAL OF A FLORIDA SURVEYOR AND MAPPER

REECE & ASSOCIATES
PROFESSIONAL SURVEYOR AND MAPPER, LB 7846
127 INDUSTRIAL ROAD, BIG PINE KEY, FL 33043
OFFICE: (305) 872 - 1348
FAX: (305) 872 - 5622

NOTES:

THIS SURVEY WAS PERFORMED FOR THE SOLE AND EXCLUSIVE BENEFIT OF THE PARTIES LISTED HEREIN AND SHALL NOT BE RELIED UPON BY ANY OTHER ENTITY OR INDIVIDUAL, WHOSOEVER, LIKEWISE, ANY REUSE OF THIS SURVEY FOR ANY PURPOSE OTHER THAN WHICH WAS ORIGINALLY INTENDED, WITHOUT THE WRITTEN PERMISSION OF THE UNDERSIGNED SURVEYOR & MAPPER, WILL BE DONE SO AT THE RISK OF THE REUSING PARTY AND WITHOUT ANY LIABILITY TO THE UNDERSIGNED SURVEYOR & MAPPER.

LEGAL DESCRIPTIONS HAVE BEEN FURNISHED BY THE CLIENT OR HIS/HER REPRESENTATIVE. PUBLIC RECORDS HAVE NOT BEEN RESEARCHED BY THE SURVEYOR TO DETERMINE THE ACCURACY OF THESE DESCRIPTIONS NOR HAVE ADDITIONAL PROPERTIES BEEN RESEARCHED TO DETERMINE OVERLAPS OR HIATUS.

THIS SURVEY DOES NOT PURPORT TO SHOW OWNERSHIP OF WALLS OR FENCES ALONG PROPERTY LINES. ADDITIONS OR DELETIONS TO THIS SURVEY MAP BY OTHER THAN THE SIGNING PARTY OR PARTIES IS PROHIBITED WITHOUT WRITTEN CONSENT OF THE SIGNING PARTY OR PARTIES.

NOTE: MEASURED DIMENSIONS EQUAL PLATTED OR DESCRIBED DIMENSIONS UNLESS INDICATED OTHERWISE. FOUNDATIONS BENEATH THE SURFACE ARE NOT SHOWN.

THE FOLLOWING IS A LIST OF ABBREVIATIONS THAT MAY BE FOUND ON THIS SHEET.

BP = BACK-SLOPE PREVENTER	FI = FENCE INBREDE	PC = POINT OF CURVE	PT = PLAT
BO = BULK-OUT	FO = FOUND	PC = POINT OF BEGINNING	TC = TOP OF FINISH
C = CALCULATED	FND = FOUND NAIL & DISK (1/2" DIA)	PC = POINT OF CORNER/END CURVE	TIP = TYPICAL
CB = CONCRETE BLOCK	FO = FENCE OUTSIDE	PC = PERMANENT CONTROL POINT	UB = UNBUTTED
CE = CONCRETE	FOL = FENCE ON LINE	PC = PAPER/ONLINE NAIL	UC = CONCRETE UTILITY POLE
CL = CENTERLINE	GI = GRADE INLET	PC = PERMANENT CONTROL POINT	UIC = UTILITY CLIP
CL = CENTERLINE	GO = GRADE OUTSIDE	PC = POINT OF BEGINNING	UP = UNDERPASS
CL = CENTERLINE	GR = GRADE INLET	PC = POINT OF REVERSE CURVE	UR = UNDERPASS
CL = CENTERLINE	GS = GRADE SLAB	PC = PERMANENT REFERENCE	US = UTILITY
CL = CENTERLINE	IC = CONCRETE INLET	PC = POINT OF REVERSE CURVE	W = WATER
CN = CONCRETE NAIL	IP = IRON PIPE	PC = PERMANENT REFERENCE	WA = WATER
CN = CONCRETE NAIL	IS = IRON ROD	PC = POINT OF BEGINNING	WB = WATER
CN = CONCRETE NAIL	LC = LUG LENGTHS	PC = PERMANENT REFERENCE	WC = WATER
CN = CONCRETE NAIL	LE = LOWER ENVELOPE	PC = POINT OF BEGINNING	WV = WATER
CN = CONCRETE NAIL	LI = LINE	PC = PERMANENT REFERENCE	WV = WATER
CN = CONCRETE NAIL	LI = LINE	PC = POINT OF BEGINNING	WV = WATER
CN = CONCRETE NAIL	LI = LINE	PC = PERMANENT REFERENCE	WV = WATER
CN = CONCRETE NAIL	LI = LINE	PC = POINT OF BEGINNING	WV = WATER
CN = CONCRETE NAIL	LI = LINE	PC = PERMANENT REFERENCE	WV = WATER
CN = CONCRETE NAIL	LI = LINE	PC = POINT OF BEGINNING	WV = WATER
CN = CONCRETE NAIL	LI = LINE	PC = PERMANENT REFERENCE	WV = WATER

ELEVATION CERTIFICATE

Important: Read the instructions on pages 1-9.

OMB No. 1660-0008
 Expiration Date: July 31, 2015

SECTION A - PROPERTY INFORMATION

A1. Building Owner's Name <u>Wayne Larsen & Michael Ingram</u>		FOR INSURANCE COMPANY USE	
A2. Building Street Address (including Apt., Unit, Suite, and/or Bldg. No.) or P.O. Route and Box No. <u>846 Galveston Lane</u>		Policy Number	
City <u>Key West</u> State <u>FL</u> ZIP Code <u>33040</u>		Company NAIC Number	
A3. Property Description (Lot and Block Numbers, Tax Parcel Number, Legal Description, etc.) <u>KW Lot 36 of TR 5; RE# 00019210-000000</u>			
A4. Building Use (e.g., Residential, Non-Residential, Addition, Accessory, etc.) <u>Residential</u>			
A5. Latitude/Longitude: Lat. <u>N 24 33 14.8</u>		Long. <u>W 81 47 50.4</u>	
Horizontal Datum: <input type="checkbox"/> NAD 1927 <input checked="" type="checkbox"/> NAD 1983			
A6. Attach at least 2 photographs of the building if the Certificate is being used to obtain flood insurance.			
A7. Building Diagram Number <u>5</u>			
A8. For a building with a crawlspace or enclosure(s):		A9. For a building with an attached garage:	
a) Square footage of crawlspace or enclosure(s) <u>NA</u> sq ft	a) Square footage of attached garage <u>NA</u> sq ft		
b) Number of permanent flood openings in the crawlspace or enclosure(s) within 1.0 foot above adjacent grade <u>NA</u>	b) Number of permanent flood openings in the attached garage within 1.0 foot above adjacent grade <u>NA</u>		
c) Total net area of flood openings in A8.b <u>NA</u> sq in	c) Total net area of flood openings in A9.b <u>NA</u> sq in		
d) Engineered flood openings? <input type="checkbox"/> Yes <input type="checkbox"/> No	d) Engineered flood openings? <input type="checkbox"/> Yes <input type="checkbox"/> No		

SECTION B - FLOOD INSURANCE RATE MAP (FIRM) INFORMATION

B1. NFIP Community Name & Community Number <u>City of Key West 120168</u>		B2. County Name <u>Monroe</u>		B3. State <u>Florida</u>	
B4. Map/Panel Number <u>12087C1516</u>	B5. Suffix <u>K</u>	B6. FIRM Index Date <u>02/18/2005</u>	B7. FIRM Panel Effective/Revised Date <u>02/18/2005</u>	B8. Flood Zone(s) <u>X</u>	B9. Base Flood Elevation(s) (Zone AO, use base flood depth) <u>NA</u>
310. Indicate the source of the Base Flood Elevation (BFE) data or base flood depth entered in Item B9. <input type="checkbox"/> FIS Profile <input checked="" type="checkbox"/> FIRM <input type="checkbox"/> Community Determined <input type="checkbox"/> Other/Source: _____					
311. Indicate elevation datum used for BFE in Item B9: <input checked="" type="checkbox"/> NGVD 1929 <input type="checkbox"/> NAVD 1988 <input type="checkbox"/> Other/Source: _____					
312. Is the building located in a Coastal Barrier Resources System (CBRS) area or Otherwise Protected Area (OPA)? <input type="checkbox"/> Yes <input checked="" type="checkbox"/> No Designation Date: <u>N/A</u> <input type="checkbox"/> CBRS <input type="checkbox"/> OPA					

SECTION C - BUILDING ELEVATION INFORMATION (SURVEY REQUIRED)

21. Building elevations are based on: Construction Drawings* Building Under Construction* Finished Construction
 *A new Elevation Certificate will be required when construction of the building is complete.

22. Elevations - Zones A1-A30, AE, AH, A (with BFE), VE, V1-V30, V (with BFE), AR, AR/A, AR/AE, AR/A1-A30, AR/AH, AR/AO. Complete Items C2.a-h below according to the building diagram specified in Item A7. In Puerto Rico only, enter meters.
 Benchmark Utilized: PIDAA0019 Elevation 7.21' Vertical Datum: NGVD-1929
 Indicate elevation datum used for the elevations in items a) through h) below. NGVD 1929 NAVD 1988 Other/Source: _____
 Datum used for building elevations must be the same as that used for the BFE.

Check the measurement used.

a) Top of bottom floor (including basement, crawlspace, or enclosure floor)	<u>8.3</u>	<input checked="" type="checkbox"/> feet	<input type="checkbox"/> meters
b) Top of the next higher floor	<u>NA</u>	<input type="checkbox"/> feet	<input type="checkbox"/> meters
c) Bottom of the lowest horizontal structural member (V Zones only)	<u>NA</u>	<input type="checkbox"/> feet	<input type="checkbox"/> meters
d) Attached garage (top of slab)	<u>NA</u>	<input type="checkbox"/> feet	<input type="checkbox"/> meters
e) Lowest elevation of machinery or equipment servicing the building (Describe type of equipment and location in Comments)	<u>6.8</u>	<input checked="" type="checkbox"/> feet	<input type="checkbox"/> meters
f) Lowest adjacent (finished) grade next to building (LAG)	<u>5.2</u>	<input checked="" type="checkbox"/> feet	<input type="checkbox"/> meters
g) Highest adjacent (finished) grade next to building (HAG)	<u>5.7</u>	<input checked="" type="checkbox"/> feet	<input type="checkbox"/> meters
h) Lowest adjacent grade at lowest elevation of deck or stairs, including structural support	<u>NA</u>	<input type="checkbox"/> feet	<input type="checkbox"/> meters

SECTION D - SURVEYOR, ENGINEER, OR ARCHITECT CERTIFICATION

This certification is to be signed and sealed by a land surveyor, engineer, or architect authorized by law to certify elevation information. I certify that the information on this Certificate represents my best efforts to interpret the data available. I understand that any false statement may be punishable by fine or imprisonment under 18 U.S. Code, Section 1001.

Check here if comments are provided on back of form. Were latitude and longitude in Section A provided by a licensed land surveyor? Yes No
 Check here if attachments.

Certifier's Name <u>Robert E. Reece</u>	License Number <u>5632</u>
Title <u>Professional Surveyor & Mapper</u>	Company Name <u>Reece & White Land Surveying, Inc.</u>
Address <u>127 ... Road, Suite B</u>	City <u>Big Pine Key</u> State <u>FL</u> ZIP Code <u>33043</u>
Signature <u>[Signature]</u>	Date <u>03/10/2015</u> Telephone <u>305-872-1348</u>

PLACE SEAL HERE
 STATE OF FLORIDA
 LS #5632
 08-10-2015

ELEVATION CERTIFICATE, page 2

IMPORTANT: In these spaces, copy the corresponding information from Section A.	FOR INSURANCE COMPANY USE
Building Street Address (including Apt., Unit, Suite, and/or Bldg. No.) or P.O. Route and Box No. 845 Galveston Lane	Policy Number:
City Key West State FL ZIP Code 33040	Company NAIC Number:

SECTION D – SURVEYOR, ENGINEER, OR ARCHITECT CERTIFICATION (CONTINUED)

Copy both sides of this Elevation Certificate for (1) community official, (2) insurance agent/company, and (3) building owner.

Comments A5. Hand Held Device; C2. e) Bottom of water heater located at the rear of the home. A/C are window units.

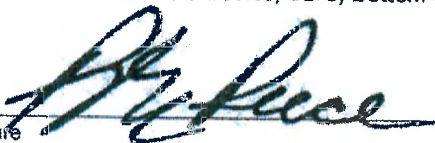
Signature 

Date 08/10/2015

SECTION E – BUILDING ELEVATION INFORMATION (SURVEY NOT REQUIRED) FOR ZONE AO AND ZONE A (WITHOUT BFE)

For Zones AO and A (without BFE), complete Items E1–E5. If the Certificate is intended to support a LOMA or LOMR-F request, complete Sections A, B, and C. For Items E1–E4, use natural grade, if available. Check the measurement used. In Puerto Rico only, enter meters.

- E1. Provide elevation information for the following and check the appropriate boxes to show whether the elevation is above or below the highest adjacent grade (HAG) and the lowest adjacent grade (LAG).
 - a) Top of bottom floor (including basement, crawlspace, or enclosure) is _____ feet meters above or below the HAG.
 - b) Top of bottom floor (including basement, crawlspace, or enclosure) is _____ feet meters above or below the HAG.
- E2. For Building Diagrams 6–9 with permanent flood openings provided in Section A Items 8 and/or 9 (see pages 8–9 of Instructions), the next higher floor (elevation C2.b in the diagrams) of the building is _____ feet meters above or below the HAG.
- E3. Attached garage (top of slab) is _____ feet meters above or below the HAG.
- E4. Top of platform of machinery and/or equipment servicing the building is _____ feet meters above or below the HAG.
- E5. Zone AO only: If no flood depth number is available, is the top of the bottom floor elevated in accordance with the community's floodplain management ordinance? Yes No Unknown. The local official must certify this information in Section G.

SECTION F – PROPERTY OWNER (OR OWNER'S REPRESENTATIVE) CERTIFICATION

The property owner or owner's authorized representative who completes Sections A, B, and E for Zone A (without a FEMA-issued or community-issued BFE) or Zone AO must sign here. The statements in Sections A, B, and E are correct to the best of my knowledge.

Property Owner's or Owner's Authorized Representative's Name _____

Address _____ City _____ State _____ ZIP Code _____

Signature _____ Date _____ Telephone _____

Comments _____

Check here if attachments.

SECTION G – COMMUNITY INFORMATION (OPTIONAL)

The local official who is authorized by law or ordinance to administer the community's floodplain management ordinance can complete Sections A, B, C (or E), and G of this Elevation Certificate. Complete the applicable item(s) and sign below. Check the measurement used in Items G8–G10. In Puerto Rico only, enter meters.

- G1. The information in Section C was taken from other documentation that has been signed and sealed by a licensed surveyor, engineer, or architect who is authorized by law to certify elevation information. (Indicate the source and date of the elevation data in the Comments area below.)
- G2. A community official completed Section E for a building located in Zone A (without a FEMA-issued or community-issued BFE) or Zone AO.
- G3. The following information (Items G4–G10) is provided for community floodplain management purposes.

G4. Permit Number	G5. Date Permit Issued	G6. Date Certificate Of Compliance/Occupancy Issued
-------------------	------------------------	---

- G7. This permit has been issued for: New Construction Substantial Improvement
- G8. Elevation of as-built lowest floor (including basement) of the building: feet meters Datum _____
- G9. BFE or (in Zone AO) depth of flooding at the building site: feet meters Datum _____
- G10. Community's design flood elevation: feet meters Datum _____

Local Official's Name _____ Title _____

Community Name _____ Telephone _____

Signature _____ Date _____

Comments _____

Check here if attachments.

Building Photographs

See Instructions for Item A6.

IMPORTANT: In these spaces, copy the corresponding information from Section A.

FOR INSURANCE COMPANY USE

Building Street Address (including Apt., Unit, Suite, and/or Bldg. No.) or P.O. Route and Box No.
845 Galveston Lane

Policy Number:

City **Key West**

State **FL**

ZIP Code **33040**

Company NAIC Number:

If using the Elevation Certificate to obtain NFIP flood insurance, affix at least 2 building photographs below according to the instructions for Item A6. Identify all photographs with date taken, "Front View" and "Rear View"; and, if required, "Right Side View" and "Left Side View." When applicable, photographs must show the foundation with representative examples of the flood openings or vents, as indicated in Section A8. If submitting more photographs than will fit on this page, use the Continuation Page.

Front View



Right Side View

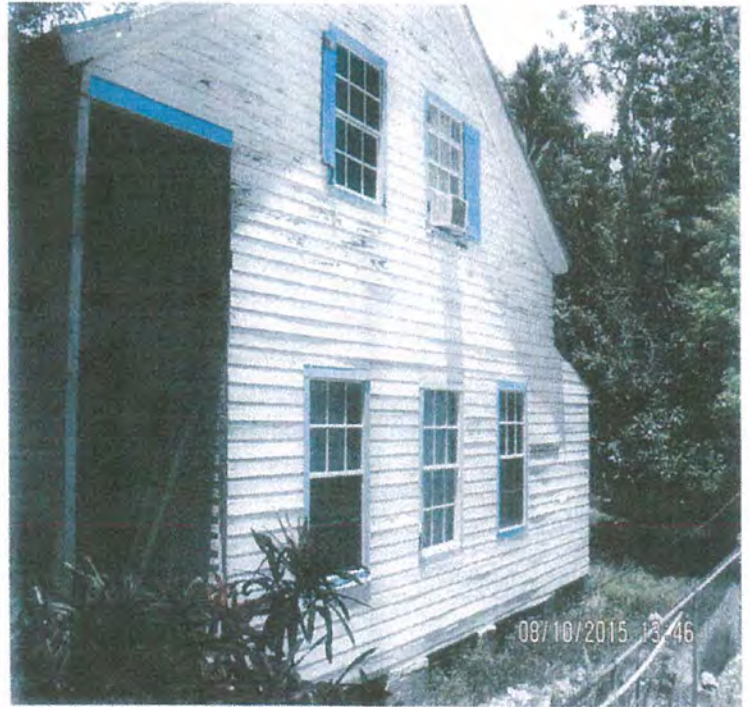

Left Side View from Rear

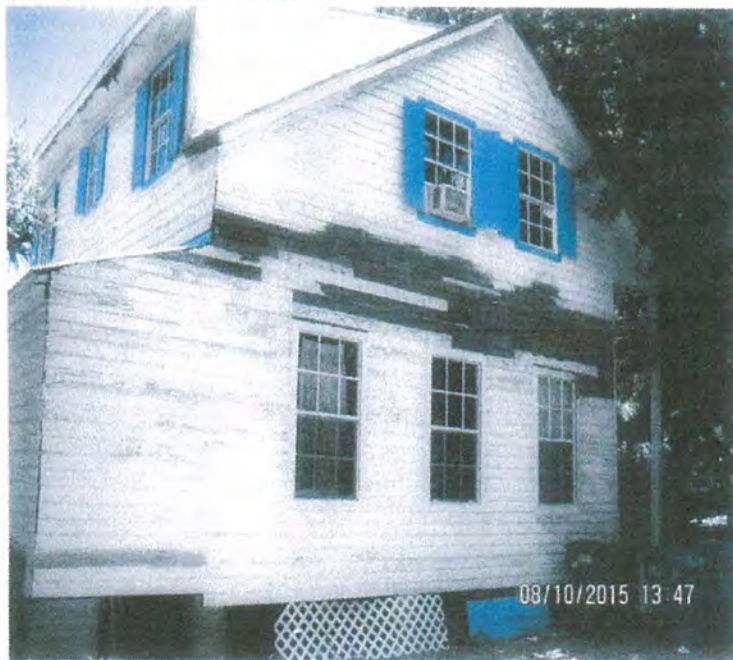

Rear View



PROPOSED DESIGN

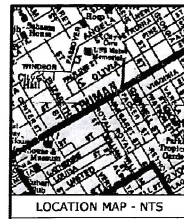

MAP OF BOUNDARY & TOPOGRAPHIC SURVEY PART OF TRACT FIVE WILLIAM A WHITEHEAD'S MAP KEY WEST, FLORIDA

NORTH ASSUMED FROM PLAT OR LEGAL DESCRIPTION
SCALE: 1" = 10'



BEARING BASE:
THE NORTH RIGHT OF WAY LINE OF OLIVIA STREET AT NORTHEASTERLY AS ASSUMED
ALL ANGLES DEPICTED ARE 90 DEGREES UNLESS OTHERWISE INDICATED
ADDRESS: 845 GALVESTON LANE, KEY WEST, FL 33040
ELEVATIONS SHOWN AS X.XX REFER TO NGVD29 VERTICAL DATUM
BENCHMARK USED: PID AA0019
STAMPING: V 267 1966
MARK LOGO: CGS
EL. 7.21', NGVD29

I HAVE CONSULTED THE FEDERAL EMERGENCY MANAGEMENT AGENCY FLOOD INSURANCE RATE MAP - COMMUNITY NO.: 120168
MAP NO.: 12087C-1516K
MAP DATE: 02-18-05
REVISED EFFECTIVE DATE: 06-05-15
THE HERON DESCRIBED PROPERTY APPEARS TO BE IN - FLOOD ZONE: ZONE X
BASE ELEVATION: NA NGVD 29 DATUM.

NOTES:
THIS SURVEY WAS PERFORMED FOR THE SOLE AND EXCLUSIVE BENEFIT OF THE PARTIES LISTED HEREIN AND SHALL NOT BE RELIED UPON BY ANY OTHER ENTITY OR INDIVIDUAL WHOSEVER. LIKEWISE, ANY REUSE OF THIS SURVEY FOR ANY PURPOSE OTHER THAN WHICH WAS ORIGINALLY INTENDED, WITHOUT THE WRITTEN PERMISSION OF THE UNDERSIGNED SURVEYOR & MAPPER, WILL BE DONE SO AT THE RISK OF THE REUSING PARTY AND WITHOUT ANY LIABILITY TO THE UNDERSIGNED SURVEYOR & MAPPER.
LOCAL DESCRIPTIONS HAVE BEEN FURNISHED BY THE CLIENT OR HIS/HER REPRESENTATIVE. PUBLIC RECORDS HAVE NOT BEEN RESEARCHED BY THE SURVEYOR TO DETERMINE THE ACCURACY OF THESE DESCRIPTIONS NOR HAVE ADJOINING PROPERTIES BEEN RESEARCHED TO DETERMINE OVERLAPS OR HIATUS.
THIS SURVEY DOES NOT PURPORT TO SHOW OWNERSHIP OF WALLS OR FENCES ALONG PROPERTY LINES. ADDITIONS OR DELETIONS TO THIS SURVEY MAP BY OTHER THAN THE SIGNING PARTY OR PARTIES IS PROHIBITED WITHOUT WRITTEN CONSENT OF THE SIGNING PARTY OR PARTIES.

This parcel crosses more than one National Flood Insurance Program Flood Zone line(s), the approximate location of which are shown hereon. These lines are approximate in their location, as scaled from F.E.M.A. Flood Insurance Rate Map, Panel No. 1516, last revised on 02/18/05. The Flood map is at a scale of 1" = 500'. At this scale the line itself is 10" in width. In addition to the small scale the map is extremely vague, making precise location of the subject parcel impossible. These lines are shown hereon for informational purposes only, and should not be used as the sole criteria for determining construction limits. The location of these lines should be verified by the appropriate authorities prior to construction.

LEGAL DESCRIPTION -
On the Island of Key West, known and described as part of Tract Five(5) according to William A. Whitehead's plan of said Island, but better known and described by reference to diagram of said tract of land laid over into lot by B Winslow Smith, and recorded in Book "E" Page 733, of Monroe County, Florida Records, as Lot No. 36; said Lot commencing at a point Fifty(50) feet from Olivia Street on an alleyway parallel with Elizabeth Street and running thence along said alleyway Fifty(50) feet in a Northwesterly direction and extending back at right angles therewith a Northwesterly direction one hundred (100) feet.

CERTIFIED TO -
Stones & Cardenas
Chicago Title Insurance Company
Wayne Larsen & Michael Ingram

REECE & ASSOCIATES
PROFESSIONAL SURVEYOR AND MAPPER, LB 7846
127 INDUSTRIAL ROAD, BIG PINE KEY, FL 33043
OFFICE (305) 872 - 1348
FAX (305) 872 - 5622

SCALE: 1" = 10'
FIELD WORK: 08/18/15
REVISION: -/-/-
DATE: -/-/-
SHEET: 1 OF 1
DRAWN BY: KK
CHECKED BY: RER
UNIVERSAL: 15072201

SITE DATA TABLE				
845 Galveston Lane				
	CODE REQUIREMENT	EXISTING (*A)	PROPOSED	VARIANCE REQUESTED
ZONING	Historic High Density Residential District (HHDR)			
FLOOD ZONE	ZONE X			
SIZE OF SITE	4,000 SF MIN	5,000 SF	5,000 SF	NONE
MINIMUM LOT WIDTH	40'-0"	50'-0"	50'-0"	NONE
MINIMUM LOT DEPTH	90'-0"	100'-0"	100'-0"	NONE
HEIGHT	30'-0"	27'-0"	27'-0"	NONE
SETBACK 1- FRONT	10'-0"	10'-0"	10'-0"	NONE
SETBACK 2- SIDE	5'-0"	9'-4"	5'-0"	NONE
SETBACK 3- REAR	20'-0"	55'-0"	20'-0"	NONE
SETBACK 4- SIDE	5'-0"	9'-1"	5'-0"	NONE
FLOOR AREA RATIO	1.0 MAX (5,000 SQ FT)	0.31 (1,528 SQ FT)	0.44 (2,216 SQ FT)	NONE
BUILDING COVERAGE	50% MAX (2,500 SQ FT)	22% (1,094 SQ FT)	42% (2,088 SQ FT)	NONE
IMPERVIOUS SURFACE	60% MIN (3,000 SQ FT)	28% (1,382 SQ FT)	58% (2,882 SQ FT)	NONE
OPEN SPACE LANDSCAPING	35% MIN (1,750 SQ FT)	72% (3,628 SQ FT)	35% (1,758 SQ FT)	NONE
FLOOR AREA				
FIRST FLOOR		864 SQ FT	1,554 SQ FT	
SECOND FLOOR		662 SQ FT	662 SQ FT	
FLOOR AREA TOTAL		1,528 SQ FT	2,216 SQ FT	

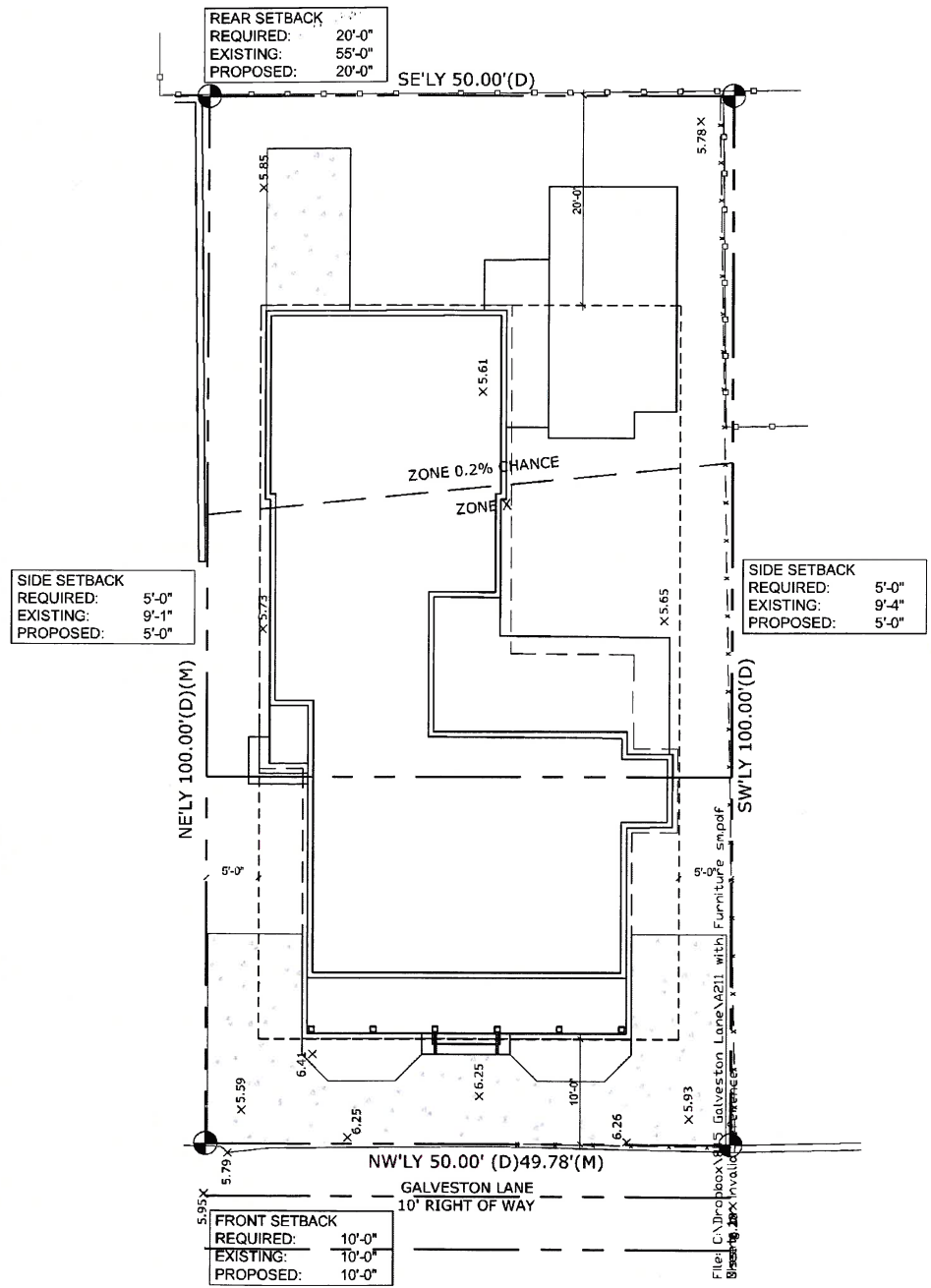

PROPOSED SITE PLAN
SCALE: 1/8" = 1'-0"

M.B. Ingram
845 Galveston

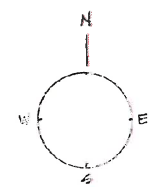
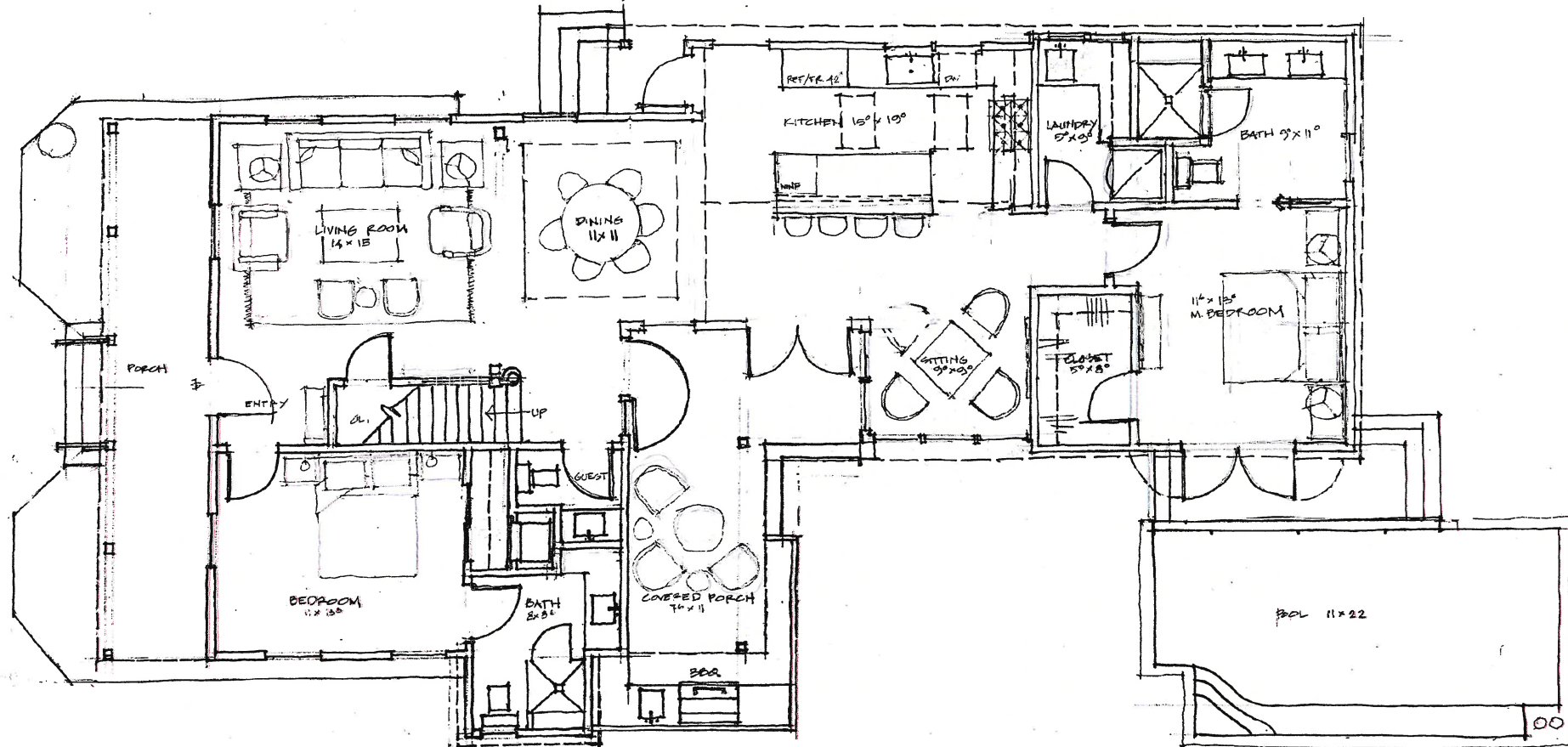
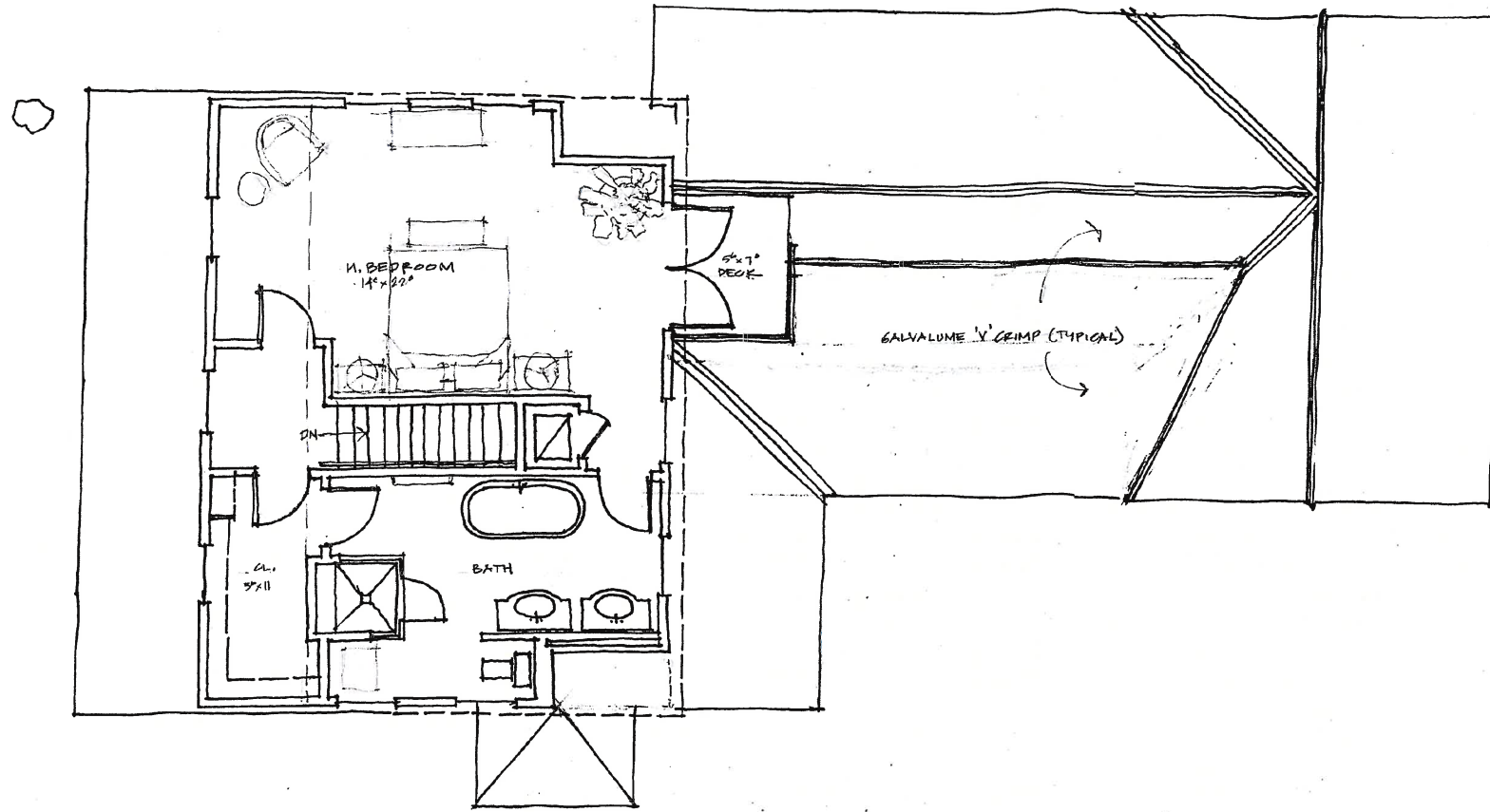

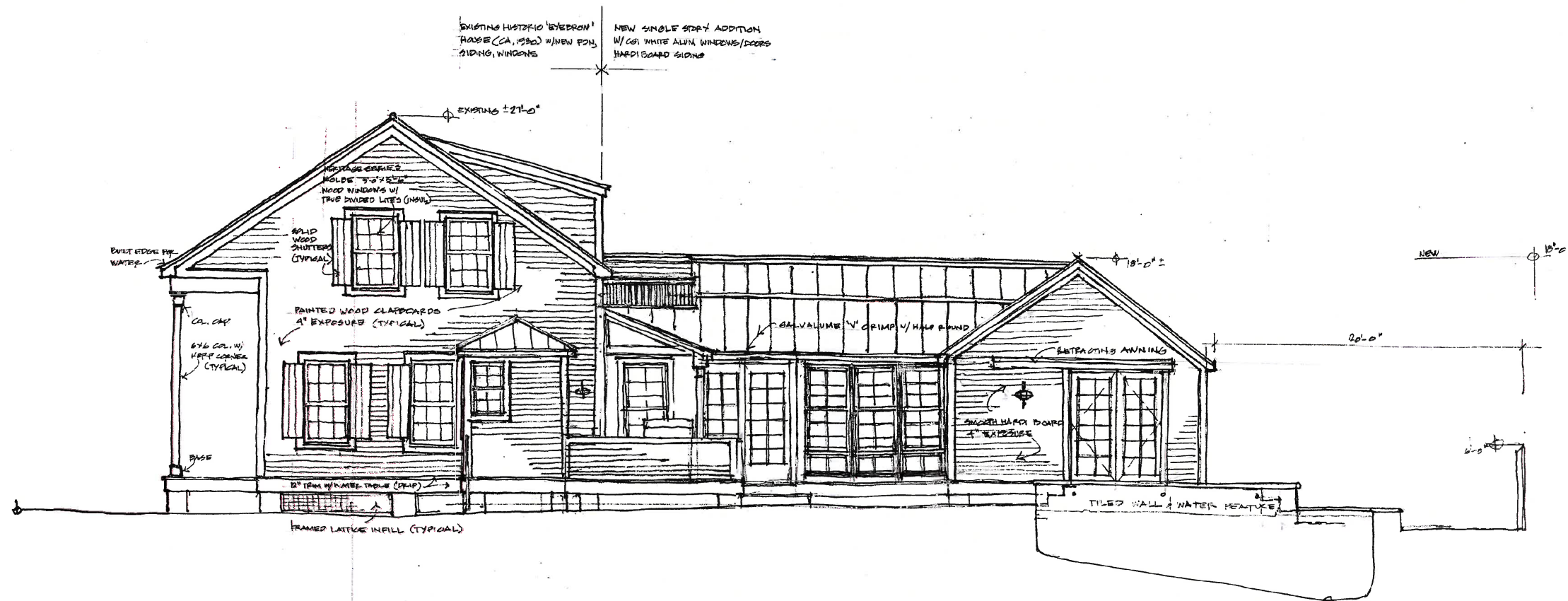
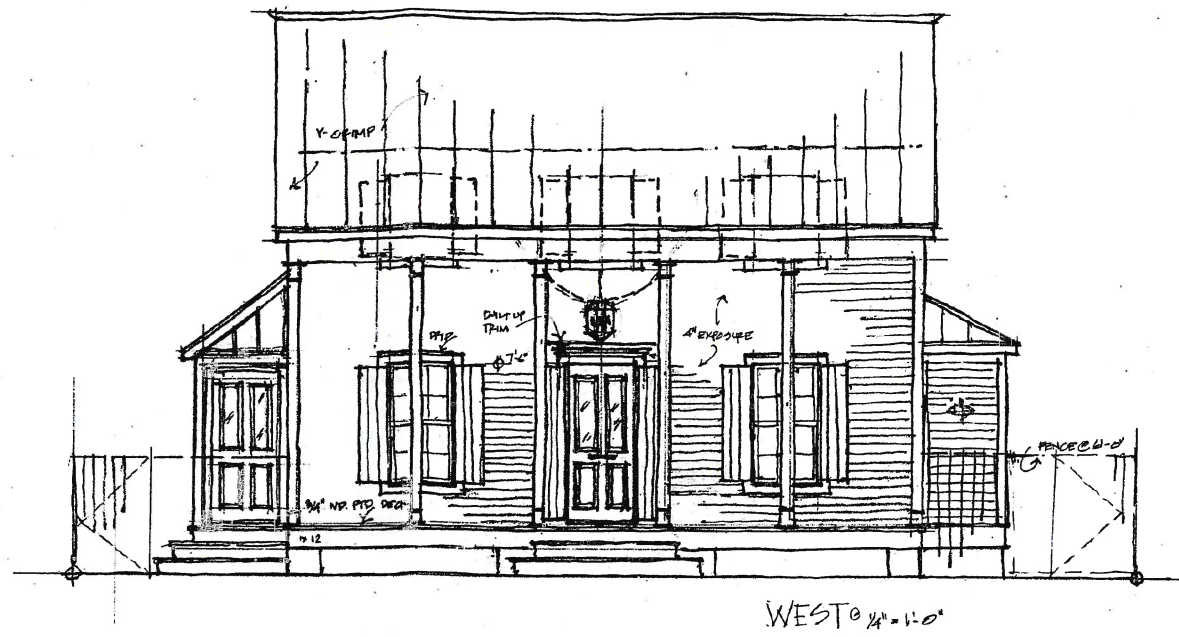

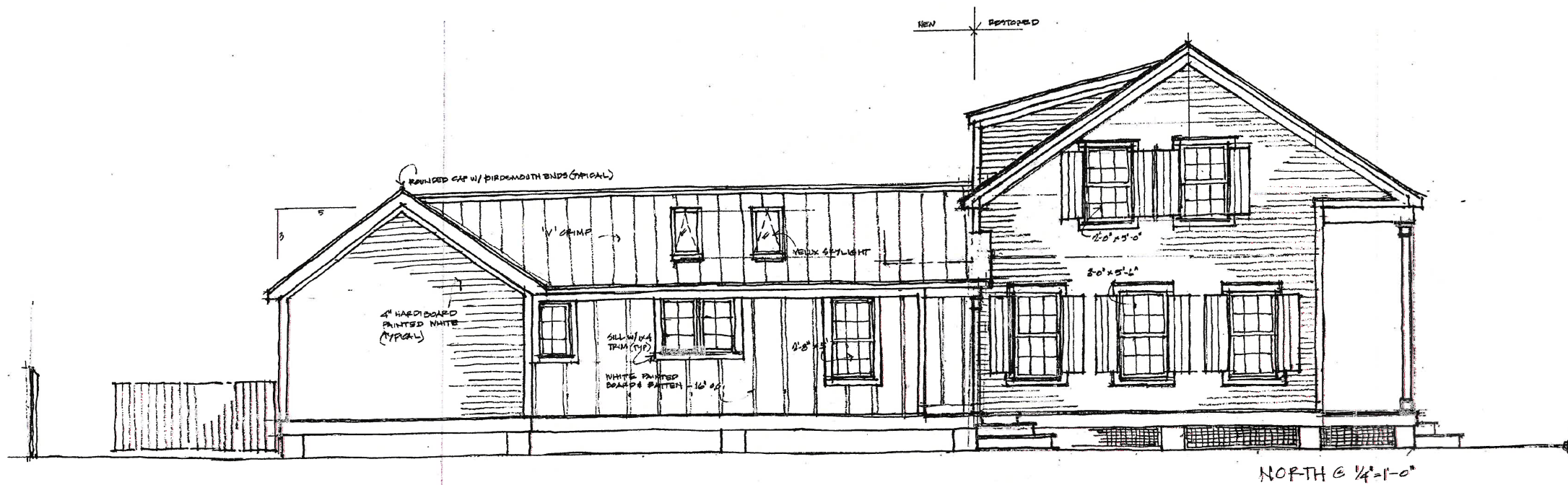
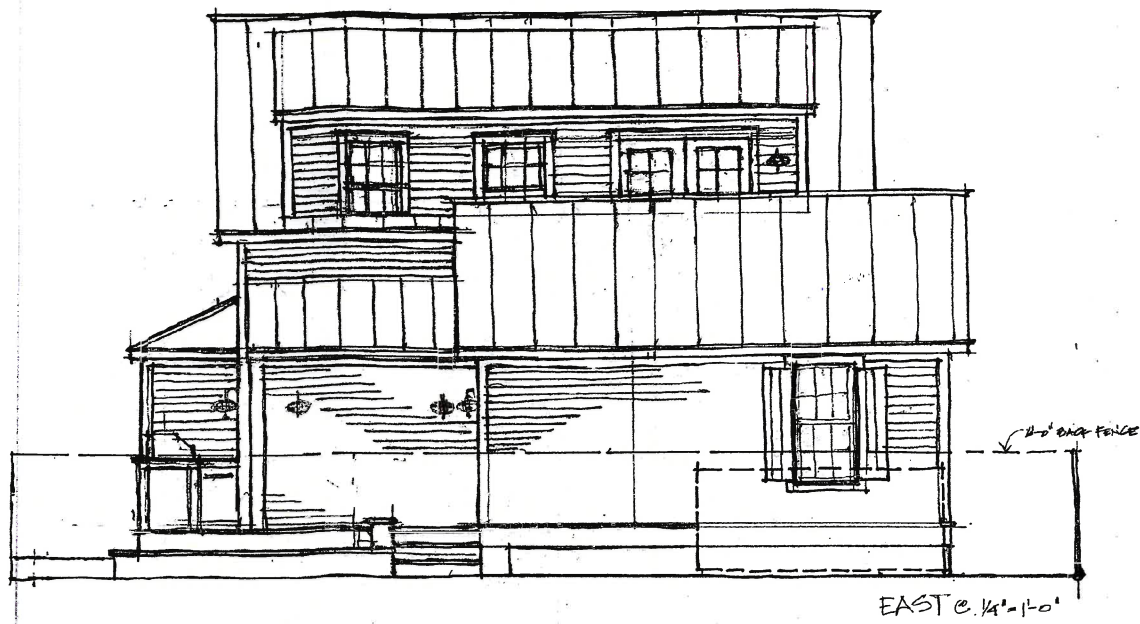



WEST @ 1/4" = 1'-0"

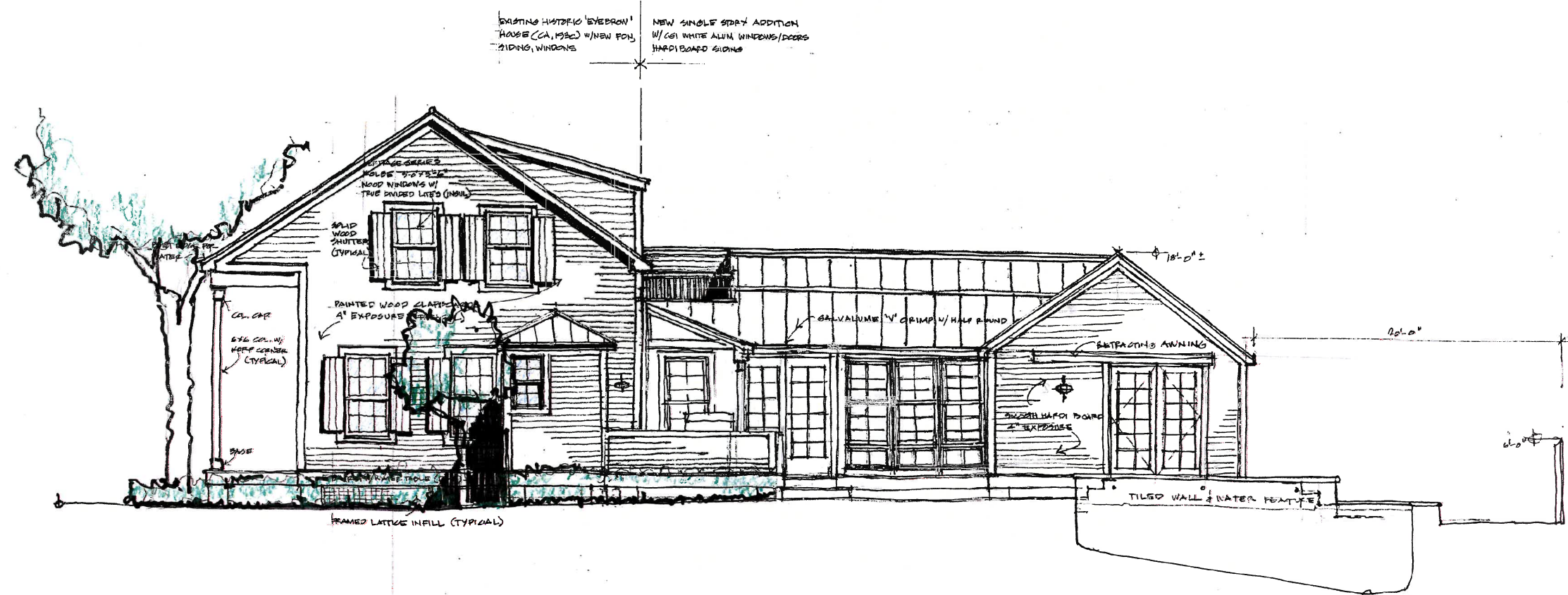

EXISTING HISTORIC 'EYEBROW'
HOUSE (CA. 1920) w/ NEW FEN.
SIDING, WINDOWS

NEW SINGLE STORY ADDITION
w/ CGI WHITE ALUM. WINDOWS/DOORS
HARDY BOARD SIDING

REAR PORCH

WOOD WINDOWS w/
TRUE DIVIDED LITES (HARDY)

SOLID WOOD SHUTTERS
(TYPICAL)

PAINTED WOOD CLARIFIED
4\"/>

GALVALUME 1/4\"/>

REAR PORCH AWNING

SOLID HARDY BOARD
EXPOSURE

TILED WALL & WATER FEATURE

FRAMED LATTICE INFILL (TYPICAL)

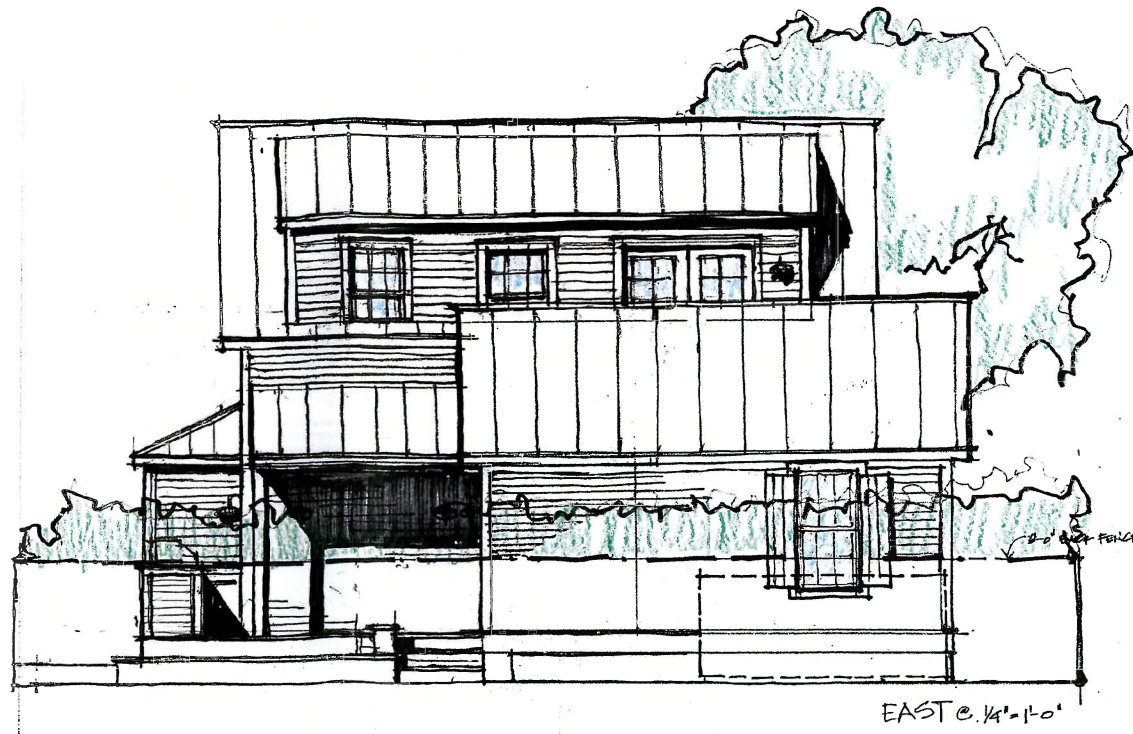

EAST @ 1/4" = 1'-0"

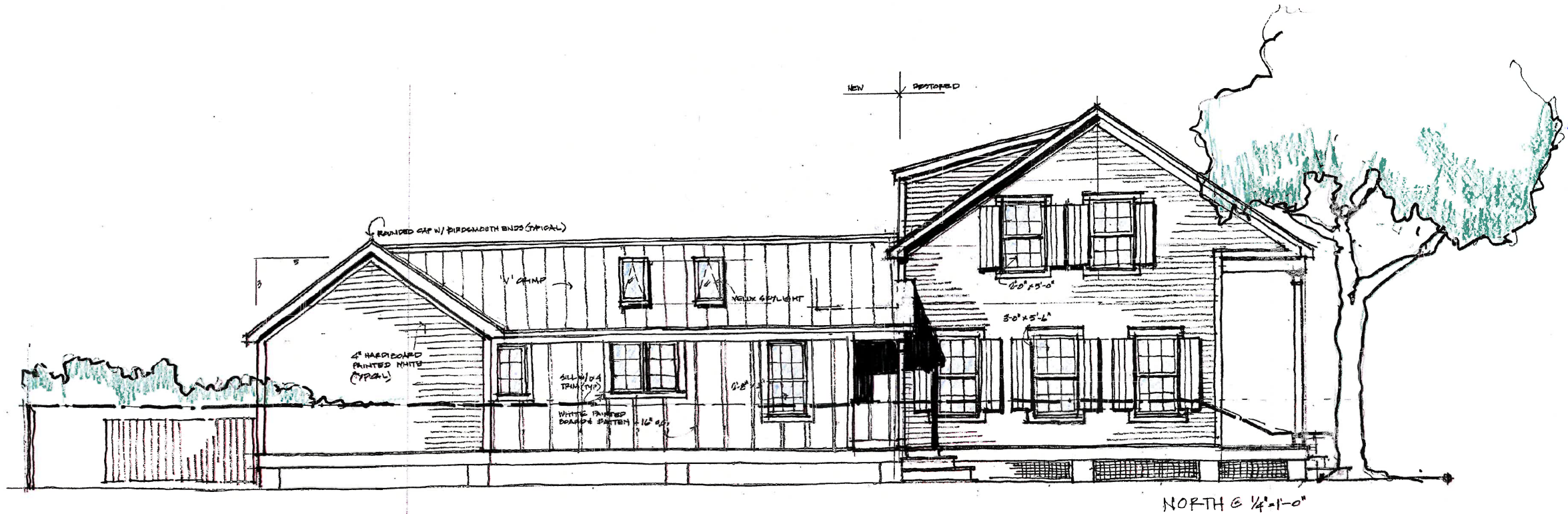

NORTH @ 1/4" = 1'-0"

Our full spectrum of brilliant colors and natural-looking textures provides plenty of options for designing a classic house in any style.

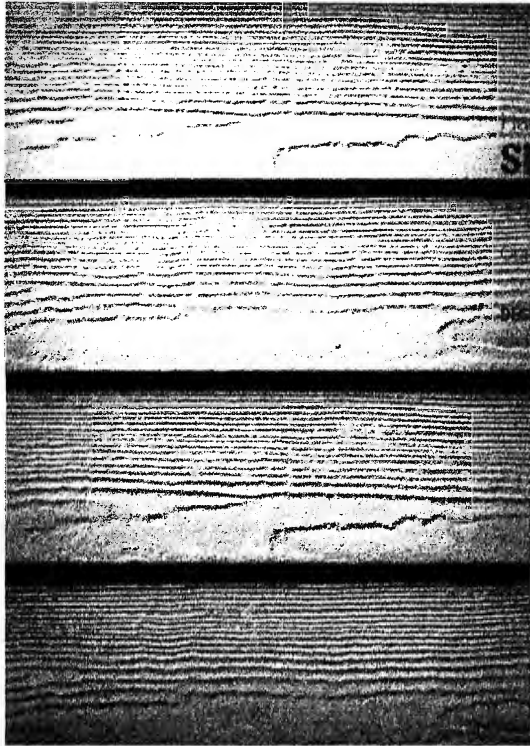

HardiePlank® Lap Siding
SELECT CEDARMILL

1/3



This natural cedar look has a soft texture that mimics wood.

DESIGN ADVICE: A great choice for historic homes, mountain retreats, woody retreats and ranch houses

[Download Product Catalog](#)

HardiePlank® Lap Siding

SMOOTH

4" EXPOSURE

You can't go wrong with this simple, clean look.

DESIGN ADVICE: Try it on ranches or breezy coastal homes

GARWESTON - NEW SECTION

WOOD -- RESTORATION SECTION

[Download Product Catalog](#)

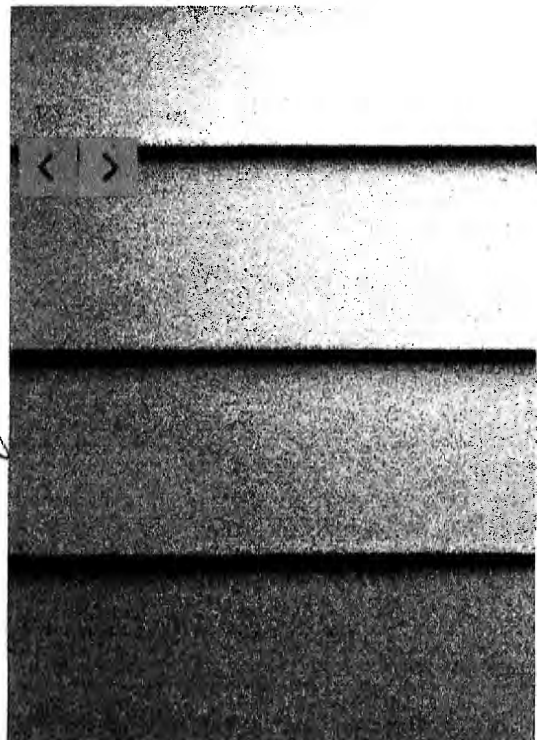

New Product Information

VELUX
SKYLIGHTS

Introducing the new VELUX Venting Curb Mounted Skylights

VCE Electric Venting Skylight



Remote control included

VCM Manual Venting Skylight

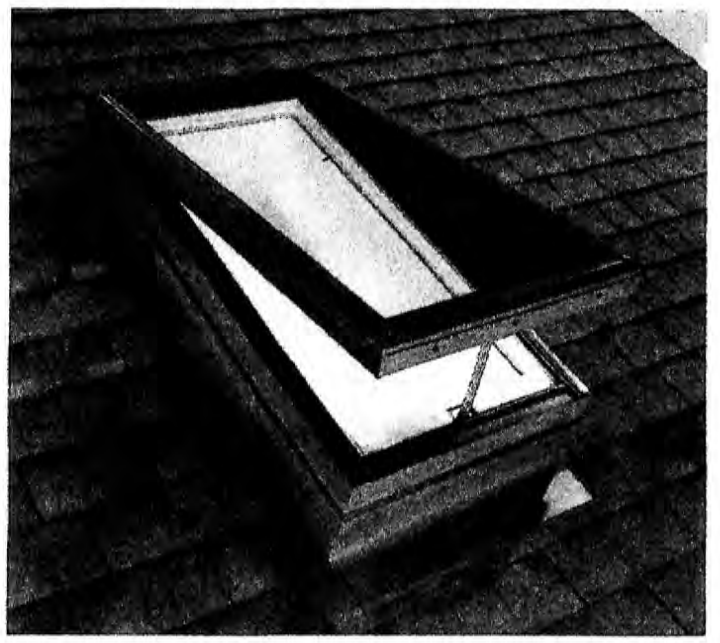

EASY-TO-INSTALL DESIGN

- Designed for simple and weathertight installation on site-built curbs
- Pre-installed operator eliminates any interior attachments
- Factory applied gaskets seal out wind and water
- VCE electric venting curb mounted skylight has all electronics and rain sensors pre-installed and operates by remote control
- 20/10/5 year warranty

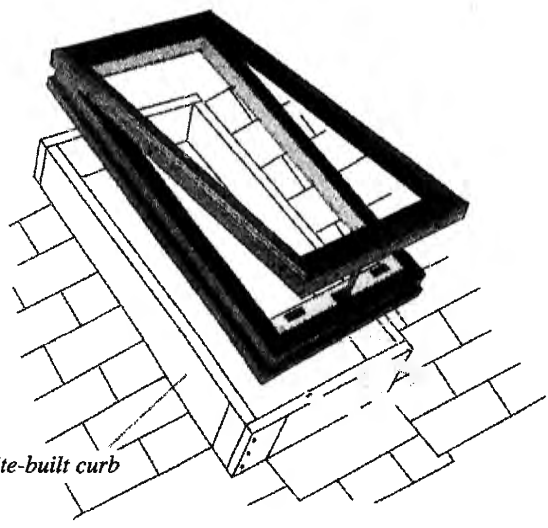

Site-built curb

ENERGY EFFICIENT AND DURABLE CONSTRUCTION

- Low-E², insulated glass reduces heat gain and loss, fading and condensation by 50% when compared to clear glass and plastics
- Interior wood frame insulates and strengthens the unit and has a white maintenance-free finish
- Rugged VELUX operator opens wide for maximum ventilation
- For use on roof pitches from 15°-60°

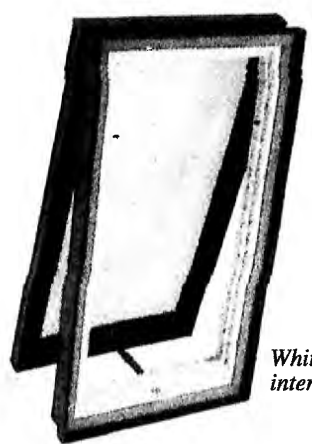

White maintenance-free interior.

[Windows](#)
[Doors](#)
[Options](#)
[Divided Lites](#)
[Finishes](#)
[Wood Species](#)
[Trim & Accessories](#)
[Hardware](#)
[Glass](#)
[Screen](#)

Divided Lites

Divide the light that enters through your windows and doors by creating unique configurations with various widths, colors and profiles of divided lite bars. Some divided lites can replicate historically-accurate designs. Others are beautiful while remaining unobtrusive, for windows that are easy to clean.

Performance Divided Lites

Kolbe's performance divided lite (PDL) glazing system gives the appearance of true divided lites without sacrificing energy efficiency. Divided lite bars are adhered to the exterior and interior of the glass, with aesthetically pleasing spacer bars installed between the glass panes, to create the illusion of true divided lites.

True Divided Lites

GALVESTON - RESTORATION SECTION

Kolbe's true divided lites (TDL) are constructed by placing wood muntin bars in between individual panes of insulating glass to create separate panes of glass. This traditional style is often used in historical restorations or historically accurate recreations.

True divided lites are only available for Heritage Series wood windows.

Grilles-In-the-Airspace

Grilles-In-the-Airspace (GIA) are constructed by sealing aluminum bars between two panes of insulating glass, which creates the look of divided panes while leaving the glass easy to clean.

Removable Grilles

Removable grilles are built with a fully surrounded frame and bars that interlock at the joints for stability. By applying grilles to the window's interior using an exclusive hidden clip system on most

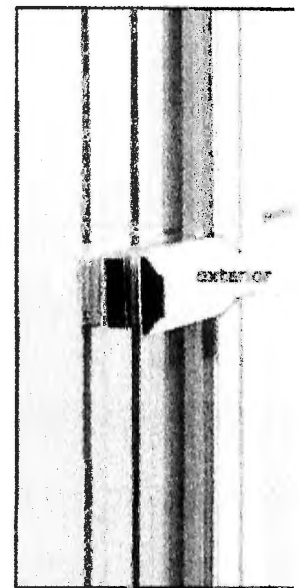

Performance Divided L

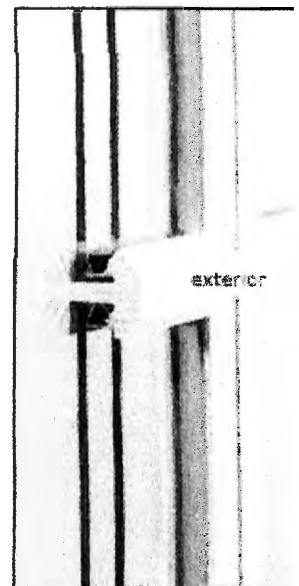

True Divided Lites



JamesHardie

COLOR AND DESIGN

WHY HARDIE?

PRODUCTS

START YOUR PROJECT

PRODUCT SUPPORT

HardiePlank® Lap Siding
SMOOTH

2 / 4



Primed for Paint

More ColorPlus® Technology colors are available **near you...**

Request a Sample

Download Product Catalog

Warranty & Install Info

HARDIEPLANK® LAP SIDING

Traditional and timeless. Sleek and strong, HardiePlank® lap siding is not just our best-selling product—it's the most popular brand of siding in America, protecting and beautifying more homes from coast to coast. All styles are Engineered for Climate® and come primed, or with baked-on ColorPlus® Technology.

PURE WHITE TRIM
OFF WHITE BODY OF HOUSE



360 SINGLE HUNG WINDOW

Industry leading single hung with design pressures up to +100/-210 PSF, available up to 42x120 or 54x96, Ogee glazing beads and muntins and standard stainless steel assembly screws.

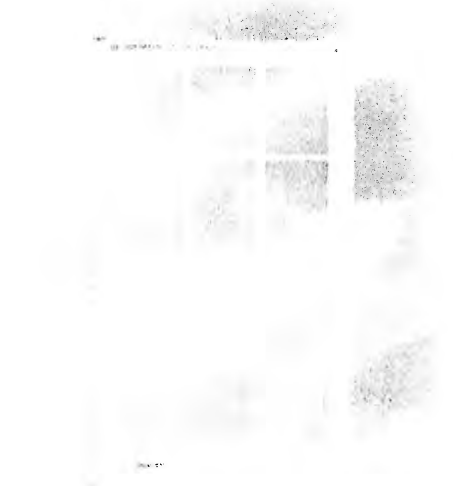

SALVESTON - 1/16
RESTRICTION SECTION

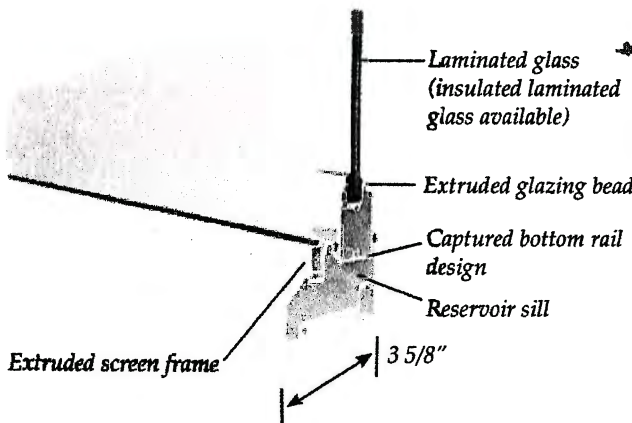

Available Finishes:

- White, Bronze, Bone White Kynar or equivalent, Class I Clear Anodized, Aspen Wood Grain Finishes, Custom Colors

Standard Glass Colors:

- Clear, Gray, Dark Gray (Turtle Code), Bronze, Solexia Green, Azuria Blue, White Interlayer, Mist (Pattern 62), Rain

Glass Types:

- 5/16" Laminated
- 7/16" Laminated
- 13/16" Insulated Laminated

Glass Coatings:

- Energy Efficient LoE Coatings

Standard Hardware:

- Pair of CGI egress self closing locks (sill mounted). Note: one lock used on windows 28" wide or less
- Pair of concealed balances
- CGI Patented Carrier Slide System

Standard Features:

- Extruded screen frame with Super-View™ screen with fiberglass mesh
- Extruded snap on glazing beads
- Stainless steel assembly screws
- Double and triple Weatherstripping
- Standard 12 PSF water sill
- Balance covers and screen pocket covers

Optional Items:

- Small missile impact resistant option
- 15 PSF waterbar adapter
- Sweep lock, keeper, and lift/pull (available for 5/16" glass only)
- Clipless mullions
- Oriel/Proview (uneven size vent available)
- Extruded double applied 1" colonial muntins (in standard or custom grids) with Ogee glazing beads only (not applicable with insulated glass)
- Muntin grids inside insulated glass (GBCs)

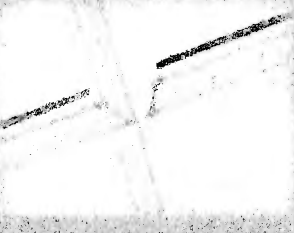

EVERYWHERE QUALITY, BEAUTY *and* STRENGTH MATTER

CAWLESTON - NEW SECTION



Tests have proven that many of our products withstand winds of nearly 300 MPH.

CGI windows and doors exude quality without compromise. As the premier manufacturer of impact resistant windows and doors, our products offer superior strength, energy efficiency and beauty. Every detail reflects our commitment to exceptional quality, from our strong commercial-grade aluminum frames to impact resistant glass

NOTICING

Public Meeting Notice

The Historic Architectural Review Commission will hold a public hearing at 5:30 p.m., September 29, 2015 at Old City Hall, 510 Greene Street, Key West, Florida. The purpose of the hearing will be to consider a request for:

RENOVATIONS AND ONE STORY ADDITION TO EYEBROW HOUSE. SITE WORK. DEMOLITION OF REAR LEAN-TO ADDITION ON CONTRIBUTING HOUSE.

FOR- #845 GALVESTON LANE

Applicant- Michael Ingram, Architect Application # H15-01-1370

If you wish to see the application or have any questions, you may visit the Planning Department during regular office hours at 3140 Flagler Avenue, call 305-809-3973 or visit our website at www.cityofkeywest-fl.gov

ADA ASSISTANCE: It is the policy of the City of Key West to comply with all requirements of the Americans with Disabilities Act (ADA). Please call the TTY number at 800-955-8771 or 800-955-8770 (Voice) or the ADA Coordinator at 305-809-3731 at least five business days in advance for sign language interpreters, assistive listening devices, or materials in accessible format.

THIS NOTICE CAN NOT BE REMOVED FROM THE SITE UNTIL HARC FINAL DETERMINATION

HARC POSTING AFFIDAVIT

STATE OF FLORIDA:
COUNTY OF MONROE:

BEFORE ME, the undersigned authority, personally appeared **Michael B. Ingram**, who, first being duly sworn, on oath, depose and says that the following statements are true and correct to the best of his/her knowledge and belief:

1. That a legal notice for Public Notice of Hearing of the Historic Architectural Review Commission (HARC) was placed on the following address:
845 Galveston Lane on the **22nd** day of **September 2015**.

This legal notice(s) contained an area of at least 8.5"x11".

The property was posted to notice a public hearing before the Key West Historic Architectural Review Commission to be held on **September 29, 2015**.

The legal notice(s) is/are clearly visible from the public street adjacent to the property.

The Certificate of Appropriateness number for this legal notice is **H15-01-1370**.

2. A photograph of that legal notice posted in the property is attached hereto.

Signed Name of Affiant:

Michael B. Ingram
Date: September 22, 2015
Address: 1001 Whitehead #101
City: Key West, FL
State, Zip: 33040

The forgoing instrument was acknowledged before me on this 22nd day of September, 2015.

By (Print name of Affiant) MICHAEL B. INGRAM who is personally known to me or has produced _____ as identification and who did take an oath.

NOTARY PUBLIC

Sign Name: Stacy L. Gibson
Print Name: STACY L. GIBSON

Notary Public - State of Florida (seal)

My Commission Expires: October 22, 2018

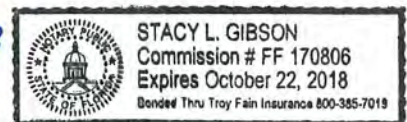

Public Meeting Notice

NOTICE OF PUBLIC MEETING
The following information is provided for your information regarding the public meeting to be held on the subject of the proposed project. The meeting will be held on the date and at the time and location specified below. The purpose of the meeting is to provide an opportunity for the public to express their views on the proposed project. The meeting will be held in a public place and will be open to all members of the public. The meeting will be held in accordance with the provisions of the Freedom of Information Act. The meeting will be held in accordance with the provisions of the Freedom of Information Act. The meeting will be held in accordance with the provisions of the Freedom of Information Act.

G
A
L
V
E
S
T
S
T

Galveston Ln



Public
Meeting
Notice

FOR MORE INFORMATION, CONTACT THE
COMMUNITY DEVELOPMENT DEPARTMENT
AT 707-441-2200



PROPERTY APPRAISER INFORMATION

- [» Tax Collector](#)

Monroe County Cities

- [» City of Key West](#)
- [» City of Marathon](#)
- [» City of Key Colony Beach](#)
- [» City of Layton](#)
- [» Islamorada, Village of Islands](#)

First Time Home Buyer (IRS)

- [» Cancellation of Debt Flyer \(English\)](#)
- [» Cancellation of Debt Flyer \(Spanish\)](#)
- [» 1st Time Homebuyers Fact Sheet](#)
- [» 1st Time Homebuyers Basic Information](#)
- [» 1st Time Homebuyers Scenarios](#)
- [» 1st Time Homebuyers Q& A's](#)

IRS Links

- [» Make Work Pay Credit](#)
- [» Energy Conservation Credit](#)

Other Links

- [» FL Dept Rev - Property Tax Oversight](#)
- [» Census Info](#)

Property Record Card -

Maps are now launching the new map application version.

[Return to Search Results](#) | [Modify Search](#) | [New Search](#) | [Send Email to MCPA Regarding this Parcel](#) | [Estimate Taxes on this Parcel](#)

Previous Record **Alternate Key: 1019895 Parcel ID: 00019210-000000** Next Record

Ownership Details

Mailing Address:

MURPHY EVELYN DIANE
845 GALVESTON LN
KEY WEST, FL 33040-6409

All Owners:

MURPHY EVELYN DIANE , MURPHY ODESSA
ESTATE T/C

Property Details

PC Code: 01 - SINGLE FAMILY

Millage Group: 10KW

Affordable Housing: No

Section-Township-Range: 06-68-25

Property Location: 845 GALVESTON LN KEY WEST

Legal Description: KW LOT 36 OF TR 5 OR195-542/44 OR237-394/95 CASE-83-65-CA-13-31 OR888-169/70F/J OR950-1983D/C OR1002-1935/36E OR1297-1595D/C OR1395-817/19ORD OR1718-311 OR1835-246R/S OR2490-583D/C OR2757-1074 OR2759-608ORD

Click Map Image to open interactive viewer

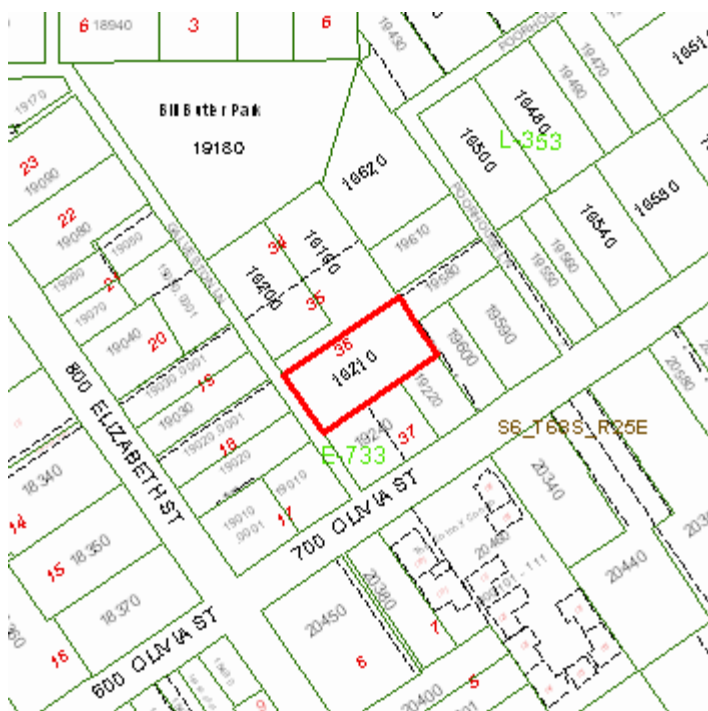

Exemptions

Exemption	Amount
35 - DISABILITY 500 CIVILIAN	500.00
44 - ADDL HOMESTEAD	25,000.00
37 - SPECIAL HOMESTEAD	25,000.00

Land Details

Land Use Code	Frontage	Depth	Land Area
01LN - SFR LANE	50	100	5,000.00 SF

Building Summary

Number of Buildings: 1
 Number of Commercial Buildings: 0
 Total Living Area: 1536
 Year Built: 1933

Building 1 Details

Building Type	R1	Condition	A	Quality Grade	550
Effective Age	49	Perimeter	236	Depreciation %	46
Year Built	1933	Special Arch	0	Grnd Floor Area	1,536
Functional Obs	0	Economic Obs	0		

Inclusions: R1 includes 1 3-fixture bath and 1 kitchen.

Roof Type	GABLE/HIP	Roof Cover	METAL	Foundation	WD CONC PADS
Heat 1	NONE	Heat 2	NONE	Bedrooms	3
Heat Src 1	NONE	Heat Src 2	NONE		

Extra Features:

2 Fix Bath	0	Vacuum	0
3 Fix Bath	0	Garbage Disposal	0
4 Fix Bath	0	Compactor	0
5 Fix Bath	0	Security	0
6 Fix Bath	0	Intercom	0
7 Fix Bath	0	Fireplaces	0
Extra Fix	0	Dishwasher	0

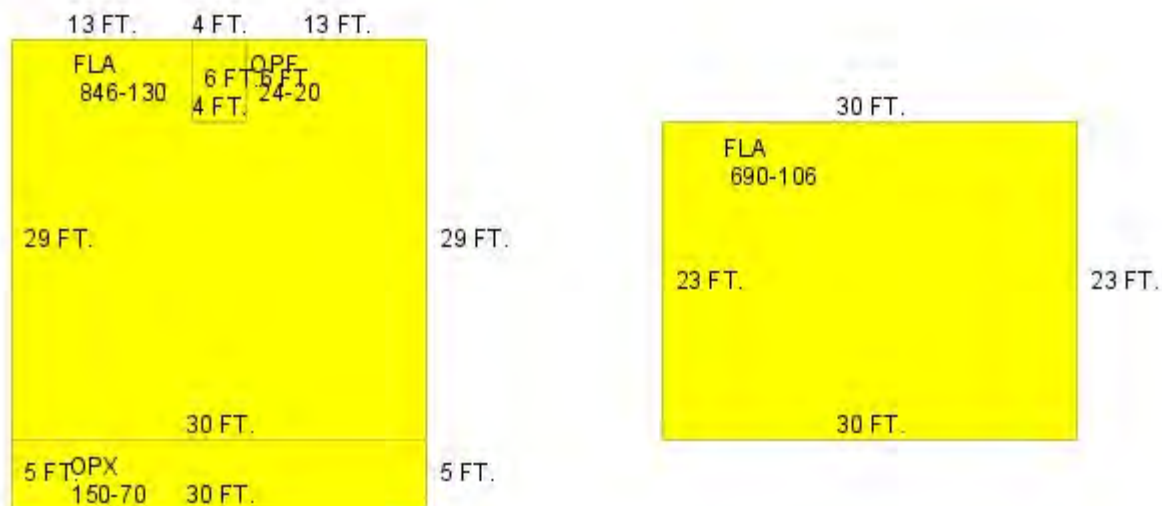

Sections:

Nbr	Type	Ext Wall	# Stories	Year Built	Attic	A/C	Basement %	Finished Basement %	Area
1	FLA	12:ABOVE AVERAGE WOOD	1	1932	N	N	0.00	0.00	846
2	OPX	12:ABOVE AVERAGE WOOD	1	1932	N	N	0.00	0.00	150
3	OPF	12:ABOVE AVERAGE WOOD	1	1932	N	N	0.00	0.00	24
4	FLA	12:ABOVE AVERAGE WOOD	1	1932	N	N	0.00	0.00	690

Misc Improvement Details

Nbr	Type	# Units	Length	Width	Year Built	Roll Year	Grade	Life
1	CL2:CH LINK FENCE	260 SF	0	0	1964	1965	1	30
2	PT4:PATIO	40 SF	8	5	1974	1975	4	50

Appraiser Notes

2002 CUT OUT DONE

Building Permits

Bldg Number	Date Issued	Date Completed	Amount	Description	Notes
05-1184	04/13/2005	04/05/2007	5,000		REPLACE DRYWALL & WOOD IN FLOORING, STUDS, MIS DOWN & UP
05-1436	05/05/2005	04/27/2007	1,000		REPLACE 1000 LN FT OF SIDING
07-2527	05/24/2007	05/13/2009	1,000		UPGRADE #05-1436
07-2873	06/12/2007	06/01/2009	1,000		INSTALL TEMP SVC AN REBUILD NEW SVC UP TO 200 AMP AND REWIRE 1200SF
1 05-0738	03/21/2005	03/13/2007	500	Residential	REPAIR ROOF
2 07-2161	05/07/2007	05/07/2007	500	Residential	INSTALL NEW 100 AMP FUSE BOX

Parcel Value History

Certified Roll Values.

[View Taxes for this Parcel.](#)

Roll Year	Total Bldg Value	Total Misc Improvement Value	Total Land Value	Total Just (Market) Value	Total Assessed Value	School Exempt Value	School Taxable Value
2015	119,815	457	597,537	717,809	409,661	25,500	384,161
2014	121,276	342	497,948	619,566	406,410	25,500	380,910
2013	121,276	342	568,242	689,860	400,404	25,500	374,904
2012	123,481	342	494,455	618,278	393,711	25,500	368,211
2011	125,686	342	451,320	577,348	382,244	25,000	357,244
2010	136,711	342	477,860	614,913	399,644	25,500	374,145
2009	150,232	342	566,352	716,926	448,227	25,500	422,727
2008	136,575	342	695,000	831,917	505,633	25,500	480,133
2007	222,044	322	875,000	1,097,366	635,745	25,500	610,245
2006	305,509	322	475,000	780,831	475,355	25,500	449,855
2005	305,509	322	380,000	685,831	425,381	25,500	399,881
2004	173,717	330	355,000	529,047	292,723	25,500	267,223
2003	167,283	338	190,000	357,621	206,484	25,500	180,984
2002	179,920	346	117,500	297,766	175,908	25,500	150,408
2001	143,450	354	117,500	261,304	173,138	25,500	147,638
2000	143,450	661	87,500	231,610	157,054	25,500	131,554
1999	117,191	552	87,500	205,243	142,786	25,500	117,286
1998	97,254	468	87,500	185,222	140,538	25,500	115,038
1997	87,343	188	77,500	165,031	138,189	25,500	112,689
1996	56,543	122	77,500	134,165	134,165	25,500	108,665
1995	56,543	0	77,500	134,043	131,524	25,500	106,024
1994	50,567	0	77,500	128,067	128,067	25,500	102,567
1993	49,731	0	77,500	127,231	127,231	25,500	101,731
1992	49,731	0	77,500	127,231	127,231	25,500	101,731
1991	49,731	0	77,500	127,231	127,231	25,000	102,231

1990	36,627	0	62,500	99,127	99,127	25,000	74,127
1989	30,270	0	61,250	91,520	91,520	25,000	66,520
1988	27,162	0	53,750	80,912	80,912	25,000	55,912
1987	22,156	0	25,000	47,156	47,156	25,000	22,156
1986	22,242	0	24,000	46,242	46,242	25,000	21,242
1985	21,778	0	16,250	38,028	38,028	25,000	13,028
1984	20,807	0	16,250	37,057	37,057	25,000	12,057
1983	20,807	0	16,250	37,057	37,057	25,000	12,057
1982	21,075	0	14,050	35,125	35,125	25,000	10,125

Parcel Sales History

NOTE: Sales do not generally show up in our computer system until about two to three months after the date of sale. If a recent sale does not show up in this list, please allow more time for the sale record to be processed. Thank you for your patience and understanding.

Sale Date	Official Records Book/Page	Price	Instrument	Qualification
8/24/2015	2759 / 608	0	ORDER	11

This page has been visited 393,274 times.

Monroe County Property Appraiser
 Scott P. Russell, CFA
 P.O. Box 1176 Key West, FL 33041-1176