



Historic Architectural Review Commission Staff Report for Item 5

To: Chairman Bryan Green and Historic Architectural Review
Commission Members

From: Enid Torregrosa-Silva, MSHP
Historic Preservation Planner

Meeting Date: August 24, 2021

Applicant: Tom Gosline

Application Number: H2021-0038

Address: 617 Frances Street

Description of Work:

Separation, renovation, and elevation of two historic structures. Relocation of one historic structure. Replacement of all windows with impact units.

Site Facts:

The building under review is a two-story house listed as a contributing resource to the historic district. The structure in question has a rear one-story addition that is older than the principal house. The principal two-story frame house was built circa 1920. The front porch of the building was altered by the removal of wood posts and installation of concrete floor. The house still preserves historic windows. At the rear of the two-story house there is a one-story frame structure depicted for the first time in the 1892 Sanborn Map. The structure sits over uncut coral stones and still have its original peg mortis and tenon. The structure has non-historic siding, non-historic jalousie windows and non-historic doors. The historic one-story structure has a rear addition that is not original to it nor it is historic. The site also has a rear detached non-historic ancillary building. Currently the building sits on an X zone for flood purpose.

The project received variance approvals from the Planning Board.

Secretary of the Interior’s Standards for Rehabilitation and Guidelines Cited on Review:

- SOIS (pages 16- 23), specifically Standards 2, 9 and 10.
- Windows (pages 29-30), specifically first paragraph and guidelines 1, 2, and 3.
- Entrances, Porches, and Doors (pages 32-33), specifically guidelines 5 and 7.
- Additions and Alterations (pages 37a-37k), specifically guidelines 1, 6, 19, 30, 32, and 33.
- Decks, Patios, Hot Tubs, Spas, Pools and Related Equipment (page 39a), specific first paragraph and guideline 3.
- Parking areas (page 43), specifically guidelines 1 and 5.

Staff Analysis:

The Certificate of Appropriateness under review proposes the separation of two historic buildings and the relocation of the oldest structure in the site to its original orientation. By reviewing the Sanborn Maps, and construction craftsmanship of the existing buildings, it was discovered that the rear one-story structure indeed is older than the principal front house. For the main house the plans include the relocation of the house by pushing it to the south towards the minimum 5’ side yard requirement and elevating it 1’-4” from its current 2’ high footers. Front porch will be rehabilitated as a three bay with four wood columns, wood railings and floors. Although staff found the current historic windows in good shape the owners would like to replace all of them with impact wood units. The southwestern first floor window on the south elevation is proposed to be shorter and the first-floor window at the rear façade will be removed. New fenestrations are proposed on the half story rear and north elevation,

As the existing rear attached historic building will be removed and relocated the plan proposes the removal of all three windows in the façade, two of them located in their original fenestration, and the installation of double folding doors at the first floor and larger double windows on the second floor. A one-story open porch is proposed in the rear of the main house.

The plans include an elevated deck (3’-4” over grade) that will be located at the rear of the main house and will give access to the oldest building. The old building will be relocated at the back of the site, with the wider side facing the rear of the house. The building will have board and batten siding, wood impact windows and synthetic wood shingles as roofing finish. A small entry roof will be added for protection of the entry door. Wood shutters are proposed.

The plan also includes a pool with a water feature wall. As the deck will be elevated it will have wood railings in both sides. A one car paved driveway is also included in the plans.

Consistency with Cited Guidelines:

It is staff’s opinion that the proposed plans conform with some of the cited guidelines. Staff finds the separation of the two buildings, elevation of both structures, rehabilitation of the front porch and oldest building, and pool in keeping with the regulations.

However, staff finds the removal of historic windows at the rear, replacement of all historic windows, and changes in size of historic fenestrations on the south elevation- westernmost first floor window on south elevation, and on the rear elevation to be inconsistent with guidelines for windows. Staff visited the house and did not find major deterioration on any of the historic windows. Historic windows are character defining features to a house and removing them to have new units is contrary to historic preservation principles. Staff also wants to state that there are in the market cedar shingles with fire retardant preservatives that meet current building code and will be more appropriate than synthetic shingles for the old structure roof.

Staff also recommends the use of tire stripes with green cover instead of bricks to create less paved areas on the front yard.

APPLICATION

HARC MAJOR PROJECTS CERTIFICATE OF APPROPRIATENESS

\$400 NON-REFUNDABLE BASE APPLICATION FEE - OTHER FEES MAY BE APPLICABLE



City of Key West

1300 WHITE STREET
KEY WEST, FLORIDA 33040

HARC COA #	REVISION #	INITIAL & DATE
FLOOD ZONE	ZONING DISTRICT	BLDG PERMIT #

A PRE-APPLICATION MEETING WITH HARC STAFF IS REQUIRED PRIOR TO SUBMITTAL

ADDRESS OF PROPOSED PROJECT:

617 Frances Street

NAME ON DEED:

Trusts of Thomas J. Gosline & William F. Fritz

PHONE NUMBER

847-849-0013

OWNER'S MAILING ADDRESS:

595 Lincoln Avenue

EMAIL

TJGosline@gmail.com

Glencoe, IL 60022

APPLICANT NAME:

Thomas J. Gosline & William F. Fritz

PHONE NUMBER

847-849-0013

APPLICANT'S ADDRESS:

595 Lincoln Avenue

EMAIL

TJGosline@gmail.com

Glencoe, IL 60022

APPLICANT'S SIGNATURE:

Thomas J. Gosline *William F. Fritz*

DATE

May 25, 2021

ANY PERSON THAT MAKES CHANGES TO AN APPROVED CERTIFICATE OF APPROPRIATENESS MUST SUBMIT A NEW APPLICATION.

FLORIDA STATUTE 837.06: WHOEVER KNOWINGLY MAKES A FALSE STATEMENT IN WRITING AND WITH THE INTENT TO MISLEAD A PUBLIC SERVANT IN THE PERFORMANCE OF HIS OR HER OFFICIAL DUTY SHALL BE GUILTY OF A MISDEMEANOR OF THE SECOND DEGREE PUNISHABLE PER SECTION 775.082 OR 775.083. THE APPLICANT FURTHER HEREBY ACKNOWLEDGES THAT THE SCOPE OF WORK AS DESCRIBED IN THE APPLICATION SHALL BE THE SCOPE OF WORK THAT IS CONTEMPLATED BY THE APPLICANT AND THE CITY. THE APPLICANT FURTHER STIPULATES THAT SHOULD FURTHER ACTION BE TAKEN BY THE CITY FOR EXCEEDING THE SCOPE OF THE DESCRIPTION OF WORK, AS DESCRIBED HEREIN, AND IF THERE IS CONFLICTING INFORMATION BETWEEN THE DESCRIPTION OF WORK AND THE SUBMITTED PLANS, THE AFOREMENTIONED DESCRIPTION OF WORK SHALL BE CONTROLLING.

PROJECT INCLUDES: REPLACEMENT OF WINDOWS RELOCATION OF A STRUCTURE ELEVATION OF A STRUCTURE

PROJECT INVOLVES A CONTRIBUTING STRUCTURE: YES NO INVOLVES A HISTORIC STRUCTURE: YES NO

PROJECT INVOLVES A STRUCTURE THAT IS INDIVIDUALLY LISTED ON THE NATIONAL REGISTER: YES NO

DETAILED PROJECT DESCRIPTION INCLUDING MATERIALS, HEIGHT, DIMENSIONS, SQUARE FOOTAGE, LOCATION, ETC.

GENERAL: This property has surprised us a number of times already, not the least is that it's actually a "2 for 1" historic property. Two homes, separated by nearly 50 years were joined in an unhappy marriage. The older rear 1880's Wreckers Cottage with mortise & tenon construction, appears to have been owned and built by a noted historical figure Nicholas Matcovich for his wife Elisa, who relocated to Key West in 1876 with some of their children following a devastating hurricane at their farm on No Name Key. The front 1920's Conch House appears to have built by his son John Matcovich who moved and reoriented Elisa's Cottage, opening the lot to the north at 615 Frances. This extensive project involves the renovation and elevation of the 2 Historic Structures, and they will also be separated and moved apart to enable each to regain its appropriate and distinct historic character, with the Wrecker's Cottage reclaiming its original west-facing orientation on the lot.

NOTE: The required Variances have been granted by the Key West Planning Department & Board.

MAIN BUILDING: The front 1920's Conch house interior is to be completely renovated, replacing all systems - plumbing, electric, HVAC, flooring, insulation, frame strapping, etc. The exterior will also be restored using existing materials where possible and like replacements where necessary, including siding, roofing, and porch flooring, posts and roofing. Some systems which are dilapidated or unsafe will be replaced entirely, including installation of new foundation piers raised to BFE +3", and installation of approved wood impact windows. To maintain the structural integrity of the interior Dade County Pine, the existing siding will be removed & salvaged for reinstallation following the application of new cladding & tyvek barrier.

DEMOLITION (PLEASE FILL OUT AND ATTACH DEMOLITION APPENDIX):

The contemporary replacement cement & steel front porch to be removed and replaced with wood, per architectural renderings.

Major Project Application Page 2

APPLICATIONS MUST BE SUBMITTED IN PERSON WITH HARD COPIES BY 3PM ON THE SCHEDULED DEADLINE
PLEASE SEND AN ELECTRONIC COPY OF ALL DOCUMENTS TO HARC@CITYOFKEYWEST-FL.GOV

ACCESSORY STRUCTURE: The rear 1880's Wrecker's Cottage will be raised to BFE +3", returned to its original 25'x13' size, and restored on the lot to its original west-facing orientation per Sanborn Maps. The interior is to be completely renovated, replacing all systems - plumbing, electric, HVAC, flooring, insulation, frame strapping, etc. The exterior will be recreated using photos of a similar home built by the first owner Nicholas Matcovich, AS NO ORIGINAL EXTERIOR ELEMENTS SURVIVE. Proposed exterior is baton & board, roofing is shake shingle, board & baton shutters, and impact rated wood casement windows (see photo of Matcovich Cottage on No Name Key). Some historical frame construction details will be exposed/accessible as fire codes allow.

ACCESSORY STRUCTURES - OTHER: A non-contributing shed will be demolished, and a non-contributing addition to the 1880's Cottage will be removed and demolished.

PAVERS:	FENCES:
Natural Thermal Blue Stone	Existing rear & side fencing to remain, front picket fence to be replaced with new 1" x 3" pressure treated white picket fence.
DECKS:	PAINTING:
Natural Thermal Blue Stone	Siding: HC-144 Palladian Blue Trim: OC-64 White Porch Ceiling: CW-585 Ewing Blue Shutters: HC-155 Newberryport Blue
SITE (INCLUDING GRADING, FILL, TREES, ETC):	POOLS (INCLUDING EQUIPMENT):
See Site Plan, there is no Landscape Plan submission at this time. All palm trees to be removed and replaced with native/ approved trees, shrubs, etc	24' x 14' pool between structures in back yard. Equipment to be located along north side of house.
ACCESSORY EQUIPMENT (GAS, A/C, VENTS, ETC.):	OTHER:
2 ground mounted a/c compressors, pool filter, pool heater/chiller, dryer vent to rear 2nd floor, stove to vent below building.	

OFFICIAL USE ONLY:		HARC COMMISSION REVIEW		EXPIRES ON:	
MEETING DATE: 07/28/21	<input type="checkbox"/> APPROVED	<input type="checkbox"/> NOT APPROVED	<input checked="" type="checkbox"/> DEFERRED FOR FUTURE CONSIDERATION	INITIAL:	BCG
MEETING DATE:	<input type="checkbox"/> APPROVED	<input type="checkbox"/> NOT APPROVED	<input type="checkbox"/> DEFERRED FOR FUTURE CONSIDERATION	INITIAL:	
MEETING DATE:	<input type="checkbox"/> APPROVED	<input type="checkbox"/> NOT APPROVED	<input type="checkbox"/> DEFERRED FOR FUTURE CONSIDERATION	INITIAL:	
REASONS OR CONDITIONS:					
STAFF REVIEW COMMENTS:					
FIRST READING FOR DEMO:			SECOND READING FOR DEMO:		
HARC STAFF SIGNATURE AND DATE:			HARC CHAIRPERSON SIGNATURE AND DATE:		

THIS APPLICATION MAY BE REVIEWED BY PLANNING DEPARTMENT STAFF.

HARC Certificate of Appropriateness: Demolition Appendix



City of Key West

1300 WHITE STREET
KEY WEST, FLORIDA 33040

HARC COA #	INITIAL & DATE
ZONING DISTRICT	BLDG PERMIT #

ADDRESS OF PROPOSED PROJECT:	617 Frances Street
PROPERTY OWNER'S NAME:	Thomas J. Gosline & William F. Fritz
APPLICANT NAME:	Thomas J. Gosline & William F. Fritz

I hereby certify I am the owner of record and that the work shall conform to all applicable laws of this jurisdiction. By receiving a Certificate of Appropriateness, I realize that this project will require a Building Permit approval **PRIOR to proceeding with the work outlined above** and that a final inspection is required under this application. I also understand that **any changes to an approved Certificate of Appropriateness must be submitted for review**.

PROPERTY OWNER'S SIGNATURE		May 25, 2021 Thomas J. Gosline & William F. Fritz	DATE AND PRINT NAME
----------------------------	---	--	---------------------

DETAILED PROJECT DESCRIPTION OF DEMOLITION

Three items are proposed for demolition:

- 1) Non-Contributing Accessory Structure (shed) to be demolished
- 2) Non-Contributing rear addition to historic 1880's Cottage to be demolished
- 3) Non-contributing front concrete porch floor & steps and metal railings to be removed from historic 1920's House

CRITERIA FOR DEMOLITION OF CONTRIBUTING OR HISTORIC STRUCTURES:

Before any Certificate of Appropriateness may be issued for a demolition request, the Historic Architectural Review Commission must find that the following requirements are met (please review and comment on each criterion that applies);

(1) If the subject of the application is a contributing or historic building or structure, then it should not be demolished unless its condition is irrevocably compromised by extreme deterioration or it does not meet any of the following criteria:

- (a) The existing condition of the building or structure is irrevocably compromised by extreme deterioration.

Non-Contributing Structures or Elements

(2) Or explain how the building or structure meets the criteria below:

- (a) Embodies no distinctive characteristics of a type, period, or method of construction of aesthetic or historic significance in the city and is not a significant and distinguishable building entity whose components may lack individual distinction.

None

Nothing in this application is intended to alter the authority of the Building Official to condemn for demolition dangerous buildings, as provided in Section 102-218 of the Land Development Regulations and Chapter 14 of the Code of Ordinances.

(b) Is not specifically associated with events that have made a significant contribution to local, state, or national history.

None

(c) Has no significant character, interest, or value as part fo the development, heritage, or cultural characteristics of the city, state or nation, and is not associated with the life of a person significant in the past.

None

(d) Is not the site of a historic event with significant effect upon society.

None

(e) Does not exemplify the cultural, political, economic, social, or historic heritage of the city.

None

(f) Does not portray the environment in an era of history characterized by a distinctive architectural style.

None

(g) If a part of or related to a square, park, or other distinctive area, nevertheless should not be developed or preserved according to a plan based on the area's historic, cultural, natural, or architectural motif.

Not Applicable

(h) Does not have a unique location or singular physical characteristic which represents an established and familiar visual feature of its neighborhood or of the city, and does not exemplify the best remaining architectural type in a neighborhood.

Nothing in this application is intended to alter the authority of the Building Official to condemn for demolition dangerous buildings, as provided in Section 102-218 of the Land Development Regulations and Chapter 14 of the Code of Ordinances.

<i>None</i>
(i) Has not yielded, and is not likely to yield, information important in history.
<i>None</i>

CRITERIA FOR DEMOLITION OF NON-CONTRIBUTING OR NON-HISTORIC STRUCTURES:

The following criteria will also be reviewed by the Historic Architectural Review Commission for proposed demolitions. The Commission shall not issue a Certificate of Appropriateness that would result in the following conditions (please review and comment on each criterion that applies);

(1) Removing buildings or structures that are important in defining the overall historic character of a district or neighborhood so that the character is diminished.

None

(2) Removing historic buildings or structures and thus destroying the historic relationship between buildings or structures and open space.

None

(3) Removing an historic building or structure in a complex; or removing a building facade; or removing a significant later addition that is important in defining the historic character of a site or the surrounding district or neighborhood.

None

(4) Removing buildings or structures that would otherwise qualify as contributing.

None

ELEVATION CERTIFICATE

Important: Follow the instructions on pages 1-9.

Copy all pages of this Elevation Certificate and all attachments for (1) community official, (2) insurance agent/company, and (3) building owner.

SECTION A – PROPERTY INFORMATION				FOR INSURANCE COMPANY USE	
A1. Building Owner's Name THOMAS J. GOSLINE & WILLIAM F. FRITZ				Policy Number:	
A2. Building Street Address (including Apt., Unit, Suite, and/or Bldg. No.) or P.O. Route and Box No. 617 FRANCES STREET				Company NAIC Number:	
City KEY WEST		State Florida		ZIP Code 33040	
A3. Property Description (Lot and Block Numbers, Tax Parcel Number, Legal Description, etc.) (TAX PARCEL #00010430-000000) (KW PT LOT 4 SQR 55)					
A4. Building Use (e.g., Residential, Non-Residential, Addition, Accessory, etc.) <u>RESIDENTIAL</u>					
A5. Latitude/Longitude: Lat. <u>24.5586 N</u> Long. <u>-81.7945 W</u> Horizontal Datum: <input type="checkbox"/> NAD 1927 <input checked="" type="checkbox"/> NAD 1983					
A6. Attach at least 2 photographs of the building if the Certificate is being used to obtain flood insurance.					
A7. Building Diagram Number <u>5</u>					
A8. For a building with a crawlspace or enclosure(s):					
a) Square footage of crawlspace or enclosure(s) <u>N/A</u> sq ft					
b) Number of permanent flood openings in the crawlspace or enclosure(s) within 1.0 foot above adjacent grade <u>N/A</u>					
c) Total net area of flood openings in A8.b <u>N/A</u> sq in					
d) Engineered flood openings? <input type="checkbox"/> Yes <input checked="" type="checkbox"/> No					
A9. For a building with an attached garage:					
a) Square footage of attached garage <u>N/A</u> sq ft					
b) Number of permanent flood openings in the attached garage within 1.0 foot above adjacent grade <u>N/A</u>					
c) Total net area of flood openings in A9.b <u>N/A</u> sq in					
d) Engineered flood openings? <input type="checkbox"/> Yes <input checked="" type="checkbox"/> No					
SECTION B – FLOOD INSURANCE RATE MAP (FIRM) INFORMATION					
B1. NFIP Community Name & Community Number CITY OF KEY WEST 120168			B2. County Name MONROE		B3. State Florida
B4. Map/Panel Number 12087C1516	B5. Suffix K	B6. FIRM Index Date 02-18-2005	B7. FIRM Panel Effective/ Revised Date 02-18-2005	B8. Flood Zone(s) X	B9. Base Flood Elevation(s) (Zone AO, use Base Flood Depth)
B10. Indicate the source of the Base Flood Elevation (BFE) data or base flood depth entered in Item B9: <input type="checkbox"/> FIS Profile <input checked="" type="checkbox"/> FIRM <input type="checkbox"/> Community Determined <input type="checkbox"/> Other/Source: _____					
B11. Indicate elevation datum used for BFE in Item B9: <input checked="" type="checkbox"/> NGVD 1929 <input type="checkbox"/> NAVD 1988 <input type="checkbox"/> Other/Source: _____					
B12. Is the building located in a Coastal Barrier Resources System (CBRS) area or Otherwise Protected Area (OPA)? <input type="checkbox"/> Yes <input checked="" type="checkbox"/> No Designation Date: _____ <input type="checkbox"/> CBRS <input type="checkbox"/> OPA					

ELEVATION CERTIFICATE

OMB No. 1660-0008
Expiration Date: November 30, 2022

IMPORTANT: In these spaces, copy the corresponding information from Section A.			FOR INSURANCE COMPANY USE
Building Street Address (including Apt., Unit, Suite, and/or Bldg. No.) or P.O. Route and Box No. 617 FRANCES STREET			Policy Number:
City KEY WEST	State Florida	ZIP Code 33040	Company NAIC Number

SECTION C – BUILDING ELEVATION INFORMATION (SURVEY REQUIRED)

C1. Building elevations are based on: Construction Drawings* Building Under Construction* Finished Construction

*A new Elevation Certificate will be required when construction of the building is complete.

C2. Elevations – Zones A1–A30, AE, AH, A (with BFE), VE, V1–V30, V (with BFE), AR, AR/A, AR/AE, AR/A1–A30, AR/AH, AR/AO. Complete Items C2.a–h below according to the building diagram specified in Item A7. In Puerto Rico only, enter meters.

Benchmark Utilized: BASIC Vertical Datum: 1929

Indicate elevation datum used for the elevations in items a) through h) below.

NGVD 1929 NAVD 1988 Other/Source: _____

Datum used for building elevations must be the same as that used for the BFE.

Check the measurement used.

- | | | | |
|---|-------------|--|---------------------------------|
| a) Top of bottom floor (including basement, crawlspace, or enclosure floor) | <u>9.3</u> | <input checked="" type="checkbox"/> feet | <input type="checkbox"/> meters |
| b) Top of the next higher floor | <u>19.0</u> | <input checked="" type="checkbox"/> feet | <input type="checkbox"/> meters |
| c) Bottom of the lowest horizontal structural member (V Zones only) | <u>N/A</u> | <input type="checkbox"/> feet | <input type="checkbox"/> meters |
| d) Attached garage (top of slab) | <u>N/A</u> | <input type="checkbox"/> feet | <input type="checkbox"/> meters |
| e) Lowest elevation of machinery or equipment servicing the building
(Describe type of equipment and location in Comments) | <u>7.1</u> | <input checked="" type="checkbox"/> feet | <input type="checkbox"/> meters |
| f) Lowest adjacent (finished) grade next to building (LAG) | <u>6.5</u> | <input checked="" type="checkbox"/> feet | <input type="checkbox"/> meters |
| g) Highest adjacent (finished) grade next to building (HAG) | <u>6.9</u> | <input checked="" type="checkbox"/> feet | <input type="checkbox"/> meters |
| h) Lowest adjacent grade at lowest elevation of deck or stairs, including structural support | <u>6.5</u> | <input checked="" type="checkbox"/> feet | <input type="checkbox"/> meters |

SECTION D – SURVEYOR, ENGINEER, OR ARCHITECT CERTIFICATION

This certification is to be signed and sealed by a land surveyor, engineer, or architect authorized by law to certify elevation information. I certify that the information on this Certificate represents my best efforts to interpret the data available. I understand that any false statement may be punishable by fine or imprisonment under 18 U.S. Code, Section 1001.

Were latitude and longitude in Section A provided by a licensed land surveyor? Yes No Check here if attachments.

Certifier's Name J. LYNN O'FLYNN	License Number 6298
Title P.S.M.	
Company Name J. LYNN O'FLYNN, INC.	
Address 3430 DUCK AVENUE	
City KEY WEST	State Florida
	ZIP Code 33040

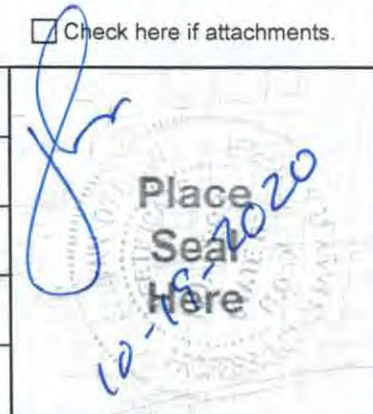

Signature 	Date 10-19-2020	Telephone (305) 296-7422	Ext.
---------------	--------------------	-----------------------------	------

Copy all pages of this Elevation Certificate and all attachments for (1) community official, (2) insurance agent/company, and (3) building owner.

Comments (including type of equipment and location, per C2(e), if applicable)

C2. e) - WATER HEATER

LONGITUDE & LATITUDE WERE DETERMINED BY USING GOOGLE EARTH

ELEVATION CERTIFICATE

OMB No. 1660-0008
Expiration Date: November 30, 2022

IMPORTANT: In these spaces, copy the corresponding information from Section A.			FOR INSURANCE COMPANY USE
Building Street Address (including Apt., Unit, Suite, and/or Bldg. No.) or P.O. Route and Box No. 617 FRANCES STREET			Policy Number:
City KEY WEST	State Florida	ZIP Code 33040	Company NAIC Number

SECTION E – BUILDING ELEVATION INFORMATION (SURVEY NOT REQUIRED) FOR ZONE AO AND ZONE A (WITHOUT BFE)

For Zones AO and A (without BFE), complete Items E1–E5. If the Certificate is intended to support a LOMA or LOMR-F request, complete Sections A, B, and C. For Items E1–E4, use natural grade, if available. Check the measurement used. In Puerto Rico only, enter meters.

- E1. Provide elevation information for the following and check the appropriate boxes to show whether the elevation is above or below the highest adjacent grade (HAG) and the lowest adjacent grade (LAG).
- a) Top of bottom floor (including basement, crawlspace, or enclosure) is _____ feet meters above or below the HAG.
- b) Top of bottom floor (including basement, crawlspace, or enclosure) is _____ feet meters above or below the LAG.
- E2. For Building Diagrams 6–9 with permanent flood openings provided in Section A Items 8 and/or 9 (see pages 1–2 of Instructions), the next higher floor (elevation C2.b in the diagrams) of the building is _____ feet meters above or below the HAG.
- E3. Attached garage (top of slab) is _____ feet meters above or below the HAG.
- E4. Top of platform of machinery and/or equipment servicing the building is _____ feet meters above or below the HAG.
- E5. Zone AO only: If no flood depth number is available, is the top of the bottom floor elevated in accordance with the community's floodplain management ordinance? Yes No Unknown. The local official must certify this information in Section G.

SECTION F – PROPERTY OWNER (OR OWNER'S REPRESENTATIVE) CERTIFICATION

The property owner or owner's authorized representative who completes Sections A, B, and E for Zone A (without a FEMA-issued or community-issued BFE) or Zone AO must sign here. The statements in Sections A, B, and E are correct to the best of my knowledge.

Property Owner or Owner's Authorized Representative's Name

Address _____ City _____ State _____ ZIP Code _____

Signature _____ Date _____ Telephone _____

Comments

Check here if attachments.

ELEVATION CERTIFICATE

OMB No. 1660-0008
Expiration Date: November 30, 2022

IMPORTANT: In these spaces, copy the corresponding information from Section A.			FOR INSURANCE COMPANY USE
Building Street Address (including Apt., Unit, Suite, and/or Bldg. No.) or P.O. Route and Box No. 617 FRANCES STREET			Policy Number:
City KEY WEST	State Florida	ZIP Code 33040	Company NAIC Number

SECTION G – COMMUNITY INFORMATION (OPTIONAL)

The local official who is authorized by law or ordinance to administer the community's floodplain management ordinance can complete Sections A, B, C (or E), and G of this Elevation Certificate. Complete the applicable item(s) and sign below. Check the measurement used in Items G8–G10. In Puerto Rico only, enter meters.

- G1. The information in Section C was taken from other documentation that has been signed and sealed by a licensed surveyor, engineer, or architect who is authorized by law to certify elevation information. (Indicate the source and date of the elevation data in the Comments area below.)
- G2. A community official completed Section E for a building located in Zone A (without a FEMA-issued or community-issued BFE) or Zone AO.
- G3. The following information (Items G4–G10) is provided for community floodplain management purposes.

G4. Permit Number	G5. Date Permit Issued	G6. Date Certificate of Compliance/Occupancy Issued
-------------------	------------------------	---

- G7. This permit has been issued for: New Construction Substantial Improvement
- G8. Elevation of as-built lowest floor (including basement) of the building: _____ feet meters Datum _____
- G9. BFE or (in Zone AO) depth of flooding at the building site: _____ feet meters Datum _____
- G10. Community's design flood elevation: _____ feet meters Datum _____

Local Official's Name	Title
Community Name	Telephone
Signature	Date

Comments (including type of equipment and location, per C2(e), if applicable)

Check here if attachments.

BUILDING PHOTOGRAPHS

See Instructions for Item A6.

OMB No. 1660-0008

Expiration Date: November 30, 2022

ELEVATION CERTIFICATE

IMPORTANT: In these spaces, copy the corresponding information from Section A.			FOR INSURANCE COMPANY USE
Building Street Address (including Apt., Unit, Suite, and/or Bldg. No.) or P.O. Route and Box No. 617 FRANCES STREET			Policy Number:
City KEY WEST	State Florida	ZIP Code 33040	Company NAIC Number

If using the Elevation Certificate to obtain NFIP flood insurance, affix at least 2 building photographs below according to the instructions for Item A6. Identify all photographs with date taken; "Front View" and "Rear View"; and, if required, "Right Side View" and "Left Side View." When applicable, photographs must show the foundation with representative examples of the flood openings or vents, as indicated in Section A8. If submitting more photographs than will fit on this page, use the Continuation Page.



Photo One

Photo One Caption

FRONT/SIDE VIEW & FOUNDATION

10-19-2020

Clear Photo One



Photo Two

Photo Two Caption

REAR/SIDE VIEW, FOUNDATION & WATER HEATER

10-19-2020

Clear Photo Two

BUILDING PHOTOGRAPHS

Continuation Page

OMB No. 1660-0008
Expiration Date: November 30, 2022

ELEVATION CERTIFICATE

IMPORTANT: In these spaces, copy the corresponding information from Section A.			FOR INSURANCE COMPANY USE
Building Street Address (including Apt., Unit, Suite, and/or Bldg. No.) or P.O. Route and Box No. 617 FRANCES STREET			Policy Number:
City KEY WEST	State Florida	ZIP Code 33040	Company NAIC Number

If submitting more photographs than will fit on the preceding page, affix the additional photographs below. Identify all photographs with: date taken; "Front View" and "Rear View"; and, if required, "Right Side View" and "Left Side View." When applicable, photographs must show the foundation with representative examples of the flood openings or vents, as indicated in Section A8.



Photo Three

Photo Three Caption **SIDE VIEW** 10-19-2020 Clear Photo Three

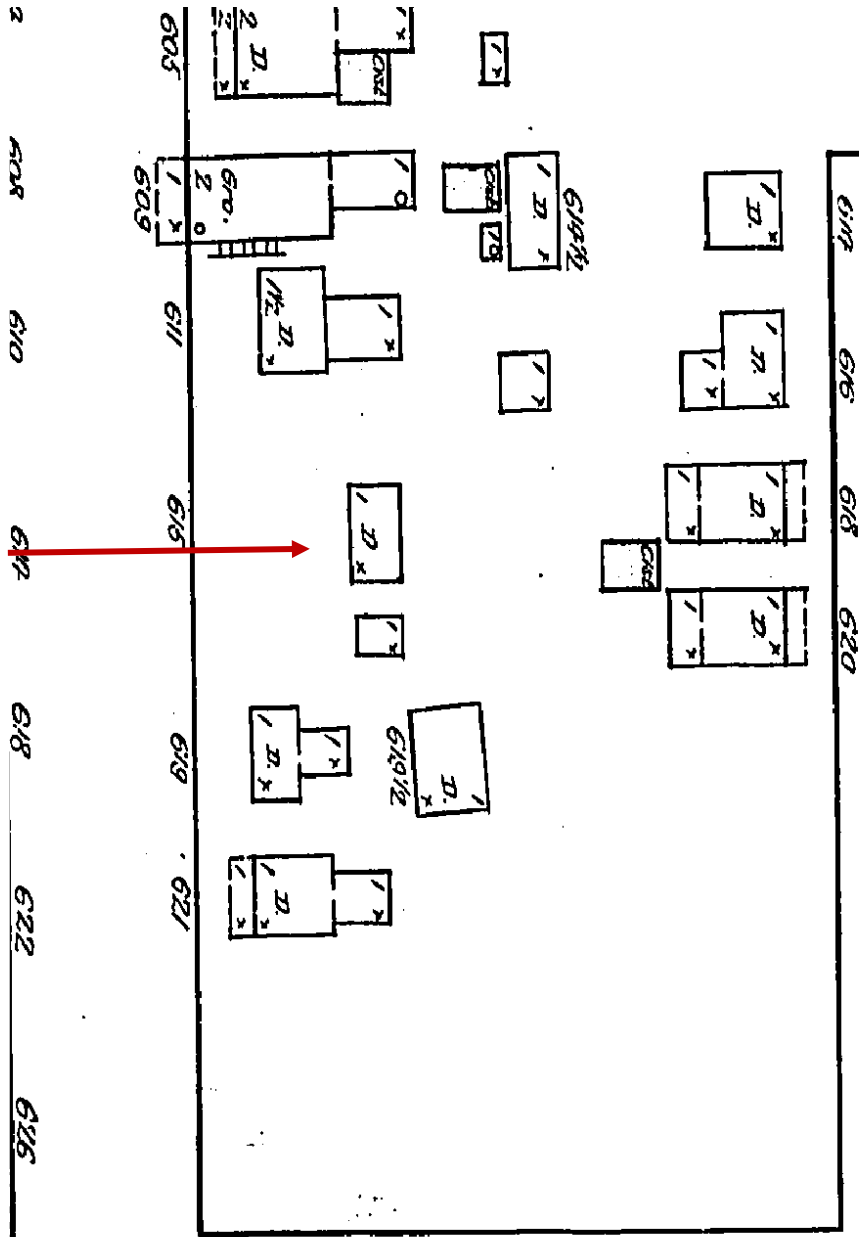

Photo Four

Photo Four Caption **FRONT VIEW** 10-19-2020 Clear Photo Four

SANBORN MAPS

55



ANGELA

1892 Sanborn Map

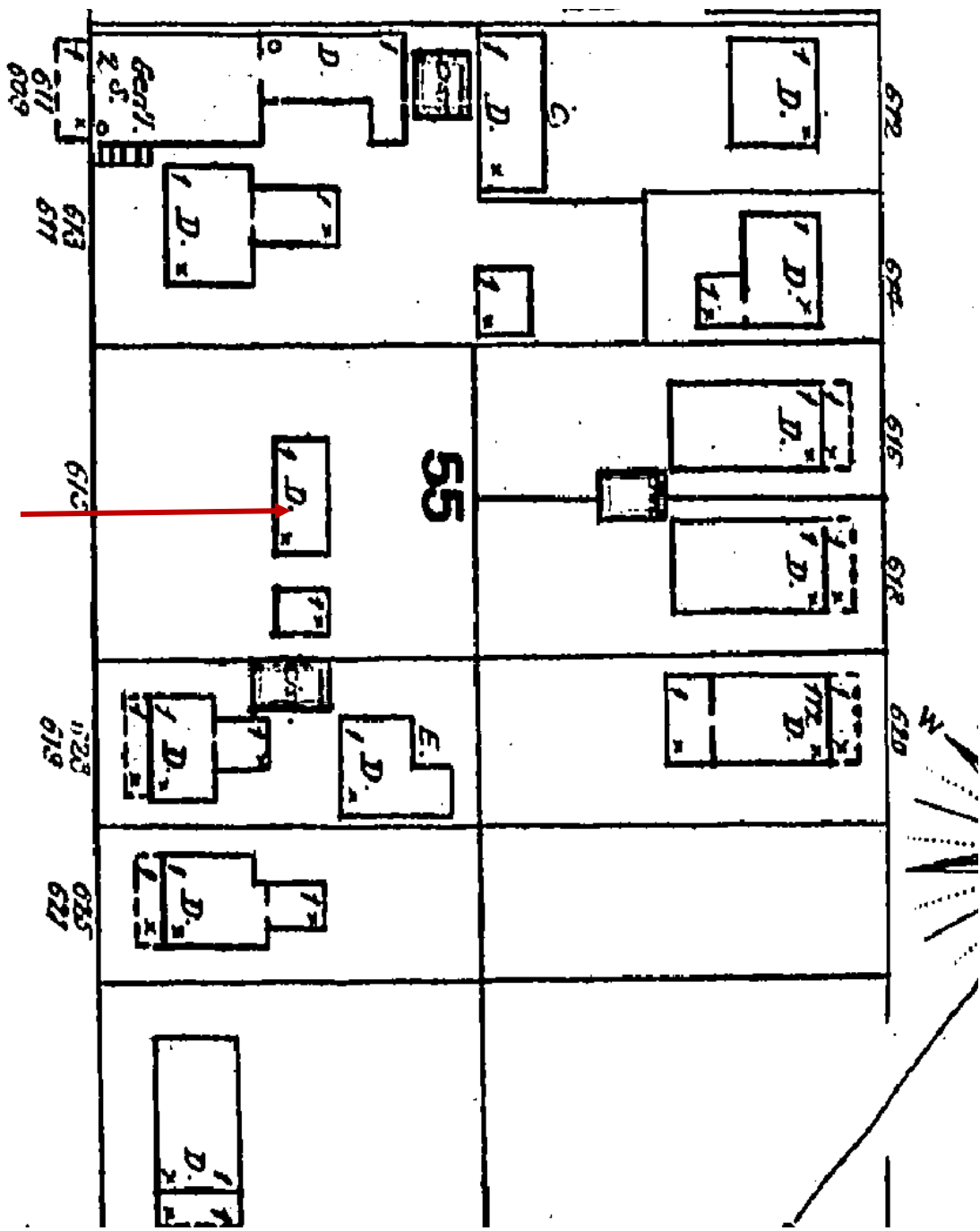

1899 Sanborn Map

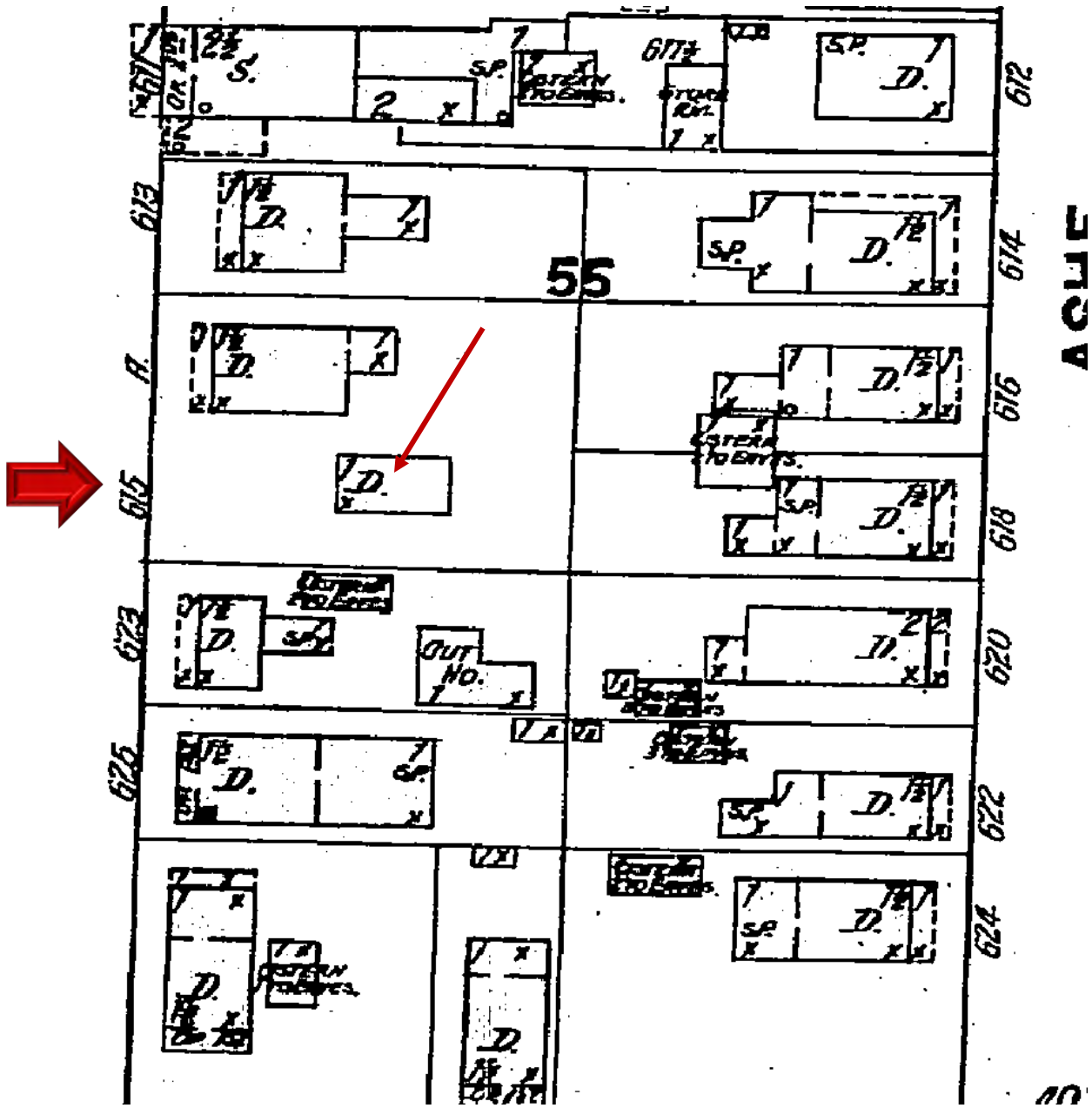

1912 Sanborn Map

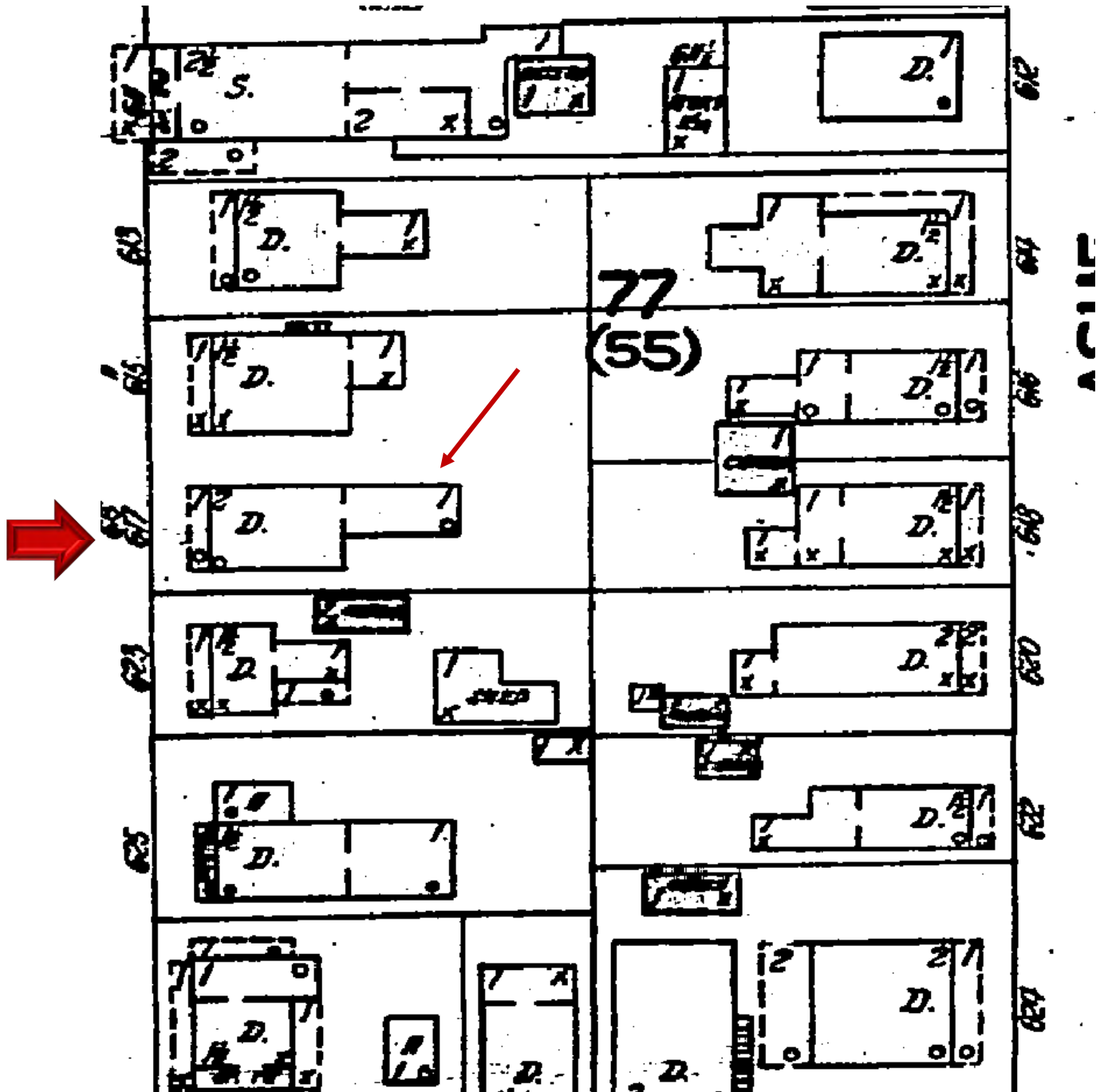

1926 Sanborn Map

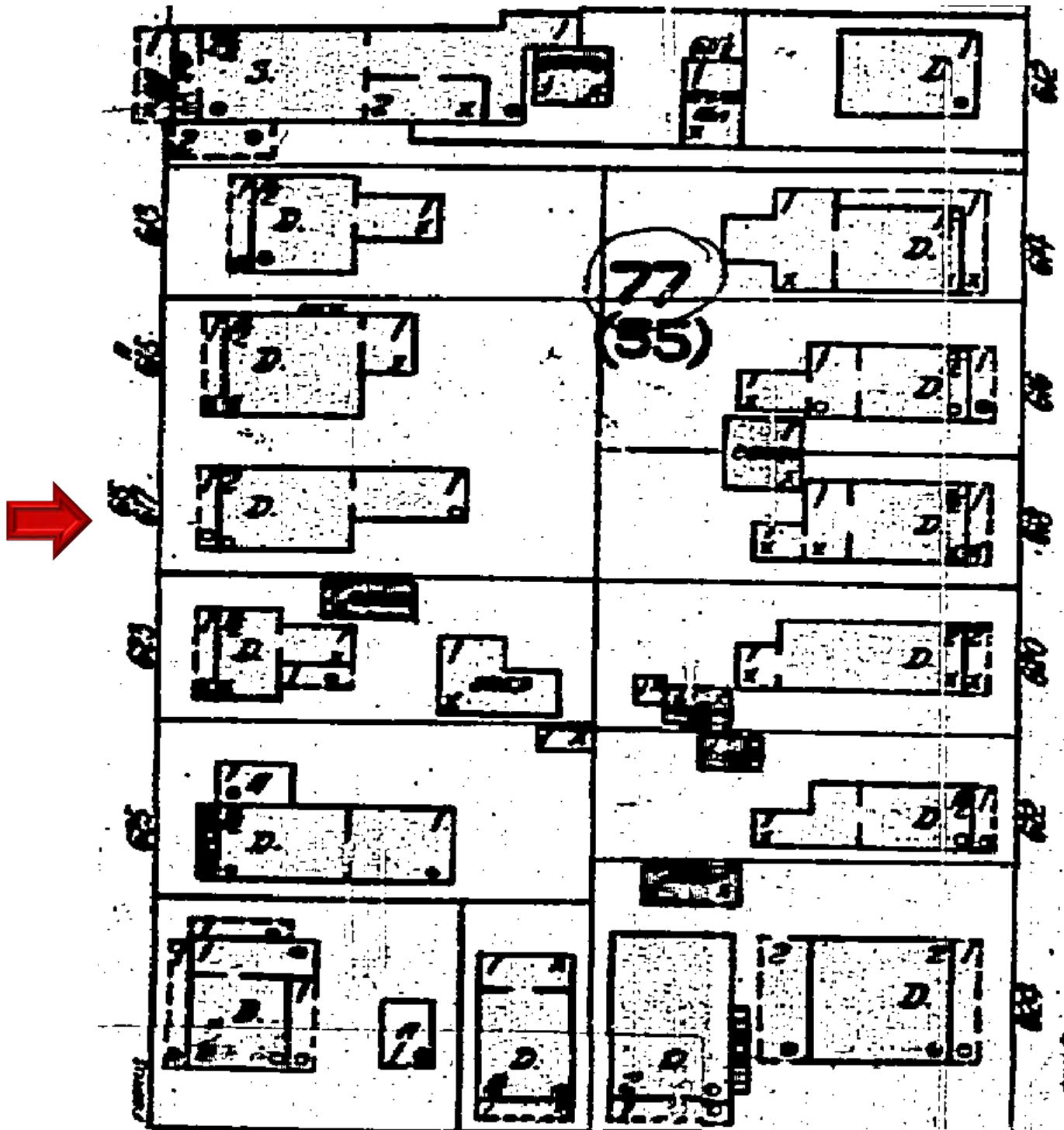

1948 Sanborn Map

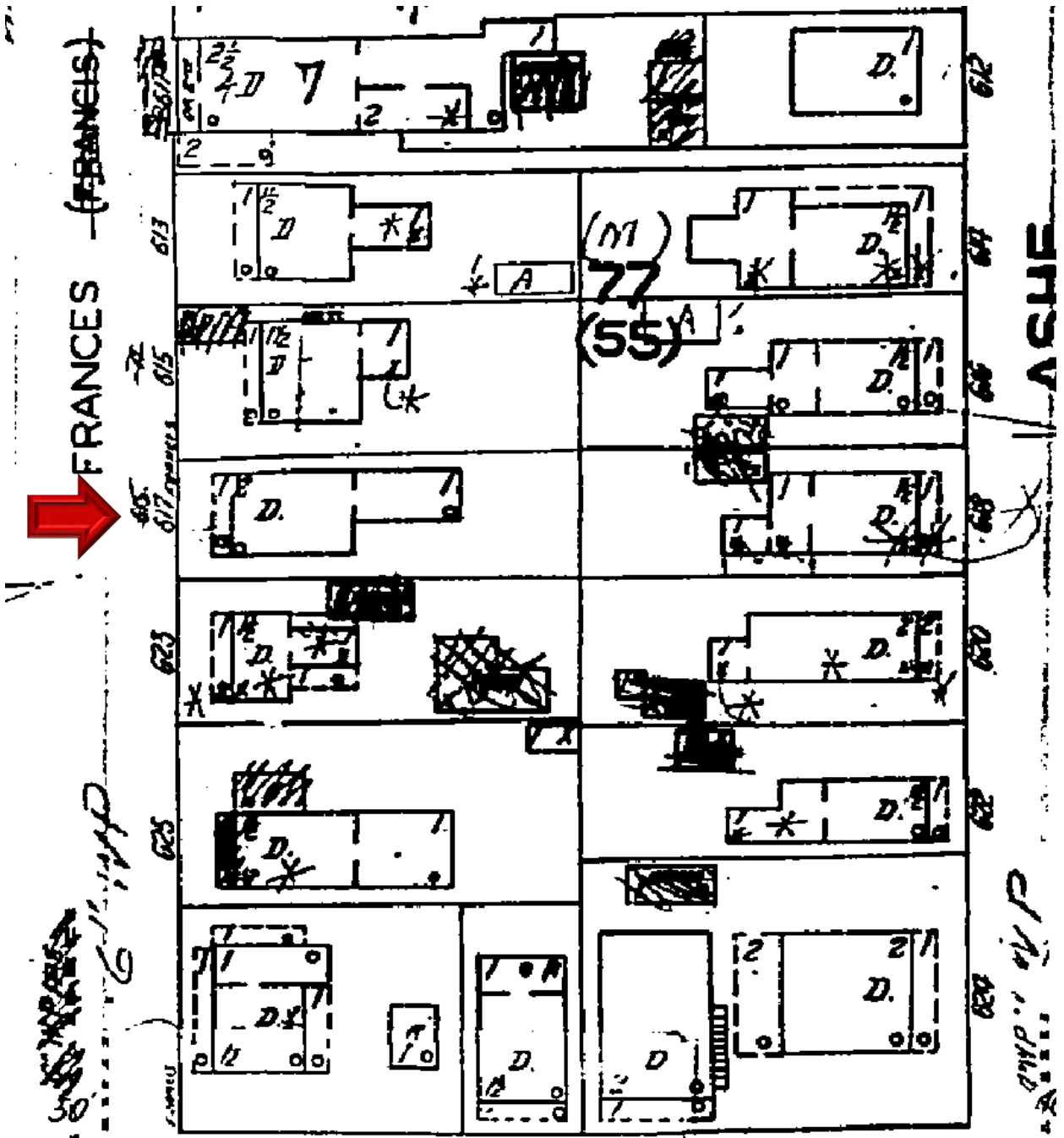

1962 Sanborn Map

PROJECT PHOTOS



617 Frances Street circa 1965. Monroe County Library.















SURVEY

Boundary Survey Map of of part of Lot 4, Square 55, Island of Key West

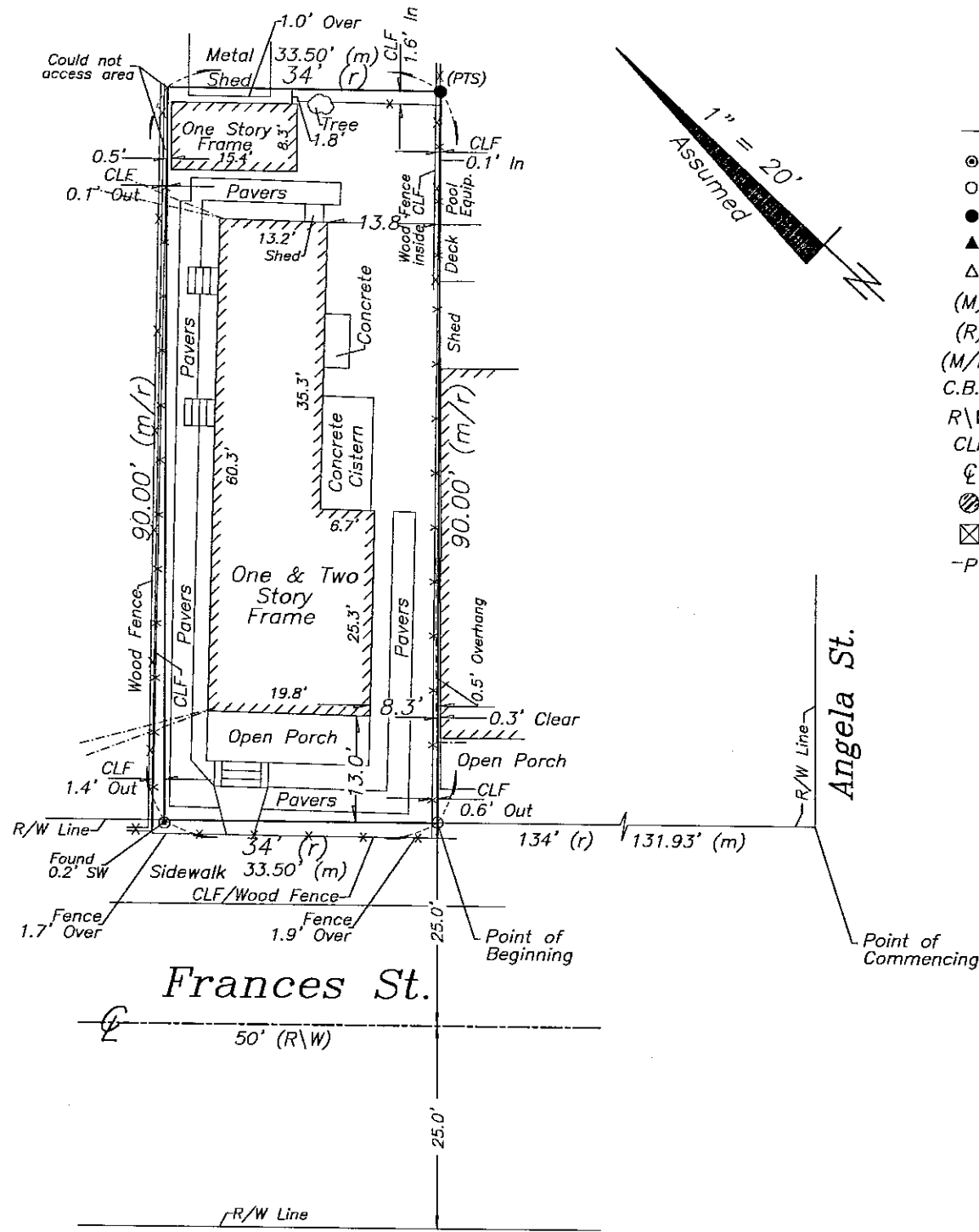

LEGEND

- ⊙ Found 1/2" Iron Pipe (FHH)
- Set 3/4" Iron Pipe w/cap (6298)
- Found 1/2" Iron Rod (As Noted)
- ▲ Found Nail & Disc (6298)
- △ Set Nail & Disc (6298)
- (M) Measured
- (R) Record
- (M/R) Measured & Record
- C.B.S. Concrete Block Structure
- R\W Right of Way
- CLF Chain Link Fence
- ⊕ Centerline
- ⊙ Wood Utility Pole
- ⊗ Concrete Utility Pole
- P- Overhead Utility Lines

- NOTES:**
1. The legal description shown hereon was furnished by the client or their agent. This survey does not determine or imply ownership.
 2. Underground foundations and utilities were not located.
 3. All angles are 90° (Measured & Record) unless otherwise noted.
 4. Street address: 617 Frances Street, Key West, FL.
 5. This survey is not valid without the signature and the original raised seal of a Florida licensed surveyor and mapper.
 6. Lands shown hereon were not abstracted for rights-of-way, easements, ownership, or other instruments of record.
 7. North Arrow is assumed and based on the legal description.
 8. Date of field work: October 18, 2020
 9. Ownership of fences is undeterminable, unless otherwise noted.
 10. Adjoiners are not furnished.

BOUNDARY SURVEY OF: Part of Lot 4, Square 55, but better known as part of Lot 4 according to a plan of the said Square 55, a diagram of which is recorded in Book "T", Pages 36-37, Monroe County Records.
COMMENCING at a point distant from the corner of Frances and Angela Street, on the said France Street, One Hundred Thirty-four (134) feet; and running thence along Frances Street in a Northwesterly direction Thirty-four (34) feet; thence at right angles in a Northeasterly direction Ninety (90) feet; thence at right angles in a Southeasterly direction Thirty-four (34) feet; thence at right angles in a Southwesterly direction Ninety (90) feet, back to the Point of Beginning on Frances Street.

BOUNDARY SURVEY FOR: Thomas J. Gosline as Trustee of the Thomas J. Gosline 2012 Revocable Trust;
 William F. Fritz as Trustee of the William F. Fritz 2012 Revocable Trust;
 Spottswood, Spottswood, Spottswood & Sterling, PLLC; Chicago Title Insurance Company;

I HEREBY CERTIFY that this survey was made under my responsible charge and meets the Standard of Practice as set forth by the Florida Board of Professional Surveyors & Mappers in Chapter 5J-17, Florida Administrative Code, pursuant to Section 472.027, Florida Statutes.

J. LYNN O'FLYNN, INC.

J. Lynn O'Flynn, PSM
 Florida Reg. #6298

October 20, 2020

THIS SURVEY
 IS NOT
 ASSIGNABLE

J. LYNN O'FLYNN, Inc.

Professional Surveyor & Mapper
 PSM #8298

3430 Duck Ave., Key West, FL 33040
 (305) 296-7422 FAX (305) 296-2244

PROPOSED DESIGN

SITE DEVELOPMENT SUMMARY

SITE DATA:

TOTAL SITE AREA: 3,060 SQ.FT
 LAND USE: HHDR
 FLOOD ZONE: ZONE X

SETBACKS

FRONT:
 REQUIRED 10'-0"
 EXISTING ±6'-11"
 PROPOSED ±6'-11"

SIDE:
 REQUIRED 5'-0"
 EXISTING ±0'-3" (±5'-7")
 PROPOSED ±7'-3"

SIDE:
 REQUIRED 5'-0"
 EXISTING ±6'-7"
 PROPOSED ±5'-0"

REAR:
 REQUIRED 20'-0"
 EXISTING ±1'-10"
 PROPOSED ±43'-0"

SETBACKS - ACCESSORY

FRONT:
 REQUIRED 10'-0"
 PROPOSED 68'-6"

SIDE:
 REQUIRED 5'-0"
 PROPOSED 5'-0"

SIDE:
 REQUIRED 5'-0"
 PROPOSED 4'-0"
VARIANCE REQUIRED

REAR:
 REQUIRED 5'-0"
 PROPOSED 5'-0"

MAXIMUM IMPERVIOUS SURFACE RATIO:

REQUIRED 60% (1,836 SQ.FT.)
 EXISTING 58.00% (±1,775 SQ.FT.)
 PROPOSED 48.93 (±1,497.5 SQ.FT.)
IMPROVEMENT

BUILDINGS ±1,048 SQ.FT.
 POOL ±336 SQ.FT.
 POOL EQUIPMENT ±33 SQ.FT.
 PERMEABLE PAVERS ±113 SQ.FT. @50%±56.5 SQ.FT.
 EXISTING SHED ±9 SQ.FT.(ENCROACHMENT)
 CONC. PAD AND STAIRS ±15 SQ.FT.

TOTAL ± 1,497.5 SQ.FT.

MAXIMUM BUILDING COVERAGE:

REQUIRED 50% MAX. (±1,530 SQ.FT.)
 EXISTING 39.38% (±1,205 SQ.FT.)
 PROPOSED 59.28% (±1,814 SQ.FT. - INCLUDING 584 SQ.FT. FOR 40" POOL DECK AND POOL)
VARIANCE REQUIRED

MINIMUM OPEN SPACE:

REQUIRED 35% (±1,071.0 SQ.FT.)
 EXISTING 38.80% (± 1,170.0 SQ.FT.)
 PROPOSED 35.35% (±1,082.0 SQ.FT.)

MAXIMUM HEIGHT:

30 FT
 EXISTING 23'-9"
 PROPOSED 24'-9"

REAR SETBACK COVERAGE:

TOTAL AREA: < 30% (±204 SQ.FT.)
 RELOCATED BUILDING: ±680 SQ.FT.
 COVERED BY EXIS. SHED: ±383 SQ.FT.
 TOTAL COVERAGE: ±9 SQ.FT. ±392 SQ.FT. (57.65%)
VARIANCE REQUIRED

REV:	DESCRIPTION:	BY:	DATE:
STATUS:			



ARTIBUS DESIGN
 3710 N. ROOSEVELT BLVD
 KEY WEST, FL 33040
 (305) 304-3512
 WWW.ARTIBUSDESIGN.COM
 CA # 30835

CLIENT:
THOMAS GOSLINE & WILLIAM FRITZ

PROJECT: **617 FRANCES STREET**

SITE: **617 FRANCES STREET
 KEY WEST, FL 33040**

TITLE: **SITE PLAN**

SCALE AT 11x17:	DATE:	DRAWN:	CHECKED:
AS SHOWN	03/16/21	VF	SM
PROJECT NO:	DRAWING NO:	REVISION:	
2103-09	C-101	1	

THIS DRAWING IS NOT VALID WITHOUT THE SIGNATURE AND ORIGINAL SEAL.
 SIGNATURE:
 DATE:
 GERRIE MARSHAKOVY
 PROFESSIONAL ENGINEER
 STATE OF FLORIDA
 LICENSE NO. 07481

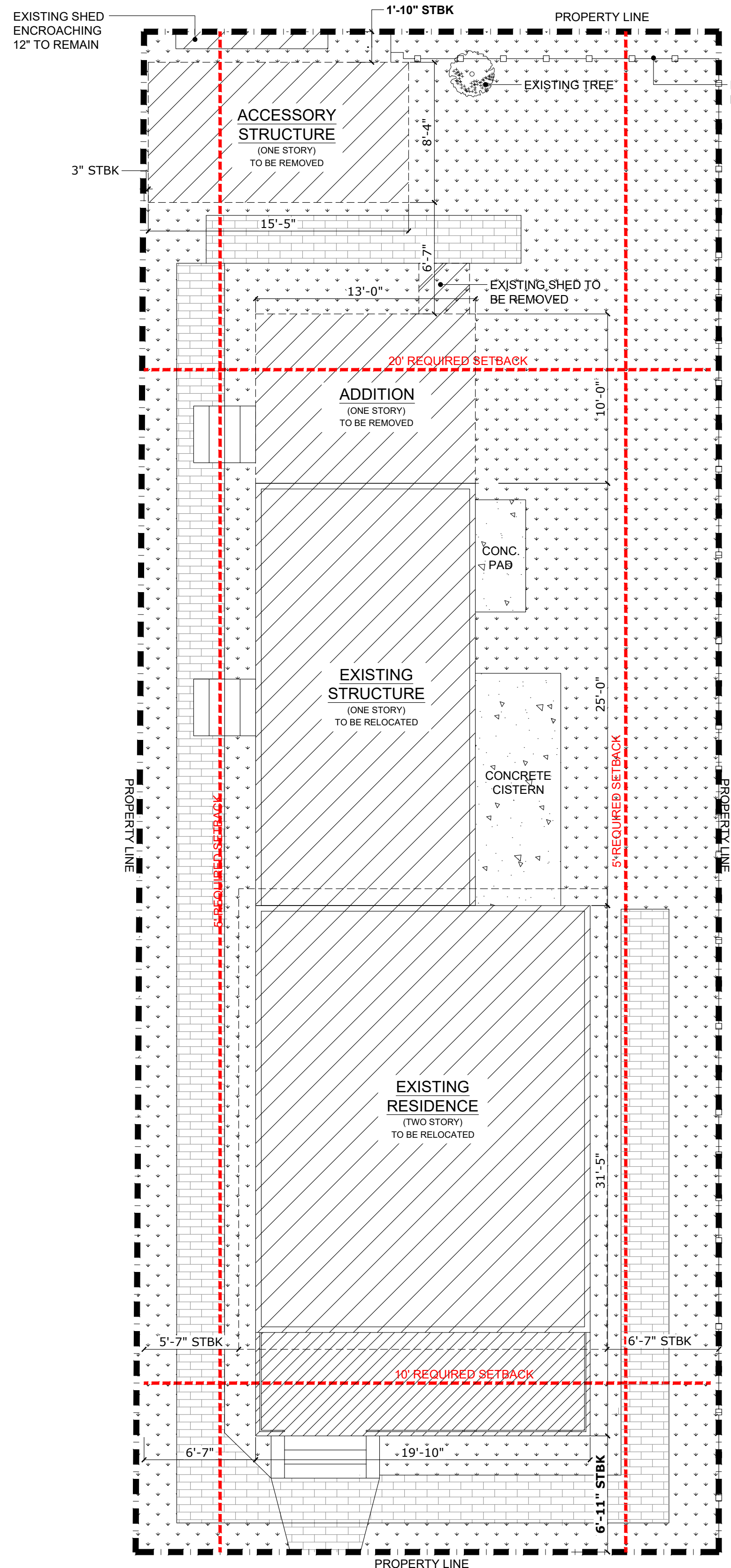
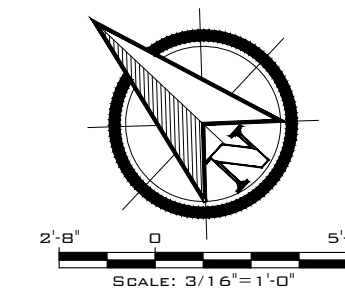

EXISTING SITE PLAN/DEMO
 SCALE: 3/16"=1'-0"

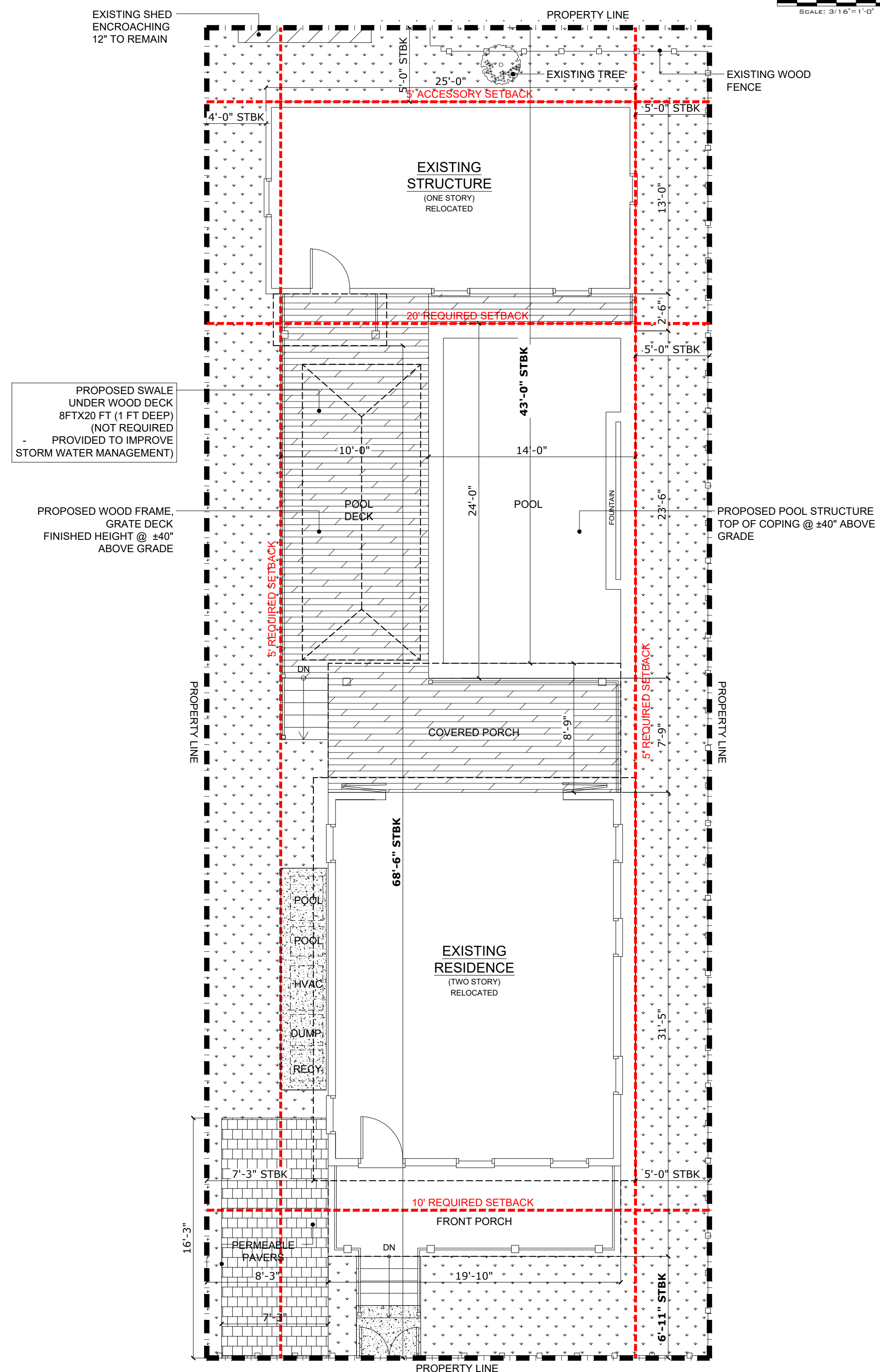
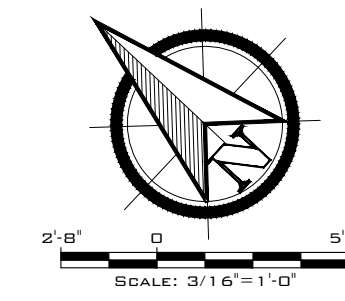

PROPOSED SITE PLAN
 SCALE: 3/16"=1'-0"

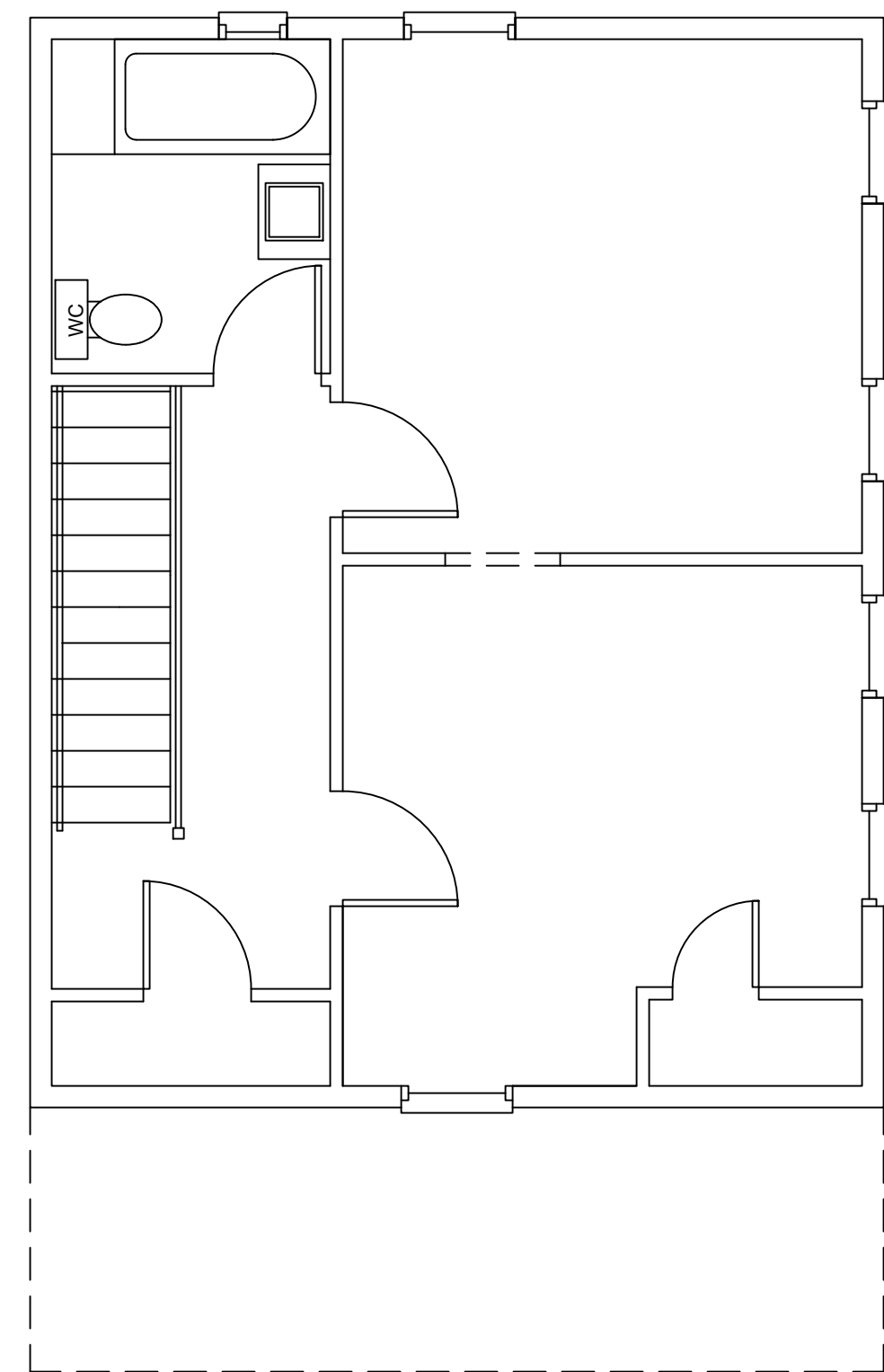

EXISTING SECOND FLOOR

SCALE: 1/4" = 1'-0"

501 SF

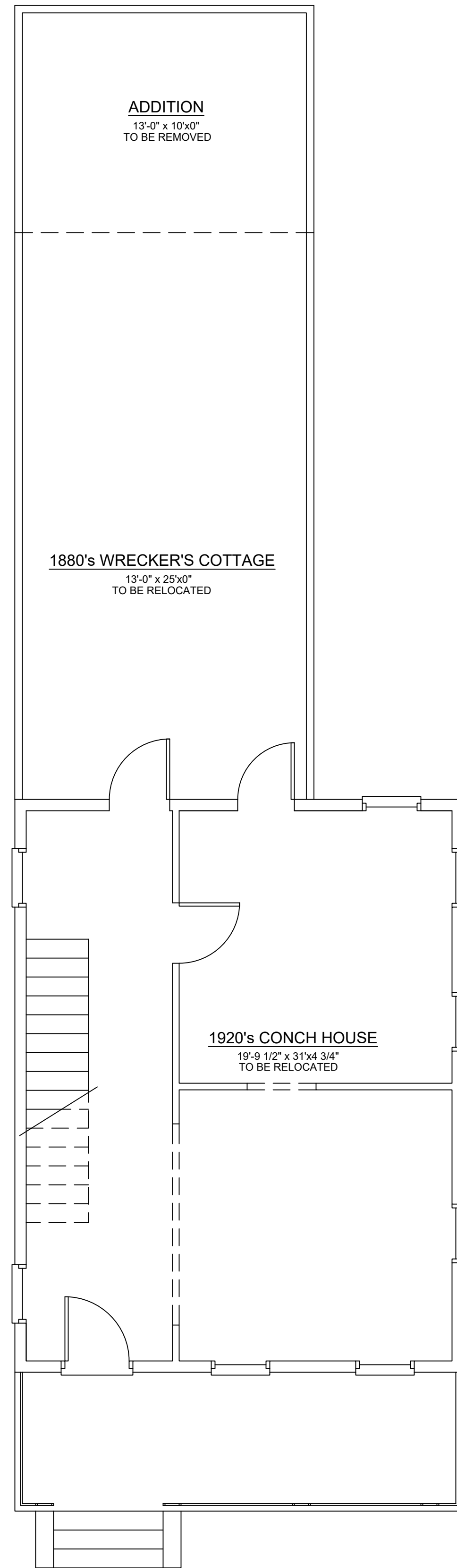

EXISTING FIRST FLOOR

SCALE: 1/4" = 1'-0"

962 SF

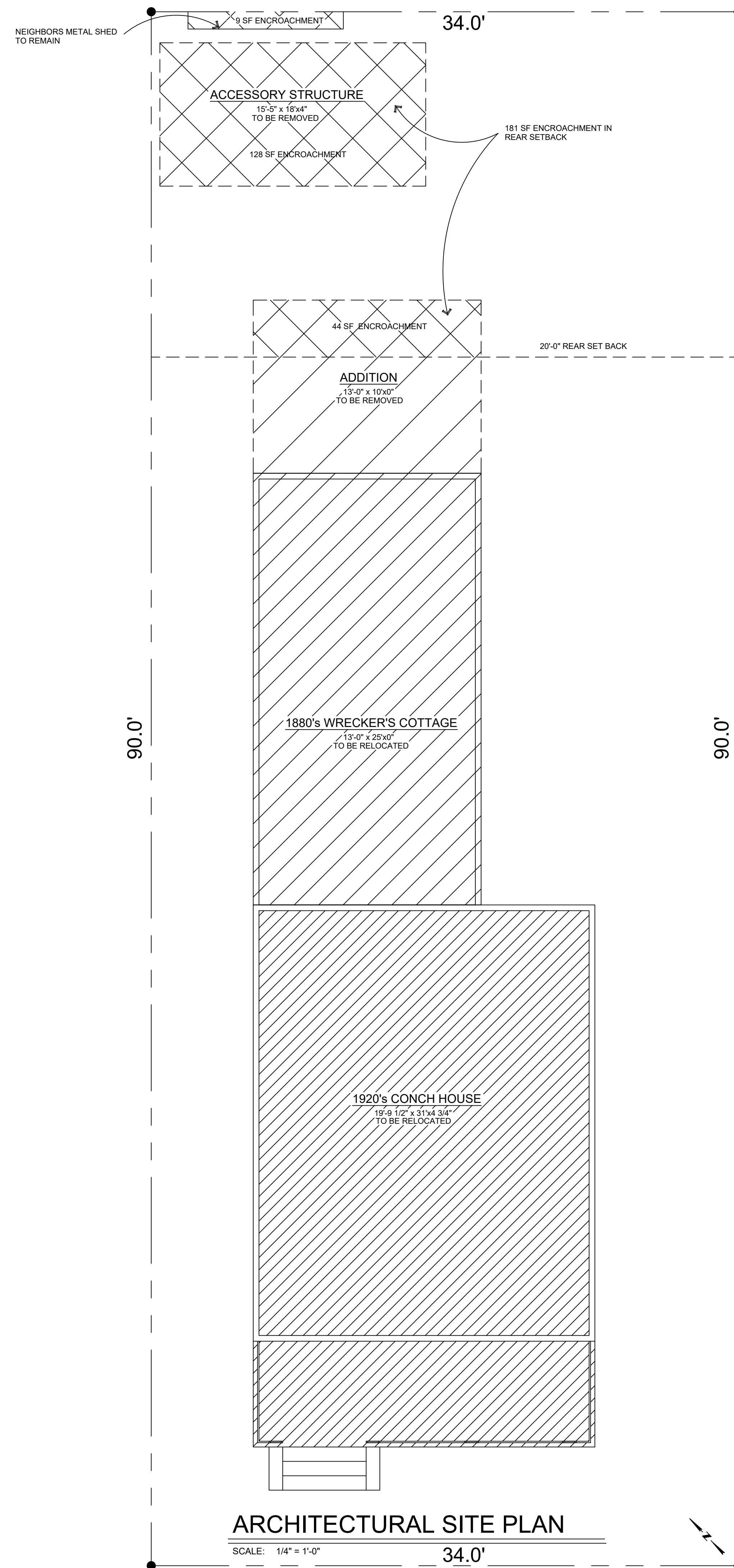

ARCHITECTURAL SITE PLAN

SCALE: 1/4" = 1'-0"

34.0'

Copyright © Jeffrey Robert Steele
Not to be reproduced

Project	Gosline Fritz
Date	06-01-2021
Drawn	JS
Revisions	

JEFFREY ROBERT STEELE AIA
 architect
 42 wyn oak nashville tennessee 37205
 mobile = 615.804.1431 jeffsteelarchitect@gmail.com

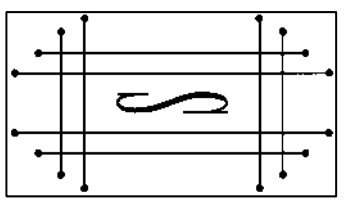

Remodeling 1880's Wrecker's Cottage and a 1920's Conch House For:
FRITZ - GOSLINE RESIDENCE
 617 Francis Street
 Key West, FL

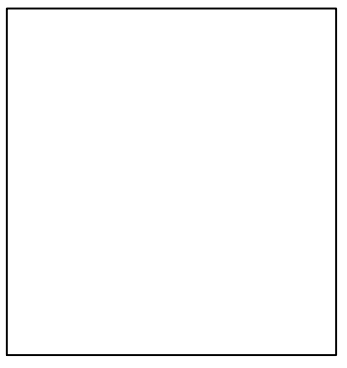

Sheet	of
1	5
Sheets	



EXISTING SOUTH ELEVATION

SCALE: 1/4" = 1'-0"

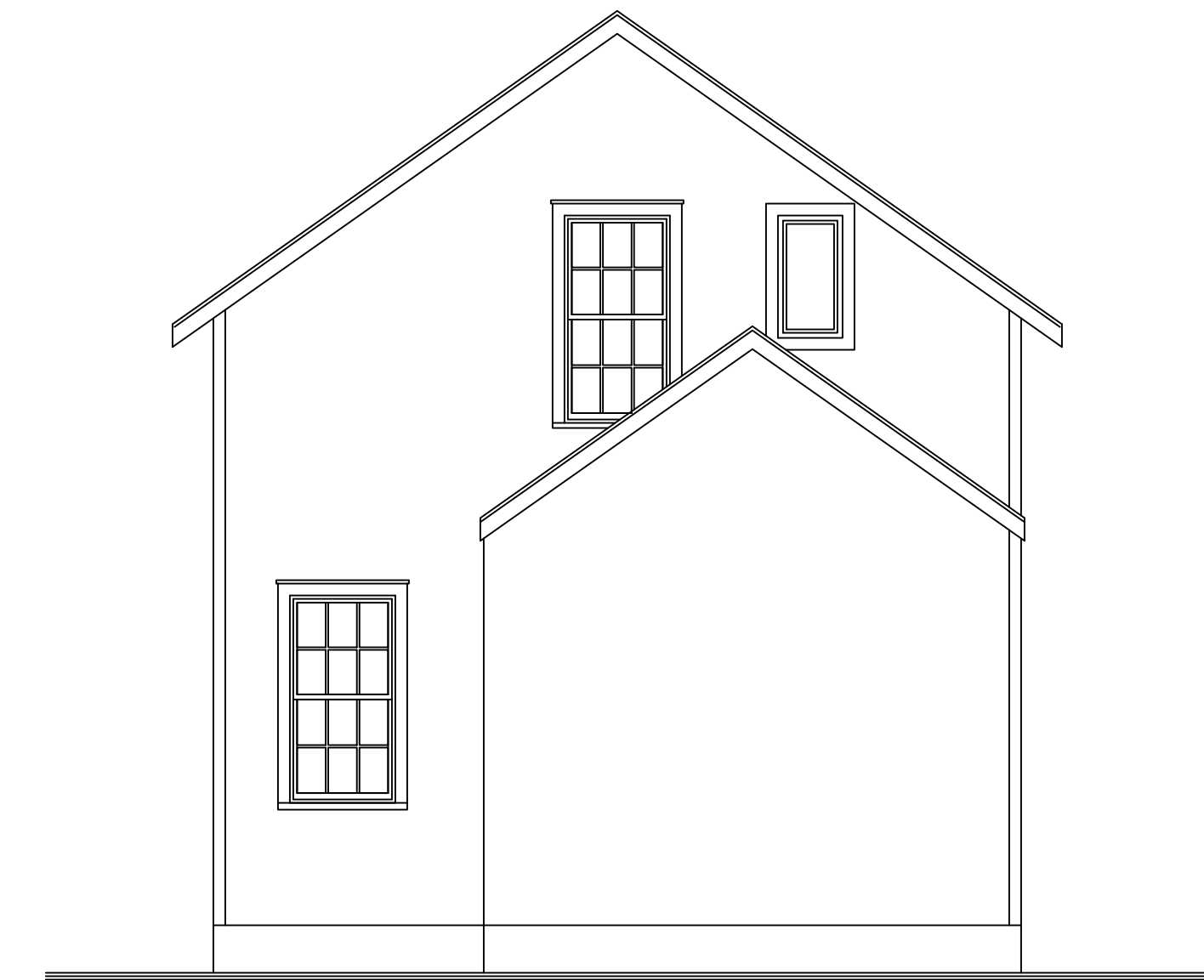

EXISTING EAST ELEVATION

SCALE: 1/4" = 1'-0"

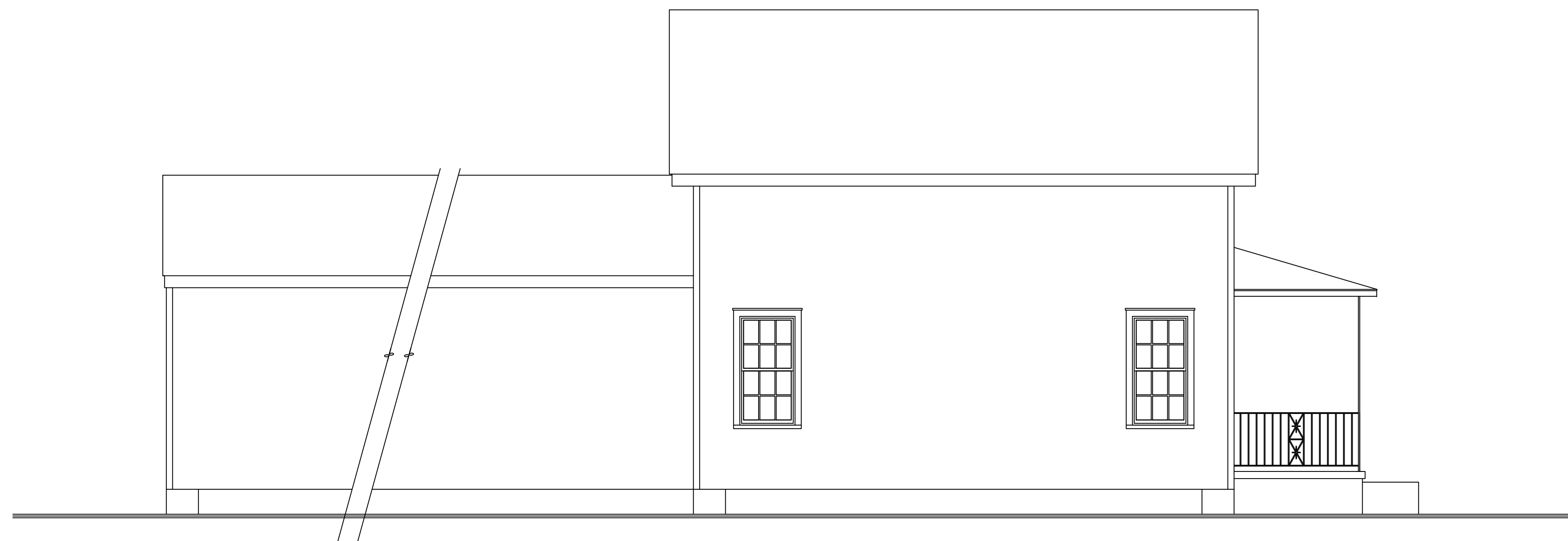

EXISTING NORTH ELEVATION

SCALE: 1/4" = 1'-0"



EXISTING WEST ELEVATION

SCALE: 1/4" = 1'-0"

Copyright © Jeffrey Robert Steele
All rights reserved.

Project	Gosline Fritz
Date	06-01-2021
Drawn	JS
Revisions	

JEFFREY ROBERT STEELE AIA
 architect
 42 wyn oak nashville tennessee 37205
 mobile = 615.804.1431 jeffsteelarchitect@gmail.com

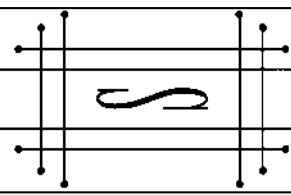

Remodeling 1880's Wrecker's Cottage and a 1920's Conch House For:
FRITZ - GOSLINE RESIDENCE
 617 Francis Street
 Key West, FL

Sheet	of
2	5
Sheets	

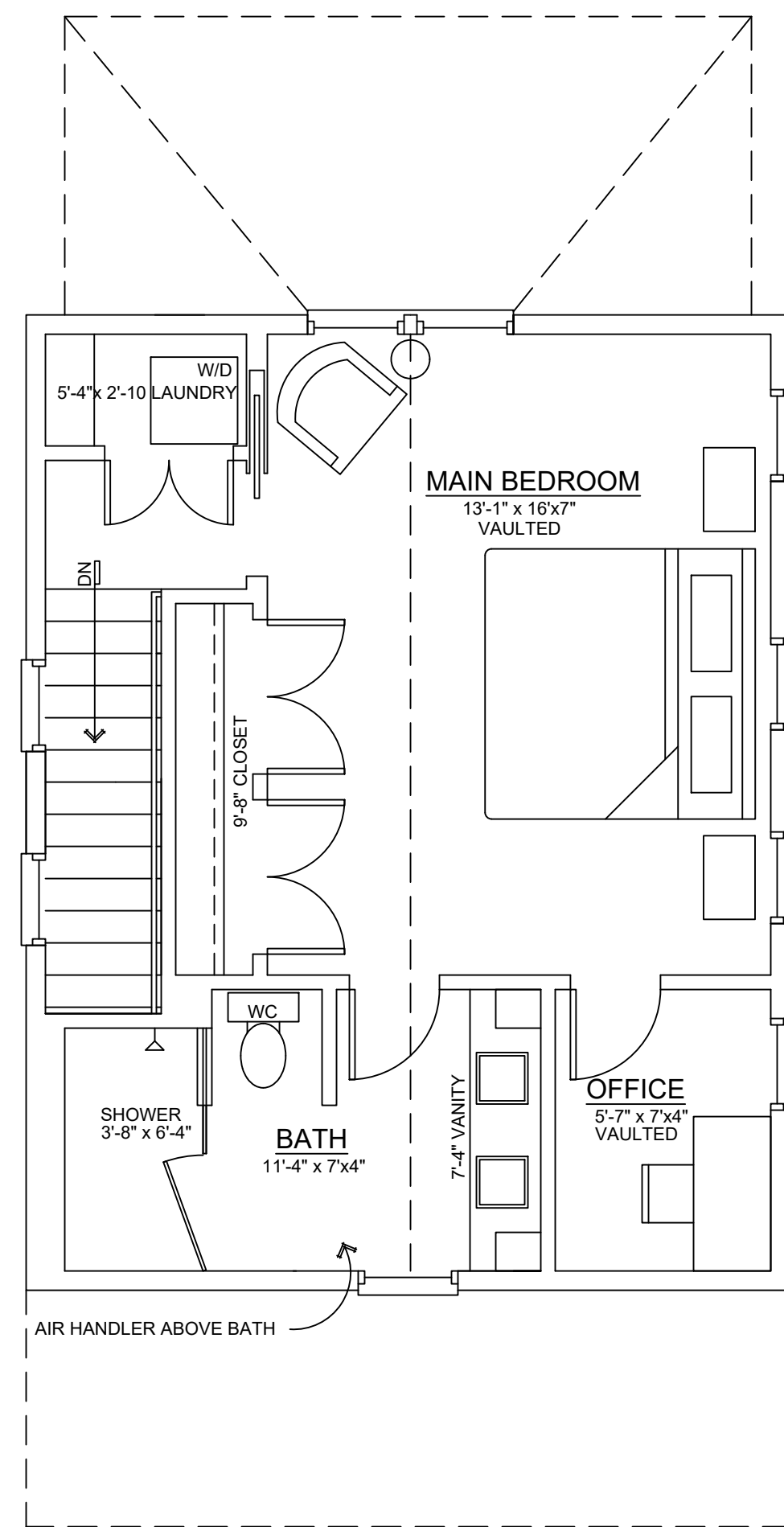

REMODELED SECOND FLOOR

SCALE: 1/4" = 1'-0"

501 SF

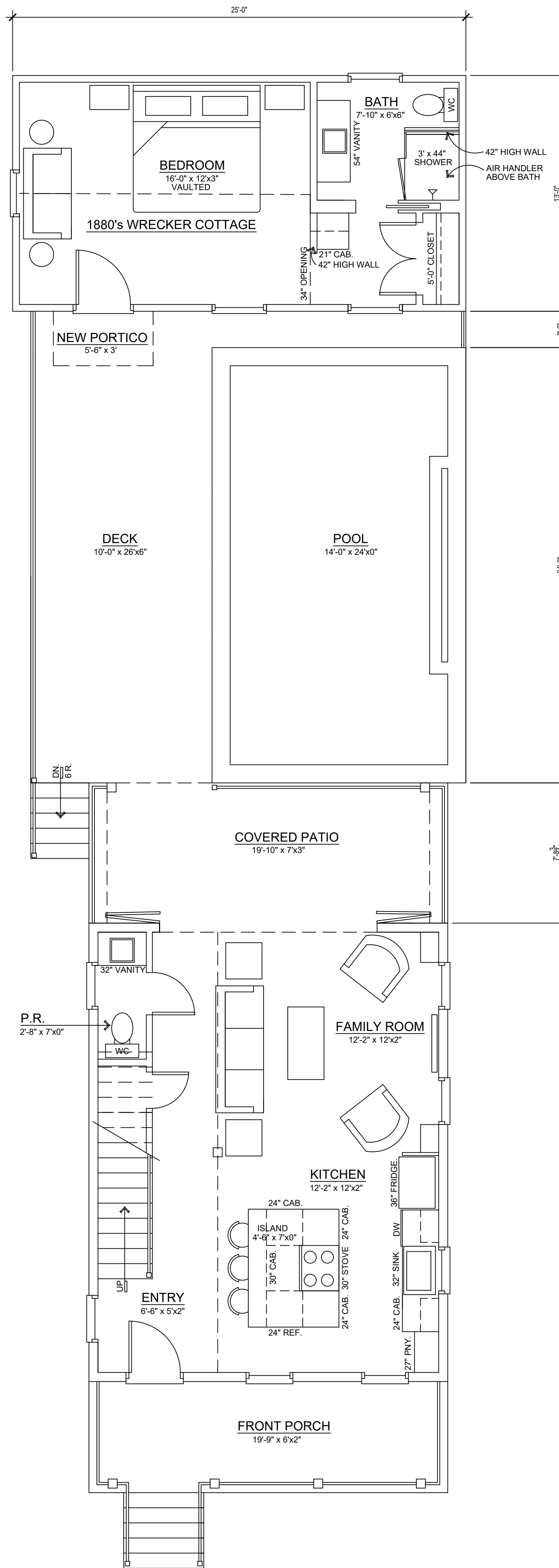

REMODELED FIRST FLOOR

SCALE: 1/4" = 1'-0"

501 SF

Copyright © Jeffrey Robert Steele
 Not to be reproduced
 without permission

Project	Gosline Fritz
Date	06-01-2021
Drawn	JS
Revisions	

JEFFREY ROBERT STEELE AIA
 architect
 42 wyn oak nashville tennessee 37205
 mobile = 615.804.1431 jeffsteelearchitect@gmail.com

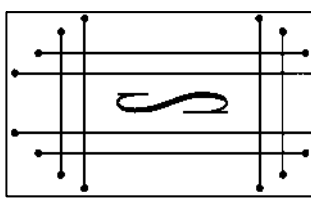

Remodeling 1880's Wrecker's Cottage and a 1920's Conch House For:
FRITZ - GOSLINE RESIDENCE
 617 Francis Street
 Key West, FL

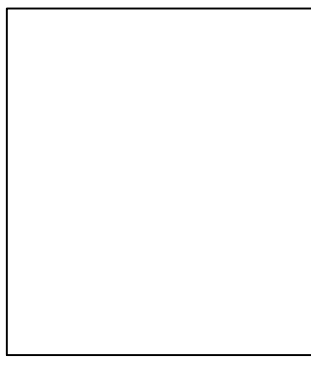

Sheet	of
4	5
Sheets	

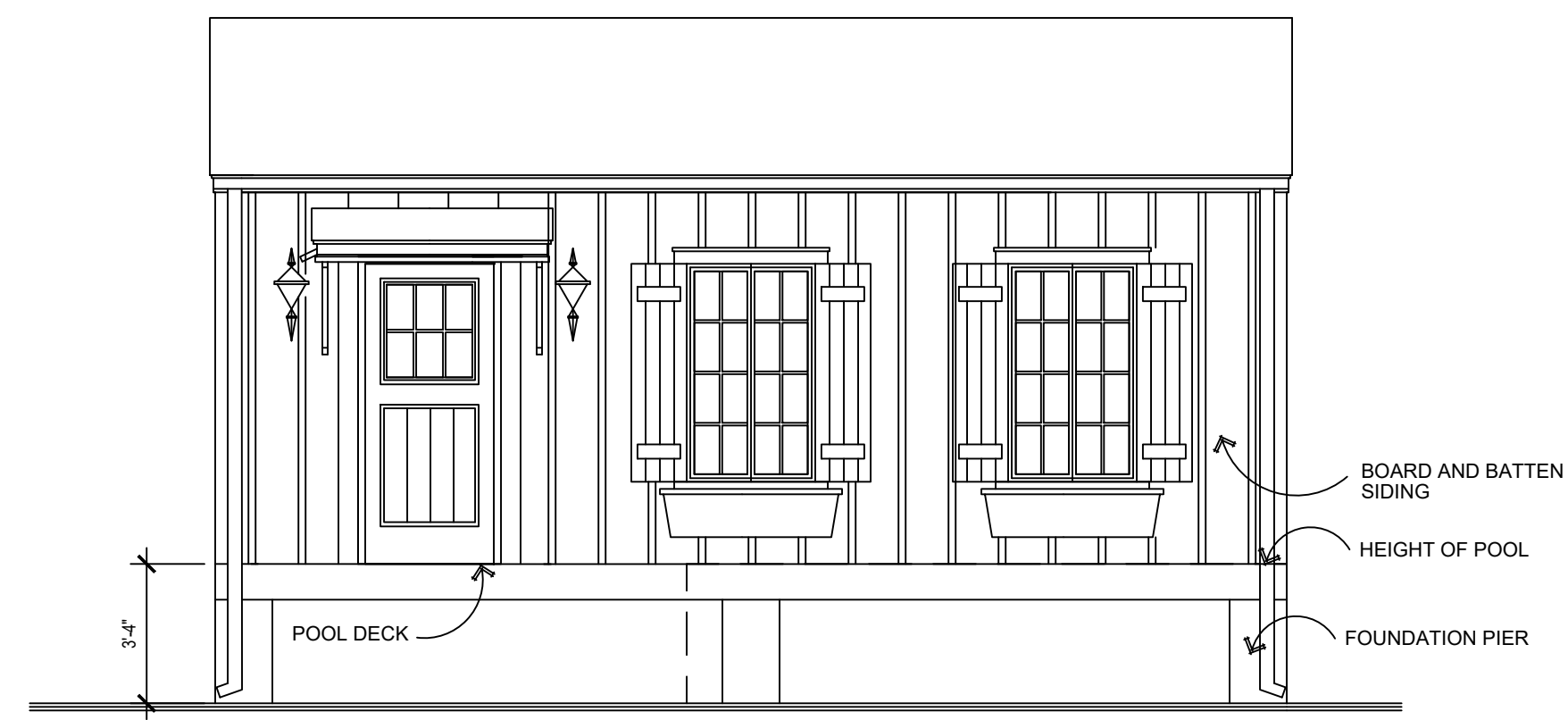

REMODELED WEST ELEVATION

SCALE: 1/4" = 1'-0" 1880'S WRECKER COTTAGE

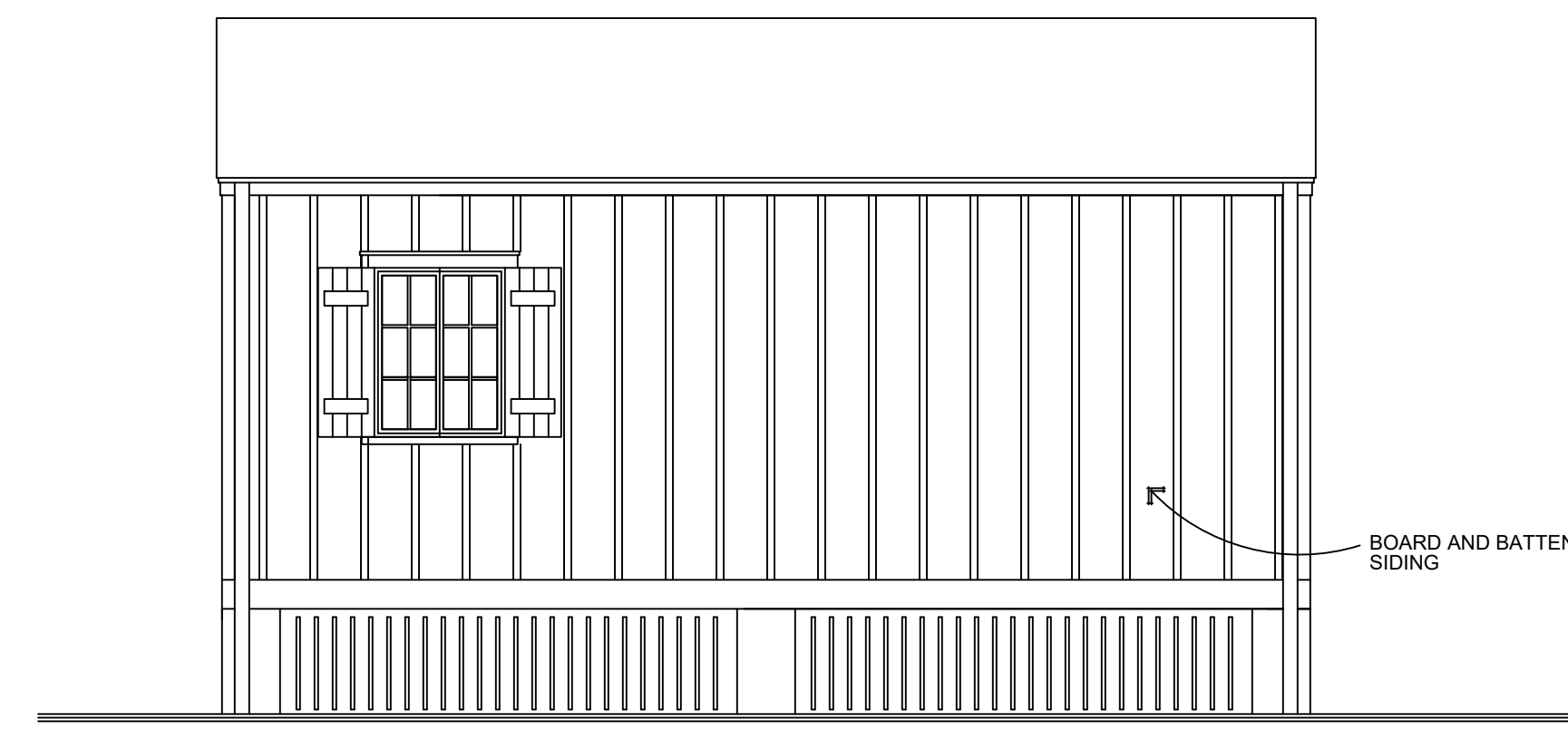

REMODELED EAST ELEVATION

SCALE: 1/4" = 1'-0" 1880'S WRECKER COTTAGE

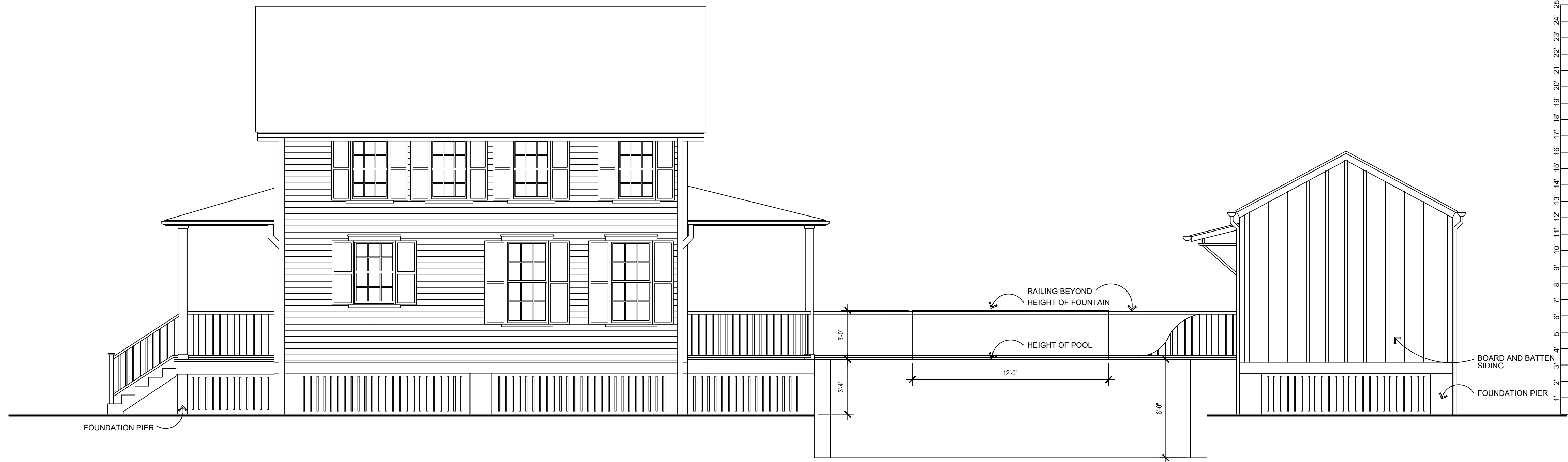
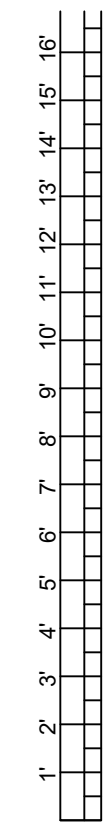

REMODELED SOUTH ELEVATION

SCALE: 1/4" = 1'-0"

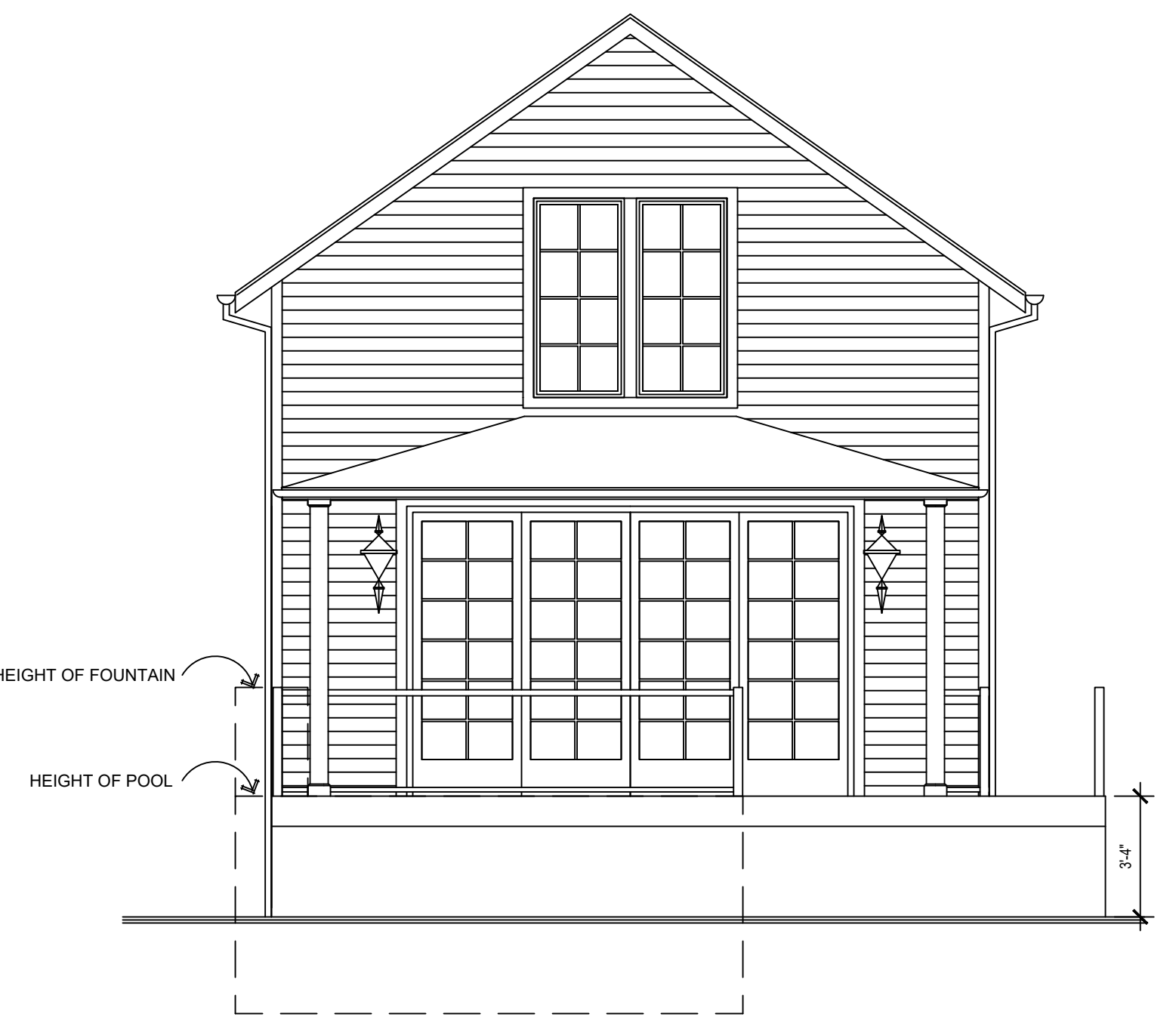

REMODELED EAST ELEVATION

SCALE: 1/4" = 1'-0"

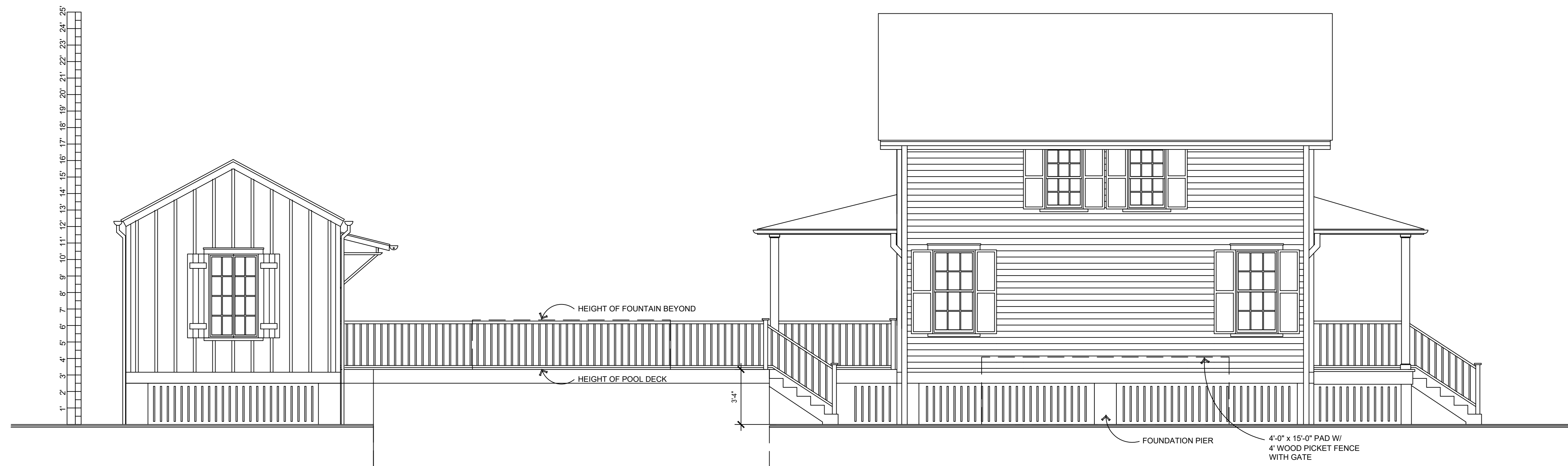
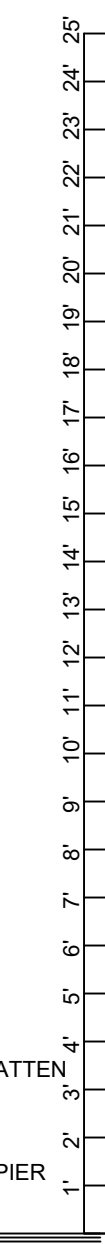

REMODELED NORTH ELEVATION

SCALE: 1/4" = 1'-0"

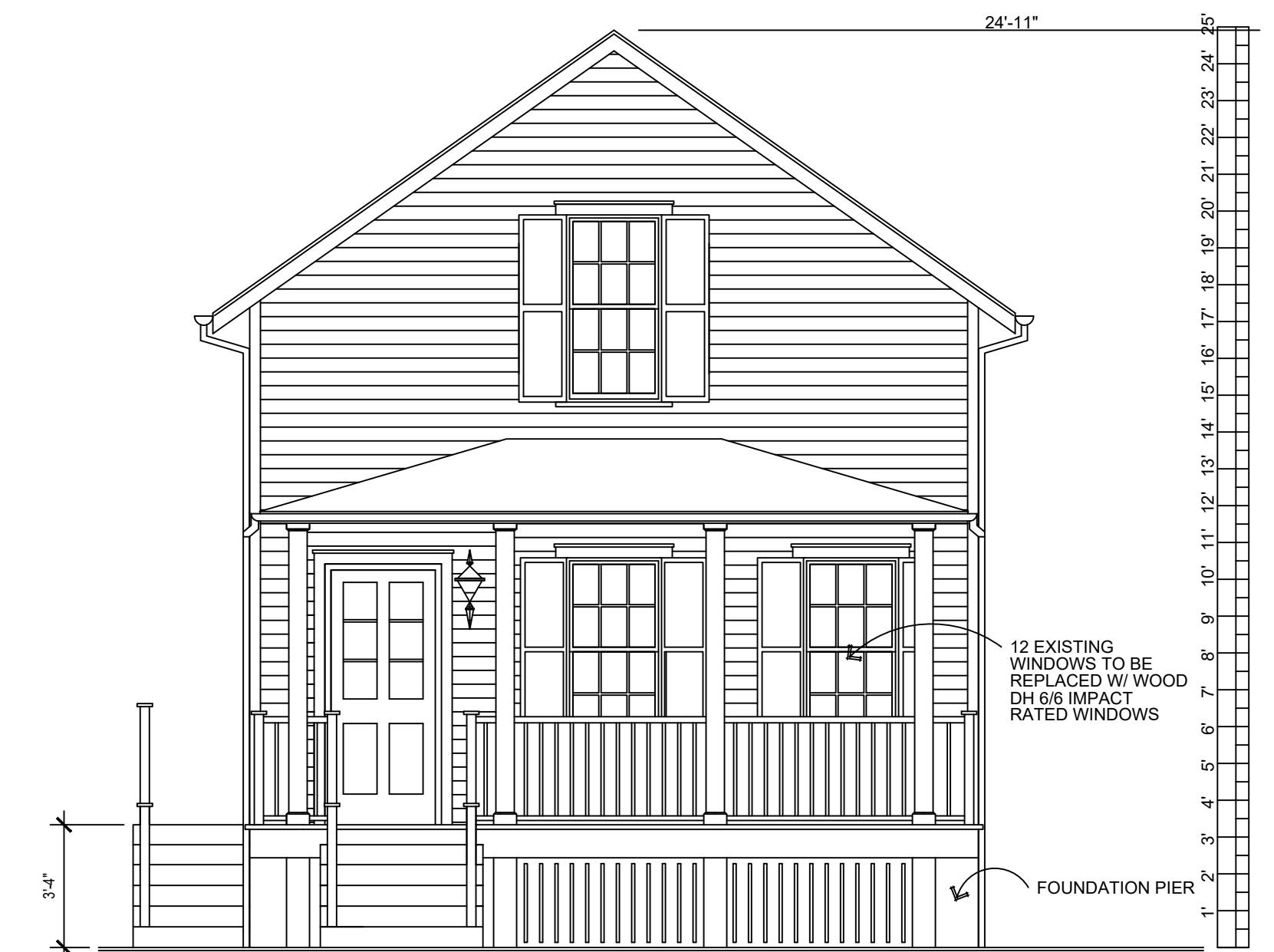

REMODELED WEST ELEVATION

SCALE: 1/4" = 1'-0"

Copyright © Jeffrey Robert Steele
Not to be reproduced

Project	Gosline Fritz
Date	06-01-2021
Drawn	JS
Revisions	

JEFFREY ROBERT STEELE AIA
 architect
 42 wyn oak nashville tennessee 37205
 mobile = 615.804.1431 jeffsteelarchitect@gmail.com

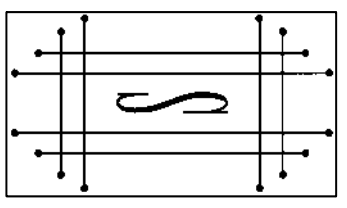

Remodeling 1880's Wrecker's Cottage and a 1920's Conch House For:
FRITZ - GOSLINE RESIDENCE
 617 Francis Street
 Key West, FL

Sheet	of
5	5
Sheets	



STREET SCAPE OF FRANCES ST

SCALE: 1/4" = 1'-0" PROPOSED



STREET SCAPE OF FRANCES ST

SCALE: 1/4" = 1'-0" BEFORE

NOTICING

Public Meeting Notice

The Historic Architectural Review Commission will hold a public meeting at **5:00 p.m., July 28, 2021 at City Hall, 1300 White Street**, Key West, Florida. In order to view the live feed of the meeting, you can tune in to Comcast channel 77, AT&T Uverse channel 99, or type this link into your browser:

http://keywestcity.granicus.com/MediaPlayer.php?publish_id=1&embed=1 If you wish to participate virtually, please contact HARC staff at 305-809-3975. The purpose of the hearing will be to consider a request for:

SEPARATION, RENOVATION, AND ELEVATION OF TWO HISTORIC STRUCTURES. RELOCATION OF ONE HISTORIC STRUCTURE. REPLACEMENT OF ALL WINDOWS WITH WOOD IMPACT UNITS. DEMOLITION OF A NON-HISTORIC SHED AND A NON-HISTORIC REAR ADDITION.

#617 FRANCES STREET

Applicant – Tom Gosline

Application #H2021-0038

If you wish to see the application or have any questions, you may visit the Planning Department during regular office hours at 1300 White Street, call 305-809-3973 or visit our website at www.cityofkeywest-fl.gov.

THIS NOTICE CAN NOT BE REMOVED FROM THE SITE UNTIL HARC FINAL DETERMINATION

ADA ASSISTANCE: It is the policy of the City of Key West to comply with all requirements of the Americans with Disabilities Act (ADA). Please call the TTY number at 800-955-8771 or 800-955-8770 (Voice) or the ADA Coordinator at 305-809-3811 at least five business days in advance for sign language interpreters, assistive listening devices, or materials in accessible format.



HARC POSTING AFFIDAVIT

STATE OF FLORIDA:
COUNTY OF MONROE:

BEFORE ME, the undersigned authority, personally appeared Emid foregross, who, first being duly sworn, on oath, depose and says that the following statements are true and correct to the best of his/her knowledge and belief:

1. That a legal notice for Public Notice of Hearing of the Historic Architectural Review Commission (HARC) was placed on the following address:
617 Frances street on the 21 day of July, 2021.

This legal notice(s) contained an area of at least 8.5"x11".

The property was posted to notice a public hearing before the Key West Historic Architectural Review Commission to be held on July 28, 2021.

The legal notice(s) is/are clearly visible from the public street adjacent to the property.

The Certificate of Appropriateness number for this legal notice is H 2021-0038

2. A photograph of that legal notice posted in the property is attached hereto.

Signed Name of Affiant:

[Signature]
Date: July 21, 2021
Address: 1300 White street
City: Key West
State, Zip: FL 33040

The forgoing instrument was acknowledged before me on this 21 day of July, 2021.

By (Print name of Affiant) Emid foregross who is personally known to me or has produced _____ as identification and who did take an oath.

NOTARY PUBLIC

Sign Name: Alexander C. Hill
Print Name: Alexander R. Hill
Notary Public - State of Florida (seal)
My Commission Expires: _____



PROPERTY APPRAISER INFORMATION



Disclaimer

The Monroe County Property Appraiser's office maintains data on property within the County solely for the purpose of fulfilling its responsibility to secure a just valuation for ad valorem tax purposes of all property within the County. The Monroe County Property Appraiser's office cannot guarantee its accuracy for any other purpose. Likewise, data provided regarding one tax year may not be applicable in prior or subsequent years. By requesting such data, you hereby understand and agree that the data is intended for ad valorem tax purposes only and should not be relied on for any other purpose.

By continuing into this site you assert that you have read and agree to the above statement.

Summary

Parcel ID 00010430-000000
 Account# 1010723
 Property ID 1010723
 Millage Group 10KW
 Location 617 FRANCES St, KEY WEST
 Address
 Legal KW PT LOT 4 SQR 55 A1-220 OR479-835 OR626-527 OR646-47 OR2381-2460
 Description OR2451-2087/88 OR3052-2262
 (Note: Not to be used on legal documents.)
 Neighborhood 6108
 Property Class SINGLE FAMILY RESID (0100)
 Subdivision
 Sec/Twp/Rng 06/68/25
 Affordable No
 Housing



Owner

GOSLINE THOMAS J 2012 REVOCABLE TRUST
 595 Lincoln Ave
 Glencoe IL 60022

FRITZ WILLIAM F 2012 REVOCABLE TRUST
 595 Lincoln Ave
 Glencoe IL 60022

Valuation

	2020	2019	2018	2017
+ Market Improvement Value	\$153,538	\$126,917	\$128,840	\$130,763
+ Market Misc Value	\$3,199	\$3,199	\$3,219	\$3,238
+ Market Land Value	\$601,122	\$633,573	\$557,853	\$557,853
= Just Market Value	\$757,859	\$763,689	\$689,912	\$691,854
= Total Assessed Value	\$496,437	\$485,276	\$476,228	\$466,433
- School Exempt Value	(\$25,000)	(\$25,000)	(\$25,000)	(\$25,000)
= School Taxable Value	\$471,437	\$460,276	\$451,228	\$441,433

Land

Land Use	Number of Units	Unit Type	Frontage	Depth
RESIDENTIAL DRY (010D)	3,060.00	Square Foot	33.5	90

Buildings

Building ID 702
 Style 2 STORY ELEV FOUNDATION
 Building Type S.F.R. - R1 / R1
 Gross Sq Ft 1673
 Finished Sq Ft 955
 Stories 2 Floor
 Condition AVERAGE
 Perimeter 160
 Functional Obs 0
 Economic Obs 0
 Depreciation % 44
 Interior Walls WALL BD/WD WAL

Exterior Walls WD FRAME
 Year Built 1933
 EffectiveYearBuilt 1975
 Foundation WD CONC PADS
 Roof Type GABLE/HIP
 Roof Coverage METAL
 Flooring Type SFT/HD WD
 Heating Type
 Bedrooms 3
 Full Bathrooms 2
 Half Bathrooms 0
 Grade 400
 Number of Fire Pl 0

Code	Description	Sketch Area	Finished Area	Perimeter
FAT	FINISHED ATTIC	500	0	90
FLA	FLOOR LIV AREA	955	955	160
OPU	OP PR UNFIN LL	98	0	42
OPF	OP PRCH FIN LL	120	0	52
TOTAL		1,673	955	344

Yard Items

Description	Year Built	Roll Year	Quantity	Units	Grade
FENCES	2001	2002	1	132 SF	2
CH LINK FENCE	1964	1965	1	720 SF	1

Sales

Sale Date	Sale Price	Instrument	Instrument Number	Deed Book	Deed Page
10/23/2020	\$730,000	Warranty Deed	2288101	3052	2262
2/2/2010	\$487,500	Warranty Deed		2451	2087
2/1/1976	\$36,000	Conversion Code		646	47

Permits

Number	Date Issued	Date Completed	Amount	Permit Type
03-4094	12/4/2003	9/27/2004	\$12,000	
0003158	10/6/2000	12/21/2000	\$2,000	
0001687	6/22/2000	7/20/2000	\$400	
0000812	3/29/2000	7/20/2000	\$3,000	

View Tax Info

[View Taxes for this Parcel](#)

Sketches (click to enlarge)

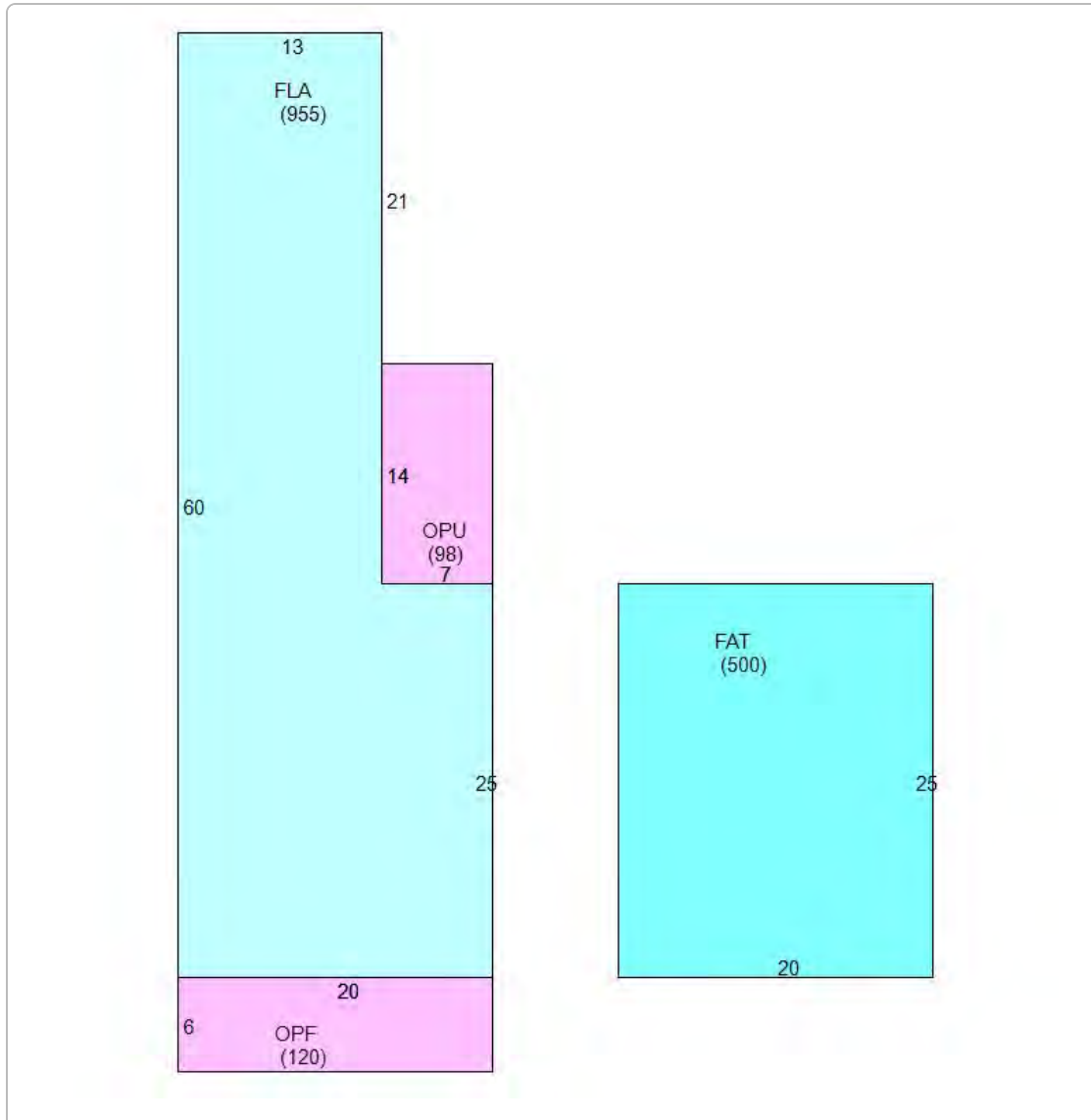

Photos



Map



TRIM Notice

[2020 TRIM Notice \(PDF\)](#)

2020 Notices Only

No data available for the following modules: Commercial Buildings, Mobile Home Buildings, Exemptions.

The Monroe County Property Appraiser's office maintains data on property within the County solely for the purpose of fulfilling its responsibility to secure a just valuation for ad valorem tax purposes of all property within the County. The Monroe County Property Appraiser's office cannot guarantee its accuracy for any other purpose. Likewise, data provided regarding one tax year may not be applicable in prior or subsequent years. By requesting such data, you hereby understand and agree that the [User Privacy Policy](#) and [GDPR Privacy Notice](#)

Developed by
 Schneider
 GEOSPATIAL

Last Data Upload: [7/21/2021, 2:36:52 AM](#)

Version 2.3.134