



---

## Historic Architectural Review Commission Staff Report for Item 3

To: Chairman Bryan Green and Historic Architectural Review  
Commission Members

From: Enid Torregrosa-Silva, MSHP  
Historic Preservation Planner

Meeting Date: June 29, 2021

Applicant: Casebolt Construction

Application Number: H2021-0024

Address: 1118 Whitehead Street

### **Description of Work:**

Reconstruction of front porch and renovations to house. Replace side and rear lower decks.

### **Site Facts:**

The building under review is a frame vernacular house listed as a contributing resource to the historic district. The one-story house was built circa 1912. A rear addition with a roof deck and the front porch are the only alterations to the building form. From the circa 1965 there is evidence that original wooden posts and deck of the front porch were no longer in existence as well as the original windows and front door. Currently the house has T1-11 wood panels used as siding on both sides and rear elevations. Current windows are not historic, and fenestrations have been altered to accommodate transoms. The house has metal shingles on its main roof and metal v-crimp covers the front porch roof.

### **Guidelines Cited on Review:**

- Building exteriors- wood (page 24), specifically preamble paragraph and guideline 1.
- Roofing (page 26), specifically guidelines 1 and 4.
- Entrances, porches and doors (pages 32-33), specifically 3, 4, 5, and 7.

### **Staff Analysis:**

The Certificate of Appropriateness under review is for the removal of the existing non-historic front porch and its replacement with a three-bay wood porch and deck covered with a hip roof. The plan proposes the new roof to be covered with metal shingles. Due to the proximity of the building with the front property line the plan includes two steps on the north side of the porch for access. No changes to existing doors or windows on the front façade are proposed.

Plan includes the removal of T1-11 siding and its replacement with wood lap siding. In addition, the plans include the repair of structural components of existing ground decks and the re use of board decks. Although the plans depict the replacement of railings at the rear roof deck this will not be under review as permits were not found for its approval.

### **Consistency with Cited Guidelines:**

It is staff's opinion that the proposed plans are consistent with cited regulations. The new front porch will be a much appropriate design than the current non-historic porch. The replacement of T1-11 will also be a positive improvement to this historic house.

# APPLICATION

# HARC MAJOR PROJECTS CERTIFICATE OF APPROPRIATENESS

\$420 NON-REFUNDABLE BASE APPLICATION FEE - OTHER FEES MAY BE APPLICABLE Rev 12/14/2020ET



City of Key West

1300 WHITE STREET  
KEY WEST, FLORIDA 33040

HARC COA # 2021-0024	REVISION #	INITIAL & DATE
FLOOD ZONE	ZONING DISTRICT	BLDG PERMIT #

**A PRE-APPLICATION MEETING WITH HARC STAFF IS REQUIRED PRIOR TO SUBMITTAL**

ADDRESS OF PROPOSED PROJECT:

1118 Whitehead Street

NAME ON DEED:

Douglas Snyder

PHONE NUMBER

305-923-9397

OWNER'S MAILING ADDRESS:

1118 Whitehead St.  
Key West, FL 33040

EMAIL

dougsnyder716@gmail.com

APPLICANT NAME:

Casebolt Construction

PHONE NUMBER

586-484-2172

APPLICANT'S ADDRESS:

1121 Whitehead St.  
Key West, FL 33040

EMAIL

caseboltconstructionkw@gmail.com

APPLICANT'S SIGNATURE:

DATE

5/17/21

**ANY PERSON THAT MAKES CHANGES TO AN APPROVED CERTIFICATE OF APPROPRIATENESS MUST SUBMIT A NEW APPLICATION.**

FLORIDA STATUTE 837.06: WHOEVER KNOWINGLY MAKES A FALSE STATEMENT IN WRITING AND WITH THE INTENT TO MISLEAD A PUBLIC SERVANT IN THE PERFORMANCE OF HIS OR HER OFFICIAL DUTY SHALL BE GUILTY OF A MISDEMEANOR OF THE SECOND DEGREE PUNISHABLE PER SECTION 775.082 OR 775.083. THE APPLICANT FURTHER HEREBY ACKNOWLEDGES THAT THE SCOPE OF WORK AS DESCRIBED IN THE APPLICATION SHALL BE THE SCOPE OF WORK THAT IS CONTEMPLATED BY THE APPLICANT AND THE CITY. THE APPLICANT FURTHER STIPULATES THAT SHOULD FURTHER ACTION BE TAKEN BY THE CITY FOR EXCEEDING THE SCOPE OF THE DESCRIPTION OF WORK, AS DESCRIBED HEREIN, AND IF THERE IS CONFLICTING INFORMATION BETWEEN THE DESCRIPTION OF WORK AND THE SUBMITTED PLANS, THE AFOREMENTIONED DESCRIPTION OF WORK SHALL BE CONTROLLING.

PROJECT INCLUDES: REPLACEMENT OF WINDOWS  RELOCATION OF A STRUCTURE  ELEVATION OF A STRUCTURE

PROJECT INVOLVES A CONTRIBUTING STRUCTURE: YES  NO  INVOLVES A HISTORIC STRUCTURE: YES  NO

PROJECT INVOLVES A STRUCTURE THAT IS INDIVIDUALLY LISTED ON THE NATIONAL REGISTER: YES  NO

DETAILED PROJECT DESCRIPTION INCLUDING MATERIALS, HEIGHT, DIMENSIONS, SQUARE FOOTAGE, LOCATION, ETC.

GENERAL:

Demolition of front porch. Remove 1200SF T1-11 siding  
Replace 2 front doors + 1 rear window. Replace side  
+ rear lower deck. Upper deck to remain. Install  
new porch gutters with down spouts connected to house by 11 connected  
roofer.

MAIN BUILDING:

DEMOLITION (PLEASE FILL OUT AND ATTACH DEMOLITION APPENDIX):







# HARC CERTIFICATE OF APPROPRIATENESS: DEMOLITION APPENDIX



**City of Key West**

1300 White Street  
Key West, Florida 33040

HARC COA #	INITIAL & DATE
ZONING DISTRICT	BLDG PERMIT #

ADDRESS OF PROPOSED PROJECT:

1118 Whitehead

PROPERTY OWNER'S NAME:

Douglas Snyder

APPLICANT NAME:

*I hereby certify I am the owner of record and that the work shall conform to all applicable laws of this jurisdiction. By receiving a Certificate of Appropriateness, I realize that this project will require a Building Permit approval **PRIOR** to proceeding with the work outlined above and that a final inspection is required under this application. I also understand that **any changes to an approved Certificate of Appropriateness must be submitted for review.***

PROPERTY OWNER'S SIGNATURE

*Douglas Snyder*

**DOUGLAS S SNYDER**

**5/17/21**

DATE AND PRINT NAME

**DETAILED PROJECT DESCRIPTION OF DEMOLITION**

Demolition of front porch to accommodate new traditional porch

**CRITERIA FOR DEMOLITION OF CONTRIBUTING OR HISTORIC STRUCTURES:**

**Before any Certificate of Appropriateness may be issued for a demolition request, the Historic Architectural Review Commission must find that the following requirements are met (please review and comment on each criterion that applies):**

(1) If the subject of the application is a contributing or historic building or structure, then it should not be demolished unless its condition is irrevocably compromised by extreme deterioration or it does not meet any of the following criteria:

(a) The existing condition of the building or structure is irrevocably compromised by extreme deterioration.

(2) Or explain how the building or structure meets the criteria below:

(a) Embodies no distinctive characteristics of a type, period, or method of construction of aesthetic or historic significance in the city and is not a significant and distinguishable building entity whose components may lack individual distinction.

Nothing in this application is intended to alter the authority of the Building Official to condemn for demolition dangerous buildings, as provided in Section 102-218 of the Land Development Regulations and Chapter 14 of the Code of Ordinances.

(b) Is not specifically associated with events that have made a significant contribution to local, state, or national history.

(c) Has no significant character, interest, or value as part of the development, heritage, or cultural characteristics of the city, state or nation, and is not associated with the life of a person significant in the past.

(d) Is not the site of a historic event with significant effect upon society.

(e) Does not exemplify the cultural, political, economic, social, or historic heritage of the city.

(f) Does not portray the environment in an era of history characterized by a distinctive architectural style.

(g) If a part of or related to a square, park, or other distinctive area, nevertheless should not be developed or preserved according to a plan based on the area's historic, cultural, natural, or architectural motif.

(h) Does not have a unique location or singular physical characteristic which represents an established and familiar visual feature of its neighborhood or of the city, and does not exemplify the best remaining architectural type in a neighborhood.



Nothing in this application is intended to alter the authority of the Building Official to condemn for demolition dangerous buildings, as provided in Section 102-218 of the Land Development Regulations and Chapter 14 of the Code of Ordinances.

(i) Has not yielded, and is not likely to yield, information important in history,
<i>not applicable</i>

<b>* CRITERIA FOR DEMOLITION OF NON-CONTRIBUTING OR NON-HISTORIC STRUCTURES:</b>
<b>The following criteria will also be reviewed by the Historic Architectural Review Commission for proposed demolitions. The Commission shall not issue a Certificate of Appropriateness that would result in the following conditions (please review and comment on each criterion that applies):</b>
(1) Removing buildings or structure that are important in defining the overall historic character of a district or neighborhood so that the character is diminished.
<i>not applicable</i>
(2) Removing historic buildings or structures and thus destroying the historic relationship between buildings or structures and open space.
<i>not applicable</i>
(3) Removing an historic building or structure in a complex; or removing a building façade; or removing a significant later addition that is important in defining the historic character of a site or the surrounding district or neighborhood.
<i>Demolition of front porch to be replaced with more traditional porch</i>
(4) Removing buildings or structures that would otherwise qualify as contributing.
<i>not applicable</i>

# SANBORN MAPS

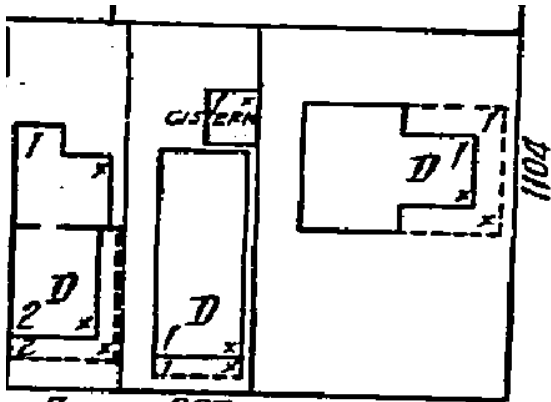

337  
327  
**AMELIA**

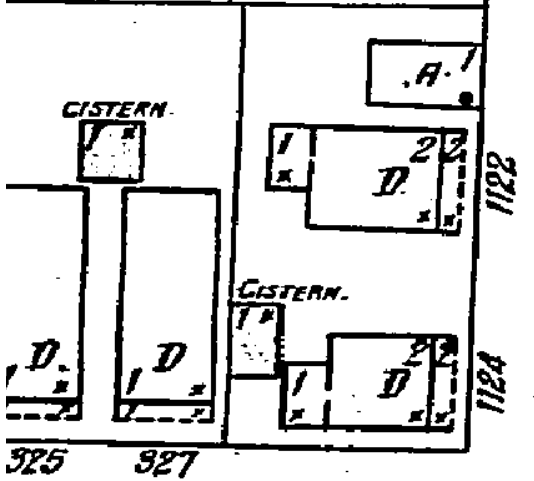
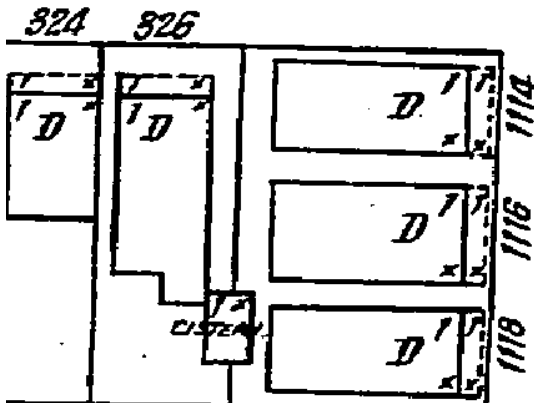
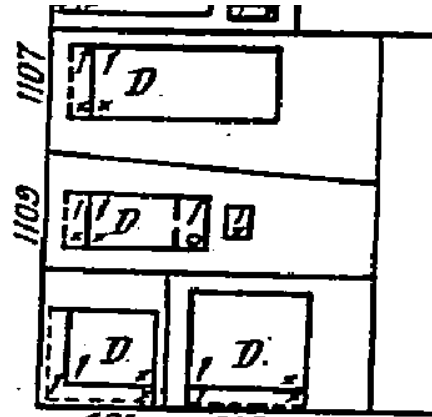

**HARINE**



**WHITEHEAD** ←

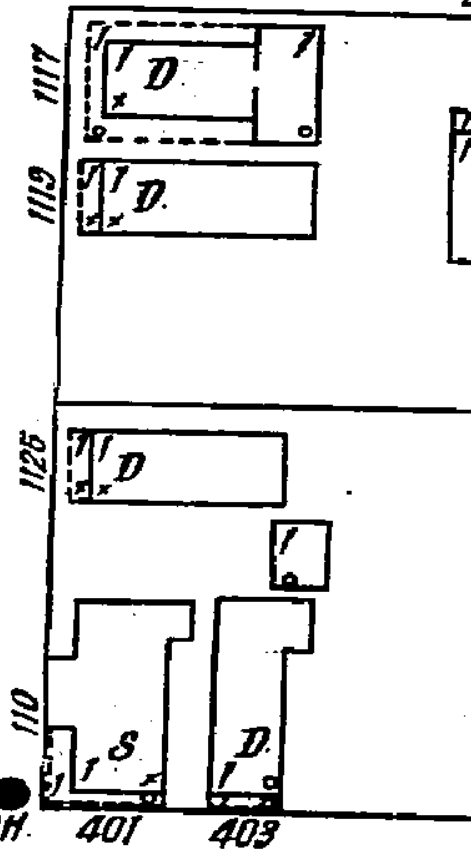

1926 Sanborn Map



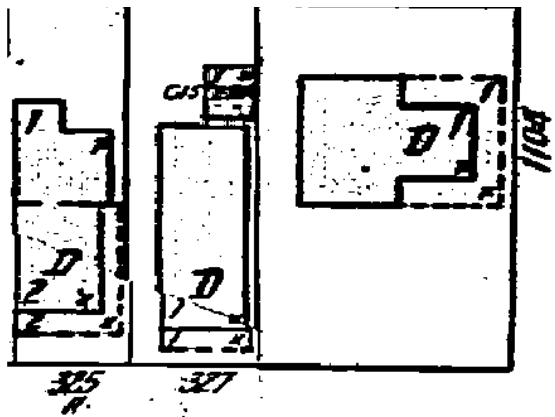

AMELIA

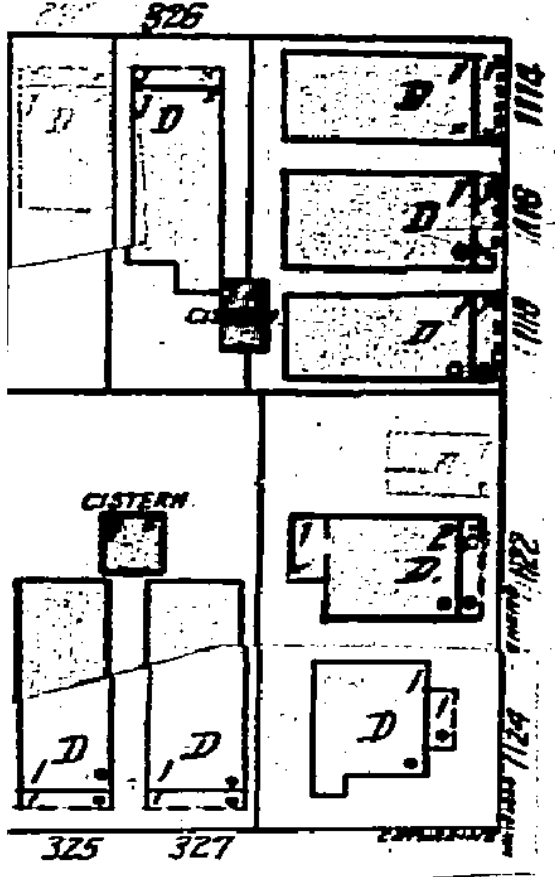
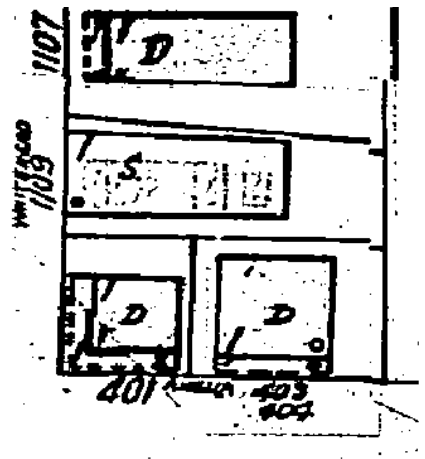

WHITEHEAD

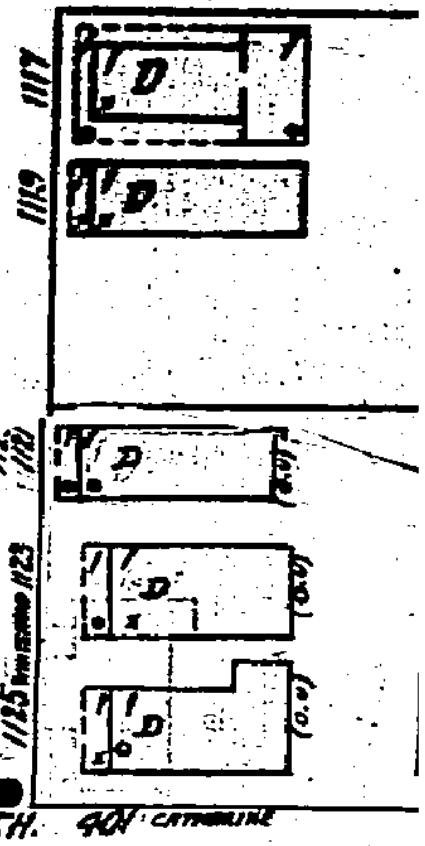

THARINE

1948 Sanborn Map

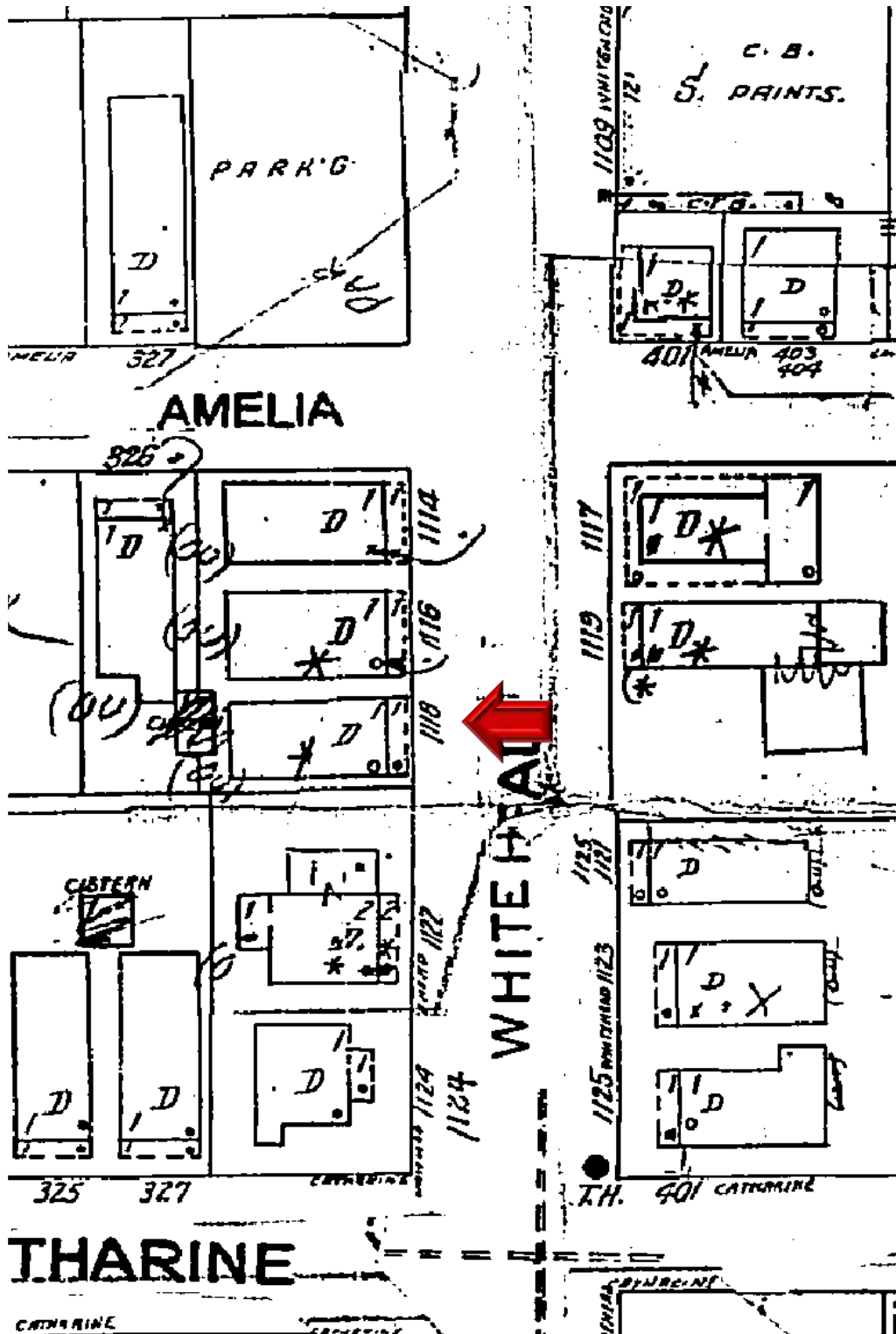

1962 Sanborn Map

# PROJECT PHOTOS







HARD WASTE

1118



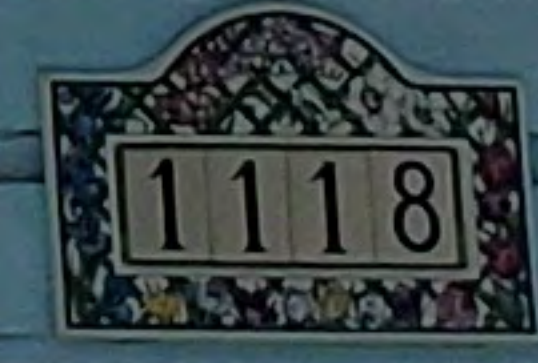











TELEPHONE NETWORK INTERFACE

CUSTOMER ACCESS

BELLSOUTH

SKTWD TECHNOLOGY

664 FEET 05/05/13









# SURVEY



# WHITEHEAD STREET (50' R/W)

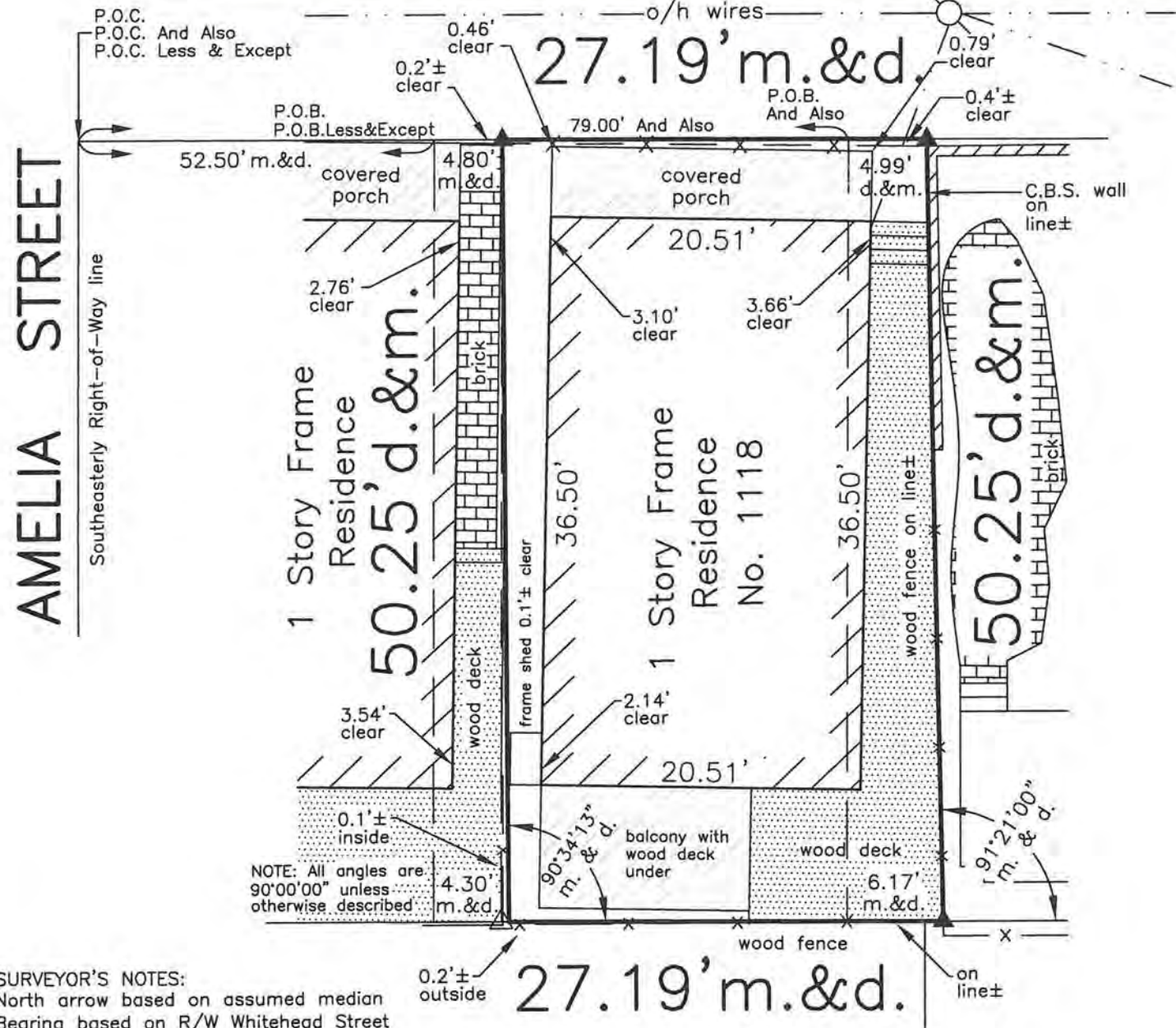
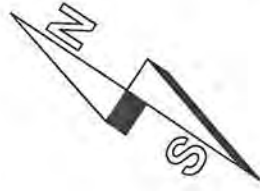

NOTE: All angles are 90°00'00" unless otherwise described.

**SURVEYOR'S NOTES:**  
 North arrow based on assumed median Bearing based on R/W Whitehead Street  
 3.4 denotes existing elevation  
 Elevations based on N.G.V.D. 1929 Datum  
 Bench Mark No.: D-121 Elevation: 3.914'  
 Title search has not been performed on said or surrounding properties  
 Field Work performed on: 4/30/15

**MONUMENTATION:**  
 ⊙ = Set 1/2" Iron Pipe, P.L.S. No. 2749  
 ● = Found 1/2" Iron Pipe  
 ▲ = Found P.K. Nail  
 △ = Set P.K. Nail, P.L.S. No. 2749

**LEGAL DESCRIPTION:**

On the Island of Key West and known on William A. Whitehead's map delineated in February, A.D. 1829 as part of Lot Seventeen (17), Square Two (2), Tract Ten (10) and described as follows: Beginning at a point on the Southwest side of Whitehead Street distance Fifty-two (52) feet and Six (6) inches Southeasterly from the corner of Amelia and Whitehead Streets and running thence in a Southeasterly direction Twenty-six (26) feet and Six (6) inches; thence at right angles in a Southwesterly direction Fifty (50) feet and Three (3) inches; thence at right angles in a Northwesterly direction Twenty-six (26) feet and Six (6) inches; thence at right angles in a Northeasterly direction Fifty (50) feet and Three (3) inches to the Point of Beginning.

**AND ALSO:**

A parcel of land on the Island of Key West and known on William A. Whitehead's map delineated in February, A.D. 1829 as part of Lot Seventeen (17), Square Two (2), Tract Ten (10) according to the Plat thereof, as recorded in Plat Book 1 at page 40 of the Public Records of Monroe County, Florida said parcel being more particularly described by metes and bounds as follows: Commence at the intersection of the Southeasterly Right-of-Way line Amelia Street with the Southwesterly Right-of-Way line of Whitehead Street and run thence Southeasterly along the Southwesterly Right-of-Way line of the said Whitehead Street for a distance of 79 feet to the Point of Beginning; thence run Southwesterly and at right angles for a distance of 50.25 feet; thence run Southeasterly and at right angles for a distance of 6.17 feet to the Northwesterly face of an existing concrete block wall; thence run Northeasterly with a deflection angle of 90°21'00" to the left and along said wall for a distance of 50.25 feet to the Southwesterly Right-of-Way line of the said Whitehead Street; thence Northwesterly and along the said Whitehead Street for a distance of 4.99 feet back to the Point of Beginning.

**LESS AND EXCEPT:**

A parcel of land on the Island of Key West and known as part of Lot Seventeen (17), Square Two (2), Tract Ten (10) according to the Plat thereof, as recorded in Plat Book 1 at page 40 of the Public Records of Monroe County, Florida said parcel being more particularly described by metes and bounds as follows: Commence at the intersection of the Southeasterly Right-of-Way line Amelia Street with the Southwesterly Right-of-Way line of Whitehead Street and run thence Southeasterly along the Southwesterly Right-of-Way line of the said Whitehead Street for a distance of 52.5 feet to the Point of Beginning; thence run Southwesterly and at right angles for a distance of 50.25 feet; thence Southeasterly and at right angles for a distance of 4.8 feet to an existing meandering wire fence; thence Northeasterly with a deflection angle of 90°34'13" to the left and along the said wire fence for a distance of 50.25 feet to the Southwesterly Right-of-Way line of the said Whitehead Street; thence Northwesterly and along the said Whitehead Street for a distance of 4.3 feet back to the Point of Beginning.

**CERTIFICATION:**

I HEREBY CERTIFY that the attached **BOUNDARY SURVEY** is true and correct to the best of my knowledge and belief; that it meets the minimum technical standards adopted by the Florida Board of Land Surveyors, Chapter 5J-17, Florida Statute Section 472.027, and the American Land Title Association, and that there are no visible encroachments unless shown hereon.

FREDERICK H. HILDEBRANDT  
 Professional Land Surveyor & Mapper No. 2749  
 Professional Engineer No. 36810  
 State of Florida

NOT VALID UNLESS EMBOSSED WITH RAISED SEAL & SIGNATURE

Douglas Snyder and Brittany P. Snyder 1118 Whitehead Street, Key West, Florida 33042			
BOUNDARY SURVEY		Dwn No.: 15-224	
Scale: 1"=10'	Ref. file 218-56	Flood panel No. 1516 K	Dwn. By: F.H.H.
Date: 6/29/15		Flood Zone: AE	Flood Elev. 6'
REVISIONS AND/OR ADDITIONS			
fred/dwg/kw/block102/1118whitehead			

**ISLAND SURVEYING INC.**  
 ENGINEERS PLANNERS SURVEYORS

3152 Northside Drive  
 Suite 201  
 Key West, Fl. 33040

(305) 293-0466  
 Fax: (305) 293-0237  
 fhildeb1@bellsouth.net  
 L.B. No. 7700

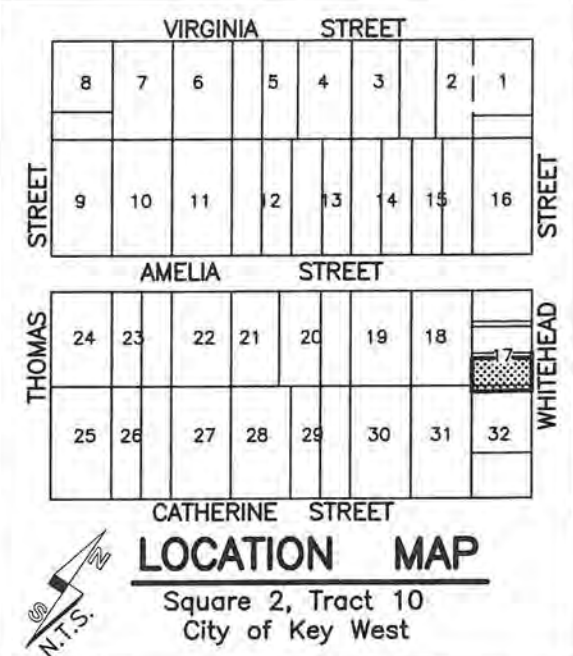

**LEGEND**

A/C	Air Conditioner
BAL	Balcony
BM	Bench Mark
CB	Catch Basin
CL	Center Line
CO	Clean Out
CONC	Concrete
C.B.S.	Concrete Block Stucco
CU	Concrete Utility Pole
COV'D	Covered
D	Deed
ELEV	Elevation
F.FL.	Finished Floor Elevation
FD	Found
FIB	Found Iron Bar
FIP	Found Iron Pipe
INV	Invert
IRR	Irregular
LB	Licensed Business Number
M	Measured
N.T.S.	Not To Scale
O.R.	Official Records
OH	Over Head
P	Plat
PB	Plat Book
P.O.B.	Point Of Beginning
P.O.C.	Point Of Commence
R/W	Right Of Way
SIB	Set Iron Bar
SIP	Set Iron Pipe
SPK	Set Nail And Disc
STY	Story
UP	Utility Pole
WM	Water Meter
WV	Water Valve



# PROPOSED DESIGN



# SNYDER RESIDENCE INTERIOR / EXTERIOR RESIDENTIAL UPGRADES

1118 WHITEHEAD STREET KEY WEST, FLORIDA 33040



SITE LOCATION

AREA OF CONSTRUCTION



STREET VIEW (WHITEHEAD STREET)

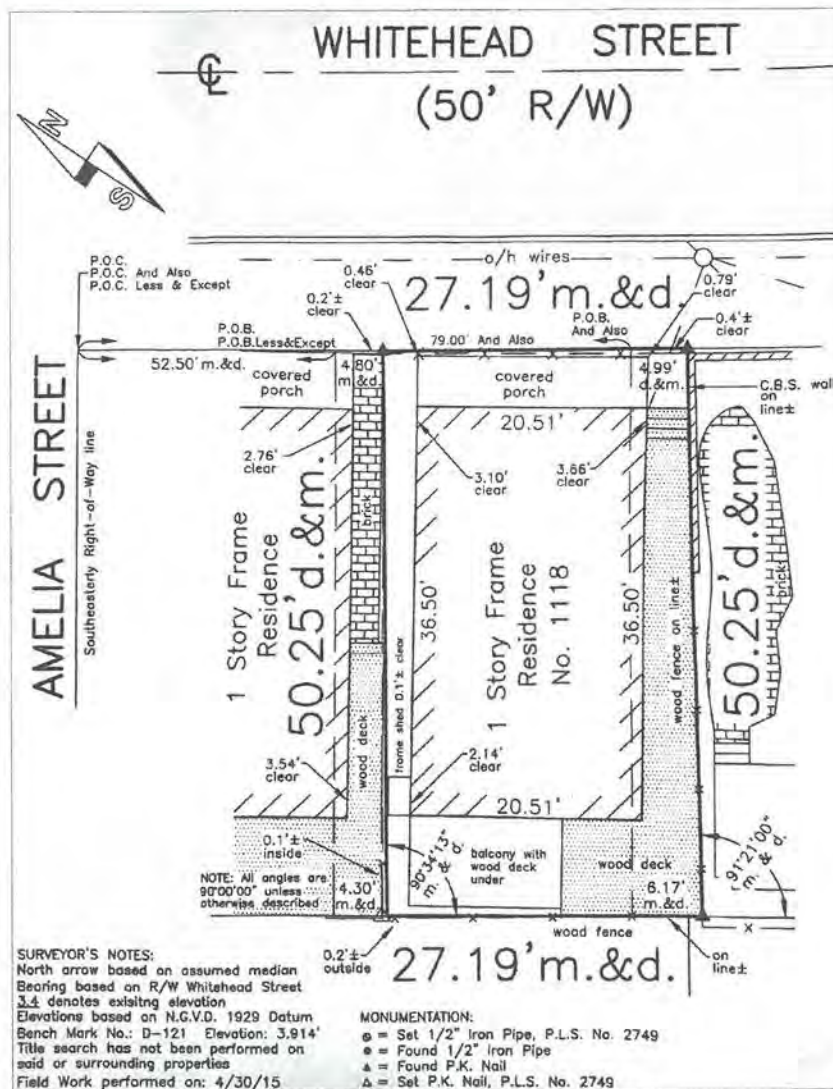

SURVEY

**GENERAL NOTES**

All work shall comply with the 2017 6th edition Florida Building Code, latest edition, and all applicable laws, codes and ordinances of the city, county, and the state of Florida. In the city of Key West, applicable Codes forming the basis of this design and compliance requirements for the contractor include:

BUILDING: Florida Building Code, 2017  
ELECTRICAL: National Electrical Code, 2017  
PLUMBING: Florida Building Code (Plumbing), 2017  
MECHANICAL: Florida Building Code (Mech.), 2017  
GAS: LP Gas Code, 2017 edition (NFPA 58)

This project is designed in accordance with A.S.C.E. 7-16 to resist wind loads of 180 mph (gusts) (Exposure C)  
This project is designed in accordance with A.S.C.E. 24-14 for flood resistant design.  
Concrete: Building code requirements for concrete, American concrete institute, ACI 318-11.

**TREE PROTECTION PLAN**

All existing trees to remain UNO.  
Provide 3' fenced border around native trees within the construction area.  
If landscape area is to be removed or tree is damaged, notify architect.

**SITE DATA**

RE NO.	1118 WHITEHEAD ST. FLOOD: AE-6 ZONE: HMDR		
	PROPOSED	EXISTING	ALLOWED
00026180-000000			
SETBACKS:			
FRONT	0.5'	0.5'	10'
SIDE	1.5'	1.5'	5'
SIDE	3.7'	3.7'	5'
REAR	0.5'	0.5'	15'
LOT SIZE	1,381.5 S.F.	1,381.5 S.F.	4,000 S.F. MIN.
BUILDING COVERAGE	952 S.F. 69%	952 S.F. 69%	690.75 S.F. 50%
BUILDING HEIGHT	18.3'	18.3'	30'
IMPERVIOUS AREA	1,028 S.F. 74%	1,028 S.F. 74%	828 S.F. 60%
OPEN SPACE	369 S.F. 27%	184 S.F. 13%	483.5 S.F. 35%

**SHEET INDEX**

SHT NO.	DESCRIPTION
C	1 COVER - LOCATION, SITE PLAN, SURVEY, GENERAL NOTES
A-1	2 EXISTING SITE PLAN / FLOOR PLAN / DEMO PLAN, NOTES
A-2	3 EXISTING NORTH & WEST ELEVATIONS / DEMO PLAN
A-3	4 EXISTING SOUTH & EAST ELEVATIONS / DEMO PLAN
A-4	5 PROPOSED SITE PLAN / FLOOR PLAN, NOTES
A-5	6 PROPOSED FLOOR PLAN, NOTES
A-6	7 PROPOSED LOFT PLAN, NOTES
A-7	8 PROPOSED NORTH & WEST ELEVATIONS
A-8	9 PROPOSED SOUTH & EAST ELEVATIONS
S-1	10 PROPOSED LOFT PLAN, NOTES
S-2	11 SECTION, DETAILS, NOTES
S-3	12 SECTION, DETAILS, NOTES
E-1	13 ELECTRICAL PLAN, LIFE SAFETY, NOTES, SCHEDULES
P-1	14 PLUMBING PLAN, HVAC PLAN, NOTES, SCHEDULES

Basic Building Structural Information			
Floor and Roof Live Loads			
Attics:	20 psf w/ storage, 10 psf w/o storage		
Habitable Attics, Bedroom:	30 psf		
All Other Rooms:	40 psf		
Garage:	40 psf		
Roofs:	20 psf		
Wind Design Data			
Ultimate Wind Speed:	180 mph	Nominal Wind Speed:	139 mph
Risk Category:	II	Wind Exposure:	C
Enclosure Classification:	Enclosed	End Zone Width:	4.00 ft.
Internal Pressure Coefficient:	0.18 +/-		
Components and Cladding Design Pressures	Roof Zone 1:	+38.6 psf max.,	-42.1 psf min.
	Roof Zone 2:	+38.6 psf max.,	-49.2 psf min.
	Roof Zone 3:	+38.6 psf max.,	-49.2 psf min.
	Roof at Zone 2 Overhangs:	-71.4 psf min.	
	Roof at Zone 3 Overhangs:	-71.4 psf min.	
	Wall Zone 4:	+42.1 psf max.,	-45.6 psf min.
Wall Zone 5:	+42.1 psf max.,	-56.3 psf min.	
The Nominal Wind Speed was used to determine the above Component and Cladding Design Pressures.			
All exterior glazed openings shall be protected from wind-borne debris as per Section 1609.1.2 of the code.			
The site of this building is not subject to special topographic wind effects as per Section 1609.1.1.1 of the code.			

SNYDER RESIDENCE  
RESIDENTIAL UPGRADES  
1118 WHITEHEAD STREET KEY WEST, FLORIDA 33040

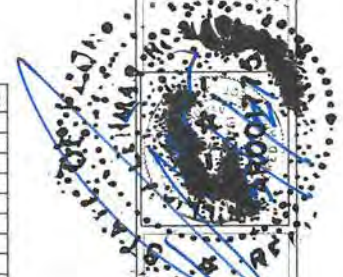

WILLIAM ROWAN N  
ARCHITECTURE  
KEY WEST, FLORIDA  
FLORIDA LICENSE AB00175  
151 PEACOCK LANE  
303.263.3784

PROJECT NO.

DATE 2-20-2020

C  
1 OF 14

COVER



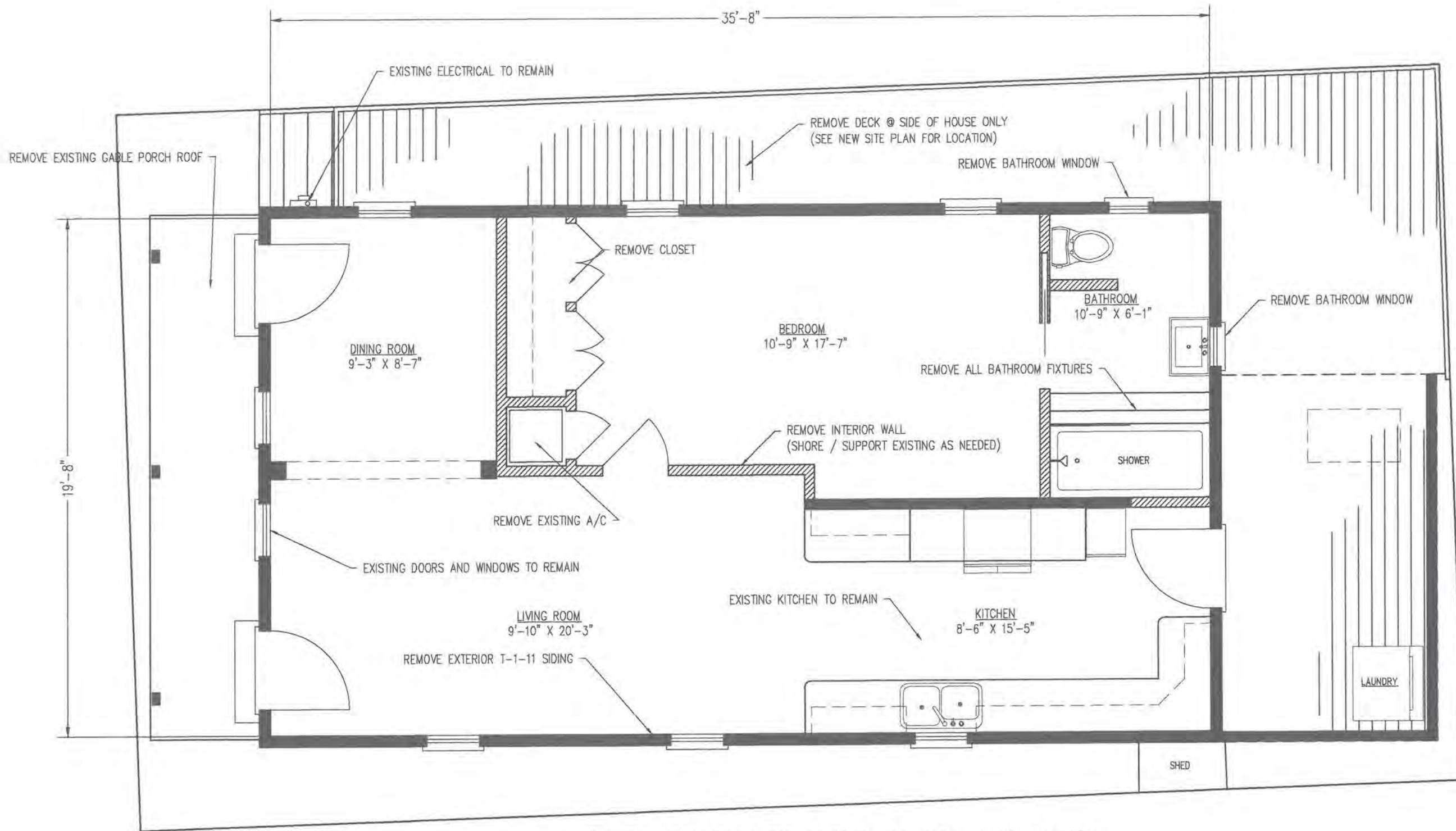

N
**SITE / FLOOR PLAN / DEMO**  
 1/4" = 1'-0" EXISTING

**DEMOLITION NOTES**

1. If Demolition commences prior to permit, GC shall obtain demo permits.
2. Furnish all labor and materials as required to complete demolition and removal of all items as indicated.
3. Provide strict control of job cleaning and prevent dust and debris from emanating from demolition area. Keep area clean.
4. If any questions arise as to the removal of any material, clarify the point in question with the architect or owner before proceeding.
5. At completion of demolition work the construction areas shall be left in "broom clean" condition. All debris and misc. material shall be moved to waste area provided by the contractor.
6. Debris removal must be performed in accordance with owner and building management requirements and procedures.
7. Carefully remove all existing light fixtures and lenses (where demolition is note) and store for future use. Before indicated reinstallation, inspect each fixture and repair or replace parts as required. All relocated fixtures shall be in full operating order. All tubes and/or ballasts not reused shall be disposed of in a proper manner.
8. Contractor shall be responsible for patching and/or repairing any damage caused by him or his subcontractors to existing construction. Refinish to match existing adjacent finish or as noted herein.
9. Existing smoke detectors to remain as needed.
10. Removal of any equipment, cabling, switches, and conduit pertaining to data/communications and telephone shall be verified with telephone companies or service owner data/communications representative as required to prevent new construction delays.
11. Demolition is not necessarily limited to what is shown on the drawings. The intent is to indicate the general scope of demolition required to complete the work in accordance with the contract drawings.
12. Contractor to coordinate with owner for reuse of existing millwork.
13. Existing elevated slab, piers, beams, cbs walls, and roof system to remain.
14. Install temporary supports below rafters and ceiling joists during demo and construction as needed.

**SNYDER RESIDENCE**  
**RESIDENTIAL UPGRADES**  
 1118 WHITEHEAD STREET KEY WEST, FLORIDA 33040

**WILLIAM ROWA**  
 ARCHITECTURE  
KEY WEST FLORIDA  
 FLORIDA LICENSE AR-011711

**PROJECT NO.**  
 \_\_\_\_\_  
**DATE** 2-20-2020  
A1  
 2 OF 14





DEMOLITION NOTES

1. If Demolition commences prior to permit, GC shall obtain demo permits.
2. Furnish all labor and materials as required to complete demolition and removal of all items as indicated.
3. Provide strict control of job cleaning and prevent dust and debris from emanating from demolition area. Keep area clean.
4. If any questions arise as to the removal of any material, clarify the point in question with the architect or owner before proceeding.
5. At completion of demolition work the construction areas shall be left in "broom clean" condition. All debris and misc. material shall be moved to waste area provided by the contractor.
6. Debris removal must be performed in accordance with owner and building management requirements and procedures.
7. Carefully remove all existing light fixtures and lenses (where demolition is note) and store for future use. Before indicated reinstallation, inspect each fixture and repair or replace parts as required. All relocated fixtures shall be in full operating order. All tubes and/or ballasts not reused shall be disposed of in a proper manner.
8. Contractor shall be responsible for patching and/or repairing any damage caused by him or his subcontractors to existing construction. Refinish to match existing adjacent finish or as noted herein.
9. Existing smoke detectors to remain as needed.
10. Removal of any equipment, cabling, switches, and conduit pertaining to data/communications and telephone shall be verified with telephone companies or service owner data/communications representative as required to prevent new construction delays.
11. Demolition is not necessarily limited to what is shown on the drawings. The intent is to indicate the general scope of demolition required to complete the work in accordance with the contract drawings.
12. Contractor to coordinate with owner for reuse of existing millwork.
13. Existing elevated slab, piers, beams, cbs walls, and roof system to remain.
14. Install temporary supports below rafters and cieling joists during demo and construction as needed.

**NORTH ELEVATION**

1/4" = 1'-0"

EXISTING

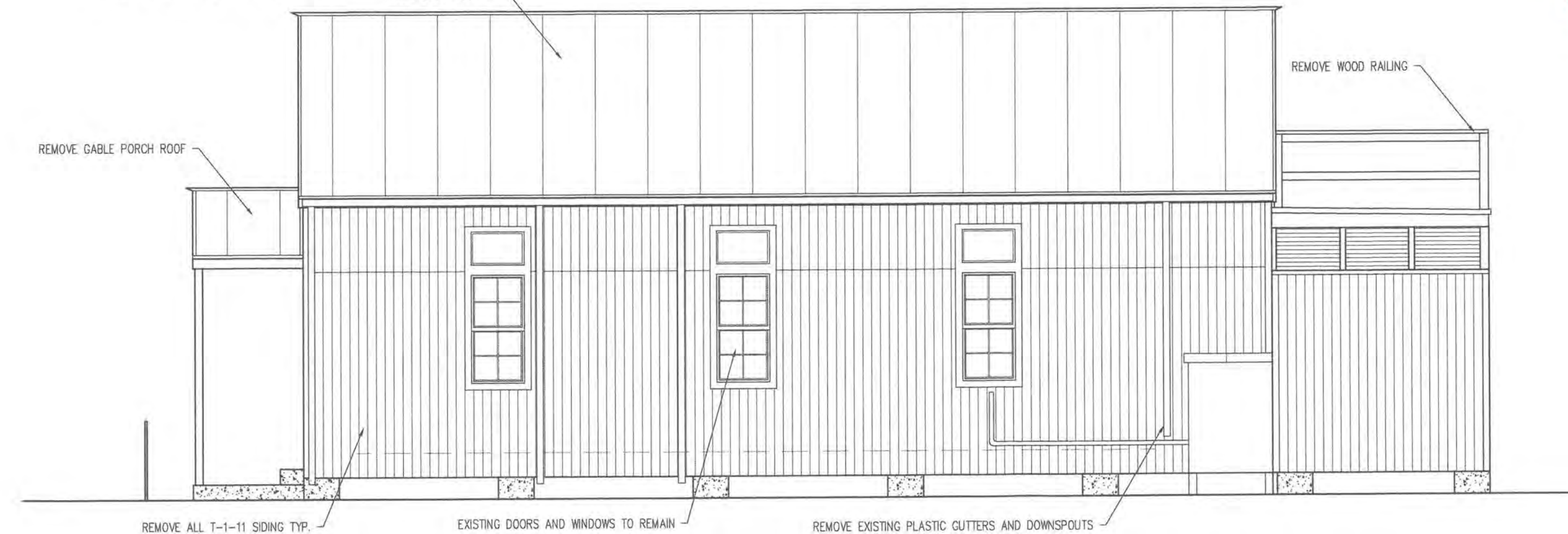

**WEST ELEVATION**

1/4" = 1'-0"

EXISTING

ELEVATIONS EXISTING / DEMO

SNYDER RESIDENCE  
RESIDENTIAL UPGRADES

1118 WHITEHEAD STREET KEY WEST, FLORIDA 33040

WILLIAM ROWA  
ARCHITECTURE

KEY WEST, FLORIDA  
FLORIDA LICENSE AR-0017741

PROJECT NO.

DATE 2-20-2020

A2

3 OF 14



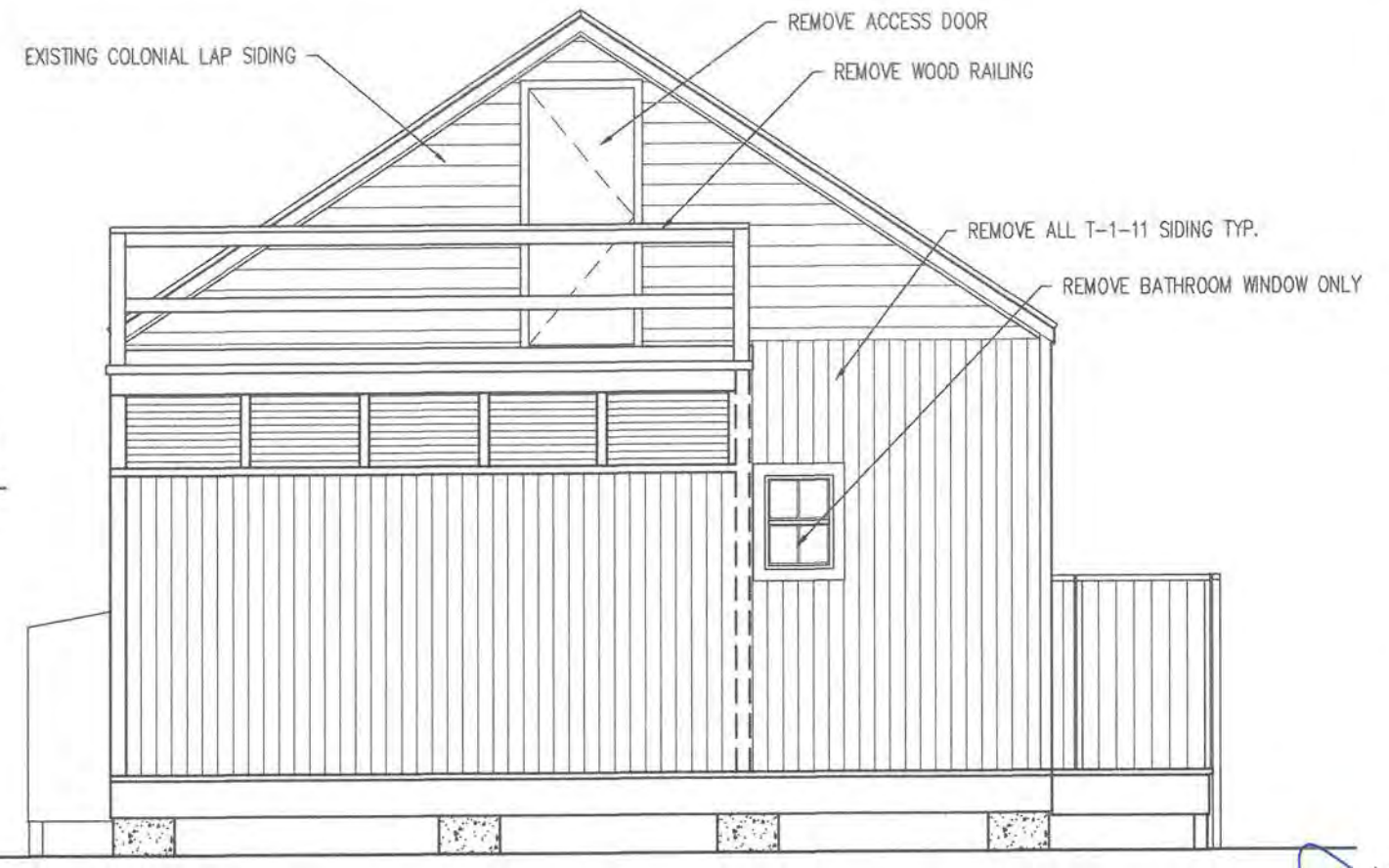

**SOUTH ELEVATION**  
 1/4" = 1'-0" EXISTING

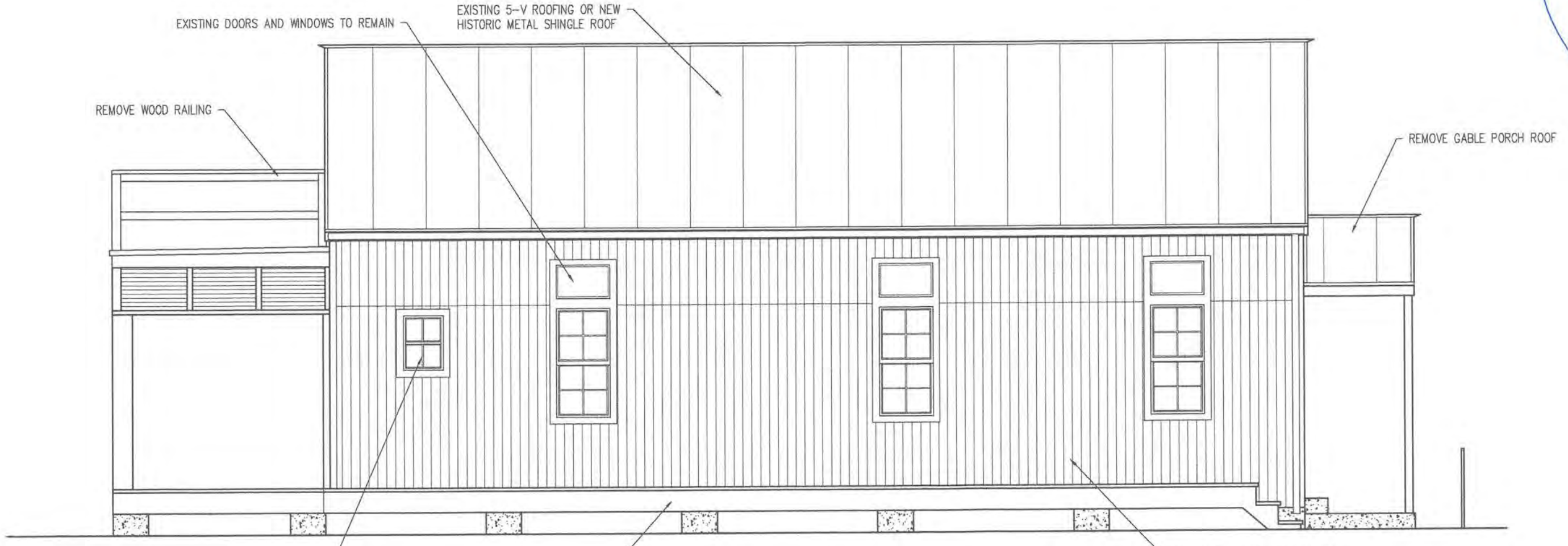

**EAST ELEVATION**  
 1/4" = 1'-0" EXISTING

ELEVATIONS EXISTING / DEMO

SNYDER RESIDENCE  
 RESIDENTIAL UPGRADES  
 4118 WHITEHEAD STREET KEY WEST, FLORIDA 33040  
**WILLIAM ROWAN NOLAN**  
 ARCHITECTURE  
 KEY WEST, FLORIDA  
 FLORIDA LICENSE ARCHITECT

PROJECT NO.  
 DATE 2-20-2020  
**A3**  
 4 OF 14



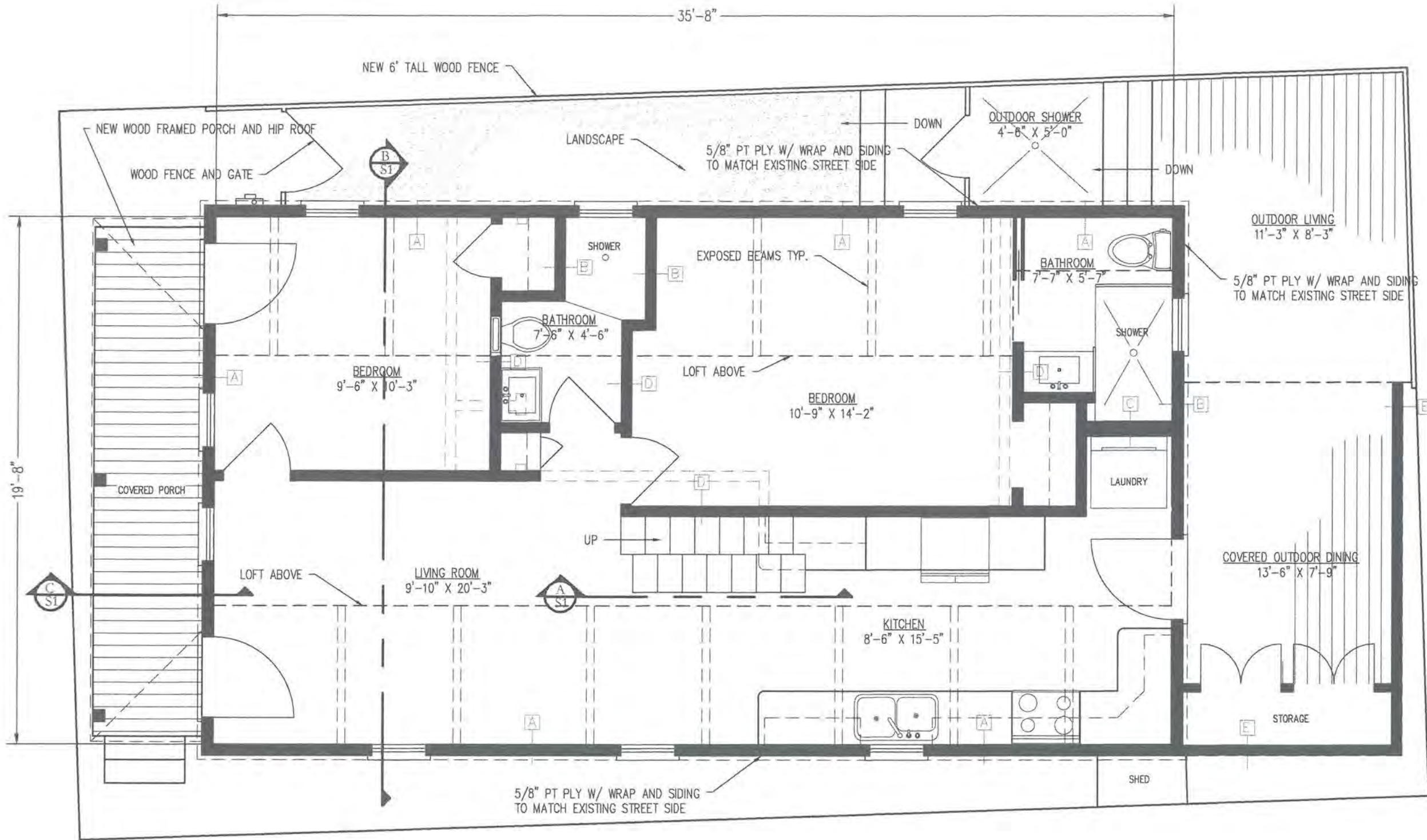

WALL SCHEDULE

MK.	WALL TYPE / DETAILS	NOTES
A	EXISTING HISTORIC ENVELOPE * INSTALL NEW 5/8" PT PLY, HOUSE WRAP, PT LAP SIDING W/ PT TRIM, PRIME & PAINT TYP. *	REPAIR AS NEEDED
B	NEW 2X4 STUD WALL, 1/2" GYPSUM BOARD ONE SIDE, GREEN BOARD ON WET WALL	STUDS PLACED 16" O.C.
C	NEW 2X6 WALL (VERIFY PLUMB, REQ.), NEW GREEN BOARD AT WET LOCATIONS	STUDS PLACED 16" O.C.
D	NEW 2X4 STUD WALL, 1/2" GYPSUM BOARD EA. SIDE, FINISH TO MATCH EXISTING	STUDS PLACED 16" O.C.
E	EXISTING EXTERIOR WALL, REPAIR AS NEEDED	STUDS PLACED 16" O.C.

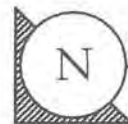

SITE / FLOOR PLAN

1/4" = 1'-0" PROPOSED

SNYDER RESIDENCE  
RESIDENTIAL UPGRADES

WILLIAM ROWAN  
ARCHITECTURE  
KEY WEST, FLORIDA  
FLORIDA LICENSE AR-0017  
331 PEACOCK LANE  
305 296 5794

PROJECT NO.

DATE 2-20-2020

A4

5 OF 14

SITE / FLOOR PLAN PROPOSED



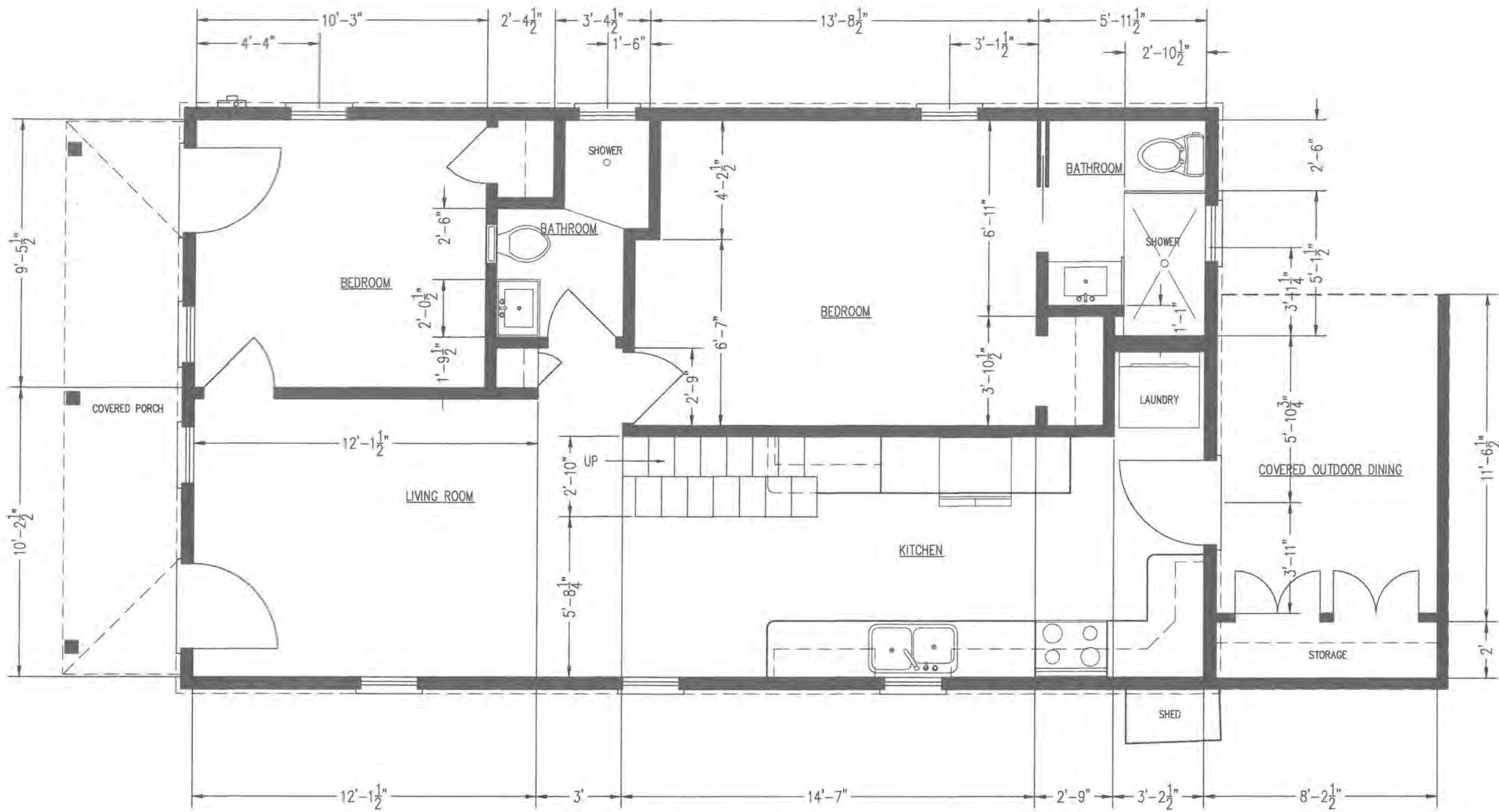

N
**FLOOR PLAN**  
 1/4" = 1'-0"      PROPOSED

**WOOD FRAMING NOTES:**

LUMBER AND ITS FASTENINGS SHALL CONFORM TO THE NATIONAL DESIGN SPECIFICATIONS FOR WOOD CONSTRUCTION, LATEST EDITION. ALL WOOD FRAMING SIZES, FRAMING, FASTENING REQUIREMENTS, ANCHORAGES, FIRESTOPS, AND CONNECTORS NOT SHOWN ON THESE PLANS TO BE PER THE SPECIFIED BUILDING CODE.

ALL STRUCTURAL LUMBER TO BE STRUCTURAL GRADE NO. 2 SPRUCE-PINE-FIR WITH A MAXIMUM MOISTURE CONTENT OF 19%. ALL LUMBER TO BE STAMPED WITH THE GRADE MARK OF AN APPROVED GRADING AGENCY.

ALL WOOD FRAMING EXPOSED TO WEATHER SHALL BE PRESSURE TREATED.

ALL FASTENERS IN CONTACT WITH PRESSURE-TREATED WOOD TO BE HOT DIP GALVANIZED PER THE MANUFACTURERS RECOMMENDATIONS AND THE APPLICABLE BUILDING CODE.

THE FRAMING LAYOUTS DEPICTED ON THE PLANS ARE TO ILLUSTRATE GENERAL FRAMING CONDITIONS BUT DO NOT NECESSARILY DEPICT THE CORRECT QUANTITIES OR CONNECTIONS REQUIRED.

FASTENING FOR ALL STRUCTURAL MEMBERS NOT SPECIFICALLY SHOWN IN THE PLANS TO BE PER THE FASTENING SCHEDULE OF THE APPLICABLE BUILDING CODE.

BOLTS SHALL CONFORM TO ASTM 307, ANSI D18.2.1. SCREWS AND LAG SCREWS SHALL CONFORM TO ANSI B18.2.1, AND ANSI B18.6.1, RESPECTIVELY. BOLTS THROUGH WOOD SHALL BE FITTED WITH STANDARD WASHERS.

BOLT HOLES SHALL BE AT LEAST A MINIMUM DIAMETER OF 1/32" AND NO MORE THAN A MAXIMUM OF 1/16" LARGER THAN THE BOLT DIAMETER.

BOLT NUTS SHALL BE FINGER-TIGHT PLUS 1/3 TO 1/2 TURN WITH A HAND WRENCH, WITH CONSIDERATION GIVEN TO POSSIBLE FUTURE WOOD SHRINKAGE. CARE SHOULD BE TAKEN NOT TO OVER-TORQUE THE NUT. IMPACT WRENCHES SHOULD NOT BE USE AS THEY MAY PRELOAD THE CONNECTORS. BOLT NUTS SHALL BE PERIODICALLY RETIGHTENED.

UNLESS OTHERWISE NOTED, CONNECTORS SHALL BE INSTALLED WITH THE MAXIMUM NUMBER AND SIZE OF FASTENERS AS REQUIRED IN THE MANUFACTURER'S INSTALLATION INSTRUCTIONS.

THE NUMBER AND SIZE OF NAILS USED TO CONNECT WOOD MEMBERS SHALL BE ACCORDING TO THE APPLICABLE BUILDING CODE. REFER TO MANUFACTURER FOR NAILING REQUIREMENTS (TO ATTAIN MAXIMUM TABLE VALUES) FOR ALL WOOD-TO-WOOD MECHANICAL FASTENERS.

MULTIPLE STUDS SHALL BE GLUED AND NAILED TO 10d NAILS 24" O.C.

BRACING SHALL BE PROVIDED FOR ALL WALLS UNTIL SHEAR PANELS, FLOOR FRAMING, ROOF FRAMING, AND DECKING ARE INSTALLED.

CUTTING AND NOTCHING OF ALL LOAD BEARING STUDS SHALL BE LIMITED TO 25% OF THE STUD DEPTH.

ALL LOAD BEARING WALLS SHALL CONSIST OF A SINGLE STUD SILL PLATE AT THE BOTTOM AND A DOUBLE STUD TOP PLATE AT THE TOP. STUDS USED IN PLATES SHALL MATCH THE DIMENSIONS USED FOR STUDS WITHIN THE WALLS. STUD WALLS SHALL END WITH DOUBLE STUDS ON EACH END.

WALL OPENINGS LESS THAN AND INCLUDING 5'-0" WIDE ARE TO BE FRAMED WITH ONE KING STUD AND ONE JACK STUD ON EACH SIDE.

WALL OPENINGS GREATER THAN 5'-0" WIDE SHALL BE FRAMED WITH ONE KING STUD AND TWO JACK STUDS ON EACH SIDE.

ALL BEAMS AND JOISTS TO BE FRAMED FLUSH WITH SUPPORTING MEMBER TO BE SUPPORTED BY APPROVED HANGERS WITHIN ENCLOSED CONDITIONED SPACE.

DOUBLE JOISTS ARE TO BE PROVIDED BELOW PARTITION WALLS THAT RUN PARALLEL TO JOISTS AND SOLID BLOCKING THE DEPTH OF THE JOISTS SHALL BE PROVIDED BETWEEN JOISTS BELOW PARTITION WALLS THAT FRAME PERPENDICULAR TO JOISTS.

WHERE HEADERS FRAME INTO STUDS, DOUBLE STUDS SHALL BE PROVIDED.

FLOOR PLAN PROPOSED

**SNYDER RESIDENCE**  
**RESIDENTIAL UPGRADES**  
 1118 WHITEHEAD STREET KEY WEST, FLORIDA 33040

**WILLIAM ROWAN N**  
**ARCHITECTURE**  
KEY WEST FLORIDA  
 FLORIDA LICENSE AB400751  
 311 PACON LANE  
 305 265 5181

PROJECT NO. \_\_\_\_\_

DATE 2-20-2020

A5

6 OF 14



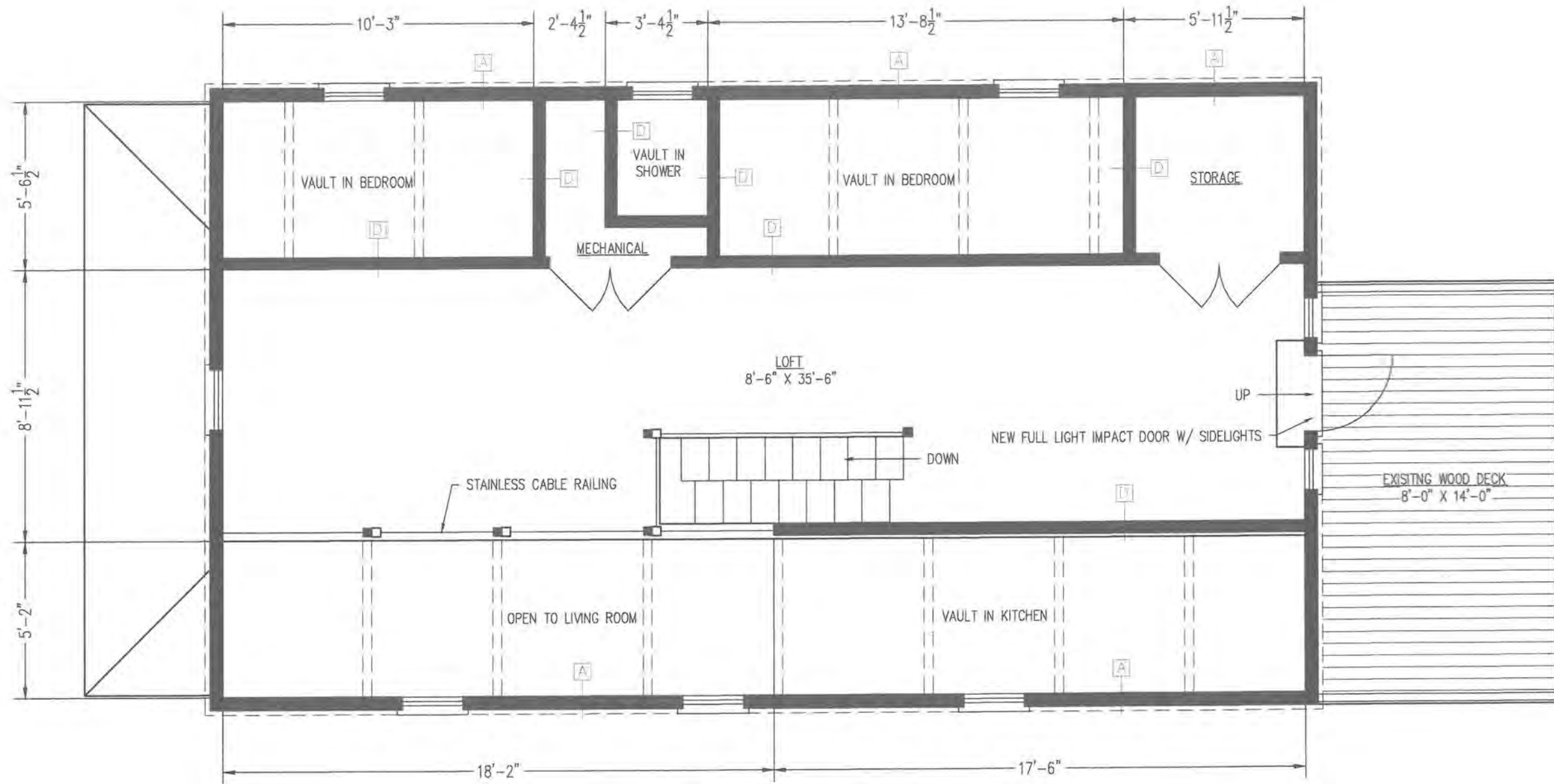

**LOFT PLAN**  
 1/4" = 1'-0"      PROPOSED

**CONSTRUCTION PLAN GENERAL NOTES**

1. Do not scale drawings, written dimensions govern. All partition locations shall be as shown on the partition plan. In case of conflict, verify with the owner or architect.
2. All new gypsum board partitions shall be taped and sanded smooth with no visible joints. Patch and repair surfaces to match adjacent or adjoining surfaces where required. All surfaces shall be aligned and sanded smooth.
3. All partitions are dimensioned from finish face of gypsum board to finish face of gypsum board unless otherwise noted. All dimensions marked "Clear" or "clr" shall be maintained and shall allow for thicknesses of all wall finishes, U.N.O.
4. Dimensions noted "clear" or "clr" must be accurately maintained and shall not vary more than +/- 1/8" without instruction from architect and/or owner, as applicable.
5. Dimensions marked +/- mean a tolerance not greater nor smaller than 2 inches from indicated dimension, U.N.O. verify field dimensions exceeding tolerance with architect or owner.
6. All dimensions to the exterior window wall are to the inside face of sill, U.N.O.
7. Notify architect or owner of any discrepancies or conflicts in the locations of the new construction.
8. All exposed gypsum board edges to have metal edge trim work or equivalent.
9. All work shall be directed and installed, plumb, level, square, and true and in proper alignment.
10. Refer to cover sheet for additional notes, legends, symbols, abbreviations, and schedules.
11. Refer to electrical power plans for locations of switched, outlets and the like.
12. Obtain approval from architect or owner, as applicable, prior to modifying building components, systems and items not identified prior to adjusting any and all other field conditions required to fit plans.
13. All existing and new floor penetrations for piping shall be fully blocked and sealed in accordance with the applicable building fire codes.
14. Trim the bottoms of the doors to clear the top of finished floor, as applicable, by 1/2" maximum, U.N.O., Verify slab conditions, trim each door to fit condition. Where radical variations in floor elevation exist, doors shall be ordered with bottom stile sized to accommodate these undercut conditions.
15. Dimensions locating doors are to the inside of edge of jamb U.N.O.
16. All "wet walls" to receive concrete board or green board.
17. Existing plumbing in kitchen to remain. Tie into existing plumbing at closest route and / or location.
18. New electrical to be verified in existing panel.
19. Verify existing floor framing and subfloor before new hardwood is installed.

LOFT PLAN PROPOSED

SNYDER RESIDENCE  
 RESIDENTIAL UPGRADES  
 1118 WHITEHEAD STREET KEY WEST, FLORIDA 33040

**WILLIAM ROWA NICHOLS**  
 ARCHITECTURE  
 KEY WEST, FLORIDA  
 FLORIDA LICENSE ARCH00134

PROJECT NO.

DATE 2-20-2020

**A6**

7 OF 14



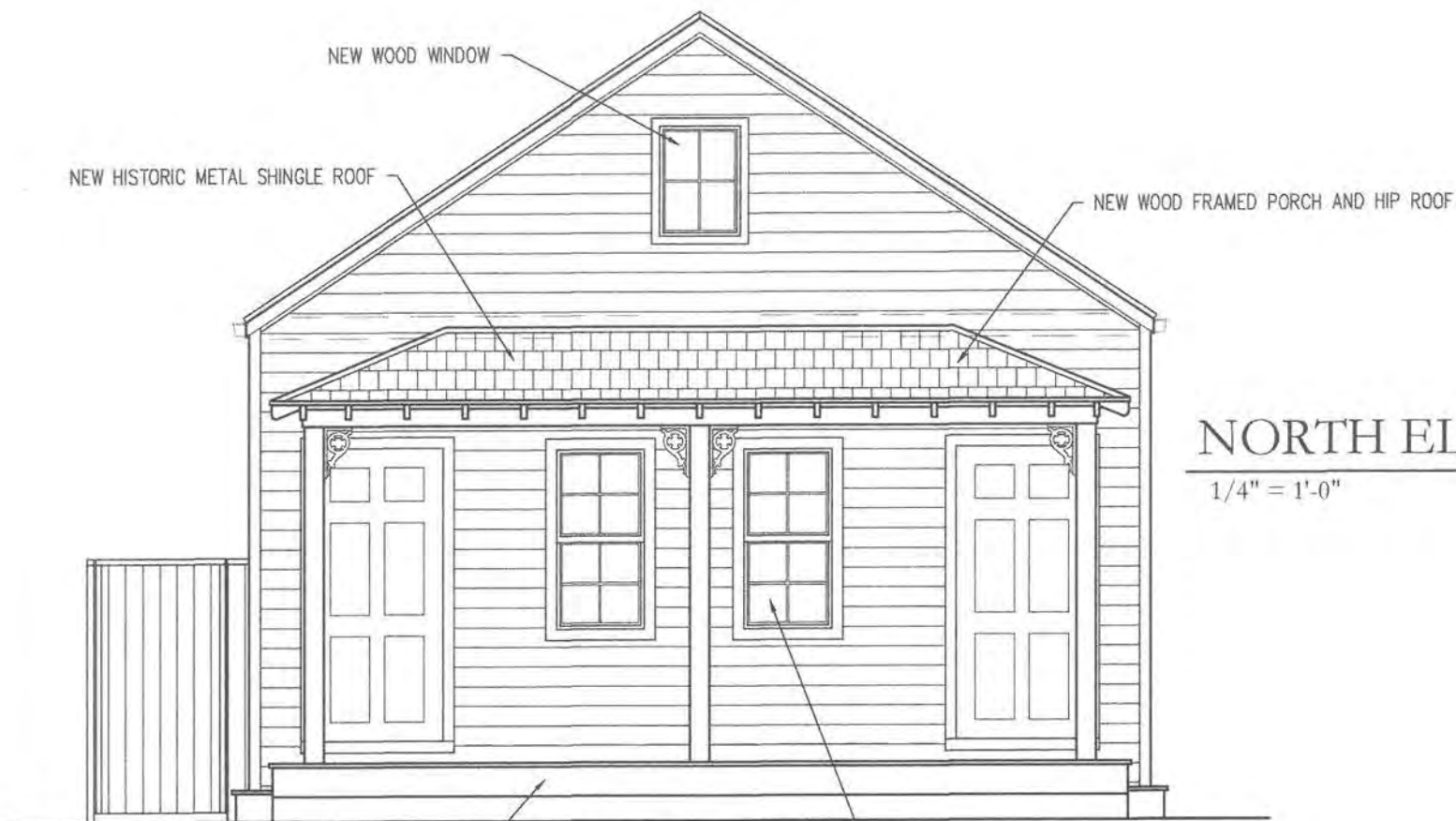

**NORTH ELEVATION**

1/4" = 1'-0"

PROPOSED



STREET VIEW - CIRCA 1965

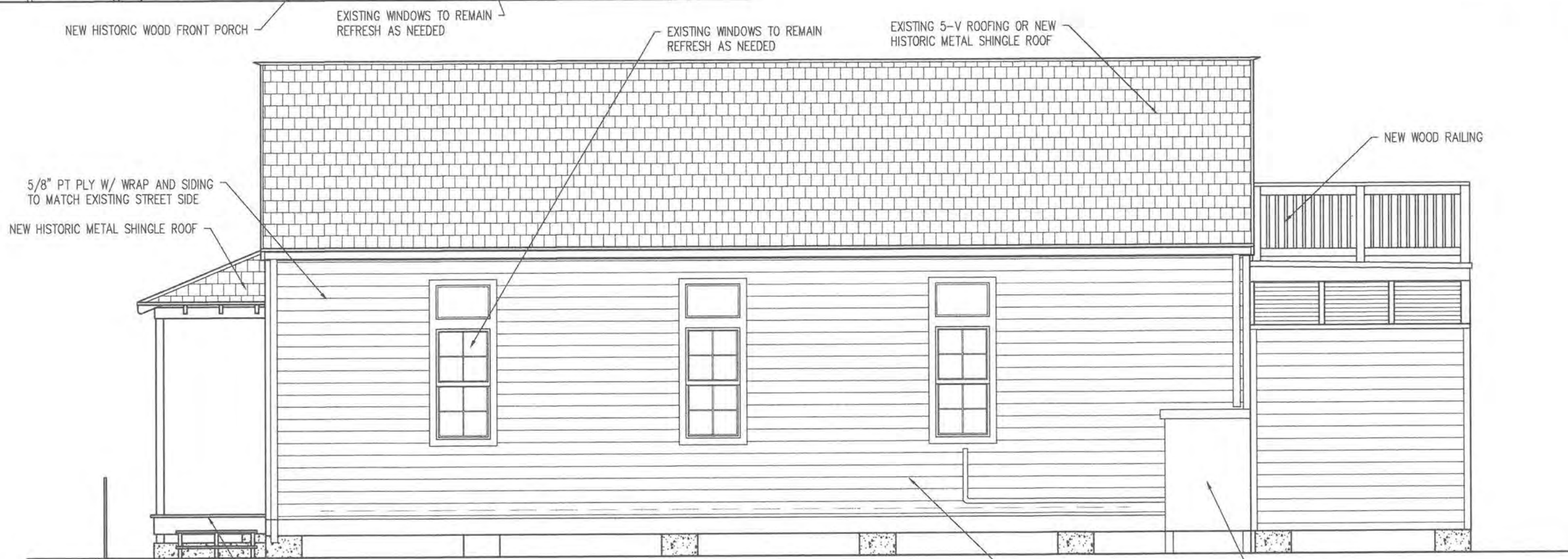

**WEST ELEVATION**

1/4" = 1'-0"

EXISTING

PROPOSED ELEVATIONS

SNYDER RESIDENCE  
RESIDENTIAL UPGRADES

8 WHITEHEAD STREET KEY WEST, FLORIDA 33040

WILLIAM ROWA  
ARCHITECTURE

KEY WEST, FLORIDA  
FLORIDA LICENSE: AK 001731

321 PEACOCK LANE  
305 596 3784

PROJECT NO.

DATE 2-20-2020

A7

8 OF 14



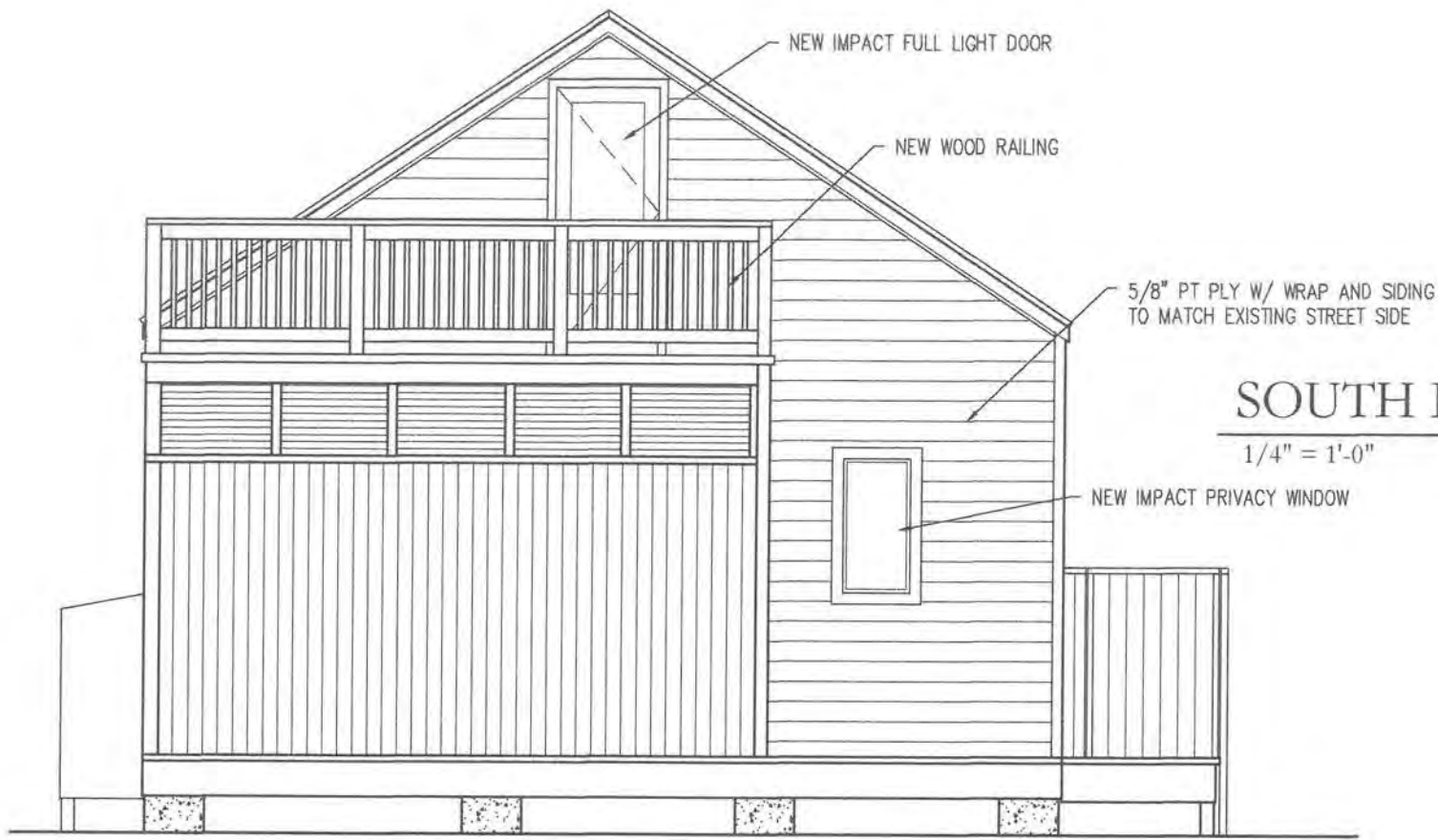

**SOUTH ELEVATION**

1/4" = 1'-0"

PROPOSED

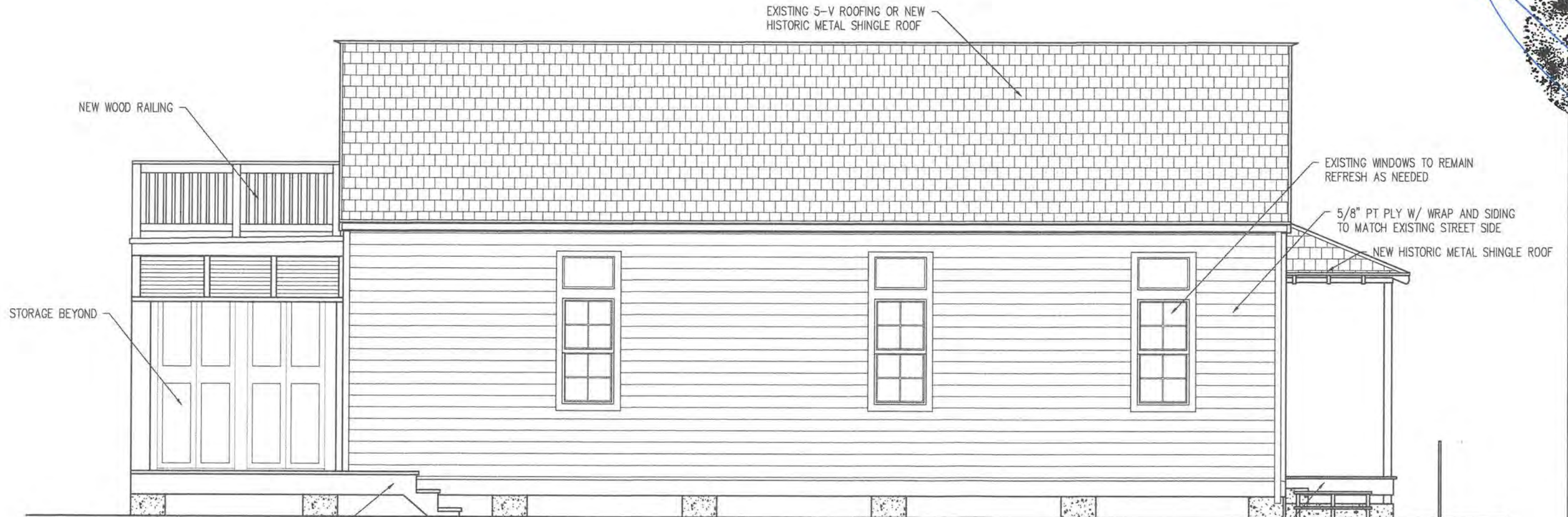

**EAST ELEVATION**

1/4" = 1'-0"

PROPOSED

SNYDER RESIDENCE  
RESIDENTIAL UPGRADES  
WHITEHEAD STREET KEY WEST, FLORIDA 33040

WILLIAM ROWAN NICHOLS  
ARCHITECTURE  
321 PENNSYLVANIA  
KEY WEST, FLORIDA  
FLORIDA LICENSE #AR001774

PROJECT NO.

DATE 2-20-2020

A8

9 OF 14

PROPOSED ELEVATIONS



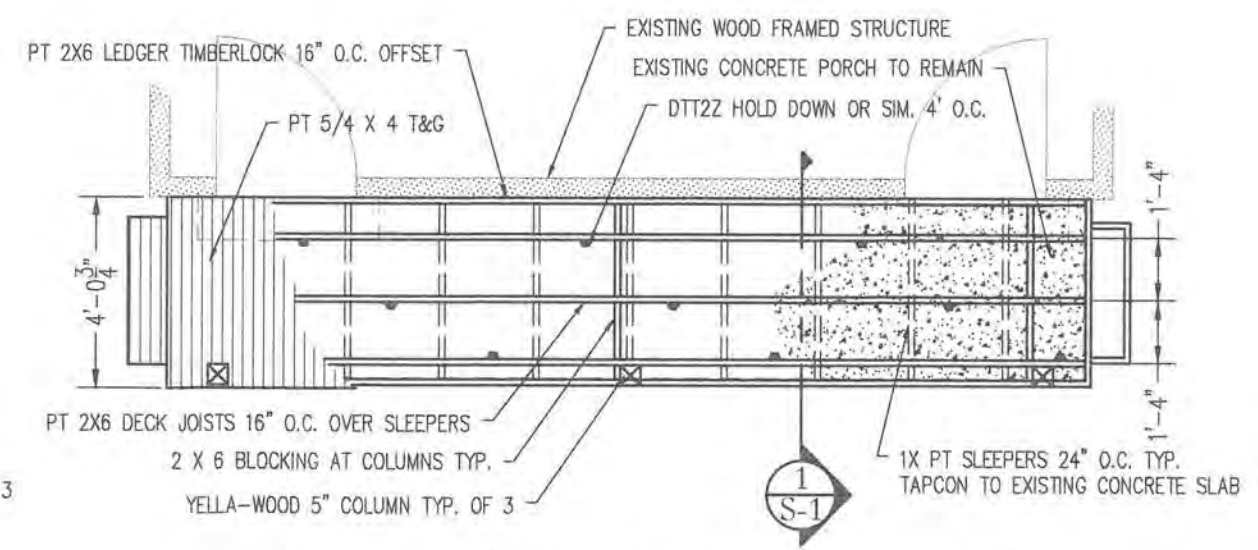
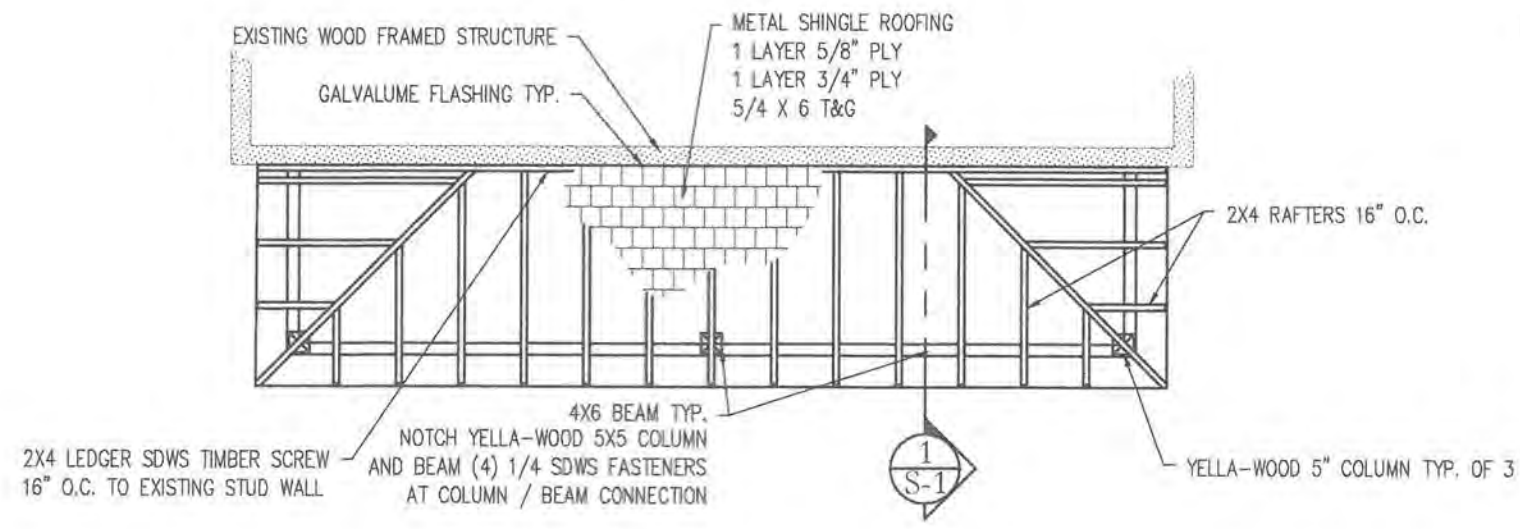
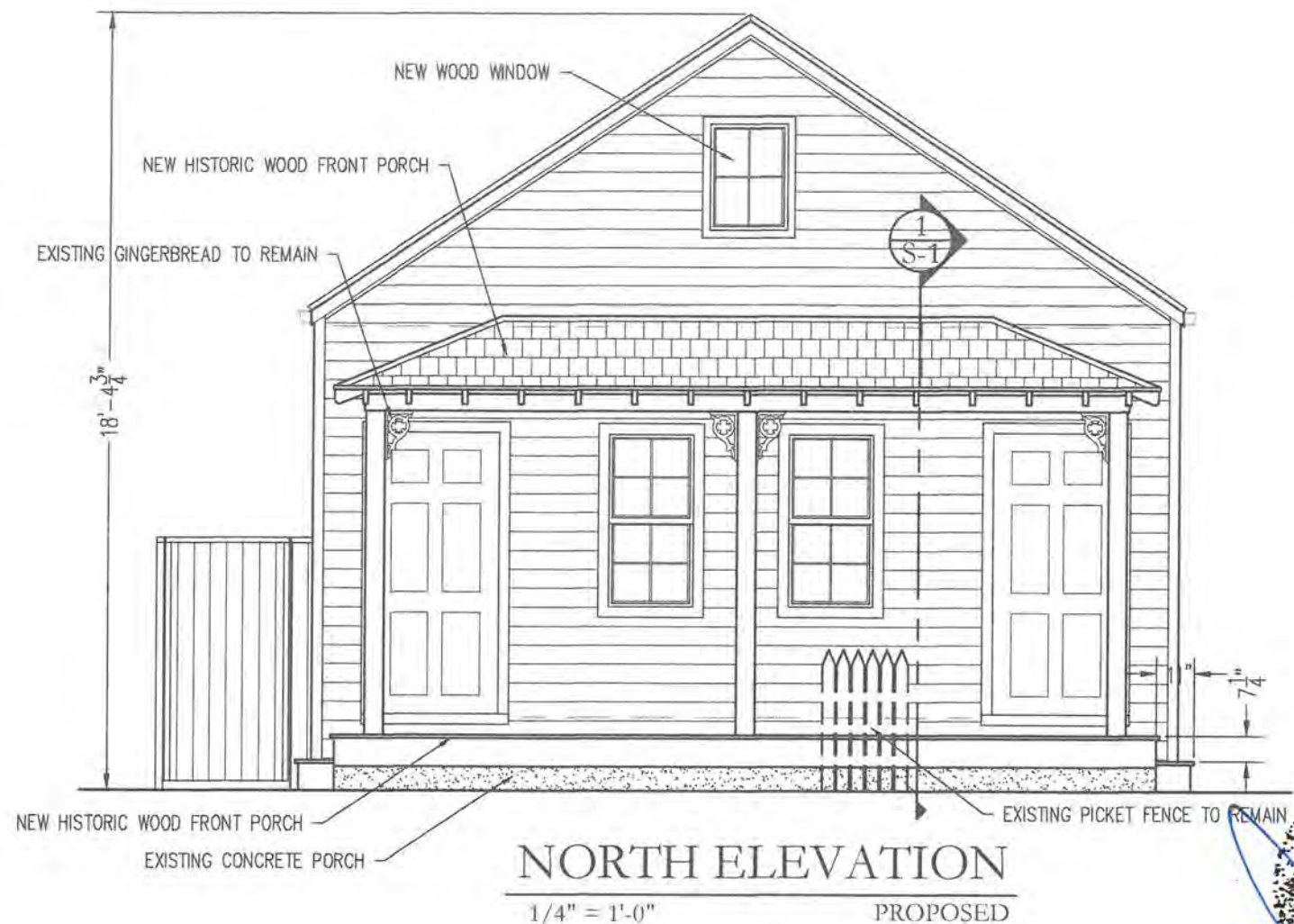
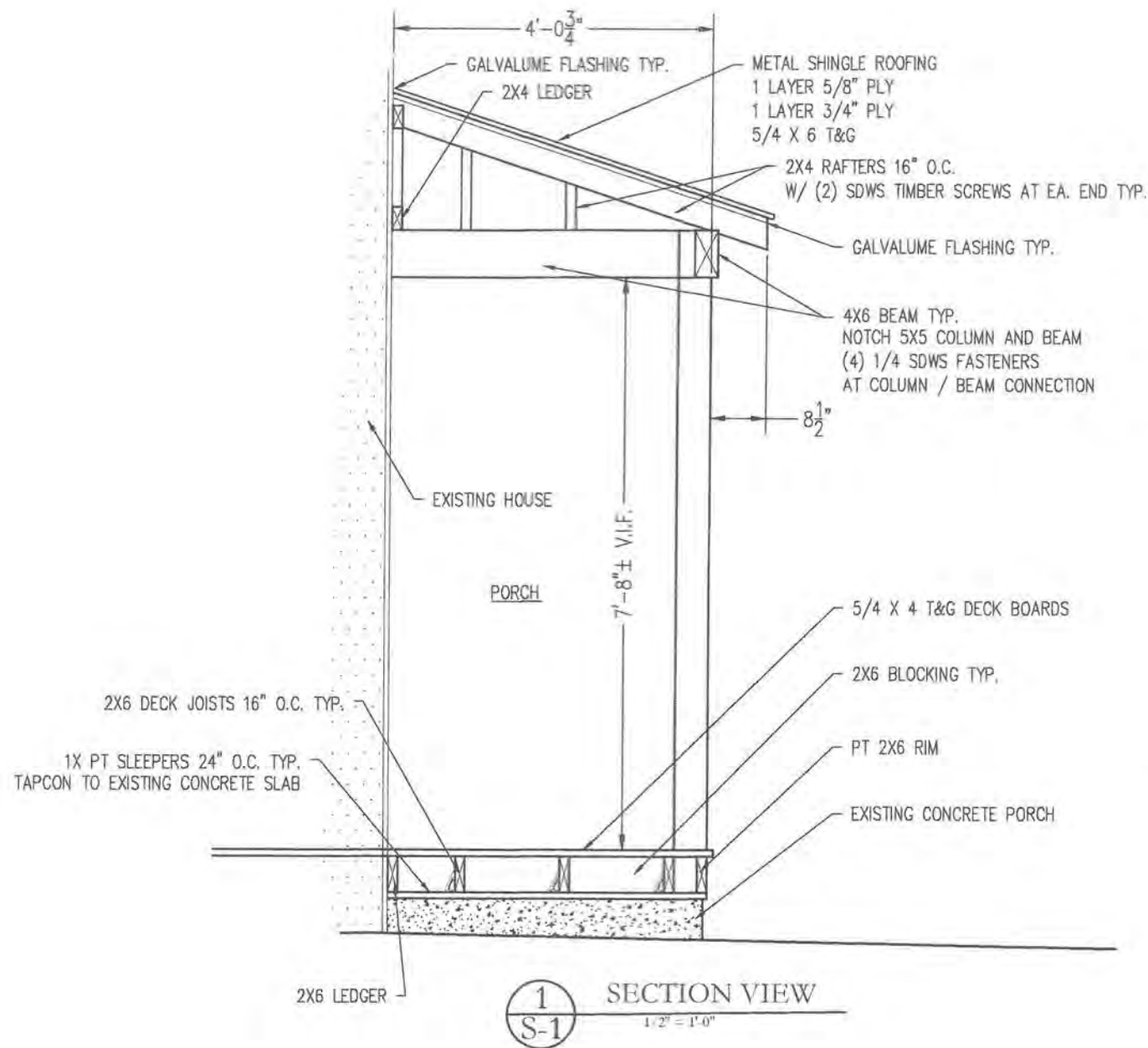

N

PORCH ROOF FRAMING PLAN

1/4" = 1'-0"

N

PORCH FLOOR FRAMING PLAN

1/4" = 1'-0"

FLOOR FRAMING FRONT PORCH

SNYDER RESIDENCE  
 RESIDENTIAL UPGRADES  
 138 WHITEHEAD STREET KEY WEST, FLORIDA 33040

**WILLIAM ROWA**  
 ARCHITECTURE  
KEY WEST, FLORIDA  
 FLORIDA LICENSE AB-007751

PROJECT NO.

DATE 2-10-2020

**S1**

10 OF 14



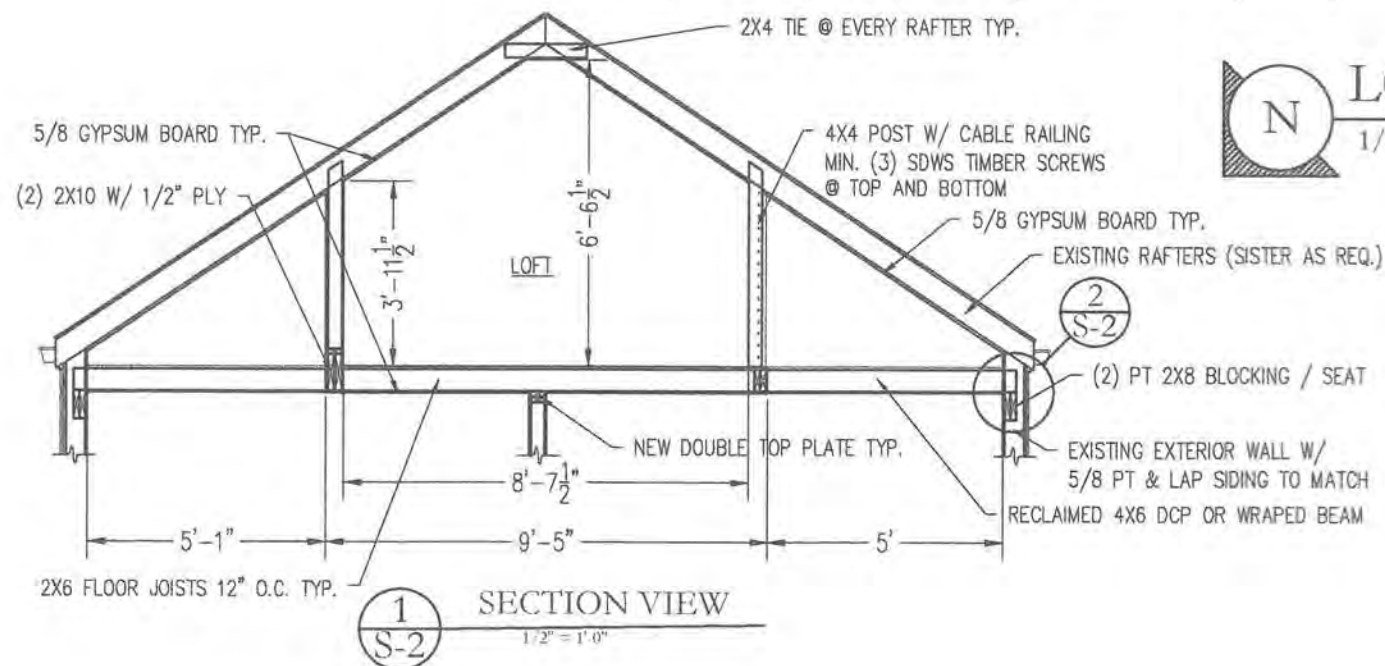
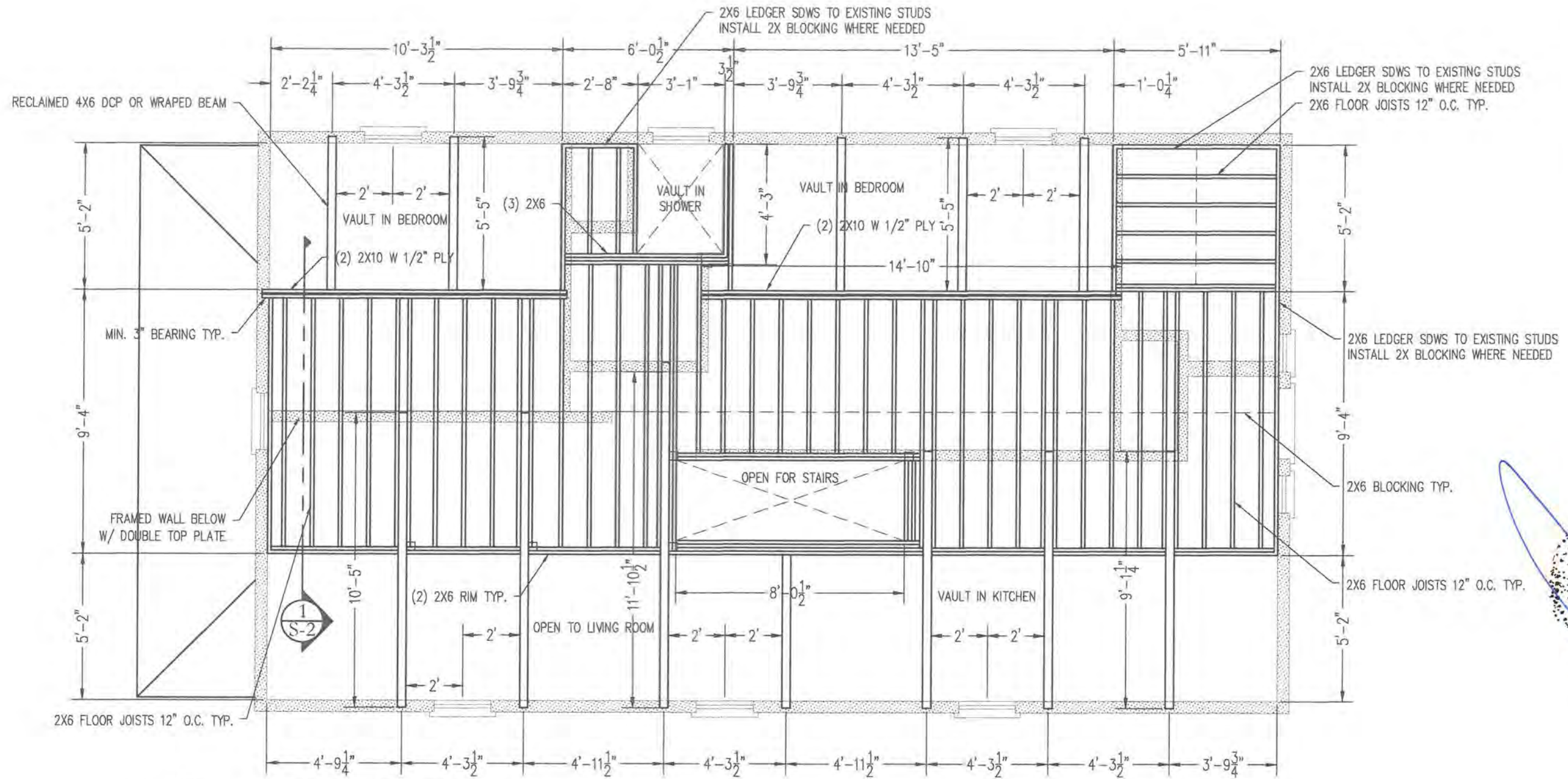

**LOFT FRAMING PLAN**  
1/4" = 1'-0"

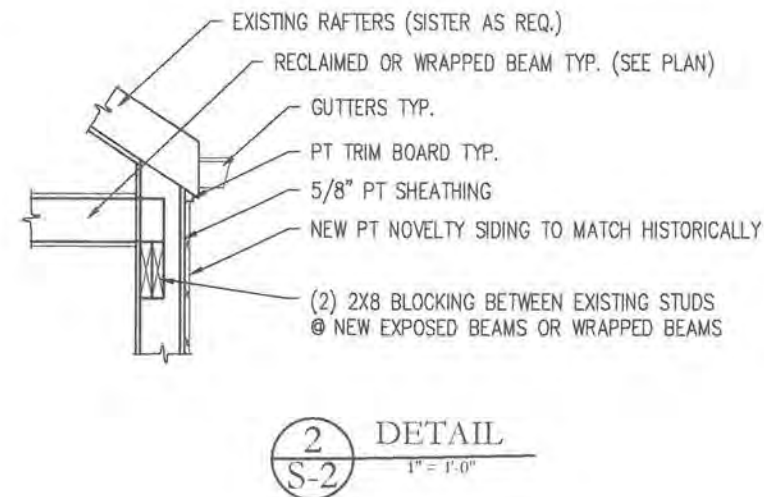

# NOTICING

# Public Meeting Notice

The Historic Architectural Review Commission will hold a public meeting at **5:00 p.m., June 29, 2021 at City Hall, 1300 White Street**, Key West, Florida. In order to view the live feed of the meeting, you can tune in to Comcast channel 77, AT&T Uverse channel 99, or type this link into your browser:

[http://keywestcity.granicus.com/MediaPlayer.php?publish\\_id=1&embed=1](http://keywestcity.granicus.com/MediaPlayer.php?publish_id=1&embed=1) If you wish to participate virtually, please contact HARC staff at 305-809-3975. The purpose of the hearing will be to consider a request for:

**RECONSTRUCTION OF FRONT PORCH AND RENOVATIONS TO HOUSE. REPLACE SIDE AND REAR LOWER DECKS. DEMOLITION OF NON-HISTORIC FRONT PORCH ELEMENTS.**

**#1118 WHITEHEAD STREET**

**Applicant –Casebolt Construction Application #H2021-0024**

If you wish to see the application or have any questions, you may visit the Planning Department during regular office hours at 1300 White Street, call 305-809-3973 or visit our website at [www.cityofkeywest-fl.gov](http://www.cityofkeywest-fl.gov).

**THIS NOTICE CAN NOT BE REMOVED FROM THE SITE UNTIL HARC FINAL DETERMINATION**

ADA ASSISTANCE: It is the policy of the City of Key West to comply with all requirements of the Americans with Disabilities Act (ADA). Please call the TTY number at 800-955-8771 or 800-955-8770 (Voice) or the ADA Coordinator at 305-809-3811 at least five business days in advance for sign language interpreters, assistive listening devices, or materials in accessible format.



# PROPERTY APPRAISER INFORMATION



**Disclaimer**

The Monroe County Property Appraiser's office maintains data on property within the County solely for the purpose of fulfilling its responsibility to secure a just valuation for ad valorem tax purposes of all property within the County. The Monroe County Property Appraiser's office cannot guarantee its accuracy for any other purpose. Likewise, data provided regarding one tax year may not be applicable in prior or subsequent years. By requesting such data, you hereby understand and agree that the data is intended for ad valorem tax purposes only and should not be relied on for any other purpose.

By continuing into this site you assert that you have read and agree to the above statement.

**Summary**

Parcel ID 00026180-000000  
 Account# 1026956  
 Property ID 1026956  
 Millage Group 11KW  
 Location 1118 WHITEHEAD St, KEY WEST  
 Address  
 Legal KW PB1-25-40 PT LOTS 17 & 32 SQR 2 TR 10 G35-359/60 OR898-2291 OR931-895  
 Description OR931-896 OR931-902 OR940-1295/96 OR1216-1274/76 OR1315-435/36 OR1355-386/88 OR1355-389/90 OR1863-463/64  
 (Note: Not to be used on legal documents.)  
 Neighborhood 6021  
 Property SINGLE FAMILY RESID (0100)  
 Class  
 Subdivision Tracts 10 and 15  
 Sec/Twp/Rng 06/68/25  
 Affordable No  
 Housing



**Owner**

SNYDER DOUGLAS S  
 1118 Whitehead St  
 Key West FL 33040

SNYDER BRITTANY P  
 1118 Whitehead St  
 Key West FL 33040

**Valuation**

	2020	2019	2018	2017
+ Market Improvement Value	\$89,328	\$90,569	\$81,884	\$86,847
+ Market Misc Value	\$239	\$239	\$239	\$239
+ Market Land Value	\$205,526	\$218,991	\$218,991	\$218,991
= Just Market Value	\$295,093	\$309,799	\$301,114	\$306,077
= Total Assessed Value	\$182,878	\$178,767	\$175,434	\$171,826
- School Exempt Value	(\$25,000)	(\$25,000)	(\$25,000)	(\$25,000)
= School Taxable Value	\$157,878	\$153,767	\$150,434	\$146,826

**Land**

Land Use	Number of Units	Unit Type	Frontage	Depth
RESIDENTIAL DRY (010D)	1,381.50	Square Foot	27.8	50.3

**Buildings**

Building ID 2044  
 Style 1 STORY ELEV FOUNDATION  
 Building Type S.F.R. - R1 / R1  
 Gross Sq Ft 1307  
 Finished Sq Ft 756  
 Stories 1 Floor  
 Condition GOOD  
 Perimeter 114  
 Functional Obs 0  
 Economic Obs 0  
 Depreciation % 30  
 Interior Walls WALL BD/WD WAL  
 Exterior Walls ABOVE AVERAGE WOOD  
 Year Built 1928  
 EffectiveYearBuilt 1999  
 Foundation CONC BLOCK  
 Roof Type GABLE/HIP  
 Roof Coverage METAL  
 Flooring Type CONC S/B GRND  
 Heating Type NONE with 0% NONE  
 Bedrooms 2  
 Full Bathrooms 1  
 Half Bathrooms 0  
 Grade 450  
 Number of Fire Pl 0

Code	Description	Sketch Area	Finished Area	Perimeter
FLA	FLOOR LIV AREA	756	756	0
OPU	OP PR UNFIN LL	232	0	0
OOU	OP PR UNFIN UL	112	0	0
OPF	OP PRCH FIN LL	207	0	0
TOTAL		1,307	756	0



**Yard Items**

Description	Year Built	Roll Year	Quantity	Units	Grade
FENCES	1985	1986	1	135 SF	2

**Sales**

Sale Date	Sale Price	Instrument	Instrument Number	Deed Book	Deed Page	Sale Qualification	Vacant or Improved
3/4/2003	\$325,000	Warranty Deed		1863	0463	Q - Qualified	Improved
5/1/1995	\$138,000	Warranty Deed		1355	0389	U - Unqualified	Improved
7/1/1994	\$110,000	Warranty Deed		1315	0435	U - Unqualified	Improved
5/1/1985	\$47,000	Warranty Deed		940	1295	Q - Qualified	Improved
12/1/1984	\$44,000	Warranty Deed		931	902	U - Unqualified	Improved

**Permits**

Number	Date Issued	Date Completed	Amount	Permit Type	Notes
8-3779	10/13/2008	11/12/2008	\$8,933		INSTALL 1000SF METAL ROOFING
04-0684	3/9/2004	11/23/2004	\$1,200		SEWER LATERAL
03-1210	4/4/2003	10/30/2003	\$2,600		ROOFING
9700326	2/1/1997	12/1/1997	\$600		DEMOLITION
9603875	9/1/1996	12/1/1997	\$1,000		RENOVATION

**View Tax Info**

[View Taxes for this Parcel](#)

**Sketches (click to enlarge)**

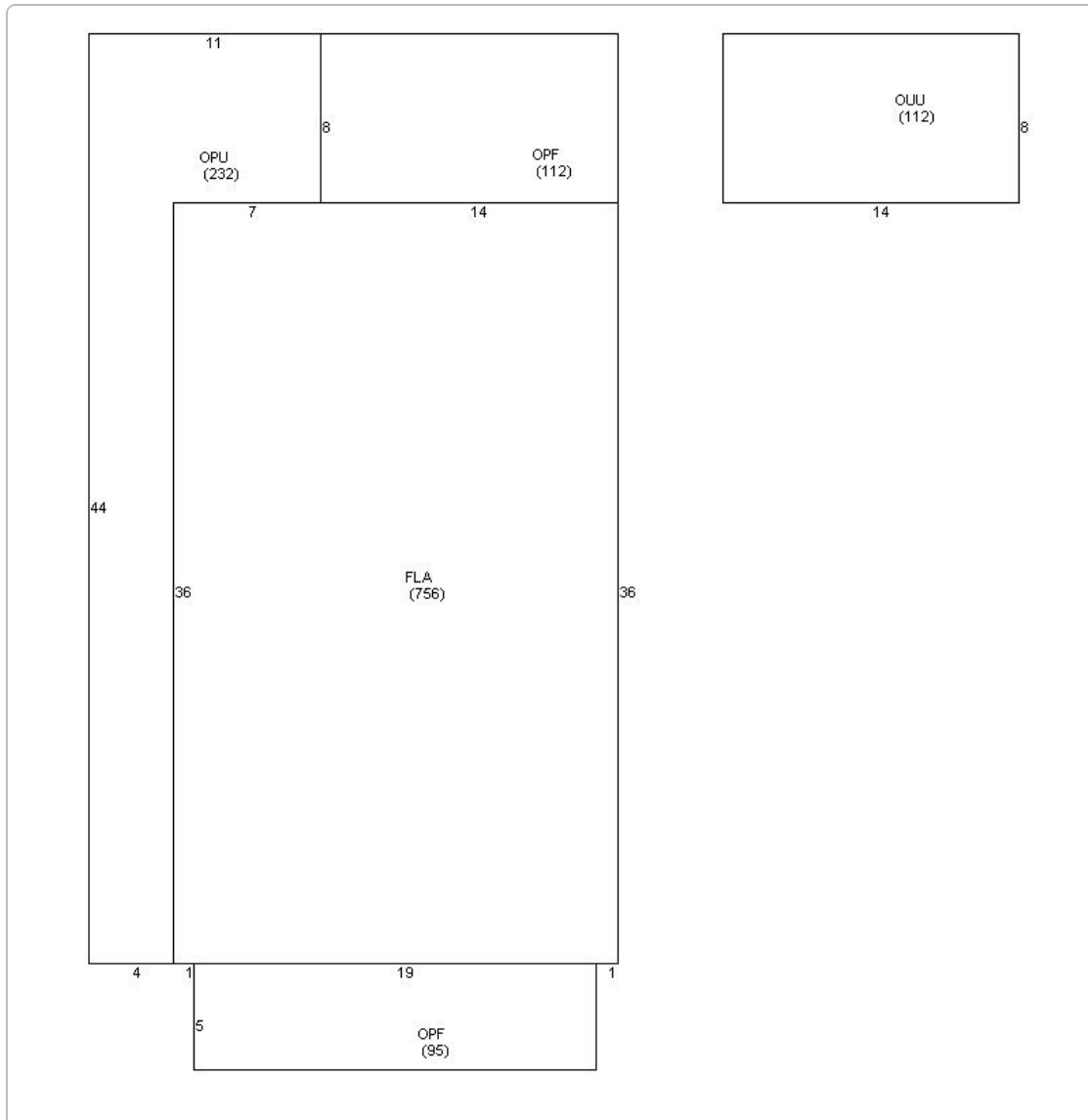

Photos



Map



TRIM Notice

[2020 TRIM Notice \(PDF\)](#)

2020 Notices Only

No data available for the following modules: Commercial Buildings, Mobile Home Buildings, Exemptions.

The Monroe County Property Appraiser's office maintains data on property within the County solely for the purpose of fulfilling its responsibility to secure a just valuation for ad valorem tax purposes of all property within the County. The Monroe County Property Appraiser's office cannot guarantee its accuracy for any other purpose. Likewise, data provided regarding one tax year may not be applicable in prior or subsequent years. By requesting such data, you hereby understand and agree that the [User Privacy Policy](#) [GDPR Privacy Notice](#)

Developed by  
 Schneider  
 GEOSPATIAL

Last Data Upload: [6/14/2021, 2:07:48 AM](#)

Version 2.3.125