

# **Application**

SMITH / HAWKS  
ATTORNEYS AT LAW

Barton W. Smith, Esq  
Telephone: (305) 296-7227  
Facsimile: (305) 296-8448  
Email: [Bart@smithhawks.com](mailto:Bart@smithhawks.com)

**VIA HAND DELIVERY and E-MAIL**

August 26, 2020

Katie Halloran, Planning Director  
City of Key West Planning Department  
1300 White Street  
Key West, FL 33040  
[Katie.halloran@cityofkeywest-fl.gov](mailto:Katie.halloran@cityofkeywest-fl.gov)

**Re: StorCon Development, LLC – Application for a Text Amendment to the City of Key West Comprehensive Plan**

Katie,

Please find below StorCon Development, LLC's ("Applicant") amendment to the proposed Text Amendment to the City of Key West Comprehensive Plan ("Comp Plan"). The original application and application fee were submitted to the City of Key West Planning Department on June 19, 2020 ("Original Application"). A corresponding amendment to the City of Key West Land Development Regulations ("LDR Amendment") is being proposed simultaneously.

As the City of Key West is in an area of critical state concern pursuant to Section 380.05, *Florida Statutes (2019)*, any Comp Plan amendment must go through the State Coordinated Review Process set out in Section 163.3184(4), *Florida Statutes (2019)*. The State Coordinated Review Process requires that, within 10 days after the first public hearing, the proposed amendment be sent the state land planning agency, who will have 60 days to send a report with any objections or comments back to the City, who may then hold the final public hearing.

Applicant is proposing to amend the Comp Plan to increase the maximum floor area ratio of the General Commercial District (CG) from 0.8 to 1.0. An increase in maximum floor area ratio ("FAR") will encourage favorable uses throughout the General Commercial District (CG) District ("District") that are supported by Comp Plan Goals, Objectives and Policies. A FAR increase in the District will incentivize redevelopment of aging and/or unoccupied commercial buildings, the largest of which include former Sears and K-Mart. The conditions of aging buildings in the District make it infeasible to add affordable resident housing above the existing first floor commercial use. Increased maximum FAR will encourage redevelopment that will include new structures with affordable resident housing atop new commercial space, which is supported by the Comp Plan.

This proposal includes the entire General Commercial District (CG), which currently primarily consists of a variety of commercial uses and transient lodging (hotels) along North Roosevelt Boulevard. Below is an illustration of the area included in the proposal:

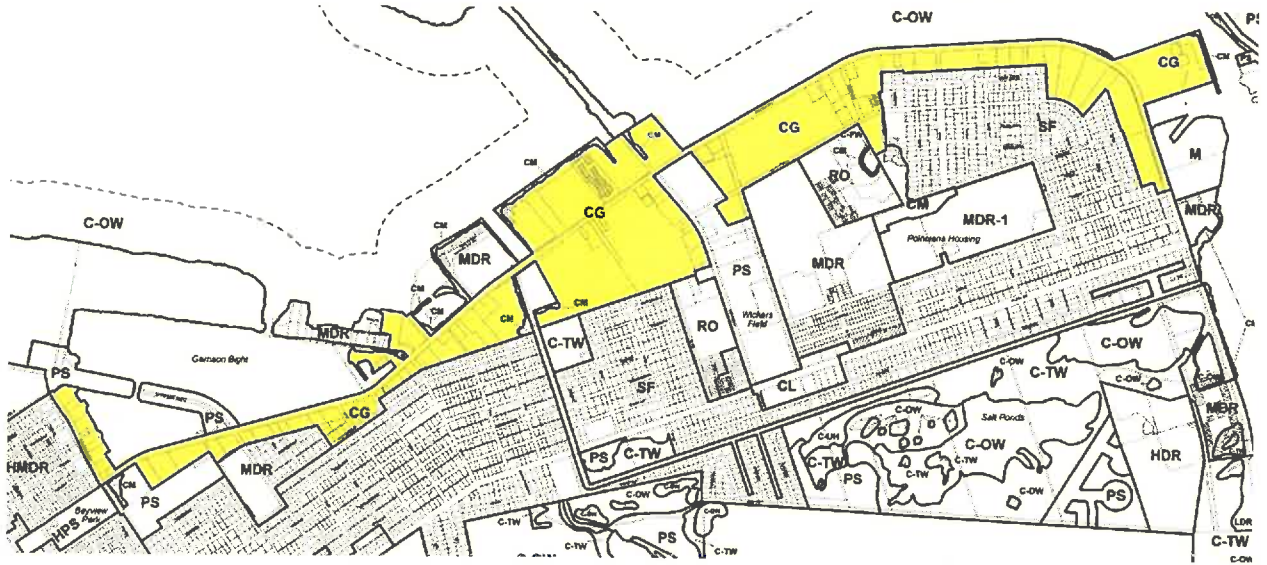

The only change proposed is to one portion of Table 1-1.1.5 regarding the General Commercial (CG) Zoning District. Proposed text additions in blue and deletions are in red and struck-through and text in black font is already existing and not proposed to be amended:

Table 1-1.1.5

\*\*\*

COMMERCIAL FUTURE LAND USE DISTRICT			
Zoning District	Density	Intensity	Uses & Limitations
(CT) Salt Pond Commercial Tourist	Maximum of 16 dwelling units per acre.*	Maximum FAR of 0.8	Allowable uses in areas zoned CT are motels, limited scale tourist facilities, customary accessory uses, and requisite community facilities including public schools.
(CG) General Commercial	Maximum of 16 dwelling units per acre.*	Maximum FAR of 1.0 <del>0.8</del>	Allowable commercial uses in areas zoned GC inclusive of, but not limited to, general retail sales and services, highway oriented sales and services, other general commercial activities, customary accessory uses, and requisite community facilities including public schools. Residential uses are allowed and encouraged in the (CG) General Commercial Zoning

			District if in conformance with Policy 1-1.1.4 with a *density bonus allowing up to 40 dwelling units per acre with the provision of deed restricted affordable housing in conformance with Policy 3-1.1.7. Density bonuses are solely for affordable housing. Market rate housing will be restricted to the maximum of 16 dwelling units per acre.
(CL) Limited Commercial	Maximum of 16 dwelling units per acre.*	Maximum FAR of 0.8	Allowable commercial uses in areas zoned CL include but are not limited to low to medium intensity retail; small limited item shops and customary accessory uses, and requisite community facilities including public schools.

\*\*\*

The following criteria for approval of Comp Plan Amendments are listed in Section 90-555 of the City of Key West Code of Ordinances:

**(1) Consistency with plan. Whether the proposal is consistent with the comprehensive plan, including the adopted infrastructure minimum levels of service standards and the concurrency management program.**

The following is provided as support for consistency with the Comp Plan:

**Portion of Table 1-1.1.5 regarding the CG District:**

**Allowable commercial uses in areas zoned GC inclusive of, but not limited to, general retail sales and services, highway oriented sales and services, other general commercial activities, customary accessory uses, and requisite community facilities including public schools. Residential uses are allowed and encouraged in the (CG) General Commercial Zoning District if in conformance with Policy 1-1.1.4 with a \*density bonus allowing up to 40 dwelling units per acre with the provision of deed restricted affordable housing in conformance with Policy 3-1.1.7. Density bonuses are solely for affordable housing. Market rate housing will be restricted to the maximum of 16 dwelling units per acre.**

- The proposal to increase maximum FAR would lead to more affordable housing encouraged and allowed in the District. A higher FAR will make possible mixed-use developments that generally provide affordable residential units on the elevated stories and low intensity commercial services or retail that are compatible with residential uses on the ground floor. A higher FAR will allow property owners in the District to utilize the density bonus for affordable housing.

**Policy 1-1.1.4: - Affordable Housing and Compact Development Incentives.**

Within land use categories supporting mixed use development, the Land Development Regulations shall include density and intensity bonuses that fall within the parameters of the Comprehensive Plan and Future Land Use Map to achieve the following objectives: *provision of affordable housing immediately adjacent to employment opportunities; reduction in dependence on automobile travel for home/work travel; provision of a range of housing types, inclusive of apartments, townhouses, efficiencies, and single room occupancies; establishment of a variety of retail uses to support onsite or adjacent residential uses; provision of sufficient density of residential uses and presence of retail commercial to support transit demand; support of redevelopment of aging, traditional suburban shopping center retail; provision of open space and recreational uses within or immediately adjacent to the mixed use complex; provision of immediate access to and support of bicycle path networks in the City; increased efficiency of energy and water use; increased solid waste diversion; increased stormwater harvesting; decreased inappropriate water use, and; creation of opportunities to provide substantial new landscaping, parking and housing/retail areas to reduce carbon footprints and support sustainability goals.*

- The proposal will increase mixed-use development placing commercial uses proximate to a variety of residences.
- The proposal will encourage property owners to utilize existing density bonus.
- An increased FAR in the District will support the redevelopment of aging and under-utilized traditional suburban shopping center retail in the District, as encouraged by this Policy.

**GOAL 1-1: - ENSURE THAT THE CHARACTER AND LOCATION OF LAND USES INCORPORATE BEST MANAGEMENT PRACTICES AND PRINCIPLES OF RESOURCE CONSERVATION; ENHANCE COMMUNITY APPEARANCES; PROMOTE ORDERLY LAND USE TRANSITION, AND; MINIMIZE THREATS TO HEALTH, SAFETY, AND WELFARE WHICH MAY BE CAUSED BY INCOMPATIBLE LAND USES, ENVIRONMENTAL DEGRADATION, HAZARDS AND NUISANCES.**

- An increase in FAR in the District will enhance community appearances and promote orderly land use transition by encouraging redevelopment that will bring many existing nonconforming developments into compliance with City of Key West Land Development Regulations ("LDRs") and defend against rising sea-levels.
- Increasing the maximum FAR does not alter other requirements in the LDRs such as minimum open space, maximum impervious surface, maximum building coverage, landscaping, draining or setbacks. Instead, an increased FAR tends to encourage two- or three-story mixed-use developments that have a smaller bottom floor footprint and more open space.

**Policy 1-1.2.1: - Provide Access to Goods and Services and Protect Residential Areas from the Adverse Impacts of Transition in Land Use.**

Stable residential areas and projected future residential areas as delineated on the Future Land Use Map shall be protected from encroachment by incompatible development. This objective does not preclude necessary community facilities from locating within residential areas when

such activities satisfy established criteria of this plan and the City's Land Development Regulations.

Any potential adverse impacts caused by different land uses located adjacent to each other shall be minimized by landscaping, including vegetated berms with tree canopy where practical, or by other appropriate screening and buffering techniques. These landscaping techniques shall be incorporated into the design of new or redeveloping nonresidential projects located adjacent to existing or planned residential development.

Similarly, perimeter landscaping techniques shall be applied in multiple family residential developments in order to appropriately screen and buffer existing and planned single family home sites from residential development having differing structure types.

Land Development Regulations shall maintain and continue to update standards and/or review criteria for mandating retention of open space and for regulating building design, including setbacks, building placement on site, and building orientation. These provisions shall be directed toward protecting privacy, as well as access to light, air and open space. Other reasonable design principles shall be included in the zoning code in order to alleviate adverse impacts of potentially incompatible land uses.

- The proposal will encourage mixed-use developments that will provide goods and services aimed toward residents and tourists and decrease the amount of goods and services aimed primarily for tourists. Many high intensity, high volume uses that may be harmful or disturbing to residential uses do not require a lot of floor area and therefore become relatively more viable than high floor area, low volume uses that mesh well with residential uses.
- An increased FAR will promote redevelopment that will come into compliance with the LDRs providing landscaping and buffering that current legal nonconforming uses do not provide.

**OBJECTIVE 1-1.3: - ALLOCATING COMMERCIAL DEVELOPMENT.**

Land area shall be designated to accommodate a variety of commercial uses. The City shall promote the image, function, architecture, and ambiance of the Historic Preservation Commercial Core District as the City's center for commerce as well as civic and cultural enrichment. In this pursuit the City shall preserve and enhance the identity, design, and vitality of the District.

The management of development and redevelopment activities shall promote preservation of the historic resources of the Historic Preservation Commercial Core District and ensure that new structures are compatible with the built environment. *Along the North Roosevelt commercial corridor, the City shall promote redevelopment of mixed use and general commercial activities which fulfill market demands of the City's residents for affordable housing proximate to retail sales and services.* The existing limited commercial area shall also be maintained for neighborhood commercial activities to meet consumer demands of residents within the areas.

- Almost the entire CG District is along the North Roosevelt commercial corridor and the proposal to increase maximum FAR will encourage redevelopment of mixed use and general commercial activities which fulfill market demands of the City's residents for affordable housing near commercial retail and services.

**Policy 1-1.3.2: - Designate Various Types of Mixed Use Commercial Nodes to Accommodate Diverse Commercial Uses.**

**A variety of commercial development designations shall be provided in order to adequately ensure availability of sites that accommodate the varied site and spatial requirements for such activities as: professional and business offices, limited commercial activities, and general retail sales and services. *In addition, it is the intent of the City of Key West to encourage mixed use residential and commercial developments which include residential uses with particular emphasis on the provision of affordable housing.***

- Increasing the maximum FAR will implement this policy and encourage mixed use residential and commercial developments and, together with other affordable housing incentives, will encourage providing affordable housing in the District, as specifically encouraged in this Policy.

**Policy 1-1.4.6: - Increase Resilience of General Landscaping.**

**The City shall use best available science and predictions for sea level rise and other climate change related issues to guide the long term health and appearance of landscape plantings. By 2014 the City shall work with sea level rise and native plant experts to create a "Climate Adaptation Planting Plan" ordinance to affect landscaping plans. This plan shall be reviewed every other year to stay up to date with climate change predictions.**

- Redevelopment of aging properties will include conformance with building code, flood protection regulations and landscaping requirements, which would make the new developments more safe, sustainable, and good looking.

**OBJECTIVE 1-1.5: - PROMOTE COMMUNITY APPEARANCE, NATURAL AMENITIES AND URBAN DESIGN PRINCIPLES.**

**The City's built environment should reflect Key West's values, architectural history, and characteristic mix of uses. The City shall establish and maintain a level of design excellence in accordance with Goal 2 of the 2011 Strategic Plan.**

- Increasing maximum FAR and encouraging redevelopment will enhance community appearance and implement modern urban design principles.

**Policy 1-1.5.1: - Reinforce and Enhance the City's Community Appearance.**

**Major attributes shall be preserved through application of design review standards and management of signs, landscaping, open space, tree protection, and other urban design amenities. Special emphasis shall be placed on preserving and/or improving the character of major natural and man-made corridors, including the waterfront shoreline, scenic views of the waterfront and tidal waters, wetlands, major drainage corridors, and major transportation corridors which serve as a focal point for the motoring public.**

- This proposal does not propose any changes to landscaping or open space requirements of the Land Development Regulations. Instead, property owners with existing nonconformities who redevelop will be subject to current Land Development Regulations leading to more native landscaping and open space.

**Policy 1-1.11.4: - Managing Stormwater Run-off.**

**The developer/owner of any site shall be responsible for managing on-site run-off. All new development shall comply with adopted level of service standards for surface water management which shall include stormwater harvesting goals.**

- Much of the District's parcels are entirely paved. Redevelopment will implement current onsite storm water retention requirements.

**OBJECTIVE 1-1.12: - CONSIDER APPLICATION OF INNOVATIVE LAND AND WATER RESOURCE MANAGEMENT, CLIMATE ADAPTATION, AND ENERGY CONSERVATION CONCEPTS.**

**The City of Key West shall maintain Land Development Regulations which incorporate concepts for managing land, water, and energy resources which are responsive to unique development and conservation issues identified in the City's Comprehensive Plan. The City of Key West shall adopt Land Development Regulations which incorporate concepts for managing land, water, and the built environment which are responsive to climate change issues including but not limited to sea level rise and increased frequency of intense rainfall events.**

- Redevelopment encouraged by the proposal would impose FEMA regulations requiring raised structures or floodproofing, making the new development more resilient to storms and climate change. Any new development would also be made to comply with concepts in the Land Development Regulations regarding managing water, energy, and landscaping.

**GOAL 5-1: - COASTAL MANAGEMENT.**

**Restrict development activities that would damage or destroy coastal resources. Protect human life and limit public expenditures in areas subject to destruction by natural disasters, but encourage policies which attract pedestrians, increase waterfront access, and reinforce the ambiance of the waterfront.**

- New development would conform to current storm and climate change mitigation regulations, which could protect human life and limit public expenditures.

\*\*\*

**(2) *Conformance with requirements.* Whether the proposal is in conformance with all applicable requirements of the Code of Ordinances.**

The proposed amendment is in conformance with all applicable requirements of the Code of Ordinances.

**(3) *Changed conditions.* Whether, and the extent to which, land use and development conditions have changed since the effective date of the existing regulations, and whether such changes support or work against the proposed rezoning.**

The current conditions in the District support the proposal and conditions have changed since the current Comp Plan effective date. There are now several aging commercial buildings in the



District that are unoccupied and out of business. Additionally, many businesses in the District have become tourist-centered and increasing FAR would pave the way for more businesses to serve the residents of the City of Key West and the Lower Keys. The proposal will encourage redevelopment supported by the Comp Plan Goals, Objectives and Policies, as detailed in Section (1).

**(4) *Land use compatibility.* Whether, and the extent to which, the proposal would result in any incompatible land uses, considering the type and location of uses involved.**

The proposal would not change the uses allowed in the District. The proposal would encourage uses promoted by the existing Comp Plan.

**(5) *Adequate public facilities.* Whether, and the extent to which, the proposal would result in demands on public facilities and services, exceeding the capacity of such facilities and services, existing or programmed, including transportation, water and wastewater services, solid waste disposal, drainage, recreation, education, emergency services, and similar necessary facilities and services. Approval of a plan amendment does not constitute a concurrency determination, and the applicant will be required to obtain a concurrency determination pursuant to [chapter 94](#).**

The proposal would not result in demands on public facilities and services beyond those that would be required to be provided by any property owner. Any development proposed would be required to be in compliance with the Land Development Regulations before being permitted.

**(6) *Natural environment.* Whether, and to the extent to which, the proposal would result in adverse impacts on the natural environment, including consideration of wetlands protection, preservation of groundwater aquifer, wildlife habitats, and vegetative communities.**

The proposal would not result in adverse impacts. The proposal would have favorable impacts on the natural environment and vegetative communities because any new project would come into compliance with the Land Development Regulations whereas the current state of many properties in the District are nearly entirely impervious and non-vegetative.

**(7) *Economic effects.* Whether, and the extent to which, the proposal would adversely affect the property values in the area or the general welfare.**

The proposal would have favorable impacts on the property values and general welfare of those in the area. The proposal would enhance the appearance of the area and provide needed services to residents, as well as provide jobs, stimulate the economy and increase City revenues. Additionally, the proposal would encourage the development of more affordable housing proximate to employment opportunities. The current high-volume uses encouraged with a lower maximum FAR may diminish the general welfare and property values in the area.

**(8) *Orderly development.* Whether the proposal would result in an orderly and compatible land use pattern. Any negative effects on such pattern shall be identified.**

SMITH / HAWKS  
ATTORNEYS AT LAW

Barton W. Smith, Esq  
Telephone: (305) 296-7227  
Facsimile: (305) 296-8448  
Email: [Bart@smithhawks.com](mailto:Bart@smithhawks.com)

**VIA HAND DELIVERY and E-MAIL**

August 26, 2020

Katie Halloran, Planning Director  
City of Key West Planning Department  
1300 White Street  
Key West, FL 33040  
[Katie.halloran@cityofkeywest-fl.gov](mailto:Katie.halloran@cityofkeywest-fl.gov)

**Re: StorCon Development, LLC – Application for a Text Amendment to the City of Key West Comprehensive Plan**

Katie,

Please find below StorCon Development, LLC's ("Applicant") amendment to the proposed Text Amendment to the City of Key West Comprehensive Plan ("Comp Plan"). The original application and application fee were submitted to the City of Key West Planning Department on June 19, 2020 ("Original Application"). A corresponding amendment to the City of Key West Land Development Regulations ("LDR Amendment") is being proposed simultaneously.

As the City of Key West is in an area of critical state concern pursuant to Section 380.05, *Florida Statutes (2019)*, any Comp Plan amendment must go through the State Coordinated Review Process set out in Section 163.3184(4), *Florida Statutes (2019)*. The State Coordinated Review Process requires that, within 10 days after the first public hearing, the proposed amendment be sent the state land planning agency, who will have 60 days to send a report with any objections or comments back to the City, who may then hold the final public hearing.

Applicant is proposing to amend the Comp Plan to increase the maximum floor area ratio of the General Commercial District (CG) from 0.8 to 1.0. An increase in maximum floor area ratio ("FAR") will encourage favorable uses throughout the General Commercial District (CG) District ("District") that are supported by Comp Plan Goals, Objectives and Policies. A FAR increase in the District will incentivize redevelopment of aging and/or unoccupied commercial buildings, the largest of which include former Sears and K-Mart. The conditions of aging buildings in the District make it infeasible to add affordable resident housing above the existing first floor commercial use. Increased maximum FAR will encourage redevelopment that will include new structures with affordable resident housing atop new commercial space, which is supported by the Comp Plan.

This proposal includes the entire General Commercial District (CG), which currently primarily consists of a variety of commercial uses and transient lodging (hotels) along North Roosevelt Boulevard. Below is an illustration of the area included in the proposal:

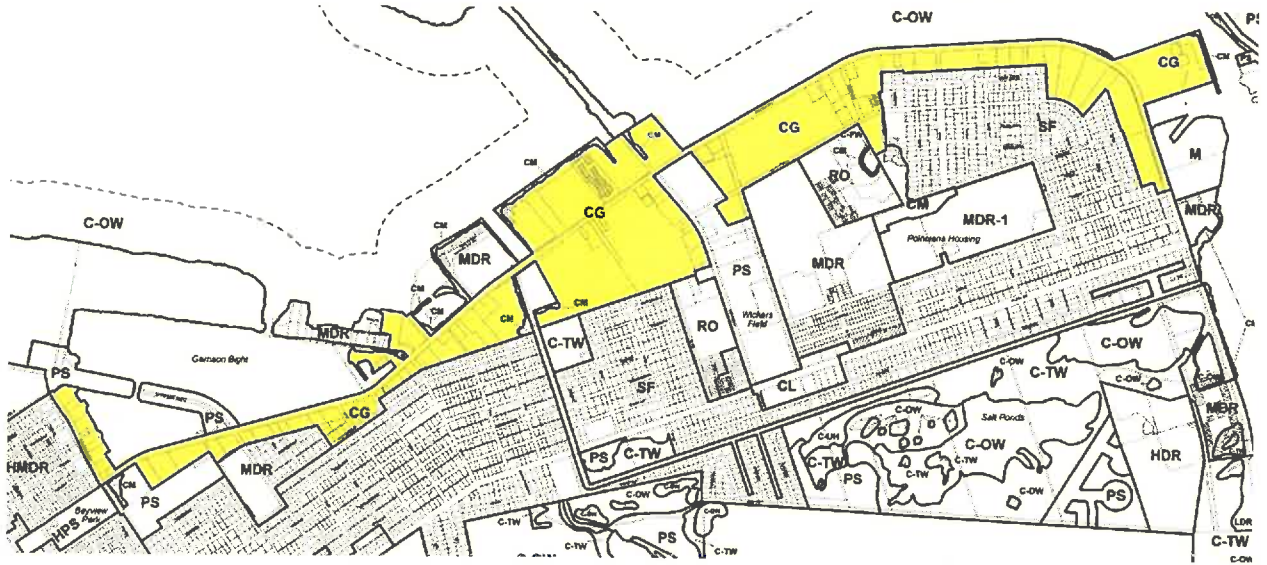

The only change proposed is to one portion of Table 1-1.1.5 regarding the General Commercial (CG) Zoning District. Proposed text additions in blue and deletions are in red and struck-through and text in black font is already existing and not proposed to be amended:

Table 1-1.1.5

\*\*\*

COMMERCIAL FUTURE LAND USE DISTRICT			
Zoning District	Density	Intensity	Uses & Limitations
(CT) Salt Pond Commercial Tourist	Maximum of 16 dwelling units per acre.*	Maximum FAR of 0.8	Allowable uses in areas zoned CT are motels, limited scale tourist facilities, customary accessory uses, and requisite community facilities including public schools.
(CG) General Commercial	Maximum of 16 dwelling units per acre.*	Maximum FAR of 1.0 <del>0.8</del>	Allowable commercial uses in areas zoned GC inclusive of, but not limited to, general retail sales and services, highway oriented sales and services, other general commercial activities, customary accessory uses, and requisite community facilities including public schools. Residential uses are allowed and encouraged in the (CG) General Commercial Zoning

			District if in conformance with Policy 1-1.1.4 with a *density bonus allowing up to 40 dwelling units per acre with the provision of deed restricted affordable housing in conformance with Policy 3-1.1.7. Density bonuses are solely for affordable housing. Market rate housing will be restricted to the maximum of 16 dwelling units per acre.
(CL) Limited Commercial	Maximum of 16 dwelling units per acre.*	Maximum FAR of 0.8	Allowable commercial uses in areas zoned CL include but are not limited to low to medium intensity retail; small limited item shops and customary accessory uses, and requisite community facilities including public schools.

\*\*\*

The following criteria for approval of Comp Plan Amendments are listed in Section 90-555 of the City of Key West Code of Ordinances:

**(1) Consistency with plan. Whether the proposal is consistent with the comprehensive plan, including the adopted infrastructure minimum levels of service standards and the concurrency management program.**

The following is provided as support for consistency with the Comp Plan:

**Portion of Table 1-1.1.5 regarding the CG District:**

**Allowable commercial uses in areas zoned GC inclusive of, but not limited to, general retail sales and services, highway oriented sales and services, other general commercial activities, customary accessory uses, and requisite community facilities including public schools. Residential uses are allowed and encouraged in the (CG) General Commercial Zoning District if in conformance with Policy 1-1.1.4 with a \*density bonus allowing up to 40 dwelling units per acre with the provision of deed restricted affordable housing in conformance with Policy 3-1.1.7. Density bonuses are solely for affordable housing. Market rate housing will be restricted to the maximum of 16 dwelling units per acre.**

- The proposal to increase maximum FAR would lead to more affordable housing encouraged and allowed in the District. A higher FAR will make possible mixed-use developments that generally provide affordable residential units on the elevated stories and low intensity commercial services or retail that are compatible with residential uses on the ground floor. A higher FAR will allow property owners in the District to utilize the density bonus for affordable housing.

**Policy 1-1.1.4: - Affordable Housing and Compact Development Incentives.**

Within land use categories supporting mixed use development, the Land Development Regulations shall include density and intensity bonuses that fall within the parameters of the Comprehensive Plan and Future Land Use Map to achieve the following objectives: *provision of affordable housing immediately adjacent to employment opportunities; reduction in dependence on automobile travel for home/work travel; provision of a range of housing types, inclusive of apartments, townhouses, efficiencies, and single room occupancies; establishment of a variety of retail uses to support onsite or adjacent residential uses; provision of sufficient density of residential uses and presence of retail commercial to support transit demand; support of redevelopment of aging, traditional suburban shopping center retail; provision of open space and recreational uses within or immediately adjacent to the mixed use complex; provision of immediate access to and support of bicycle path networks in the City; increased efficiency of energy and water use; increased solid waste diversion; increased stormwater harvesting; decreased inappropriate water use, and; creation of opportunities to provide substantial new landscaping, parking and housing/retail areas to reduce carbon footprints and support sustainability goals.*

- The proposal will increase mixed-use development placing commercial uses proximate to a variety of residences.
- The proposal will encourage property owners to utilize existing density bonus.
- An increased FAR in the District will support the redevelopment of aging and under-utilized traditional suburban shopping center retail in the District, as encouraged by this Policy.

**GOAL 1-1: - ENSURE THAT THE CHARACTER AND LOCATION OF LAND USES INCORPORATE BEST MANAGEMENT PRACTICES AND PRINCIPLES OF RESOURCE CONSERVATION; ENHANCE COMMUNITY APPEARANCES; PROMOTE ORDERLY LAND USE TRANSITION, AND; MINIMIZE THREATS TO HEALTH, SAFETY, AND WELFARE WHICH MAY BE CAUSED BY INCOMPATIBLE LAND USES, ENVIRONMENTAL DEGRADATION, HAZARDS AND NUISANCES.**

- An increase in FAR in the District will enhance community appearances and promote orderly land use transition by encouraging redevelopment that will bring many existing nonconforming developments into compliance with City of Key West Land Development Regulations ("LDRs") and defend against rising sea-levels.
- Increasing the maximum FAR does not alter other requirements in the LDRs such as minimum open space, maximum impervious surface, maximum building coverage, landscaping, draining or setbacks. Instead, an increased FAR tends to encourage two- or three-story mixed-use developments that have a smaller bottom floor footprint and more open space.

**Policy 1-1.2.1: - Provide Access to Goods and Services and Protect Residential Areas from the Adverse Impacts of Transition in Land Use.**

Stable residential areas and projected future residential areas as delineated on the Future Land Use Map shall be protected from encroachment by incompatible development. This objective does not preclude necessary community facilities from locating within residential areas when

such activities satisfy established criteria of this plan and the City's Land Development Regulations.

Any potential adverse impacts caused by different land uses located adjacent to each other shall be minimized by landscaping, including vegetated berms with tree canopy where practical, or by other appropriate screening and buffering techniques. These landscaping techniques shall be incorporated into the design of new or redeveloping nonresidential projects located adjacent to existing or planned residential development.

Similarly, perimeter landscaping techniques shall be applied in multiple family residential developments in order to appropriately screen and buffer existing and planned single family home sites from residential development having differing structure types.

Land Development Regulations shall maintain and continue to update standards and/or review criteria for mandating retention of open space and for regulating building design, including setbacks, building placement on site, and building orientation. These provisions shall be directed toward protecting privacy, as well as access to light, air and open space. Other reasonable design principles shall be included in the zoning code in order to alleviate adverse impacts of potentially incompatible land uses.

- The proposal will encourage mixed-use developments that will provide goods and services aimed toward residents and tourists and decrease the amount of goods and services aimed primarily for tourists. Many high intensity, high volume uses that may be harmful or disturbing to residential uses do not require a lot of floor area and therefore become relatively more viable than high floor area, low volume uses that mesh well with residential uses.
- An increased FAR will promote redevelopment that will come into compliance with the LDRs providing landscaping and buffering that current legal nonconforming uses do not provide.

**OBJECTIVE 1-1.3: - ALLOCATING COMMERCIAL DEVELOPMENT.**

Land area shall be designated to accommodate a variety of commercial uses. The City shall promote the image, function, architecture, and ambiance of the Historic Preservation Commercial Core District as the City's center for commerce as well as civic and cultural enrichment. In this pursuit the City shall preserve and enhance the identity, design, and vitality of the District.

The management of development and redevelopment activities shall promote preservation of the historic resources of the Historic Preservation Commercial Core District and ensure that new structures are compatible with the built environment. *Along the North Roosevelt commercial corridor, the City shall promote redevelopment of mixed use and general commercial activities which fulfill market demands of the City's residents for affordable housing proximate to retail sales and services.* The existing limited commercial area shall also be maintained for neighborhood commercial activities to meet consumer demands of residents within the areas.

- Almost the entire CG District is along the North Roosevelt commercial corridor and the proposal to increase maximum FAR will encourage redevelopment of mixed use and general commercial activities which fulfill market demands of the City's residents for affordable housing near commercial retail and services.

**Policy 1-1.3.2: - Designate Various Types of Mixed Use Commercial Nodes to Accommodate Diverse Commercial Uses.**

**A variety of commercial development designations shall be provided in order to adequately ensure availability of sites that accommodate the varied site and spatial requirements for such activities as: professional and business offices, limited commercial activities, and general retail sales and services. *In addition, it is the intent of the City of Key West to encourage mixed use residential and commercial developments which include residential uses with particular emphasis on the provision of affordable housing.***

- Increasing the maximum FAR will implement this policy and encourage mixed use residential and commercial developments and, together with other affordable housing incentives, will encourage providing affordable housing in the District, as specifically encouraged in this Policy.

**Policy 1-1.4.6: - Increase Resilience of General Landscaping.**

**The City shall use best available science and predictions for sea level rise and other climate change related issues to guide the long term health and appearance of landscape plantings. By 2014 the City shall work with sea level rise and native plant experts to create a "Climate Adaptation Planting Plan" ordinance to affect landscaping plans. This plan shall be reviewed every other year to stay up to date with climate change predictions.**

- Redevelopment of aging properties will include conformance with building code, flood protection regulations and landscaping requirements, which would make the new developments more safe, sustainable, and good looking.

**OBJECTIVE 1-1.5: - PROMOTE COMMUNITY APPEARANCE, NATURAL AMENITIES AND URBAN DESIGN PRINCIPLES.**

**The City's built environment should reflect Key West's values, architectural history, and characteristic mix of uses. The City shall establish and maintain a level of design excellence in accordance with Goal 2 of the 2011 Strategic Plan.**

- Increasing maximum FAR and encouraging redevelopment will enhance community appearance and implement modern urban design principles.

**Policy 1-1.5.1: - Reinforce and Enhance the City's Community Appearance.**

**Major attributes shall be preserved through application of design review standards and management of signs, landscaping, open space, tree protection, and other urban design amenities. Special emphasis shall be placed on preserving and/or improving the character of major natural and man-made corridors, including the waterfront shoreline, scenic views of the waterfront and tidal waters, wetlands, major drainage corridors, and major transportation corridors which serve as a focal point for the motoring public.**

- This proposal does not propose any changes to landscaping or open space requirements of the Land Development Regulations. Instead, property owners with existing nonconformities who redevelop will be subject to current Land Development Regulations leading to more native landscaping and open space.

**Policy 1-1.11.4: - Managing Stormwater Run-off.**

**The developer/owner of any site shall be responsible for managing on-site run-off. All new development shall comply with adopted level of service standards for surface water management which shall include stormwater harvesting goals.**

- Much of the District's parcels are entirely paved. Redevelopment will implement current onsite storm water retention requirements.

**OBJECTIVE 1-1.12: - CONSIDER APPLICATION OF INNOVATIVE LAND AND WATER RESOURCE MANAGEMENT, CLIMATE ADAPTATION, AND ENERGY CONSERVATION CONCEPTS.**

**The City of Key West shall maintain Land Development Regulations which incorporate concepts for managing land, water, and energy resources which are responsive to unique development and conservation issues identified in the City's Comprehensive Plan. The City of Key West shall adopt Land Development Regulations which incorporate concepts for managing land, water, and the built environment which are responsive to climate change issues including but not limited to sea level rise and increased frequency of intense rainfall events.**

- Redevelopment encouraged by the proposal would impose FEMA regulations requiring raised structures or floodproofing, making the new development more resilient to storms and climate change. Any new development would also be made to comply with concepts in the Land Development Regulations regarding managing water, energy, and landscaping.

**GOAL 5-1: - COASTAL MANAGEMENT.**

**Restrict development activities that would damage or destroy coastal resources. Protect human life and limit public expenditures in areas subject to destruction by natural disasters, but encourage policies which attract pedestrians, increase waterfront access, and reinforce the ambiance of the waterfront.**

- New development would conform to current storm and climate change mitigation regulations, which could protect human life and limit public expenditures.

\*\*\*

**(2) *Conformance with requirements.* Whether the proposal is in conformance with all applicable requirements of the Code of Ordinances.**

The proposed amendment is in conformance with all applicable requirements of the Code of Ordinances.

**(3) *Changed conditions.* Whether, and the extent to which, land use and development conditions have changed since the effective date of the existing regulations, and whether such changes support or work against the proposed rezoning.**

The current conditions in the District support the proposal and conditions have changed since the current Comp Plan effective date. There are now several aging commercial buildings in the



District that are unoccupied and out of business. Additionally, many businesses in the District have become tourist-centered and increasing FAR would pave the way for more businesses to serve the residents of the City of Key West and the Lower Keys. The proposal will encourage redevelopment supported by the Comp Plan Goals, Objectives and Policies, as detailed in Section (1).

**(4) *Land use compatibility.* Whether, and the extent to which, the proposal would result in any incompatible land uses, considering the type and location of uses involved.**

The proposal would not change the uses allowed in the District. The proposal would encourage uses promoted by the existing Comp Plan.

**(5) *Adequate public facilities.* Whether, and the extent to which, the proposal would result in demands on public facilities and services, exceeding the capacity of such facilities and services, existing or programmed, including transportation, water and wastewater services, solid waste disposal, drainage, recreation, education, emergency services, and similar necessary facilities and services. Approval of a plan amendment does not constitute a concurrency determination, and the applicant will be required to obtain a concurrency determination pursuant to [chapter 94](#).**

The proposal would not result in demands on public facilities and services beyond those that would be required to be provided by any property owner. Any development proposed would be required to be in compliance with the Land Development Regulations before being permitted.

**(6) *Natural environment.* Whether, and to the extent to which, the proposal would result in adverse impacts on the natural environment, including consideration of wetlands protection, preservation of groundwater aquifer, wildlife habitats, and vegetative communities.**

The proposal would not result in adverse impacts. The proposal would have favorable impacts on the natural environment and vegetative communities because any new project would come into compliance with the Land Development Regulations whereas the current state of many properties in the District are nearly entirely impervious and non-vegetative.

**(7) *Economic effects.* Whether, and the extent to which, the proposal would adversely affect the property values in the area or the general welfare.**

The proposal would have favorable impacts on the property values and general welfare of those in the area. The proposal would enhance the appearance of the area and provide needed services to residents, as well as provide jobs, stimulate the economy and increase City revenues. Additionally, the proposal would encourage the development of more affordable housing proximate to employment opportunities. The current high-volume uses encouraged with a lower maximum FAR may diminish the general welfare and property values in the area.

**(8) *Orderly development.* Whether the proposal would result in an orderly and compatible land use pattern. Any negative effects on such pattern shall be identified.**

The proposal would result in orderly and compatible land use pattern encouraged in the current Comp Plan. No negative effects of the proposal are anticipated.

**(9) *Public interest; enabling act.* Whether the proposal would be in conflict with the public interest, and whether it is in harmony with the purpose and interest of the land development regulations in this subpart B and the enabling legislation.**

The proposal would promote the public interest and would be in harmony with the purpose and interest of the LDRs and the enabling legislation.

**(10) *Other matters.* Other matters which the planning board and the city commission may deem appropriate.**

Applicant is willing and would diligently work with the planning board and the city commission on any concerns they have with the proposal. Applicant is accepting of and invites any suggestions from the City.

Please use this letter to supplement and amend the Original Application. Thank you for your consideration and work on this matter.

Sincerely,

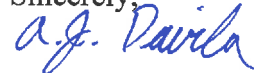
  
Anthony Davila for  
Barton W. Smith

CC: Daniel Sobczak – [daniel.sobczak@cityofkeywest-fl.gov](mailto:daniel.sobczak@cityofkeywest-fl.gov)  
George Wallace – [gwallace@cityofkeywest-fl.gov](mailto:gwallace@cityofkeywest-fl.gov)

The proposal would result in orderly and compatible land use pattern encouraged in the current Comp Plan. No negative effects of the proposal are anticipated.

**(9) *Public interest; enabling act.* Whether the proposal would be in conflict with the public interest, and whether it is in harmony with the purpose and interest of the land development regulations in this subpart B and the enabling legislation.**

The proposal would promote the public interest and would be in harmony with the purpose and interest of the LDRs and the enabling legislation.

**(10) *Other matters.* Other matters which the planning board and the city commission may deem appropriate.**

Applicant is willing and would diligently work with the planning board and the city commission on any concerns they have with the proposal. Applicant is accepting of and invites any suggestions from the City.

Please use this letter to supplement and amend the Original Application. Thank you for your consideration and work on this matter.

Sincerely,

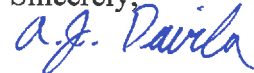
  
Anthony Davila for  
Barton W. Smith

CC: Daniel Sobczak – [daniel.sobczak@cityofkeywest-fl.gov](mailto:daniel.sobczak@cityofkeywest-fl.gov)  
George Wallace – [gwallace@cityofkeywest-fl.gov](mailto:gwallace@cityofkeywest-fl.gov)

# **Verification Form**

City of Key West  
Planning Department



Verification Form  
(Where Authorized Representative is an Entity)

I, Jonathan Dorman, in my capacity as Manager  
*(print name)* *(print position: president, managing member)*  
of StorCon Development, LLC  
*(print name of entity serving as Authorized Representative)*

being duly sworn, depose and say that I am the Authorized Representative of the Owner (as appears on the deed), for the following property identified as the subject matter of this application:

1900 N. Roosevelt Blvd., Key West, FL 33040

*Street Address of subject property*

All of the answers to the above questions, drawings, plans and any other attached data which make up the application, are true and correct to the best of my knowledge and belief. In the event the City or the Planning Department relies on any representation herein which proves to be untrue or incorrect, any action or approval based on said representation shall be subject to revocation.



*Signature of Authorized Representative*

Subscribed and sworn to (or affirmed) before me on this 12 day of March 2021  
*date*

Jonathan Dorman  
*Name of Authorized Representative*

He/She is personally known to me or has presented His Driver's License as identification.



*Notary's Signature and Seal*

GINA GALARZA  
*Name of Acknowledger typed, printed or stamped*

GG 140863

*Commission Number, if any*

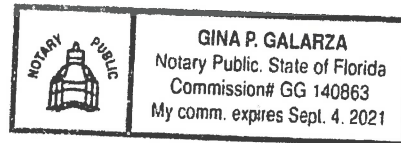

City of Key West  
Planning Department



Verification Form  
(Where Authorized Representative is an Entity)

I, Jonathan Dorman, in my capacity as Manager  
*(print name)* *(print position: president, managing member)*  
of StorCon Development, LLC  
*(print name of entity serving as Authorized Representative)*

being duly sworn, depose and say that I am the Authorized Representative of the Owner (as appears on the deed), for the following property identified as the subject matter of this application:

1910 N. Roosevelt Blvd., Key West, FL 33040

*Street Address of subject property*

All of the answers to the above questions, drawings, plans and any other attached data which make up the application, are true and correct to the best of my knowledge and belief. In the event the City or the Planning Department relies on any representation herein which proves to be untrue or incorrect, any action or approval based on said representation shall be subject to revocation.

*Signature of Authorized Representative*

Subscribed and sworn to (or affirmed) before me on this 12 day of March 2020 by  
Jonathan Dorman  
*Name of Authorized Representative*

He/She is personally known to me or has presented FL Drivers License as identification.

*Notary's Signature and Seal*

GINA GALARZA  
*Name of Acknowledger typed, printed or stamped*

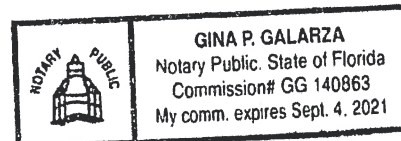

GG 140863  
*Commission Number, if any*

# **Authorization Form**

City of Key West  
Planning Department



Authorization Form  
(Where Owner is a Business Entity)

Please complete this form if someone other than the owner is representing the property owner in this matter.

I, Dennis Saviano as  
*Please Print Name of person with authority to execute documents on behalf of entity*

Trustee of Dennis Saviano Living Trust  
*Name of office (President, Managing Member) Name of owner from deed*

authorize Jonathan Dorman  
*Please Print Name of Representative*

to be the representative for this application and act on my/our behalf before the City of Key West.

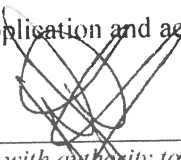
 Trustee  
*Signature of person with authority to execute documents on behalf on entity owner*  
DENNIS SAVIANO

Subscribed and sworn to (or affirmed) before me on this 3-11-20  
*Date*

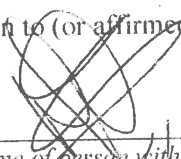
by  Trustee  
*Name of person with authority to execute documents on behalf on entity owner*  
DENNIS SAVIANO

He/She is personally known to me or has presented Florida Driver License as identification.

Brandy Brown  
*Notary's Signature and Seal*

Brandy Brown  
*Name of Acknowledger typed, printed or stamped*

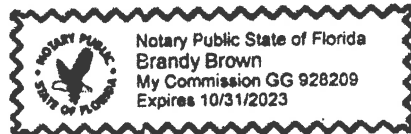

GG 928209  
*Commission Number, if any*



**City of Key West  
Planning Department**



**Authorization Form**  
*(Where Owner is a Business Entity)*

Please complete this form if someone other than the owner is representing the property owner in this matter.

I, Allan Burns as  
*Please Print Name of person with authority to execute documents on behalf of entity*

President of Paradise Petroleum Marketers, Inc  
*Name of office (President, Managing Member)* *Name of owner from deed*

authorize Jonathan Dorman  
*Please Print Name of Representative*

to be the representative for this application and act on my/our behalf before the City of Key West.

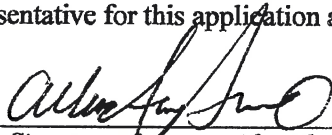
  
\_\_\_\_\_  
*Signature of person with authority to execute documents on behalf on entity owner*

Subscribed and sworn to (or affirmed) before me on this 3-12-2020  
*Date*

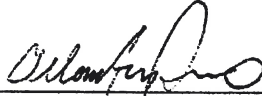
by   
*Name of person with authority to execute documents on behalf on entity owner*

He/She is personally known to me or has presented FLDL as identification.

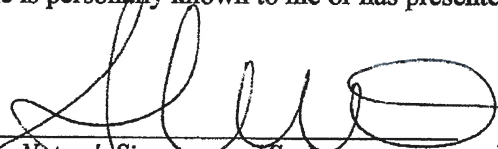
  
\_\_\_\_\_  
*Notary's Signature and Seal*

Sheila Moyer  
*Name of Acknowledger typed, printed or stamped*

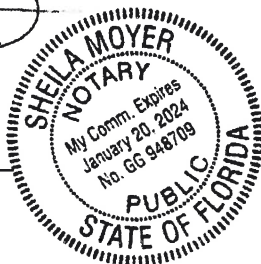

01-20-2024  
*Commission Number, if any*

**Ukg' Rnc p**

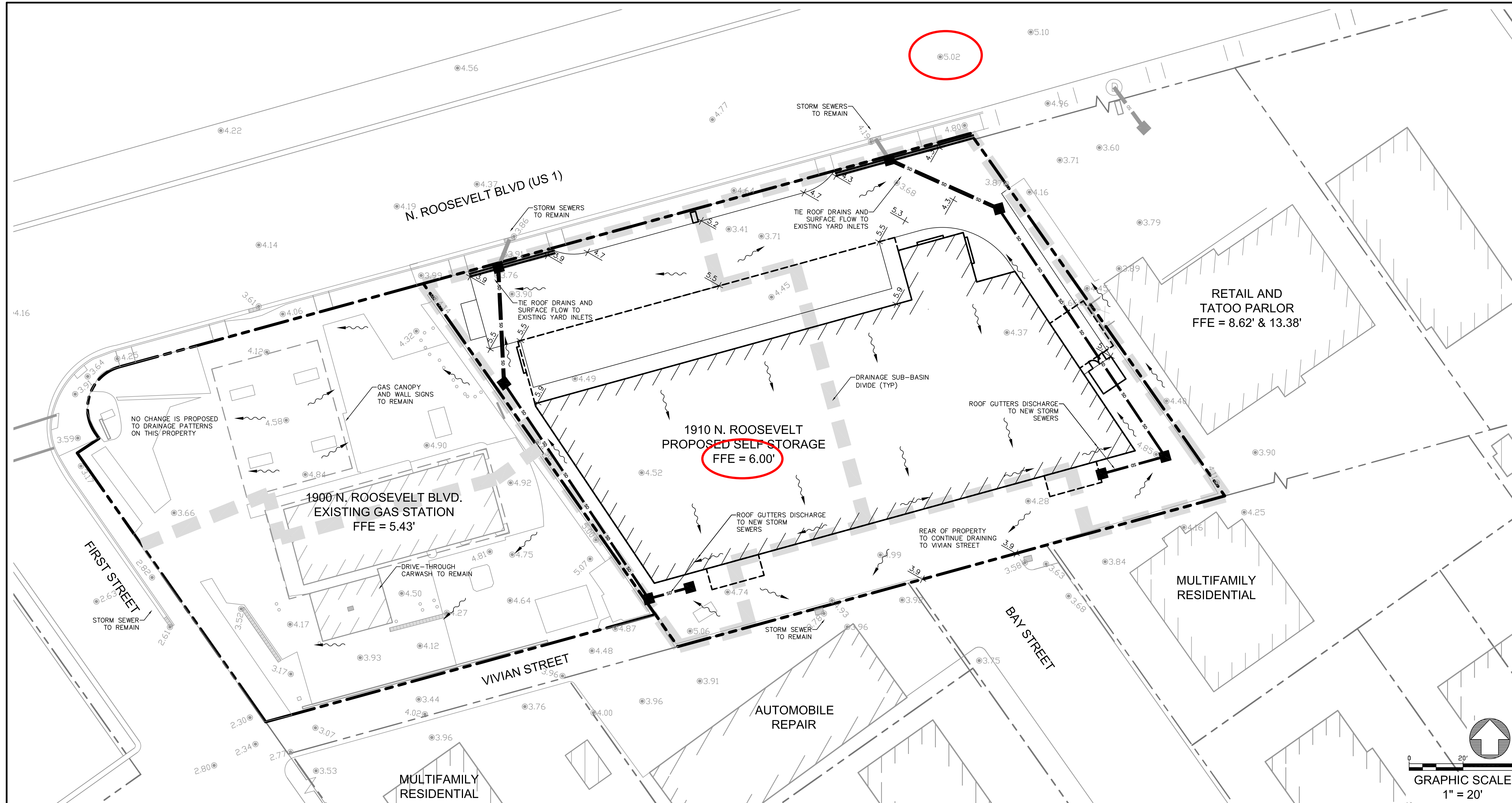

**DRAINAGE NOTES:**

1. NO ADVERSE STORMWATER MANAGEMENT IMPACTS ARE PROPOSED OR ANTICIPATED AS A RESULT OF THIS PROJECT. NO CHANGES ARE PROPOSED TO 1900 N. ROOSEVELT BLVD. IMPERVIOUS AREA WILL BE REDUCED WITH THE REDEVELOPMENT OF 1910 N. ROOSEVELT.
2. ALL EXISTING DRAINAGE PATTERNS ARE PROPOSED TO BE MAINTAINED AS A RESULT OF THIS PROJECT.
2. FEMA FLOOD ZONE: AE (ELEV 7/8 PER FIRM PANEL #12087C1517k (EFF 2/18/2005))
3. THERE ARE NO KNOWN SURFACE WATER FEATURES, ENVIRONMENTALLY SENSITIVE AREAS, OR EXISTING STORMWATER MANAGEMENT DEVICES WITHIN THE PROJECT AREA.
3. THIS PROJECT IS LOCATED WITHIN THE FLOODPLAIN, THE NEW SELF STORAGE STRUCTURE WILL BE FLOODPROOFED BY WAY OF LIMITED GROUND-FLOOR OPENINGS, PROTECTED BY REMOVABLE FLOOD GATES.
4. ELEVATIONS SHOWN ARE BASED ON PRIOR SURVEYS OF 1900 / 1970 N. ROOSEVELT BLVD. AND WILL BE UPDATED UPON COMPLETION OF NEW SURVEY.

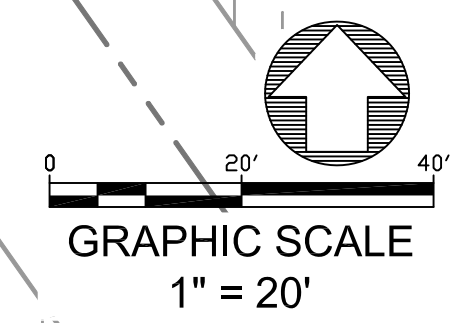

PRELIMINARY  
NOT FOR CONSTRUCTION

DRAINAGE PLAN

MAJOR DEVELOPMENT PLAN  
ROOSEVELT SELF STORAGE

8637 TUTTLE AVE. #412  
SARASOTA, FL 34243  
(813) 310-8520 (PH)  
(813) 746-4863 (FAX)

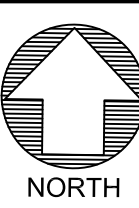

NORTH  
SCALE:  
1" = 20'

DATE:  
07/20/2020

SHEET  
5 OF 6

I, JONATHAN DORMAN, HEREBY CERTIFY AS A LICENSED PROFESSIONAL ENGINEER IN ACCORDANCE WITH FLORIDA STATUTE 471 (481) THAT I HAVE PERFORMED A QUALITY ASSURANCE REVIEW OF THESE PLANS, AND THAT THIS DESIGN, TO THE BEST OF MY KNOWLEDGE, INFORMATION AND BELIEF, WILL MEET APPLICABLE MUNICIPAL AND STATE DESIGN CRITERIA. DATE: JONATHAN M. DORMAN FLORIDA PE NO. 54009



**CONCEPTUAL RENDERING**  
(SUBJECT TO FINAL DESIGN)

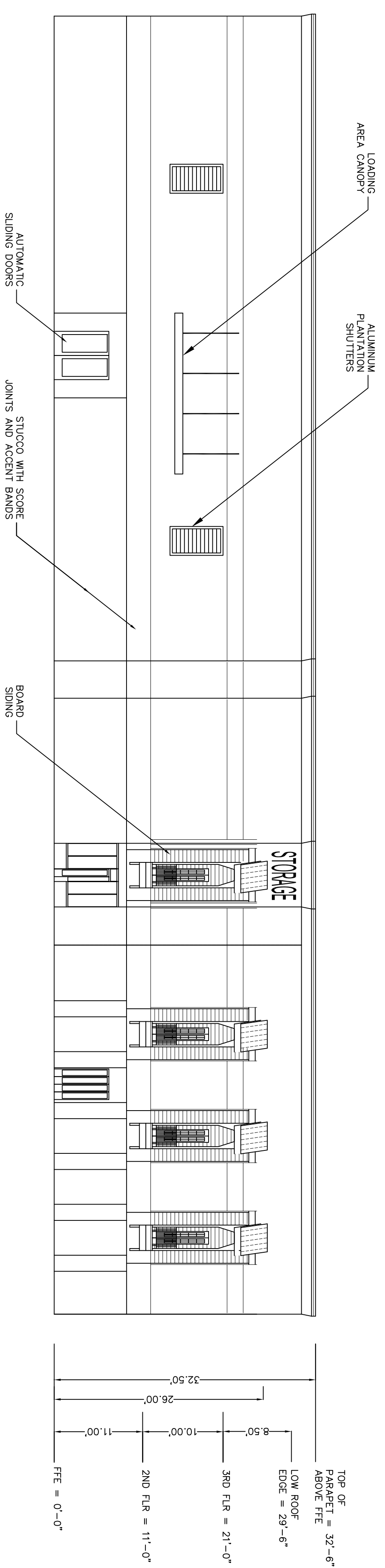

**EAST ELEVATION**  
**FACING 1970 N. ROOSEVELT BLVD.**  
SCALE 1 INCH = 10 FEET  
TYPICAL OF WEST ELEVATION

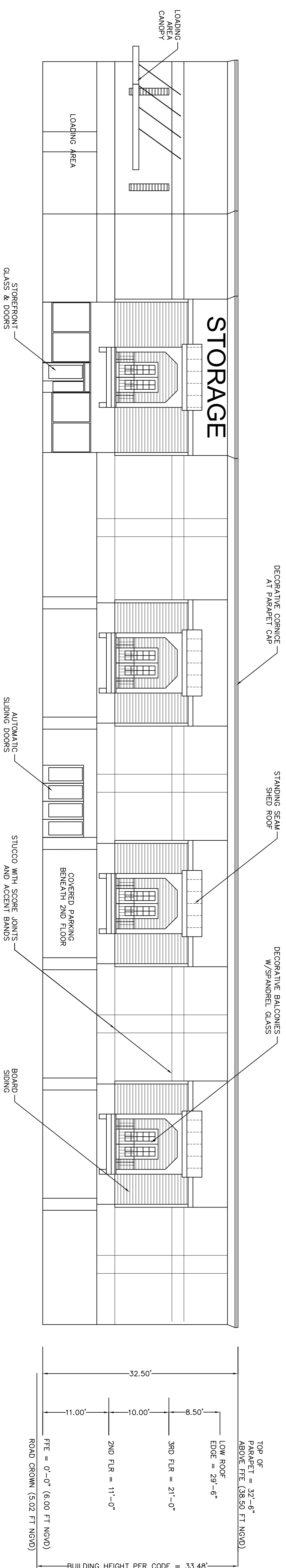

**NORTH ELEVATION**  
**FRONTING N. ROOSEVELT BLVD.**  
SCALE 1 INCH = 10 FEET

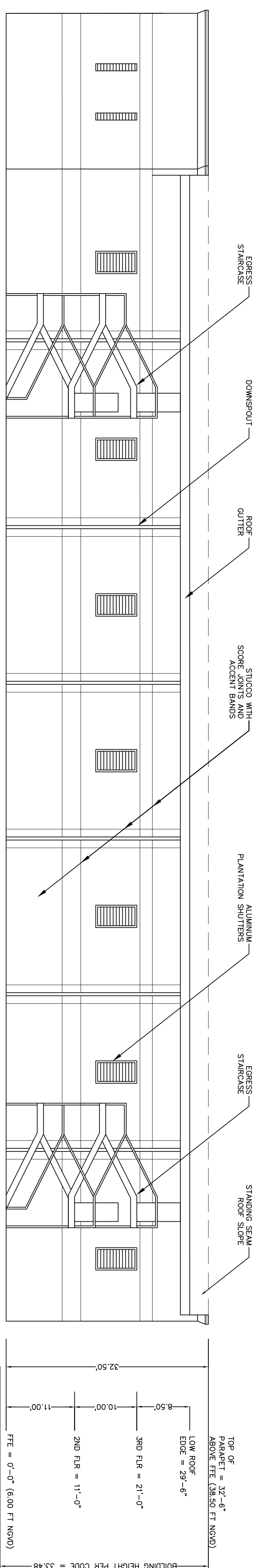

**SOUTH ELEVATION**  
**FACING VIVIAN STREET**  
SCALE 1 INCH = 10 FEET

# **Warranty Deed**

WARRANTY DEED  
INDIVID. TO INDIVID.

Return to: (enclose self-addressed stamped envelope)

Name:

Address:

This Instrument Prepared by:

DIANNE BARLOW  
FIRST TITLE & ABSTRACT  
Address 1010 KENNEDY DRIVE  
KEY WEST, FL 33040  
File No.: 965874-T

Property Appraisers Parcel Identification (Folio) Number(s):

Alternate Key No. 1052469  
Grantee[s] S.S. #[s]:

MONROE COUNTY  
OFFICIAL RECORDS

FILE # 970649  
BK# 1426 PG# 16

RCD Oct 15 1996 09:00AM  
DANNY L KOLHAGE, CLERK

DEED DOC STAMPS 7280.00  
10/15/1996 DEP CLK

SPACE ABOVE THIS LINE FOR PROCESSING DATA

SPACE ABOVE THIS LINE FOR RECORDING DATA

This Warranty Deed Made the 10th day of OCTOBER A.D. 19 96 by

HISTORIC TOURS OF AMERICA, INC., a Florida corporation,  
whose address is 601 Duval Street, Suite 5, Key West, FL 33040

hereinafter called the grantor, to DENNIS P. SAVIANO, a married man,  
whose post office address is: 23040 Ardmore Park Drive, St. Claire Shores, MI 48081  
hereinafter called the grantee:

(Wherever used herein the terms "grantor" and "grantee" include all the parties to this instrument and the heirs, legal representatives and assigns of individuals, and the successors and assigns of corporations)

**Witnesseth:** That the grantor, for and in consideration of the sum of \$10.00 and other valuable considerations, receipt whereof is hereby acknowledged, hereby grants, bargains, sells, aliens, remises, releases, conveys and confirms unto the grantee all that certain land situate in Monroe County, State of Florida, viz:

On the Island of Key West, Monroe County, Florida, and known as the Easterly 59.69 feet of Lot 1, all of Lot 2, and the Westerly 70.31 feet of Lot 3, Block 6, SUNSHINE SUBDIVISION Plat No. 3, according to the Plat thereof recorded in Plat Book 2, at Page 169, of the Public Records of Monroe County, Florida.

SUBJECT TO taxes for the year 1996 and subsequent years.  
SUBJECT TO easements, restrictions and reservations of record, but this reference thereto shall not operate to reimpose same.

Together, with all the tenements, hereditaments and appurtenances thereto belonging or in anywise appertaining.

To Have and to Hold, the same in fee simple forever.

And the grantor hereby covenants with said grantee that the grantor is lawfully seized of said land in fee simple; that the grantor has good right and lawful authority to sell and convey said land, and hereby warrants the title to said land and will defend the same against the lawful claims of all persons whomsoever; and that said land is free to all encumbrances, except taxes accruing subsequent to December 31, 1995.

In Witness Whereof, the said grantor has signed and sealed these presents the day and year first above written.

Signed, sealed and delivered in the presence of:

Michelle I. Cates  
Witness Signature  
Michelle I. Cates  
Printed Witness Name  
Dianne Barlow  
Witness Signature  
Dianne Barlow  
Printed Witness Name

HISTORIC TOURS OF AMERICA, INC.  
Michael H. Cates, a/k/a Michael Cates, Vice President  
Michael H. Cates, a/k/a Michael Cates, Vice President

STATE OF FLORIDA )  
COUNTY OF MONROE )

MONROE COUNTY  
OFFICIAL RECORDS

I HEREBY CERTIFY that on this day, before me, an officer duly authorized to administer oaths and take acknowledgments, personally appeared MICHAEL H. CATES, a/k/a MICHAEL CATES, Vice President, and

of HISTORIC TOURS OF AMERICA, INC., a Florida corporation, known to me to be the person described in and who executed the foregoing instrument, who acknowledged before me that executed the same, that I relied upon the following form of identification of the above-named person:

NOTARY RUBBER STAMP SEAL



Witness my hand and official seal in the County and State last aforesaid this 10th day of October, A.D. 19 96

Notary Signature

Dianne Barlow

765090

OFF REC 1239 PAGE 0450

200  
12/29/92  
2846-20

WHEN RECORDED MAIL TO:  
Nicholas H. Hagoort, Jr., P.A.  
Woolbright Corporate Center  
1901 S. Congress Ave., Suite 360  
Boynton Beach, Florida 33426

DAVID L. HARRIS  
115 S. MONROE ST.  
MONROE, LOUISIANA 70002

92 DEC 29 P 3:50

FILED FOR RECORD

**DEED**

KNOW ALL MEN BY THESE PRESENTS:

That, **SERVICE STATION HOLDINGS INC.** (successor in interest to Service Station Realty Inc.), a Delaware corporation with its principal office at 200 Public Square, Cleveland, Ohio 44114- 2375 ("Grantor"), for Four Hundred Six Thousand, Five Hundred Fourteen Dollars (\$406,514.00) and other good and valuable consideration received to its full satisfaction of **PARADISE PETROLEUM MARKETERS INC.**, a Florida corporation, whose tax mailing address is RR #S Box 119 J, Lobstertail Rd., Big Pine Key, Florida 33043 ("Grantee"), and pursuant to that certain Agreement of Purchase and Sale between Grantor and Grantee dated November 11, 1992 ("Agreement"), does hereby grant, bargain, sell and convey unto Grantee, and its heirs, devisees, legal representatives, successors and assigns, as the case may be, that certain real property (hereinafter called the "Premises") located at First Street & North Roosevelt Boulevard in the City of Key West, County of Monroe, and State of Florida, and being the same real property conveyed to Grantor by deed recorded in Official Records Book 1115, Page 1989 of the public records of said County, as more fully described in Exhibit A attached hereto and made a part hereof.

Excepting therefrom all buildings, structures and improvements of any kind (whether or not classified as real property) and all personal property of whatsoever nature located on the Premises, which buildings, structures and improvements are being simultaneously conveyed to Grantee by bill of sale from BP Exploration & Oil Inc., the owner thereof ("BP").

TO HAVE AND TO HOLD the above granted and bargained Premises with the easements and rights appurtenant thereunto belonging, unto Grantee and the heirs, devisees, legal representatives, successors and assigns of Grantee, as the case may be, forever, SUBJECT, however, to all legal highways, and to the terms, conditions and restrictions herein contained, and to all liens, encumbrances and claims of every kind and nature caused, created or suffered to exist or be attached upon, against or to the Premises by anyone other than the Grantor, and subject to: (a) real estate taxes and assessments, both general and special, not then due and payable; (b) building and zoning ordinances, laws, regulations and restrictions by municipal or other governmental authorities; (c) any and all leases, easements, rights-of-way, encumbrances, reservations and exceptions of

DS Paid 2846.00 Date 12-29-92  
MONROE COUNTY  
DANNY L. IORRAGE, CLERK, CR. CT.  
By [Signature]

record; and (d) any state of facts that an accurate survey and independent inspection of the Premises by Grantee or its agents would disclose. Unless otherwise defined herein, all terms defined in the Agreement shall have the same meaning herein.

BP has reserved, for itself, its employees, contractors, agents, representatives and licensees, access to the Premises for the purpose of testing, assessing, and if necessary, remediating the Premises ("Access"), in accordance with the terms of Section 10.01 of the Agreement. During BP's Access, Grantee shall not be permitted to engage in the construction or relocation of any improvements on the Premises, or other development activity on the Premises, or any change in use of the Premises, unless and until BP has approved the plans, specifications, drawings and cost estimates therefor. In addition, during BP's Access, Grantee shall not convey to any third party any interest in the Premises, or, if Grantee shall be a corporation or partnership, Grantee shall not convey any interest in the corporation or partnership, unless and until certain conditions specified in Section 10.01 of the Agreement are met.

Except as provided in Section 10.01 of the Agreement, Grantee does hereby assume and agree to be responsible for, does hereby waive, release and discharge, and shall defend, indemnify and hold harmless Grantor and BP, and the parents, subsidiaries and affiliates of Grantor and BP, and their respective directors, officers, partners, employees, contractors, agents, representatives, successors and assigns, from and against any and all claims, demands, damages, losses, costs and expenses, attorney's fees, court costs, awards, settlements, judgments, penalties, fines, liens, actions or causes of action at law or in equity, including without limitation actions under the Comprehensive Environmental Response, Compensation and Liability Act of 1980, 42 U.S.C. 9601, et seq., as amended, the Resource Conservation and Recovery Act, 42 U.S.C. 6901, et seq., and any other applicable environmental laws, statutes, ordinances, rules, regulations or orders ("Laws"), arising out of or relating to the environmental and/or physical condition of the Premises or other property abandoned thereon by Grantor or BP or arising out of or relating to the ownership or use of the Premises after Closing.

Notwithstanding anything to the contrary contained herein, in the event that, after Closing, any governmental agency, entity, body, instrumentality, department or representative ("Government") shall notify Grantor or BP that Grantor or BP must undertake on the Premises any testing, investigation and/or remediation of flammable explosives, hydrocarbons and/or petroleum products or fractions thereof, radioactive materials, hazardous or toxic wastes, substances or materials, including but not limited to those materials and substances defined as "hazardous substances", "hazardous materials", "hazardous wastes" or "toxic substances" in the Laws ("Hazardous Materials"), then Grantor or BP shall



765090

DEF 1239 PAGE 452  
REC

immediately notify Grantee of same, Grantee shall promptly undertake the same, and Grantee shall immediately notify the Government that Grantee shall respond to such notice in the place of Grantor or BP. After such notice from Grantor or BP, in the event: (i) Grantee fails to timely or properly undertake and pursue the required testing, investigation and/or remediation of the Hazardous Materials, or (ii) the Government insists that Grantor or BP, not Grantee, undertake or pursue the required testing, investigation and/or remediation of the Hazardous Materials; then, and only in the event of (i) or (ii), and under no other circumstances Grantor or BP shall have the right and authority, without trespass, to enter the Premises and to conduct the required testing, investigation and/or remediation of the Hazardous Materials. Grantor's or BP's entry on the Premises and activities thereon shall not be deemed an admission of liability for such Hazardous Materials. While on the Premises, Grantor and BP shall have the right to install, maintain, operate, store, use and remove equipment, including but not limited to monitoring wells, recovery wells and other assessment or remediation equipment, to remove, remediate, store and test soils and groundwater therefrom and thereon and to otherwise take all actions required to comply with the Laws. Grantor and BP shall exercise its right of entry onto the Premises in a manner which does not unreasonably interfere with the Present Primary Use thereof by Grantee. Grantee shall not interfere with Grantor's or BP's right of entry, or actions taken pursuant thereto, and shall cooperate with Grantor and BP in obtaining any permits, consents or approvals necessary for Grantor's or BP's actions taken with respect to the Premises.

Grantor warrants and will defend its title to the Premises against all lawful claims and demands made against said title by all persons claiming by, from, through or under Grantor, except as above noted.

Grantee represents and warrants that it is familiar with the condition of the Premises and that, except for the foregoing limited warranty of title by Grantor, GRANTOR HAS NOT MADE AND MAKES NO WARRANTIES OR REPRESENTATIONS REGARDING THE PREMISES, EXPRESS OR IMPLIED, INCLUDING WITHOUT LIMITATION, ITS HABITABILITY, CONDITION OR FITNESS FOR ANY PARTICULAR USE OR PURPOSE. GRANTEE AGREES THAT THE PREMISES IS HEREBY CONVEYED BY GRANTOR AND ACCEPTED BY GRANTEE IN ITS "AS-IS, WHERE-IS" CONDITION.

Grantee's acceptance of the terms and provisions of this Deed shall be indicated by its recording of this Deed or its entry upon or use of the Premises. The terms and provisions of this Deed shall run with the land and shall be binding upon and inure to the benefit of Grantor and its successor and assigns, Grantee and its heirs, devisees, legal representatives, successors and permitted assigns as the case may be, and any other person or entity expressly noted herein.

765090

REF REC 1239 PAGE 453

Service Station Realty Inc. merged into Service Station Holdings Inc. on December 31, 1990. Service Station Holdings Inc. qualified to transact business in the State of Florida on December 27, 1990.

IN WITNESS WHEREOF, SERVICE STATION HOLDINGS INC. has hereunto set its hand and corporate seal, by its duly authorized officers, this 28th day of December, 1992.

WITNESSES:

SERVICE STATION HOLDINGS INC.

By: Christine E. Lang  
Print: Christine E. Lang

By: B. T. Werner  
B. T. Werner

By: Elaine M. Svatos  
Print: Elaine M. Svatos

Its: Vice President

By: Christine E. Lang  
Print: Christine E. Lang

Attest: J. Shoda  
J. Shoda

By: Elaine M. Svatos  
Print: Elaine M. Svatos

Its: Assistant Secretary



CORPORATE ACKNOWLEDGMENT

STATE OF OHIO )  
COUNTY OF CUYAHOGA ) SS:

BEFORE ME, a Notary Public in and for said County and State, personally appeared the above named SERVICE STATION HOLDINGS INC. an Delaware corporation, by B. T. Werner its Vice President, and J. Shoda, its Assistant Secretary, who acknowledged that they did sign the foregoing instrument and that the same is the free act and deed of said corporation and the free act and deed of each of them personally and as such officers.

IN TESTIMONY WHEREOF, I have hereunto set my hand and official seal at Cleveland, Ohio, this 28th day of December, 1992.

Fredda R. Sharp  
Notary Public **FREDDA R. SHARP**  
Notary Public for State of Ohio  
Commission Expires October 14, 1997

Key West, FL  
BP Site No. 24572

JS6215/frs

This instrument prepared by: 4  
L. M. Wood, Esq.  
BP Exploration & Oil Inc.  
200 Public Square  
Cleveland, Ohio 44114

765090

REC 1239 PAGE 454

City of Key West  
County of Monroe  
State of Florida

Site No. 24572

Exhibit A

A portion of Lot 1, Block 4, of "SUNSHINE SUBDIVISION", according to the plat thereof, as recorded in Plat Book 2 at Page 167, of the Public Records of Monroe County, Florida, being more particularly described as follows:

Commence at the intersection of the Southeastery line of Roosevelt Boulevard and the Northeastery line of First Street; thence S. 66° 00' 00" E. along the Southeastery line of Roosevelt Blvd. for 150.00 feet; thence run S. 43° 49' 35" E. parallel with First Street for 150.00 feet thence S. 66° 00' 00" N. parallel with Roosevelt Blvd. for 150.00 feet to the intersection with the Northeastery line of First Street; thence run N. 43° 49' 35" W. along the Northeastery line of First Street for 150.00 feet to the point of beginning, lying and being situate in the City of Key West, Monroe County, Florida.

RECORDS MEMO.  
LEGIBILITY OF WRITING, TYPING, OR PRINTING WAS  
UNSATISFACTORY ON THIS DOCUMENT WHEN RECEIVED

Recorded in Official Records Book  
In Monroe County, Florida  
Record No. 1104  
DANNY L. KOLMAGE  
Clerk Circuit Court

01-GWD.02 01/01

\$1.00

Doc# 1748177 06/26/2009 11:25AM  
Filed & Recorded in Official Records of  
MONROE COUNTY DANNY L. KOLHAGE

This instrument prepared by,  
or under the direction of,  
Alicia Trujillo, Esq.  
District Six Chief Counsel  
State of Florida  
Department of Transportation  
1000 N.W. 111<sup>th</sup> Avenue  
Miami, Florida 33172  
February 5, 2009 -NE

06/26/2009 11:25AM  
DEED DOC STAMP CL: TRINA \$0.70

Parcel No. : 105.1  
Item/Segment No. : 2505483  
Managing District : 6  
Doc# 1748177  
Bkn 2419 Pg# 1579

**WARRANTY DEED**

THIS WARRANTY DEED, Made this 18<sup>th</sup> day of June, 2009, by **PARADISE PETROLEUM MARKETERS, INC.**, a Florida Corporation, grantor, to the **STATE OF FLORIDA, DEPARTMENT OF TRANSPORTATION**, grantee: (wherever used herein the terms "grantor" and "grantee" include all the parties to this instrument and the heirs, legal representatives and assigns of individuals and the successors, and assigns of organizations).

WITNESSETH: That the grantor, for and in consideration of the sum of \$1.00 and other valuable considerations, receipt and sufficiency being hereby acknowledged, hereby grants, bargains, sells, aliens, remises, releases, conveys and confirms unto the grantee, all that certain land situate in Monroe County, Florida, to-wit:

Parcel 105

FIN. No. 2505483

A portion of Lot 1, Block 6 of Sunshine Subdivision Plat No.3, according to the Plat thereof as recorded in Plat Book 2, at Page 169, of the Public Records of Monroe County, Florida, more particularly described as follows:  
**Beginning** at the Point of intersection of the Northeasterly Right-of-Way line of First Street as shown on said plat of Sunshine Subdivision Plat No.3 and the Existing Southerly Right-of-Way line of State Road No. 5, North Roosevelt Boulevard, as shown on the Florida Department of Transportation Right-of-Way map for State Road No.5, Section 90010; Thence S35°06'58"E, along the Northeasterly Right-of-Way line of First Street, for a distance of 28.32 feet; Thence N56°22'01"E, departing the previously described Right-of-Way line, for a distance of 9.73 feet; Thence N34°57'21"W, for a distance of 2.36 feet to the Point of Curvature of a circular curve concave to the East; Thence Northwesterly, Northerly and Northeasterly, along the arc of said curve to the right, having a radius of 16.00 feet and a central angle of 109°57'56" for a distance of 30.71 feet to the point of cusp, said point also being on the Southerly Right-of-Way line of State Road No. 5, North Roosevelt Boulevard; Thence S74°39'21"W, along the previously described line, for a distance of 33.20 feet to the **Point of Beginning**.

Containing 379 sq.ft, more or less.

TOGETHER with all tenements, hereditaments and appurtenances thereto belonging or in anywise appertaining.

TO HAVE AND TO HOLD, the same in fee simple forever.

AND the grantor hereby covenants with said grantee that the grantor is lawfully seized of said land in fee simple; that the grantor has good right and lawful authority to sell and convey said land; that the grantor hereby fully warrants the title to said land and will defend the same against the lawful claims of all persons whomsoever; and that said land is free of all encumbrances.

IN WITNESS WHEREOF, the grantor has caused these presents to be executed in its name, and its corporate seal to be hereunto affixed, by its proper officers thereunto duly authorized, the day and year first above written.

Signed, sealed and delivered in the presence of:  
(Two witnesses required by Florida Law)

**PARADISE PETROLEUM MARKETERS, INC.**,  
A Florida corporation

By: Alan Burns Pres.  
ALAN BURNS

Alicia Trujillo  
(Signature of Witness)

Billie Jo Donavan  
(Signature of Witness)

PO Box 430663  
316 Pine Hwy, Ft 3301  
ADDRESS

or, ATTEST by: Colleen, Title: Pres

(Affix Corporate Seal)

STATE OF New Jersey

Doc# 1748177  
Bk# 2419 Pg# 1560

COUNTY OF WARREN

The foregoing instrument was acknowledged before me this 18 day of June, 2009  
by ALLAN BURNS of PARADISE PETROLEUM MARKETERS, INC., a  
Florida corporation, on behalf of the corporation. He/she is personally known to me or has produced  
Driver's License as identification.

(Signature of person taking acknowledgment)

Billie Jo Donovan

(Type, print or stamp name under signature)  
Title or rank and serial number, if any

**BILLIE JO DONOVAN**  
**NOTARY PUBLIC OF NEW JERSEY**  
**Commission Expires 6/2/2010**

# **Property Record Card**

**Disclaimer**

The Monroe County Property Appraiser's office maintains data on property within the County solely for the purpose of fulfilling its responsibility to secure a just valuation for ad valorem tax purposes of all property within the County. The Monroe County Property Appraiser's office cannot guarantee its accuracy for any other purpose. Likewise, data provided regarding one tax year may not be applicable in prior or subsequent years. By requesting such data, you hereby understand and agree that the data is intended for ad valorem tax purposes only and should not be relied on for any other purpose.

By continuing into this site you assert that you have read and agree to the above statement.

**Summary**

Parcel ID 00051820-000000  
 Account# 1052442  
 Property ID 1052442  
 Millage Group 10KW  
 Location 1900 N ROOSEVELT Blvd, KEY WEST  
 Address  
 Legal SUNSHINE SUB PLAT NO 3 PB2-169 PT LOT 1 BLK 6 OR45-12/13  
 Description OR933-404/410 OR1115-1989/1991 OR1239-450/58 OR2419-1579/80  
 (Note: Not to be used on legal documents.)  
 Neighborhood 31040  
 Property Class SERVICE STATION (2600)  
 Subdivision Sunshine Subdivision Plat No. 3  
 Sec/Twp/Rng 05/68/25  
 Affordable No  
 Housing



AK1052442 1900 N. ROOSEVELT BLVD. 6/28/2011

**Owner**

PARADISE PETROLEUM MARKETERS INC  
 PO Box 430663  
 Big Pine Key FL 33043

**Valuation**

	2019	2018	2017	2016
+ Market Improvement Value	\$390,633	\$364,340	\$385,159	\$371,515
+ Market Misc Value	\$35,084	\$28,159	\$28,159	\$28,159
+ Market Land Value	\$806,208	\$806,208	\$445,536	\$446,846
= Just Market Value	\$1,231,925	\$1,198,707	\$858,854	\$846,520
= Total Assessed Value	\$1,039,212	\$944,739	\$858,854	\$846,520
- School Exempt Value	\$0	\$0	\$0	\$0
= School Taxable Value	\$1,231,925	\$1,198,707	\$858,854	\$846,520

**Land**

Land Use	Number of Units	Unit Type	Frontage	Depth
COMM DRY HIGHWAY (10DH)	20,800.00	Square Foot	150	150

**Commercial Buildings**

Style 1 STY STORE-A / 11A  
 Gross Sq Ft 5,131  
 Finished Sq Ft 2,828  
 Perimeter 0  
 Stories 3  
 Interior Walls  
 Exterior Walls C.B.S.  
 Quality 400 ()  
 Roof Type  
 Roof Material  
 Exterior Wall1 C.B.S.  
 Exterior Wall2  
 Foundation  
 Interior Finish  
 Ground Floor Area  
 Floor Cover

**Full Bathrooms** 2  
**Half Bathrooms** 0  
**Heating Type**  
**Year Built** 1960  
**Year Remodeled**  
**Effective Year Built** 1995  
**Condition**

Code	Description	Sketch Area	Finished Area	Perimeter
CAD	DETACHED CAN	2,050	0	0
FLA	FLOOR LIV AREA	2,828	2,828	0
OPF	OP PRCH FIN LL	253	0	0
TOTAL		5,131	2,828	0

### Yard Items

Description	Year Built	Roll Year	Quantity	Units	Grade
RW2	1959	1960	1	130 SF	4
ASPHALT PAVING	1975	1976	1	6183 SF	2
CONC PATIO	1983	1984	1	4371 SF	2
WALL AIR COND	1985	1986	1	1 UT	1
FENCES	1987	1988	1	1800 SF	2

### Sales

Sale Date	Sale Price	Instrument	Instrument Number	Deed Book	Deed Page	Sale Qualification	Vacant or Improved
6/18/2009	\$100	Warranty Deed		2419	1579	18 - Unqualified	Improved
12/1/1992	\$406,000	Warranty Deed		1239	450	Q - Qualified	Vacant
12/1/1989	\$265,000	Warranty Deed		1115	1989	U - Unqualified	Vacant
1/1/1985	\$187,100	Warranty Deed		933	404	M - Unqualified	Improved

### Permits

Number	Date Issued	Date Completed	Amount	Permit Type	Notes
18-2894	7/6/2018		\$0		REPLACE 2 4 TON RHEEM RA1448AJ1NA CONDENSER RBH1P4821STANJA
09-2025	7/6/2009	6/28/2011	\$8,000	Commercial	REPAIR 39LF OF DAMAGED CONCRETE ON SUPPORT COLUMNS LOCATED IN GARAGE AREA.
08-3105	8/26/2008	6/28/2011	\$2,400	Commercial	RECONNECT PIPES AND WIRE FOR DISPENSERS AND TANKS.
08/2750	8/5/2008	6/28/2011	\$43,000	Commercial	RE-PIPE FUEL DELIVERY LINES WITH DOUBLE WALL. ADD SECONDARY CONTAINMENT TO EXISTING TANKS.
08-2673	7/23/2008	6/28/2011	\$2,000	Commercial	CHANGE OUT OF A 2.5 TON CONDENSER ON EXISTING STAND.
05-0949	3/24/2005	12/31/2005	\$4,000		CHANGE OUT ICE-MACHINE
03-3189	9/11/2003	11/23/2004	\$10,000		CLEAN & PAINT BLDG
03-3269	9/11/2003	11/23/2004	\$1,000		CONNECT NEW DISPENSERS
02/0890	4/18/2002		\$1		INSTALL METER
0200890	4/18/2002	9/18/2002	\$800		DEDUCT METER
9800987	7/6/1998	12/31/1998	\$60,000	Commercial	INSTALL CAR WASH
9801570	5/19/1998	12/31/1998	\$250	Commercial	ELECTRICAL
9702903	2/24/1998	12/31/1998	\$2,000	Commercial	SEC ALARM
9704237	1/22/1998	12/31/1998	\$3,500	Commercial	ATM SIGN
9702896	8/1/1997	12/1/1997	\$700		CONNECT ATM MACHINE
9700532	3/1/1997	3/1/1997	\$500		BASE CONC/CONCH SHELL
9700877	3/1/1997	3/1/1997	\$1,600		ELECTRICAL
9700877	3/1/1997	3/1/1997	\$6,000		CONCRETE UNENCLOSED
9700370	2/1/1997	3/1/1997	\$28,500		ELECTRICAL
9700532	2/1/1997	3/1/1997	\$500		REPAIR/REMODELING
9704862	1/1/1997	3/1/1997	\$6,500		MECHANICAL
9603964	10/1/1996	3/1/1997	\$50,000	Commercial	ELECTRICAL/REPAIRS
9600769	2/1/1996	3/1/1997	\$1,000		PAINTING
P953143	9/1/1995	12/1/1995	\$8,000		REPLACE 4 GAS DISPENSERS

### View Tax Info

[View Taxes for this Parcel](#)

### Sketches (click to enlarge)



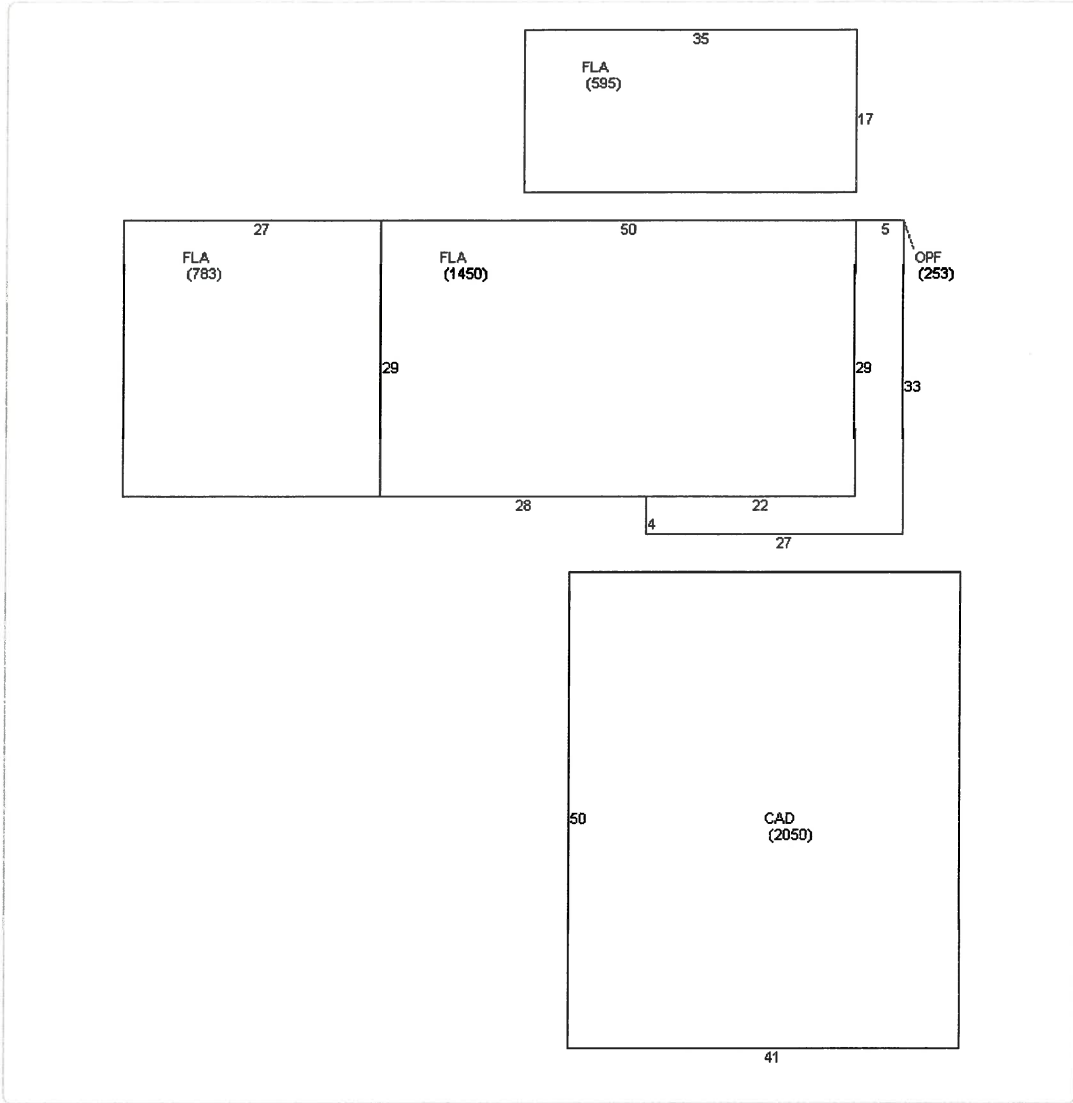

**Photos**



**Map**



### Disclaimer

The Monroe County Property Appraiser's office maintains data on property within the County solely for the purpose of fulfilling its responsibility to secure a just valuation for ad valorem tax purposes of all property within the County. The Monroe County Property Appraiser's office cannot guarantee its accuracy for any other purpose. Likewise, data provided regarding one tax year may not be applicable in prior or subsequent years. By requesting such data, you hereby understand and agree that the data is intended for ad valorem tax purposes only and should not be relied on for any other purpose.

By continuing into this site you assert that you have read and agree to the above statement.

### Summary

**Parcel ID** 00051840-000000  
**Account#** 1052469  
**Property ID** 1052469  
**Millage Group** 10KW  
**Location** 1910 N ROOSEVELT Blvd, KEY WEST  
**Address**  
**Legal** SUNSHINE SUB PLAT NO 3 PB2-169 ELY 59.69 FT LT 1 AND ALL LT 2 AND  
**Description** WLY 70.31 FT LT 3 BK 6 OR84-413 OR98-535/36 OR202-71/72 OR439-  
 886/90 OR777-1864 OR810-2428 OR856-1258 OR856-1259/60  
 OR1285-1162/71 OR1287-1541/42P/R OR1426-16 OR1426-17  
 OR1444-2024/25 OR1561-150/51  
 (Note: Not to be used on legal documents.)  
**Neighborhood** 31040  
**Property Class** SERVICE SHOPS (2500)  
**Subdivision** Sunshine Subdivision Plat No. 3  
**Sec/Twp/Rng** 05/68/25  
**Affordable** No  
**Housing**



### Owner

SAVIANO DENNIS P LIV TR 5/18/1993  
 PO Box 2025  
 Key West FL 33045

### Valuation

	2019	2018	2017	2016
+ Market Improvement Value	\$348,895	\$0	\$0	\$0
+ Market Misc Value	\$40,427	\$0	\$0	\$0
+ Market Land Value	\$1,024,766	\$947,176	\$947,176	\$947,176
= Just Market Value	\$1,414,088	\$947,176	\$947,176	\$947,176
= Total Assessed Value	\$1,041,893	\$947,176	\$947,176	\$947,176
- School Exempt Value	\$0	\$0	\$0	\$0
= School Taxable Value	\$1,414,088	\$947,176	\$947,176	\$947,176

### Land

Land Use	Number of Units	Unit Type	Frontage	Depth
COMM DRY HIGHWAY (10DH)	32,491.00	Square Foot	210	164

### Commercial Buildings

**Style** OFF BLDG-1 STY-D / 17D  
**Gross Sq Ft** 5,250  
**Finished Sq Ft** 5,250  
**Perimeter** 0  
**Stories** 1  
**Interior Walls**  
**Exterior Walls** METAL SIDING  
**Quality** 400 ()  
**Roof Type**  
**Roof Material**  
**Exterior Wall1** METAL SIDING  
**Exterior Wall2**  
**Foundation**  
**Interior Finish**  
**Ground Floor Area**  
**Floor Cover**

**Full Bathrooms** 0  
**Half Bathrooms** 0  
**Heating Type**  
**Year Built** 1980  
**Year Remodeled**  
**Effective Year Built** 1999  
**Condition**

Code	Description	Sketch Area	Finished Area	Perimeter
FLA	FLOOR LIV AREA	5,250	5,250	0
TOTAL		5,250	5,250	0

### Yard Items

Description	Year Built	Roll Year	Quantity	Units	Grade
TIKI	1979	1980	1	120 SF	3
ASPHALT PAVING	1979	1980	1	17590 SF	2
CH LINK FENCE	1999	2000	1	1600 SF	2
TIKI	1999	2000	1	64 SF	5

### Sales

Sale Date	Sale Price	Instrument	Instrument Number	Deed Book	Deed Page	Sale Qualification	Vacant or Improved
10/1/1996	\$1,040,000	Warranty Deed		1426	0016	Q - Qualified	Improved
11/1/1993	\$729,700	Warranty Deed		1285	1162	Q - Qualified	Improved
2/1/1982	\$75,000	Warranty Deed		856	1268	M - Unqualified	Improved
2/1/1982	\$75,000	Warranty Deed		856	1258	M - Unqualified	Improved

### Permits

Number	Date Issued	Date Completed	Amount	Permit Type	Notes
16-00002785	8/12/2016	2/21/2017	\$7,000	Commercial	REMOVE DAMGED ASPHALT APPLY SEAL COAT TO 24.915 SQ/FT CREATE ADA PARKING STALL STRIPE 25 PARKING STALL INSTALL SIGNAGE N.O.C REQUIRED. GH
07-3355	8/6/2007		\$10,000	Commercial	INSTALL PREFABRICATED ICE FREEZER
04-2933	8/31/2004	11/23/2004	\$575	Commercial	PHASE CONVERTER
99-3457	10/6/1999	11/17/1999	\$2,000	Commercial	ELECTRICAL
99-0191	3/30/1999	11/17/1999	\$800	Commercial	FENCE
98-2129	7/23/1998	12/31/1998	\$6,500	Commercial	REMOVE/INSTL GARAGE DOOR
98-1834	7/22/1998	12/31/1998	\$8,000	Commercial	RELOCATE SIGN
B94-1036	3/1/1994	12/1/1994	\$2,000	Commercial	ENLARGE TICKET BOOTH

### View Tax Info

[View Taxes for this Parcel](#)

Sketches (click to enlarge)

FLA  
(5250)

75

70

Photos

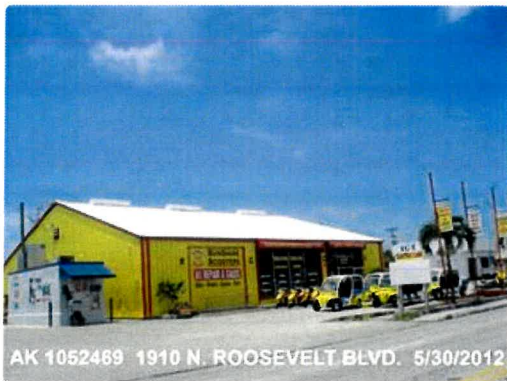

## Map



## TRIM Notice



2019 Notices Only

No data available for the following modules: Buildings, Mobile Home Buildings, Exemptions.

The Monroe County Property Appraiser's office maintains data on property within the County solely for the purpose of fulfilling its responsibility to secure a just valuation for ad valorem tax purposes of all property within the County. The Monroe County Property Appraiser's office cannot guarantee its accuracy for any other purpose. Likewise, data provided regarding one tax year may not be applicable in prior or subsequent years. By requesting such data, you hereby understand and agree that the [User Privacy Policy](#) and [GDPR Privacy Notice](#)

Developed by  
 Schneider  
GEOSPATIAL

[Last Data Upload: 3/12/2020, 3:34:10 AM](#)

[Version 2.3.45](#)

# **Boundary Survey**

BEARING BASE:  
 ALL BEARINGS ARE BASED ON N74°39'21"E ALONG THE CENTERLINE OF NORTH ROOSEVELT BOULEVARD, AS SHOWN ON FOOT STATE ROAD NO. 5 RW MAP SHEET 5 OF 19, SECTION 9001-NR03.

ALL ANGLES DEPICTED ARE 90 DEGREES UNLESS OTHERWISE INDICATED

ALL UNITS ARE SHOWN IN U.S. SURVEY FEET

ADDRESS:  
 1900-1910 NORTH ROOSEVELT BOULEVARD  
 KEY WEST, FL 33040

ELEVATIONS SHOWN HEREON ARE IN FEET AND BASED ON THE NATIONAL GEODETIC VERTICAL DATUM OF 1929 (NGVD29) AND ARE CERTIFIED TO ±0.10'  
 BENCHMARK DESCRIPTION:  
 NATIONAL GEODETIC SURVEY BENCHMARK DESIGNATION: W 267; P.I.D.: AA0022; ELEVATION: 5.09 (NGVD29)

THE UTILITIES SHOWN HEREON HAVE BEEN LOCATED FROM OBSERVED EVIDENCE. THE SURVEYOR MAKES NO GUARANTIES THAT THE UTILITIES SHOWN HEREON ENCOMPASS ALL SUCH UTILITIES IN THE AREA, EITHER IN SERVICE OR ABANDONED. FURTHERMORE THE SURVEYOR DOES NOT WARRANT THAT THE UNDERGROUND UTILITIES SHOWN ARE IN THE EXACT LOCATION INDICATED ALTHOUGH HE DOES CERTIFY THAT THEY ARE LOCATED AS ACCURATELY AS POSSIBLE FROM THE EVIDENCE AVAILABLE. THE SURVEYOR HAS NOT PHYSICALLY LOCATED THE UNDERGROUND UTILITIES. ALL DRAINAGE STRUCTURES WERE FULL OF DEBRIS OR WATER, OR INACCESSIBLE AT TIME OF SURVEY.

COMMUNITY NO.: 120168  
 MAP NO.: 12087C-1516K  
 MAP DATE: 02-18-2005  
 FLOOD ZONE: AE  
 BASE ELEVATION: 7.48

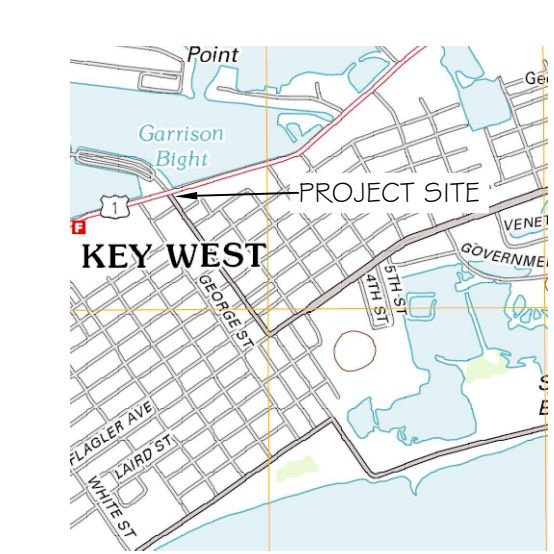

LOCATION MAP - NTS  
 SEC. 5-T685-R25E

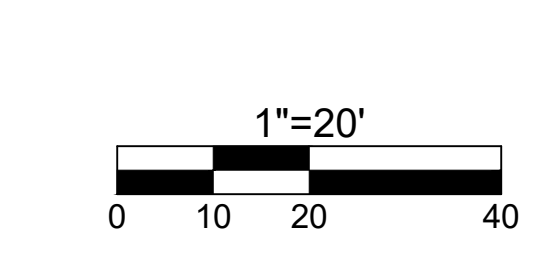
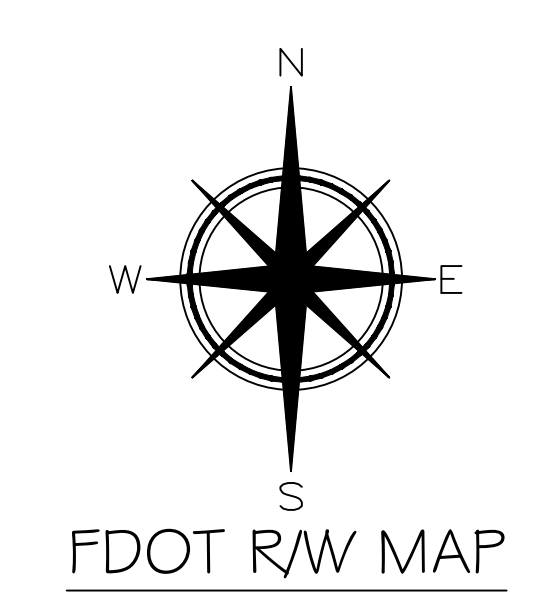

\*VERIFY ORIGINAL SCALE OF 2"

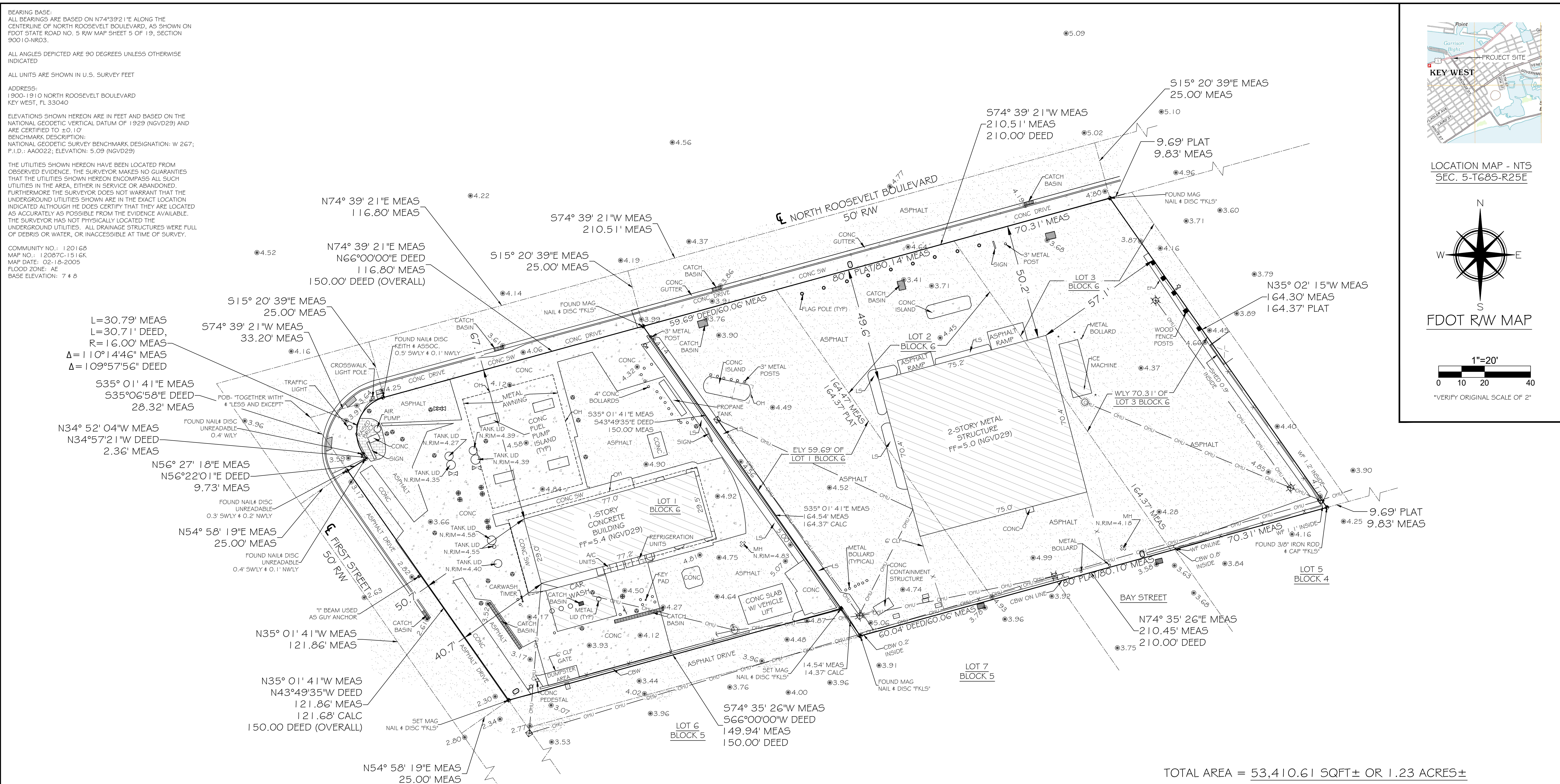

TOTAL AREA = 53,410.61 SQFT ± OR 1.23 ACRES ±

**LEGAL DESCRIPTION**

On the Island of Key West, and known as the Easterly 59.69 feet of Lot 1, All of Lot 2, and the Westerly 70.31 feet of Lot 3, Block 6, SUNSHINE SUBDIVISION Plat No. 3, according to Plat thereof recorded in Plat Book 2, at Page 169, Monroe County, Florida Public Records.

TOGETHER WITH:

A portion of Lot 1, Block 6, of "SUNSHINE SUBDIVISION", according to the plat thereof, as recorded in Plat Book 2, Page 169, of the Public Records of Monroe County, Florida, being more particularly described as follows:  
 Commence at the intersection of the Southeastly line of Roosevelt Boulevard and the Northeastly line of First Street; thence N.66°00'00"E, along the Southeastly line of Roosevelt Blvd. for 150.00 feet; thence run S.43°49'35"E, parallel with First Street for 150.00 feet; thence S.66°00'00"W, parallel with Roosevelt Blvd. for 150.00 feet to the intersection with the Northeastly line of First Street; thence run N.43°49'35"W, along the Northeastly line of First Street for 150.00 feet to the Point of Beginning. Lying and being situate in the City of Key West, Monroe County, Florida.

LESS AND EXCEPT:

A portion of Lot 1, Block 6 of Sunshine Subdivision Plat No. 3, according to the Plat thereof as recorded in Plat Book 2, at Page 169, of the Public Records of Monroe County, Florida, more particularly described as follows:  
 Beginning at the Point of Intersection of the Northeastly Right-of-Way line of First Street as shown on said plat of Sunshine Subdivision Plat No. 3 and the Existing Southerly Right-of-Way line of State Road No. 5, North Roosevelt Boulevard, as shown on the Florida Department of Transportation Right-of-Way map for State Road No. 5, Section 9001Q; Thence S35°06'58"E, along the Northeastly Right-of-Way line of First Street, for a distance of 28.32 feet; Thence N56°22'01"E, departing the previously described Right-of-Way line, for a distance of 9.73 feet; Thence N34°57'21"W, for a distance of 2.36 feet to the Point of Curvature of a circular curve concave to the East; Thence Northwestly, Northerly and Northeastly, along the arc of said curve to the north, having a radius of 16.00 feet and a central angle of 109°57'56" for a distance of 30.71 feet to the point of cusp, said point also being on the Southerly Right-of-Way line of State Road No. 5, North Roosevelt Boulevard; Thence S74°39'21"W, along the previously described line, for a distance of 33.20 feet to the Point of Beginning.

SURVEYORS NOTE:

IT IS THIS SURVEYORS OPINION THAT THE LEGAL DESCRIPTIONS SUBDIVIDING BLOCK 6 HAVE BEEN ERRONEOUSLY SURVEYED BY APPLYING THE DEED DIMENSIONING ALONG THE SOUTH RIGHT OF WAY LINE OF NORTH ROOSEVELT BOULEVARD. THIS WAS SUBSTANTIATED BY OCCUPATION, PAROLE EVIDENCE FROM OTHER SURVEYORS, AND MONUMENTATION RECOVERED DURING THE COURSE OF PERFORMING THIS SURVEY.

**SYMBOL LEGEND:**

	CATCH BASIN		WATER METER
	DRAINAGE MANHOLE		TRAFFIC SIGNAL BOX
	CONCRETE UTILITY POLE		WOOD UTILITY POLE
	CONCRETE UTILITY POLE WITH LAMP		6x6 POST W ROPE
	FIRE HYDRANT		SPOT ELEVATION (TYPICAL)
	GUY WIRE		ELECTRIC BOX
	FUEL VALVE		ADA SURFACE (PLASTIC)
	SANITARY CLEANOUT		MONITORING WELL
	MANHOLE		UNDERGROUND FUEL TANK FILL LID
	TELEPHONE MANHOLE		OVERHEAD UTILITY LINE
	WATER VALVE		
	LIGHT POLE		

NOTE: FOUNDATIONS BENEATH THE SURFACE ARE NOT SHOWN. MEASURED DIMENSIONS EQUAL PLATED OR DESCRIBED DIMENSIONS UNLESS INDICATED OTHERWISE.  
 THE FOLLOWING IS A LIST OF ABBREVIATIONS THAT MAY BE FOUND ON THIS SHEET.

BPF = BACK FLOW PREVENTER	GV = GUY WIRE	POC = POINT OF COMMENCEMENT
BO = BLOW OUT	IR = IRON ROD	PRC = POINT OF REVERSE CURVE
CALC = CALCULATED FROM DEEDS	IRP = IRON PIPE	PRM = PERMANENT REFERENCE MONUMENT
CB = CONCRETE BLOCK	L = ARC LENGTH	PT = POINT OF TANGENT
CBW = CONCRETE BLOCK WALL	LI = LANDMARKING	R = RADIUS
CI = CONCRETE	MB = MALSBOBY	RM = RIGHT OF WAY LINE
CL = CHANNEL FENCE	ME = MEASURED	SDCC = SANITARY SEWER CLEAN-OUT
CM = CONCRETE MONUMENT	MF = METAL FENCE	SM = SIDE WALK
CONC = CONCRETE	MI = MANSION	TM = TEMPORARY BENCHMARK
COP = CONCRETE POWER POLE	MO = METAL	TS = TOP OF BANK
COVER = COVERED	MS = METAL	TS = TOP OF SLOPE
DELTA = DELTA	NGVD = NATIONAL GEODETIC VERTICAL DATUM (1929)	TS = TRAFFIC SIGN
ENCL = ENCLOSURE	HTS = NOT TO SCALE	TYP = TYPICAL
ENCL = ENCLOSURE	OH = OVERHEAD WIRE	UN = UNDESIGNABLE
EP = SIDE OF PAVEMENT	OP = OVERHEAD WIRE	UE = UTILITY EQUIPMENT
FF = FINISHED FLOOR ELEVATION	PC = POINT OF CURVE	WD = WOOD DECK
FI = FIRE HYDRANT	PCP = POINT OF COMMENCEMENT	WF = WOOD FENCE
FL = FENCE LINE	PCF = PERMANENT CONTROL POINT	WL = WOOD LANDING
FO = FOUND	PF = PARKER GAUGE NAIL	WM = WATER METER
FO = FENCE OUTSIDE	POB = POINT OF BEGINNING	WPP = WOOD POWER POLE
FO = FENCE ON LINE	POI = POINT OF INTERSECTION	WRASL = LINE OF DEBRIS ON SHORE
		WV = WATER VALVE

NOTE: LEGAL DESCRIPTIONS HAVE BEEN FURNISHED BY THE CLIENT OR HIS/HER REPRESENTATIVE. ADDITIONS OR DELETIONS TO SURVEY MAP OR REPORT BY OTHER THAN THE SIGNING PARTY IS PROHIBITED WITHOUT WRITTEN CONSENT OF THE SIGNING PARTY. THE BOLD LINE SHOWN HEREON REPRESENTS THE SURVEYORS OPINION OF THE DEED LINES. THE MEAN HIGH WATER LINE WAS NOT DETERMINED FOR THIS SURVEY. THE APPARENT MEAN HIGH WATER LINE IS SHOWN FOR REFERENCE ONLY.

CERTIFIED TO -  
 StorCon Development, LLC;

I HEREBY CERTIFY THAT THIS SURVEY WAS MADE UNDER MY RESPONSIBLE CHARGE AND MEETS THE STANDARDS OF PRACTICE AS SET FORTH BY THE FLORIDA BOARD OF PROFESSIONAL SURVEYORS AND MAPPERS IN CHAPTER 55-17, FLORIDA ADMINISTRATIVE CODE, PURSUANT TO SECTION 472.027, FLORIDA STATUTES AND COMPLIES WITH CHAPTER 177, FLORIDA STATUTES.

NOT VALID WITHOUT THE SIGNATURE AND THE RAISED SEAL OF A FLORIDA SURVEYOR AND MAPPER

SIGNED:   
 ERIC A. ISAACS, PSM #6783, PROFESSIONAL SURVEYOR AND MAPPER, LM 7847

**FLORIDA KEYS LAND SURVEYING**  
 1996 OVERSEAS HIGHWAY  
 SUGARLOAF KEY, FL 33042  
 PHONE: (305) 334-3690  
 FAX: (305) 509-7373  
 EMAIL: FKL5email@gmail.com

**TOPOGRAPHIC SURVEY**  
 1900 & 1910 NORTH ROOSEVELT BOULEVARD  
 KEY WEST, MONROE COUNTY, STATE OF FLORIDA

DATE: 06/30/2020	SURVEY BY: EAI	PROJECT: 1900-1910 N ROOSEVELT
REVISION DATE: XX/XX/XXXX	DRAWN BY: GBF	H. SCALE: 1"=20'
JOB NO.: 20-314	CHECKED BY:	SHEET 1 OF 1

**Public  
Notice**