



Historic Architectural Review Commission Staff Report for Item 3

To: Chairman Bryan Green and Historic Architectural Review Commission Members

From: Enid Torregrosa-Silva, MSHP
Historic Preservation Planner

Meeting Date: July 29, 2020

Applicant: Chas Spottswood, Owner/ Contractor

Application Number: Bldg. 2019-1671

Address: 529 Caroline Street

Description of Work:

Repair damage brick with stucco application. The stucco repair will only be approximately 5 feet above the front porch elevation and down.

Site Facts:

The house under review is a contributing resource to the historic district and was build circa 1899. On portions of a land used as a Brick and Lumber Yard. The two-story Queen Anne revival has a turret on its southeast corner facing Caroline Street. Although the building has exterior brick walls, the structural components of the house are made of wood, making the exterior brick walls a finish surface rather than a structural element. Repointing work has not done for a long time and bricks had several layers of latex red painting that was recently removed as part of a current building permit that includes, among other work, *“less than 10% repairs to exiting brick, fascia, and deck boards with like materials”*. Mortar and brick analysis were done, and the new repointing material matches the historic in composition, texture, and color.

The bricks used in the front, porch side and turret are different in size and color tone than the rest of the bricks found in other exterior walls. The front and southwest walls are covered and protected under an “L” shape porch; portions of those protected walls have a much-concentrated deteriorated bricks. The deterioration includes spalling of the brick’s frontal surface and sporadically efflorescence. The bricks were dry to the touch when visited the structure. The front and southwest

walls are built over brick piers and the front porch has a solid concrete base. The turret's brick veneer is in contact with grade and presents some missing bricks and moisture problems. No humidity readings or tracking has been done. Most likely deterioration of brick is due to years of improper moisture entrapment under layers of painting and possible abrasive cleaning methods. The bricks in the front and southwest area are covered under a roof, are not exposed to the elements, and surrounded by a concrete base for the porch without openings. The applicant has spent time contacting brick salvage firms and a contractor that has done brick work in Key West.

Guidelines and SOIS Cited on Review:

- Secretary of the Interior's Standards (pages 16-23), specifically standards 2, 5, 6, and 9.
- Guidelines for Exteriors- Masonry (pages 25), first three paragraphs, and specifically guidelines 1, 2, 4, 5, 6, and 7.
- SOIS and Guidelines for Rehabilitation, (pages 8, 9 and 10), specifically;

Recommended:

Identifying, retaining, and preserving masonry features that are important in defining the overall historic character of the building such as walls, brackets, railings, cornices, window architraves, door pediments, steps, and columns; and details such as tooling and bonding patterns, coatings, and color.

Not Recommended:

Applying paint or other coatings such as stucco to masonry that has been historically unpainted or uncoated to create a new appearance

Recommended:

Repairing masonry walls and other masonry features by repointing the mortar joints where there is evidence of deterioration such as disintegrating mortar, cracks in mortar joints, loose bricks, damp walls, or damaged plasterwork.

Repairing masonry features by patching, piecing-in, or consolidating the masonry using recognized preservation methods. Repair may also include the limited replacement in kind--or with compatible substitute material--of those extensively deteriorated or missing parts of masonry features when there are surviving prototypes such as terra-cotta brackets or stone balusters.

Not Recommended:

Using a substitute material for the replacement part that does not convey the visual appearance of the surviving parts of the masonry feature or that is physically or chemically incompatible.

Recommended:

Replacing in kind an entire masonry feature that is too deteriorated to repair--if the overall form and detailing are still evident--using the physical evidence as a model to reproduce the feature. Examples can include large sections of a wall, a cornice, balustrade, column, or stairway. If using the same kind of material is not technically or economically feasible, then a compatible substitute material may be considered.

Not Recommended:

Removing a masonry feature that is unrepairable and not replacing it; or replacing it with a new feature that does not convey the same visual appearance.

Staff Analysis:

Report after June 23, 2020 meeting:

During the last HARC meeting the Commissioners motioned to postpone the item until the July meeting and gave recommendations to the applicant. At the date of this report, staff has not received any communication, documents or any phone call from the applicant.

Report after February 25, 2020 meeting:

This project was discussed and postponed by the Commission at the public hearing on February 25, 2020. During the discussion the applicant stated that they have reached out to a dozen of experts and that none of the parties were not able to provide other recommendation. The applicant also stated that they will need approximately 2,500 bricks. Commissioner Bender offered to visit the house and see if the deteriorated bricks can be removed and reuse with their back surface facing front. Unfortunately, this will not work.

In March 17, 2020 Commissioner Bender and myself had a conference call with Rick Hilburn, preservation architect from the Division of Historical Resources of Florida Department of State in order to discuss the deterioration issues found in the bricks and appropriate means to solve the problem. Architect Hilburn opinion is that applying of stucco is not an appropriate solution but finding a larger brick is. Either vertical or horizontal joints will be change due to a different size of the brick, but that is an appropriate solution to replace deteriorated historic bricks when equal dimensions cannot be found. Commissioner Bender and I conveyed to the applicant our conversation with architect Hilburn. Staff did send written communications following up with the applicant. No new documents or new information has been received from the applicant. Staff did not include the item on the May agenda as we never received any new documentation nor have been contacted to review any bricks as replacement alternative. The applicant insisted to be on the next available agenda.

A significant fact is that the 1892 Sanborn Map depicts the site where the house still stands today as part of a Brick and Lumber Yard.

Report for February 25, 2020 meeting:

The applicant submitted a revision to an approved building permit that included, among other work, the repairs of less than 10% of bricks. The applicant has met with staff to find solutions to a problem that he has encountered as he has stated that he cannot find brick replacements for the front wall and the lower portion of the turret. The nominal dimension of the brick used as a veneer in the front and southwest part of the house is 2.4" x 4.2" x 7.9".

The applicant is proposing to apply a stucco finish over the existing damaged bricks up to 5' height from finished floor and is proposing the same treatment on the turret but starting down to grade and aligning the stucco height with the one proposed in the front elevation. Weep holes as required, are noted on a stucco section detail and the proposed stucco will end on a mortar joint. The proposed stucco will have the following layers:

Eucorepair V100- According to the guide specifications this product is a bonding agent/ primer that is cement-based, one component, fiber reinforced, polymer modified repair mortar containing corrosion inhibitor and is mixed with water.

Sakrete- According to the manufacturer specification this is a water-resistant stucco composed of same parts of cement, Portland, chemicals-, calcium oxide- Gypsum- limestone- magnesium oxide and small parts of calcium hydroxide, quartz and chromium and is mix with water.

BASF Limestone Finish- According to the manufacturer this is a 100% acrylic polymer finish coat.

Consistency with Cited SOIS and Guidelines:

It is still staff's opinion that the proposed solution of applying a stucco finish over deteriorated historic bricks is inappropriate and inconsistent with cited regulations and the Secretary of the Interior's Standards and Guidelines for Rehabilitation. Covering historic deteriorated bricks with a material that has concentrations of concrete and polymers will promote the acceleration of the decay of the historic fabric; it will not allow moisture to evaporate from the masonry walls as needed. In addition, the proposed stucco solution will change the visual character of the historic house. Finding the source of why the deterioration has taken place and correcting the problem is paramount to fix the issue under review. Finally, photographs were included as part of the application of historic brick buildings that have a stucco finish in their first floor. All examples are commercial buildings that have zero setbacks from the sidewalks and their finish floor is less than 13 inches height in relationship to the sidewalks in one or more entryways. One can make an argument that this stucco became a means for flood proofing these commercial buildings. Still, because stucco over bricks is found in some structures it does not mean this is appropriate for the building under review or for correcting the decay issue found in the historic house.

COMBINATION APPLICATION: FLOODPLAIN, CONSTRUCTION AND HARC

\$50.00 APPLICATION FEE NON-REFUNDABLE



City of Key West

3140 FLAGLER AVENUE
KEY WEST, FLORIDA 33040

Phone: 305.809.3956

www.cityofkeywest-fl.gov

HARC PERMIT NUMBER		BUILDING PERMIT NUMBER	INITIAL & DATE
		2019-1671	5-7-19
FLOODPLAIN PERMIT			REVISION #
FLOOD ZONE	PANEL #	ELEV. L. FL.	SUBSTANTIAL IMPROVEMENT
			___ YES ___ NO ___ %

ADDRESS OF PROPOSED PROJECT:

529 Caroline St.

OF UNITS

RE # OR ALTERNATE KEY:

NAME ON DEED:

SVR 529, LLC

PHONE NUMBER

OWNER'S MAILING ADDRESS:

506 Fleming St.

EMAIL

billy@spottswood.com

CONTRACTOR COMPANY NAME:

Keystar, Inc.

PHONE NUMBER

305-360-0802

CONTRACTOR'S CONTACT PERSON:

Chas Spottswood

EMAIL

chas@keystarconstruction.com

ARCHITECT / ENGINEER'S NAME:

Thomas E. Pope, PA

PHONE NUMBER

305-296-3611

ARCHITECT / ENGINEER'S ADDRESS:

610 White St.

EMAIL

holly@p-s-architects.com

HARC: PROJECT LOCATED IN HISTORIC DISTRICT OR IS CONTRIBUTING: YES NO (SEE PART C FOR HARC APPLICATION.)

CONTRACT PRICE FOR PROJECT OR ESTIMATED TOTAL FOR MAT'L., LABOR & PROFIT:

\$500,000

FLORIDA STATUTE 837.06: WHOEVER KNOWINGLY MAKES A FALSE STATEMENT IN WRITING AND WITH THE INTENT TO MISLEAD A PUBLIC SERVANT IN THE PERFORMANCE OF HIS OR HER OFFICIAL DUTY SHALL BE GUILTY OF A MISDEMEANOR OF THE SECOND DEGREE PUNISHABLE PER SECTION 775.082 OR 775.083.

PROJECT TYPE: ONE OR TWO FAMILY MULTI-FAMILY COMMERCIAL NEW REMODEL
 CHANGE OF USE / OCCUPANCY ADDITION SIGNAGE WITHIN FLOOD ZONE
 DEMOLITION SITE WORK INTERIOR EXTERIOR AFTER-THE-FACT

DETAILED PROJECT DESCRIPTION INCLUDING QUANTITIES, SQUARE FOOTAGE ETC.,

Relocate existing

baths. Convert 1/2 bath to ADA. ~~demo non-contributing~~
~~sheds~~. Less than 10% repairs to existing brick, fascia
 and deck boards with like materials. (MEP and roofing under separate permit app)

I'VE OBTAINED ALL NECESSARY APPROVALS FROM ASSOCIATIONS, GOV'T AGENCIES AND OTHER PARTIES AS APPLICABLE TO COMPLETE THE DESCRIBED PROJECT;

OWNER PRINT NAME: William B. Spottswood, VP	QUALIFIER PRINT NAME: Chas Spottswood
OWNER SIGNATURE: <i>[Signature]</i>	QUALIFIER SIGNATURE: <i>[Signature]</i>
Notary Signature as to owner: <i>[Signature]</i>	Notary Signature as to qualifier: <i>[Signature]</i>
STATE OF FLORIDA; COUNTY OF MONROE, SWORN TO AND SCRIBED BEFORE ME THIS <u>7</u> DAY OF <u>May</u> , 20 <u>19</u> .	STATE OF FLORIDA; COUNTY OF MONROE, SWORN TO AND SCRIBED BEFORE ME THIS <u>7th</u> DAY OF <u>May</u> , 20 <u>19</u> .
 Personally known or produced _____ as identification.	 Personally known or produced _____ as identification.

Francesca S. Chavez

Permit Admin 12000.00
814.50

Page 1 of 3

John Castro
5-22-19

PART B: SUPPLEMENTARY PROJECT DETAILS TO AVOID DELAYS / CALL-BACKS

PROPERTY STRUCTURES AFFECTED BY PROJECT: MAIN STRUCTURE ACCESSORY STRUCTURE SITE

ACCESSORY STRUCTURES: GARAGE / CARPORT DECK FENCE OUTBUILDING / SHED

FENCE STRUCTURES: 4 FT. 6 FT. SOLID 6 FT. / TOP 2 FT. 50% OPEN

POOLS: INGROUND ABOVE GROUND SPA / HOT TUB PRIVATE PUBLIC
 PUBLIC POOLS REQUIRE BD. OF HEALTH LICENSE APPLICATION AT TIME OF CITY APPLICATION.
 PUBLIC POOLS REQUIRE BD. OF HEALTH LICENSE PRIOR TO RECEIVING THE CITY CERTIFICATE OF OCCUPANCY.

ROOFING: NEW ROOF-OVER TEAR-OFF REPAIR AWNING
 5 V METAL ASPLT. SHGLS. METAL SHGLS. BLT. UP TPO OTHER

FLORIDA ACCESSIBILITY CODE: 20% OF PROJECT FUNDS INVESTED IN ACCESSIBILITY FEATURES.

SIGNAGE: # OF SINGLE FACE # OF DOUBLE FACE REPLACE SKIN ONLY BOULEVARD ZONE
 POLE WALL PROJECTING AWNING HANGING WINDOW
 SQ. FT. OF EACH SIGN FACE: _____

SUBCONTRACTORS / SPECIALTY CONTRACTORS SUPPLEMENTARY INFORMATION:

MECHANICAL: DUCTWORK COMMERCIAL EXH. HOOD INTAKE / EXH. FANS LPG TANKS
 A / C: COMPLETE SYSTEM AIR HANDLER CONDENSER MINI-SPLIT

ELECTRICAL: LIGHTING RECEPTACLES HOOK-UP EQUIPMENT LOW VOLTAGE
 SERVICE: OVERHEAD UNDERGROUND 1 PHASE 3 PHASE _____ AMPS

PLUMBING: ONE SEWER LATERAL PER BLDG. INGROUND GREASE INTCPTRS. LPG TANKS

RESTROOMS: MEN'S WOMEN'S UNISEX ACCESSIBLE

PART C: HARC APPLICATION FOR A CERTIFICATE OF APPROPRIATENESS

APPLICATION FEES: PAINTING SINGLE FAMILY: \$10 STAFF APPROVAL: \$50 COMMISSION REVIEW \$100
 PLEASE ATTACH APPROPRIATE VARIANCES / RESOLUTIONS FROM HARC, PLANNING BOARD OR TREE COMMISSION.
 ATTENTION: NO BUILDING PERMITS WILL BE ISSUED PRIOR TO HARC APPROVAL.

PLEASE SEND ELECTRONIC SUBMISSIONS TO: harc@cityofkeywest-fl.gov
 INDICATE TYPE OF CERTIFICATE. OF APPROPRIATENESS: GENERAL DEMOLITION SIGN PAINTING OTHER
 ADDITIONAL INFORMATION: _____

PROJECT SPECIFICATIONS: PLEASE PROVIDE PHOTOS OF EXISTING CONDITIONS, PLANS, PRODUCT SAMPLES, TECHNICAL DATA

ARCHITECTURAL FEATURES TO BE ALTERED:	ORIGINAL MATERIAL:	PROPOSED MATERIAL:
repairs to existing brick,	brick	same as existing
facia and deck boards	wood	same as existing
like materials less		
than 10%		

DEMOLITION: PLEASE FILL OUT THE HARC APPENDIX FOR PROPOSED DEMOLITION.
 DEMOLITION OF HISTORIC STRUCTURES IS NOT ENCOURAGED BY THE HISTORIC ARCHITECTURAL REVIEW COMMISSION.
 SIGNAGE: (SEE PART B) BUSINESS SIGN BRAND SIGN OTHER: _____
 BUSINESS LICENSE # _____ IF FAÇADE MOUNTED, SQ. FT. OF FAÇADE _____

SIGN SPECIFICATIONS		
SIGN COPY:	PROPOSED MATERIALS:	SIGNS WITH ILLUMINATION:
		TYPE OF LTG.:
		LTG. LINEAL FTG.:
MAX. HGT. OF FONTS:		COLOR AND TOTAL LUMENS:
IF USING LIGHT FIXTURES PLEASE INDICATE HOW MANY: INCLUDE SPEC. SHEET WITH LOCATIONS AND COLORS.		

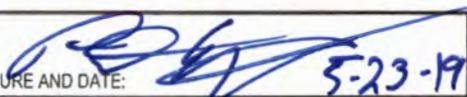
OFFICIAL USE ONLY:		HARC STAFF OR COMMISSION REVIEW	
<input type="checkbox"/> APPROVED	<input type="checkbox"/> NOT APPROVED	<input type="checkbox"/> DEFERRED FOR FUTURE CONSIDERATION	<input type="checkbox"/> TABLED FOR ADD'L. INFO.
HARC MEETING DATE:	HARC MEETING DATE:	HARC MEETING DATE:	
REASONS OR CONDITIONS:			
STAFF REVIEW COMMENTS:			
HARC PLANNER SIGNATURE AND DATE:  5-23-19		HARC CHAIRPERSON SIGNATURE AND DATE:	

PART D: STATE OF FLORIDA OFFICIAL NOTIFICATIONS AND WARNINGS

FLORIDA STATUTE 713.135: WARNING TO OWNER: YOUR FAILURE TO RECORD A 'NOTICE OF COMMENCEMENT' MAY RESULT IN YOUR PAYING TWICE FOR IMPROVEMENTS TO YOUR PROPERTY. A NOTICE OF COMMENCEMENT MUST BE RECORDED WITH THE COUNTY RECORDER AND A COPY POSTED ON THE JOB SITE BEFORE THE FIRST INSPECTION. IF YOU INTEND TO OBTAIN FINANCING CONSULT WITH YOUR LENDER OR AN ATTORNEY BEFORE RECORDING A NOTICE.

FLORIDA STATUTE 469: ABESTOS ABATEMENT. AS OWNER / CONTRACTOR / AGENT OF RECORD FOR THE CONSTRUCTION APPLIED FOR IN THIS APPLICATION, I AGREE THAT I WILL COMPLY WITH THE PROVISIONS F. S. 469.003 AND TO NOTIFY THE FLORIDA D. E. P. OF MY INTENT TO DEMOLISH / REMOVE ASBESTOS. IN ADDITION TO THE REQUIREMENTS OF THIS PERMIT APPLICATION, THERE MAY BE DEED RESTRICTIONS AND / OR ADDITIONAL RESTRICTIONS APPLICABLE TO THIS PROPERTY THAT MAY BE FOUND IN THE PUBLIC RECORDS OF MONROE COUNTY AND THERE MAY BE ADDITIONAL PERMITS REQUIRED FROM OTHER GOVERNMENT ENTITIES SUCH AS AQUADUCT ATHORITY, FLORIDA DEP OR OTHER STATE AGENCIES; ARMY CORPS OF ENGINEERS OR OTHER FEDERAL AGENCIES.

FEDERAL LAW REQUIRES LEAD PAINT ABATEMENT PER THE STANDARDS OF THE USEP ON STRUCTURES BUILT PRIOR TO 1978.

OFFICIAL USE ONLY BY PLANS EXAMINER OR CHIEF BUILDING OFFICIAL:				CBO OR PL. EXAM. APPROVAL:
HARC FEES:	BLDG. FEES:	FIRE MARSHAL FEE:	IMPACT FEES:	
				DATE:

APPLICATION

HARC MAJOR PROJECTS CERTIFICATE OF APPROPRIATENESS

\$400 NON-REFUNDABLE BASE APPLICATION FEE - OTHER FEES MAY BE APPLICABLE



City of Key West
 1300 WHITE STREET
 KEY WEST, FLORIDA 33040

HARC COA # Blg. 19-1671	REVISION #	INITIAL & DATE
FLOOD ZONE Rev. 1	ZONING DISTRICT	BLDG PERMIT #

A PRE-APPLICATION MEETING WITH HARC STAFF IS REQUIRED PRIOR TO SUBMITTAL

ADDRESS OF PROPOSED PROJECT:	529 Caroline St. Key West	
NAME ON DEED:	SUR 529 LLC	PHONE NUMBER 352-494-2338
OWNER'S MAILING ADDRESS:	506 Fleming St.	EMAIL Billy@Spottswood.com
APPLICANT NAME:	Chas Spottswood	PHONE NUMBER 305 360 0802
APPLICANT'S ADDRESS:		EMAIL chas@Keystarconstruction.com
APPLICANT'S SIGNATURE:		DATE 1/2/20

ANY PERSON THAT MAKES CHANGES TO AN APPROVED CERTIFICATE OF APPROPRIATENESS MUST SUBMIT A NEW APPLICATION.

FLORIDA STATUTE 837.06: WHOEVER KNOWINGLY MAKES A FALSE STATEMENT IN WRITING AND WITH THE INTENT TO MISLEAD A PUBLIC SERVANT IN THE PERFORMANCE OF HIS OR HER OFFICIAL DUTY SHALL BE GUILTY OF A MISDEMEANOR OF THE SECOND DEGREE PUNISHABLE PER SECTION 775.082 OR 775.083. THE APPLICANT FURTHER HEREBY ACKNOWLEDGES THAT THE SCOPE OF WORK AS DESCRIBED IN THE APPLICATION SHALL BE THE SCOPE OF WORK THAT IS CONTEMPLATED BY THE APPLICANT AND THE CITY. THE APPLICANT FURTHER STIPULATES THAT SHOULD FURTHER ACTION BE TAKEN BY THE CITY FOR EXCEEDING THE SCOPE OF THE DESCRIPTION OF WORK, AS DESCRIBED HEREIN, AND IF THERE IS CONFLICTING INFORMATION BETWEEN THE DESCRIPTION OF WORK AND THE SUBMITTED PLANS, THE AFOREMENTIONED DESCRIPTION OF WORK SHALL BE CONTROLLING.

PROJECT INCLUDES: REPLACEMENT OF WINDOWS RELOCATION OF A STRUCTURE ELEVATION OF A STRUCTURE

PROJECT INVOLVES A CONTRIBUTING STRUCTURE: YES NO INVOLVES A HISTORIC STRUCTURE: YES NO

PROJECT INVOLVES A STRUCTURE THAT IS INDIVIDUALLY LISTED ON THE NATIONAL REGISTER: YES NO

DETAILED PROJECT DESCRIPTION INCLUDING MATERIALS, HEIGHT, DIMENSIONS, SQUARE FOOTAGE, LOCATION, ETC.	
GENERAL:	We propose to repair the damaged stucco with a stucco application the stucco repair will only be approximately 5 feet above the front porch elevation and down.
MAIN BUILDING:	
DEMOLITION (PLEASE FILL OUT AND ATTACH DEMOLITION APPENDIX):	

APPLICATIONS MUST BE SUBMITTED IN PERSON WITH HARD COPIES BY 3PM ON THE SCHEDULED DEADLINE
 PLEASE SEND AN ELECTRONIC COPY OF ALL DOCUMENTS TO HARC@CITYOFKEYWEST-FL.GOV

ACCESSORY STRUCTURE(S):	
PAVERS:	FENCES:
DECKS:	PAINTING:
SITE (INCLUDING GRADING, FILL, TREES, ETC.):	POOLS (INCLUDING EQUIPMENT):
ACCESSORY EQUIPMENT (GAS, A/C, VENTS, ETC.):	OTHER:

OFFICIAL USE ONLY:	HARC COMMISSION REVIEW	EXPIRES ON:
MEETING DATE:	<input type="checkbox"/> APPROVED <input type="checkbox"/> NOT APPROVED <input type="checkbox"/> DEFERRED FOR FUTURE CONSIDERATION	INITIAL:
MEETING DATE:	<input type="checkbox"/> APPROVED <input type="checkbox"/> NOT APPROVED <input type="checkbox"/> DEFERRED FOR FUTURE CONSIDERATION	INITIAL:
MEETING DATE:	<input type="checkbox"/> APPROVED <input type="checkbox"/> NOT APPROVED <input type="checkbox"/> DEFERRED FOR FUTURE CONSIDERATION	INITIAL:
REASONS OR CONDITIONS:		
STAFF REVIEW COMMENTS:		
<div style="font-family: cursive; color: blue; font-size: 1.2em;"> Home is a contributing resource to the historic district. </div>		
FIRST READING FOR DEMO:	SECOND READING FOR DEMO:	
HARC STAFF SIGNATURE AND DATE:	HARC CHAIRPERSON SIGNATURE AND DATE:	

THIS APPLICATION MAY BE REVIEWED BY PLANNING DEPARTMENT STAFF.

Subject: RE: Looking for matching brick
Date: Thursday, September 19, 2019 at 1:48:19 PM Eastern Daylight Time
From: Tom Angeley
To: Chas Spottswood
Attachments: image002.png

I'm pretty some fire brick are 8 ¼ in length, maybe you could stain the brick. Sorry but that's a tough one.

From: Chas Spottswood [mailto:chas@keystarconstruction.com]
Sent: Thursday, September 19, 2019 11:19 AM
To: Tom Angeley
Subject: Looking for matching brick

Tom,

Thanks for taking my call, here are some photos on the brick I need to match. Any help would be greatly appreciated.

Thanks,

Chas Spottswood

KEYSTAR

Chas@Keystarconstruction.com

305.294.5909 (Office)

305.360.0802 (Mobile)

Total Control Panel

[Login](#)

To: tom@stilesandhart.com

Message Score: 15

High (60): Pass

From: chas@keystarconstruction.com

My Spam Blocking Level: Medium

Medium (75): Pass

Low (90): Pass

[Block](#) this sender

[Block](#) keystarconstruction.com

This message was delivered because the content filter score did not exceed your filter level.

Subject: Re: key west project
Date: Wednesday, September 18, 2019 at 3:13:01 AM Eastern Daylight Time
From: Authentic Reclamation
To: Chas Spottswood
Attachments: image001.png, Outlook-ka3yycu1.jpg

Hello,

We unfortunately don't have anything in the quantity you are after which is a good match

Kind regards,
Myah



From: Chas Spottswood <chas@keystarconstruction.com>
Sent: 17 September 2019 16:35
To: Authentic Reclamation <info@authentic-reclamation.co.uk>
Cc: Victoria Ashmore <vashmore@keystarconstruction.com>; Tony Roberts <troberts@keystarconstruction.com>
Subject: key west project

Hello,

I am looking for about 2,000 brick for a restoration project. Here are some photos. Please email me back, any help is greatly appreciated.

Thanks,

Chas Spottswood
KEYSTAR
Chas@Keystarconstruction.com
305.294.5909 (Office)
305.360.0802 (Mobile)

Nick

Nick Olson | Project Manager | Specialized Property Services, Inc.
9605 US Highway 92 East, Tampa, FL 33610
Office 813.246.4274 | Mobile 813.447.0664 | Fax 813.514.2794
| nickolson@sps247.net | www.specializedpropertyservices.com

From: Chas Spottswood <chas@keystarconstruction.com>
Sent: Thursday, September 19, 2019 11:54 AM
To: Nick Olson <NickOlson@sps247.net>
Subject: Re: 529 Caroling Key West Red Brick Restoration

Hey Nick,

Thanks for chatting with me about my project. Here are some picture of the brick I need to match. Any help would be greatly appreciated.

Thanks,

Chas Spottswood
KEYSTAR
Chas@Keystarconstruction.com
305.294.5909 (Office)
305.360.0802 (Mobile)

From: Chas Spottswood <chas@keystarconstruction.com>
Date: Tuesday, September 17, 2019 at 3:55 PM
To: "NickOlson@sps247.net" <NickOlson@sps247.net>
Subject: 529 Caroling Key West Red Brick Restoration

Hello Nick,

Enid Torres gave me your contact. I am a GC here in KW and just started a red brick restoration project. Enid mentioned you may be able to help me find matching brick.

Call or email me anytime. Thanks,

Chas Spottswood
KEYSTAR
Chas@Keystarconstruction.com
305.294.5909 (Office)
305.360.0802 (Mobile)

Subject: RE: 529 Caroling Key West Red Brick Restoration
Date: Thursday, October 3, 2019 at 4:09:03 PM Eastern Daylight Time
From: Nick Olson
To: Chas Spottswood
Attachments: image004.png

Chas,

I'm not sure if you'd had any luck with finding the brick yet, but I've done a bit of research and talked to some of my people and haven't come up with any exact matches for you. The problem is the size of the brick. It is a real odd ball size, and I am not sure if anyone makes a brick that size. It is possible that may even be a road brick, or was made by a company that made road brick. Sometimes municipalities have salvaged road brick in storage, if they've pulled them up to install pavement, but that may not be the case in the Keys. Below I have listed out a bunch of different brick manufacturers that I would check with. Sometimes they will make custom sizes for you, but you would have to order at least 100,000 brick, in some cases. I hope this helps.

- Acme Brick
- Acme Brick
- Bowerston Shale Company
- Brampton Brick Inc.
- Carolina Ceramics (This is where I got the brick for the Custom House, it was the Cherry Smooth, Rosewood Smooth, and the Terra Cotta Smooth)
- Cherokee Brick (They do custom sizes)
- Endicott Clay Products Company
- General Shale, Inc.
- Columbus Brick Company
- Watsontown Brick Company
- Glen-Gery Corporation
- Hebron Brick Supply Company
- Henry Brick Company, Inc.
- Lee Brick & Tile Company, Inc.
- Marion Ceramics
- McNear Brick & Block
- Meridian Brick
- Morin Brick Company
- Palmetto Brick
- Pine Hall Brick Company, Inc.
- Statesville Brick Company
- Sioux City Brick
- Taylor Clay Products Company
- The Belden Brick Company
- Redland Brick Inc.
- Richards Brick Company
- The McAvoy Brick Company
- The Stiles & Hart Brick Company
- Triangle Brick Company
- Whitacre Greer Company

Subject: FW: 529 Caroline Brick Repairs
Date: Monday, October 7, 2019 at 10:38:08 AM Eastern Daylight Time
From: Chas Spottswood
To: Enid Torregrosa, Tom Pope
CC: John Spottswood III
Attachments: image001.png, AuthenticReclamation.pdf, StilesandHArt.pdf, 536 Fleming.png, 601 Fleming.png, 201 Siminton.png, NickOlson.pdf

Enid,

After months of searching I have not been able to find matching brick for the 529 Caroline project. I have reached out to many manufacturers, and reclamation experts around the country and one in Europe and no one I found has or will make a matching brick. See attached correspondence from some of the companies I contacted. Stiles and Hart is the company Bert Bender's office referred me to and the other, Authentic Reclamation, is also an expert reclamation company of historic building materials. Everyone I have spoken with says the 8-1/2" length is very unique and is not made any longer.

I should have the mortar and brick testing report back this week from US Heritage, do I need to submit this to HARC?

At this juncture I feel it may be best to replicate the same method as demonstrated at 536 Fleming, 601 Fleming and 201 Siminton, see attached photos. This may be better than trying to use a brick that does not match size, color and density/strength.

Thanks,

Chas Spottswood

KEYSTAR

Chas@Keystarconstruction.com

305.294.5909 (Office)

305.360.0802 (Mobile)

SANBORN MAPS

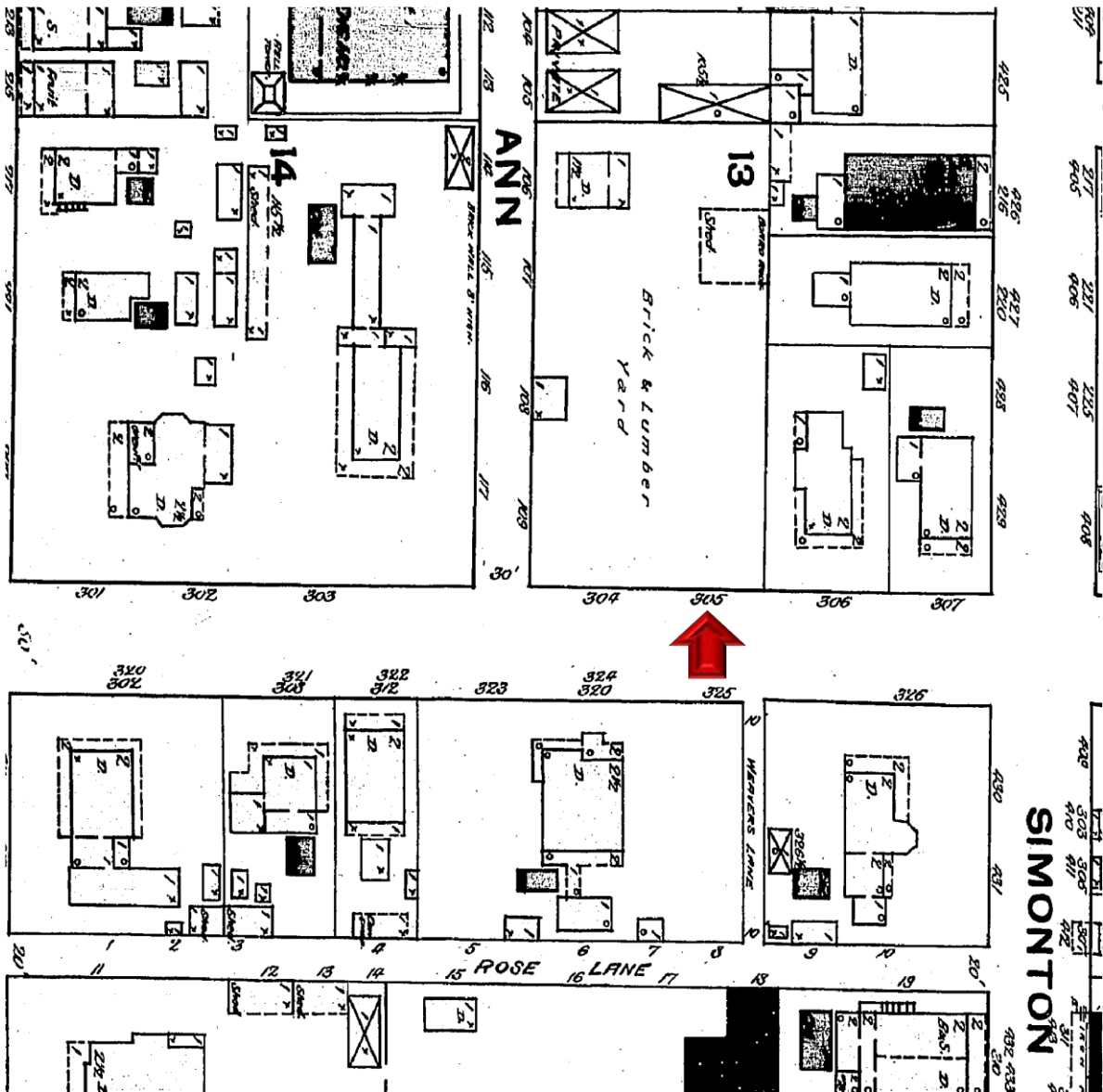

1892 Sanborn Map

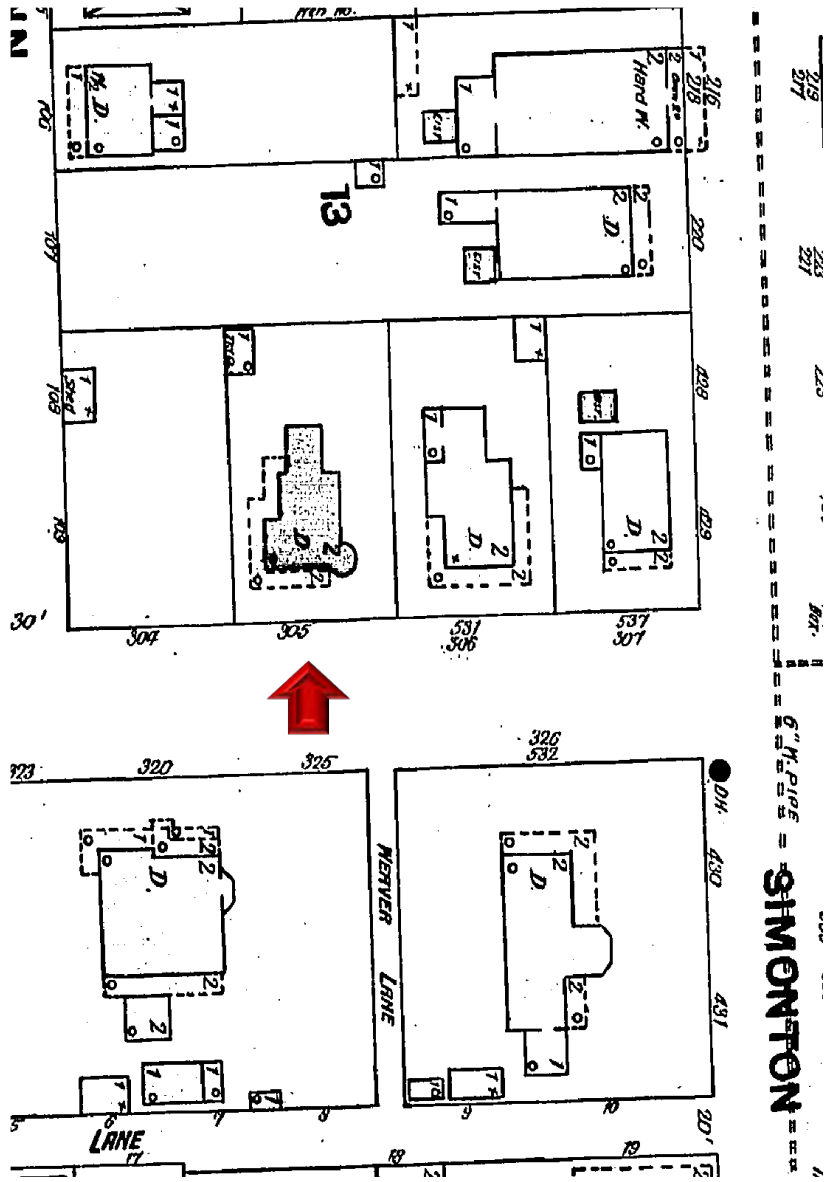

1899 Sanborn Map

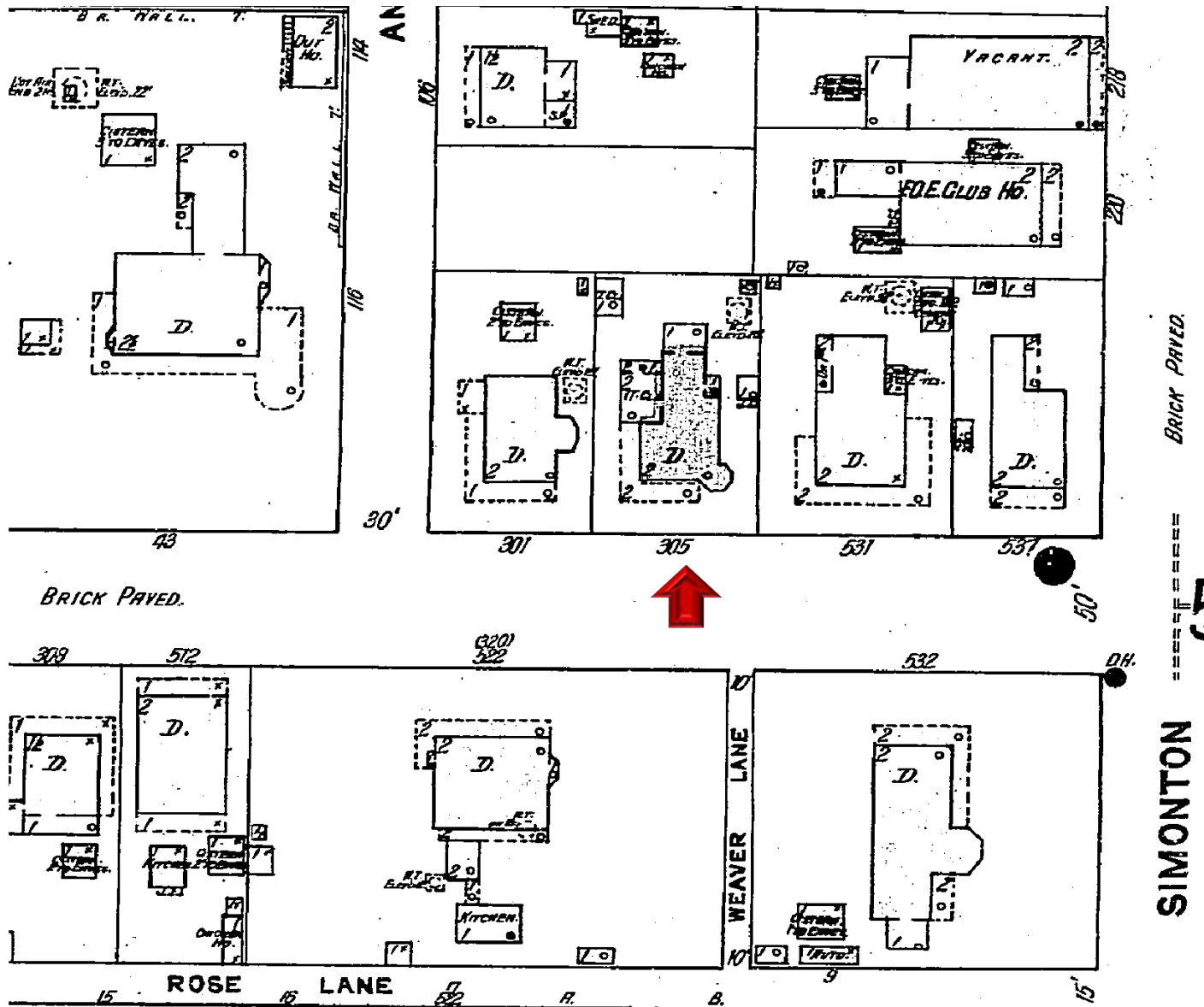

1912 Sanborn Map

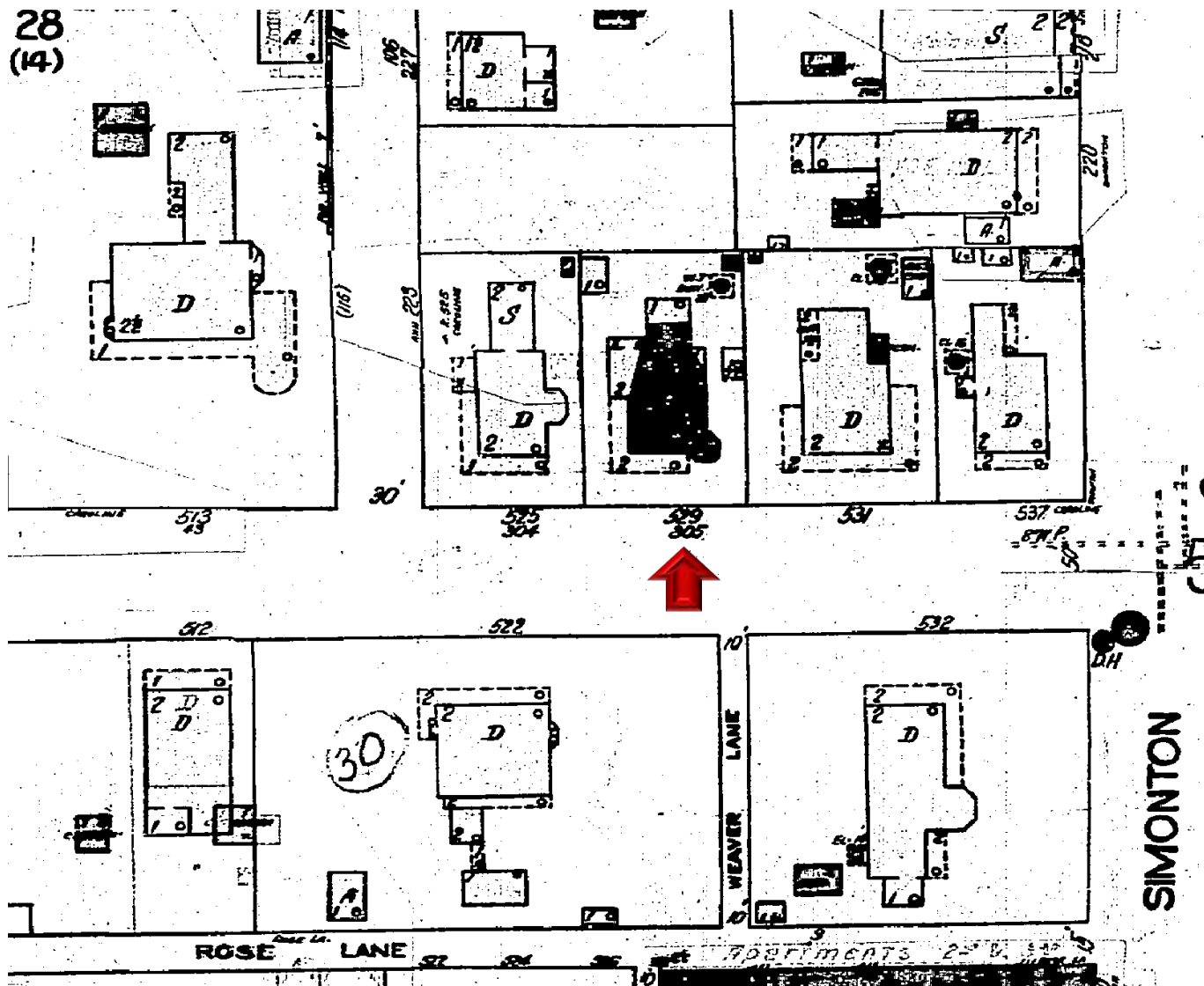

1948 Sanborn Map

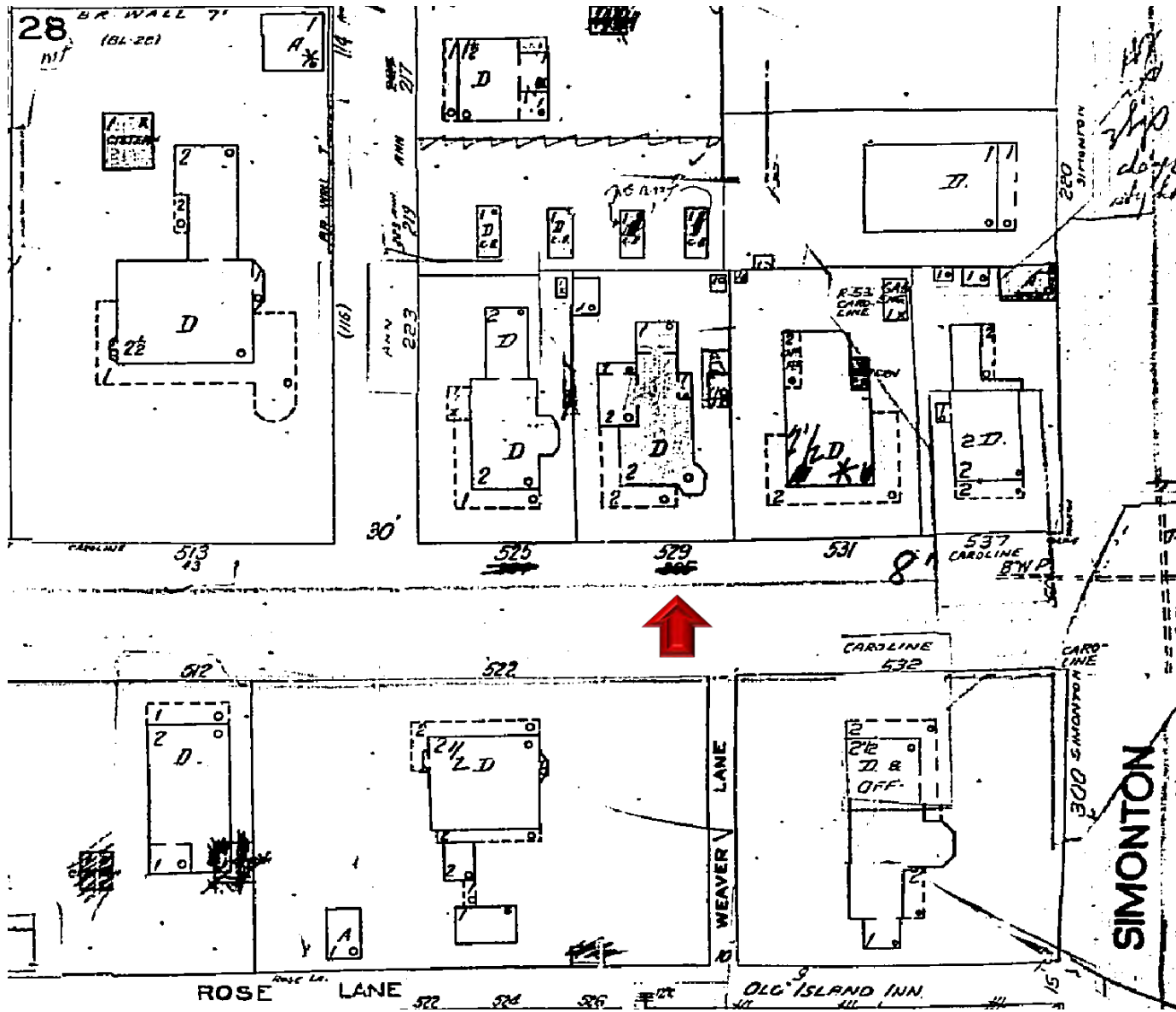

1962 Sanborn Map

PROJECT PHOTOS



529 Caroline Street circa 1965. Monroe County Library.



Current conditions, entryway.



Current conditions front view of turret as removal of layers of paint has finished. New repointing at the upper portion of the turret.

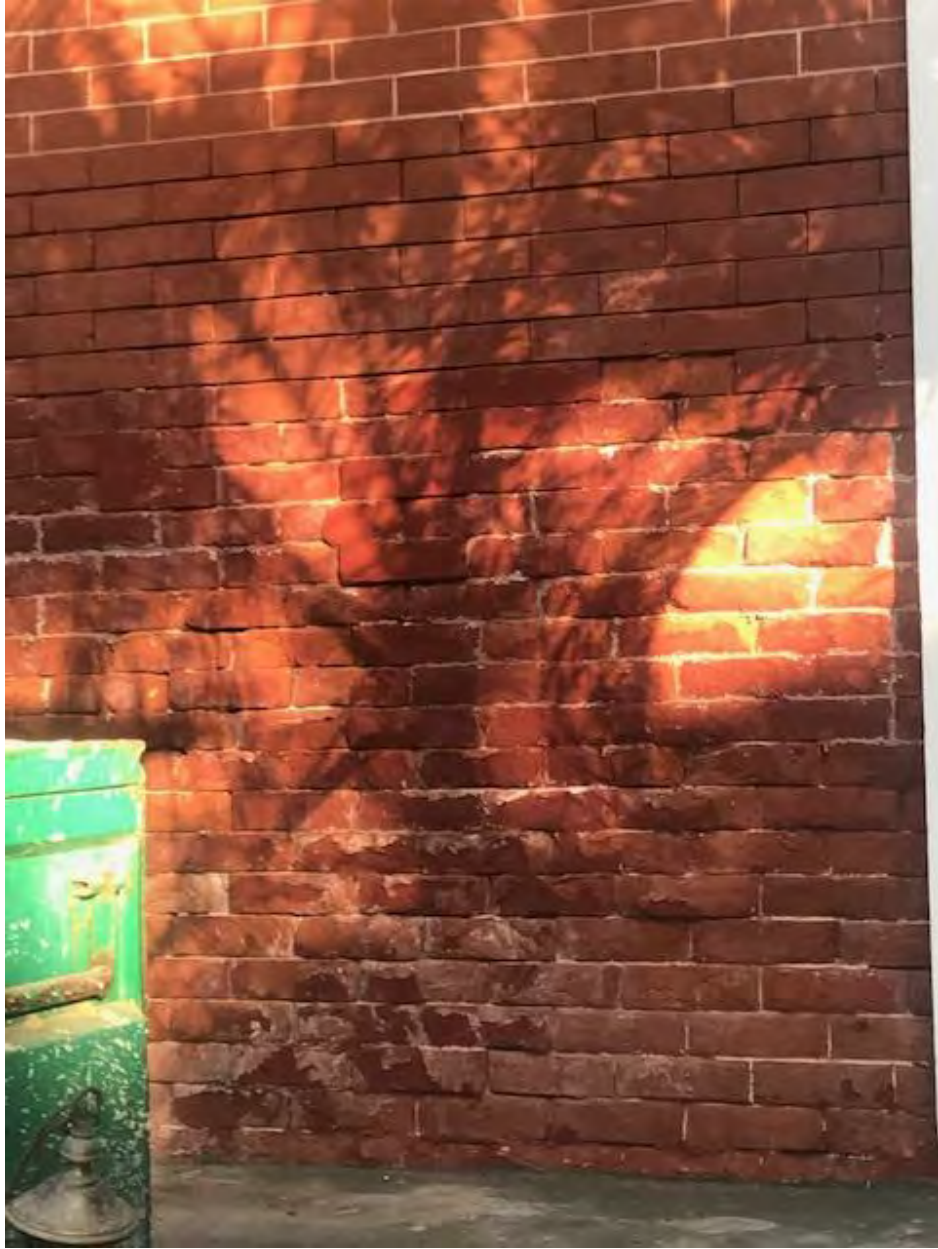

Current conditions, detail of front wall.



Current conditions, detail front wall.



Current conditions front view of turret



Current conditions, detail of lower portion of turret.

PROPOSED DESIGN

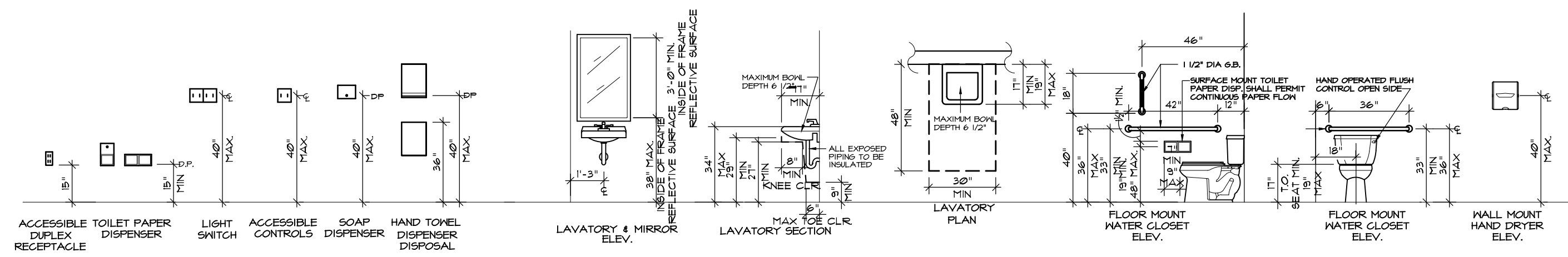

Typical ADA Details

1/4" = 1' - 0"

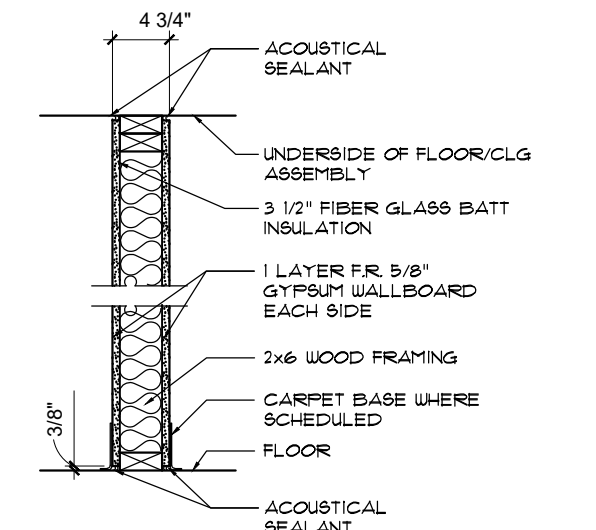

PARTITION TYPE - ONE HOUR 4
 FIRE: 1 HR
 U.L. U200
 SOUND: STC50
 TYPICAL APPLICATION: PARTITION WALL

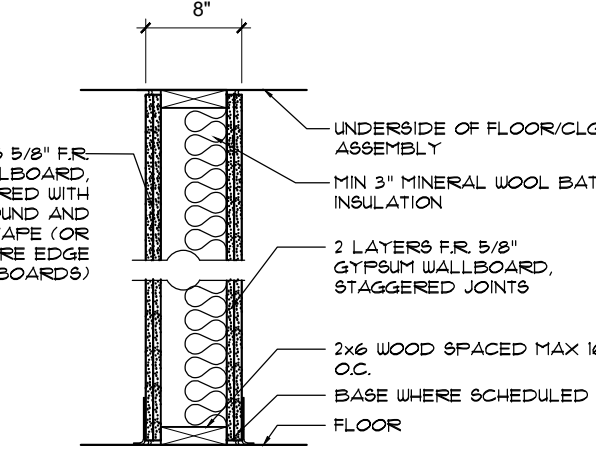

PARTITION TYPE - ONE HOUR 3
 FIRE: 2 HR3
 U.L. U200
 SOUND: STC54
 TYPICAL APPLICATION: FIRE RATED PLUMBING WALL

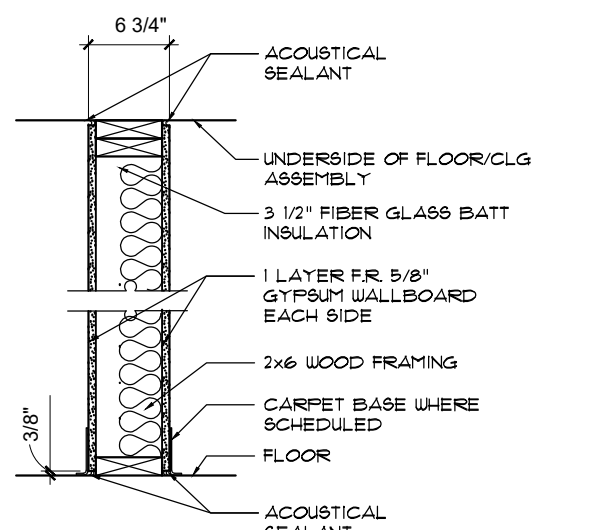

PARTITION TYPE - NON RATED 2
 FIRE: 1 HR
 U.L. U200
 SOUND: STC50
 TYPICAL APPLICATION: PLUMBING WALL

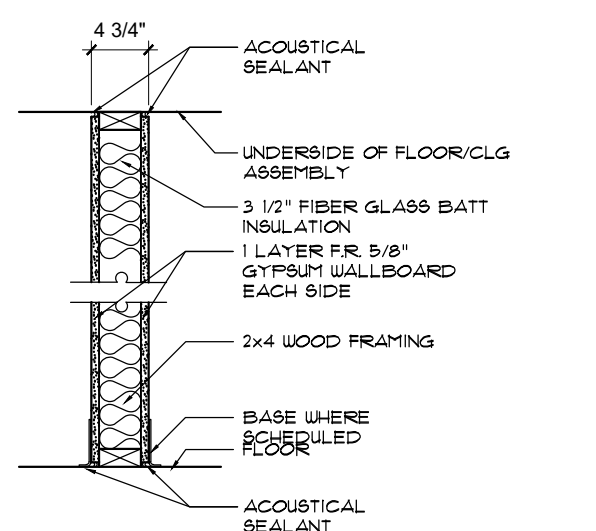

PARTITION TYPE - NON RATED 1
 FIRE: N/A
 U.L. N/A
 SOUND: N/A
 TYPICAL APPLICATION: TYPICAL WALL

Typical Wall Details

3/4" = 1' - 0"

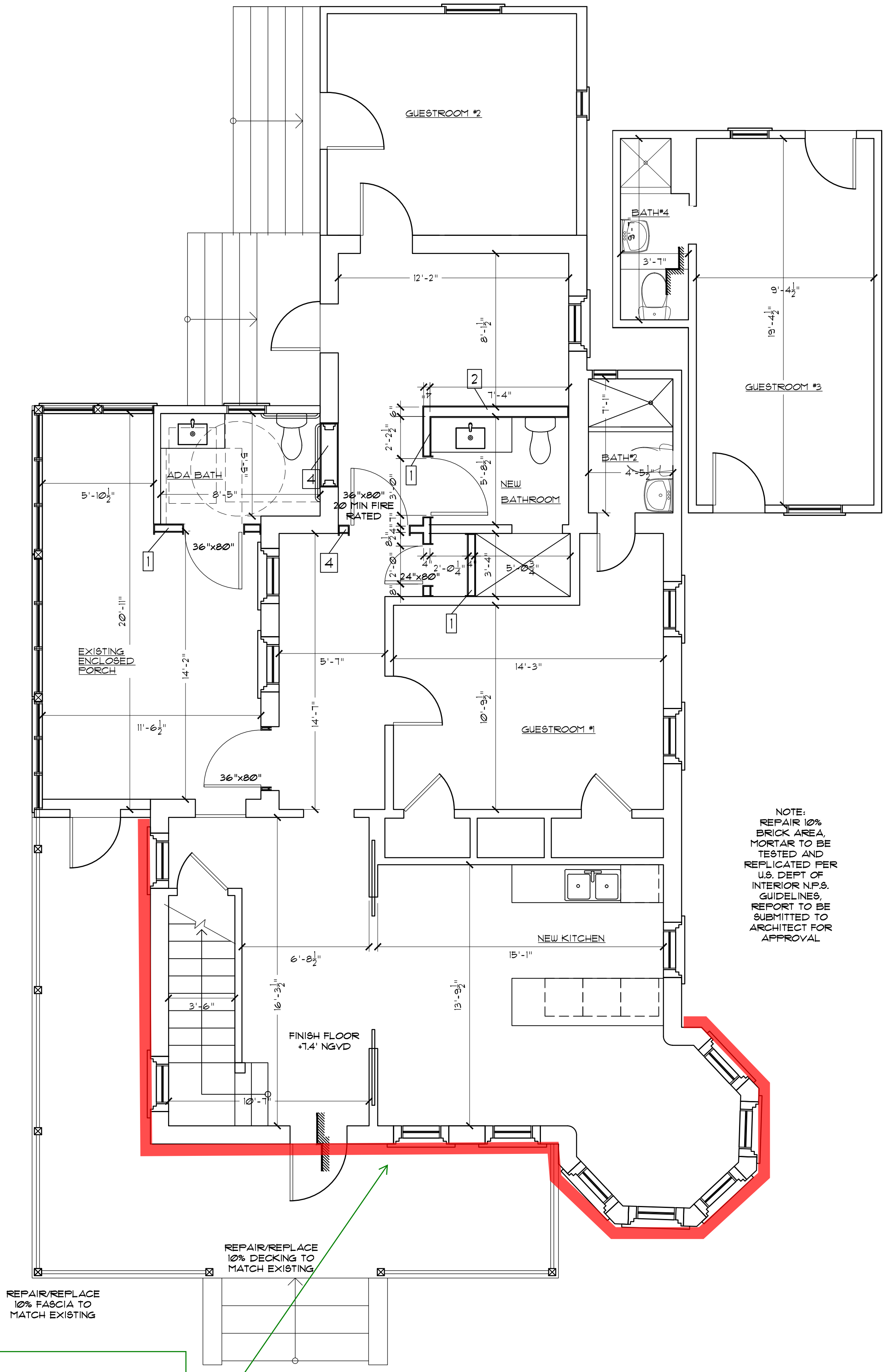
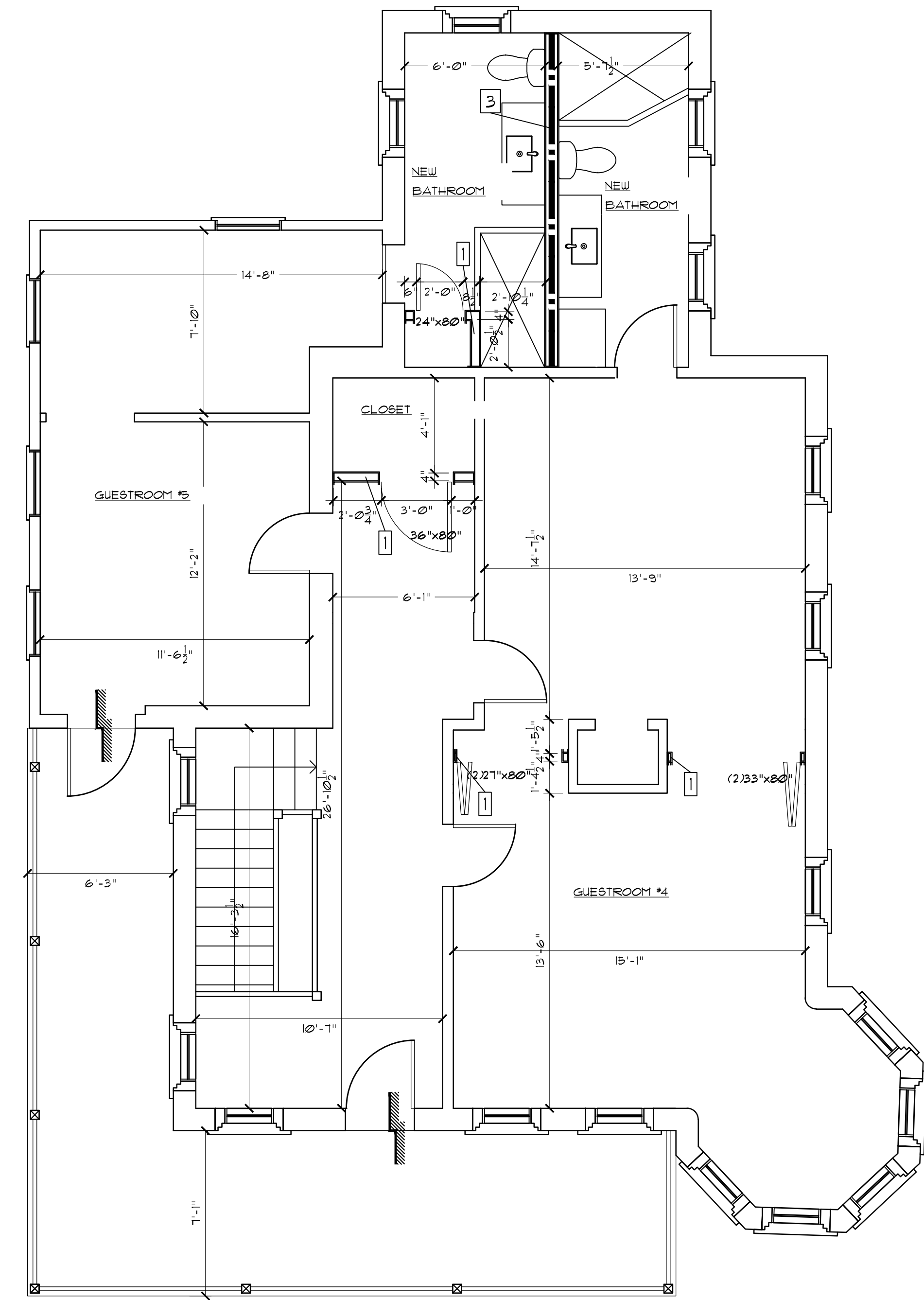

Red line indicates area of proposed stucco repairs

Proposed First Floor Plan
 1/4" = 1' - 0"

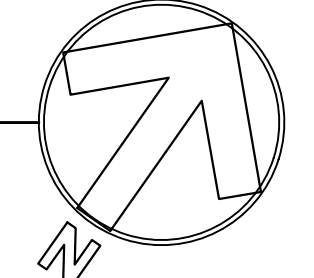

529 Caroline St
 Key West, FL

THOMAS E. POPE, P.A.
 POPE - SCARBROUGH - ARCHITECTS
 610 White St, Key West FL
 (305) 296 3611

date: 5/7/19
 revision:

sheet: A1.1

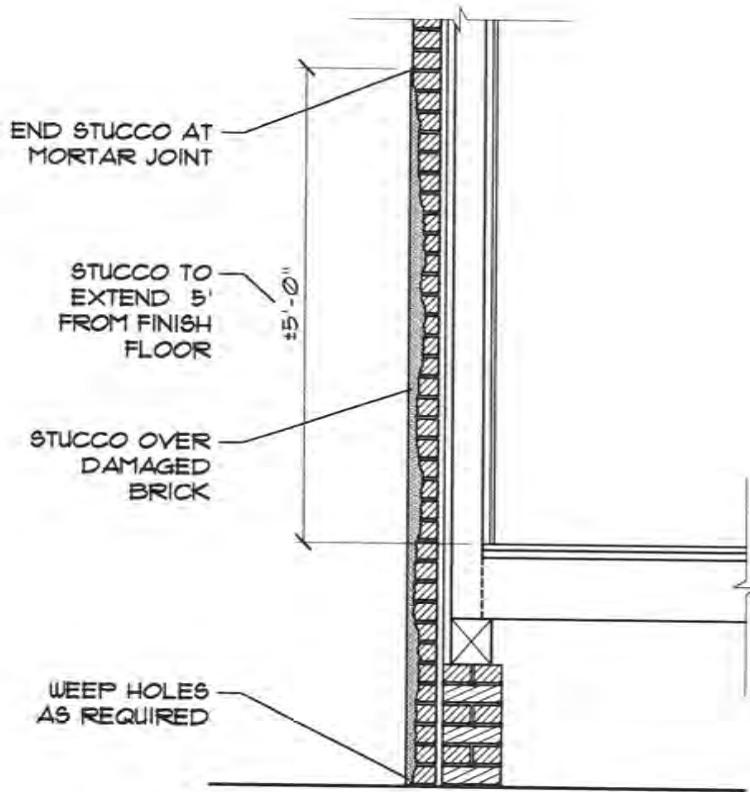

Stucco Detail

1/2" = 1' - 0"

date:
revision:

529 Caroline St.
529 Caroline Street Key West, FL

THOMAS E. POPE, P.A.
POPE-SCARBROUGH-ARCHITECTS
610 White St, Key West FL
(305) 296 3611



Proposed area for stucco repairs



proposed area of
stucco repair

Project: USHG #19-153B

October 18, 2019



Lisa Littlefield
Concrete Analysis and Testing Lab
1600 Yellowtail Ave.
Marathon, FL 33050
Phone: 305-393-0643

EVALUATION OF ORIGINAL AND REPLACEMENT BRICK – ASTM C67 529 Caroline St. Key West

INTRODUCTION

5 samples of original brick were received for analysis on September 30, 2019. Assuming the bricks provided are representative of the existing bricks, the analysis detailed in this report will give a reliable indication of the physical characteristics of the bricks in the structure.

The project identification in our file is: USHG#19-153B.

METHODS OF ANALYSIS

ASTM C67 - The sample was analyzed according to procedures and examination methods of ASTM C67, "Standard Test Methods for Sampling and Testing Brick and Structural Clay Tile".

The bricks were examined for physical measurements and tested for compressive strength. The results of the testing are presented on page 2.

Respectfully submitted,
U.S. Heritage Group, Inc.

A handwritten signature in black ink that reads "Tai Olson".

Tai Olson
Laboratory Manager



RESULTS - COMPRESSIVE STRENGTH

Bricks: 529 Caroline St. Key West—USHG #19-153B

ASTM C67 – Physical Analysis of Clay Face Brick – Section 7 - Compressive Strength

Nominal Brick Size 2.4" x 4.2" x 7.9"

<i>Unit No.</i>	<u>1</u>	<u>2</u>	<u>3</u>	<u>4</u>	<u>5</u>	<u>AVG</u>
Compressive Strength (psi)	3,290	4,300	3,360	3,910	4,710	3,910





Custom Mortar Matching Report

USHG Project: # 19-153

Analysis Date: 10/01/2019

Project: 529 Caroline Street, Key West, FL

Client: Lisa Littlefield, Concrete Analysis & Testing Laboratories

PO Box 500875, Marathon, FL 33050

Client Requirements: Match Mortar / Package B

Mortar Dating: unknown

Location/Function in Building: unknown

INTRODUCTION

The findings and recommendations presented in this report are premised on the results of tests performed on two mortar samples delivered to our laboratory on September 30, 2019.

The scope of testing was limited to the determination of the physical mix proportions of the major ingredients used in the mortar samples. The testing included visual examination, both with and without magnification, as well as analysis of the aggregate color, particle shape and grain size distribution.

The sample's physical characteristics, original date of construction, and guidelines from the U.S. Department of the Interior National Park Service were used to determine the proposed mortar component recommendations as well as the aggregate ratios for the replacement mix.

U.S. Heritage Group interpreted and adjusted the proposed mortar formulation recommendation based on the information provided to us regarding: current site conditions; present condition and type of masonry; the function of the new mortar; and the degree of weather exposure. Assuming the sample provided is representative of the original mortar, the analysis and mortar-matching diagnosis detailed in this report here will give a reliable indication of the original ingredients and allow U.S. Heritage Group to recommend a historically correct mortar formulation for your project.

SAMPLES

The samples were identified in our laboratory as:

- 1) #19-153-1 529 Caroline St, K West, FL - Sample1 2) #19-153-2 529 Caroline St, K West, FL - Sample2

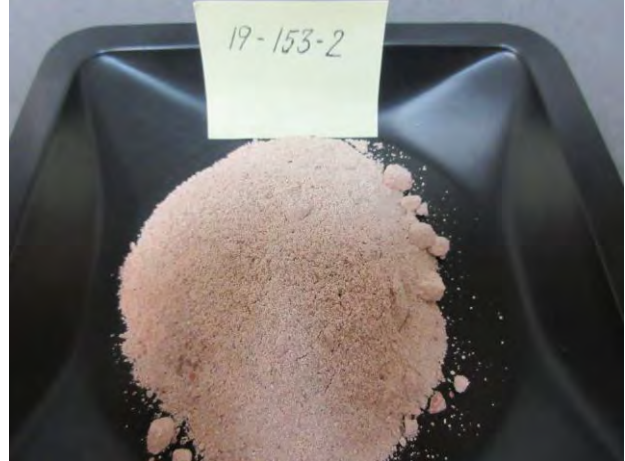
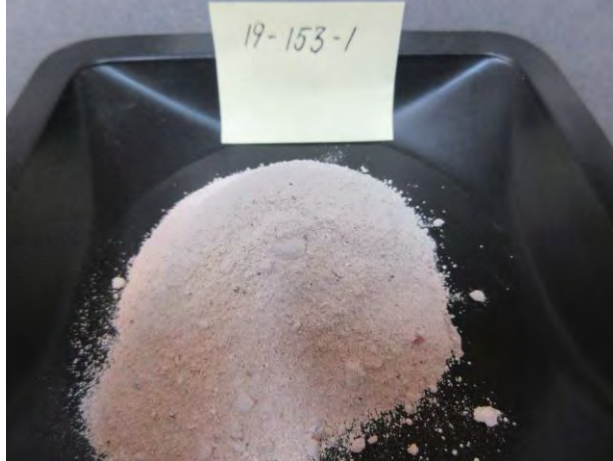

PRELIMINARY TESTING

Samples were different in color however both were delivered in the form of dust, which suggests they represent similar mixes. The fact that the samples were provided in the form of dust allows us to conclude about the very low compressive strength of the tested mortars.

AGGREGATE ANALYSIS

Next, we chemically removed the binder from the aggregate using a dilute acid solution. After drying the aggregate, we viewed it under 40X magnification to determine the characteristics of the particles. A sieve separation process established the distribution of aggregate particles by a percent of total weight. We prepared a gradation charts to graphically display the color, shape and size of the aggregate particles. The aggregate sieve sizes requisite in ASTM C144 meet ASTM E11 specification requirements.

The sand weight retained on each testing sieve was as follow:

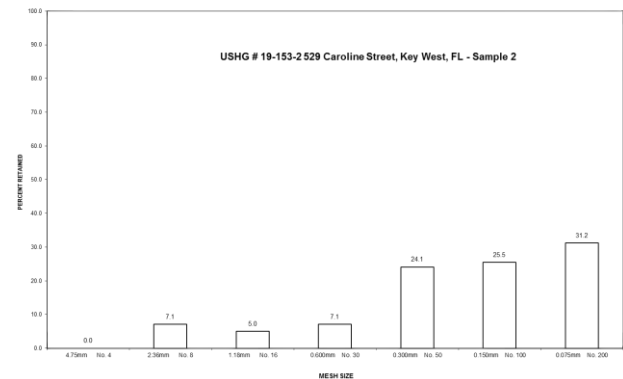
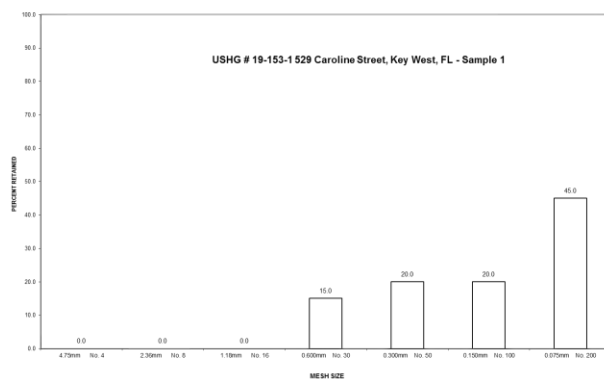

Samples:	#19-153-1 Sample 1	#19-153-2 Sample 2
Testing Sieve Size	% of sand retained	
4.75mm, No. 4	0.0	0.0
2.36mm, No. 8	0.0	7.1
1.18mm, No. 16	0.0	5.0
600micro, No. 30	15.0	7.1
300micro, No. 50	20.0	24.1
150micro, No. 100	20.0	25.5
75micro, No. 200	45.0	31.2
Total sand weight	100%	100%

Based on the particle color and shape similarities it appears that both mortars were likely made using aggregate from the same area. Variation in aggregate gradation is untypical for natural sand and suggest that majority of aggregate used in the mix is not a silica sand. Grated brick and small shards of brick appear in the aggregate. Original aggregate extracted from mortar sample #19-153-1 529 Caroline Street, Key West, FL – Sample 1 is classified as fine-sized aggregate and sand extracted from mortar sample #19-153-2 529 Caroline Street, Key West, FL – Sample 2 is classified as mix of fine and medium-sized aggregate.

BINDER TO AGGREGATE RATIO

The binder percentage in each mortar sample was established and found to be above 90% for both samples, which would be considered an extremely binder rich formulation. The results of this calculation can be affected by the presence of calcium carbonate in the aggregate which would have been dissolved out during the chemical wet process. Another argument for this is the high speed and rapidity of the chemical reaction. Those factors were considered in the evaluation of the proposed replacement formulation.

Sample	#19-153-1 Sample 1	#19-153-2 Sample 2
Binder	98.7%	90.6%
Aggregate	1.3%	9.4%

SUMMARY OF TEST RESULTS

Low compressive strength results for both samples were assumed. The material reaction noted during chemical wet process was very similar for both samples and did not indicated presence of a hydraulic component in the material. This coupled with the samples' appearance, suggests that they were originally mixed using non-hydraulic slaked lime putt and aggregate (mostly limestone). However, these are the conclusions obtained on the base of analysis of samples provided in the form of dust. For a final, full judgment it is necessary to analyze solid mortar samples.

PROPOSED REPLACEMENT MIX

In light of these findings and the intended use of the replacement material, U.S. Heritage Group recommends specifying the following replication mortar formulations for both projects (19-153-1 Sample 1 and 19-153-2 Sample 2):

1 part slaked lime putty and 2.5 parts sand selected from the USHG sand library.

Mineral-based color pigments were used to match the original color of exterior mortar.

Above recommendation was made in accordance with Preservation Brief 2:

“The new mortar must be as vapor permeable and as soft or softer (measured in compressive strength) than the historic mortar.”

Note: Masonry work using this formulation must be completed 28 days prior to freeze thaw cycles occurring. Do not perform any masonry work unless air temperatures are between 40 degrees Fahrenheit (10 degrees Celsius) and 95 degrees Fahrenheit (32 degrees Celsius) and will remain so for at least 5 weeks after the completion of the work.

Slaked lime putty should be aged for a minimum of three months before use in a mortar mix. Building elements such a chimney or foundation wall may require addition of hydraulic component in the mortar. Type and amount of hydraulic additive used in a new mortar should be established based on the condition of the existing masonry units to make sure that new installed mortar is softer with greater rate of water absorption.

JOBSITE MOCK-UP SAMPLE

The replacement mortar sample should be field-tested through a jobsite mock-up. The mock-up sample should be installed by a qualified craftsperson who understands the curing and application details of traditional lime mortars. Once the mock-up sample is installed, appropriate precautions should be taken to ensure that the mortar is protected from wind, sun, rain and frost to enable slow curing (i.e. carbonation) to take place.

Thank you for seeking our advice and entrusting these important details to U.S. Heritage Group. We are always available to discuss these findings with you in detail. Please contact me directly at 773-286-2100 if you have any questions.

We look forward to providing you with a custom, ready-to-use, historically correct mortar for your project.

Respectfully,

U.S. Heritage Group, Inc.



Tai Olson
Laboratory Manager



Piotr Psuja PhD Eng.
Laboratory Manager

Note: This information is held in confidence and becomes a permanent record at the U.S. Heritage Group laboratories located at 3516 North Kostner Ave., Chicago, IL 60641. It can be referenced at any time in the future by the property owner named above or by an authorized mason contractor involved with the restoration work. When inquiring about this match please use the project number USHG #19-153.



EUCLID CHEMICAL

EUCOREPAIR V100

**LOW SHRINKAGE, FIBER REINFORCED, NSF/ANSI STANDARD 61
CERTIFIED VERTICAL & OVERHEAD REPAIR MORTAR**

DESCRIPTION

EUCOREPAIR V100 is a single-component, quick-setting, low shrinkage repair mortar formulated with unique polymers and fiber reinforcement for vertical and overhead repairs requiring high performance.

PRIMARY APPLICATIONS

- Vertical and overhead repairs
- Marine structures, tunnels, and dams
- Parking structures & bridges
- Above and below grade applications
- Water and wastewater treatment facilities

FEATURES/BENEFITS

- Single-component for easy mixing and handling
- Contains an integral corrosion inhibitor
- Excellent freeze-thaw resistance for difficult climates
- Low permeability helps protect rebar from corrosion
- Polymer modified with fiber reinforcement
- High bond strength provides excellent adhesion
- NSF/ANSI Standard 61 certified
- Apply coatings after 6 hours at 70°F (21°C)

TECHNICAL INFORMATION

The following are typical values obtained under laboratory conditions. Expect reasonable variation under field conditions.

PROPERTY	RESULTS
Compressive Strength ASTM C109 modified, 2" (5 cm) cubes, psi (MPa)	3 hours 2,000 (13.8)
	1 day 3,000 (20.7)
	7 days 4,500 (31.0)
	28 days 6,000 (41.4)
Split Tensile Strength ASTM C496, psi (MPa)	28 days >400 (2.8)
Flexural Strength ASTM C348, psi (MPa)	7 days >500 (3.4)
	28 days >600 (4.1)
Bond Strength ASTM C882, psi (MPa)	7 days >1,400 (9.7)
	28 days >1,800 (12.4)
Length Change ASTM C157 modified (3"x3"x11.25" specimens)	28 days -0.020%
Unit Weight	~ 120 lb/ft ³ (1,922 kg/m ³)
Set Times	Initial: ~ 20 min. Final: ~ 35 min.

Appearance: EUCOREPAIR V100 is a free-flowing powder designed to be mixed with water. After mixing and placing, the color may appear darker than the surrounding concrete. While this color will lighten as EUCOREPAIR V100 cures and dries out, the repair may always appear darker than the surrounding concrete.

PACKAGING/YIELD

EUCOREPAIR V100 is packaged in 46 lb (21 kg) moisture resistant bags, and 46 lb (21 kg) pails. **Yield:** 0.45 ft³ (0.013 m³) per 46 lb (21 kg) bag/pail when mixed with 1 gal (3.79 L) of water.

SHELF LIFE

1 year in original, unopened package

SPECIFICATIONS/COMPLIANCES

EUCOREPAIR V100 is NSF/ANSI Standard 61 certified for use with potable water

COVERAGE

One unit of EUCOREPAIR V100 will cover approximately 10.5 ft² (1.0 m²) when placed at an average depth of 1/2" (13 mm).

DIRECTIONS FOR USE

Surface Preparation: Concrete surfaces must be structurally sound, free of loose or deteriorated concrete and free of dust, dirt, paint, efflorescence, oil and all other contaminants. Mechanically abrade the surface to achieve a surface profile equal to CSP 5 - 7 in accordance with ICRI Guideline 310.2. Properly clean profiled area.

Priming & Bonding (Saw Cut & Chipped Out Repairs): Thoroughly clean any exposed reinforcing steel, and apply DURALPREP A.C. to the concrete and the reinforcing steel within the repair area. Refer to the DURALPREP A.C. technical data sheet for full instructions. Alternatively, application of a scrub coat of EUCOREPAIR V100 to the saturated surface dry (SSD) concrete surface may be used for bonding. The repair material must be placed on the scrub coat before the scrub coat dries out.

Priming & Bonding (Vertical & Overhead Skim Coats/Toppings): Apply a scrub coat of EUCOREPAIR V100 to the saturated surface dry (SSD) concrete surface. The repair material must be placed on the scrub coat before the scrub coat dries out.

Mixing: For optimum results, condition material to be mixed to 65°F to 85°F (18°C to 29°C) at least 24 hours prior to use. Single bags may be mixed with a drill and "jiffy" type mixer. Use a paddle type mortar mixer for large jobs. Add the appropriate amount of water, 0.9 to 1 gal (3.40 to 3.79 L)/bag into a clean mixing vessel, then add the dry product. Mix for 3 to 5 minutes. Do not mix more material than can be placed within 15 minutes.

Placement: Do not apply to surfaces or in ambient temperatures below 45°F (7°C). Place in 1/8" to 4" (3 to 100 mm) lifts for vertical surfaces and 1/8" to 2" (3 to 50 mm) lifts for overhead applications. Trowel into place and allow to reach final set before the next lift. If additional lifts are required, score the surface of the placed mortar before it reaches final set.

Finishing: Finish the repair material to the desired texture. Do not add additional water to the surface during the finishing operation. Use EUCOBAR evaporation retarder.

Curing and Sealing: Curing is required. Cure with a Euclid Chemical high solids, water-based curing compound. (NOTE: A SOLVENT BASED CURING COMPOUND SHOULD NOT BE USED ON THIS PRODUCT). Under hot, windy or direct sunlight situations, apply a second coat of curing compound after the first has dried. If a curing compound is not desired, wet cure for a minimum of three days. When curing EUCOREPAIR V100 in potable water vessels, it is recommended to wet cure for 3 days, followed by 4 days of air cure prior to filling the vessel.

CLEAN-UP

Clean tools and equipment with water before the material hardens.

PRECAUTIONS/LIMITATIONS

- Do not allow repairs to freeze until the material has reached a minimum of 1,000 psi (7 MPa) compressive strength.
- Do not use as a horizontal topping.
- Do not add admixtures or aggregate extension.
- When necessary, follow the recommendations in ACI 305R "Guide to Hot Weather Concreting" or ACI 306R "Guide to Cold Weather Concreting".
- Use only potable water for mixing.
- Minimum application thickness 1/8" (3 mm).
- Minimum surface and ambient temperature 45°F (7°C) and rising at time of application.
- For optimum results, condition material to 65°F to 85°F (18°C to 29°C) at least 24 hours prior to use.
- Do not use a solvent based curing compound on this product.
- In all cases, consult the Safety Data Sheet before use.

Rev. 01.20

WARRANTY: The Euclid Chemical Company ("Euclid") solely and expressly warrants that its products shall be free from defects in materials and workmanship for one (1) year from the date of purchase. Unless authorized in writing by an officer of Euclid, no other representations or statements made by Euclid or its representatives, in writing or orally, shall alter this warranty. EUCLID MAKES NO WARRANTIES, IMPLIED OR OTHERWISE, AS TO THE MERCHANTABILITY OR FITNESS FOR ORDINARY OR PARTICULAR PURPOSES OF ITS PRODUCTS AND EXCLUDES THE SAME. If any Euclid product fails to conform with this warranty, Euclid will replace the product at no cost to Buyer. Replacement of any product shall be the sole and exclusive remedy available and buyer shall have no claim for incidental or consequential damages. Any warranty claim must be made within one (1) year from the date of the claimed breach. Euclid does not authorize anyone on its behalf to make any written or oral statements which in any way alter Euclid's installation information or instructions in its product literature or on its packaging labels. Any installation of Euclid products which fails to conform with such installation information or instructions shall void this warranty. Product demonstrations, if any, are done for illustrative purposes only and do not constitute a warranty or warranty alteration of any kind. Buyer shall be solely responsible for determining the suitability of Euclid's products for the Buyer's intended purposes.



EUCLID CHEMICAL

Guide Specification

The Euclid Chemical Company
19215 Redwood Road
Cleveland, OH 44110-2799
Phone: 800-321-7628
Fax: 216-531-9399
www.euclidchemical.com

EUCOREPAIR V100

Single component, low shrinkage, vertical and overhead repair mortar

{Note to Specifier: The paragraphs below are meant to be incorporated into Parts 2 and 3 of a standard CSI 3 Part Format specification, project's General Structural Notes or directly onto the plans. They must be carefully reviewed by a qualified design professional and edited to meet the particular requirements of the project at hand, assure compliance with any governing building codes, and coordinate with other specification sections and drawings.}

PART 2.0: PRODUCT

2. BONDING AGENT/PRIMER

{Note to Specifier: Certain bonding agents, adhesives and primers can be used to enhance the bond of this repair mortar. If desired choose a recommended bonding agent/primer from the data sheet and insert here. (Note: Latex additives will increase the volumetric resistivity of the mortar making it no longer compatible with Galvanic Anode Protection)}

2. CEMENTITIOUS REPAIR MORTAR

- A. Trowelable cementitious repair mortar for vertical and overhead, repairs up to 2" per lift: Cement-based, one component, fiber reinforced, polymer modified repair mortar containing corrosion inhibitor. Material shall have the following properties:
1. Compressive Strength minimum per ASTM C 109 modified 2" cubes
 - 1 day 3,000 psi
 - 7 days 4,500 psi
 - 28 days 6,000 psi
 2. Flexural Strength minimum per ASTM C 348
 - 7 days 500 psi
 - 28 days 600 psi
 3. Spitting Tensile Strength per ASTM C 496
 - 7 day 250 psi
 - 28 day 400 psi
 4. Bond Strength per ASTM C 882
 - 7 day 1,400 psi
 - 28 day 1,800 psi
 5. Modulus of Elasticity per ASTM C 469
 - 28 days 2.65×10^6
 6. Shrinkage per ASTM C 157 50% RH -0.020%
 7. Product:
 - a) Euclid Chemical Company (The); EucoRepair V100
www.euclidchemical.com
- B. Manufacturer shall have ISO 9001 Quality Certification. To ensure compatibility all admixtures shall be from the same manufacturer.
- C. To ensure compatibility bonding agent and curing compound if used shall be from same manufacturer as repair mortar.

2.____ CURING

{Note to Specifier: Euclid Chemical suggests curing this repair mortar with a high solids curing compound. If desired choose a recommended product from the data sheet and insert here. Guide spec language for these products can be found by accessing each product separately through this web site. Be advised that liquid curing compounds are typically not compatible with future penetrating sealer, adhesives or coatings. If such treatments are intended the specifier should insert language for a dissipating resin curing compound such as KUREZ DR VOX, a removable curing compound such as KUREZ RC, or insert language for proper moisture retaining curing methods meeting ACI 308. Duration of such cure should be minimum 3 days.}

PART 3.0: EXECUTION

3.____ SURFACE PREPARATION

- A. Concrete Removal: Remove all loose and unsound concrete per ICRI Guideline 310.1R “Guide for Surface Preparation”
 - 1. Unsound concrete surface areas shall have perimeter boundaries saw cut to minimum depth of ½” inch or less if such depth will cause saw to come in contact with embedded reinforcing steel. Saw cuts shall be made perpendicular to the concrete surface and all concrete removal boundaries shall be straight and aligned parallel to opposite boundary edges resulting in repair areas that are rectangular in shape.
 - 2. All concrete shall be removed from within repair boundary to minimum depth of ½” inch. Provide a surface with suitable profile for bond, as defined in repair mortar manufacturer’s written recommendations. If delaminations, cracking, or unsound materials exist beyond minimum removal depth, then removal shall continue until all unsound, delaminated, or cracked concrete has been removed from cavity.
- B. Preparing Reinforcing Steel: Clean and prepare any exposed embedded reinforcing steel per ICRI Guideline 310.1R. “Guide for Surface Preparation”
 - 1. Where ½ or more of diameter of reinforcement steel is exposed either by existing conditions or concrete removal, bond between the concrete and reinforcing steel is broken, or corrosion is present, the concrete shall be removed to provide a minimum ¾” clearance around entire perimeter of steel and along entire exposed length.
 - 2. Clean all exposed reinforcing steel to bright steel, prior to installation of repair mortar.
 - a) Where section loss on a reinforcing bar is more than *[insert number]*%, or *[insert number]*% in two or more adjacent bars contact Engineer.
- C. Concrete Preparation and Cleaning: Areas to receive concrete repair shall be structurally sound and free from deteriorated concrete, dust, dirt, debris, loosened concrete, paint, oil, efflorescence, laitance, and other contaminants, and shall have a minimum Concrete Surface Profile CSP equal to that recommended by the repair mortar manufacturer per ICRI Guideline 310.2.

3.____ REPAIR MORTAR APPLICATION:

- A. Repair Mortar Application: Mix and apply Repair Mortar per manufacturer's recommendations within the open time of the product scrub coat or any bonding agents. Finish to level of surrounding concrete surface utilizing techniques recommended by manufacturer.

BASE COAT SCRATCH & BROWN STUCCO



◆ The Pro's Choice Since 1936



Sakrete® Base Coat Scratch and Brown Stucco is a gray, blended, water resistant, portland/lime cement-based, material used for scratch and brown coat stucco work.

Features:

- Meets ASTM C926 Standard Specification for Application of Portland Cement-Based Plaster
- Preblend with sand requiring only the addition of water
- Can be used in a 3 coat system or 2 coat scratch and brown application
- Water resistant with a breathable finish

Use For:

- Concrete Block
- Vertical and overhead applications
- Scratch and Brown
- Applications over metal lath, welded or woven wire lath in accordance with ASTM C1063
- Brick or Stone

Yield/Water/Coverage:

Bag Size	Trowel Applied	Spray Applied	Water
80 lb (36.3 kg)	70 ft ² (6.4 m ²) at 1/8" (3.2 mm) thick or 35 ft ² (3.2 m ²) at 1/4" (6.4 mm) thick	60 ft ² (5.5 m ²) at 1/8" (3.2 mm) thick	1.5 gal (5.8 L)

NOTE: Yield and water are approximate. The yield above does not allow for waste and spillage. Coverage can vary depending upon texture, weather, method of application, workmanship and other conditions.

Color:

Gray

Technical Data:

Typical Values

Compressive Strength ASTM C109	
7 days	725 psi (5 MPa)
28 days	1,100 psi (7.6 MPa)

DIVISION 9
Portland Cement Plastering - 09 24 00

Preparation/Application:

For best results all material should be stored between 40°F (4°C) and 90°F (32°C).

1. Remove all unsound concrete, mortar, grease, oil, paint and other foreign materials that will inhibit performance.
2. When applying over a base coat, CMU (Concrete Masonry Unit) or other porous surfaces, dampen the surface first.
3. When applying over a smooth non-absorbent surface follow the provisions of ASTM C926 for surface treatment and the use of Sakrete Bonder & Fortifier or Sakrete Concrete Glue.
4. When used over old stucco, Sakrete Concrete Glue or Sakrete Bonder/Fortifier is required.

Refer to:

- ASTM D4258 Surface Cleaning of Concrete before painting
- ASTM C926 Application of Portland Cement Plaster
- ACI 524R Guide to Portland Cement Plastering

Placement:

1. Apply a scratch and brown coat in accordance with ASTM C926 prior to application of the stucco.
2. Install to a minimum thickness in accordance with the standards referenced.
3. Finish according to the texture specified. Wood floats are preferred.
4. Over-floating the material can result in color variations, mottling and surface defects.
5. The air, mix & substrate temperatures should all be between 40°F (4°C) to 90°F (32°C).

Spray Application:

Note: The following information is offered as a guide only. Specific product, equipment, application conditions and user experience will influence proper application results. Consult with the equipment manufacturer for equipment handling techniques. Field Test material with equipment prior to starting project.

Spray an even, consistent coat, moving the nozzle with a steady, even motion, maintaining the same distance and angle from the wall.

Progressive Cavity Pump	Hose diameter & max length	Gun	Tip	Pressure at Pump	Pressure at Gun
2.5 L	1" to 1.5" (25.4 to 38.1 mm)	Pole	7/16" to 9/16" (11.1 to 14.3 mm)	300-400 psi (2.1-2.8 MPa)	Air compressor to furnish 50 psi (0.3 MPa)

Mixing:

1. Use clean tools and potable water. A mixer will help with uniformity.
2. Use approximately 1 1/2 gal (5.8 L) of water per 80 lb (36.3 kg) bag.
3. Place the water in the mixer, gradually adding the stucco to the mixing water and mix until material is wet and of a trowelable consistency (about 3 - 4 minutes).
4. Water and mixing time must be kept to a minimum and be consistent between batches. Inconsistent amounts of water from bag to bag will result in color variations on the wall.



BASE COAT SCRATCH & BROWN STUCCO

◆ The Pro's Choice Since 1936

5. Allow mixer to sit for 2 minutes, than remix for one minute. A small amount of water may be added at this time if mix is stiff.
6. Mix only quantities that can be applied within one hour.
7. If mixture becomes stiff and difficult to trowel, discard it. Do not re-temper. Re-tempering will seriously affect performance.
8. When used over porous substrates and/or during hot, dry weather replace 1/2 gallon of water with the Sakrete Bonder & Fortifier or prime with Sakrete Concrete Glue.

Note: Refer to applicable sections of the standards referenced. DO NOT re-temper. Re-tempering will seriously affect color. When using Sakrete Bonder & Fortifier, pre-dilute with water first before mixing with the stucco. The addition of Bonder & Fortifier improves bond, curing, reduces shrinkage cracks, improves color retention and helps reduce efflorescence.

Curing:

1. Proper curing is critical for sound results.
2. Protect newly applied substrates from rain for 24 hours. Protect from freezing for 24 hours after application.
3. Materials modified with Sakrete Bonder & Fortifier should be air cured, unless hot and/or drying winds or low humidity are present. Under such conditions if not modified, lightly fog spray.
4. Cure per American Concrete Institute 308-Standard Practice for Curing Concrete. As with all stucco, surface cracking may occur due to curing conditions, control joint configurations, over-watering, over-troweling or other conditions beyond the control of the manufacturers of Sakrete products.
5. Efflorescence is a naturally occurring phenomenon associated with portland cement based products. Elevated mineral content, salts, or other particulates can exacerbate this condition.

Precautions:

- DO NOT apply over substrates that are frozen.
- DO NOT apply if air or substrate temperature is below 40°F (4°C) or above 90°F (32°C).
- DO NOT apply when temperature is expected to fall below 40°F (4°C) within 48 hours.
- DO NOT over-water.
- DO NOT over-float material.
- DO NOT use high mineral content or salt water.
- DO NOT apply over painted, sealed or slick surfaces.

NOTE: Proper application and installation of all Sakrete products are the responsibility of the end user.

Safety:

READ and UNDERSTAND the Safety Data Sheet (SDS) before using this product. WARNING: Wear protective clothing and equipment. For emergency information, call CHEMTREC at 800-424-9300 or 703-527-3887 (outside USA).

KEEP OUT OF REACH OF CHILDREN.

Limited Product Warranty:

The manufacturer warrants that this product shall be of merchantable quality when used or applied in accordance with the manufacturer's instructions. This product is not warranted as suitable for any purpose other than the general purpose for which it is intended. This warranty runs for one (1) year from the dates the product is purchased. ANY IMPLIED WARRANTY OF MERCHANTABILITY OR FITNESS FOR A PARTICULAR PURPOSE ON THIS PRODUCT IS LIMITED TO THE DURATION OF THIS WARRANTY. Liability under this warranty is limited to replacement or defective products or, at the manufacturer's option, refund of the purchase price. CONSEQUENTIAL AND INCIDENTAL DAMAGES ARE NOT RECOVERABLE UNDER THIS WARRANTY.

Limestone Finish

100% acrylic polymer finish coat

Product Bulletin

DESCRIPTION

Factory-mixed, 100% acrylic polymer finish coat. Limestone Finish utilizes uniformly-sized aggregate for a smooth, fine texture.

PACKAGING

31.7-kg per 19-liter pail
(70-lbs per 5-gallon pail).

COVERAGE

(Approximate) 14.8 m² (160 ft.²)
per pail

COLORS

Available in a wide variety of
standard and custom colors



USES

1. Provides an aesthetically pleasing surface color and texture for the Finestone Wall Systems.
2. Can also be utilized as a textured finish for poured concrete or unit masonry, conventional stucco, Finestone Stucco Wall System, FINESTONE Cement-Board Stucco, certain insulating concrete forms, and interior veneer plaster or gypsum wallboard.

Features	Benefits
100% Acrylic polymer chemistry	Long-term durability and weather resistance
Integral color	Reduced maintenance and recoating
Weather resistant	Repels water and resists wind-driven rain
Seals existing, non-moving hairline cracks	Protects
Breathable	Doesn't blister, peel or flake

Limestone Finish

MIXING

1. Thoroughly mix the factory-prepared LIMESTONE Finish with a mixer until thoroughly blended.
2. A small amount of clean, potable water may be added to adjust workability.
3. Additives are not permitted.
4. Close container when not in use.
5. Clean tools with soap and water immediately after use.

APPLICATION

1. Substrate shall be dry, clean, sound and free of releasing agents, paint or other residue or coatings. Verify substrate is flat, free of fins or planar irregularities greater than 6.4 mm in 3 m (1/4" in 10').
2. Apply LIMESTONE Finish directly to the Finestone Base Coat/ Reinforcing Mesh with a clean, stainless steel trowel.
3. Apply and level LIMESTONE Finish during the same operation to minimum obtainable thickness consistent with uniform coverage.
4. Maintain a wet edge on LIMESTONE Finish by applying and texturing continually over the wall surface.
5. Work LIMESTONE Finish to corners, joints or other natural breaks and do not allow material to set up within an uninterrupted wall area.
6. Float LIMESTONE Finish to achieve final texture.

LIMITATIONS

1. Protect Finestone materials during transportation and installation to avoid physical damage.
2. Store Finestone materials in a cool, dry place protected from freezing. Store at no less than 4°C (40°F). Protect from extreme heat and direct sunlight. Shelf life is two years when unopened and stored as directed.
3. Do not apply Finestone materials in ambient temperatures below 4°C (40°F). Provide supplementary heat during installation and drying period (at least 24 hours after installation and until dry) when temperatures less than 4°C (40°F) prevail.
4. Do not apply Finestone materials to frozen surfaces.
5. Samples of LIMESTONE Finish are available from Finestone for color approval only. Samples for job approval must be made in the field by the applicator, and approved prior to ordering.

HEALTH, SAFETY AND ENVIRONMENTAL

Read, understand and follow all Safety Data Sheets and product label information for this product prior to use. The SDS can be obtained by visiting www.finestone.basf.com. Use only as directed.

TECHNICAL SUPPORT

Consult our Technical Services Department for specific recommendations concerning all other applications. Consult the web site, www.finestone.basf.com for additional information and for updated literature.

WARRANTY

BASF warrants this product to be free from manufacturing defects and to meet the technical properties on the current Product Bulletin, if used as directed within shelf life. Satisfactory results depend not only on quality products but also upon many factors beyond our control. BASF MAKES NO OTHER WARRANTY OR GUARANTEE, EXPRESS OR IMPLIED, INCLUDING WARRANTIES OF MERCHANTABILITY OR FITNESS FOR A PARTICULAR PURPOSE WITH RESPECT TO ITS PRODUCTS. The sole and exclusive remedy of Purchaser for any claim concerning this product, including but not limited to, claims alleging breach of warranty, negligence, strict liability or otherwise, is shipment to purchaser of product equal to the amount of product that fails to meet this warranty or refund of the original purchase price of product that fails to meet this warranty, at the sole option of BASF. In the absence of an extended warranty issued by BASF, any claims concerning this product must be received in writing within one (1) year from the date of shipment and any claims not presented within that period are waived by Purchaser. BASF WILL NOT BE RESPONSIBLE FOR ANY SPECIAL, INCIDENTAL, CONSEQUENTIAL (INCLUDING LOST PROFITS) OR PUNITIVE DAMAGES OF ANY KIND.

Purchaser must determine the suitability of the products for the intended use and assumes all risks and liabilities in connection therewith. This information and all further technical advice are based on BASF's present knowledge and experience. However, BASF assumes no liability for providing such information and advice including the extent to which such information and advice may relate to existing third party intellectual property rights, especially patent rights, nor shall any legal relationship be created by or arise from the provision of such information and advice. BASF reserves the right to make any changes according to technological progress or further developments. The Purchaser of the Product(s) must test the product(s) for suitability for the intended application and purpose before proceeding with a full application of the product(s). Performance of the product described herein should be verified by testing and carried out by qualified experts.



Example of historic brick building in historic Key West with similar stucco repair. 201 Simonton.



Example of historic brick building in historic Key West with similar stucco repair

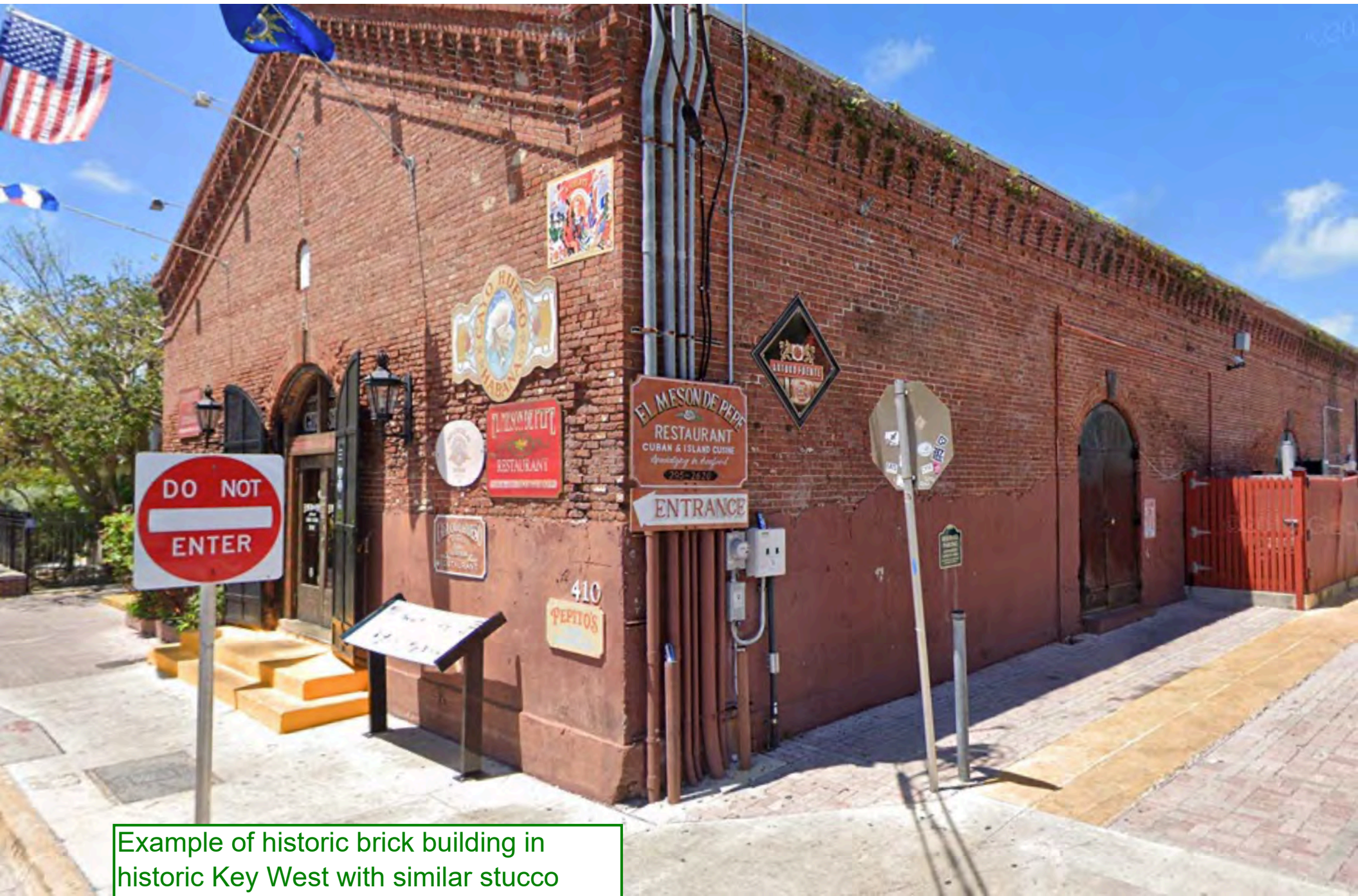

Example of historic brick building in historic Key West with similar stucco repair. 410 Wall St.



Example of historic brick building in historic Key West with similar stucco repair. 536 Fleming.



Example of historic brick building in historic Key West with similar stucco repair. 427 Front St.



Example of historic brick building in historic Key West with similar stucco repair. 423 Front St.

NOTICING

Public Meeting Notice

The Historic Architectural Review Commission will hold a virtual meeting at **5:00 p.m., June 23, 2020**. In order to view the live feed of the meeting, you can tune in to Comcast channel 77, AT&T Uverse channel 99, or type this link into your browser: http://keywestcity.granicus.com/MediaPlayer.php?publish_id=1&embed=1

The purpose of the hearing will be to consider a request for:

REPAIR DAMAGE BRICK WITH STUCCO APPLICATION. THE STUCCO REPAIR WILL ONLY BE APPROXIMATELY 5 FEET ABOVE THE FRONT PORCH ELEVATION AND DOWN.

#529 CAROLINE STREET

Applicant – Chas Spottswood Application #BLDG. 2019-1671

If you wish to see the application or have any questions, you may contact the Planning Department during regular office hours at 305-809-3973 or visit our website at www.cityofkeywest-fl.gov.

THIS NOTICE CAN NOT BE REMOVED FROM THE SITE UNTIL HARC FINAL DETERMINATION

ADA ASSISTANCE: It is the policy of the City of Key West to comply with all requirements of the Americans with Disabilities Act (ADA). Please call the TTY number at 800-955-8771 or 800-955-8770 (Voice) or the ADA Coordinator at 305-809-3811 at least five business days in advance for sign language interpreters, assistive listening devices, or materials in accessible format.

PROPERTY APPRAISER INFORMATION



Disclaimer

The Monroe County Property Appraiser's office maintains data on property within the County solely for the purpose of fulfilling its responsibility to secure a just valuation for ad valorem tax purposes of all property within the County. The Monroe County Property Appraiser's office cannot guarantee its accuracy for any other purpose. Likewise, data provided regarding one tax year may not be applicable in prior or subsequent years. By requesting such data, you hereby understand and agree that the data is intended for ad valorem tax purposes only and should not be relied on for any other purpose.

By continuing into this site you assert that you have read and agree to the above statement.

Summary

Parcel ID 00001220-000000
 Account# 1001244
 Property ID 1001244
 Millage Group 10KW
 Location 529 CAROLINE St, KEY WEST
 Address
 Legal KW PT LOT 4 SQR 13 G10-430/431 OR636-724/726 OR744-708/09 OR744-710 OR744-774/776
 Description OR769-1516 OR790-1315 OR1120-1532/33 OR1125-1564/65 OR1367-2001/13 OR2702-2128/29 OR2953-2274
 (Note: Not to be used on legal documents.)
 Neighborhood 32040
 Property Class HOTEL/MOTEL (3900)
 Subdivision
 Sec/Twp/Rng 06/68/25
 Affordable No
 Housing



Owner

SVR 529 LLC
 506 Fleming St
 Key West FL 33040

Valuation

	2019	2018	2017	2016
+ Market Improvement Value	\$443,202	\$460,875	\$460,875	\$406,600
+ Market Misc Value	\$4,509	\$4,635	\$4,762	\$5,004
+ Market Land Value	\$901,740	\$880,270	\$880,270	\$855,224
= Just Market Value	\$1,349,451	\$1,345,780	\$1,345,907	\$1,266,828
= Total Assessed Value	\$1,349,451	\$1,345,780	\$1,345,907	\$1,266,828
- School Exempt Value	\$0	\$0	\$0	\$0
= School Taxable Value	\$1,349,451	\$1,345,780	\$1,345,907	\$1,266,828

Land

Land Use	Number of Units	Unit Type	Frontage	Depth
COMMERCIAL DRY (100D)	5,650.00	Square Foot	56.5	105

Commercial Buildings

Style R8 / R8
 Gross Sq Ft 3,371
 Finished Sq Ft 2,798
 Perimeter 608
 Stories 2
 Interior Walls WALL BD/WD WAL
 Exterior Walls HARDIE BD
 Quality 650 ()
 Roof Type IRR/CUSTOM
 Roof Material METAL
 Exterior Wall1 HARDIE BD
 Exterior Wall2
 Foundation CONCR FTR
 Interior Finish WALL BD/WD WAL
 Ground Floor Area
 Floor Cover SFT/HD WD
 Full Bathrooms 3
 Half Bathrooms 0
 Heating Type FCD/AIR DUCTED with 0% NONE
 Year Built 1938
 Year Remodeled
 Effective Year Built 1995
 Condition

Code	Description	Sketch Area	Finished Area	Perimeter
OPX	EXC OPEN PORCH	528	0	200
FLA	FLOOR LIV AREA	2,798	2,798	380
SBF	UTIL FIN BLK	45	0	28
TOTAL		3,371	2,798	608

Style	S.F.R. - R1 / R1
Gross Sq Ft	312
Finished Sq Ft	200
Perimeter	106
Stories	1
Interior Walls	DRYWALL
Exterior Walls	WD FRAME
Quality	450 ()
Roof Type	GABLE/HIP
Roof Material	METAL
Exterior Wall1	WD FRAME
Exterior Wall2	
Foundation	CONCRETE SLAB
Interior Finish	DRYWALL
Ground Floor Area	
Floor Cover	CONC S/B GRND
Full Bathrooms	1
Half Bathrooms	0
Heating Type	NONE with 0% NONE
Year Built	1966
Year Remodeled	
Effective Year Built	1987

Code	Description	Sketch Area	Finished Area	Perimeter
FLA	FLOOR LIV AREA	200	200	60
OPU	OP PR UNFIN LL	112	0	46
TOTAL		312	200	106

Yard Items

Description	Year Built	Roll Year	Quantity	Units	Grade
FENCES	1937	1938	1	132 SF	3
CONC PATIO	1937	1938	1	200 SF	1
CONC PATIO	1937	1938	1	49 SF	2
CH LINK FENCE	1964	1965	1	228 SF	1
BRICK PATIO	1974	1975	1	352 SF	2
FENCES	1989	1990	1	84 SF	2
FENCES	2001	2002	1	300 SF	5

Sales

Sale Date	Sale Price	Instrument	Instrument Number	Deed Book	Deed Page	Sale Qualification	Vacant or Improved
3/15/2019	\$2,290,000	Warranty Deed	2211205	2953	2274	37 - Unqualified	Improved
9/10/2014	\$0	Quit Claim Deed		2702	2128	11 - Unqualified	Improved
10/1/1977	\$87,000	Conversion Code		790	1315	Q - Qualified	Improved

Permits

Number	Date Issued	Date Completed	Amount	Permit Type	Notes
BLD2019-2877	8/14/2019		\$15,000	Commercial	Relocate existing 200A:120/240V
BLD2019-2602	7/25/2019		\$32,000	Commercial	6- Bathrooms - 6 Toilets,6 Lava,6 Showers, 1 Water heater, 1 washer , 1 kitchen sink. Tie into existing water & sewer
BLD2019-1671	5/23/2019		\$500,000	Commercial	Relocate existing baths convert 1/2 bath to ADA Less than 10% repairs to existing brick, fascia, and deck boards with like materials (MEP and roofing under separate permit application)
0100719	2/23/2001	10/30/2001	\$3,600	Residential	REMOVE/REBUILD COLUMNS

View Tax Info

[View Taxes for this Parcel](#)

Sketches (click to enlarge)

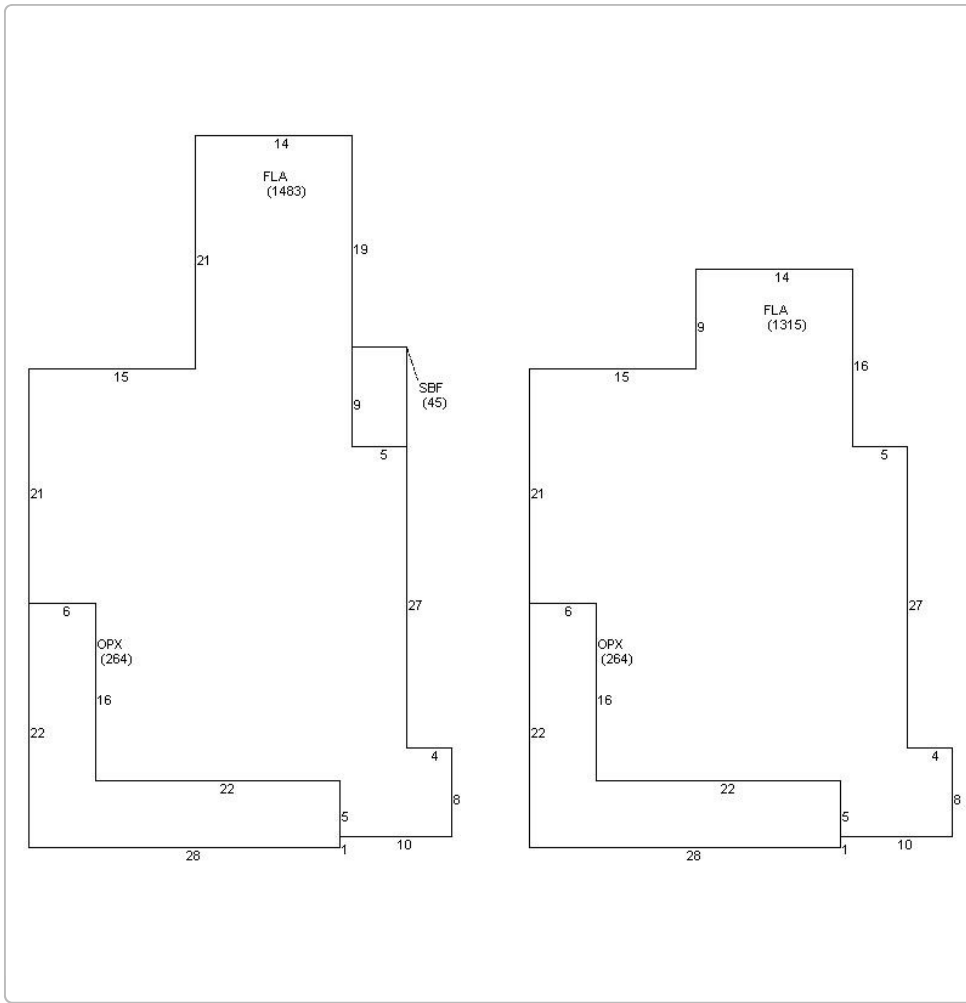

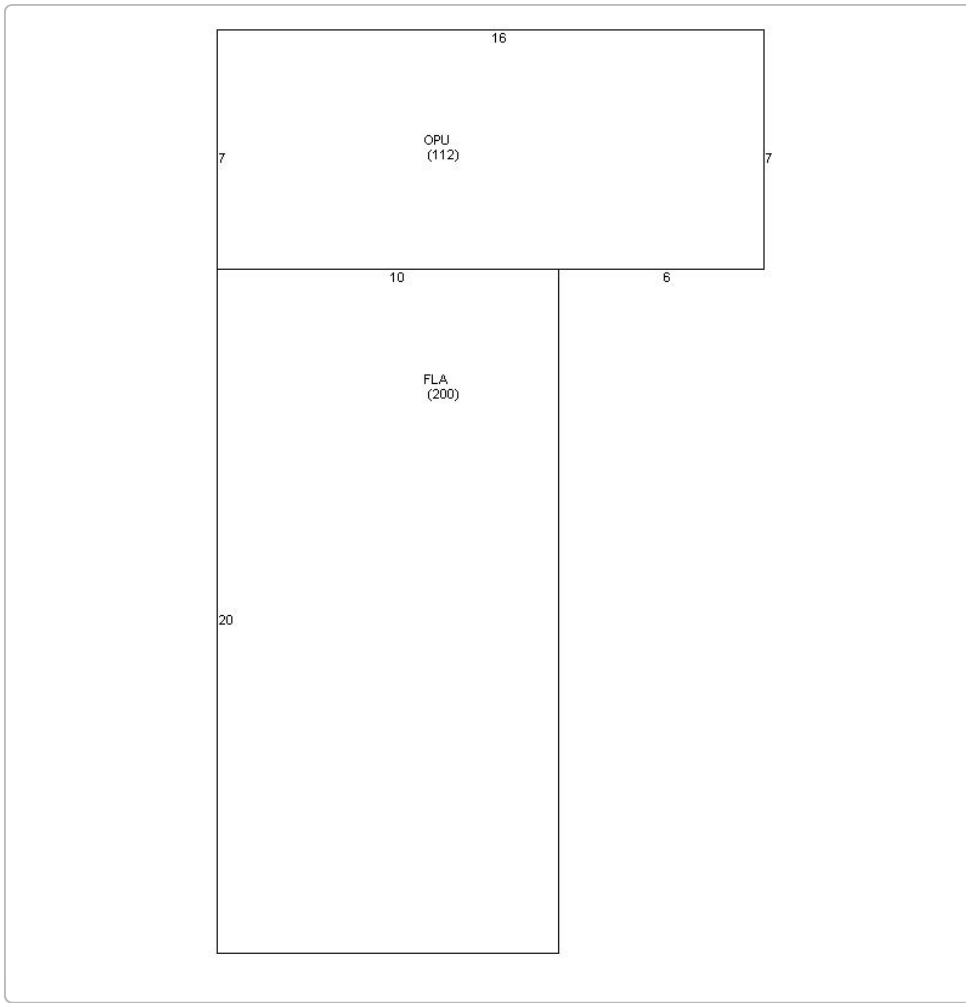

Photos



Map



TRIM Notice

Trim Notice

2019 Notices Only

No data available for the following modules: Buildings, Mobile Home Buildings, Exemptions.

The Monroe County Property Appraiser's office maintains data on property within the County solely for the purpose of fulfilling its responsibility to secure a just valuation for ad valorem tax purposes of all property within the County. The Monroe County Property Appraiser's office cannot guarantee its accuracy for any other purpose. Likewise, data provided regarding one tax year may not be applicable in prior or subsequent years. By requesting such data, you hereby understand and agree that the

[User Privacy Policy](#)
[GDPR Privacy Notice](#)

Last Data Upload: [2/20/2020 2:14:27 AM](#)

Developed by



[Version 2.3.41](#)

COMBINATION APPLICATION: FLOODPLAIN, CONSTRUCTION AND HARC

\$50.00 APPLICATION FEE NON-REFUNDABLE



City of Key West

3140 FLAGLER AVENUE
KEY WEST, FLORIDA 33040

Phone: 305.809.3956

www.cityofkeywest-fl.gov

HARC PERMIT NUMBER		BUILDING PERMIT NUMBER	INITIAL & DATE
		2019-1671	5-7-19
FLOODPLAIN PERMIT			REVISION #
FLOOD ZONE	PANEL #	ELEV. L. FL.	SUBSTANTIAL IMPROVEMENT
			<input type="checkbox"/> YES <input type="checkbox"/> NO <input type="checkbox"/> %

ADDRESS OF PROPOSED PROJECT:

529 Caroline St.

OF UNITS

RE # OR ALTERNATE KEY:

NAME ON DEED:

SVR 529, LLC

PHONE NUMBER

OWNER'S MAILING ADDRESS:

506 Fleming St.

EMAIL

billy@spottswood.com

CONTRACTOR COMPANY NAME:

Keystar, Inc.

PHONE NUMBER

305-360-0802

CONTRACTOR'S CONTACT PERSON:

Chas Spottswood

EMAIL

chas@keystarconstruction.com

ARCHITECT / ENGINEER'S NAME:

Thomas E. Pope, PA

PHONE NUMBER

305-296-3611

ARCHITECT / ENGINEER'S ADDRESS:

610 White St.

EMAIL

holly@p-s-architects.com

HARC: PROJECT LOCATED IN HISTORIC DISTRICT OR IS CONTRIBUTING: YES NO (SEE PART C FOR HARC APPLICATION.)

CONTRACT PRICE FOR PROJECT OR ESTIMATED TOTAL FOR MAT'L., LABOR & PROFIT:

\$500,000



FLORIDA STATUTE 837.06: WHOEVER KNOWINGLY MAKES A FALSE STATEMENT IN WRITING AND WITH THE INTENT TO MISLEAD A PUBLIC SERVANT IN THE PERFORMANCE OF HIS OR HER OFFICIAL DUTY SHALL BE GUILTY OF A MISDEMEANOR OF THE SECOND DEGREE PUNISHABLE PER SECTION 775.082 OR 775.083.

PROJECT TYPE: ONE OR TWO FAMILY MULTI-FAMILY COMMERCIAL NEW REMODEL
 CHANGE OF USE / OCCUPANCY ADDITION SIGNAGE WITHIN FLOOD ZONE
 DEMOLITION SITE WORK INTERIOR EXTERIOR AFTER-THE-FACT

DETAILED PROJECT DESCRIPTION INCLUDING QUANTITIES, SQUARE FOOTAGE ETC.,

Relocate existing

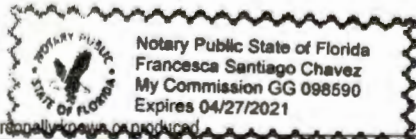
baths. Convert 1/2 bath to ADA. ~~Demo non-contributing~~
~~sheds~~. Less than 10% repairs to existing brick, fascia
 and deck boards with like materials. (MEP and roofing under separate permit app)

I'VE OBTAINED ALL NECESSARY APPROVALS FROM ASSOCIATIONS, GOV'T AGENCIES AND OTHER PARTIES AS APPLICABLE TO COMPLETE THE DESCRIBED PROJECT;	
OWNER PRINT NAME: <i>William B. Spottswood, VP</i>	QUALIFIER PRINT NAME: <i>Chas Spottswood</i>
OWNER SIGNATURE: <i>[Signature]</i>	QUALIFIER SIGNATURE: <i>[Signature]</i>
Notary Signature as to owner: <i>[Signature]</i>	Notary Signature as to qualifier: <i>[Signature]</i>
STATE OF FLORIDA; COUNTY OF MONROE, SWORN TO AND SCRIBED BEFORE ME THIS <u>7</u> DAY OF <u>May</u> , 20 <u>19</u> .	STATE OF FLORIDA; COUNTY OF MONROE, SWORN TO AND SCRIBED BEFORE ME THIS <u>7th</u> DAY OF <u>May</u> , 20 <u>19</u> .
 Personally known or produced _____ as identification.	 Personally known or produced _____ as identification.

Francesca S. Chavez

Permit 12000.00
Admin 814.50

John Castro
5-22-19

PART B: SUPPLEMENTARY PROJECT DETAILS TO AVOID DELAYS / CALL-BACKS

PROPERTY STRUCTURES AFFECTED BY PROJECT: MAIN STRUCTURE ACCESSORY STRUCTURE SITE

ACCESSORY STRUCTURES: GARAGE / CARPORT DECK FENCE OUTBUILDING / SHED

FENCE STRUCTURES: 4 FT. 6 FT. SOLID 6 FT. / TOP 2 FT. 50% OPEN

POOLS: INGROUND ABOVE GROUND SPA / HOT TUB PRIVATE PUBLIC
 PUBLIC POOLS REQUIRE BD. OF HEALTH LICENSE APPLICATION AT TIME OF CITY APPLICATION.
 PUBLIC POOLS REQUIRE BD. OF HEALTH LICENSE PRIOR TO RECEIVING THE CITY CERTIFICATE OF OCCUPANCY.

ROOFING: NEW ROOF-OVER TEAR-OFF REPAIR AWNING
 5 V METAL ASPLT. SHGLS. METAL SHGLS. BLT. UP TPO OTHER

FLORIDA ACCESSIBILITY CODE: 20% OF PROJECT FUNDS INVESTED IN ACCESSIBILITY FEATURES.

SIGNAGE: # OF SINGLE FACE # OF DOUBLE FACE REPLACE SKIN ONLY BOULEVARD ZONE
 POLE WALL PROJECTING AWNING HANGING WINDOW
 SQ. FT. OF EACH SIGN FACE: _____

SUBCONTRACTORS / SPECIALTY CONTRACTORS SUPPLEMENTARY INFORMATION:

MECHANICAL: DUCTWORK COMMERCIAL EXH. HOOD INTAKE / EXH. FANS LPG TANKS
 A / C: COMPLETE SYSTEM AIR HANDLER CONDENSER MINI-SPLIT

ELECTRICAL: LIGHTING RECEPTACLES HOOK-UP EQUIPMENT LOW VOLTAGE
 SERVICE: OVERHEAD UNDERGROUND 1 PHASE 3 PHASE _____ AMPS

PLUMBING: ONE SEWER LATERAL PER BLDG. INGROUND GREASE INTCPTRS. LPG TANKS

RESTROOMS: MEN'S WOMEN'S UNISEX ACCESSIBLE

PART C: HARC APPLICATION FOR A CERTIFICATE OF APPROPRIATENESS

APPLICATION FEES: PAINTING SINGLE FAMILY: \$10 STAFF APPROVAL: \$50 COMMISSION REVIEW \$100
 PLEASE ATTACH APPROPRIATE VARIANCES / RESOLUTIONS FROM HARC, PLANNING BOARD OR TREE COMMISSION.
 ATTENTION: NO BUILDING PERMITS WILL BE ISSUED PRIOR TO HARC APPROVAL.

PLEASE SEND ELECTRONIC SUBMISSIONS TO: harc@cityofkeywest-fl.gov
 INDICATE TYPE OF CERTIFICATE. OF APPROPRIATENESS: GENERAL DEMOLITION SIGN PAINTING OTHER
 ADDITIONAL INFORMATION: _____

PROJECT SPECIFICATIONS: PLEASE PROVIDE PHOTOS OF EXISTING CONDITIONS, PLANS, PRODUCT SAMPLES, TECHNICAL DATA

ARCHITECTURAL FEATURES TO BE ALTERED:	ORIGINAL MATERIAL:	PROPOSED MATERIAL:
repairs to existing brick,	brick	same as existing
facia and deck boards	wood	same as existing
like materials less		
than 10%		

DEMOLITION: PLEASE FILL OUT THE HARC APPENDIX FOR PROPOSED DEMOLITION.
 DEMOLITION OF HISTORIC STRUCTURES IS NOT ENCOURAGED BY THE HISTORIC ARCHITECTURAL REVIEW COMMISSION.
 SIGNAGE: (SEE PART B) BUSINESS SIGN BRAND SIGN OTHER: _____
 BUSINESS LICENSE # _____ IF FAÇADE MOUNTED, SQ. FT. OF FAÇADE _____

SIGN SPECIFICATIONS		
SIGN COPY:	PROPOSED MATERIALS:	SIGNS WITH ILLUMINATION:
		TYPE OF LTG.:
		LTG. LINEAL FTG.:
MAX. HGT. OF FONTS:		COLOR AND TOTAL LUMENS:
IF USING LIGHT FIXTURES PLEASE INDICATE HOW MANY: INCLUDE SPEC. SHEET WITH LOCATIONS AND COLORS.		

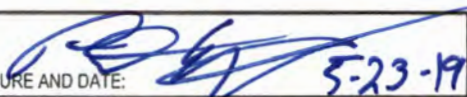
OFFICIAL USE ONLY:		HARC STAFF OR COMMISSION REVIEW	
<input type="checkbox"/> APPROVED	<input type="checkbox"/> NOT APPROVED	<input type="checkbox"/> DEFERRED FOR FUTURE CONSIDERATION	<input type="checkbox"/> TABLED FOR ADD'L. INFO.
HARC MEETING DATE:	HARC MEETING DATE:	HARC MEETING DATE:	
REASONS OR CONDITIONS:			
STAFF REVIEW COMMENTS:			
HARC PLANNER SIGNATURE AND DATE:  5-23-19		HARC CHAIRPERSON SIGNATURE AND DATE:	

PART D: STATE OF FLORIDA OFFICIAL NOTIFICATIONS AND WARNINGS

FLORIDA STATUTE 713.135: WARNING TO OWNER: YOUR FAILURE TO RECORD A 'NOTICE OF COMMENCEMENT' MAY RESULT IN YOUR PAYING TWICE FOR IMPROVEMENTS TO YOUR PROPERTY. A NOTICE OF COMMENCEMENT MUST BE RECORDED WITH THE COUNTY RECORDER AND A COPY POSTED ON THE JOB SITE BEFORE THE FIRST INSPECTION. IF YOU INTEND TO OBTAIN FINANCING CONSULT WITH YOUR LENDER OR AN ATTORNEY BEFORE RECORDING A NOTICE.

FLORIDA STATUTE 469: ABESTOS ABATEMENT. AS OWNER / CONTRACTOR / AGENT OF RECORD FOR THE CONSTRUCTION APPLIED FOR IN THIS APPLICATION, I AGREE THAT I WILL COMPLY WITH THE PROVISIONS F. S. 469.003 AND TO NOTIFY THE FLORIDA D. E. P. OF MY INTENT TO DEMOLISH / REMOVE ASBESTOS. IN ADDITION TO THE REQUIREMENTS OF THIS PERMIT APPLICATION, THERE MAY BE DEED RESTRICTIONS AND / OR ADDITIONAL RESTRICTIONS APPLICABLE TO THIS PROPERTY THAT MAY BE FOUND IN THE PUBLIC RECORDS OF MONROE COUNTY AND THERE MAY BE ADDITIONAL PERMITS REQUIRED FROM OTHER GOVERNMENT ENTITIES SUCH AS AQUADUCT ATHORITY, FLORIDA DEP OR OTHER STATE AGENCIES; ARMY CORPS OF ENGINEERS OR OTHER FEDERAL AGENCIES.

FEDERAL LAW REQUIRES LEAD PAINT ABATEMENT PER THE STANDARDS OF THE USEP ON STRUCTURES BUILT PRIOR TO 1978.

OFFICIAL USE ONLY BY PLANS EXAMINER OR CHIEF BUILDING OFFICIAL:				CBO OR PL. EXAM. APPROVAL:
HARC FEES:	BLDG. FEES:	FIRE MARSHAL FEE:	IMPACT FEES:	
				DATE:

APPLICATION

HARC MAJOR PROJECTS CERTIFICATE OF APPROPRIATENESS

\$400 NON-REFUNDABLE BASE APPLICATION FEE - OTHER FEES MAY BE APPLICABLE



City of Key West
 1300 WHITE STREET
 KEY WEST, FLORIDA 33040

HARC COA # Blg. 19-1671	REVISION #	INITIAL & DATE
FLOOD ZONE Rev. 1	ZONING DISTRICT	BLDG PERMIT #

A PRE-APPLICATION MEETING WITH HARC STAFF IS REQUIRED PRIOR TO SUBMITTAL

ADDRESS OF PROPOSED PROJECT:	529 Caroline St. Key West	
NAME ON DEED:	SUR 529 LLC	PHONE NUMBER 352-494-2338
OWNER'S MAILING ADDRESS:	506 Fleming St.	EMAIL Billy@Spottswood.com
APPLICANT NAME:	Chas Spottswood	PHONE NUMBER 305 360 0802
APPLICANT'S ADDRESS:		EMAIL chas@Keystarconstruction.com
APPLICANT'S SIGNATURE:		DATE 1/2/20

ANY PERSON THAT MAKES CHANGES TO AN APPROVED CERTIFICATE OF APPROPRIATENESS MUST SUBMIT A NEW APPLICATION.

FLORIDA STATUTE 837.06: WHOEVER KNOWINGLY MAKES A FALSE STATEMENT IN WRITING AND WITH THE INTENT TO MISLEAD A PUBLIC SERVANT IN THE PERFORMANCE OF HIS OR HER OFFICIAL DUTY SHALL BE GUILTY OF A MISDEMEANOR OF THE SECOND DEGREE PUNISHABLE PER SECTION 775.082 OR 775.083. THE APPLICANT FURTHER HEREBY ACKNOWLEDGES THAT THE SCOPE OF WORK AS DESCRIBED IN THE APPLICATION SHALL BE THE SCOPE OF WORK THAT IS CONTEMPLATED BY THE APPLICANT AND THE CITY. THE APPLICANT FURTHER STIPULATES THAT SHOULD FURTHER ACTION BE TAKEN BY THE CITY FOR EXCEEDING THE SCOPE OF THE DESCRIPTION OF WORK, AS DESCRIBED HEREIN, AND IF THERE IS CONFLICTING INFORMATION BETWEEN THE DESCRIPTION OF WORK AND THE SUBMITTED PLANS, THE AFOREMENTIONED DESCRIPTION OF WORK SHALL BE CONTROLLING.

PROJECT INCLUDES: REPLACEMENT OF WINDOWS RELOCATION OF A STRUCTURE ELEVATION OF A STRUCTURE

PROJECT INVOLVES A CONTRIBUTING STRUCTURE: YES NO INVOLVES A HISTORIC STRUCTURE: YES NO

PROJECT INVOLVES A STRUCTURE THAT IS INDIVIDUALLY LISTED ON THE NATIONAL REGISTER: YES NO

DETAILED PROJECT DESCRIPTION INCLUDING MATERIALS, HEIGHT, DIMENSIONS, SQUARE FOOTAGE, LOCATION, ETC.	
GENERAL:	We propose to repair the damaged stucco with a stucco application the stucco repair will only be approximately 5 feet above the front porch elevation and down.
MAIN BUILDING:	
DEMOLITION (PLEASE FILL OUT AND ATTACH DEMOLITION APPENDIX):	

APPLICATIONS MUST BE SUBMITTED IN PERSON WITH HARD COPIES BY 3PM ON THE SCHEDULED DEADLINE
 PLEASE SEND AN ELECTRONIC COPY OF ALL DOCUMENTS TO HARC@CITYOFKEYWEST-FL.GOV

ACCESSORY STRUCTURE(S):	
PAVERS:	FENCES:
DECKS:	PAINTING:
SITE (INCLUDING GRADING, FILL, TREES, ETC.):	POOLS (INCLUDING EQUIPMENT):
ACCESSORY EQUIPMENT (GAS, A/C, VENTS, ETC.):	OTHER:

OFFICIAL USE ONLY:	HARC COMMISSION REVIEW	EXPIRES ON:
MEETING DATE:	<input type="checkbox"/> APPROVED <input type="checkbox"/> NOT APPROVED <input type="checkbox"/> DEFERRED FOR FUTURE CONSIDERATION	INITIAL:
MEETING DATE:	<input type="checkbox"/> APPROVED <input type="checkbox"/> NOT APPROVED <input type="checkbox"/> DEFERRED FOR FUTURE CONSIDERATION	INITIAL:
MEETING DATE:	<input type="checkbox"/> APPROVED <input type="checkbox"/> NOT APPROVED <input type="checkbox"/> DEFERRED FOR FUTURE CONSIDERATION	INITIAL:
REASONS OR CONDITIONS:		
STAFF REVIEW COMMENTS:		
<div style="font-family: cursive; color: blue; font-size: 1.2em;"> Home is a contributing resource to the historic district. </div>		
FIRST READING FOR DEMO:	SECOND READING FOR DEMO:	
HARC STAFF SIGNATURE AND DATE:	HARC CHAIRPERSON SIGNATURE AND DATE:	

THIS APPLICATION MAY BE REVIEWED BY PLANNING DEPARTMENT STAFF.

Subject: RE: Looking for matching brick
Date: Thursday, September 19, 2019 at 1:48:19 PM Eastern Daylight Time
From: Tom Angeley
To: Chas Spottswood
Attachments: image002.png

I'm pretty some fire brick are 8 ¼ in length, maybe you could stain the brick. Sorry but that's a tough one.

From: Chas Spottswood [mailto:chas@keystarconstruction.com]
Sent: Thursday, September 19, 2019 11:19 AM
To: Tom Angeley
Subject: Looking for matching brick

Tom,

Thanks for taking my call, here are some photos on the brick I need to match. Any help would be greatly appreciated.

Thanks,

Chas Spottswood

KEYSTAR

Chas@Keystarconstruction.com

305.294.5909 (Office)

305.360.0802 (Mobile)

Total Control Panel

[Login](#)

To: tom@stilesandhart.com

Message Score: 15

High (60): Pass

From: chas@keystarconstruction.com

My Spam Blocking Level: Medium

Medium (75): Pass

Low (90): Pass

[Block](#) this sender

[Block](#) keystarconstruction.com

This message was delivered because the content filter score did not exceed your filter level.

Subject: Re: key west project
Date: Wednesday, September 18, 2019 at 3:13:01 AM Eastern Daylight Time
From: Authentic Reclamation
To: Chas Spottswood
Attachments: image001.png, Outlook-ka3yycu1.jpg

Hello,

We unfortunately don't have anything in the quantity you are after which is a good match

Kind regards,
Myah



From: Chas Spottswood <chas@keystarconstruction.com>
Sent: 17 September 2019 16:35
To: Authentic Reclamation <info@authentic-reclamation.co.uk>
Cc: Victoria Ashmore <vashmore@keystarconstruction.com>; Tony Roberts <troberts@keystarconstruction.com>
Subject: key west project

Hello,

I am looking for about 2,000 brick for a restoration project. Here are some photos. Please email me back, any help is greatly appreciated.

Thanks,

Chas Spottswood
KEYSTAR
Chas@Keystarconstruction.com
305.294.5909 (Office)
305.360.0802 (Mobile)

Nick

Nick Olson | Project Manager | Specialized Property Services, Inc.
9605 US Highway 92 East, Tampa, FL 33610
Office 813.246.4274 | Mobile 813.447.0664 | Fax 813.514.2794
| nickolson@sps247.net | www.specializedpropertyservices.com

From: Chas Spottswood <chas@keystarconstruction.com>
Sent: Thursday, September 19, 2019 11:54 AM
To: Nick Olson <NickOlson@sps247.net>
Subject: Re: 529 Caroling Key West Red Brick Restoration

Hey Nick,

Thanks for chatting with me about my project. Here are some picture of the brick I need to match. Any help would be greatly appreciated.

Thanks,

Chas Spottswood
KEYSTAR
Chas@Keystarconstruction.com
305.294.5909 (Office)
305.360.0802 (Mobile)

From: Chas Spottswood <chas@keystarconstruction.com>
Date: Tuesday, September 17, 2019 at 3:55 PM
To: "NickOlson@sps247.net" <NickOlson@sps247.net>
Subject: 529 Caroling Key West Red Brick Restoration

Hello Nick,

Enid Torres gave me your contact. I am a GC here in KW and just started a red brick restoration project. Enid mentioned you may be able to help me find matching brick.

Call or email me anytime. Thanks,

Chas Spottswood
KEYSTAR
Chas@Keystarconstruction.com
305.294.5909 (Office)
305.360.0802 (Mobile)

Subject: RE: 529 Caroling Key West Red Brick Restoration
Date: Thursday, October 3, 2019 at 4:09:03 PM Eastern Daylight Time
From: Nick Olson
To: Chas Spottswood
Attachments: image004.png

Chas,

I'm not sure if you'd had any luck with finding the brick yet, but I've done a bit of research and talked to some of my people and haven't come up with any exact matches for you. The problem is the size of the brick. It is a real odd ball size, and I am not sure if anyone makes a brick that size. It is possible that may even be a road brick, or was made by a company that made road brick. Sometimes municipalities have salvaged road brick in storage, if they've pulled them up to install pavement, but that may not be the case in the Keys. Below I have listed out a bunch of different brick manufacturers that I would check with. Sometimes they will make custom sizes for you, but you would have to order at least 100,000 brick, in some cases. I hope this helps.

- Acme Brick
- Acme Brick
- Bowerston Shale Company
- Brampton Brick Inc.
- Carolina Ceramics (This is where I got the brick for the Custom House, it was the Cherry Smooth, Rosewood Smooth, and the Terra Cotta Smooth)
- Cherokee Brick (They do custom sizes)
- Endicott Clay Products Company
- General Shale, Inc.
- Columbus Brick Company
- Watsontown Brick Company
- Glen-Gery Corporation
- Hebron Brick Supply Company
- Henry Brick Company, Inc.
- Lee Brick & Tile Company, Inc.
- Marion Ceramics
- McNear Brick & Block
- Meridian Brick
- Morin Brick Company
- Palmetto Brick
- Pine Hall Brick Company, Inc.
- Statesville Brick Company
- Sioux City Brick
- Taylor Clay Products Company
- The Belden Brick Company
- Redland Brick Inc.
- Richards Brick Company
- The McAvoy Brick Company
- The Stiles & Hart Brick Company
- Triangle Brick Company
- Whitacre Greer Company

Subject: FW: 529 Caroline Brick Repairs
Date: Monday, October 7, 2019 at 10:38:08 AM Eastern Daylight Time
From: Chas Spottswood
To: Enid Torregrosa, Tom Pope
CC: John Spottswood III
Attachments: image001.png, AuthenticReclamation.pdf, StilesandHArt.pdf, 536 Fleming.png, 601 Fleming.png, 201 Siminton.png, NickOlson.pdf

Enid,

After months of searching I have not been able to find matching brick for the 529 Caroline project. I have reached out to many manufacturers, and reclamation experts around the country and one in Europe and no one I found has or will make a matching brick. See attached correspondence from some of the companies I contacted. Stiles and Hart is the company Bert Bender's office referred me to and the other, Authentic Reclamation, is also an expert reclamation company of historic building materials. Everyone I have spoken with says the 8-1/2" length is very unique and is not made any longer.

I should have the mortar and brick testing report back this week from US Heritage, do I need to submit this to HARC?

At this juncture I feel it may be best to replicate the same method as demonstrated at 536 Fleming, 601 Fleming and 201 Siminton, see attached photos. This may be better than trying to use a brick that does not match size, color and density/strength.

Thanks,

Chas Spottswood

KEYSTAR

Chas@Keystarconstruction.com

305.294.5909 (Office)

305.360.0802 (Mobile)

SANBORN MAPS

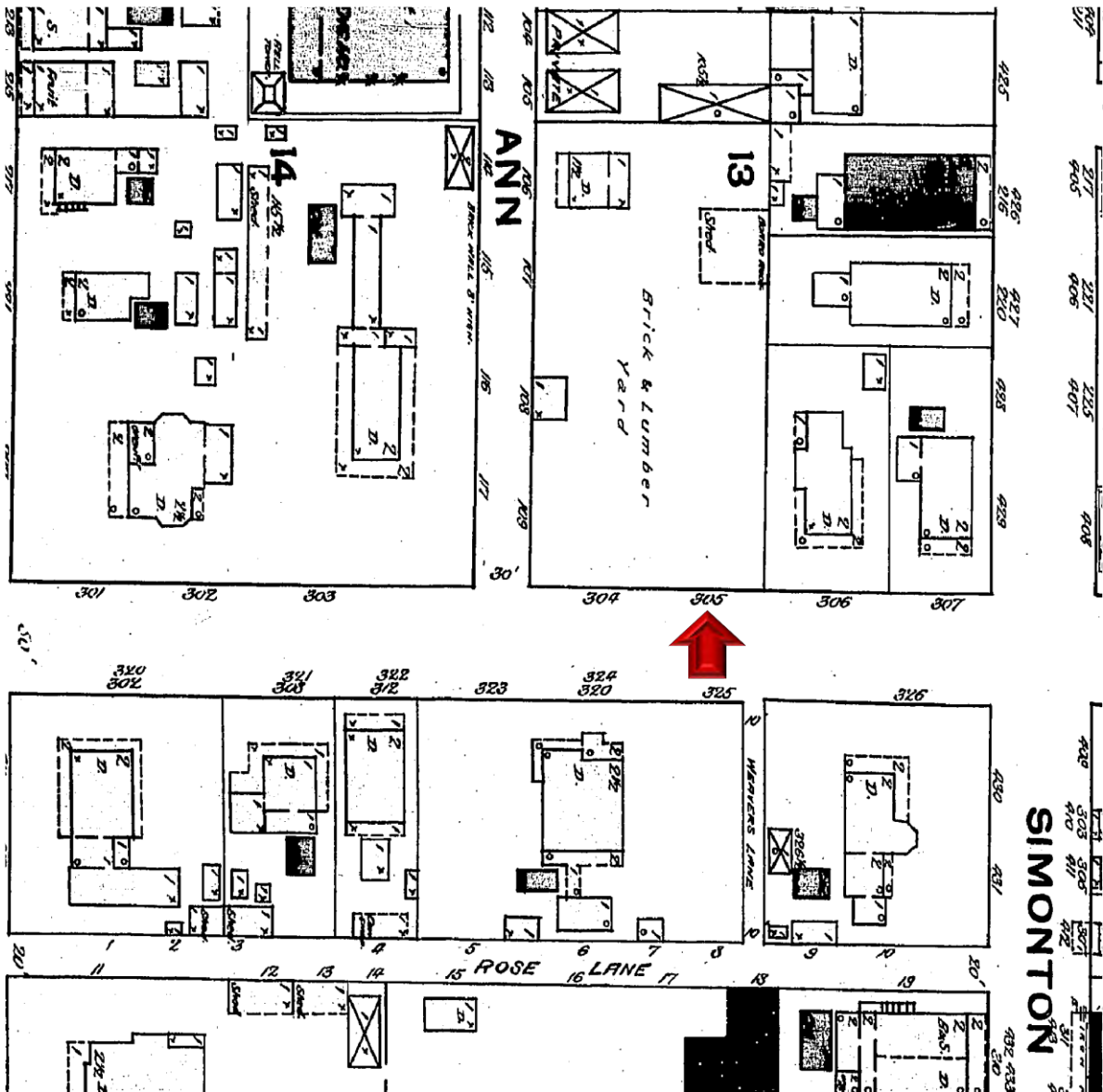

1892 Sanborn Map

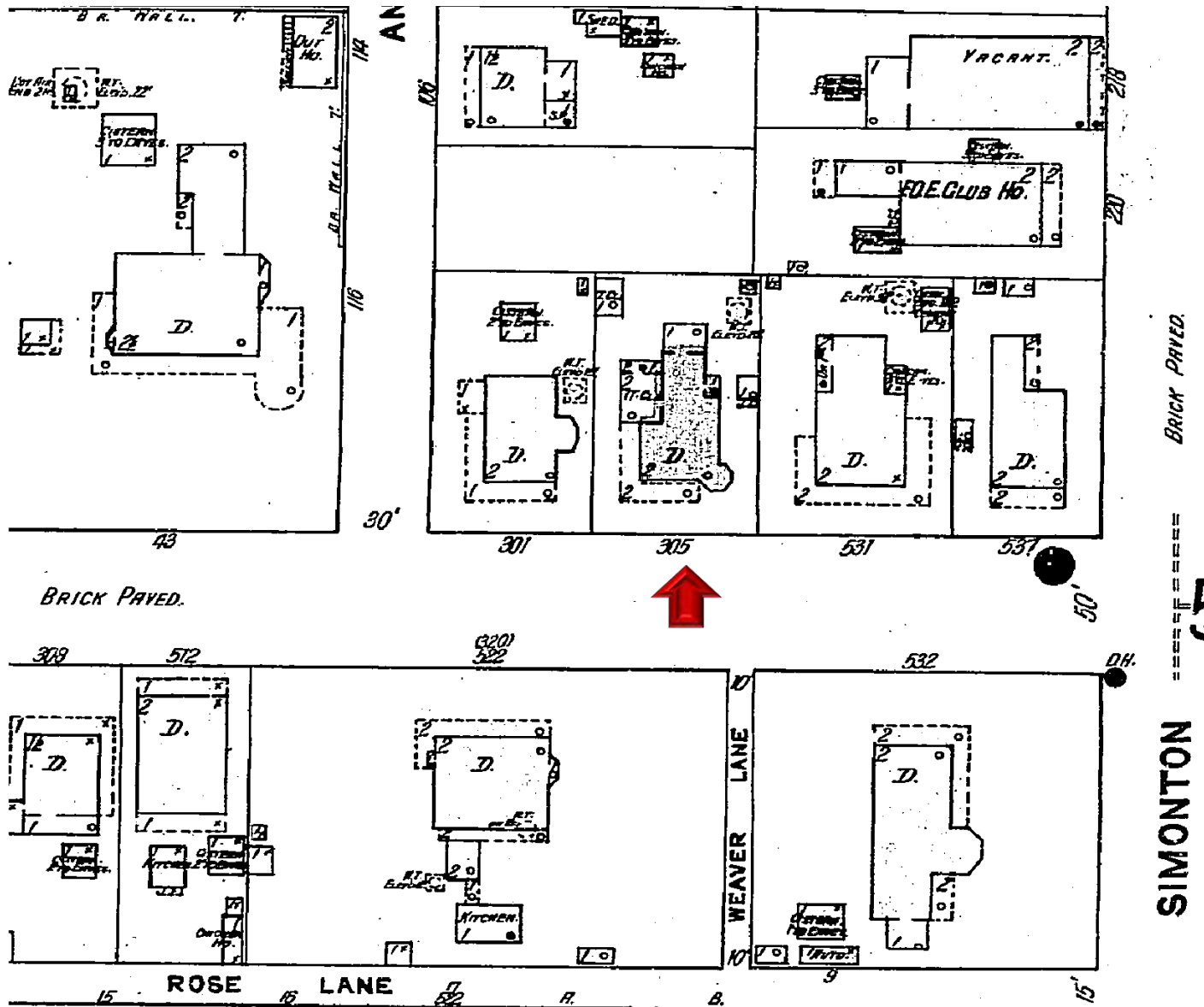

1912 Sanborn Map

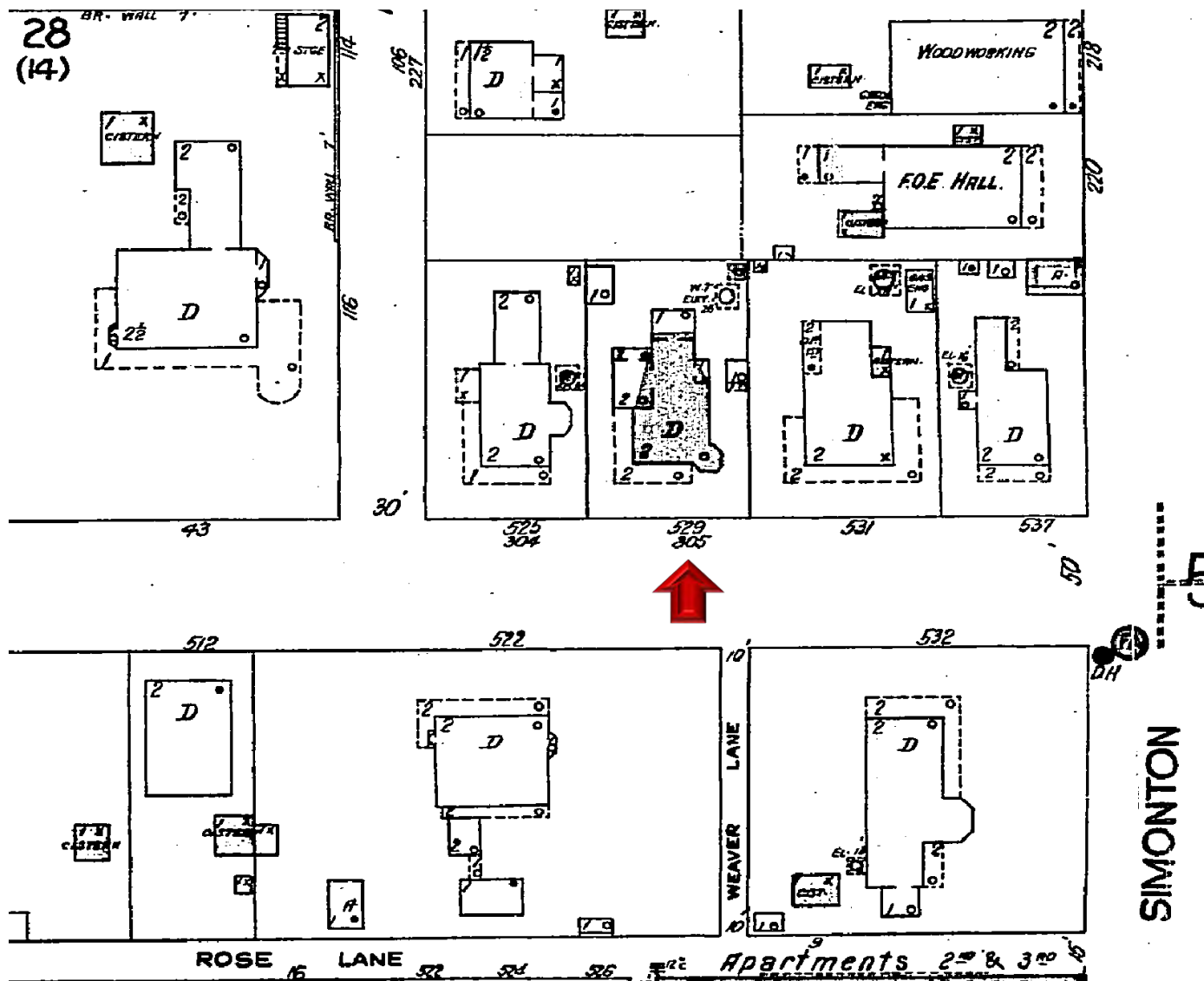

1926 Sanborn Map

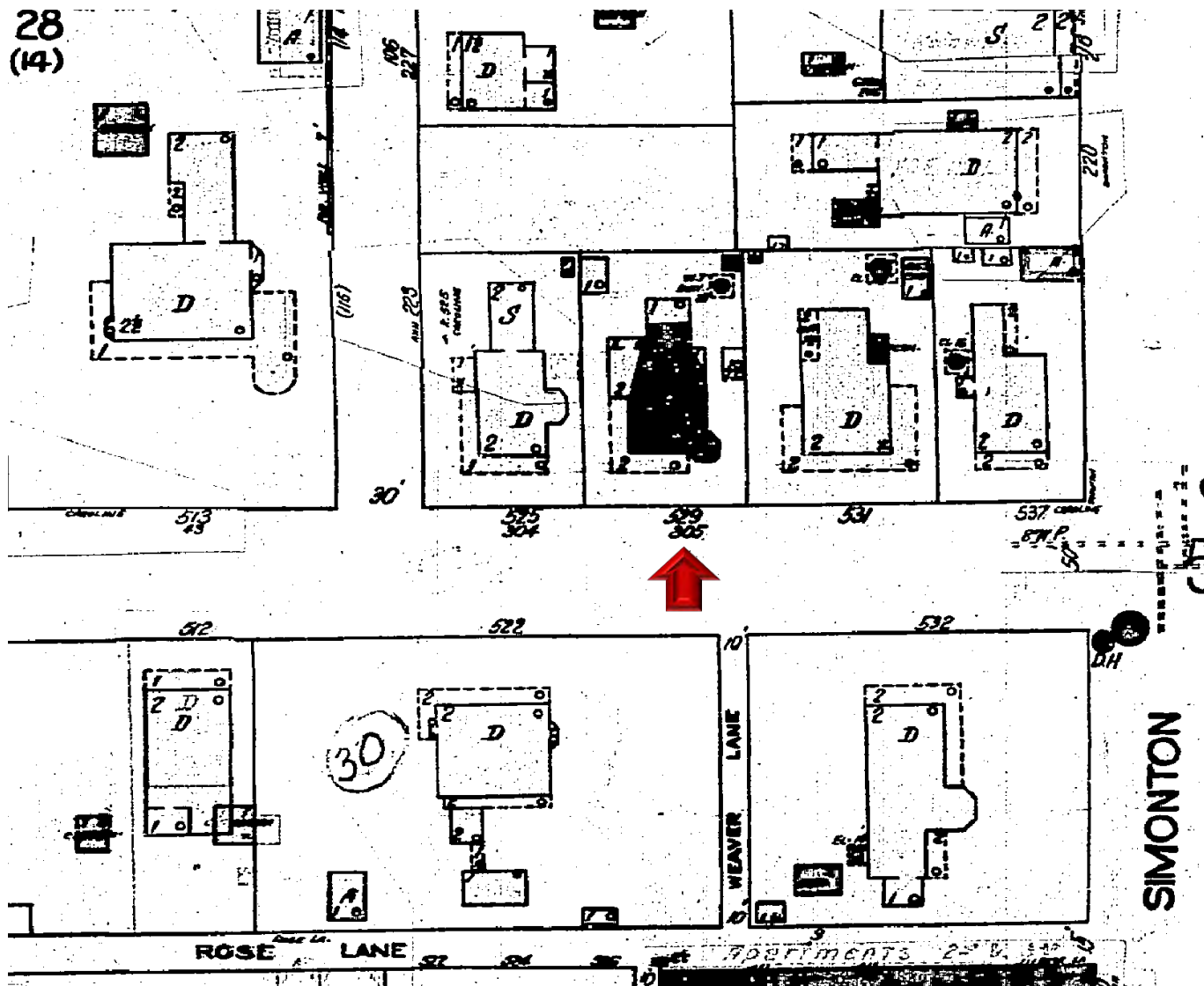

1948 Sanborn Map

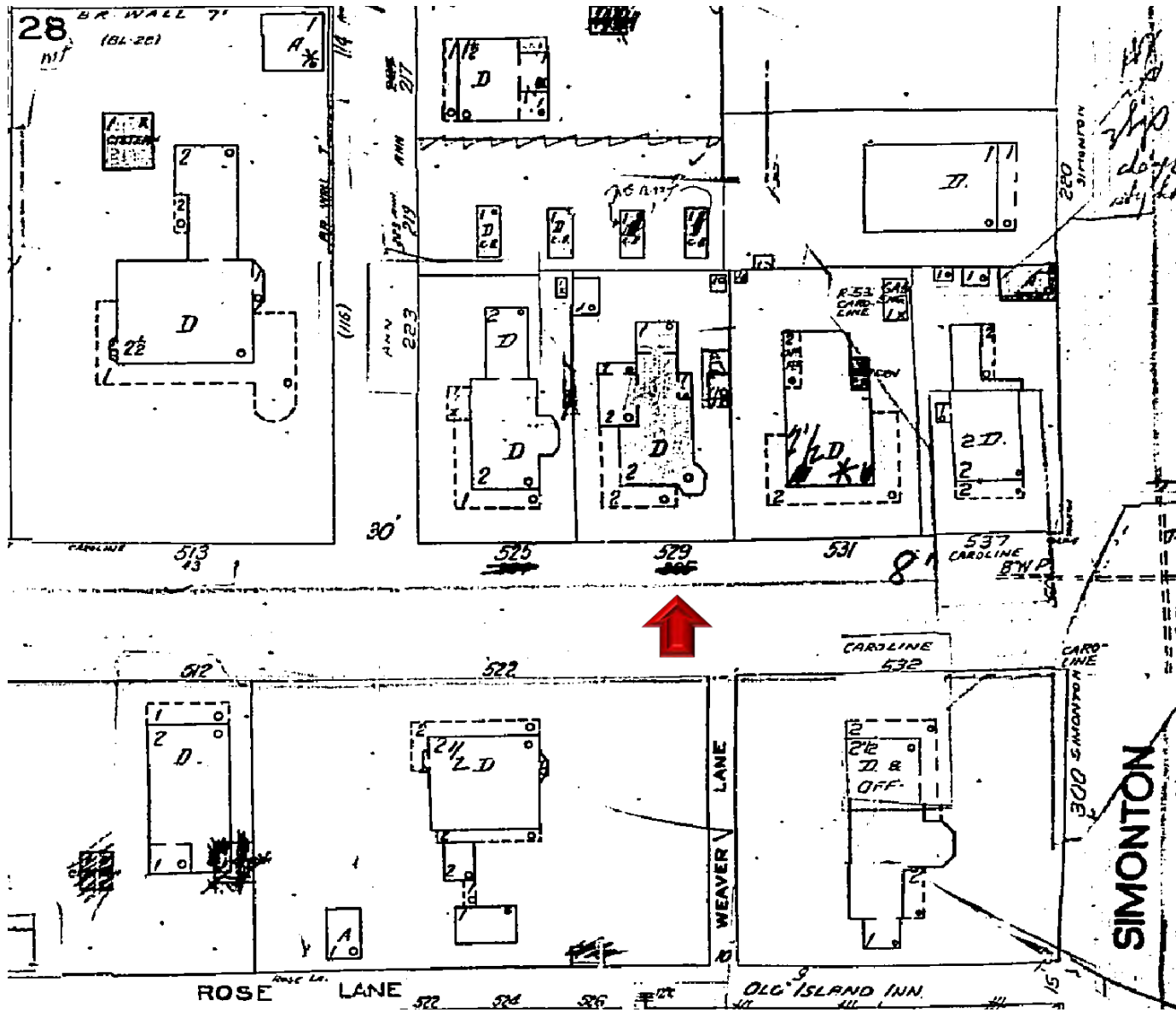

1962 Sanborn Map

PROJECT PHOTOS



529 Caroline Street circa 1965. Monroe County Library.



Current conditions, entryway.



Current conditions front view of turret as removal of layers of paint has finished. New repointing at the upper portion of the turret.

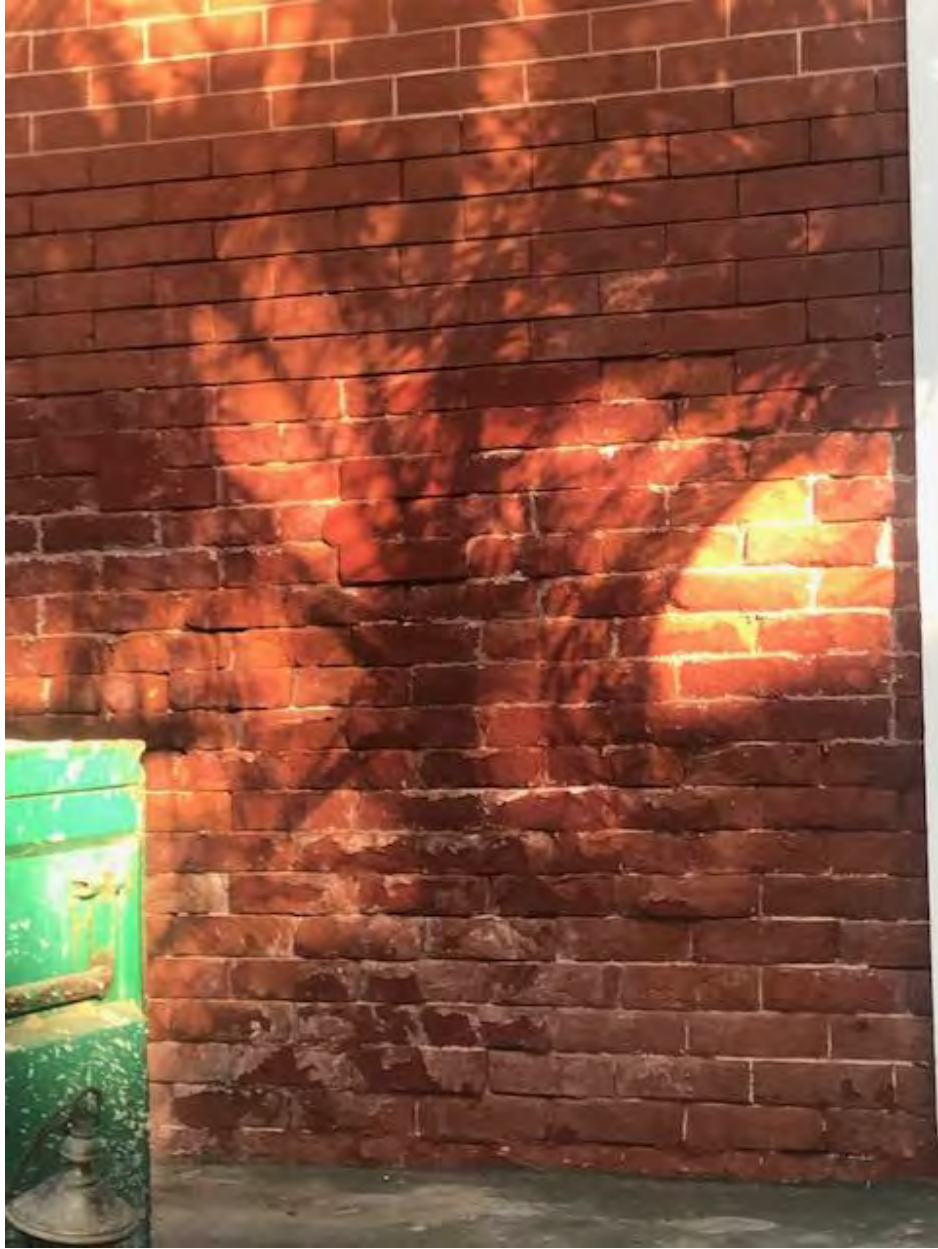

Current conditions, detail of front wall.



Current conditions, detail front wall.



Current conditions front view of turret



Current conditions, detail of lower portion of turret.

PROPOSED DESIGN

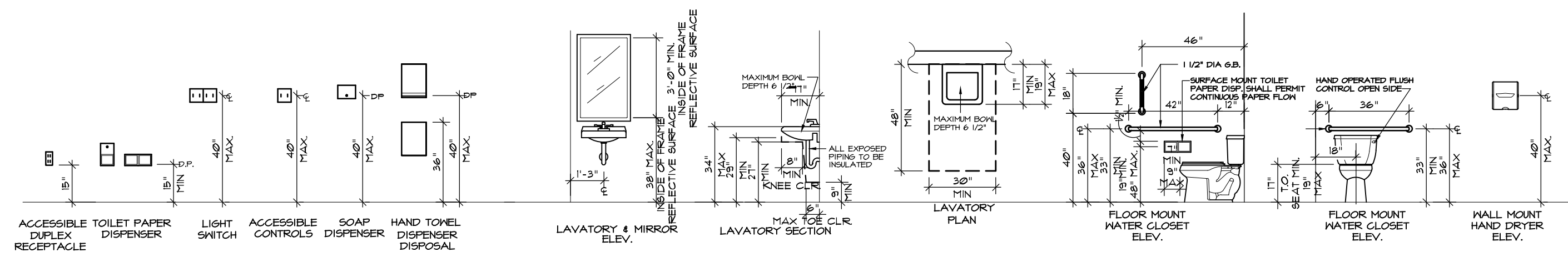

Typical ADA Details

1/4" = 1' - 0"

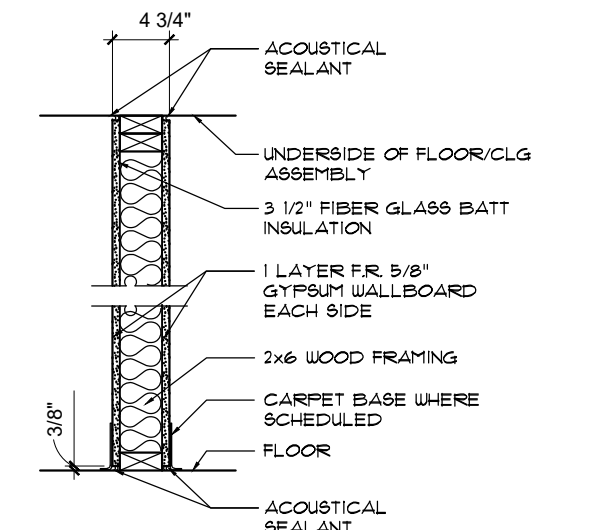

PARTITION TYPE - ONE HOUR 4
 FIRE: 1 HR
 U.L. U200
 SOUND: STC50
 TYPICAL APPLICATION: PARTITION WALL

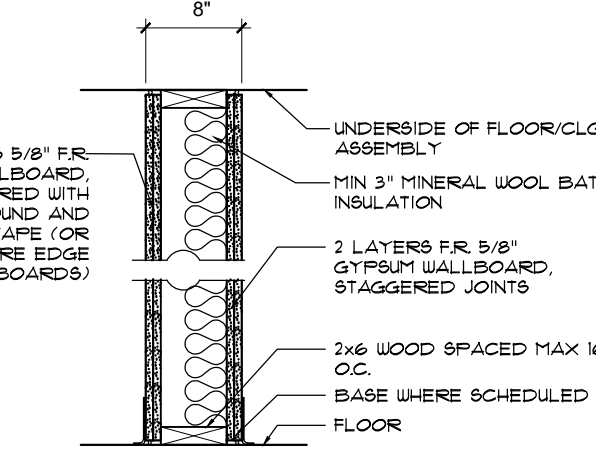

PARTITION TYPE - ONE HOUR 3
 FIRE: 2 HR3
 U.L. U200
 SOUND: STC54
 TYPICAL APPLICATION: FIRE RATED PLUMBING WALL

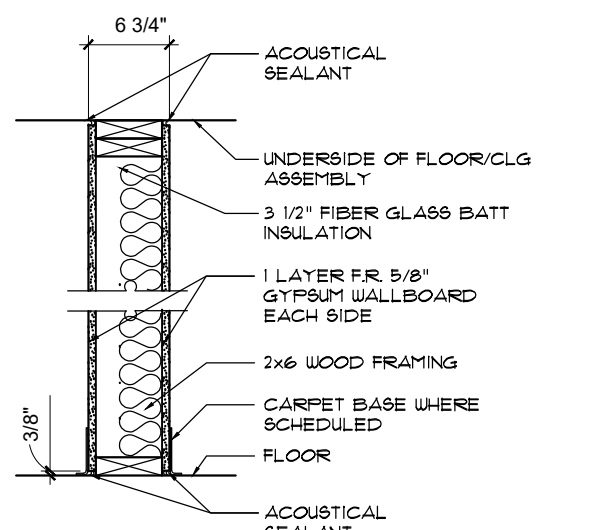

PARTITION TYPE - NON RATED 2
 FIRE: 1 HR
 U.L. U200
 SOUND: STC50
 TYPICAL APPLICATION: PLUMBING WALL

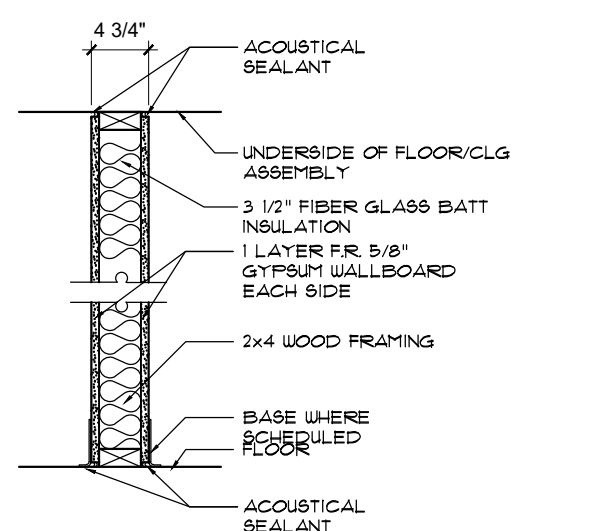

PARTITION TYPE - NON RATED 1
 FIRE: N/A
 U.L. N/A
 SOUND: N/A
 TYPICAL APPLICATION: TYPICAL WALL

Typical Wall Details

3/4" = 1' - 0"

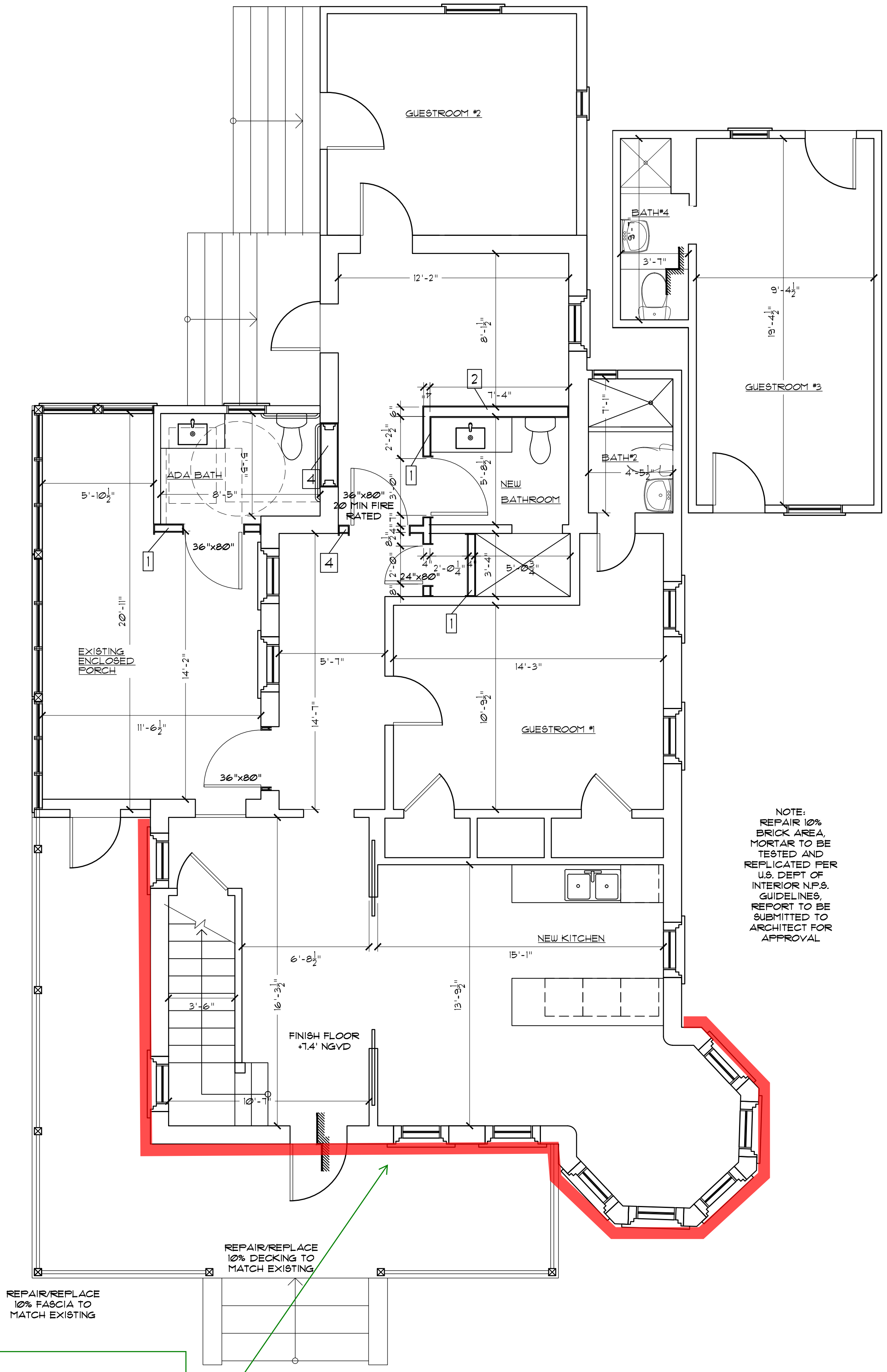
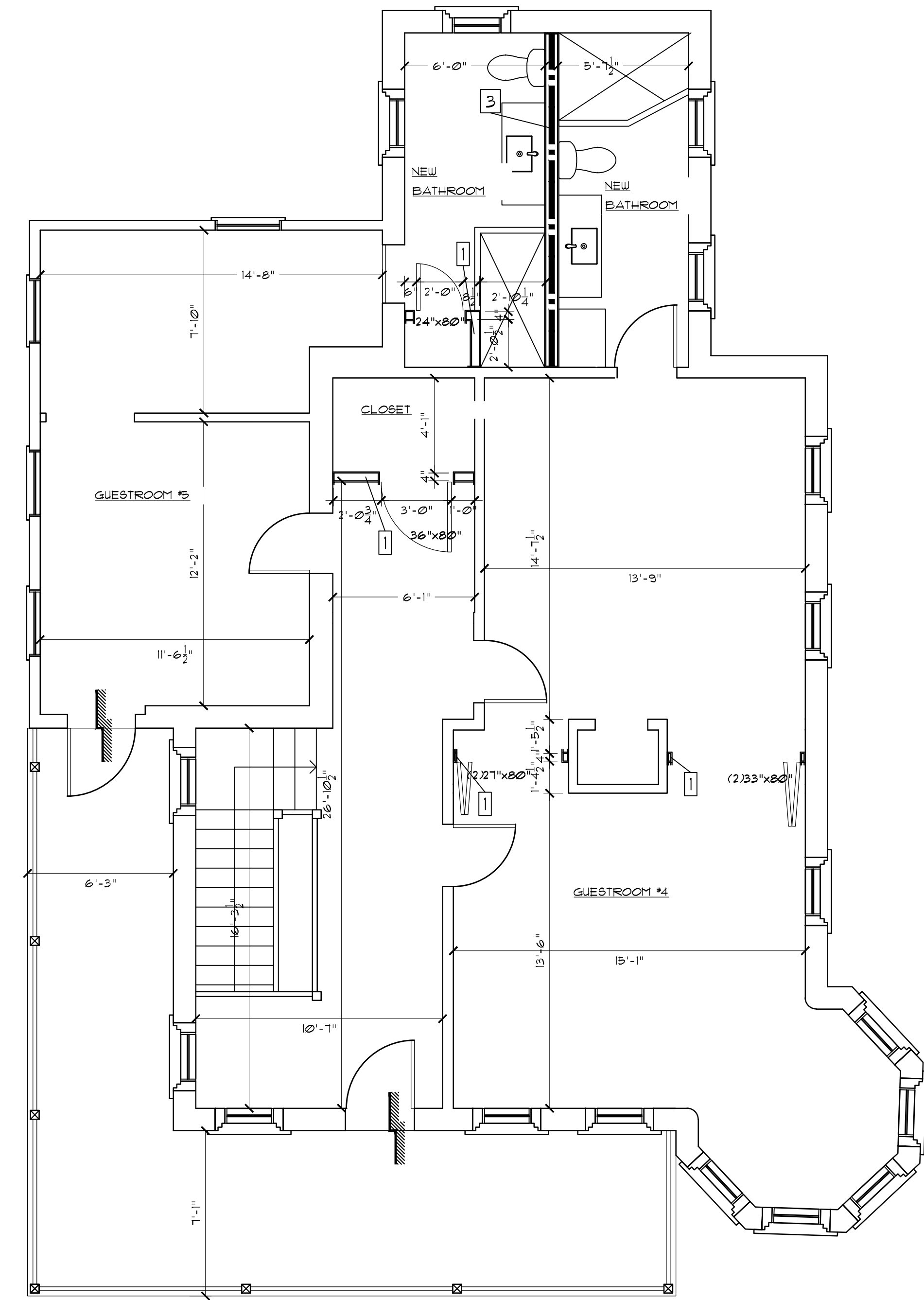

Red line indicates area of proposed stucco repairs

Proposed First Floor Plan
 1/4" = 1' - 0"

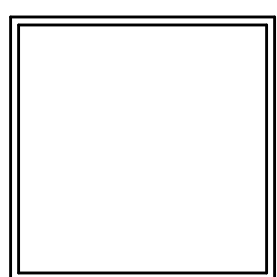
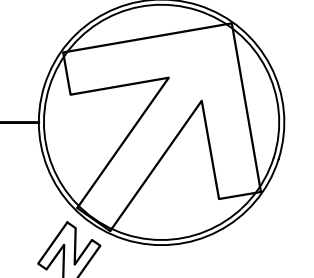

529 Caroline St
 Key West, FL
 529 Caroline St

THOMAS E. POPE, P.A.
 POPE-SCARBROUGH-ARCHITECTS
 610 White St, Key West FL
 (305) 296 3611

date: 5/7/19
 revision:

sheet:
 A1.1

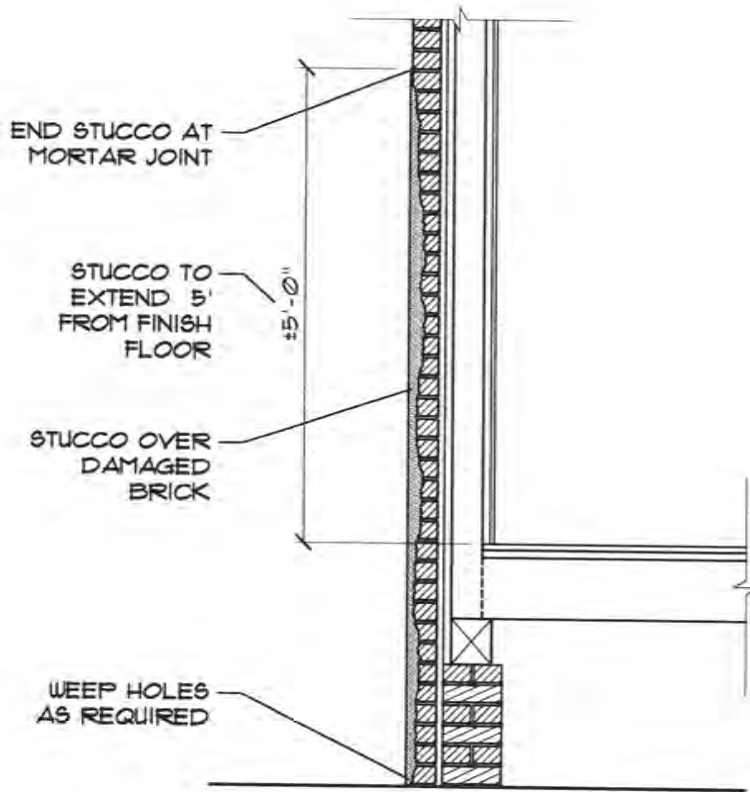

Stucco Detail

1/2" = 1' - 0"

date:
revision:

529 Caroline St.
529 Caroline Street Key West, FL

THOMAS E. POPE, P.A.
POPE-SCARBROUGH-ARCHITECTS
610 White St, Key West FL
(305) 296 3611



Proposed area for stucco repairs



proposed area of
stucco repair

Project: USHG #19-153B

October 18, 2019



Lisa Littlefield
Concrete Analysis and Testing Lab
1600 Yellowtail Ave.
Marathon, FL 33050
Phone: 305-393-0643

EVALUATION OF ORIGINAL AND REPLACEMENT BRICK – ASTM C67 529 Caroline St. Key West

INTRODUCTION

5 samples of original brick were received for analysis on September 30, 2019. Assuming the bricks provided are representative of the existing bricks, the analysis detailed in this report will give a reliable indication of the physical characteristics of the bricks in the structure.

The project identification in our file is: USHG#19-153B.

METHODS OF ANALYSIS

ASTM C67 - The sample was analyzed according to procedures and examination methods of ASTM C67, "Standard Test Methods for Sampling and Testing Brick and Structural Clay Tile".

The bricks were examined for physical measurements and tested for compressive strength. The results of the testing are presented on page 2.

Respectfully submitted,
U.S. Heritage Group, Inc.

A handwritten signature in black ink that reads "Tai Olson".

Tai Olson
Laboratory Manager



RESULTS - COMPRESSIVE STRENGTH

Bricks: 529 Caroline St. Key West—USHG #19-153B

ASTM C67 – Physical Analysis of Clay Face Brick – Section 7 - Compressive Strength

Nominal Brick Size 2.4" x 4.2" x 7.9"

<i>Unit No.</i>	<u>1</u>	<u>2</u>	<u>3</u>	<u>4</u>	<u>5</u>	<u>AVG</u>
Compressive Strength (psi)	3,290	4,300	3,360	3,910	4,710	3,910





Custom Mortar Matching Report

USHG Project: # 19-153

Analysis Date: 10/01/2019

Project: 529 Caroline Street, Key West, FL

Client: Lisa Littlefield, Concrete Analysis & Testing Laboratories

PO Box 500875, Marathon, FL 33050

Client Requirements: Match Mortar / Package B

Mortar Dating: unknown

Location/Function in Building: unknown

INTRODUCTION

The findings and recommendations presented in this report are premised on the results of tests performed on two mortar samples delivered to our laboratory on September 30, 2019.

The scope of testing was limited to the determination of the physical mix proportions of the major ingredients used in the mortar samples. The testing included visual examination, both with and without magnification, as well as analysis of the aggregate color, particle shape and grain size distribution.

The sample's physical characteristics, original date of construction, and guidelines from the U.S. Department of the Interior National Park Service were used to determine the proposed mortar component recommendations as well as the aggregate ratios for the replacement mix.

U.S. Heritage Group interpreted and adjusted the proposed mortar formulation recommendation based on the information provided to us regarding: current site conditions; present condition and type of masonry; the function of the new mortar; and the degree of weather exposure. Assuming the sample provided is representative of the original mortar, the analysis and mortar-matching diagnosis detailed in this report here will give a reliable indication of the original ingredients and allow U.S. Heritage Group to recommend a historically correct mortar formulation for your project.

SAMPLES

The samples were identified in our laboratory as:

- 1) #19-153-1 529 Caroline St, K West, FL - Sample1 2) #19-153-2 529 Caroline St, K West, FL - Sample2

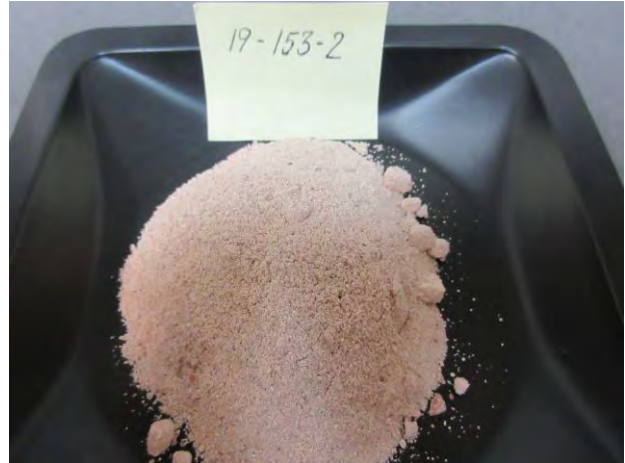
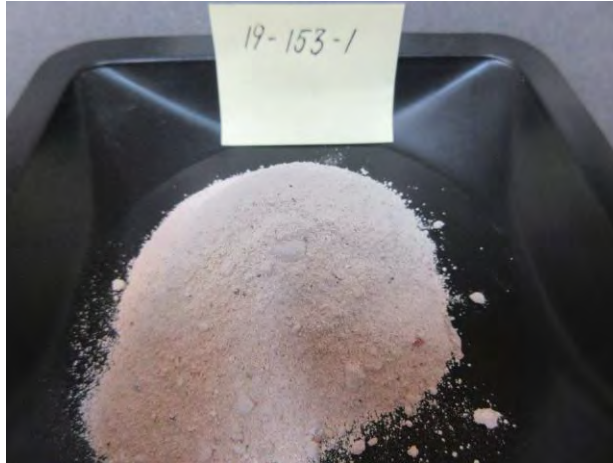

PRELIMINARY TESTING

Samples were different in color however both were delivered in the form of dust, which suggests they represent similar mixes. The fact that the samples were provided in the form of dust allows us to conclude about the very low compressive strength of the tested mortars.

AGGREGATE ANALYSIS

Next, we chemically removed the binder from the aggregate using a dilute acid solution. After drying the aggregate, we viewed it under 40X magnification to determine the characteristics of the particles. A sieve separation process established the distribution of aggregate particles by a percent of total weight. We prepared a gradation charts to graphically display the color, shape and size of the aggregate particles. The aggregate sieve sizes requisite in ASTM C144 meet ASTM E11 specification requirements.

The sand weight retained on each testing sieve was as follow:

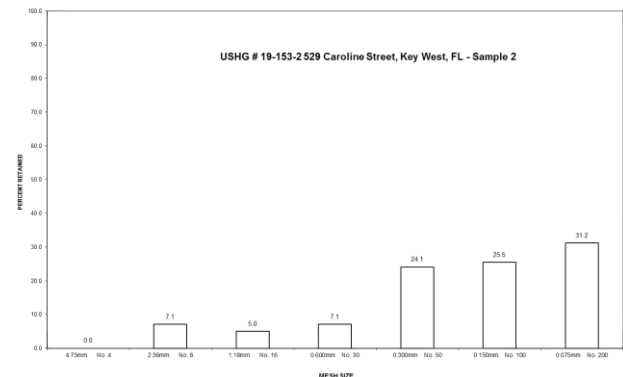
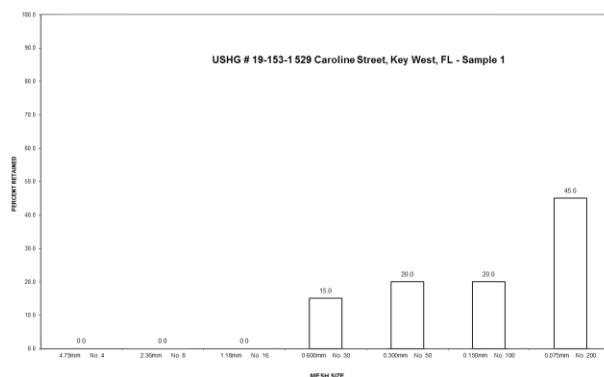

Samples:	#19-153-1 Sample 1	#19-153-2 Sample 2
Testing Sieve Size	% of sand retained	
4.75mm, No. 4	0.0	0.0
2.36mm, No. 8	0.0	7.1
1.18mm, No. 16	0.0	5.0
600micro, No. 30	15.0	7.1
300micro, No. 50	20.0	24.1
150micro, No. 100	20.0	25.5
75micro, No. 200	45.0	31.2
Total sand weight	100%	100%

Based on the particle color and shape similarities it appears that both mortars were likely made using aggregate from the same area. Variation in aggregate gradation is untypical for natural sand and suggest that majority of aggregate used in the mix is not a silica sand. Grated brick and small shards of brick appear in the aggregate. Original aggregate extracted from mortar sample #19-153-1 529 Caroline Street, Key West, FL – Sample 1 is classified as fine-sized aggregate and sand extracted from mortar sample #19-153-2 529 Caroline Street, Key West, FL – Sample 2 is classified as mix of fine and medium-sized aggregate.

BINDER TO AGGREGATE RATIO

The binder percentage in each mortar sample was established and found to be above 90% for both samples, which would be considered an extremely binder rich formulation. The results of this calculation can be affected by the presence of calcium carbonate in the aggregate which would have been dissolved out during the chemical wet process. Another argument for this is the high speed and rapidity of the chemical reaction. Those factors were considered in the evaluation of the proposed replacement formulation.

Sample	#19-153-1 Sample 1	#19-153-2 Sample 2
Binder	98.7%	90.6%
Aggregate	1.3%	9.4%

SUMMARY OF TEST RESULTS

Low compressive strength results for both samples were assumed. The material reaction noted during chemical wet process was very similar for both samples and did not indicated presence of a hydraulic component in the material. This coupled with the samples' appearance, suggests that they were originally mixed using non-hydraulic slaked lime putt and aggregate (mostly limestone). However, these are the conclusions obtained on the base of analysis of samples provided in the form of dust. For a final, full judgment it is necessary to analyze solid mortar samples.

PROPOSED REPLACEMENT MIX

In light of these findings and the intended use of the replacement material, U.S. Heritage Group recommends specifying the following replication mortar formulations for both projects (19-153-1 Sample 1 and 19-153-2 Sample 2):

1 part slaked lime putty and 2.5 parts sand selected from the USHG sand library.

Mineral-based color pigments were used to match the original color of exterior mortar.

Above recommendation was made in accordance with Preservation Brief 2:

“The new mortar must be as vapor permeable and as soft or softer (measured in compressive strength) than the historic mortar.”

Note: Masonry work using this formulation must be completed 28 days prior to freeze thaw cycles occurring. Do not perform any masonry work unless air temperatures are between 40 degrees Fahrenheit (10 degrees Celsius) and 95 degrees Fahrenheit (32 degrees Celsius) and will remain so for at least 5 weeks after the completion of the work.

Slaked lime putty should be aged for a minimum of three months before use in a mortar mix. Building elements such a chimney or foundation wall may require addition of hydraulic component in the mortar. Type and amount of hydraulic additive used in a new mortar should be established based on the condition of the existing masonry units to make sure that new installed mortar is softer with greater rate of water absorption.

JOBSITE MOCK-UP SAMPLE

The replacement mortar sample should be field-tested through a jobsite mock-up. The mock-up sample should be installed by a qualified craftsperson who understands the curing and application details of traditional lime mortars. Once the mock-up sample is installed, appropriate precautions should be taken to ensure that the mortar is protected from wind, sun, rain and frost to enable slow curing (i.e. carbonation) to take place.

Thank you for seeking our advice and entrusting these important details to U.S. Heritage Group. We are always available to discuss these findings with you in detail. Please contact me directly at 773-286-2100 if you have any questions.

We look forward to providing you with a custom, ready-to-use, historically correct mortar for your project.

Respectfully,

U.S. Heritage Group, Inc.

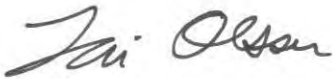

Tai Olson
Laboratory Manager



Piotr Psuja PhD Eng.
Laboratory Manager

Note: This information is held in confidence and becomes a permanent record at the U.S. Heritage Group laboratories located at 3516 North Kostner Ave., Chicago, IL 60641. It can be referenced at any time in the future by the property owner named above or by an authorized mason contractor involved with the restoration work. When inquiring about this match please use the project number USHG #19-153.



EUCLID CHEMICAL

EUCOREPAIR V100

LOW SHRINKAGE, FIBER REINFORCED, NSF/ANSI STANDARD 61
CERTIFIED VERTICAL & OVERHEAD REPAIR MORTAR

DESCRIPTION

EUCOREPAIR V100 is a single-component, quick-setting, low shrinkage repair mortar formulated with unique polymers and fiber reinforcement for vertical and overhead repairs requiring high performance.

PRIMARY APPLICATIONS

- Vertical and overhead repairs
- Marine structures, tunnels, and dams
- Parking structures & bridges
- Above and below grade applications
- Water and wastewater treatment facilities

FEATURES/BENEFITS

- Single-component for easy mixing and handling
- Contains an integral corrosion inhibitor
- Excellent freeze-thaw resistance for difficult climates
- Low permeability helps protect rebar from corrosion
- Polymer modified with fiber reinforcement
- High bond strength provides excellent adhesion
- NSF/ANSI Standard 61 certified
- Apply coatings after 6 hours at 70°F (21°C)

TECHNICAL INFORMATION

The following are typical values obtained under laboratory conditions. Expect reasonable variation under field conditions.

PROPERTY	RESULTS
Compressive Strength ASTM C109 modified, 2" (5 cm) cubes, psi (MPa)	3 hours 2,000 (13.8)
	1 day 3,000 (20.7)
	7 days 4,500 (31.0)
	28 days 6,000 (41.4)
Split Tensile Strength ASTM C496, psi (MPa)	28 days >400 (2.8)
Flexural Strength ASTM C348, psi (MPa)	7 days >500 (3.4)
	28 days >600 (4.1)
Bond Strength ASTM C882, psi (MPa)	7 days >1,400 (9.7)
	28 days >1,800 (12.4)
Length Change ASTM C157 modified (3"x3"x11.25" specimens)	28 days -0.020%
Unit Weight	~ 120 lb/ft ³ (1,922 kg/m ³)
Set Times	Initial: ~ 20 min. Final: ~ 35 min.

Appearance: EUCOREPAIR V100 is a free-flowing powder designed to be mixed with water. After mixing and placing, the color may appear darker than the surrounding concrete. While this color will lighten as EUCOREPAIR V100 cures and dries out, the repair may always appear darker than the surrounding concrete.

PACKAGING/YIELD

EUCOREPAIR V100 is packaged in 46 lb (21 kg) moisture resistant bags, and 46 lb (21 kg) pails. **Yield:** 0.45 ft³ (0.013 m³) per 46 lb (21 kg) bag/pail when mixed with 1 gal (3.79 L) of water.

SHELF LIFE

1 year in original, unopened package

SPECIFICATIONS/COMPLIANCES

EUCOREPAIR V100 is NSF/ANSI Standard 61 certified for use with potable water

COVERAGE

One unit of EUCOREPAIR V100 will cover approximately 10.5 ft² (1.0 m²) when placed at an average depth of 1/2" (13 mm).

DIRECTIONS FOR USE

Surface Preparation: Concrete surfaces must be structurally sound, free of loose or deteriorated concrete and free of dust, dirt, paint, efflorescence, oil and all other contaminants. Mechanically abrade the surface to achieve a surface profile equal to CSP 5 - 7 in accordance with ICRI Guideline 310.2. Properly clean profiled area.

Priming & Bonding (Saw Cut & Chipped Out Repairs): Thoroughly clean any exposed reinforcing steel, and apply DURALPREP A.C. to the concrete and the reinforcing steel within the repair area. Refer to the DURALPREP A.C. technical data sheet for full instructions. Alternatively, application of a scrub coat of EUCOREPAIR V100 to the saturated surface dry (SSD) concrete surface may be used for bonding. The repair material must be placed on the scrub coat before the scrub coat dries out.

Priming & Bonding (Vertical & Overhead Skim Coats/Toppings): Apply a scrub coat of EUCOREPAIR V100 to the saturated surface dry (SSD) concrete surface. The repair material must be placed on the scrub coat before the scrub coat dries out.

Mixing: For optimum results, condition material to be mixed to 65°F to 85°F (18°C to 29°C) at least 24 hours prior to use. Single bags may be mixed with a drill and "jiffy" type mixer. Use a paddle type mortar mixer for large jobs. Add the appropriate amount of water, 0.9 to 1 gal (3.40 to 3.79 L)/bag into a clean mixing vessel, then add the dry product. Mix for 3 to 5 minutes. Do not mix more material than can be placed within 15 minutes.

Placement: Do not apply to surfaces or in ambient temperatures below 45°F (7°C). Place in 1/8" to 4" (3 to 100 mm) lifts for vertical surfaces and 1/8" to 2" (3 to 50 mm) lifts for overhead applications. Trowel into place and allow to reach final set before the next lift. If additional lifts are required, score the surface of the placed mortar before it reaches final set.

Finishing: Finish the repair material to the desired texture. Do not add additional water to the surface during the finishing operation. Use EUCOBAR evaporation retarder.

Curing and Sealing: Curing is required. Cure with a Euclid Chemical high solids, water-based curing compound. (NOTE: A SOLVENT BASED CURING COMPOUND SHOULD NOT BE USED ON THIS PRODUCT). Under hot, windy or direct sunlight situations, apply a second coat of curing compound after the first has dried. If a curing compound is not desired, wet cure for a minimum of three days. When curing EUCOREPAIR V100 in potable water vessels, it is recommended to wet cure for 3 days, followed by 4 days of air cure prior to filling the vessel.

CLEAN-UP

Clean tools and equipment with water before the material hardens.

PRECAUTIONS/LIMITATIONS

- Do not allow repairs to freeze until the material has reached a minimum of 1,000 psi (7 MPa) compressive strength.
- Do not use as a horizontal topping.
- Do not add admixtures or aggregate extension.
- When necessary, follow the recommendations in ACI 305R "Guide to Hot Weather Concreting" or ACI 306R "Guide to Cold Weather Concreting".
- Use only potable water for mixing.
- Minimum application thickness 1/8" (3 mm).
- Minimum surface and ambient temperature 45°F (7°C) and rising at time of application.
- For optimum results, condition material to 65°F to 85°F (18°C to 29°C) at least 24 hours prior to use.
- Do not use a solvent based curing compound on this product.
- In all cases, consult the Safety Data Sheet before use.

Rev. 01.20

WARRANTY: The Euclid Chemical Company ("Euclid") solely and expressly warrants that its products shall be free from defects in materials and workmanship for one (1) year from the date of purchase. Unless authorized in writing by an officer of Euclid, no other representations or statements made by Euclid or its representatives, in writing or orally, shall alter this warranty. EUCLID MAKES NO WARRANTIES, IMPLIED OR OTHERWISE, AS TO THE MERCHANTABILITY OR FITNESS FOR ORDINARY OR PARTICULAR PURPOSES OF ITS PRODUCTS AND EXCLUDES THE SAME. If any Euclid product fails to conform with this warranty, Euclid will replace the product at no cost to Buyer. Replacement of any product shall be the sole and exclusive remedy available and buyer shall have no claim for incidental or consequential damages. Any warranty claim must be made within one (1) year from the date of the claimed breach. Euclid does not authorize anyone on its behalf to make any written or oral statements which in any way alter Euclid's installation information or instructions in its product literature or on its packaging labels. Any installation of Euclid products which fails to conform with such installation information or instructions shall void this warranty. Product demonstrations, if any, are done for illustrative purposes only and do not constitute a warranty or warranty alteration of any kind. Buyer shall be solely responsible for determining the suitability of Euclid's products for the Buyer's intended purposes.



EUCLID CHEMICAL

Guide Specification

The Euclid Chemical Company
19215 Redwood Road
Cleveland, OH 44110-2799
Phone: 800-321-7628
Fax: 216-531-9399
www.euclidchemical.com

EUCOREPAIR V100

Single component, low shrinkage, vertical and overhead repair mortar

{Note to Specifier: The paragraphs below are meant to be incorporated into Parts 2 and 3 of a standard CSI 3 Part Format specification, project's General Structural Notes or directly onto the plans. They must be carefully reviewed by a qualified design professional and edited to meet the particular requirements of the project at hand, assure compliance with any governing building codes, and coordinate with other specification sections and drawings.}

PART 2.0: PRODUCT

2. BONDING AGENT/PRIMER

{Note to Specifier: Certain bonding agents, adhesives and primers can be used to enhance the bond of this repair mortar. If desired choose a recommended bonding agent/primer from the data sheet and insert here. (Note: Latex additives will increase the volumetric resistivity of the mortar making it no longer compatible with Galvanic Anode Protection)}

2. CEMENTITIOUS REPAIR MORTAR

- A. Trowelable cementitious repair mortar for vertical and overhead, repairs up to 2" per lift: Cement-based, one component, fiber reinforced, polymer modified repair mortar containing corrosion inhibitor. Material shall have the following properties:
1. Compressive Strength minimum per ASTM C 109 modified 2" cubes
 - 1 day 3,000 psi
 - 7 days 4,500 psi
 - 28 days 6,000 psi
 2. Flexural Strength minimum per ASTM C 348
 - 7 days 500 psi
 - 28 days 600 psi
 3. Splitting Tensile Strength per ASTM C 496
 - 7 day 250 psi
 - 28 day 400 psi
 4. Bond Strength per ASTM C 882
 - 7 day 1,400 psi
 - 28 day 1,800 psi
 5. Modulus of Elasticity per ASTM C 469
 - 28 days 2.65×10^6
 6. Shrinkage per ASTM C 157 50% RH -0.020%
 7. Product:
 - a) Euclid Chemical Company (The); EucoRepair V100
www.euclidchemical.com
- B. Manufacturer shall have ISO 9001 Quality Certification. To ensure compatibility all admixtures shall be from the same manufacturer.
- C. To ensure compatibility bonding agent and curing compound if used shall be from same manufacturer as repair mortar.

2.____ CURING

{Note to Specifier: Euclid Chemical suggests curing this repair mortar with a high solids curing compound. If desired choose a recommended product from the data sheet and insert here. Guide spec language for these products can be found by accessing each product separately through this web site. Be advised that liquid curing compounds are typically not compatible with future penetrating sealer, adhesives or coatings. If such treatments are intended the specifier should insert language for a dissipating resin curing compound such as KUREZ DR VOX, a removable curing compound such as KUREZ RC, or insert language for proper moisture retaining curing methods meeting ACI 308. Duration of such cure should be minimum 3 days.}

PART 3.0: EXECUTION

3.____ SURFACE PREPARATION

- A. Concrete Removal: Remove all loose and unsound concrete per ICRI Guideline 310.1R “Guide for Surface Preparation”
 - 1. Unsound concrete surface areas shall have perimeter boundaries saw cut to minimum depth of ½” inch or less if such depth will cause saw to come in contact with embedded reinforcing steel. Saw cuts shall be made perpendicular to the concrete surface and all concrete removal boundaries shall be straight and aligned parallel to opposite boundary edges resulting in repair areas that are rectangular in shape.
 - 2. All concrete shall be removed from within repair boundary to minimum depth of ½” inch. Provide a surface with suitable profile for bond, as defined in repair mortar manufacturer’s written recommendations. If delaminations, cracking, or unsound materials exist beyond minimum removal depth, then removal shall continue until all unsound, delaminated, or cracked concrete has been removed from cavity.
- B. Preparing Reinforcing Steel: Clean and prepare any exposed embedded reinforcing steel per ICRI Guideline 310.1R. “Guide for Surface Preparation”
 - 1. Where ½ or more of diameter of reinforcement steel is exposed either by existing conditions or concrete removal, bond between the concrete and reinforcing steel is broken, or corrosion is present, the concrete shall be removed to provide a minimum ¾” clearance around entire perimeter of steel and along entire exposed length.
 - 2. Clean all exposed reinforcing steel to bright steel, prior to installation of repair mortar.
 - a) Where section loss on a reinforcing bar is more than *[insert number]*%, or *[insert number]*% in two or more adjacent bars contact Engineer.
- C. Concrete Preparation and Cleaning: Areas to receive concrete repair shall be structurally sound and free from deteriorated concrete, dust, dirt, debris, loosened concrete, paint, oil, efflorescence, laitance, and other contaminants, and shall have a minimum Concrete Surface Profile CSP equal to that recommended by the repair mortar manufacturer per ICRI Guideline 310.2.

3.____ REPAIR MORTAR APPLICATION:

- A. Repair Mortar Application: Mix and apply Repair Mortar per manufacturer's recommendations within the open time of the product scrub coat or any bonding agents. Finish to level of surrounding concrete surface utilizing techniques recommended by manufacturer.

BASE COAT SCRATCH & BROWN STUCCO



◆ The Pro's Choice Since 1936



Sakrete® Base Coat Scratch and Brown Stucco is a gray, blended, water resistant, portland/lime cement-based, material used for scratch and brown coat stucco work.

Features:

- Meets ASTM C926 Standard Specification for Application of Portland Cement-Based Plaster
- Preblend with sand requiring only the addition of water
- Can be used in a 3 coat system or 2 coat scratch and brown application
- Water resistant with a breathable finish

Use For:

- Concrete Block
- Vertical and overhead applications
- Scratch and Brown
- Applications over metal lath, welded or woven wire lath in accordance with ASTM C1063
- Brick or Stone

Yield/Water/Coverage:

Bag Size	Trowel Applied	Spray Applied	Water
80 lb (36.3 kg)	70 ft ² (6.4 m ²) at 1/8" (3.2 mm) thick or 35 ft ² (3.2 m ²) at 1/4" (6.4 mm) thick	60 ft ² (5.5 m ²) at 1/8" (3.2 mm) thick	1.5 gal (5.8 L)

NOTE: Yield and water are approximate. The yield above does not allow for waste and spillage. Coverage can vary depending upon texture, weather, method of application, workmanship and other conditions.

Color:

Gray

Technical Data:

Typical Values

Compressive Strength ASTM C109	
7 days	725 psi (5 MPa)
28 days	1,100 psi (7.6 MPa)

DIVISION 9
Portland Cement Plastering - 09 24 00

Preparation/Application:

For best results all material should be stored between 40°F (4°C) and 90°F (32°C).

1. Remove all unsound concrete, mortar, grease, oil, paint and other foreign materials that will inhibit performance.
2. When applying over a base coat, CMU (Concrete Masonry Unit) or other porous surfaces, dampen the surface first.
3. When applying over a smooth non-absorbent surface follow the provisions of ASTM C926 for surface treatment and the use of Sakrete Bonder & Fortifier or Sakrete Concrete Glue.
4. When used over old stucco, Sakrete Concrete Glue or Sakrete Bonder/Fortifier is required.

Refer to:

- ASTM D4258 Surface Cleaning of Concrete before painting
- ASTM C926 Application of Portland Cement Plaster
- ACI 524R Guide to Portland Cement Plastering

Placement:

1. Apply a scratch and brown coat in accordance with ASTM C926 prior to application of the stucco.
2. Install to a minimum thickness in accordance with the standards referenced.
3. Finish according to the texture specified. Wood floats are preferred.
4. Over-floating the material can result in color variations, mottling and surface defects.
5. The air, mix & substrate temperatures should all be between 40°F (4°C) to 90°F (32°C).

Spray Application:

Note: The following information is offered as a guide only. Specific product, equipment, application conditions and user experience will influence proper application results. Consult with the equipment manufacturer for equipment handling techniques. Field Test material with equipment prior to starting project.

Spray an even, consistent coat, moving the nozzle with a steady, even motion, maintaining the same distance and angle from the wall.

Progressive Cavity Pump	Hose diameter & max length	Gun	Tip	Pressure at Pump	Pressure at Gun
2.5 L	1" to 1.5" (25.4 to 38.1 mm)	Pole	7/16" to 9/16" (11.1 to 14.3 mm)	300-400 psi (2.1-2.8 MPa)	Air compressor to furnish 50 psi (0.3 MPa)

Mixing:

1. Use clean tools and potable water. A mixer will help with uniformity.
2. Use approximately 1 1/2 gal (5.8 L) of water per 80 lb (36.3 kg) bag.
3. Place the water in the mixer, gradually adding the stucco to the mixing water and mix until material is wet and of a trowelable consistency (about 3 - 4 minutes).
4. Water and mixing time must be kept to a minimum and be consistent between batches. Inconsistent amounts of water from bag to bag will result in color variations on the wall.



BASE COAT SCRATCH & BROWN STUCCO

◆ The Pro's Choice Since 1936

5. Allow mixer to sit for 2 minutes, than remix for one minute. A small amount of water may be added at this time if mix is stiff.
6. Mix only quantities that can be applied within one hour.
7. If mixture becomes stiff and difficult to trowel, discard it. Do not re-temper. Re-tempering will seriously affect performance.
8. When used over porous substrates and/or during hot, dry weather replace 1/2 gallon of water with the Sakrete Bonder & Fortifier or prime with Sakrete Concrete Glue.

Note: Refer to applicable sections of the standards referenced. DO NOT re-temper. Re-tempering will seriously affect color. When using Sakrete Bonder & Fortifier, pre-dilute with water first before mixing with the stucco. The addition of Bonder & Fortifier improves bond, curing, reduces shrinkage cracks, improves color retention and helps reduce efflorescence.

Curing:

1. Proper curing is critical for sound results.
2. Protect newly applied substrates from rain for 24 hours. Protect from freezing for 24 hours after application.
3. Materials modified with Sakrete Bonder & Fortifier should be air cured, unless hot and/or drying winds or low humidity are present. Under such conditions if not modified, lightly fog spray.
4. Cure per American Concrete Institute 308-Standard Practice for Curing Concrete. As with all stucco, surface cracking may occur due to curing conditions, control joint configurations, over-watering, over-troweling or other conditions beyond the control of the manufacturers of Sakrete products.
5. Efflorescence is a naturally occurring phenomenon associated with portland cement based products. Elevated mineral content, salts, or other particulates can exacerbate this condition.

Precautions:

- DO NOT apply over substrates that are frozen.
- DO NOT apply if air or substrate temperature is below 40°F (4°C) or above 90°F (32°C).
- DO NOT apply when temperature is expected to fall below 40°F (4°C) within 48 hours.
- DO NOT over-water.
- DO NOT over-float material.
- DO NOT use high mineral content or salt water.
- DO NOT apply over painted, sealed or slick surfaces.

NOTE: Proper application and installation of all Sakrete products are the responsibility of the end user.

Safety:

READ and UNDERSTAND the Safety Data Sheet (SDS) before using this product. WARNING: Wear protective clothing and equipment. For emergency information, call CHEMTREC at 800-424-9300 or 703-527-3887 (outside USA).

KEEP OUT OF REACH OF CHILDREN.

Limited Product Warranty:

The manufacturer warrants that this product shall be of merchantable quality when used or applied in accordance with the manufacturer's instructions. This product is not warranted as suitable for any purpose other than the general purpose for which it is intended. This warranty runs for one (1) year from the dates the product is purchased. ANY IMPLIED WARRANTY OF MERCHANTABILITY OR FITNESS FOR A PARTICULAR PURPOSE ON THIS PRODUCT IS LIMITED TO THE DURATION OF THIS WARRANTY. Liability under this warranty is limited to replacement or defective products or, at the manufacturer's option, refund of the purchase price. CONSEQUENTIAL AND INCIDENTAL DAMAGES ARE NOT RECOVERABLE UNDER THIS WARRANTY.

Limestone Finish

100% acrylic polymer finish coat

Product Bulletin

DESCRIPTION

Factory-mixed, 100% acrylic polymer finish coat. Limestone Finish utilizes uniformly-sized aggregate for a smooth, fine texture.

PACKAGING

31.7-kg per 19-liter pail
(70-lbs per 5-gallon pail).

COVERAGE

(Approximate) 14.8 m² (160 ft.²)
per pail

COLORS

Available in a wide variety of
standard and custom colors



USES

1. Provides an aesthetically pleasing surface color and texture for the Finestone Wall Systems.
2. Can also be utilized as a textured finish for poured concrete or unit masonry, conventional stucco, Finestone Stucco Wall System, FINESTONE Cement-Board Stucco, certain insulating concrete forms, and interior veneer plaster or gypsum wallboard.

Features	Benefits
100% Acrylic polymer chemistry	Long-term durability and weather resistance
Integral color	Reduced maintenance and recoating
Weather resistant	Repels water and resists wind-driven rain
Seals existing, non-moving hairline cracks	Protects
Breathable	Doesn't blister, peel or flake

Limestone Finish

MIXING

1. Thoroughly mix the factory-prepared LIMESTONE Finish with a mixer until thoroughly blended.
2. A small amount of clean, potable water may be added to adjust workability.
3. Additives are not permitted.
4. Close container when not in use.
5. Clean tools with soap and water immediately after use.

APPLICATION

1. Substrate shall be dry, clean, sound and free of releasing agents, paint or other residue or coatings. Verify substrate is flat, free of fins or planar irregularities greater than 6.4 mm in 3 m (1/4" in 10').
2. Apply LIMESTONE Finish directly to the Finestone Base Coat/ Reinforcing Mesh with a clean, stainless steel trowel.
3. Apply and level LIMESTONE Finish during the same operation to minimum obtainable thickness consistent with uniform coverage.
4. Maintain a wet edge on LIMESTONE Finish by applying and texturing continually over the wall surface.
5. Work LIMESTONE Finish to corners, joints or other natural breaks and do not allow material to set up within an uninterrupted wall area.
6. Float LIMESTONE Finish to achieve final texture.

LIMITATIONS

1. Protect Finestone materials during transportation and installation to avoid physical damage.
2. Store Finestone materials in a cool, dry place protected from freezing. Store at no less than 4°C (40°F). Protect from extreme heat and direct sunlight. Shelf life is two years when unopened and stored as directed.
3. Do not apply Finestone materials in ambient temperatures below 4°C (40°F). Provide supplementary heat during installation and drying period (at least 24 hours after installation and until dry) when temperatures less than 4°C (40°F) prevail.
4. Do not apply Finestone materials to frozen surfaces.
5. Samples of LIMESTONE Finish are available from Finestone for color approval only. Samples for job approval must be made in the field by the applicator, and approved prior to ordering.

HEALTH, SAFETY AND ENVIRONMENTAL

Read, understand and follow all Safety Data Sheets and product label information for this product prior to use. The SDS can be obtained by visiting www.finestone.basf.com. Use only as directed.

TECHNICAL SUPPORT

Consult our Technical Services Department for specific recommendations concerning all other applications. Consult the web site, www.finestone.basf.com for additional information and for updated literature.

WARRANTY

BASF warrants this product to be free from manufacturing defects and to meet the technical properties on the current Product Bulletin, if used as directed within shelf life. Satisfactory results depend not only on quality products but also upon many factors beyond our control. BASF MAKES NO OTHER WARRANTY OR GUARANTEE, EXPRESS OR IMPLIED, INCLUDING WARRANTIES OF MERCHANTABILITY OR FITNESS FOR A PARTICULAR PURPOSE WITH RESPECT TO ITS PRODUCTS. The sole and exclusive remedy of Purchaser for any claim concerning this product, including but not limited to, claims alleging breach of warranty, negligence, strict liability or otherwise, is shipment to purchaser of product equal to the amount of product that fails to meet this warranty or refund of the original purchase price of product that fails to meet this warranty, at the sole option of BASF. In the absence of an extended warranty issued by BASF, any claims concerning this product must be received in writing within one (1) year from the date of shipment and any claims not presented within that period are waived by Purchaser. BASF WILL NOT BE RESPONSIBLE FOR ANY SPECIAL, INCIDENTAL, CONSEQUENTIAL (INCLUDING LOST PROFITS) OR PUNITIVE DAMAGES OF ANY KIND.

Purchaser must determine the suitability of the products for the intended use and assumes all risks and liabilities in connection therewith. This information and all further technical advice are based on BASF's present knowledge and experience. However, BASF assumes no liability for providing such information and advice including the extent to which such information and advice may relate to existing third party intellectual property rights, especially patent rights, nor shall any legal relationship be created by or arise from the provision of such information and advice. BASF reserves the right to make any changes according to technological progress or further developments. The Purchaser of the Product(s) must test the product(s) for suitability for the intended application and purpose before proceeding with a full application of the product(s). Performance of the product described herein should be verified by testing and carried out by qualified experts.



Example of historic brick building in historic Key West with similar stucco repair. 201 Simonton.



Example of historic brick building in historic Key West with similar stucco repair

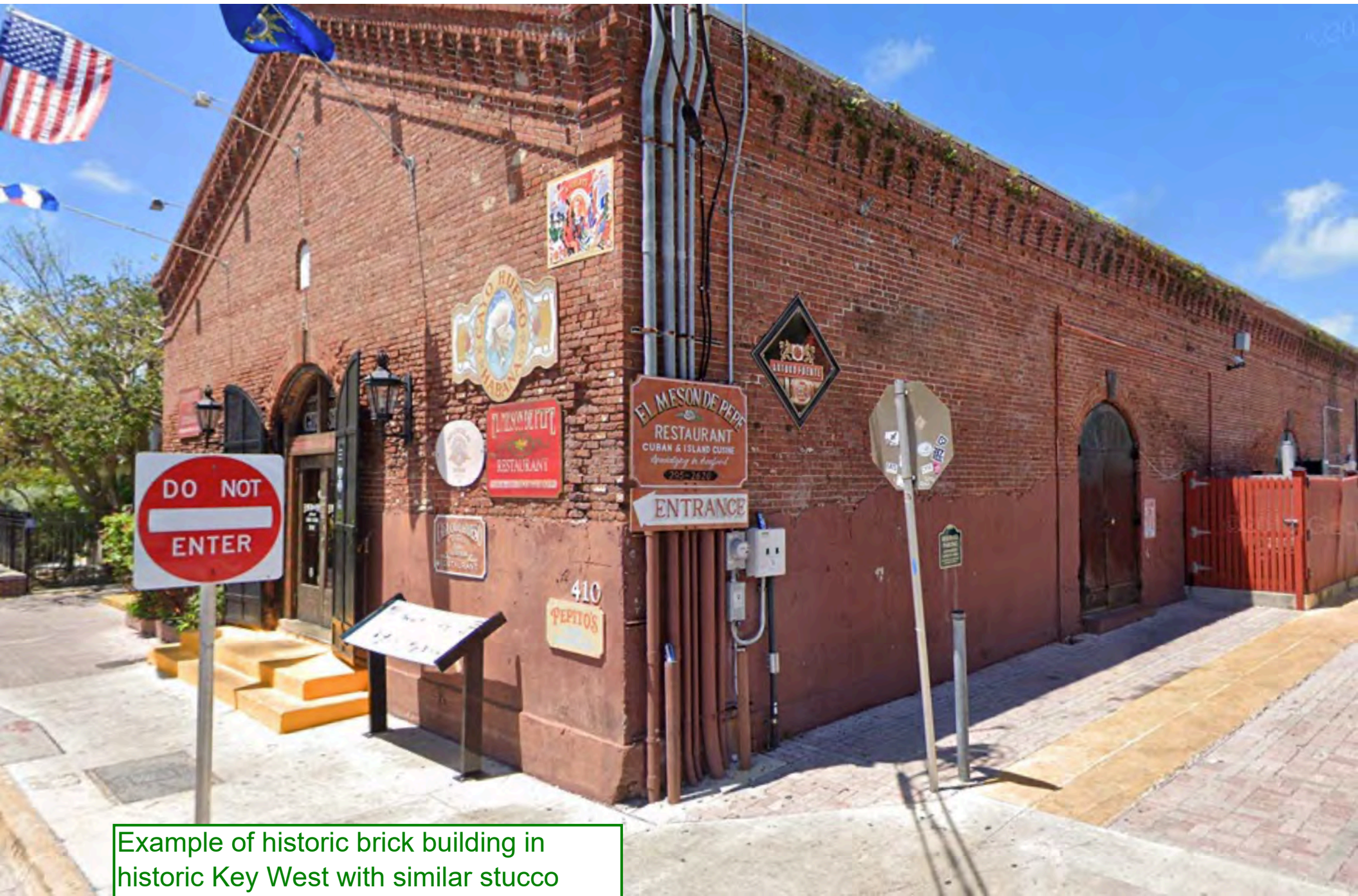

Example of historic brick building in historic Key West with similar stucco repair. 410 Wall St.



Example of historic brick building in historic Key West with similar stucco repair. 536 Fleming.



Example of historic brick building in historic Key West with similar stucco repair. 427 Front St.



Example of historic brick building in historic Key West with similar stucco repair. 423 Front St.

NOTICING

Public Meeting Notice

The Historic Architectural Review Commission will hold a virtual meeting at **5:00 p.m., June 23, 2020**. In order to view the live feed of the meeting, you can tune in to Comcast channel 77, AT&T Uverse channel 99, or type this link into your browser: http://keywestcity.granicus.com/MediaPlayer.php?publish_id=1&embed=1

The purpose of the hearing will be to consider a request for:

REPAIR DAMAGE BRICK WITH STUCCO APPLICATION. THE STUCCO REPAIR WILL ONLY BE APPROXIMATELY 5 FEET ABOVE THE FRONT PORCH ELEVATION AND DOWN.

#529 CAROLINE STREET

Applicant – Chas Spottswood Application #BLDG. 2019-1671

If you wish to see the application or have any questions, you may contact the Planning Department during regular office hours at 305-809-3973 or visit our website at www.cityofkeywest-fl.gov.

THIS NOTICE CAN NOT BE REMOVED FROM THE SITE UNTIL HARC FINAL DETERMINATION

ADA ASSISTANCE: It is the policy of the City of Key West to comply with all requirements of the Americans with Disabilities Act (ADA). Please call the TTY number at 800-955-8771 or 800-955-8770 (Voice) or the ADA Coordinator at 305-809-3811 at least five business days in advance for sign language interpreters, assistive listening devices, or materials in accessible format.

PROPERTY APPRAISER INFORMATION



Disclaimer

The Monroe County Property Appraiser's office maintains data on property within the County solely for the purpose of fulfilling its responsibility to secure a just valuation for ad valorem tax purposes of all property within the County. The Monroe County Property Appraiser's office cannot guarantee its accuracy for any other purpose. Likewise, data provided regarding one tax year may not be applicable in prior or subsequent years. By requesting such data, you hereby understand and agree that the data is intended for ad valorem tax purposes only and should not be relied on for any other purpose.

By continuing into this site you assert that you have read and agree to the above statement.

Summary

Parcel ID 00001220-000000
 Account# 1001244
 Property ID 1001244
 Millage Group 10KW
 Location 529 CAROLINE St, KEY WEST
 Address
 Legal KW PT LOT 4 SQR 13 G10-430/431 OR636-724/726 OR744-708/09 OR744-710 OR744-774/776
 Description OR769-1516 OR790-1315 OR1120-1532/33 OR1125-1564/65 OR1367-2001/13 OR2702-2128/29 OR2953-2274
 (Note: Not to be used on legal documents.)
 Neighborhood 32040
 Property Class HOTEL/MOTEL (3900)
 Subdivision
 Sec/Twp/Rng 06/68/25
 Affordable No
 Housing



Owner

SVR 529 LLC
 506 Fleming St
 Key West FL 33040

Valuation

	2019	2018	2017	2016
+ Market Improvement Value	\$443,202	\$460,875	\$460,875	\$406,600
+ Market Misc Value	\$4,509	\$4,635	\$4,762	\$5,004
+ Market Land Value	\$901,740	\$880,270	\$880,270	\$855,224
= Just Market Value	\$1,349,451	\$1,345,780	\$1,345,907	\$1,266,828
= Total Assessed Value	\$1,349,451	\$1,345,780	\$1,345,907	\$1,266,828
- School Exempt Value	\$0	\$0	\$0	\$0
= School Taxable Value	\$1,349,451	\$1,345,780	\$1,345,907	\$1,266,828

Land

Land Use	Number of Units	Unit Type	Frontage	Depth
COMMERCIAL DRY (100D)	5,650.00	Square Foot	56.5	105

Commercial Buildings

Style R8 / R8
 Gross Sq Ft 3,371
 Finished Sq Ft 2,798
 Perimeter 608
 Stories 2
 Interior Walls WALL BD/WD WAL
 Exterior Walls HARDIE BD
 Quality 650 ()
 Roof Type IRR/CUSTOM
 Roof Material METAL
 Exterior Wall1 HARDIE BD
 Exterior Wall2
 Foundation CONCR FTR
 Interior Finish WALL BD/WD WAL
 Ground Floor Area
 Floor Cover SFT/HD WD
 Full Bathrooms 3
 Half Bathrooms 0
 Heating Type FCD/AIR DUCTED with 0% NONE
 Year Built 1938
 Year Remodeled
 Effective Year Built 1995
 Condition

Code	Description	Sketch Area	Finished Area	Perimeter
OPX	EXC OPEN PORCH	528	0	200
FLA	FLOOR LIV AREA	2,798	2,798	380
SBF	UTIL FIN BLK	45	0	28
TOTAL		3,371	2,798	608

Style	S.F.R. - R1 / R1
Gross Sq Ft	312
Finished Sq Ft	200
Perimeter	106
Stories	1
Interior Walls	DRYWALL
Exterior Walls	WD FRAME
Quality	450 ()
Roof Type	GABLE/HIP
Roof Material	METAL
Exterior Wall1	WD FRAME
Exterior Wall2	
Foundation	CONCRETE SLAB
Interior Finish	DRYWALL
Ground Floor Area	
Floor Cover	CONC S/B GRND
Full Bathrooms	1
Half Bathrooms	0
Heating Type	NONE with 0% NONE
Year Built	1966
Year Remodeled	
Effective Year Built	1987

Code	Description	Sketch Area	Finished Area	Perimeter
FLA	FLOOR LIV AREA	200	200	60
OPU	OP PR UNFIN LL	112	0	46
TOTAL		312	200	106

Yard Items

Description	Year Built	Roll Year	Quantity	Units	Grade
FENCES	1937	1938	1	132 SF	3
CONC PATIO	1937	1938	1	200 SF	1
CONC PATIO	1937	1938	1	49 SF	2
CH LINK FENCE	1964	1965	1	228 SF	1
BRICK PATIO	1974	1975	1	352 SF	2
FENCES	1989	1990	1	84 SF	2
FENCES	2001	2002	1	300 SF	5

Sales

Sale Date	Sale Price	Instrument	Instrument Number	Deed Book	Deed Page	Sale Qualification	Vacant or Improved
3/15/2019	\$2,290,000	Warranty Deed	2211205	2953	2274	37 - Unqualified	Improved
9/10/2014	\$0	Quit Claim Deed		2702	2128	11 - Unqualified	Improved
10/1/1977	\$87,000	Conversion Code		790	1315	Q - Qualified	Improved

Permits

Number	Date Issued	Date Completed	Amount	Permit Type	Notes
BLD2019-2877	8/14/2019		\$15,000	Commercial	Relocate existing 200A:120/240V
BLD2019-2602	7/25/2019		\$32,000	Commercial	6- Bathrooms - 6 Toilets,6 Lava,6 Showers, 1 Water heater, 1 washer , 1 kitchen sink. Tie into existing water & sewer
BLD2019-1671	5/23/2019		\$500,000	Commercial	Relocate existing baths convert 1/2 bath to ADA Less than 10% repairs to existing brick, fascia, and deck boards with like materials (MEP and roofing under separate permit application)
0100719	2/23/2001	10/30/2001	\$3,600	Residential	REMOVE/REBUILD COLUMNS

View Tax Info

[View Taxes for this Parcel](#)

Sketches (click to enlarge)

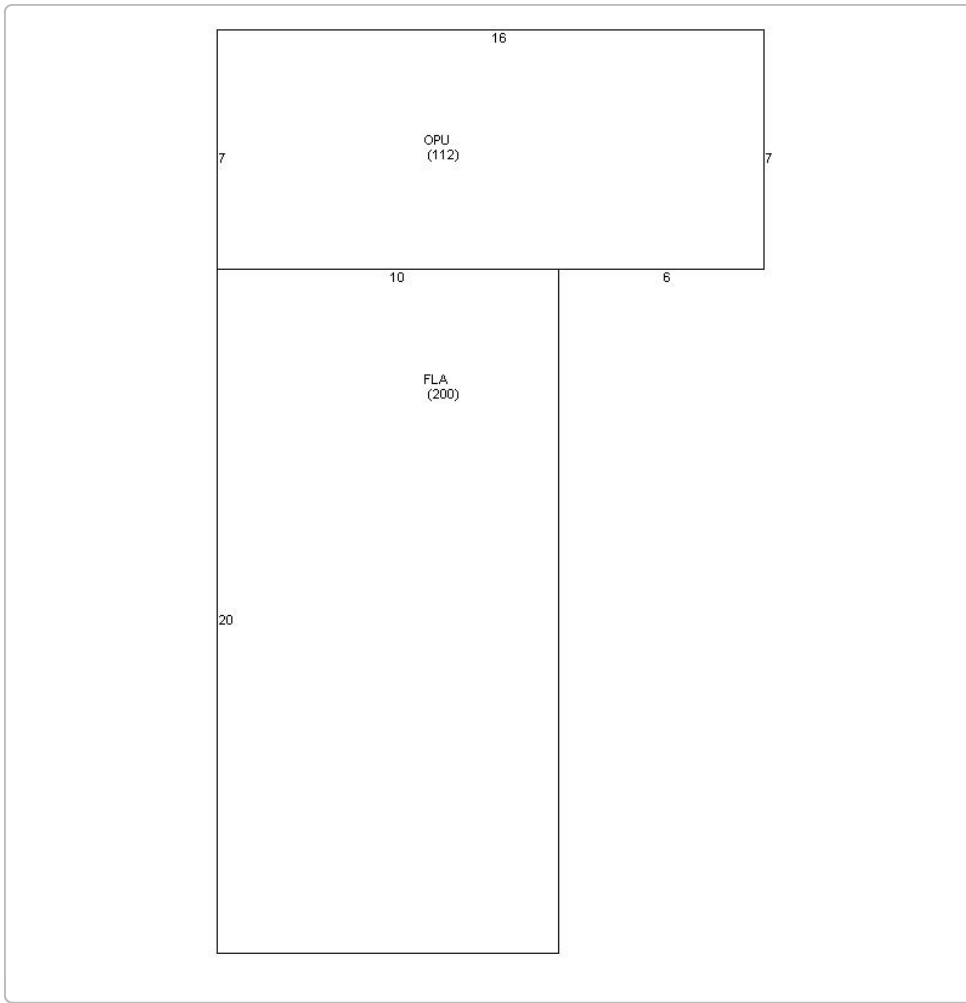

Photos



Map



TRIM Notice

Trim Notice

2019 Notices Only

No data available for the following modules: Buildings, Mobile Home Buildings, Exemptions.

The Monroe County Property Appraiser's office maintains data on property within the County solely for the purpose of fulfilling its responsibility to secure a just valuation for ad valorem tax purposes of all property within the County. The Monroe County Property Appraiser's office cannot guarantee its accuracy for any other purpose. Likewise, data provided regarding one tax year may not be applicable in prior or subsequent years. By requesting such data, you hereby understand and agree that the

[User Privacy Policy](#)
[GDPR Privacy Notice](#)

Last Data Upload: [2/20/2020 2:14:27 AM](#)

Developed by



[Version 2.3.41](#)