



**Historic Architectural Review Commission
Staff Report for Item 6**

To: Chairman Bryan Green and Historic Architectural Review Commission Members

From: Enid Torregrosa, MSHP
Historic Preservation Planner

Meeting Date: April 26, 2016

Applicant: Wayne Garcia

Application Number: H16-01-0002

Address: #1109 Virginia Street

Description of Work:

New pool house and relocate pool equipment.

Site Facts:

The main house on the site is a contributing resource to the historic district. The one-story frame structure was built in 1928. At the rear of the house, there is a small pool, a wood deck, and a wood frame structure with a tarp, which has not received any approvals for construction.

Guidelines Cited on Review:

- New construction (pages 36-38a), specifically all guidelines for new construction.
- Outbuildings (pages 40-41), specifically guidelines 1, 10 and 11.

Staff Analysis

The plans under review are for the construction of a one-story frame pool cabana. The structure will be lower in height than the main house and will be located on the back yard, behind the historic house. The new structure is rectangular in footprint and will have a gable roof. The design proposes as finish materials hardi board siding and metal v-crimp roofing system. The structure will have PGT aluminum impact windows and doors.

The plan also includes the relocation of the existing pool equipment in order to create room for the cabana.

Consistency with Guidelines

It is staff's opinion that the proposed design meets the cited guidelines. The proposed accessory structure will be smaller in scale and massing than the principal structure and surrounding buildings. The building is in keeping with the urban context in terms of materials, scale, and building form.

APPLICATION

COMBINATION APPLICATION: FLOODPLAIN, CONSTRUCTION AND HARC

\$50.00 APPLICATION FEE NON-REFUNDABLE



City of Key West

3140 FLAGLER AVENUE
KEY WEST, FLORIDA 33040

Phone: 305.809.3956

HARC PERMIT NUMBER 16-01-0002	BUILDING PERMIT NUMBER 16-0010	INITIAL & DATE
FLOODPLAIN PERMIT		REVISION #
FLOOD ZONE	PANEL #	ELEV. L. FL.
		SUBSTANTIAL IMPROVEMENT ___ YES ___ NO ___ %

ADDRESS OF PROPOSED PROJECT:

1109 VIRGINIA STREET

OF UNITS

1

RE # OR ALTERNATE KEY:

KW GWYNN SUB 0-195 PT LOT 21 TR 13

NAME ON DEED:

ROBERT E. SCHARLL

PHONE NUMBER

802-254-0857

OWNER'S MAILING ADDRESS:

P.O. Box 691

EMAIL

RSCHARLL@GFLA.COM

BROTTSBORO VT 05302

CONTRACTOR COMPANY NAME:

Wayne Garcia, Bldg. Cont.

PHONE NUMBER

(305) 360-1820

CONTRACTOR'S CONTACT PERSON:

Wayne Garcia

EMAIL

ARCHITECT / ENGINEER'S NAME:

Annalise Mannix

PHONE NUMBER

(305) 797-0463

ARCHITECT / ENGINEER'S ADDRESS:

3739 Parks Ave.

EMAIL

amannix@aol.com

Key West FL 33040

HARC: PROJECT LOCATED IN HISTORIC DISTRICT OR IS CONTRIBUTING: YES ___ NO (SEE PART C FOR HARC APPLICATION.)

CONTRACT PRICE FOR PROJECT OR ESTIMATED TOTAL FOR MAT'L., LABOR & PROFIT:

\$37,000.00

FLORIDA STATUTE 837.06: WHOEVER KNOWINGLY MAKES A FALSE STATEMENT IN WRITING AND WITH THE INTENT TO MISLEAD A PUBLIC SERVANT IN THE PERFORMANCE OF HIS OR HER OFFICIAL DUTY SHALL BE GUILTY OF A MISDEMEANOR OF THE SECOND DEGREE PUNISHABLE PER SECTION 775.082 OR 775.083.

PROJECT TYPE: ONE OR TWO FAMILY ___ MULTI-FAMILY ___ COMMERCIAL NEW ___ REMODEL
 ___ CHANGE OF USE / OCCUPANCY ___ ADDITION ___ SIGNAGE ___ WITHIN FLOOD ZONE ___
 DEMOLITION ___ SITE WORK ___ INTERIOR EXTERIOR ___ AFTER-THE-FACT

DETAILED PROJECT DESCRIPTION INCLUDING QUANTITIES, SQUARE FOOTAGE ETC.,

POOL HOUSE AS PER PLANS BY A. MANNIX APPROX. 272 SQ. FT.

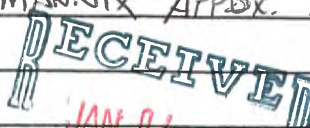

I HAVE OBTAINED ALL NECESSARY APPROVALS FROM ASSOCIATIONS, GOV'T AGENCIES AND OTHER PARTIES AS APPLICABLE TO COMPLETE THE DESCRIBED PROJECT:

OWNER PRINT NAME: **ROBERT E. SCHARLL**

QUALIFIER PRINT NAME: **WAYNE GARCIA**

OWNER SIGNATURE: *[Signature]*

QUALIFIER SIGNATURE: *[Signature]*

Notary Signature as to owner: *[Signature]*

Notary Signature as to qualifier: *[Signature]*

STATE OF FLORIDA, COUNTY OF MONROE, SWORN TO AND SCRIBED BEFORE ME THIS **1st** DAY OF **December**, 20 **15**.

STATE OF FLORIDA, COUNTY OF MONROE, SWORN TO AND SCRIBED BEFORE ME THIS **31st** DAY OF **December**, 20 **15**.

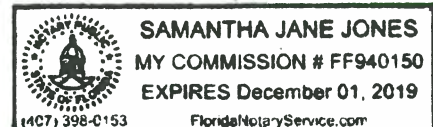

[Signature]
Samantha Jane Jones

Personally known or produced as identification

Planning Department 2/24/2016 M. Leto

52388-3959-0K

PART B:

SUPPLEMENTARY PROJECT DETAILS TO AVOID DELAYS / CALL-BACKS

PROPERTY STRUCTURES AFFECTED BY PROJECT: MAIN STRUCTURE ACCESSORY STRUCTURE SITE

ACCESSORY STRUCTURES: GARAGE / CARPORT DECK FENCE OUTBUILDING / SHED

FENCE STRUCTURES: 4 FT. 6 FT. SOLID 6 FT. / TOP 2 FT. 50% OPEN

POOLS: INGROUND ABOVE GROUND SPA / HOT TUB PRIVATE PUBLIC
 PUBLIC POOLS REQUIRE BD. OF HEALTH LICENSE APPLICATION AT TIME OF CITY APPLICATION.
 PUBLIC POOLS REQUIRE BD. OF HEALTH LICENSE PRIOR TO RECEIVING THE CITY CERTIFICATE OF OCCUPANCY.

ROOFING: NEW ROOF-OVER TEAR-OFF REPAIR AWNING
 5 V METAL ASPLT. SHGLS. METAL SHGLS. BLT. UP TPO OTHER

FLORIDA ACCESSIBILITY CODE: 20% OF PROJECT FUNDS INVESTED IN ACCESSIBILITY FEATURES.

SIGNAGE: # OF SINGLE FACE # OF DOUBLE FACE REPLACE SKIN ONLY BOULEVARD ZONE
 POLE WALL PROJECTING AWNING HANGING WINDOW
 SQ. FT. OF EACH SIGN FACE: _____

SUBCONTRACTORS / SPECIALTY CONTRACTORS SUPPLEMENTARY INFORMATION:

MECHANICAL: DUCTWORK COMMERCIAL EXH. HOOD INTAKE / EXH. FANS LPG TANKS
 A/C: COMPLETE SYSTEM AIR HANDLER CONDENSER MINI-SPLIT

ELECTRICAL: LIGHTING RECEPTACLES HOOK-UP EQUIPMENT LOW VOLTAGE
 SERVICE: OVERHEAD UNDERGROUND 1 PHASE 3 PHASE _____ AMPS

PLUMBING: ONE SEWER LATERAL PER BLDG. INGROUND GREASE INTCPTRS. LPG TANKS
 RESTROOMS: MEN'S WOMEN'S UNISEX ACCESSIBLE

PART C:

HARC APPLICATION FOR A CERTIFICATE OF APPROPRIATENESS

APPLICATION FEES: PAINTING SINGLE FAMILY: \$10 STAFF APPROVAL: \$50 COMMISSION REVIEW \$100
 PLEASE ATTACH APPROPRIATE VARIANCES / RESOLUTIONS FROM HARC, PLANNING BOARD OR TREE COMMISSION.
 ATTENTION: NO BUILDING PERMITS WILL BE ISSUED PRIOR TO HARC APPROVAL.

PLEASE SEND ELECTRONIC SUBMISSIONS TO: harc@cityofkeywest-fl.gov

INDICATE TYPE OF CERTIFICATE. OF APPROPRIATENESS: GENERAL DEMOLITION SIGN PAINTING OTHER

ADDITIONAL INFORMATION: _____

PROJECT SPECIFICATIONS: PLEASE PROVIDE PHOTOS OF EXISTING CONDITIONS, PLANS, PRODUCT SAMPLES, TECHNICAL DATA

ARCHITECTURAL FEATURES TO BE ALTERED:	ORIGINAL MATERIAL:	PROPOSED MATERIAL:

DEMOLITION: PLEASE FILL OUT THE HARC APPENDIX FOR PROPOSED DEMOLITION.

DEMOLITION OF HISTORIC STRUCTURES IS NOT ENCOURAGED BY THE HISTORIC ARCHITECTURAL REVIEW COMMISSION.

SIGNAGE: (SEE PART B) BUSINESS SIGN BRAND SIGN OTHER: _____

BUSINESS LICENSE # _____ IF FAÇADE MOUNTED, SQ. FT. OF FAÇADE _____

Oper: KEYWBLD Type: BP Drawer: 1
 Date: 1/04/16 50 Receipt no: 6949
 2016 1000002
 PT * BUILDING PERMITS-NEW
 1.00 \$50.00
 Trans number: 3074750
 CK CHECK 9350 \$100.00
 Trans date: 1/04/16 Time: 12:42:35

SIGN SPECIFICATIONS		
SIGN COPY:	PROPOSED MATERIALS:	SIGNS WITH ILLUMINATION:
		TYPE OF LTG.:
		LTG. LINEAL FTG.:
MAX. HGT. OF FONTS:		COLOR AND TOTAL LUMENS:
IF USING LIGHT FIXTURES PLEASE INDICATE HOW MANY: INCLUDE SPEC. SHEET WITH LOCATIONS AND COLORS.		

OFFICIAL USE ONLY:		HARC STAFF OR COMMISSION REVIEW	
___ APPROVED ___ NOT APPROVED ___ DEFERRED FOR FUTURE CONSIDERATION ___ TABLED FOR ADD'L. INFO.			
HARC MEETING DATE:	HARC MEETING DATE:	HARC MEETING DATE:	
REASONS OR CONDITIONS:			
STAFF REVIEW COMMENTS:			
<i>Main house is listed as contributing Guidelines for outbuildings</i>			
HARC PLANNER SIGNATURE AND DATE:		HARC CHAIRPERSON SIGNATURE AND DATE:	

PART D: STATE OF FLORIDA OFFICIAL NOTIFICATIONS AND WARNINGS

FLORIDA STATUTE 713.135: WARNING TO OWNER: YOUR FAILURE TO RECORD A 'NOTICE OF COMMENCEMENT' MAY RESULT IN YOUR PAYING TWICE FOR IMPROVEMENTS TO YOUR PROPERTY. A NOTICE OF COMMENCEMENT MUST BE RECORDED WITH THE COUNTY RECORDER AND A COPY POSTED ON THE JOB SITE BEFORE THE FIRST INSPECTION. IF YOU INTEND TO OBTAIN FINANCING CONSULT WITH YOUR LENDER OR AN ATTORNEY BEFORE RECORDING A NOTICE.

FLORIDA STATUTE 469: ABESTOS ABATEMENT. AS OWNER / CONTRACTOR / AGENT OF RECORD FOR THE CONSTRUCTION APPLIED FOR IN THIS APPLICATION, I AGREE THAT I WILL COMPLY WITH THE PROVISIONS F. S. 469.003 AND TO NOTIFY THE FLORIDA D. E. P. OF MY INTENT TO DEMOLISH / REMOVE ASBESTOS. IN ADDITION TO THE REQUIREMENTS OF THIS PERMIT APPLICATION, THERE MAY BE DEED RESTRICTIONS AND / OR ADDITIONAL RESTRICTIONS APPLICABLE TO THIS PROPERTY THAT MAY BE FOUND IN THE PUBLIC RECORDS OF MONROE COUNTY AND THERE MAY BE ADDITIONAL PERMITS REQUIRED FROM OTHER GOVERNMENT ENTITIES SUCH AS AQUADUCT ATHORITY, FLORIDA DEP OR OTHER STATE AGENCIES; ARMY CORPS OF ENGINEERS OR OTHER FEDERAL AGENCIES.

FEDERAL LAW REQUIRES LEAD PAINT ABATEMENT PER THE STANDARDS OF THE USDEP ON STRUCTURES BUILT PRIOR TO 1978.

OFFICIAL USE ONLY BY PLANS EXAMINER OR CHIEF BUILDING OFFICIAL:				CBO OR PL. EXAM. APPROVAL:	
HARC FEES:	BLDG. FEES:	FIRE MARSHAL FEE:	IMPACT FEES:		
				DATE:	

Oper: KEYBLD Tyon: OC Drawer: L
 Date: 3/04/16 53 Receipt no: 11447
 2016 1000002
 PT * BUILDING PERMITS-NEW
 1.00 \$50.00
 Trans number: 3078046
 VM VISA/MASTERC \$50.00
 Trans date: 3/03/16 Time: 17:05:59

SANBORN MAPS

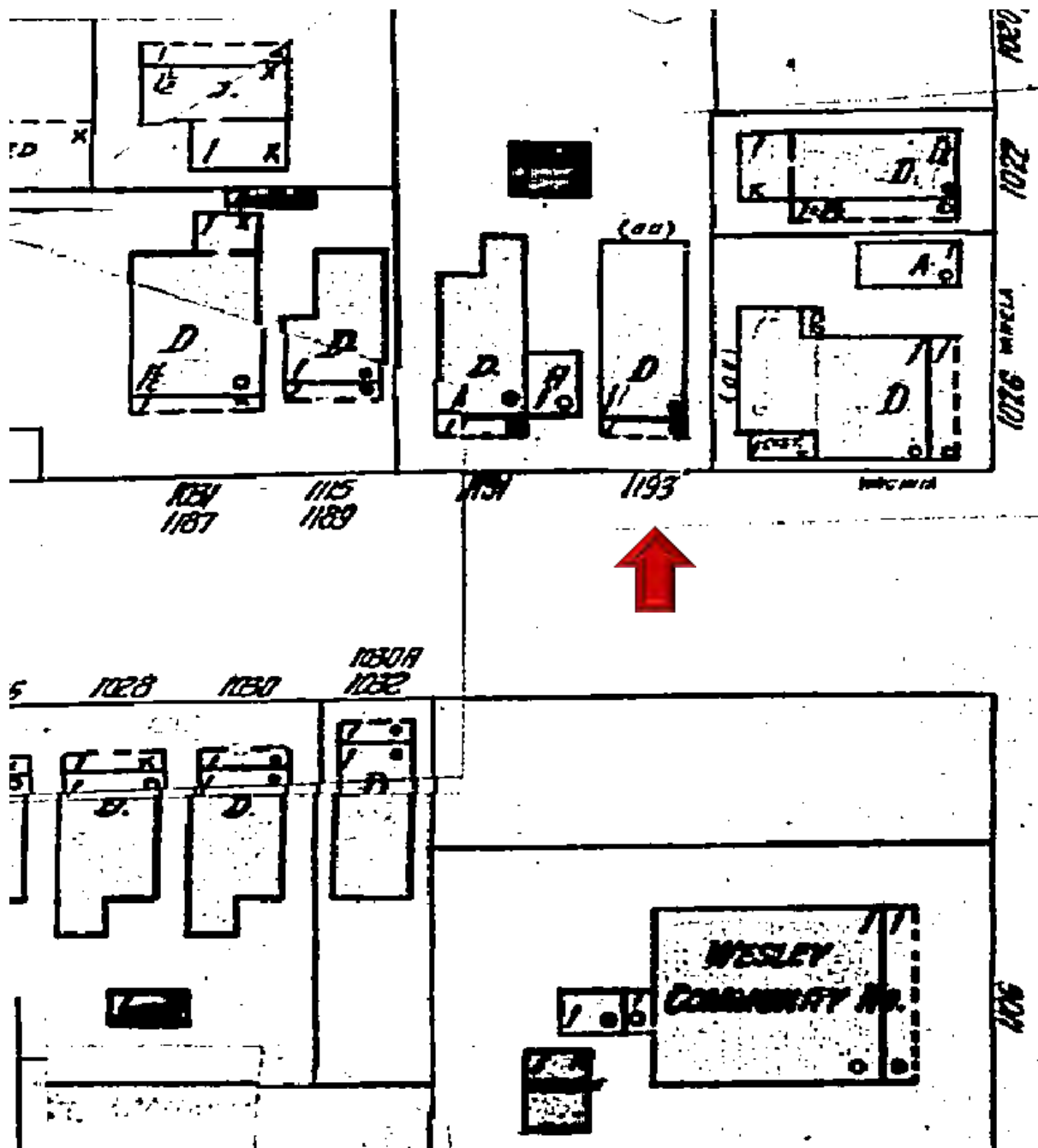

#1109 Virginia Street Sanborn map 1948

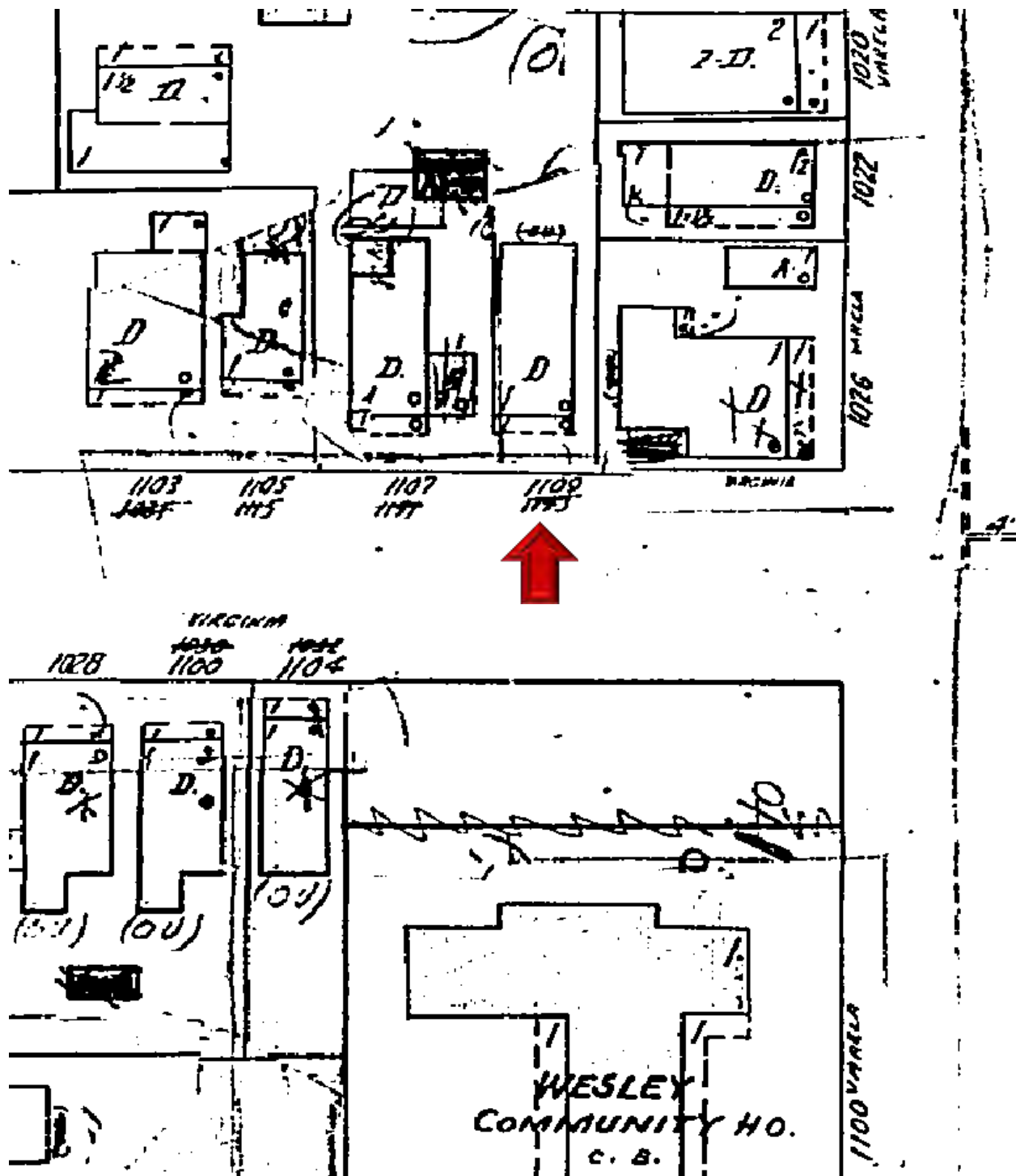

#1109 Virginia Street Sanborn map 1962

PROJECT PHOTOS



Pictures with descriptions for Enid

Perhaps the most important things insofar as HARC is concerned, is:

- That it will be nearly impossible for anyone to see the structure from the street, due to how far it sits back, the existing vegetation on both sides of the property, and the existing fences between the properties.
- The structure will look exactly like the house, i.e. siding, trim, roofing, etc.

Street view. Note: Only place structure will be seen is possibly through this screen doorway (now no longer rusty) Gumbo limbo, while needing to be trimmed, also obstructs view somewhat. Not visible at all from Simon's house (Right side) due to existing fencing.



From this angle, you can see the fence between Simon's house (Varela Street) and 1109 Virginia which precludes seeing the structure from the right side of 1109.



This is just another street view and the fence between the houses can be seen better as well.



This is the same picture as above. The existing rear vegetation (trees) as well as the Gumbo Limbo also make it such that a view of the new structure is obstructed.



This is pretty much the only way the new structure could be seen from the road., i.e. down this entrance way. I've put an arrow here to indicate where the corner of the structure could be seen.

It would be behind the table umbrella in the picture. The yard is DEEP!



Enid, this is the best “overall” view of the existing lattice I have. That brown tarp-like stuff a tenant put up to not have to view what’s behind it. The top of the lattice isn’t that attractive to look at. It was used, I understand, a long time ago to raise/grow orchids. There is no roof on the lattice. It is only held together on top by the right and rear 2x4s and 3 other 2x4’s running front to back. It’s not a very strong structure, but while Annalise shows it being removed. I am leaning towards keeping it, because if the 3 top 2x4s were replaced, it could be a nice structure on which to encourage attractive plant growth.



This is almost the same picture as above. Due to the angle of the picture, the red I have put in doesn't show (as it would from a top view) the footprint of the cabana/pool house, but I put the red there to show where it will be. It will lie just forward of the lattice structure, and just at the end of the pool deck. Actually, it will encroach a little onto the pool deck. Best I can tell at this point from the drawings, is that the pool deck at that point will be shortened by about 1 foot. The rear of the new structure and the sides (from end of roof overhang (not actual sides) will be within the required setbacks, so no variances are needed. Just FYI, while this picture was taken this November, so really recent, this shows old deck boards that were on the deck, many of which were ruined and had to be replaced when the avocado was taken down, fell upon and broke them. Good thing however, as the tree was SO full of termites, it was about to fall on the house or a neighbors house!

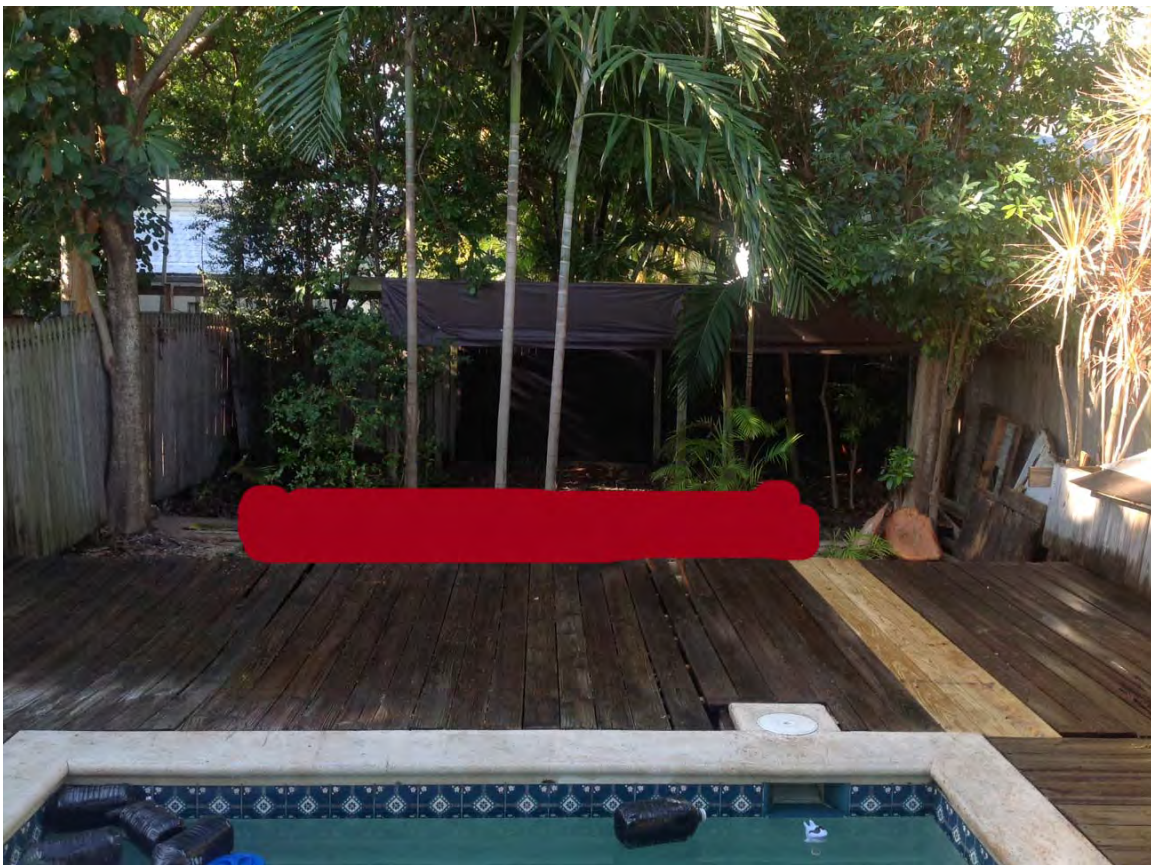

This picture was taken about 2 years ago, but it has not changed since. It gives a really good sense of the lattice structure. You can see on the bottom it is also held together by 2x6's attached to each post. The new structure will be just forward of this and go a few feet forward of the Alexander palm you see on the extreme left side of this picture. While I have a permit to take down those palms. They are really nice and I'm going to transplant them to the left and right side of the property, both because that would look very nice, but also it provides further blind of the new structure.

Also, Annalise in the drawings shows deck all the way to the rear. I may not do that if I keep the lattice, rather, making it a yard and a step down. At the moment I'm staying with Annalise's plans, but may ask building department later what it would take (application or other) to not build the rear deck portion. Anyway, this shows you the best view of what the lattice structure looks like.



This is a picture that shows what you would see if you were sitting in the new structure looking toward the back of the house and Virginia street. It is taken right from where the new structure would start. You can see how the vegetation on the left side between Simon's house and mine, and the fence, totally preclude anyone from seeing the new structure from the street. And also you can easily imagine how for the same reasons and the visibility from the street on the right side of this picture is also really restricted.

Also, it is a VERY deep back yard, and that helps too. The yard/lot runs 3 houses down Varela street. It's wonderfully, that deep.



Front of Lot

House 18 feet tall

Adjacent Structures and building heights:





Virginia Street

Exiting
House on
lot of
proposed
pool
house

1-1/2
story
looking
down on
proposed
pool
house
20 feet
tall

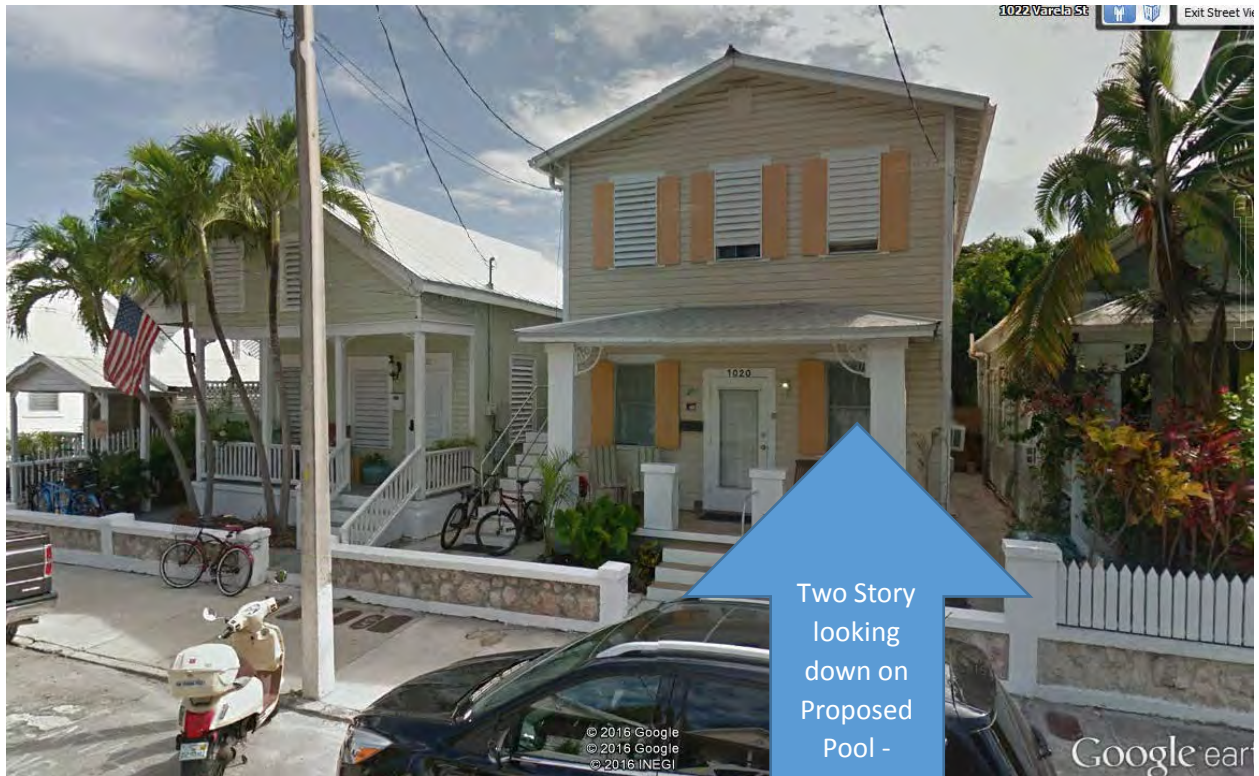

Virginia Street - The rear of this house looks down on proposed structure.

Two Story
looking
down on
Proposed
Pool -
House

26
feet
tall

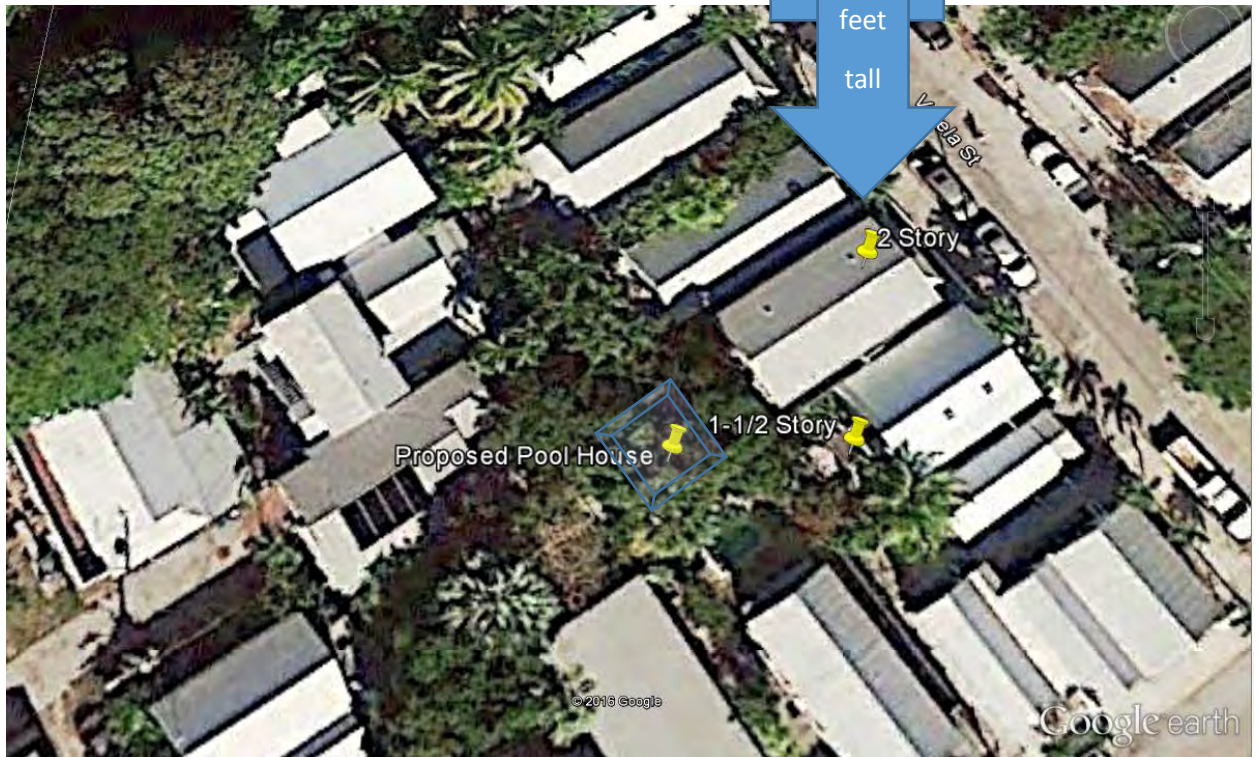



House
looks
down on
proposed
Pool
House
24 feet



PROPOSED DESIGN

MAP OF BOUNDARY SURVEY

BEARING BASE
ALL BEARINGS ARE BASED
ON NAD 83 (1983) ASSUMED
ALONG THE CENTERLINE OF
VIRGINIA STREET.

ALL ANGLES DEPICTED
ARE 90 DEGREES UNLESS
OTHERWISE INDICATED

ALL UNITS ARE SHOWN IN
U.S. SURVEY FEET

ADDRESS:
1109 VIRGINIA STREET
KEY WEST, FL 33040

COMMUNITY NO.: 120160
MAP NO.: 12087C-151 GK
MAP DATE: 05-16-2014
FLOOD ZONE: X

LEGEND

- - WATER METER
- - SANITARY SEWER CLEAN OUT
- - MAILBOX
- - WOOD POWER POLE
- - CONCRETE POWER POLE



LOCATION MAP - NTS
SEC. 05-T685-R25E

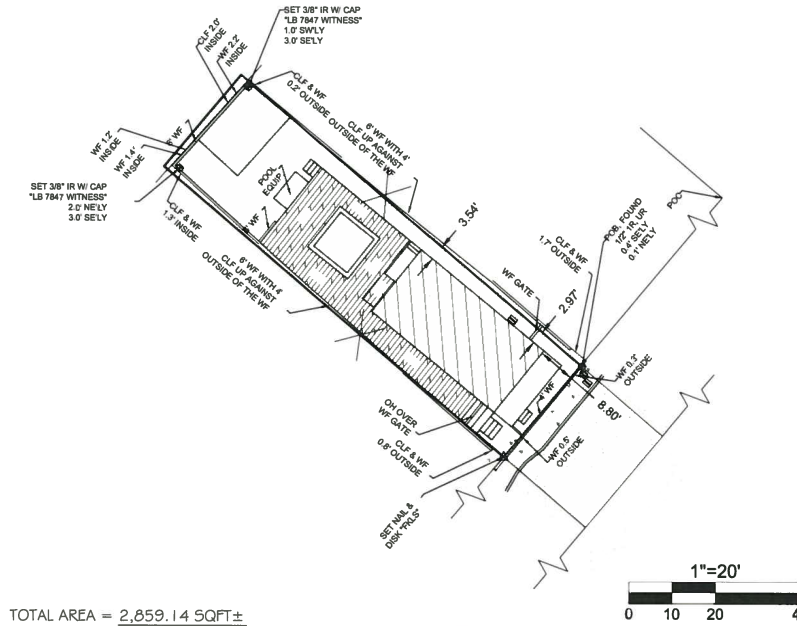

TOTAL AREA = 2,859.14 SQFT ±

THE SURVEY MAP (SHEET 1 OF 2) IS NOT COMPLETE AND VALID WITHOUT THE ATTACHED SURVEY REPORT (SHEET 2 OF 2)

CERTIFIED TO -

Robert E. Schnull;
First State Bank of the Florida Keys;
Smith | Oropeza P.L.;
Chicago Title Insurance Company

NOTE: LEGAL DESCRIPTIONS HAVE BEEN FURNISHED BY THE CLIENT OR HIS/HER REPRESENTATIVE. PUBLIC RECORDS HAVE NOT BEEN RESEARCHED BY THE SURVEYOR TO DETERMINE THE ACCURACY OF THESE DESCRIPTIONS NOR HAVE ADDITIONAL PROPERTIES BEEN RESEARCHED TO DETERMINE OVERLAPS OR HAZARDS. ADDITIONS OR OMISSIONS TO SURVEY MAP OR REPORT BY OTHER THAN THE SIGNING PARTY IS PROHIBITED WITHOUT WRITTEN CONSENT OF THE SIGNING PARTY. THE BOLD LINE SHOWN HEREON REPRESENTS THE SURVEYOR'S OPINION OF THE DEED LINES. THE MEAN HIGH WATER LINE WAS NOT DETERMINED FOR THIS SURVEY. THE APPARENT MEAN HIGH WATER LINE IS SHOWN FOR REFERENCE ONLY.

SCALE: 1"=20'
FIELD WORK DATE: 04/22/2014
REVISION: XX/XX/XXXX
SHEET 1 OF 2
DRAWN BY: MPB
CHECKED BY: MPB
INVOICE NO.: -----

HEREBY CERTIFY THAT THIS SURVEY WAS MADE UNDER MY RESPONSIBLE CHARGE AND MEETS THE MINIMUM TECHNICAL STANDARDS AS SET FORTH BY THE FLORIDA BOARD OF PROFESSIONAL SURVEYORS AND MAPPERS IN CHAPTER 55-17.05, FLORIDA ADMINISTRATIVE CODE, PURSUANT TO SECTION 472.027, FLORIDA STATUTES AND COMPLIES WITH CHAPTER 177, PART II, FLORIDA STATUTES.

NOT VALID WITHOUT THE SIGNATURE AND THE RAISED SEAL OF A FLORIDA SURVEYOR AND MAPPER

ERIC A. ISAACS, PSM #6783, PROFESSIONAL SURVEYOR AND MAPPER, LSW 7047



**FLORIDA KEYS
LAND SURVEYING**
19960 OVERSEAS HIGHWAY
SUGARLOAF KEY, FL 33042
PHONE: (305) 394-3690
FAX: (305) 509-7373
EMAIL: FKL5mail@Gmail.com

REPORT OF BOUNDARY SURVEY

LOCATION MAP - NTS
SEC. 05-T685-R25E

LEGAL DESCRIPTION -

On the island of Key West and known on William A. Whitehead's map delineated in February A.D. 1829 as part of Tract Thirteen (13), but now better known as part of Lot Twenty-one (21) in Square One (1) in said Tract Thirteen (13), according to a division of One-third (1/3) of said Tract Thirteen (13) drawn by W.A. Gwynn, County Surveyor, and duly recorded in Book "D" of Deeds, on Page 195, of Monroe County Florida, Records, Commencing at a point Fifty-five (55) feet, Four (4) inches from the corner of Virginia and Varela Streets, and running thence along said Virginia Street in a Southwesterly direction Twenty Seven (27) feet and Eight (8) inches; thence at right angles in a Northwesterly direction One Hundred and Three (103) feet and Four (4) inches; thence at right angles in a Northeasterly direction Twenty Seven (27) feet and Eight (8) inches; thence at right angles in a Southeasterly direction One Hundred and Three (103) feet and Four (4) inches out to the place of beginning.

THE SURVEY REPORT (SHEET 2 OF 2) IS NOT COMPLETE AND VALID WITHOUT THE ATTACHED SURVEY MAP (SHEET 1 OF 2)

CERTIFIED TO -

Robert E. Schnull;
First State Bank of the Florida Keys;
Smith | Oropeza P.L.;
Chicago Title Insurance Company

NOTE: LEGAL DESCRIPTIONS HAVE BEEN FURNISHED BY THE CLIENT OR HIS/HER REPRESENTATIVE. PUBLIC RECORDS HAVE NOT BEEN RESEARCHED BY THE SURVEYOR TO DETERMINE THE ACCURACY OF THESE DESCRIPTIONS NOR HAVE ADDITIONAL PROPERTIES BEEN RESEARCHED TO DETERMINE OVERLAPS OR HAZARDS. ADDITIONS OR OMISSIONS TO SURVEY MAP OR REPORT BY OTHER THAN THE SIGNING PARTY IS PROHIBITED WITHOUT WRITTEN CONSENT OF THE SIGNING PARTY. THE BOLD LINE SHOWN HEREON REPRESENTS THE SURVEYOR'S OPINION OF THE DEED LINES. THE MEAN HIGH WATER LINE WAS NOT DETERMINED FOR THIS SURVEY. THE APPARENT MEAN HIGH WATER LINE IS SHOWN FOR REFERENCE ONLY.

SCALE: 1"=20'
FIELD WORK DATE: 04/22/2014
REVISION: XX/XX/XXXX
SHEET 2 OF 2
DRAWN BY: MPB
CHECKED BY: MPB
INVOICE NO.: -----

HEREBY CERTIFY THAT THIS SURVEY WAS MADE UNDER MY RESPONSIBLE CHARGE AND MEETS THE MINIMUM TECHNICAL STANDARDS AS SET FORTH BY THE FLORIDA BOARD OF PROFESSIONAL SURVEYORS AND MAPPERS IN CHAPTER 55-17.05, FLORIDA ADMINISTRATIVE CODE, PURSUANT TO SECTION 472.027, FLORIDA STATUTES AND COMPLIES WITH CHAPTER 177, PART II, FLORIDA STATUTES.

NOT VALID WITHOUT THE SIGNATURE AND THE RAISED SEAL OF A FLORIDA SURVEYOR AND MAPPER

ERIC A. ISAACS, PSM #6783, PROFESSIONAL SURVEYOR AND MAPPER, LSW 7047



**FLORIDA KEYS
LAND SURVEYING**
19960 OVERSEAS HIGHWAY
SUGARLOAF KEY, FL 33042
PHONE: (305) 394-3690
FAX: (305) 509-7373
EMAIL: FKL5mail@Gmail.com

PROJECT INFORMATION:

Project Scope of Work: Add a 270.88 SF wood framed pool house, 330.34 SF deck 26" above grade and relocate pool equipment. Pool house includes shower, toilet and lavatory, and bar sink and electric.

Design: 2010 Florida Building Code and ASCE 7-10 and ASCE 24-05
Designed for Exposure C, 180 miles per hour, Structural Category II

Historic medium density residential district (HMDR)

Maximum density: 16 dwelling units per acre	Proposed 1
Maximum height: 30 FT	Proposed 17.4FT
Minimum lot size: 4,000 SF	Existing 2859.14 SF
Lot dimensions:	27'-8" x 103'-4"
Maximum building coverage: 40%	Existing 29.04%
Proposed 38.5%	
Maximum bldg. coverage: 1143.65 SF	Existing 830.46 SF
Proposed 1101 SF	
Maximum impervious surface ratio: 60%	Existing 30.39%
Proposed 39.88%	
Maximum imperv. surface ratio: 1715.48 SF	Existing 869 SF
Proposed 1140.34 SF	
Minimum lot size: 4,000 SF	Existing 2859.14SF
Minimum setbacks	Exist. Proposed
Front: 10 FT	3.08 FT 3.08 FT
East side: 5 FT	2.97 FT 2.97 FT
West side: 5 FT	5 FT 5 FT
Rear: 15 FT	54.5 FT 15 FT

Stormwater Calculations

270.88 SF x 0.083 FT = 22.56 CF

5'-0" swale x 0'-10" deep with 4:12 slope = 2.07 CF/LF

14'-0" x 2.07 CF/LF = 28.99 CF

**ANNALISE MANNIX, P.E.,
M.S., M. ASCE**

**ANNALISE MANNIX
ENGINEERING
AND CONSULTING, LLC**
3739 Paula Avenue
Key West, Florida 33040

Tel: 305-797-0463
Email: amannix@aol.com
FLORIDA REG. P.E. #57533
CA #27779

Submissions:

Revisions:

**POOL HOUSE
1109 VIRGINIA STREET
RE #: 00032660-000000
Key West 33040**

Title:

**SITE MAP,
SURVEY &
NOTES**

Sheet Number:

C1

Date: 22 SEPTEMBER 2014



1 COPY OF SURVEY
SCALE: NTS

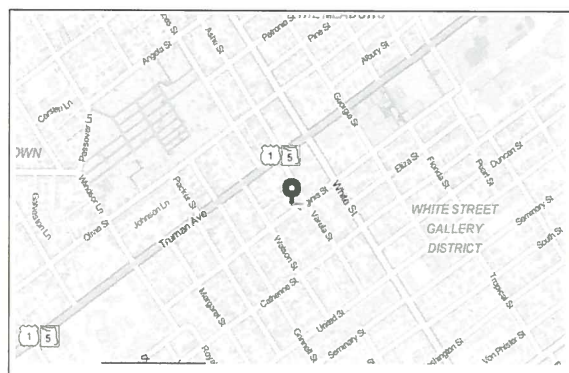

2 LOCATION MAP
SCALE: NTS

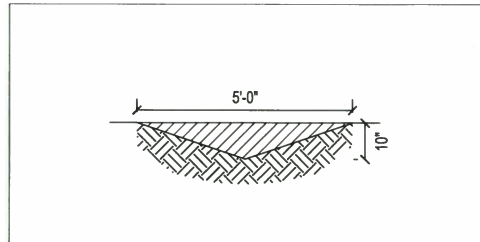

3 SWALE SECTION
SCALE: 1/2" = 1'-0"

ANNALISE MANNIX, P.E.,
M.S., M. ASCE

ANNALISE MANNIX
ENGINEERING
AND CONSULTING, LLC
3739 Paula Avenue
Key West, Florida 33040

Tel: 305-797-0463
Email: amannix@aol.com
FLORIDA REG. P.E. #57533
CA #27779

Submissions:

Revisions:

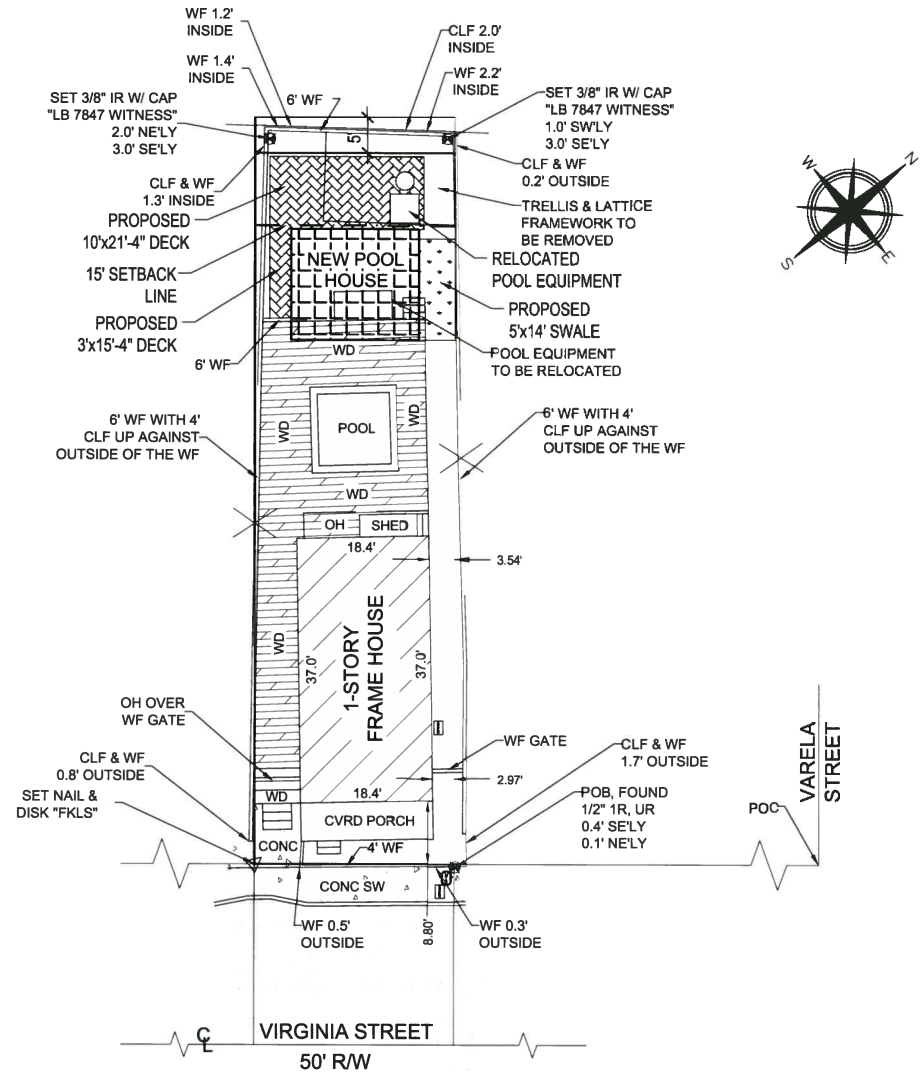

1 SITE PLAN
SCALE: 1" = 1'-0"

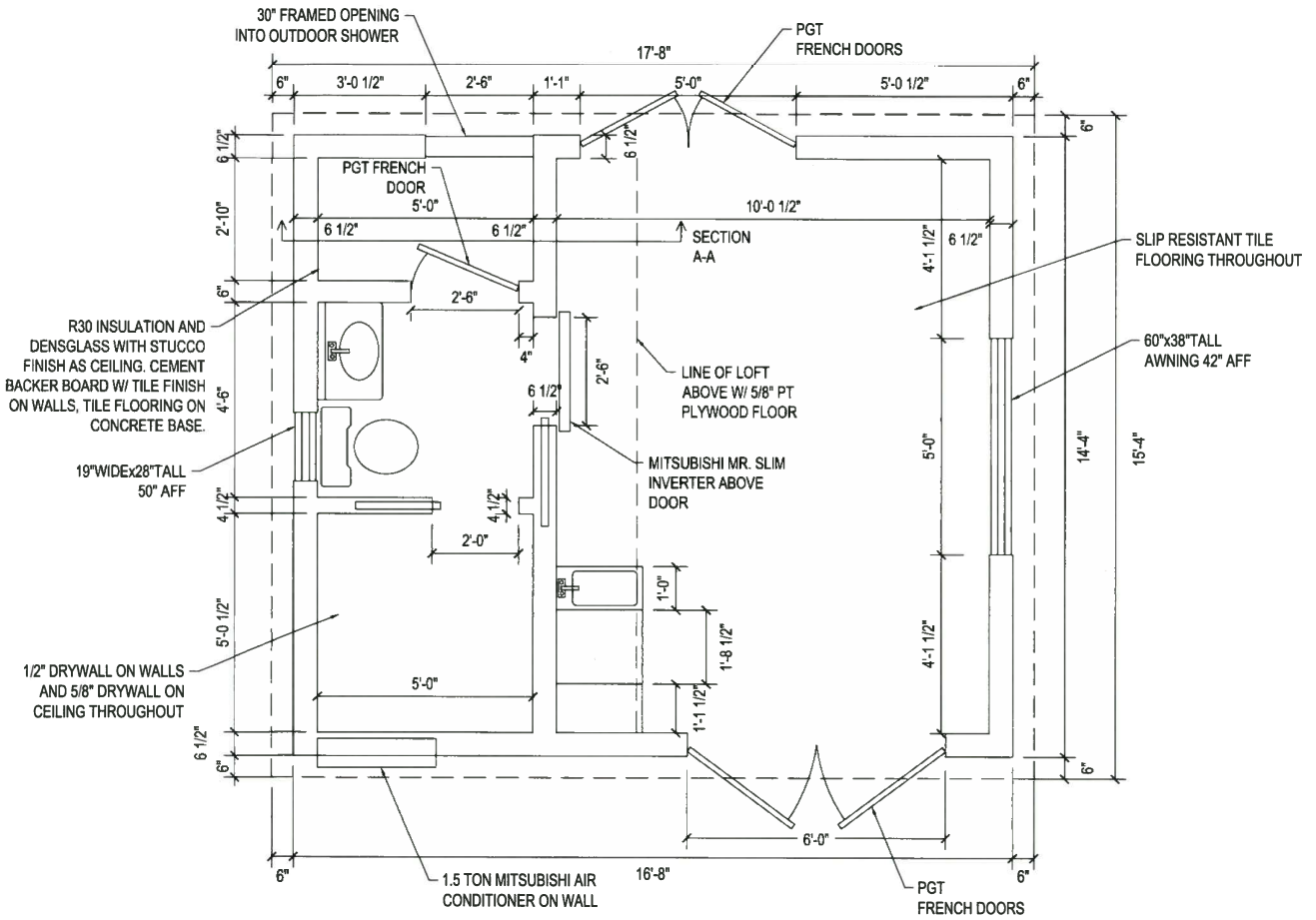

2 FLOOR PLAN
SCALE: 1/2" = 1'-0"

POOL HOUSE
1109 VIRGINIA STREET
RE #: 00032660-000000
Key West 33040

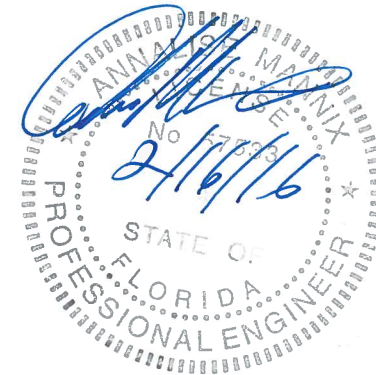

Title:
**SITE PLAN
&
FLOOR PLAN**

Sheet Number:
C2
Date: 22 SEPTEMBER 2014

ANNALISE MANNIX, P.E.,
M.S., M. ASCE

ANNALISE MANNIX
ENGINEERING
AND CONSULTING, LLC
3739 Paula Avenue
Key West, Florida 33040
Tel: 305-797-0463
Email: amannix@aol.com
FLORIDA REG. P.E. #57533
CA #27779



Submissions: _____
Revisions: _____

POOL HOUSE
1109 VIRGINIA STREET
RE #: 00032660-000000
Key West 33040

Title:
ELEVATIONS

Sheet Number:
C3
Date: 22 SEPTEMBER 2014

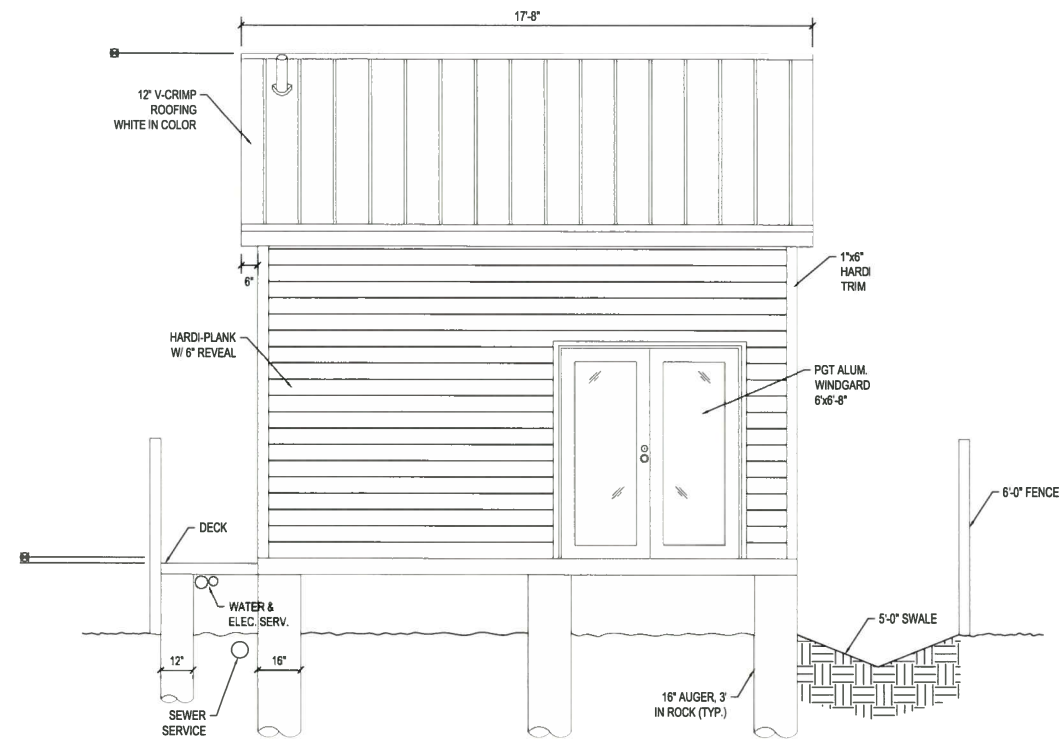

1 SOUTH ELEVATION
SCALE: 3/8" = 1'-0"

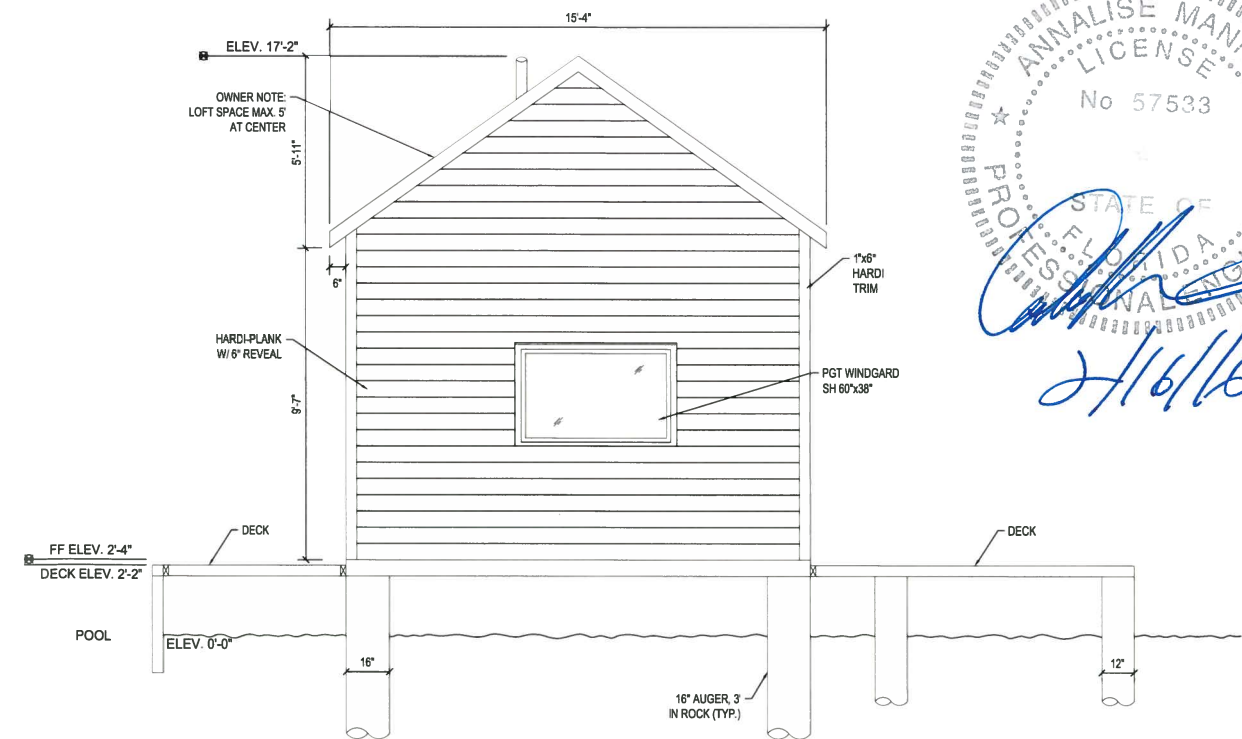

3 EAST ELEVATION
SCALE: 3/8" = 1'-0"

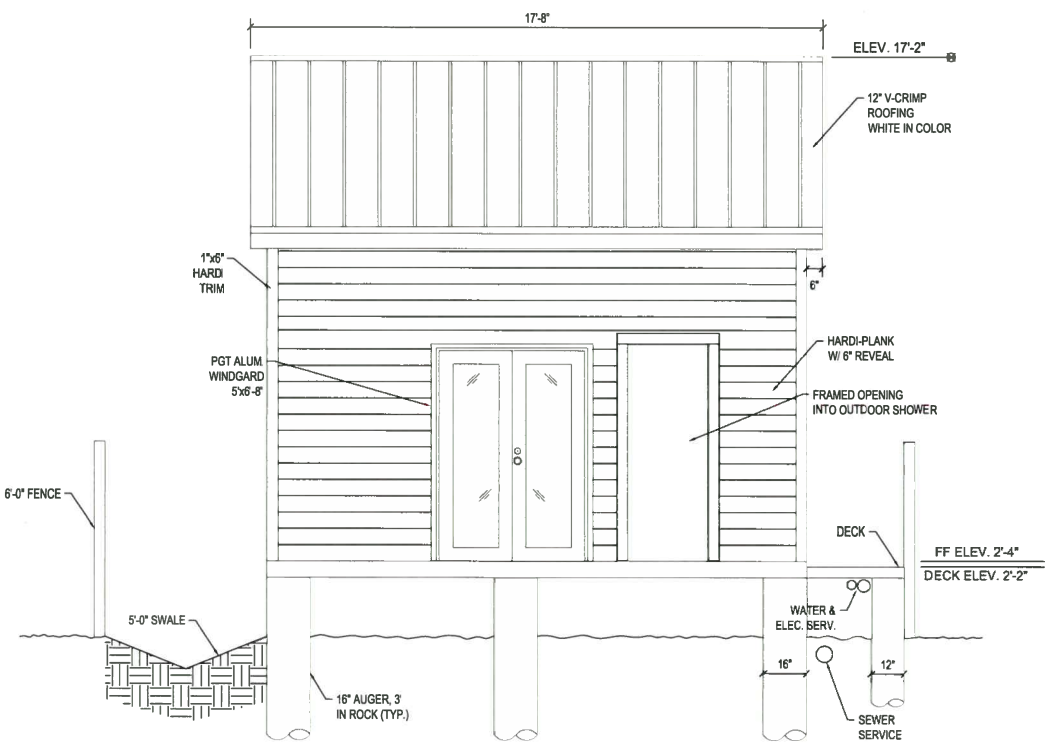

2 NORTH ELEVATION
SCALE: 3/8" = 1'-0"

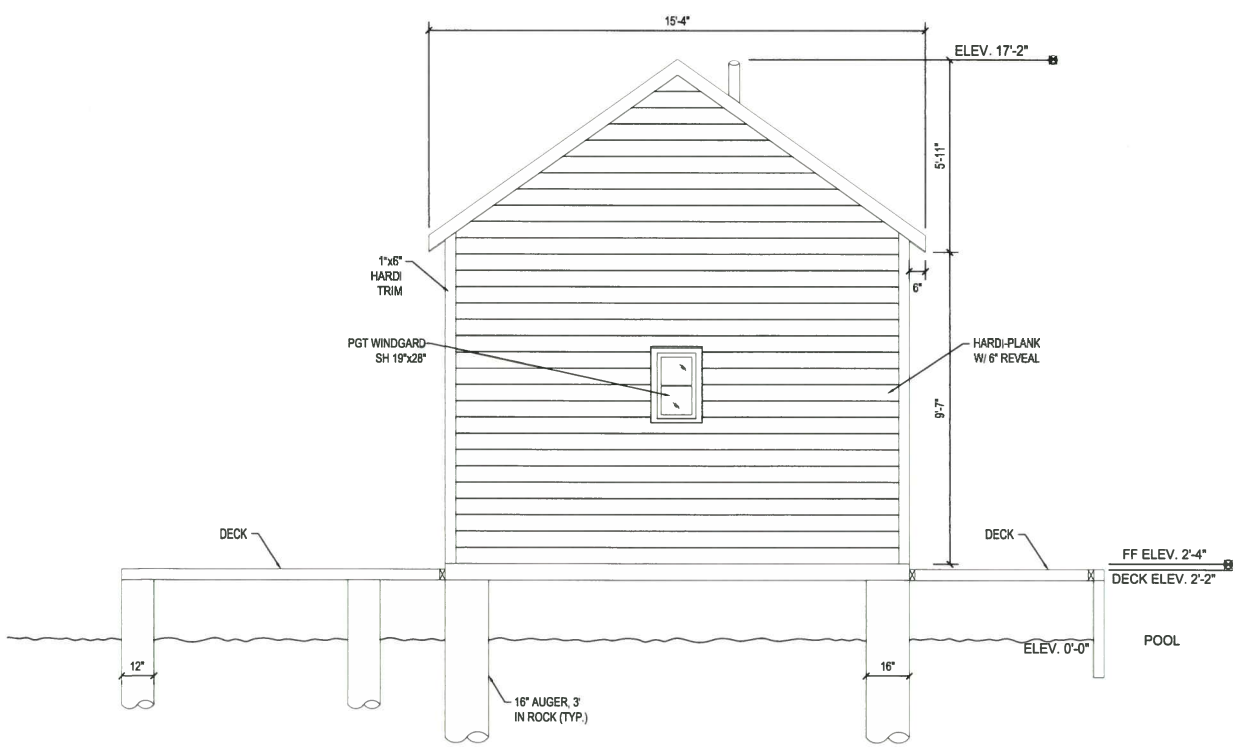

4 WEST ELEVATION
SCALE: 3/8" = 1'-0"

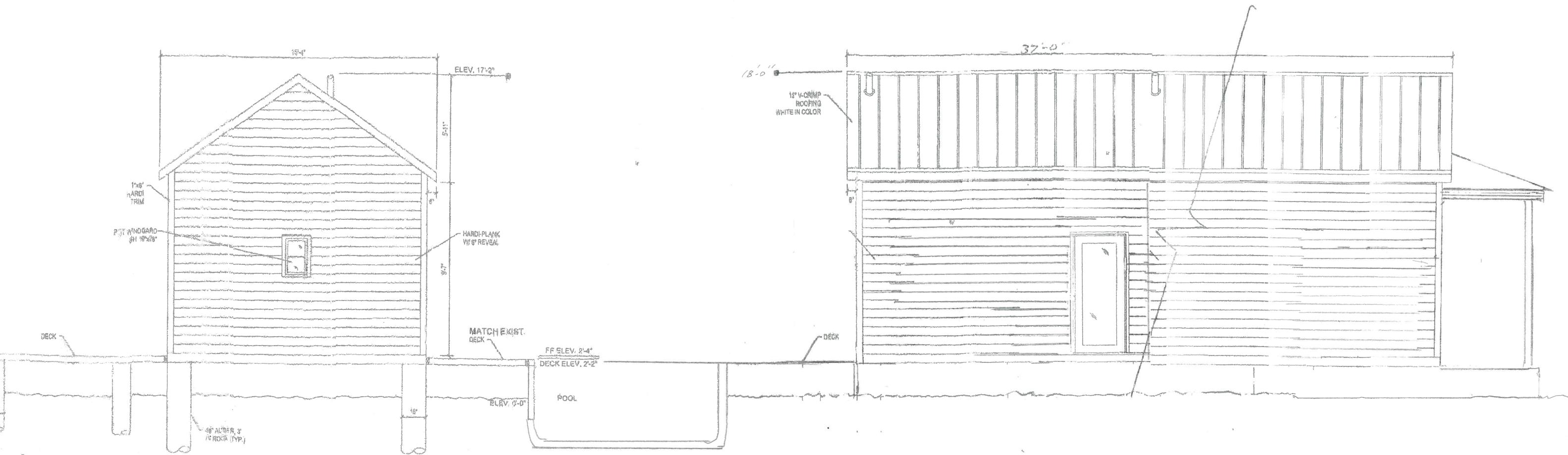

WEST ELEVATION



Title:
ELEVATION

**ANNALISE MANNIX
ENGINEERING
AND CONSULTING, LLC**
3739 Paula Avenue
Key West, Florida 33040
CA 27779
Tel: 305-797-0463
Email: amannix@aol.com
FLORIDA REG. P.E. #57533

**POOL HOUSE
1109 VIRGINIA STREET
RE #: 00032660-000000
Key West 33040**

Seal:

Revisions:
01-15-16 REVISIONS

NOTICING

Public Meeting Notice

The Historic Architectural Review Commission will hold a public hearing at 5:30 p.m., March 22, 2016 at Old City Hall, 510 Greene Street, Key West, Florida. The purpose of the hearing will be to consider a request for:

NEW POOL HOUSE AND RELOCATE POOL EQUIPMENT. DEMOLITION OF REAR ACCESSORY STRUCTURE.

FOR- #1109 VIRGINIA STREET

Applicant – Wayne Garcia

Application #H16-01-0002

If you wish to see the application or have any questions, you may visit the Planning Department during regular office hours at 3140 Flagler Avenue, call 305-809-3973 or visit our website at www.cityofkeywest-fl.gov.

THIS NOTICE CAN NOT BE REMOVED FROM THE SITE UNTIL HARC FINAL DETERMINATION

ADA ASSISTANCE: It is the policy of the City of Key West to comply with all requirements of the Americans with Disabilities Act (ADA). Please call the TTY number at 800-955-8771 or 800-955-8770 (Voice) or the ADA Coordinator at 305-809-3731 at least five business days in advance for sign language interpreters, assistive listening devices, or materials in accessible format.

PROPERTY APPRAISER INFORMATION



Scott P. Russell, CFA
Property Appraiser
Monroe County, Florida

Key West (305) 292-3420
 Marathon (305) 289-2550
 Plantation Key (305) 852-7130

Property Record Card -
Maps are now launching the new map application version.

Website tested on IE8,
 IE9, & Firefox.
 Requires Adobe Flash
 10.3 or higher

Alternate Key: 1033421 Parcel ID: 00032660-000000

Ownership Details

Mailing Address:
 SCHRULL ROBERT E
 PO BOX 691
 BRATTLEBORO, VT 05302-0691

Property Details

PC Code: 01 - SINGLE FAMILY
Millage Group: 10KW
Affordable Housing: No
Section-Township-Range: 05-68-25
Property Location: 1109 VIRGINIA ST KEY WEST
Legal Description: KW GWYNN SUB 0-195 PT LOT 21 SQR 1 TR 13 G8-291 OR778-1596/1598 OR775-1083/97 CO JUDGES
 DOC 73-309 OR779-1048/1050C OR1367-1974/76F/J-CASE 94-1422-FR-04 OR1378-1216/17 OR1449-1985/86R/S OR2627-835/36

Click Map Image to open interactive viewer



Land Details

Land Use Code	Frontage	Depth	Land Area
010D - RESIDENTIAL DRY	0	0	2,858.00 SF

Building Summary

Number of Buildings: 1
Number of Commercial Buildings: 0
Total Living Area: 720
Year Built: 1928

Building 1 Details

Building Type R1
 Effective Age 29
 Year Built 1928
 Functional Obs 0

Condition G
 Perimeter 116
 Special Arch 0
 Economic Obs 0

Quality Grade 450
 Depreciation % 34
 Grnd Floor Area 720

Inclusions: R1 includes 1 3-fixture bath and 1 kitchen.

Roof Type GABLE/HIP
 Heat 1 NONE
 Heat Src 1 NONE

Roof Cover METAL
 Heat 2 NONE
 Heat Src 2 NONE

Foundation WD CONC PADS
 Bedrooms 2

Extra Features:

2 Fix Bath 0
 3 Fix Bath 0
 4 Fix Bath 0
 5 Fix Bath 0
 6 Fix Bath 0
 7 Fix Bath 0
 Extra Fix 0

Vacuum 0
 Garbage Disposal 0
 Compactor 0
 Security 0
 Intercom 0
 Fireplaces 0
 Dishwasher 0

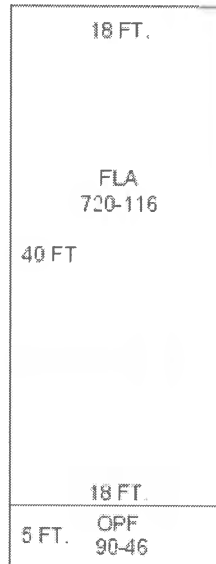

Sections:

Nbr	Type	Ext Wall	# Stories	Year Built	Attic A/C	Basement %	Finished Basement %	Area
0	OPF		1	1927				90
1	FLA	12: ABOVE AVERAGE WOOD	1	1927	N Y	0.00	0.00	720

Misc Improvement Details

Nbr	Type	# Units	Length	Width	Year Built	Roll Year	Grade	Life
1	PT3:PATIO	54 SF	0	0	1964	1965	2	50

2	WD2:WOOD DECK	950 SF	0	0	1995	1996	2	40
3	PO4:RES POOL	200 SF	20	10	1995	1996	5	50
4	FN2:FENCES	1,392 SF	232	6	1995	1996	2	30
5	FN2:FENCES	116 SF	29	4	2013	2014	2	30

Appraiser Notes

1996 TOTAL RENOVATION - ATTEMPTED TO ENTER 3 TIMES TPP 8928628 - RENTAL

Building Permits

Bldg	Number	Date Issued	Date Completed	Amount	Description	Notes
1	13-0095	01/14/2013	11/15/2013	1,600	Residential	REBUILD 4' PICKET FENCE PAINT WHITE
1	9500197	12/01/1995	10/01/1996	5,000		RENOVATIONS
1	9600287	01/01/1996	10/01/1996	600		ELECTRIC
1	9601177	03/01/1996	10/01/1996	1,750		ELECTRIC
1	9601440	04/01/1996	10/01/1996	2,950		MECHANICAL
1	9601460	04/01/1996	10/01/1996	7,000		POOL
1	9602242	05/01/1996	10/01/1996	5,500		RENOVATIONS
1	9901737	05/19/1999	08/10/1999	2,400	Residential	NEW V-CRIMP ROOF

Parcel Value History

Certified Roll Values.

[View Taxes for this Parcel.](#)

Roll Year	Total Bldg Value	Total Misc Improvement Value	Total Land Value	Total Just (Market) Value	Total Assessed Value	School Exempt Value	School Taxable Value
2015	71,029	23,778	389,397	484,204	396,650	0	484,204
2014	68,207	22,281	270,103	360,591	360,591	0	360,591
2013	82,690	22,971	314,995	420,656	359,799	0	420,656
2012	86,931	23,834	216,325	327,090	327,090	0	327,090
2011	87,991	24,768	233,302	346,061	345,321	0	346,061
2010	89,051	25,578	199,300	313,929	313,929	0	313,929
2009	100,188	26,564	255,048	381,800	381,800	0	381,800
2008	98,600	27,375	358,019	483,994	483,994	0	483,994
2007	180,704	24,214	297,232	502,150	502,150	0	502,150
2006	271,932	24,972	228,640	525,544	525,544	0	525,544
2005	203,982	25,800	242,930	472,712	472,712	0	472,712
2004	161,021	26,506	177,196	364,723	364,723	0	364,723
2003	151,549	27,388	65,734	244,671	244,671	0	244,671
2002	158,881	28,094	65,734	252,709	252,709	0	252,709
2001	134,645	28,922	65,734	229,301	229,301	0	229,301
2000	136,261	29,533	48,586	214,379	214,379	0	214,379
1999	130,593	29,128	48,586	208,307	208,307	0	208,307

1998	107,484	24,524	48,586	180,594	180,594	0	180,594
1997	124,551	22,675	42,870	190,096	190,096	0	190,096
1996	37,527	55	42,870	80,452	80,452	0	80,452
1995	35,506	0	42,870	78,376	78,376	0	78,376
1994	31,754	0	42,870	74,624	74,624	0	74,624
1993	31,754	0	42,870	74,624	74,624	0	74,624
1992	31,754	0	42,870	74,624	74,624	0	74,624
1991	31,754	0	42,870	74,624	74,624	0	74,624
1990	24,509	0	29,295	53,804	53,804	0	53,804
1989	15,996	0	28,580	44,576	44,576	0	44,576
1988	13,996	0	22,864	36,860	36,860	0	36,860
1987	13,820	0	15,433	29,253	29,253	0	29,253
1986	13,897	0	15,433	29,330	29,330	0	29,330
1985	13,473	0	10,382	23,855	23,855	0	23,855
1984	12,596	0	10,382	22,978	22,978	0	22,978
1983	12,596	0	10,382	22,978	22,978	0	22,978
1982	12,840	0	8,969	21,809	21,809	0	21,809

Parcel Sales History

NOTE: Sales do not generally show up in our computer system until about two to three months after the date of sale. If a recent sale does not show up in this list, please allow more time for the sale record to be processed. Thank you for your patience and understanding.

Sale Date	Official Records Book/Page	Price	Instrument	Qualification
5/1/2013	2627 / 835	394,800	WD	Q2
3/1/1997	1449 / 1985	215,000	WD	Q
11/1/1995	1378 / 1216	110,000	WD	Q
9/1/1978	779 / 1048	20,000	00	Q

This page has been visited 145,375 times.

Monroe County Property Appraiser
 Scott P. Russell, CFA
 P.O. Box 1176 Key West, FL 33041-1176