

FINAL

BLOWER ALTERNATIVES EVALUATION MEMO

Richard A. Heyman Environmental
Protection Facility

B&V PROJECT NO. 199322

PREPARED FOR



City of Key West

14 NOVEMBER 2018



Table of Contents

1.0	Overview.....	1
1.1	Background.....	1
1.2	Evaluation Objectives and Approach.....	1
	Scope of Work.....	1
2.0	Evaluation of Existing Data.....	1
2.1	Background Data.....	1
2.2	Flows, Loads, and power demand.....	2
	Existing Influent Loading.....	2
	Existing Air Flows.....	4
	Existing Power Demand.....	6
3.0	Alternatives.....	7
3.1	Air Control System.....	7
	Most Open Valve Control Strategy.....	7
	Ammonium versus NO _x (AvN) Control.....	8
3.2	Compressed Air System.....	8
	Alternatives 1 and 2 – Multistage Centrifugal.....	9
	Alternative 3 – Integrally Geared Turbo with Inlet Guided Vanes.....	10
	Alternative 4 – Integrally Geared Turbo with AFD.....	11
	Alternative 5 – Dry-Screw with AFD.....	12
3.3	Life Cycle Analysis.....	13
	Air Flow and Pressure.....	13
	Manufacturer’s Selections.....	13
	Probabilistic Cost Evaluation.....	13
	Results.....	20
4.0	Conclusions and Recommendations.....	22
4.1	Recommendations.....	22

APPENDICIES

- A. Manufacturer Selections
- B. Statistical Evaluation Input Parameters

LIST OF TABLES

Table 2-1: Annual Average Influent loading comparison 2

Table 2-2: Maximum Month Influent loading comparison..... 2

Table 2-3: Average Monthly Air Flows (From Daily Logs)..... 4

Table 3-1: Summary of Selections for Blower Evaluation..... 13

Table 3-2: Evaluation Input Parameters..... 14

Table 3-3: Alternative Numbering in Analysis Plots..... 16

Table 3-4: Evaluation Summary 21

LIST OF FIGURES

Figure 2-1: Influent Pollutant (CBOD5 and TSS) Loading and Influent Flow to Plant..... 3

Figure 2-2: Influent CBOD5 Loading..... 3

Figure 2-3: Influent Total Suspended Solids Loading 4

Figure 2-4: Distribution of Air Flow from Daily Logs, CY 2013-2018 5

Figure 2-5: Cumulative Distribution of Air Flow from Daily Logs, CY 2013-2018..... 5

Figure 2-6: Distribution of Percentage Open of Blower Inlet Valve from Daily Logs, CY 2013-2018 6

Figure 2-7: Historical Power Demands of Existing Blowers from Daily Logs, CY 2013-2018..... 7

Figure 3-1: Multistage blower 10

Figure 3-2: Single stage blower without enclosure..... 11

Figure 3-3: Single stage blower with AFD 12

Figure 3-4: Single stage blower with AFD 12

Figure 3-5: Capital Expenditures for the Evaluated Alternatives..... 17

Figure 3-6: Annual Value of Operational Expenditures for the Evaluated Alternatives 18

Figure 3-7: 20-year Present Worth of Total Cost of Ownership for the TOTEX..... 19

1.0 Overview

1.1 BACKGROUND

Black & Veatch (B&V) has been requested by the City of Key West (City) to perform an evaluation of various blower technologies that could be implemented to potentially improve the existing aeration system at the Richard A. Heyman Environmental Protection Facility (RAHEPF). The existing aeration system comprises of two multistage centrifugal blowers with associated mechanical piping, electrical and instrumentation and controls components. The City desires to increase redundancy at the facility with the addition of a new blower. The existing layout was designed with space and piping connections for the addition of a third blower unit in the future.

1.2 EVALUATION OBJECTIVES AND APPROACH

The primary objective of this evaluation is to select a blower technology that provides the most economical solution for the City, accounting for both capital and operational costs. The evaluation also includes a review of the existing process control and provides recommendations targeted to continue to comply with the required treated effluent limits, while incorporating energy savings. It is anticipated that energy savings can be obtained by optimizing process control and by utilizing newer, more efficient blower technology.

Scope of Work

Principal elements of the evaluation include the following:

- Evaluation of Existing Data from the City
- Air Delivery System Evaluation
- Blower Evaluation

2.0 Evaluation of Existing Data

This section discusses the existing blower performance at different loading conditions, aeration system process performance information and blower power demands to evaluate the existing process at the RAHEPF.

2.1 BACKGROUND DATA

The existing data was obtained from the following sources:

- Ref. 1 – Historical Aeration Daily Log data provided by the City for the RAHEPF
 - August and November 2016
 - April and October 2017
 - January and June 2018
- Ref. 2 – RAHEPF Raw Influent Characteristics provided by the City, for Calendar Years (CY) 2013-2018.
- Ref. 3 – *Replacement of Existing Surface Aerators with Diffused Aeration System*, Preliminary Design Report, CDM. February 2008.

2.2 FLOWS, LOADS, AND POWER DEMAND

Existing Influent Loading

Data for the 2013-2018 calendar years was analyzed to determine the influent loading to the RAHEPF with respect to CBOD₅, TSS, and NH₄⁺. Table 2-1 and 2-2 show the average annual and maximum month loadings compared to historical data (January 2006 to October 2007) and design loadings used for the existing diffused aeration system from the Preliminary Design Report (PDR) developed by CDM in 2008.

Table 2-1: Annual Average Influent loading comparison

	CBOD ₅	TSS	NH ₄ ⁺
CY 2013 Annual Average Loading	7,570	6,332	n/a ²
CY 2014 Annual Average Loading	8,338	7,339	n/a ²
CY 2015 Annual Average Loading	8,035	8,150	n/a ²
CY 2016 Annual Average Loading	8,312	7,830	n/a ²
CY 2017 Annual Average Loading	7,780	7,545	1,095
CY 2018 Annual Average Loading	8,524	8,255	n/a ²
Historical Average Loadings (January 2006 to October 2007) ⁴	8,304	7,852	849
CY 2013-2018 Annual Average Loading	7,575	8,093	n/a ²
Design Average Loading ³	10,543	9,968	1,078

1. All loadings in pounds per day
 2. Only one month (August/July 2017) of TKN was collected, assuming a ratio of 0.67 NH₄⁺ to TKN
 3. Design loads come from the PDR
 4. Average day value provided in historical data included in the PDR, the annual average was not provided.

Table 2-2: Maximum Month Influent loading comparison

	CBOD ₅	TSS	NH ₄ ⁺
CY 2013 Maximum Month	7,565	10,004	n/a ²
CY 2014 Maximum Month	8,420	11,070	n/a ²
CY 2015 Maximum Month	10,444	10,350	n/a ²
CY 2016 Maximum Month	9,351	10,428	n/a ²
CY 2017 Maximum Month	9,899	10,529	n/a ²
CY 2018 Maximum Month	9,601	10,137	n/a ²
Historical Max Loadings (January 2006 to October 2007) ⁴	10,878	12,249	1,155
CY 2013-2018 Maximum Month Average	9,939	10,954	n/a ²
Design Max Month Loading ³	13,793	15,599	1,465

1. All loadings in pounds per day
2. Only one month (August/July 2017) of TKN was collected, assuming a ratio of 0.67 NH₄⁺ to TKN
3. Design loads come from the Preliminary Design Report developed in 2008 by CDM.
4. Maximum values come from Historical data included in the PDR. The average day value and maximum month peak factor are provided, the value assumes max month can be calculated by the average day loading multiplied by max month peak factor.

From Tables 2-1 and 2-2, it can be concluded that there have not been drastic increases in influent loading, with the historical averages matching up to the averages over the last 6 years. The values are not approaching the design loadings except for NH₄⁺. Figures 2-1, 2-2, and 2-3 continue to show the influent loadings maintaining steady levels throughout the last 6 years.

Figure 2-1: Influent Pollutant (CBOD5 and TSS) Loading and Influent Flow to Plant

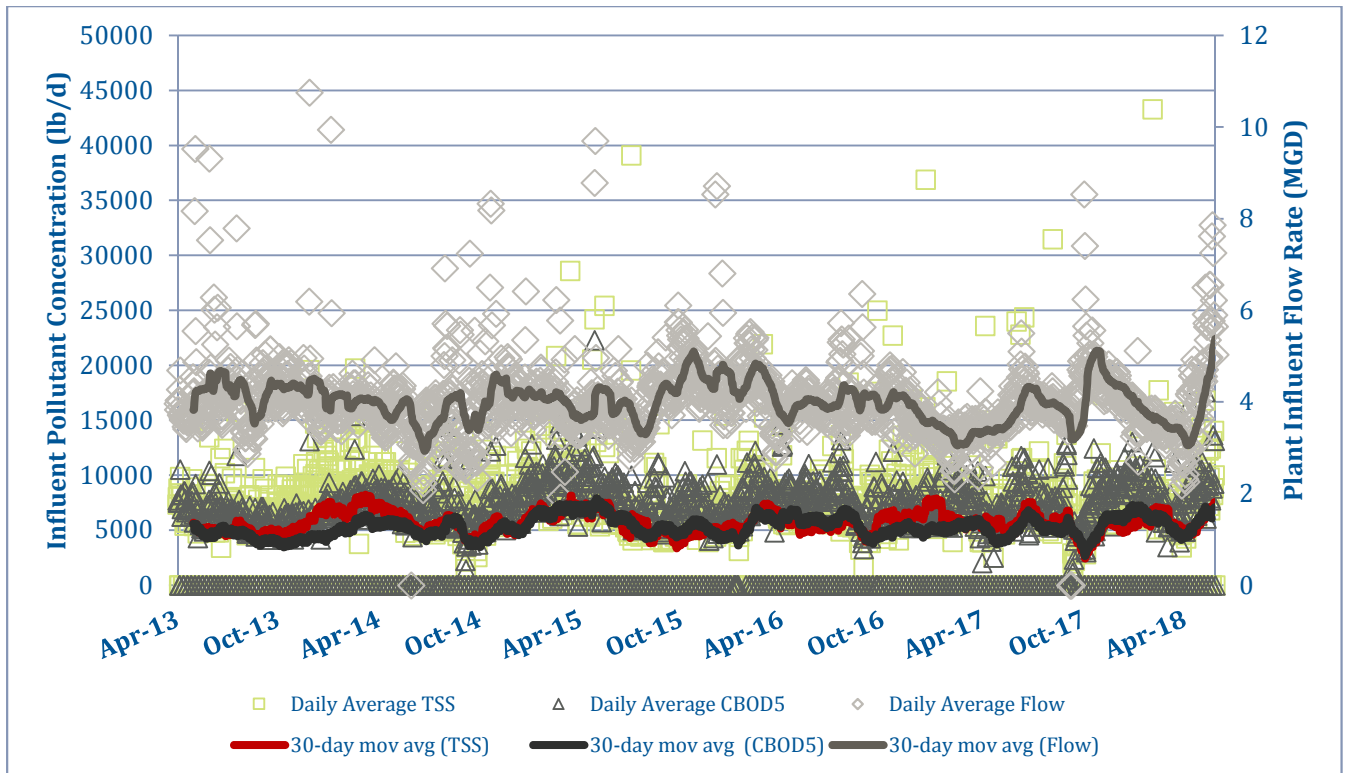

Figure 2-2: Influent CBOD₅ Loading

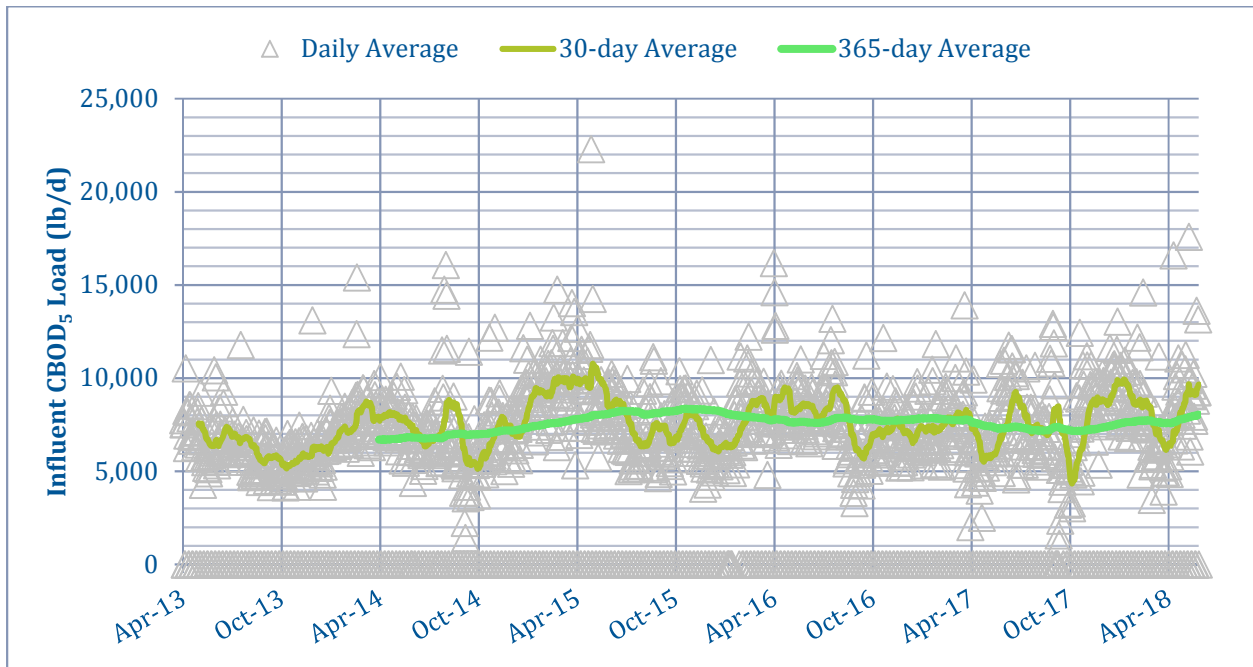
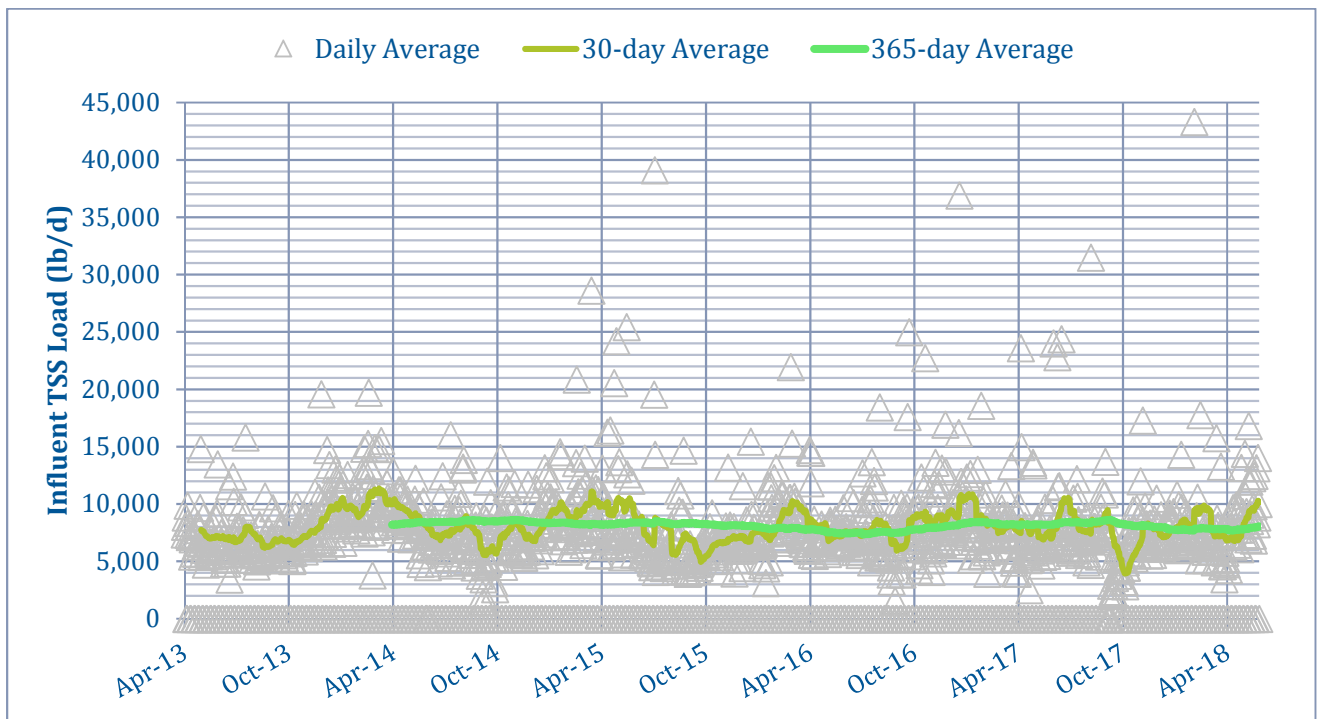

Figure 2-3: Influent Total Suspended Solids Loading



Existing Air Flows

B&V evaluated the air demand daily logs from the plant provided by the City. Although the blower Programmable Logic Control (PLC) reports instantaneous air demands, it seems that the City does not have a historian function enabled at the plant. Therefore, the extremely valuable continuous data

for airflows was not available for this study and thus B&V had to revert to the daily log information which does not show the hourly variability as detailed in the blower system PLC.

The daily log data shows the current air flow demands at the RAHEPF have been relatively steady in the recent past as can be seen in Table 2-3.

Table 2-3: Average Monthly Air Flows (From Daily Logs)

MONTH	AIR FLOW ¹
August 2016	4292
November 2016	4784
April 2017	4568
October 2017	3588
January 2018	4352
June 2018	4020

1. All flows in scfm.

In order to assess the current operations of the plant a plot of the air flows was created showing the distribution of flow data based off of daily log data taken from the facility. Air flow reading was recorded 6 times each day during the months shown in Table 2-1. This distribution can be seen in Figure 2-4 and a cumulative distribution of the data can be seen in Figure 2-5.

Figure 2-4: Distribution of Air Flow from Daily Logs, CY 2013-2018

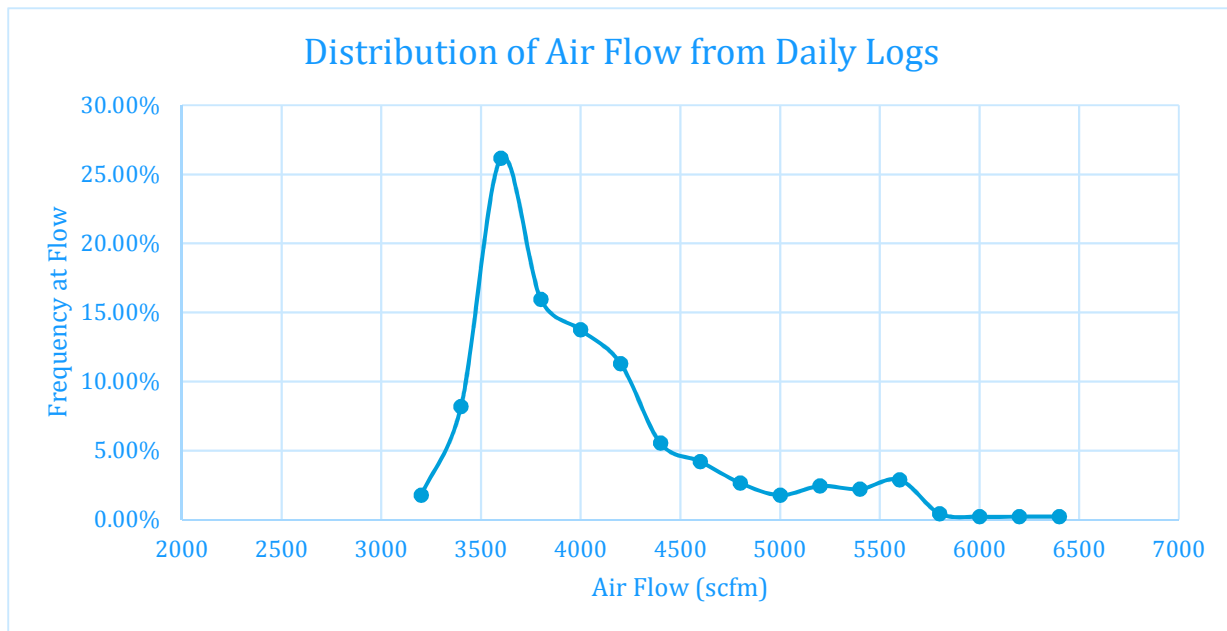
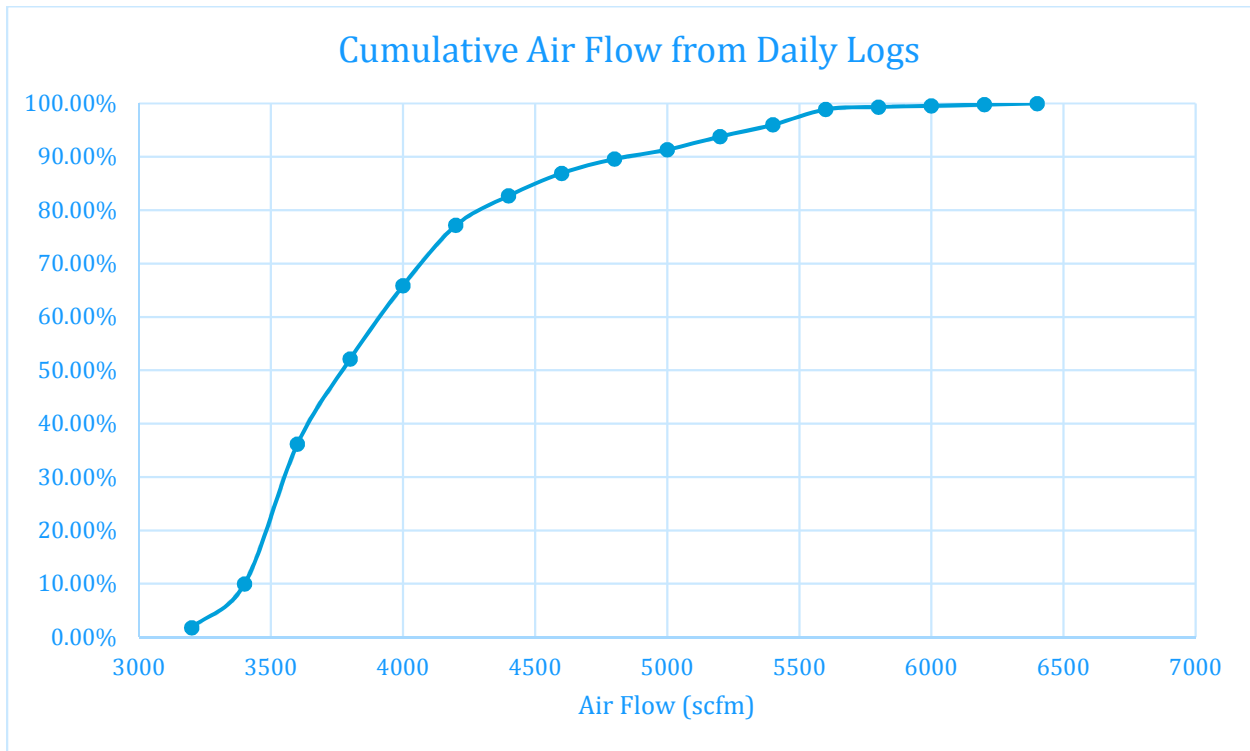

Figure 2-5: Cumulative Distribution of Air Flow from Daily Logs, CY 2013-2018



The existing blowers were sized for a rated point of 4,600 scfm at 9.13 psig to meet a combined capacity of 9,200 scfm at 9.13 psig. From the data shown and the figures above it can be concluded that there are few instances where the flow exceeds 4,500 scfm, and that practically all flows are below 6,000 scfm.

The daily log data shows that the plant frequently operates with a single blower. The diffused aeration system was designed to operate the majority of the time with one blower with the inlet valve throttled to 73%. As can be seen in Figure 2-6 the average throttling of the inlet valve to a single blower is ~40%. There are only a few instances in the daily log data that it is apparent there are two blowers in operation. In these instances, the inlet valves are throttled down to between 31% and 42%. Looking at the flows shown in the daily logs and comparing it to the designed size of the existing blowers it seems possible that some of the information in the daily logs was not recorded correctly and as part of the evaluation, it was assumed that there were two blowers in operation at the times where flows in the 5,500-6,000 scfm range were recorded.

Figure 2-6: Distribution of Percentage Open of Blower Inlet Valve from Daily Logs, CY 2013-2018

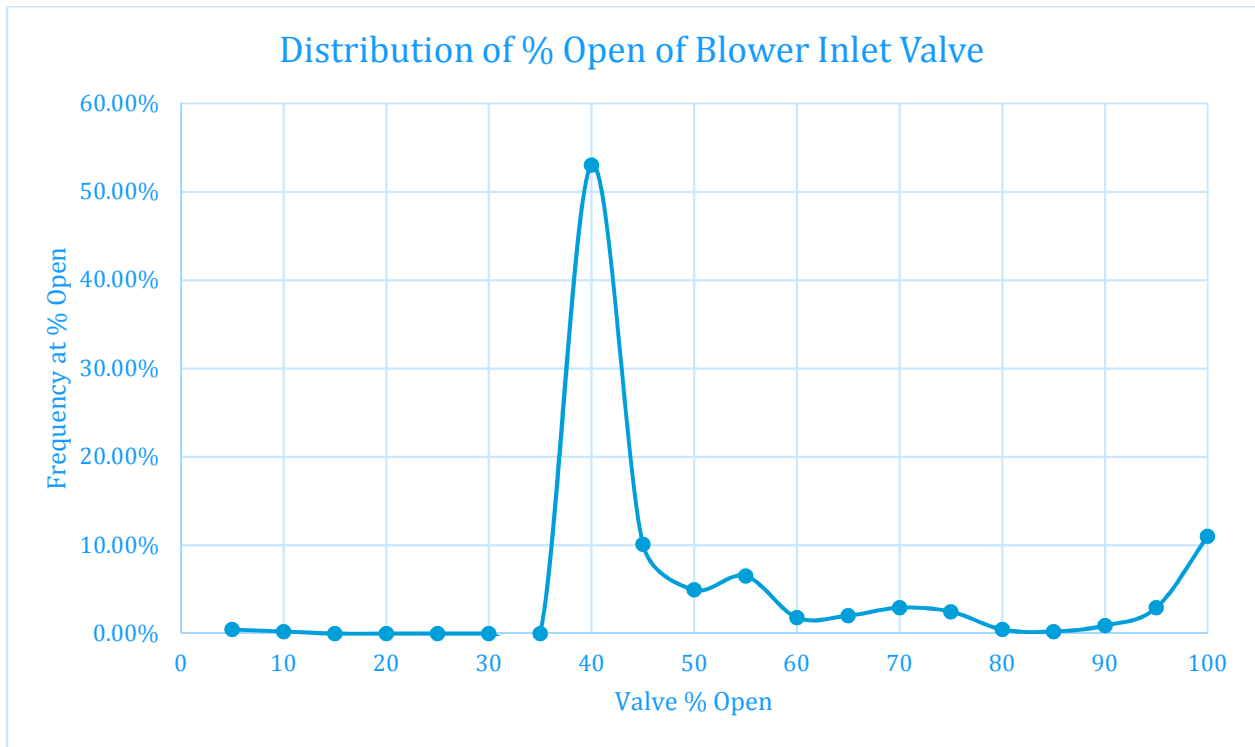

Existing Power Demand

The daily log data shows that the blower power demand fluctuates between 240-410 amps with an average of 274 as can be seen in Figure 2-7.

Figure 2-7: Historical Power Demands of Existing Blowers from Daily Logs, CY 2013-2018

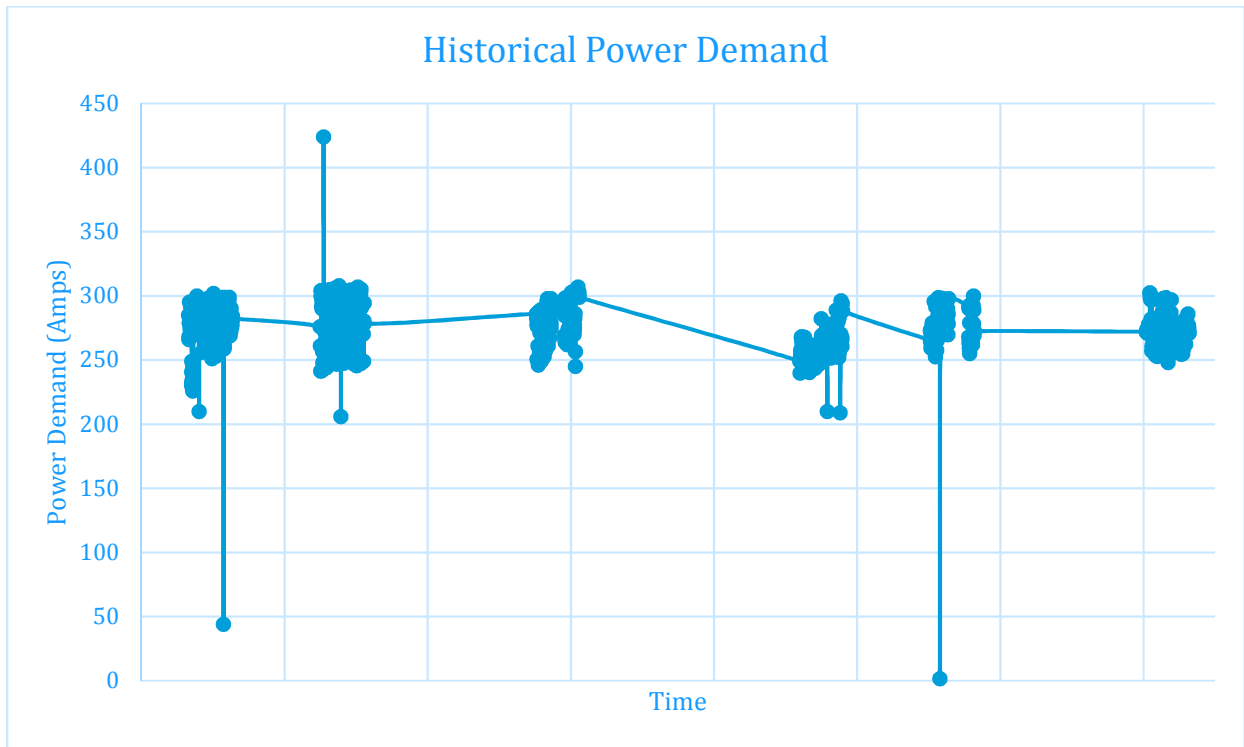

3.0 Alternatives

This section details the evaluation of air control system and blower alternatives to address the requested improvements for the existing aeration system. A workshop was held with the Utilities Director of the City of Key West and Fleming Key WWTP operations staff on June 26, 2018 to confirm understanding of the issues at the RAHEPF and expectations of the client.

3.1 AIR CONTROL SYSTEM

This section discussed the potential improvements to the plant's air control system.

Currently, the RAHEPT air control system is based on a blower discharge pressure in the discharge header coupled with Dissolved Oxygen (DO) feedback from the each of the droplegs and their associated butterfly valves. Each of the valves for each dropleg responds to the DO reading in each zone and the valve open/closes to satisfy the demand. Then the header pressure is monitored and as it goes up or down, the flow from the blowers is modulated to maintain a pressure setpoint. While this is a commonly used air control strategy, it does not optimize the pressure setpoint in the system and thus more power is needed to supply the demand.

Summarized below are two possible options for improvements to the plant air delivery.

Most Open Valve Control Strategy

In this strategy the system is configured to utilize the multi-point DO system to optimize air distribution and blower efficiency. The Most Open Valve (MOV) control system will allow the aeration system to operate at its lowest pressure while satisfying the DO requirements based on the specific

demands of each zone in each basin. The zone with the highest oxygen demand is typically the MOV zone. If the MOV goes too far closed, the blower header pressure or flow set point decrements downward. The reverse action occurs when the plant air demand is increasing.

The keys to success with DO and MOV control systems is tuning, including time delays and deadbands. This comes only from experience. In the past, many DO control systems were provided by the low bidding system integrator who frequently had no familiarity with wastewater aeration applications. Many of these systems did not work properly, valve hunting resulted, and they were disabled by their owners. B&V strongly recommends that the blower vendor have single source responsibility for the control of the entire aeration system. Some blower manufacturers have in-house staff with significant DO control experience. Others have an established relationship with an experienced controls subcontractor. B&V requires that subcontractors who are not established in the industry submit a reference list for review.

The only modifications required for this control strategy are from the programming side of things. Therefore, there is little investment required. Since there is no online data available for the evaluation of the air flows, only estimations of the potential savings can be projected. Based on rules of thumb, it is expected that an automated MOV control system will reduce system pressure by 0.5 psig which would generate energy savings of approximately 3-5% when upgrading. Another rule of thumb would indicate that reducing DO from 3 mg/l to 2 mg/l would result in a savings of 13%.

Ammonium versus NO_x (AvN) Control

AvN logic was developed to promote nitrifier oxidizing organisms (NOB) outselection and enhance simultaneous nitrification-denitrification (SND) in reactors. The control logic involves cycling the aeration on/off to nitrify NH₄⁺ and denitrify all the NO_x produced. The effluent NH₄⁺ and NO_x concentrations in the effluent will be the same (NO_x-N/NH₄⁺-N = 1). The aeration cycles are operated to a pre-established DO (typically 1.5 mg/L NH₄⁺). Initial cycle durations (aerobic and anoxic) are set with a subsequent tuning based on the NO_x/NH₄⁺ ratio, increasing or decreasing aeration time accordingly with a PID controller.

In the AvN, the NH₄⁺ removal rate will depend on denitrification potential. The aerobic SRT is adjusted such that only the fraction of NH₄⁺ oxidized is equal to what the system can reduced via denitrification.

NH₄⁺ and NO_x probes coupled programing are required for this control alternative. Estimates on potential energy savings by implementing this alternative based on other projects can range from 5-10%.

3.2 COMPRESSED AIR SYSTEM

The RAHEPF aeration system currently comprises of two multistage centrifugal blowers. However, the existing layout was designed with space and piping connections for a third blower. Daily log data showed that only one blower is required to meet the plant's needs for approximately 88% of the time. For the evaluation, it was determined that the new blower would be used as the base blower for 88% of the time and when a second unit is required, either of the existing multistage blowers will operate in parallel with the new blower. The following blower technologies were evaluated:

1. Multistage Centrifugal – Fixed Speed and Inlet Throttling (same as existing units)
2. Multistage Centrifugal – Adjustable Frequency Drive (AFD)
3. Integrally Geared Turbo – Fixed Speed and Inlet Guided Vanes
4. Integrally Geared Turbo – AFD
5. Dry-Screw – AFD

With the help of electronics and AFDs, blowers have become more and more efficient over time and different technologies have become more competitive between them in terms of operating ranges and efficiencies. For this reason, five alternatives were evaluated.

All blowers with the exception of Multistage Centrifugal, require weather proof enclosures if installed outdoors. Overall all the technologies evaluated are suitable for outdoor installations. It was assumed that AFDs will be installed in the electrical room to be protected from the weather, however, at additional costs AFDs can be installed outdoors with special standalone enclosures.

High Speed Turbo Blower technology was not taken in consideration for this evaluation as it is B&V's experience that the highly complicated electronics systems in these unit do not make them suitable for outdoor installations specially in coastal facilities.

Alternatives 1 and 2 – Multistage Centrifugal

Existing blowers are constant speed Multistage Centrifugal. Figure 3-1 depicts a multistage blower. Multistage blowers are a proven technology with a long installation history at municipal wastewater plants. They utilize a motor coupled to a series of impellers to compress the air to the final discharge pressure. They are most commonly constant speed. Discharge air flows vary inversely to the discharge pressure on centrifugal machines operating at constant speed. To vary the flow of a centrifugal machine with constant speed and fixed discharge pressure, inlet throttling is required. Over the past years, multistage blowers have been offered with Adjustable Frequency Drives or AFDs, allowing for flow variations at improved efficiency's when compared to inlet throttling. Inlet throttling provides greater turndown at expense of efficiency, and units with AFDs will suffer a penalty on how much turndown can be achieved. For this specific application, selections were obtained for blowers utilizing inlet valve throttling and AFDs for capacity control. Although AFDs provided improved efficiencies at turndown, the cost of a multistage blower of this size with an AFD can be between 30% to 40% higher. For multistage units, there are four or five manufacturers who can meet a five-year experience requirement.

Figure 3-1: Multistage blower



Alternative 3 – Integrally Geared Turbo with Inlet Guided Vanes

Integrally geared single stage blowers utilize a motor and speed increasing gearbox to operate the single stage impeller at high operating speeds. As with multistage blowers, these units are most commonly constant speed. The blowers utilize dual point control consisting of inlet guide vanes and variable diffuser vanes for pressure and flow control. In general, having two control variables (the two sets of vanes in this case) allows somewhat independent control of flow and pressure providing better turndown and nearly constant efficiency throughout the blower's turndown range.

When compared to other technologies such as multistage, the integrally geared single stage units operate at higher speeds, have more moving parts and have tighter manufacturing tolerances required for the high-speed operation. Single stage blowers have over 35 years of installation history in the U.S. municipal wastewater market and about 45 years overseas. Single stage blowers are known to be robust from an operational and reliability standpoint. They do have more ancillary mechanical components and subsystems as compared with a multistage blower. The components and subsystems include the gearbox, pressurized lubricating oil system and lube oil cooling system as well as the two sets of vanes with actuators. Maintenance is slightly higher when compared to multistage blowers due to these items and a factory service representative may be required until plant staff become familiar with maintenance requirements. See Figure 3-2 for an example of a single stage blower.

Figure 3-2: Single stage blower without enclosure



Alternative 4 – Integrally Geared Turbo with AFD

Considered an equal to the third alternative, this technology removes the inlet guided vanes and incorporates AFD. Only one manufacturer (Inovair) currently provides this technology. This approach is newer than the integrally geared blower with inlet guided vanes, but most of the technology components are not. Although the technology is available with belt drives or an increasing gearbox, the evaluation was performed for a selection with gearbox as it provides increased efficiency. Historically, the oldest outdoor installation with belt drives is around 10 years, and the oldest installation with an increasing gearbox dates to 2016.

A disadvantage to this technology is that the largest machine available can only produce 2,000 scfm at the plant's pressure requirement. Although the manufacturer offers two units stacked together to reduce its foot print, three units would be required to meet the required air flows and stacked packages are not offered with three units. See Figure 3-3 for an example of a single stage blower with AFD.

Figure 3-3: Single stage blower with AFD



Alternative 5 – Dry-Screw with AFD

A dry-screw machine is a positive displacement (PD) unit that also provides internal compression, and when combined with an AFD, can provide efficiencies competitive to other blower technologies at lower capital costs. Instead of the straight lobes used on a PD machine, it has helical fluted rotors similar to a dry-screw compressor (see Figure 3-4). There are around five manufacturers as well as several reputable packagers that can provide the technology.

Due to its PD characteristics, the main application for the technology is for systems with varying water levels. For applications with variations in air flow are required, an AFD is incorporated, as is the case with this application.

Figure 3-4: Single stage blower with AFD

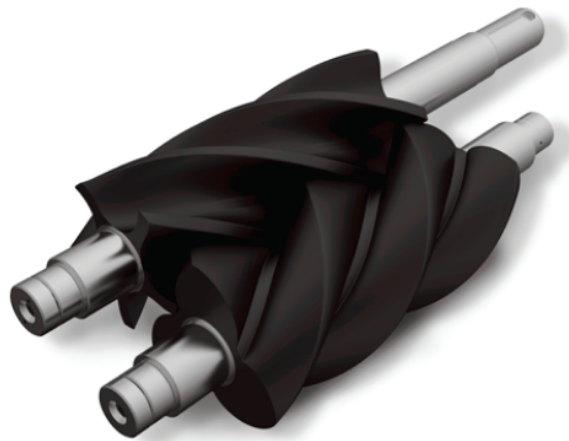

3.3 LIFE CYCLE ANALYSIS

Air Flow and Pressure

The new blower will provide capacity rated at 4,600 scfm. The new unit will provide the required flows for approximately 88% of the time. The other 12% of the time, the existing blowers will be used to complement the new blower and both units will start operating close to 50% turndown. It was assumed that existing blowers can achieve a turndown of at least 50% and new blower shall be able to achieve similar turndowns.

The blowers were evaluated at a discharge pressure of 9.2 psig and a suction pressure loss of 0.3 psi (from dirty inlet filters and inlet piping). For dry-screw machine, an inlet pressure loss of 0.4 psi was assumed. The discharge was based on the discharge pressure of the existing machine which is 9.13 psig but rounded to the next decimal place. Any variation in discharge pressure should have a relative impact on rankings of the alternatives.

Manufacturer’s Selections

Table 3-1 below, shows the different manufacturers used for the evaluation and the associated technology, the selections are included in detail in Appendix A:

Table 3-1: Summary of Selections for Blower Evaluation

BLOWER TYPE	BLOWER MANUFACTURER	NO. OF UNITS	MOTOR SIZE (HP)	DISCHARGE PRESSURE (PSIG)	RATED FLOW (SCFM)	TURNDOWN FLOW SUMMER/WINTER
Multistage - Inlet Throttling	Gardner Denver	1	300	9.2	4,600	50%/59%
Multistage - AFD	Gardner Denver	1	300	9.2	4,600	65%/75%
Integrally Geared – Inlet Vane	LoneStar	1	250	9.2	4,600	50%/50%
Integrally Geared – AFD	Inovair	3	100	9.2	1,533	50%/50%
Dry-Screw - AFD	Gardner Denver (Heliflow HE)	1	250	9.2	4,600	50%/50%

Probabilistic Cost Evaluation

All the proposed alternatives were compared from the financial standpoint of life cycle costs. Given the large number of input variables required to predict total cost, capital expenditure (CAPEX) and operating expenses (OPEX), a probabilistic sensitivity analysis was performed. In this evaluation, each of the main variables affecting the total cost of each alternative (CAPEX + OPEX) was assigned a probability function specific to the variable. Then, a Monte Carlo type simulation with over 10,000 iterations was run for each of the alternatives and the probability curve envelopes of the total cost for each alternative were generated. The Monte Carlo method is a broad class of computational algorithms that rely on repeated random sampling to obtain numerical results. The method involves using random values within a certain range to solve for variety of possible outcomes, and thus

provide a realistic statistical evaluation. This is often used in physical and mathematical problems and is most useful when it is difficult or impossible to use other approaches. Monte Carlo methods are mainly used in three problem classes: optimization, numerical integration and generation of draws from a probability distribution. In this case, each of the evaluated options has multiple variables that make it impossible to predict a specific result without doing multiple iterations of the different variable combinations. Thus, a Monte Carlo simulation is required to combine the different alternatives in a probabilistic distribution.

Budget equipment costs were obtained from the blower manufacturers based on the design requirements listed in Table 3-1, above. Installation cost is assumed to be 40% of the equipment cost. Maintenance costs and electrical infrastructure costs to provide the required power to the blowers are not included in the evaluation of alternatives. The five blower alternatives were evaluated assuming the blowers operate for 100% of the year over a 20-year evaluation period and a power cost of \$0.11/kWh. All alternatives were compared with the net present worth (NPW) method within the Monte Carlo Analysis. Note that the results provided by the analysis are comparative costs for purposes of equipment selection only and do not represent total project costs for aeration system modifications.

Aeration system controls were not specifically included in this evaluation. System control capabilities are similar across the alternatives. Anticipated controls would consist of a new master control panel to control sequencing and capacity of the blowers.

Table 3-2 below includes the input parameters considered in the evaluation and Appendix B contains the different input variables used in the probabilistic model developed.

Table 3-2: Evaluation Input Parameters

CAPEX		
Total # of Blowers		Quantity of blowers
Motor Rating	HP	Nameplate motor size per blower
Blower Cost	\$	Initial cost of blowers
Installation Cost	\$	Installation cost per blower (assumed to be 40% of equipment cost)
CAPEX	\$	Total of Capital Costs (Equipment + Installation)
OPEX		
Maximum Day, Summer		
Units Operating		Quantity of blowers operating, max day summer
Discharge Pressure	psig	Blower discharge pressure, max day summer
Capacity	scfm	Blower capacity, max day summer
Power per blower	HP	Blower draw, max day summer
Power per blower including motor efficiency	HP	Wire power draw, max day summer
Yearly operation	%	Percent of time per year in use, max day summer
Average Day, Summer		

Units Operating		Quantity of blowers operating, ave. day summer
Discharge Pressure	psig	Blower discharge pressure, ave. day summer
Capacity	scfm	Blower capacity, ave. day summer
Power per blower	HP	Blower draw, ave. day summer
Power per blower including motor efficiency	HP	Wire draw including motor efficiency
Yearly operation	%	Percent of time per year in use, ave. day summer
Minimum Day, Summer		
Units Operating		Quantity of blowers operating, min day summer
Discharge Pressure	psig	Blower discharge pressure, min day summer
Capacity	scfm	Blower capacity, min day summer
Power per blower	HP	Blower draw, min day summer
Power per blower including motor efficiency	HP	Wire draw including motor efficiency
Yearly operation	%	Percent of time per year in use, min day summer
Maximum Day, Winter		
Units Operating		Quantity of blowers operating, max day winter
Discharge Pressure	psig	Blower discharge pressure, max day winter
Capacity	scfm	Blower capacity, max day winter
Power per blower	HP	Blower draw, max day winter
Power per blower including motor efficiency	HP	Wire draw including motor efficiency
Yearly operation	%	Percent of time per year in use, max day winter
Average Day, Winter		
Units Operating		Quantity of blowers operating, ave. day winter
Discharge Pressure	psig	Blower discharge pressure, ave. day winter
Capacity	scfm	Blower capacity, ave. day winter
Power per blower	HP	Blower draw, ave. day winter
Power per blower including motor efficiency	HP	Wire draw including motor efficiency
Yearly operation	%	Percent of time per year in use, ave. day winter
Minimum Day, Winter		
Units Operating		Quantity of blowers operating, min day winter
Discharge Pressure	psig	Blower discharge pressure, min day winter
Capacity	scfm	Blower capacity, min day winter
Power per blower	HP	Blower draw, min day winter
Power per blower including motor efficiency	HP	Wire draw including motor efficiency
Yearly operation	%	Percent of time per year in use, min day winter
Summer		100°F, 95% Relative Humidity
Winter		40°F, 50% Relative Humidity
Power Cost	\$ / Kw h	Electricity Rate
Annual Cost	\$	Annual cost of operating blowers
n	20 years	Evaluation period

i	3.5%	Discount Rate
OPEX	\$	Present worth of Annual cost of operating blowers
TOTEX		
TOTEX	\$	Total present worth of each alternative (CAPEX + Present Worth Annual Cost)

The representative plots from the analysis showing the CAPEX, OPEX, and TOTEX for each of the alternatives are shown in Figures 3-5, 3-6, and 3-7 respectively. In the plots the alternatives are numbered in accordance with Table 3-3.

Table 3-3: Alternative Numbering in Analysis Plots

Alternative 1	Multistage - Inlet Throttling
Alternative 2	Multistage - AFD
Alternative 3	Integrally Geared – Inlet Vane
Alternative 4	Integrally Geared – AFD
Alternative 5	Dry-Screw - AFD

Figure 3-5: Capital Expenditures for the Evaluated Alternatives

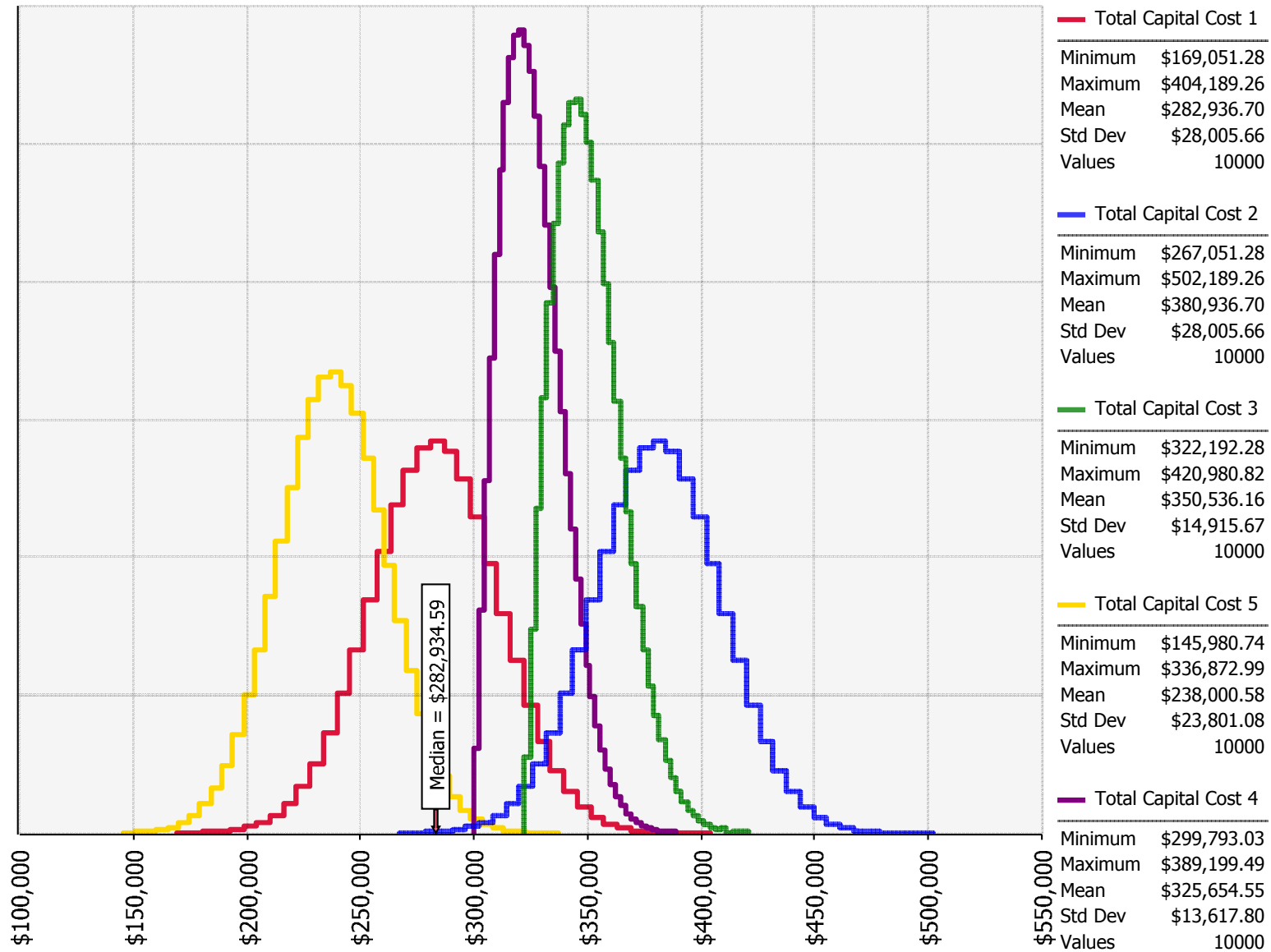

Figure 3-6: Annual Value of Operational Expenditures for the Evaluated Alternatives

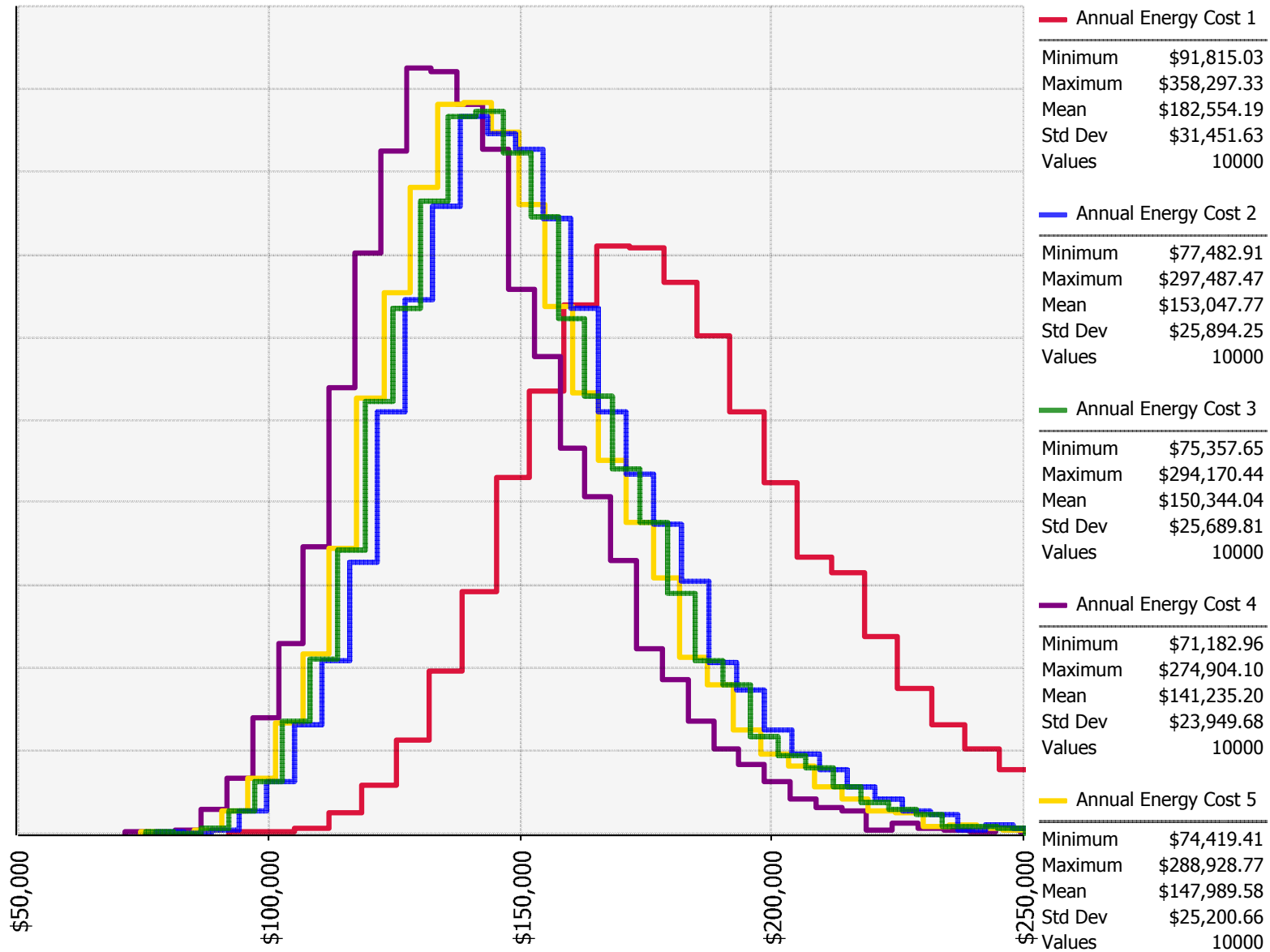
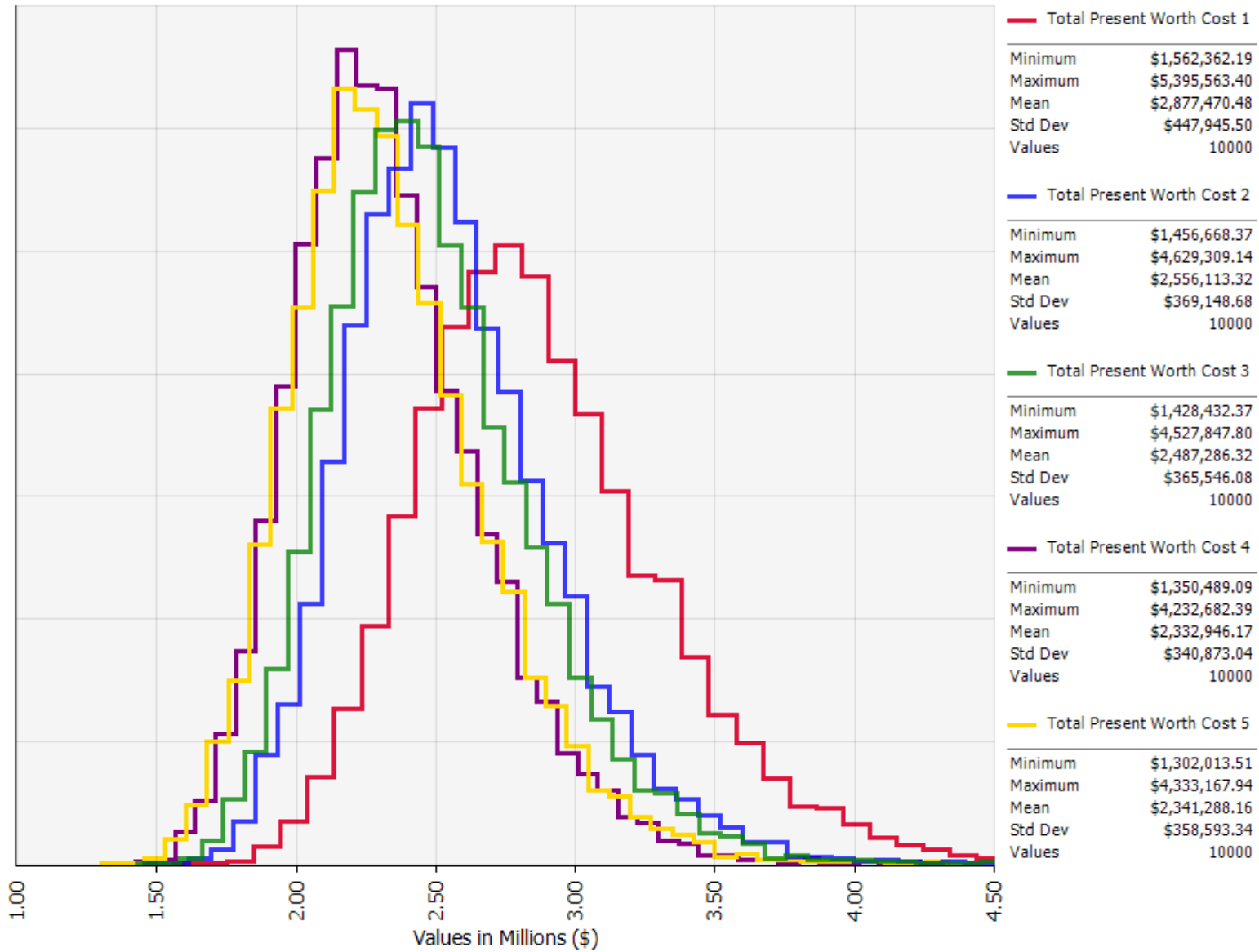

Figure 3-7: 20-year Present Worth of Total Cost of Ownership for the TOTEX



Results

A summary of the results from the analysis are shown in Table 3-4 below. The table shows the minimum, maximum and mean values from the analysis. The percent difference for each option is compared to the multistage centrifugal with inlet throttling as that is the technology currently used in the plant. This comparison is shown as a negative percent difference to indicate the alternative is more expensive than the base alternative, and a positive number indicating the savings with the specified alternative.

The capital cost of the multistage centrifugal with inlet throttling is the second least expensive option at \$169,051-\$404,189 with a mean value of \$282,936. The capital cost of the dry-screw technology is the least expensive option at \$145,981-\$336,873 with a mean value of \$238,001, which represent savings of 14%-17% (16%). The other three alternatives, all have higher capital costs than dry-screw and multistage with inlet throttling.

In contrast to the lower capital cost, and as expected, the power consumption from the multistage blowers with inlet throttling is the greatest of all the technologies with an annual operating present worth of \$91,815-\$358,297 with a mean value of \$182,554, or \$1,836,300-\$7,165,940 with a mean value of \$3,651,080 over a 20-year period. The most efficient alternative was the integrally geared turbo with AFD with an annual operating present worth of \$71,183-\$274,904 with a mean value of \$141,235 or \$1,423,660-\$5,498,080 with a mean value of \$2,824,700 over a 20-year period which represents a 22%-24% (23%) savings (over a 20-year period) compared to the existing blowers.

Overall, the blower alternative with the lowest total present worth (capital cost + operating cost) is the integrally geared turbo with AFD with a total present worth of \$1,350,489-\$4,232,682 with a mean value of \$2,332,649 over a 20-year period, savings of 14%-22%(19%), followed by the dry-screw blower with a total operating present worth of \$1,302,014-\$4,333,168 with a mean value of \$2,341,288 over a 20-year period, 17%-20%(19%). Total savings over a 20-year period for the integrally geared with AFD and dry-screw vs multistage with inlet throttling was \$571,665 (18% savings) and \$489,343 (15% savings) respectively.

As previously indicated, the integrally geared blower with AFD can only achieve the required flows and pressure with three units. Although stack packages are available, only two blowers can be combined in a stack, resulting in two separate enclosures and the area contemplated for the blower installation does not have enough space for the installation of two units. However, adding a platform area for the second blower enclosure should be feasible and not too costly.

Table 3-4: Evaluation Summary

	MULTISTAGE INLET THROTTLING	MULTISTAGE AFD	GEARED TURBO INLET GUIDED VANES	GEARED TURBO AFD ¹	DRY-SCREW AFD
Capital Expenditure					
Minimum CAPEX	\$169,051	\$267,051	\$322,193	\$299,793	\$145,981
Maximum CAPEX	\$404,189	\$502,189	\$420,981	\$389,199	\$336,873
Mean CAPEX	\$282,937	\$380,937	\$350,536	\$325,655	\$238,001
Annual OPEX					
Minimum Annual OPEX	\$ 91,815	\$ 77,483	\$75,358	\$71,183	\$74,419
Maximum Annual OPEX	\$ 358,297	\$ 297,487	\$ 294,170	\$ 274,904	\$ 288,929
Mean Annual OPEX	\$ 182,554	\$ 153,048	\$ 150,344	\$ 141,235	\$ 147,990
Total Present Worth					
Minimum Present Worth Cost	\$ 1,562,362	\$ 1,456,668	\$1,428,432	\$1,350,489	\$1,302,014
Maximum Present Worth Cost	\$ 5,395,563	\$4,629,309	\$4,527,848	\$4,232,682	\$4,333,168
Mean Present Worth Cost	\$ 2,877,470	\$2,556,113	\$2,487,286	\$2,332,649	\$2,341,288
Savings Using a New Multistage Blower with Inlet Throttling as the Base Unit					
Mean Annual OPEX	---	(\$98,000) 35%	(\$67,599) 24%	(\$42,718) 15%	\$44,936 16%
Mean Annual OPEX	---	\$29,506 16%	\$32,210 18%	\$41,319 23%	\$34,564 19%
Mean Present Worth Cost	---	\$321,357 11%	\$390,184 14%	\$544,821 19%	\$536,182 19%

1. Three blowers need to operate at the same time to meet rated flow.

4.0 Conclusions and Recommendations

From the information provided in the previous sections, here are some initial conclusions:

- Of the 5 blower alternatives evaluated, it is clear that implementing Alternatives 3, 4, or 5 will result in the most savings to the City from the TOTEX standpoint. Implementing Alternative 2 results in the highest TOTEX to the City.
- There is little difference in the TOTEX between Alternatives 3, 4, and 5, including variability. Alternative 4 provides the lowest TOTEX envelope, marginally below Alternative 5.
- The lowest CAPEX envelope is for Alternative 5 while the highest CAPEX is for Alternative 2. Alternative 4 is in the middle of all envelopes.
- Alternative 4 has the lowest OPEX. This is important as it provides the most savings from possible power rate increases in the future. However, the difference between Alternative 4 and 5 is less than \$10,000.
- Alternative 1 has the largest power cost of all alternatives.
- Alternative 4 has the advantage of multiple units in the same package. This translates in two key advantages: (1) better turndown than any other alternative, providing additional annual power savings, (2) additional redundancy built in, as if one of the units goes out of service, there will be two other units for throttling flows up/down, which guarantees savings even with one unit down.
- Alternative 4 is new to the market and lacks competition. This could potentially shift the CAPEX of Alternative 4 to the right side of the envelope.
- Alternative 2 uses the same type of blower as what is currently at the plant. Staff has familiarity with this type of unit and adding another unit should be straightforward.
- Alternatives 2 through 5 require installation of a AFD. Given the environmental conditions at the plant, it is recommended that the AFD be installed inside the electrical room.
- Alternative 4 requires the use of two stack enclosures. Therefore, more platform area than what is currently available will be required. This will increase the CAPEX of this alternative from what is shown in the analysis.

4.1 RECOMMENDATIONS

The results of the evaluation were discussed in a workshop with the City and plant staff. Collectively, City and plant staff agreed that shying away from the current concept (Alternative 1) is the most sensible approach for the City, as all other alternatives provide better energy management. City and plant staff saw the benefits of the two lowest TOTEX alternatives, Alternatives 4 and 5. However, the City is looking into forward thinking approaches that will result in smart business case strategies in the future, and Alternative 4 provides some of those added advantages. This include the wider flexibility in operation with more units and the ease of adding an additional unit in the future if required.

Understanding that the manufacturer for Alternative 4 does not have units installed in Florida, City and plant staff decided to perform a reference check with other installations in the US, to ascertain the performance of the slow turbo units in other

WWTPs. A total of 4 utilities were contacted and the feedback obtain from each of them was very positive, with just a couple of comments about minor components improvements of their enclosure system. After the refences evaluations, City and plant staff felt comfortable with using slow turbo units, so Alternative 4 was selected for implementation. However, to minimize potential problems, the following steps/measures will be taken in the blower addition project:

1. The slow turbo manufacturer has a standard 2-year warranty for the units. The City would like to get an extended warranty. Black & Veatch recommends negotiating a 5-year warranty, to which the manufacturer is open.
2. Black & Veatch recommended to specify witness testing before the units are shipped from the factory in the contract documents to ensure that guaranteed power numbers are met. Penalties for not meeting those will be specified.
3. To prevent price gauging during the solesource, Black & Veatch recommends requesting recent bid pricing from the slow turbo blower manufacturer for other projects so that the negotiated pricing is fair. It is also recommended that the City purchase the blowers directly, and that this equipment is assigned to the successful bidder for the project. Black & Veatch will prepare a blower purchase package with all requirements for the manufacturer to provide a firm pricing for the units.
4. Pricing for three units will be requested. An add-on pricing item for adding a fourth unit will also be requested.
5. The spec will consider the use of 316 SS for the cooling fan air filter bracket to avoid corrosion issues.
6. The current enclosure design will be reviewed against hurricane standards for Key West. Door latches, and plastic panels that could be easily damaged during a storm will be reviewed, and potential remedial measures will be requested in the enclosure design and specified in the procurement specification.
7. An additional spare gearbox and any other components required for replacing that unit will be added to the equipment procurement.

APPENDIX A

Manufacturer Selections

QUOTE #: Budget



REPRESENTATIVE: United Midwest, Inc.

QUOTATION FOR: Hector Torres

ADDRESS: Black & Veatch

DATE: 9/4/2018

APPLICATION: Aeration

FOR INSTALLATION AT: Key West, FL WWTP

Wt	Part #	Qty	Description	Unit Sell	Total
13080	1607	1	1607, 16" In & 14" Out, Blower	\$136,916.10	\$136,916.10
	PTU1600	1	PTC-10 ASME Performance Test, Unwitnessed - 1600	\$2,593.90	\$2,593.90
91	HF00485082	1	Expansion Joint with Rods; 16"	\$1,789.05	\$1,789.05
55	HF00485051	1	Expansion Joint w/o rods; 14"	\$1,384.43	\$1,384.43
220	BA1006600000	1	Check Valve (Wafer); 14"	\$3,983.37	\$3,983.37
175	MBFV4-20ma16	1	BFV, Waf, Metal Seat, 4-20 mA Act; 16", 10 psig max	\$8,792.44	\$8,792.44
127	VP1024065	1	Butterfly Valve, Resilient Seat, Wafer, Handwheel Act; 14"	\$2,270.36	\$2,270.36
107	VP1012708	1	Intake Fil/Sil; Ultra; Cartridge; 16" FLG; Element - VP1012697 - Rated 11000 CFM	\$3,638.02	\$3,638.02
	BA2182nn	1	Duplex SmartMeter Surge/OL, Brg Vibration	\$11,729.84	\$11,729.84
		1	Freight	\$2,000.00	\$2,000.00
		1	Service	\$2,000.00	\$2,000.00
3600		1	300 Hp 3/60/460 VAC TEFC Motor	\$25,000.00	\$25,000.00
17455		12	Total		\$202,097.50

Date: 9/4/2018

Project Name: Key West, FL WWTP

Customer: Black & Veatch; Hector Torres

Sales Order Number:

Application Engineer: RShankel

Comment: Scenario 2: 4600 SCFM VFD

AMBIENT GAS PARAMETERS	ENGLISH UNITS	METRIC UNITS
Molecular Weight	28.282 lbm/lbmol	28.282 kg/kgmol
R Value	54.628 ft.lbf/lbm.R	0.294 kJ/kg.K
Density	0.069 lbm/ft^3	1.108 kg/m^3
Sp. Heat @ Const. P	0.248 BTU/lbm.R	1.039 kJ/kg.K
Ratio of Sp. Heats	1.395	1.395
Partial Pres. of Vapor	0.910	0.910

GAS MIX:	VOL
Air	100

Inlet Set 1

CORRECTED VALUES	ORIGINAL UNITS	ENGLISH UNITS	METRIC UNITS
Ambient Pressure	10 ALTI-FT	14.69 PSIA	1.01 bar a
Relative Humidity	95%	95%	95%
Ambient Temperature	100 F	100.00 F	37.78 C
Inlet Pressure	-0.3 PSIG	14.39 PSIA	0.99 bar g
Inlet Flow	4600 SCFM	5271 ICFM	8956 m3/h
Discharge Pressure	9.2 PSIG	9.20 PSIG	0.63 bar g
MEASURED VALUES	ORIGINAL UNITS	ENGLISH UNITS	METRIC UNITS
VFD Speed	3545 RPM	3545 RPM	3545 RPM
Surge Flow Rate	1674 SCFM	1918 ICFM	3259 m3/h
Surge Pressure	11.25 PSIG	11.25 PSIG	0.78 bar g
Pressure Rise to Surge	2.05 PSIG	2.05 PSIG	0.14 bar g
Max. Vol. Turndown	63.61%	63.61%	63.61%
Pressure @ Design	9.20 PSIG	9.20 PSIG	0.63 bar g
Power @ Design	239.01 HP	239.01 HP	178.23 KW
Efficiency @ Design	75.56%	75.56%	75.56%
Temperature @ Design	214.35 F	214.35 F	101.31 C

Inlet Set 2

CORRECTED VALUES	ORIGINAL UNITS	ENGLISH UNITS	METRIC UNITS
Ambient Pressure	10 ALTI-FT	14.69 PSIA	1.01 bar a
Relative Humidity	95%	95%	95%
Ambient Temperature	100 F	100.00 F	37.78 C
Inlet Pressure	-0.3 PSIG	14.39 PSIA	0.99 bar g
Inlet Flow	3450 SCFM	3953 ICFM	6717 m3/h
Discharge Pressure	9.2 PSIG	9.20 PSIG	0.63 bar g
MEASURED VALUES	ORIGINAL UNITS	ENGLISH UNITS	METRIC UNITS
VFD Speed	3346 RPM	3346 RPM	3346 RPM
Surge Flow Rate	1478 SCFM	1694 ICFM	2878 m3/h
Surge Pressure	9.79 PSIG	9.79 PSIG	0.67 bar g
Pressure Rise to Surge	0.59 PSIG	0.59 PSIG	0.04 bar g
Max. Vol. Turndown	57.15%	57.15%	57.15%
Pressure @ Design	9.20 PSIG	9.20 PSIG	0.63 bar g
Power @ Design	187.42 HP	187.42 HP	139.76 KW
Efficiency @ Design	72.26%	72.26%	72.26%
Temperature @ Design	219.57 F	219.57 F	104.20 C

Inlet Set 3

CORRECTED VALUES	ORIGINAL UNITS	ENGLISH UNITS	METRIC UNITS
Ambient Pressure	10 ALTI-FT	14.69 PSIA	1.01 bar a
Relative Humidity	95%	95%	95%
Ambient Temperature	100 F	100.00 F	37.78 C
Inlet Pressure	-0.3 PSIG	14.39 PSIA	0.99 bar g
Inlet Flow	2300 SCFM	2636 ICFM	4478 m3/h
Discharge Pressure	9.2 PSIG	9.20 PSIG	0.63 bar g
MEASURED VALUES	ORIGINAL UNITS	ENGLISH UNITS	METRIC UNITS
VFD Speed	3253 RPM	3253 RPM	3253 RPM
Surge Flow Rate	1437 SCFM	1647 ICFM	2798 m3/h
Surge Pressure	9.16 PSIG	9.16 PSIG	0.63 bar g
Pressure Rise to Surge	-0.04 PSIG	-0.04 PSIG	-0.00 bar g
Max. Vol. Turndown	37.51%	37.51%	37.51%
Pressure @ Design	9.20 PSIG	9.20 PSIG	0.63 bar g
Power @ Design	143.97 HP	143.97 HP	107.36 KW
Efficiency @ Design	62.71%	62.71%	62.71%
Temperature @ Design	237.77 F	237.77 F	114.32 C

Inlet Set 4

CORRECTED VALUES	ORIGINAL UNITS	ENGLISH UNITS	METRIC UNITS
Ambient Pressure	10 ALTI-FT	14.69 PSIA	1.01 bar a
Relative Humidity	95%	95%	95%
Ambient Temperature	100 F	100.00 F	37.78 C
Inlet Pressure	-0.3 PSIG	14.39 PSIA	0.99 bar g
Inlet Flow	3000 SCFM	3438 ICFM	5841 m3/h
Discharge Pressure	9.2 PSIG	9.20 PSIG	0.63 bar g
MEASURED VALUES	ORIGINAL UNITS	ENGLISH UNITS	METRIC UNITS
VFD Speed	3296 RPM	3296 RPM	3296 RPM
Surge Flow Rate	1456 SCFM	1669 ICFM	2835 m3/h
Surge Pressure	9.45 PSIG	9.45 PSIG	0.65 bar g
Pressure Rise to Surge	0.25 PSIG	0.25 PSIG	0.02 bar g
Max. Vol. Turndown	51.46%	51.46%	51.46%
Pressure @ Design	9.20 PSIG	9.20 PSIG	0.63 bar g
Power @ Design	170.00 HP	170.00 HP	126.77 KW
Efficiency @ Design	69.26%	69.26%	69.26%
Temperature @ Design	224.73 F	224.73 F	107.07 C

Inlet Set 5

CORRECTED VALUES	ORIGINAL UNITS	ENGLISH UNITS	METRIC UNITS
Ambient Pressure	10 ALTI-FT	14.69 PSIA	1.01 bar a
Relative Humidity	50%	50%	50%
Ambient Temperature	40 F	40.00 F	4.44 C
Inlet Pressure	-0.3 PSIG	14.39 PSIA	0.99 bar g
Inlet Flow	4600 SCFM	4430 ICFM	7527 m3/h
Discharge Pressure	9.2 PSIG	9.20 PSIG	0.63 bar g
MEASURED VALUES	ORIGINAL UNITS	ENGLISH UNITS	METRIC UNITS
VFD Speed	3222 RPM	3222 RPM	3222 RPM
Surge Flow Rate	1810 SCFM	1743 ICFM	2962 m3/h
Surge Pressure	10.58 PSIG	10.58 PSIG	0.73 bar g
Pressure Rise to Surge	1.38 PSIG	1.38 PSIG	0.09 bar g
Max. Vol. Turndown	60.65%	60.65%	60.65%
Pressure @ Design	9.20 PSIG	9.20 PSIG	0.63 bar g
Power @ Design	201.62 HP	201.62 HP	150.35 KW
Efficiency @ Design	74.98%	74.98%	74.98%
Temperature @ Design	143.40 F	143.40 F	61.89 C

Inlet Set 6

CORRECTED VALUES	ORIGINAL UNITS	ENGLISH UNITS	METRIC UNITS
Ambient Pressure	10 ALTI-FT	14.69 PSIA	1.01 bar a
Relative Humidity	50%	50%	50%
Ambient Temperature	40 F	40.00 F	4.44 C
Inlet Pressure	-0.3 PSIG	14.39 PSIA	0.99 bar g
Inlet Flow	3450 SCFM	3323 ICFM	5645 m3/h
Discharge Pressure	9.2 PSIG	9.20 PSIG	0.63 bar g
MEASURED VALUES	ORIGINAL UNITS	ENGLISH UNITS	METRIC UNITS
VFD Speed	3084 RPM	3084 RPM	3084 RPM
Surge Flow Rate	1621 SCFM	1561 ICFM	2653 m3/h
Surge Pressure	9.51 PSIG	9.51 PSIG	0.66 bar g
Pressure Rise to Surge	0.31 PSIG	0.31 PSIG	0.02 bar g
Max. Vol. Turndown	53.01%	53.01%	53.01%
Pressure @ Design	9.20 PSIG	9.20 PSIG	0.63 bar g
Power @ Design	161.73 HP	161.73 HP	120.60 KW
Efficiency @ Design	70.08%	70.08%	70.08%
Temperature @ Design	150.61 F	150.61 F	65.89 C

Static Discharge Pressure PSIG

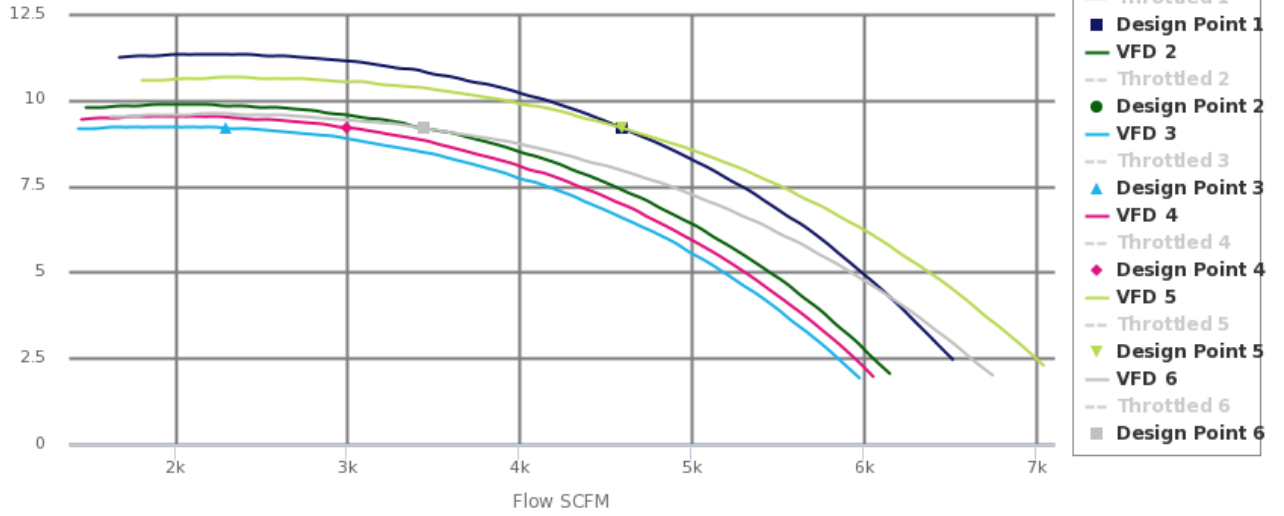

Highcharts.com

Shaft Power HP

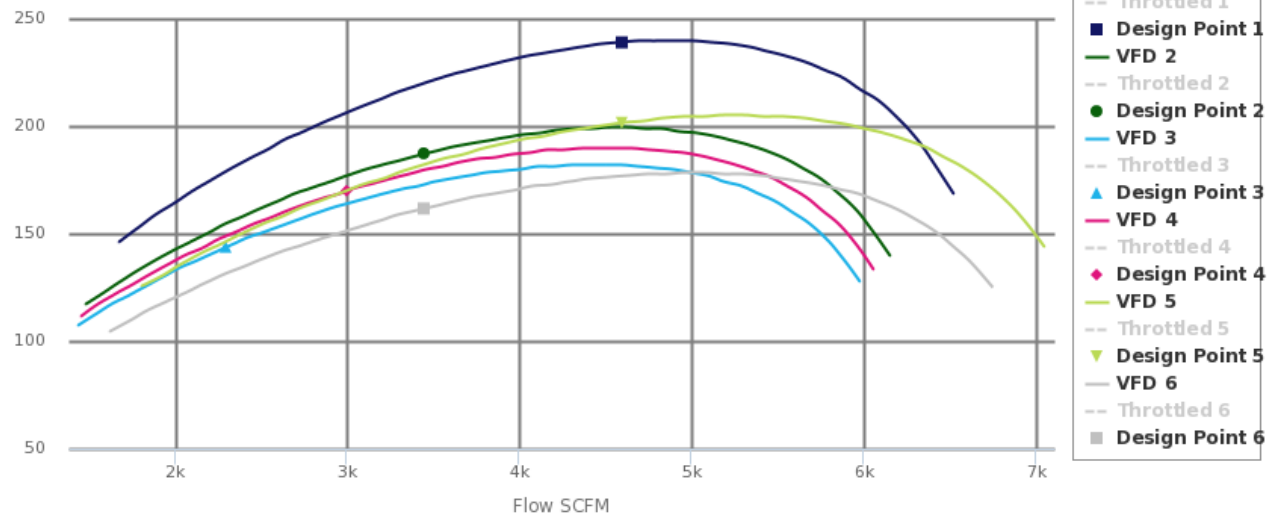

Highcharts.com

Temperature °F

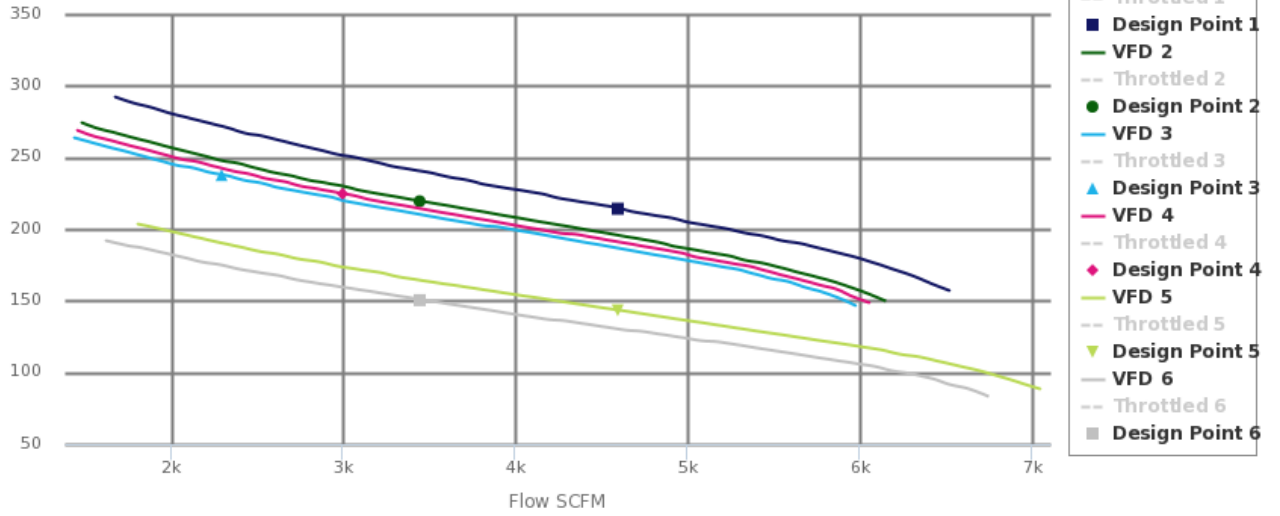

Highcharts.com

Static Efficiency %

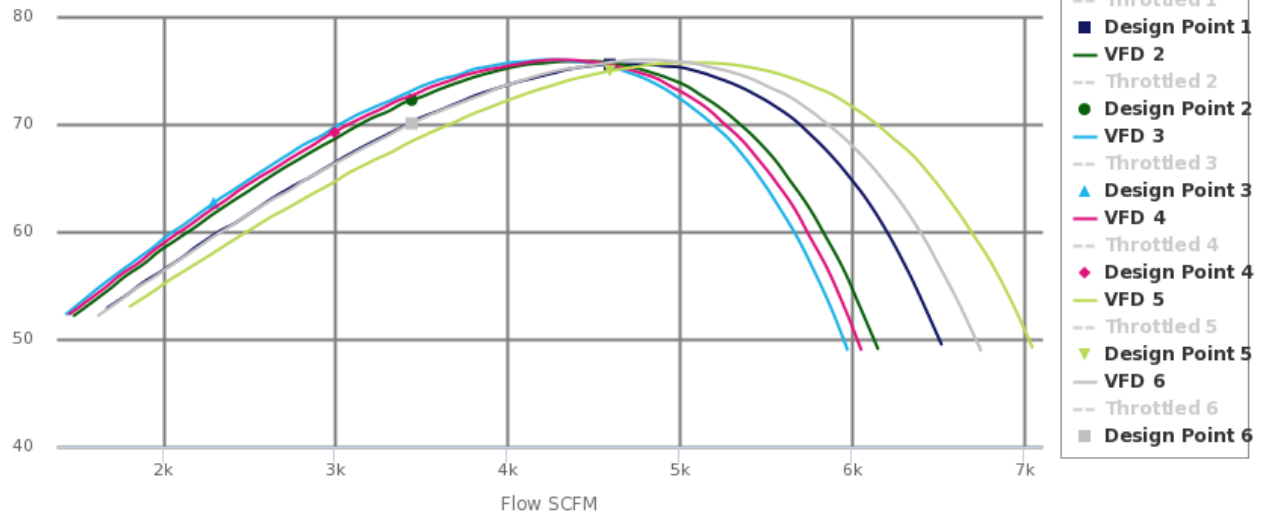

Highcharts.com

Date: 9/4/2018

Project Name: Key West, FL WWTP

Customer: Black & Veatch; Hector Torres

Sales Order Number:

Application Engineer: RShankel

Comment: Scenario 2: 4600 SCFM Inlet Throttled

AMBIENT GAS PARAMETERS	ENGLISH UNITS	METRIC UNITS
Molecular Weight	28.282 lbm/lbmol	28.282 kg/kgmol
R Value	54.628 ft.lbf/lbm.R	0.294 kJ/kg.K
Density	0.069 lbm/ft^3	1.108 kg/m^3
Sp. Heat @ Const. P	0.248 BTU/lbm.R	1.039 kJ/kg.K
Ratio of Sp. Heats	1.395	1.395
Partial Pres. of Vapor	0.910	0.910

GAS MIX:	VOL
Air	100

Inlet Set 1

CORRECTED VALUES	ORIGINAL UNITS	ENGLISH UNITS	METRIC UNITS
Ambient Pressure	10 ALTI-FT	14.69 PSIA	1.01 bar a
Relative Humidity	95%	95%	95%
Ambient Temperature	100 F	100.00 F	37.78 C
Inlet Pressure	-0.3 PSIG	14.39 PSIA	0.99 bar g
Inlet Flow	4600 SCFM	5271 ICFM	8956 m3/h
Discharge Pressure	9.2 PSIG	9.20 PSIG	0.63 bar g
MEASURED VALUES	ORIGINAL UNITS	ENGLISH UNITS	METRIC UNITS
Surge Flow Rate	2247 SCFM	2575 ICFM	4375 m3/h
Surge Pressure	11.31 PSIG	11.31 PSIG	0.78 bar g
Pressure Rise to Surge	2.11 PSIG	2.11 PSIG	0.15 bar g
Max. Vol. Turndown	51.15%	51.15%	51.15%
Pressure @ Design	9.20 PSIG	9.20 PSIG	0.63 bar g
Power @ Design	264.14 HP	264.14 HP	196.97 KW
Efficiency @ Design	69.52%	69.52%	69.52%
Temperature @ Design	226.37 F	226.37 F	107.98 C

Inlet Set 2

CORRECTED VALUES	ORIGINAL UNITS	ENGLISH UNITS	METRIC UNITS
Ambient Pressure	10 ALTI-FT	14.69 PSIA	1.01 bar a
Relative Humidity	95%	95%	95%
Ambient Temperature	100 F	100.00 F	37.78 C
Inlet Pressure	-0.3 PSIG	14.39 PSIA	0.99 bar g
Inlet Flow	3450 SCFM	3953 ICFM	6717 m3/h
Discharge Pressure	9.2 PSIG	9.20 PSIG	0.63 bar g
MEASURED VALUES	ORIGINAL UNITS	ENGLISH UNITS	METRIC UNITS
Surge Flow Rate	2247 SCFM	2575 ICFM	4375 m3/h
Surge Pressure	11.31 PSIG	11.31 PSIG	0.78 bar g
Pressure Rise to Surge	2.11 PSIG	2.11 PSIG	0.15 bar g
Max. Vol. Turndown	34.87%	34.87%	34.87%
Pressure @ Design	9.20 PSIG	9.20 PSIG	0.63 bar g
Power @ Design	221.50 HP	221.50 HP	165.17 KW
Efficiency @ Design	67.79%	67.79%	67.79%
Tempurature @ Design	244.99 F	244.99 F	118.33 C

Inlet Set 3

CORRECTED VALUES	ORIGINAL UNITS	ENGLISH UNITS	METRIC UNITS
Ambient Pressure	10 ALTI-FT	14.69 PSIA	1.01 bar a
Relative Humidity	95%	95%	95%
Ambient Temperature	100 F	100.00 F	37.78 C
Inlet Pressure	-0.3 PSIG	14.39 PSIA	0.99 bar g
Inlet Flow	2300 SCFM	2636 ICFM	4478 m3/h
Discharge Pressure	9.2 PSIG	9.20 PSIG	0.63 bar g
MEASURED VALUES	ORIGINAL UNITS	ENGLISH UNITS	METRIC UNITS
Surge Flow Rate	2247 SCFM	2575 ICFM	4375 m3/h
Surge Pressure	11.31 PSIG	11.31 PSIG	0.78 bar g
Pressure Rise to Surge	2.11 PSIG	2.11 PSIG	0.15 bar g
Max. Vol. Turndown	2.31%	2.31%	2.31%
Pressure @ Design	9.20 PSIG	9.20 PSIG	0.63 bar g
Power @ Design	173.55 HP	173.55 HP	129.42 KW
Efficiency @ Design	59.45%	59.45%	59.45%
Temperature @ Design	271.69 F	271.69 F	133.16 C

Inlet Set 4

CORRECTED VALUES	ORIGINAL UNITS	ENGLISH UNITS	METRIC UNITS
Ambient Pressure	10 ALTI-FT	14.69 PSIA	1.01 bar a
Relative Humidity	50%	50%	50%
Ambient Temperature	40 F	40.00 F	4.44 C
Inlet Pressure	-0.3 PSIG	14.39 PSIA	0.99 bar g
Inlet Flow	4600 SCFM	4430 ICFM	7527 m3/h
Discharge Pressure	9.2 PSIG	9.20 PSIG	0.63 bar g
MEASURED VALUES	ORIGINAL UNITS	ENGLISH UNITS	METRIC UNITS
Surge Flow Rate	2674 SCFM	2575 ICFM	4375 m3/h
Surge Pressure	13.40 PSIG	13.40 PSIG	0.92 bar g
Pressure Rise to Surge	4.20 PSIG	4.20 PSIG	0.29 bar g
Max. Vol. Turndown	41.88%	41.88%	41.88%
Pressure @ Design	9.20 PSIG	9.20 PSIG	0.63 bar g
Power @ Design	266.27 HP	266.27 HP	198.56 KW
Efficiency @ Design	68.73%	68.73%	68.73%
Temperature @ Design	183.56 F	183.56 F	84.20 C

Inlet Set 5

CORRECTED VALUES	ORIGINAL UNITS	ENGLISH UNITS	METRIC UNITS
Ambient Pressure	10 ALTI-FT	14.69 PSIA	1.01 bar a
Relative Humidity	50%	50%	50%
Ambient Temperature	40 F	40.00 F	4.44 C
Inlet Pressure	-0.3 PSIG	14.39 PSIA	0.99 bar g
Inlet Flow	3450 SCFM	3323 ICFM	5645 m3/h
Discharge Pressure	9.2 PSIG	9.20 PSIG	0.63 bar g
MEASURED VALUES	ORIGINAL UNITS	ENGLISH UNITS	METRIC UNITS
Surge Flow Rate	2674 SCFM	2575 ICFM	4375 m3/h
Surge Pressure	13.40 PSIG	13.40 PSIG	0.92 bar g
Pressure Rise to Surge	4.20 PSIG	4.20 PSIG	0.29 bar g
Max. Vol. Turndown	22.51%	22.51%	22.51%
Pressure @ Design	9.20 PSIG	9.20 PSIG	0.63 bar g
Power @ Design	223.81 HP	223.81 HP	166.90 KW
Efficiency @ Design	63.70%	63.70%	63.70%
Temperature @ Design	202.86 F	202.86 F	94.92 C

Inlet Set 6

CORRECTED VALUES	ORIGINAL UNITS	ENGLISH UNITS	METRIC UNITS
Ambient Pressure	10 ALTI-FT	14.69 PSIA	1.01 bar a
Relative Humidity	50%	50%	50%
Ambient Temperature	40 F	40.00 F	4.44 C
Inlet Pressure	-0.3 PSIG	14.39 PSIA	0.99 bar g
Inlet Flow	2700 SCFM	2600 ICFM	4418 m3/h
Discharge Pressure	9.2 PSIG	9.20 PSIG	0.63 bar g
MEASURED VALUES	ORIGINAL UNITS	ENGLISH UNITS	METRIC UNITS
Surge Flow Rate	2674 SCFM	2575 ICFM	4375 m3/h
Surge Pressure	13.40 PSIG	13.40 PSIG	0.92 bar g
Pressure Rise to Surge	4.20 PSIG	4.20 PSIG	0.29 bar g
Max. Vol. Turndown	0.98%	0.98%	0.98%
Pressure @ Design	9.20 PSIG	9.20 PSIG	0.63 bar g
Power @ Design	193.04 HP	193.04 HP	143.95 KW
Efficiency @ Design	58.30%	58.30%	58.30%
Tempurature @ Design	219.71 F	219.71 F	104.28 C

Static Discharge Pressure PSIG

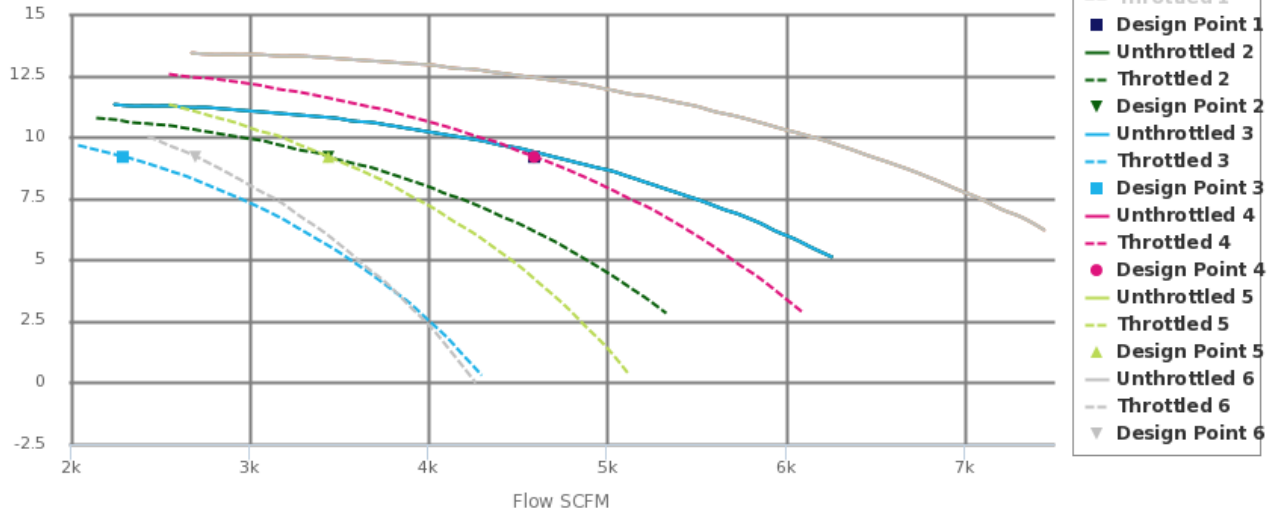

Highcharts.com

Shaft Power HP

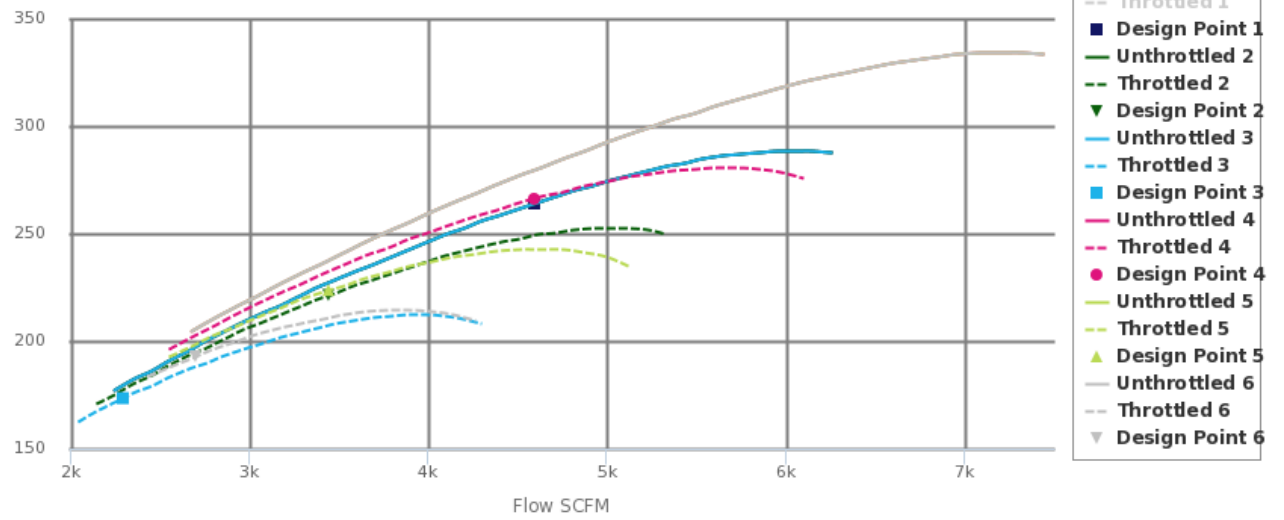

Highcharts.com

Temperature °F

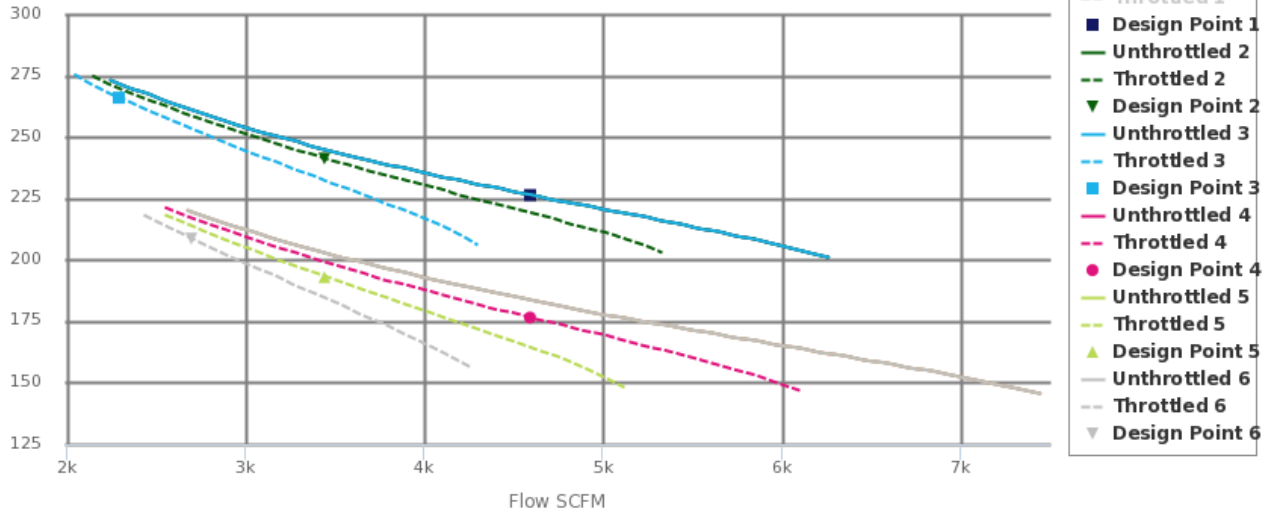

Highcharts.com

Static Efficiency %

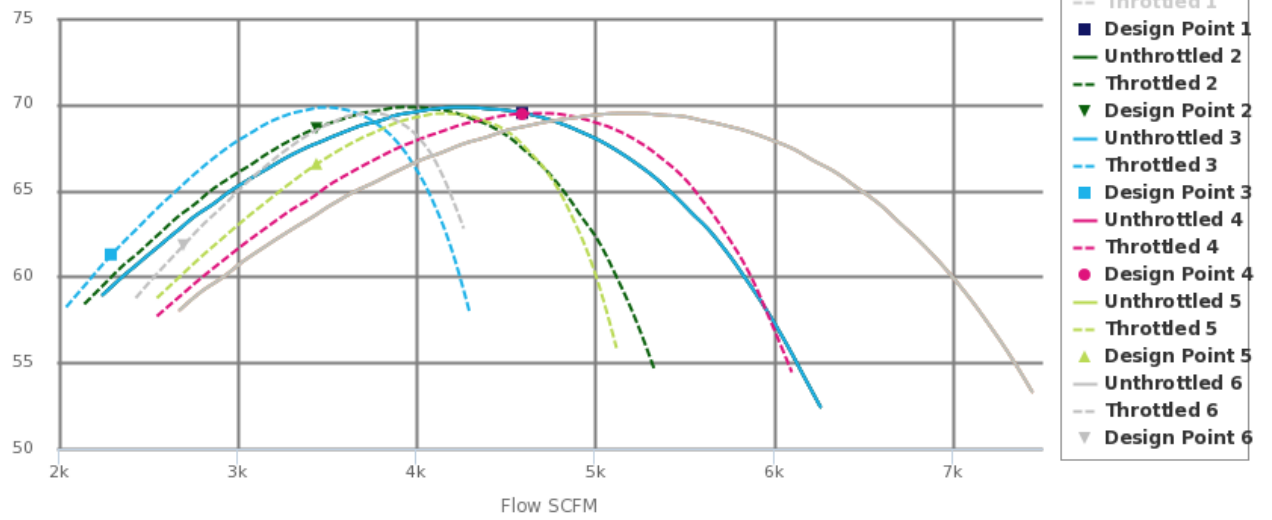

Highcharts.com

McGonigle, Miles

From: Torres, Hector R.
Sent: Wednesday, September 19, 2018 15:54
To: Torres, Hector R.
Subject: FW: Key West WWTP - Blower Eval - Multistage Lone Star Blower

From: Parker Korenek <pkorenek@lonestarrow.com>
Sent: Tuesday, September 04, 2018 7:21 PM
To: Torres, Hector R. <TorresHR@bv.com>
Subject: RE: Key West WWTP - Blower Eval - Multistage Lone Star Blower

Hector,

I can build you formal proposals on each of these options in the morning in order to better organize everything. Not sure on when you need everything in the morning so I have attached all of the preliminary performance curves here and cutsheets on each unit. Below I will outline the unit, the scenario, and the motor size, and a plug budget number that has accessories, startup, freight, controls/instruments, and a sequencer for anything that has more than 1 duty unit.

The pressure on this one is a respectable pressure, a little bit lower pressure need would help out with the flow range capabilities of each of the scenarios. As an alternative I am also including options for the two scenarios that are made up of our geared turbo units. We can make these weather proof and place them in an enclosure for added protection in the outdoor installation. These are much better at achieving the performance scenarios in a single unit with room to spare. The budget numbers on these include an enclosure for the units as well.

Scenario 2: Geared Turbo option

- **1 duty unit for the total flow**, Model GL3, with 250 HP motor
- Price (1 duty blowers, accessories with controls and starter, startup, freight): \$230,000.00

If you want to call in the morning as well too I can walk you through each of the scenarios and explain what is going on.

Regards,



Parker Korenek | Applications Engineer

Lone Star Blower, Inc.

T: [832-532-3112](tel:832-532-3112) | F: [832-532-3115](tel:832-532-3115)

M: [817-771-3092](tel:817-771-3092)

E: pkorenek@lonestarrow.com

W: www.lonestarrow.com

Lone Star Blower



GL3-WX-02

Standard Specifications

Flow Capacity	See performance chart
Flow Range	100% to 45% of rated flow with combination control
Pressure Range	3 to 30 PSIG
Power Range	Sized by factory
Noise Level	88 – 91 dB(A) without enclosure 75 – 78 dB(A) with enclosure
Gearbox	Helical gear sets
Bearings	Force lubricated journal bearings
Gas	Air, steam, H ₂ S, biogas or custom gas configuration
Control System Options	Combination inlet and discharge guide vanes, variable diffuser vane, variable inlet guide vanes, variable speed control or blow off control
Controller	Allen Bradley Compac Logixs*
HMI	Allen Bradley Panel View Plus*
Pressure Sensors	IP55 4-20mA transducers
Temperature Sensors	P55 4-20mA transducers
Inlet Filter/Silencer	GLT custom designed 99% at 5 micron
Expansion Joint	150# flanged temperature rated elastomer
Turbo Expander Cone	Schedule 40 steel
Local Control Panel	NEMA 12, NEMA 4X or custom
Base Frame	Structural steel
Blower Driver	Electric induction motor 2 pole 50/60 Hz, steam turbine, engine
Enclosure	Galvanized steel
Total Weight	(See chart on back side)
Discharge Velocity	20 m/s
Vibration Level	2.8 mm/s per ISO 10816-1 ISO 10816-1
Oil Cooling	Air or external liquid to oil

Safety Monitoring

Surge	Anti surge switch
Temperature	Inlet, oil reservoir, oil cooler, enclosure
Oil Pressure	Oil reservoir
Oil Level	Oil reservoir
Delta Pressure	Inlet and outlet

Auxiliaries

Electrical Actuators	Electric modulated IP66 with positional control to LCP
Blow Off Valve	Electric modulated IP66 with positional control to LCP
Cooling Fan	IP55 50/60 HZ
Check Valve	Butterfly valve

Material Specifications

Casing: Volute	Grey iron GG25
Casing:	
Inner Volute and Gearbox ...	Grey iron GG25
Impeller	Aluminum alloy AlCu2MgNi (anodized optional)

Material Specifications Continued

Diffuser Vanes	Stainless steel 304
Gears	High tensile alloy steel 20CrNiMo
High Speed Shaft	High tensile alloy steel 20CrNiMo
Slow Shaft	High tensile alloy steel 20CrNiMo
Coupling	Alloy steel 40Cr
Filter Material	Synthetic fiber
Machine Mounts	St. SIS 1312 for inertial damping with rubber hardness 60
Bearings	Alloy steel with white PAP alloy
Standards	API 617, 673
Test Procedure	ISO 5389, ASME PTC10, ASME PTC13
Quality	ISO 9001, ISO 14001

General Performance

Standard Conditions (68°F, 36% RH, 14.7 psia)

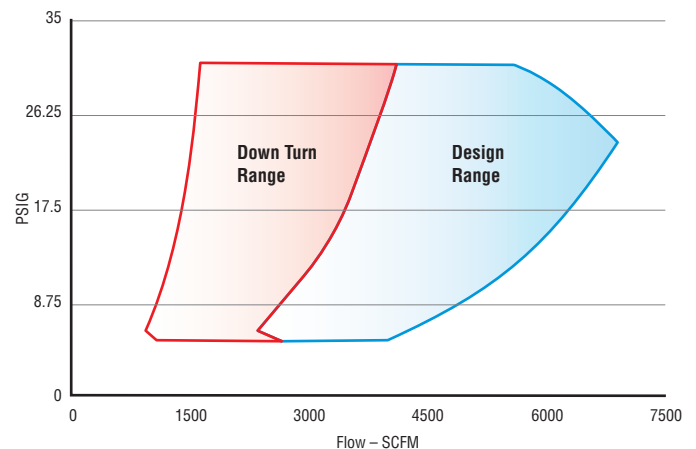

GL3-WX-02

*Custom Available

GL3-WX-02

Motor	A	B	C	Total Weight
75kw	55.1	172.4	110.2	5159 lbs.
90kw	55.1	172.4	110.2	5203 lbs.
110kw	55.1	172.4	110.2	5578 lbs.
132kw	60.2	188.2	126	6030 lbs.
160kw	60.2	188.2	126	6283 lbs.
185kw	60.2	188.2	126	6526 lbs.
200kw	60.2	188.2	126	6548 lbs.
220kw	66.9	192.1	129.9	7970 lbs.
250kw	66.9	192.1	129.9	8080 lbs.
280kw	66.9	192.1	129.9	8477 lbs.
315kw	66.9	192.1	129.9	8499 lbs.

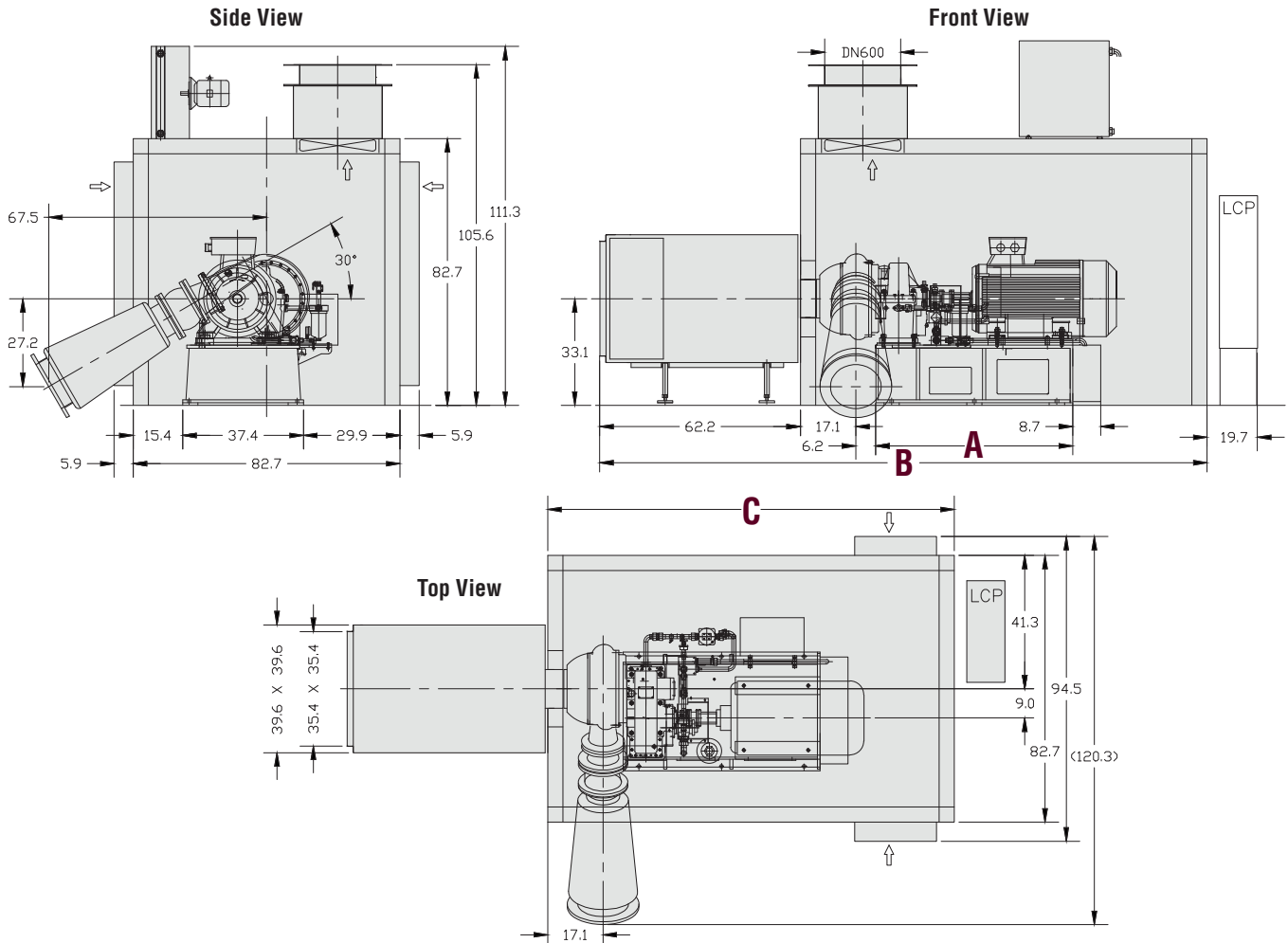

Note: Blower outlet angle is adjustable every 15° radially.
Blower is installed by expansion bolts

Dimensions and specifications may change without notice.



LONE STAR BLOWER

+1 832 532 3112
+1 832 532 3115 Fax
info@lonestarblower.com
www.lonestarblower.com



CUSTOMER PERFORMANCE DATA

Product: Geared Turbo
 Selected Model: GL3

Project: Key West WWTP
 Project Ref: Scenario 2
 Engineer: B&V
 Date: 9/4/18 5:34 PM

		Design					
Units		Duty 1	Alt Flow 1	Alt Flow 2	Alt Flow 3	Alt Flow 4	Alt Flow 5
Volume Flow at Inlet	ICFM	5,264.2	4,718.8	3,911.9	3,645.6	2,591.4	2,329.9
Specified Volume	Delivered SCFM	4,600	4,140	3,450	3,220	2,300	2,070
<i>Specified Flow defined at</i>							
Pressure 14.7 PSIA							
Temperature 68 °F							
Relative Humidity 36 %							
Inlet Temperature	°F	100	100	100	100	100	100
Relative Humidity	%	95	95	95	95	95	95
Barometric Pressure	PSIA	14.69	14.69	14.69	14.69	14.69	14.69
Inlet Pressure Losses	PSIG	0.30	0.30	0.30	0.30	0.30	0.30
Pressure at Inlet	PSIA	14.39	14.39	14.39	14.39	14.39	14.39
Pressure at Discharge	PSIG	9.20	9.20	9.20	9.20	9.20	9.20
Discharge Pressure Losses	PSIG	0.00	0.00	0.00	0.00	0.00	0.00
Total Delta Pressure	PSIG	9.50	9.50	9.50	9.50	9.50	9.50
Temperature at Discharge	°F	208.80	201.79	201.29	201.09	202.92	203.98
Blower Speed	RPM	17870					
Polytropic Eff.	%	80.74%	85.15%	84.65%	84.56%	82.35%	81.41%
Gearbox Input Shaft Power	HP	237.95	201.67	168.64	157.64	116.90	107.04
	kW	177.44	150.38	125.76	117.55	87.17	79.82
Est. Wire to Air	HP	249.68	212.24	178.33	167.07	125.51	115.49
	kW	186.19	158.27	132.98	124.58	93.59	86.12

*The stated blower performance is shaft power measured per ASME PTC10-1997, Heat Balance Method, and stated with a +/- 4% tolerance

P-V Curve & Shaft Power: Duty I : 100F/95%

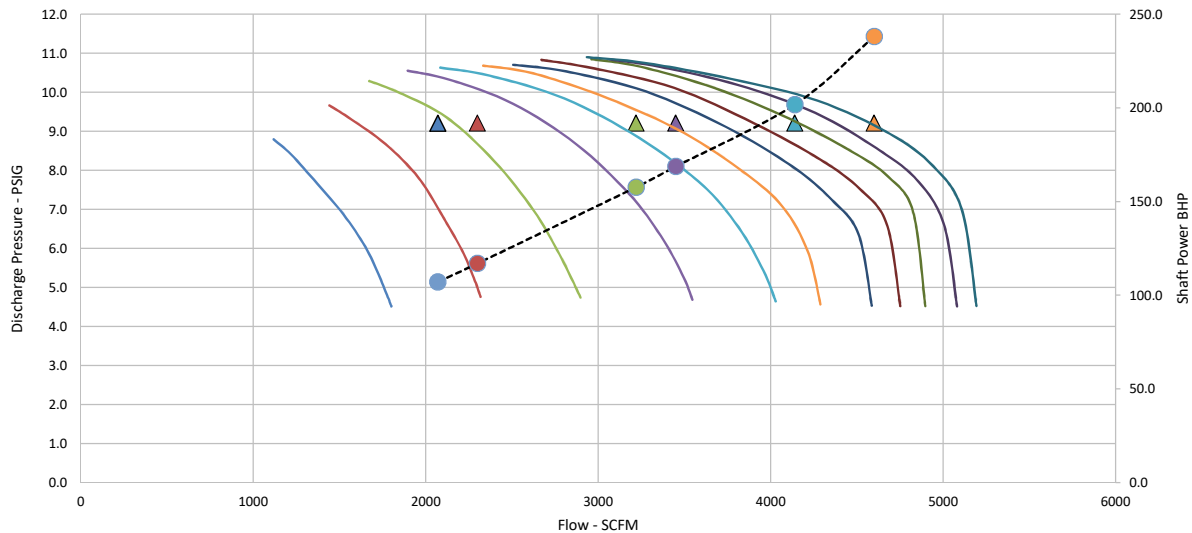



CUSTOMER PERFORMANCE DATA

Product: Geared Turbo
 Selected Model: GL3

Project: Key West WWTP
 Project Ref: Scenario 2
 Engineer: B&V
 Date: 9/4/18 5:34 PM

		Design					
Units		Duty 1	Alt Flow 1	Alt Flow 2	Alt Flow 3	Alt Flow 4	Alt Flow 5
Volume Flow at Inlet	ICFM	4,746.1	4,256.5	3,531.2	3,291.5	2,341.0	2,105.1
Specified Volume	Delivered SCFM	4,600	4,140	3,450	3,220	2,300	2,070
<i>Specified Flow defined at</i>							
	Pressure 14.7 PSIA						
	Temperature 68 °F						
	Relative Humidity 36 %						
Inlet Temperature	°F	70	70	70	70	70	70
Relative Humidity	%	70	70	70	70	70	70
Barometric Pressure	PSIA	14.69	14.69	14.69	14.69	14.69	14.69
Inlet Pressure Losses	PSIG	0.30	0.30	0.30	0.30	0.30	0.30
Pressure at Inlet	PSIA	14.39	14.39	14.39	14.39	14.39	14.39
Pressure at Discharge	PSIG	9.20	9.20	9.20	9.20	9.20	9.20
Discharge Pressure Losses	PSIG	0.00	0.00	0.00	0.00	0.00	0.00
Total Delta Pressure	PSIG	9.50	9.50	9.50	9.50	9.50	9.50
Temperature at Discharge	°F	169.61	169.10	168.66	168.79	171.61	172.30
Blower Speed	RPM	17870					
Polytropic Eff.	%	83.39%	83.19%	82.79%	82.47%	79.67%	79.03%
Gearbox Input Shaft Power	HP	207.72	186.87	156.43	146.74	110.00	100.44
	kW	154.90	139.35	116.65	109.42	82.02	74.90
Est. Wire to Air	HP	218.47	197.02	165.82	155.92	118.49	108.79
	kW	162.92	146.92	123.65	116.27	88.36	81.12

*The stated blower performance is shaft power measured per ASME PTC10-1997, Heat Balance Method, and stated with a +/- 4% tolerance

P-V Curve & Shaft Power: Duty II : 70F/70%

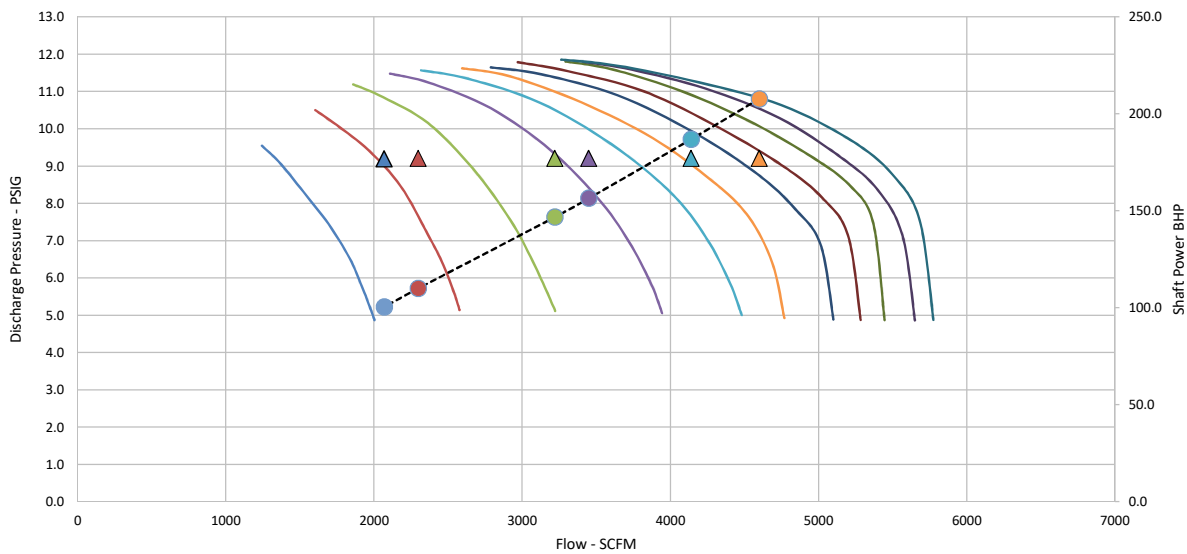



CUSTOMER PERFORMANCE DATA

Product: Geared Turbo
 Selected Model: GL3

Project: Key West WWTP
 Project Ref: Scenario 2
 Engineer: B&V
 Date: 9/4/18 5:34 PM

		Design					
Units		Duty 1	Alt Flow 1	Alt Flow 2	Alt Flow 3	Alt Flow 4	Alt Flow 5
Volume Flow at Inlet	ICFM	4,411.8	3,957.9	3,284.5	3,061.8	2,178.4	1,959.0
Specified Volume	Delivered SCFM	4,600	4,140	3,450	3,220	2,300	2,070
<i>Specified Flow defined at</i>							
Pressure 14.7 PSIA							
Temperature 68 °F							
Relative Humidity 36 %							
Inlet Temperature	°F	40	40	40	40	40	40
Relative Humidity	%	50	50	50	50	50	50
Barometric Pressure	PSIA	14.69	14.69	14.69	14.69	14.69	14.69
Inlet Pressure Losses	PSIG	0.30	0.30	0.30	0.30	0.30	0.30
Pressure at Inlet	PSIA	14.39	14.39	14.39	14.39	14.39	14.39
Pressure at Discharge	PSIG	9.20	9.20	9.20	9.20	9.20	9.20
Discharge Pressure Losses	PSIG	0.00	0.00	0.00	0.00	0.00	0.00
Total Delta Pressure	PSIG	9.50	9.50	9.50	9.50	9.50	9.50
Temperature at Discharge	°F	136.36	136.28	136.17	136.41	139.55	142.21
Blower Speed	RPM	17870					
Polytropic Eff.	%	81.42%	80.96%	80.36%	79.99%	77.05%	75.09%
Gearbox Input Shaft Power	HP	198.28	179.14	150.50	141.34	106.41	98.96
	kW	147.86	133.59	112.23	105.40	79.35	73.80
Est. Wire to Air	HP	208.76	189.09	159.76	150.41	114.85	107.29
	kW	155.67	141.01	119.13	112.16	85.64	80.00

*The stated blower performance is shaft power measured per ASME PTC10-1997, Heat Balance Method, and stated with a +/- 4% tolerance

P-V Curve & Shaft Power: Duty III : 40F/50%

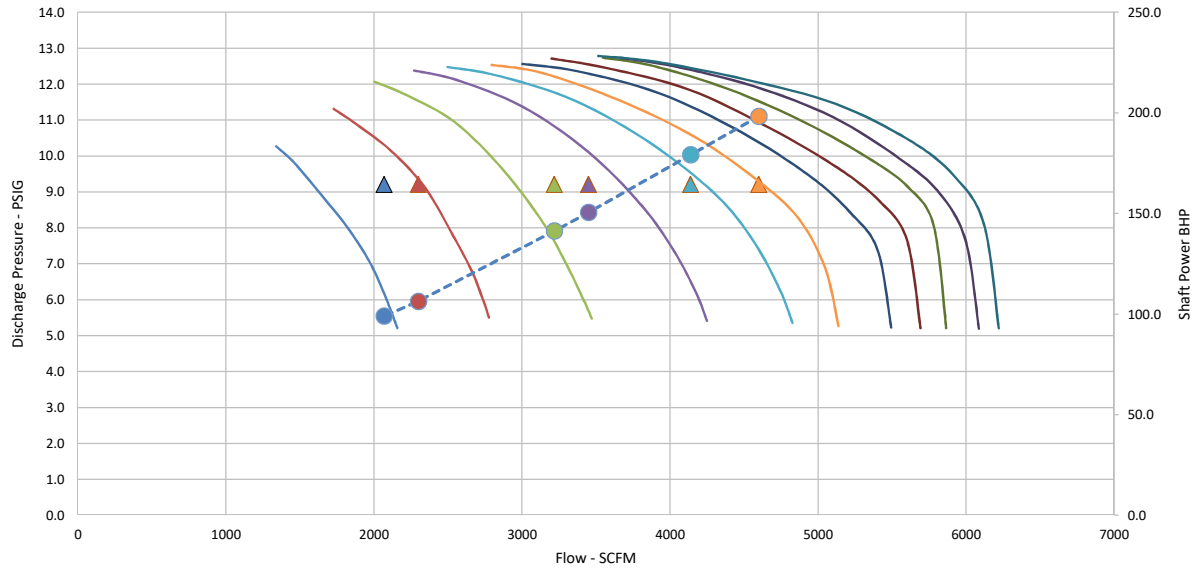

Project: Key West Scenario 2

Quote No: 335491

Date: 09/04/2018

Specification: Inovair Standard Design

Two (2) single-stage IM series stacked centrifugal turbo blowers, accessories, and controls with variable frequency drive (VFD) for variable output capacity control. Each stack consists of two independent modules. Each module is designed for a capacity of 1150 - 1725 SCFM at 9.2 PSIG discharge pressure. This setup will provide the system with three operational modules with continuous flow from 1150 – 5175 SCFM plus one independent redundant module. Each unit is equipped with automatic temperature compensation and automatic speed adjustment for varying liquid levels.

Major Skid Components:

Inovair turbo blower with integral speed increasing gearbox and oil reservoir
2x100 HP TEFC high efficiency electric motor, 480VAC/3ph suitable for VFD drive
Structural steel base
Oil lube system with mechanical pump, oil filter, and air-oil cooler, initial oil fill
Skid mounted instruments
Blow-off (bypass) valve, electric-actuated
Vibration isolation pads
Integral inlet filter

Shipped Loose Components:

Blower Master Control Panel
8" Discharge Check Valve
VFD (NEMA 1) – 100 HP/460VAC/3PH
8" Discharge EPDM Expansion Joint
8" EPDM Manual Butterfly Valve
Oil service pump – (1 total)

Instruments Include:

Inlet mass air flow transmitter
Inlet pressure transducer
Inlet filter differential pressure switch
Oil temperature sensor
Low oil pressure switch
Oil pressure gauge
Discharge pressure gauge
Discharge pressure transducer

Control Panel:

Each blower unit will come with a NEMA 4 Local control panel with a machine level controller. Panel door mounted items include operator interface monitor (HMI) and shutdown button. A separate 120/60/1 15 amp power supply is required.

Paint:

Manufacturer's standard powder coat finish.

Start-up Service:

Two days (1 trip) of start-up and operator training is included. Additional service is available at \$1,500 per day plus travel and living expenses billed at cost, plus 10%. Advance notification of 10 working days is required for scheduling.

Factory Test (Non-witnessed):

Factory Performance Test – air-end/gearbox
Functional Control Panel System Test
Mechanical Run Test
Motor Routine Test

Drawings and Shipment:

Standard submittal for information only will be in 3 weeks after acceptance of the order by Inovair. If required additional submittal information to Inovair standards will follow within a reasonable time. Delivery is estimated to be 14-16 weeks after order acceptance by Inovair.

Payment Terms: Terms of invoiced values below, without deduction, are to be paid within 30 days after invoice date. Payment shall not be dependent on the Contractor or Manufacturer's Representative being paid by any third parties. Under no circumstances will payment be dependent on acceptance of the equipment by the Owner.

Approval of Submittal: 20% of total

Delivery to Jobsite: 70% of total

Completion of Equipment Commissioning: 10% of total

Items Not Included:

Installation, anchor bolts, interconnecting pipe, fittings, bolts, nuts, gaskets, wiring, valves, oil and lubricants, or any other items not specifically listed above.

Optional Items (Not Included in Quote):

Notes:

Price: \$286,161 (Two Hundred Eighty Six Thousand One Hundred Sixty One Dollars)

F.O.B. factory, estimated freight to the jobsite is \$3000 per stacked blower, not included in the quotation.

This proposal is firm for 90 days.

Quoted by:

Nate Neufeld
Sales Manager
Inovair
14801 W. 114th Terrace
Lenexa, KS 66215
Office: 913-469-7259
Cell: 913-953-7078

Warranty:

Inovair turbo blower and accompanying manufactured components are warranted to be free from defects in materials and workmanship for a period of twenty-four (24) months, commencing at the time the blower system is placed into service, but in no event are these manufactured components to be warranted for longer than thirty (30) months from date of shipment. Electrical and other purchased components (supplied by other manufacturers) are warranted in accordance to those stated warranty policies, and are not eligible under this warranty.

The replacement or repair of parts normally consumed in service such as oil, grease, belts, etc. is considered part of routine maintenance and upkeep and such parts are not eligible for repair or exchange free of charge under this warranty.

During the warranty period, if any warranted part is defective or fails to perform as specified when operating at design conditions and if the blower system has been environmentally and physically protected prior to start-up and has been installed, operated and maintained all in accordance with the written instructions provided, exchange free of charge a replacement for such defective part. Defective parts must be returned by the owner postage paid. This limited warranty coverage is extended only to the original owner. IF THE BLOWER DRIVE RATIO IS ALTERED IN ANY WAY WITHOUT FACTORY APPROVAL, WARRANTY COVERAGE IS VOID. USE OF ANY PULLEY NOT MANUFACTURED OR SUPPLIED BY BLOWER MANUFACTURER VOIDS ALL WARRANTY COVERAGE. Disassembly of blower or removal of the blower serial plate voids all warranties. Claims for freight damages should be directed to the freight company.

NO OTHER WARRANTY EXPRESSED OR IMPLIED and SPECIFICALLY DISCLAIMS ANY IMPLIED WARRANTY AS TO THE MERCHANTABILITY OF THE BLOWER SYSTEM OR AS TO ITS FITNESS FOR ANY PARTICULAR PURPOSE. Blower manufacturer is not responsible for consequential or incidental damages of any nature resulting from such things as, but not limited to, defects in design, material, workmanship, or delays in delivery of blower, availability of replacements or repairs.

The waiver or abridgement of any single provision or group of provisions, either by ruling or agreement, shall not be construed to alter or void any other provisions of this warranty.

IᅀOVAIR TERMS AND CONDITIONS

TERMS OF SALE

The sale of products and services ("Products") by Accessible Technologies, Inc. and its divisions, subsidiaries, and affiliates ("Iᅀovair") are subject to these terms and conditions ("Agreement") regardless of other or additional terms or conditions that conflict with or contradict this Agreement in any purchase order, document, or other communication ("Order"). Preprinted terms and conditions on any document of customer ("Customer") (for example: Orders or confirmations) and/or Iᅀovair's failure to object to conflicting or additional terms will not change or add to the terms of this Agreement.

1. ORDERS. Quotes from Iᅀovair are invitations to tender and are subject to change at any time without notice. All Orders are subject to acceptance by Iᅀovair. Contracts between Customer and Iᅀovair are formed upon Iᅀovair's written acceptance or execution of Customer's Order and shall be subject to this Agreement. All Orders including, but not limited to, Electronic Purchase Orders, for Products identified by Iᅀovair as non-standard, are non-cancelable, non-returnable. Iᅀovair may identify Products as non-standard by various means including, but not limited to, quotes, Scope of Services, Products lists, attachments or exhibits. Customer may not change, cancel or reschedule Orders for standard Products without Iᅀovair's consent. Iᅀovair reserves the right to allocate the sale of Products among its Customers.

2. PRICES. Prices are subject to change at any time. Prices are for Products only and do not include taxes, shipping charges, freight, duties, and other charges or fees, such as fees for special packaging and labeling of the Products, permits, certificates, customs declarations and registration (collectively, "Additional Fees"). Customer is responsible for any Additional Fees.

3. TERMS OF PAYMENT. Terms of invoiced values, without deduction, are to be paid within 30 days after invoice date. Payment shall not be dependent on the Contractor or Manufacturer's Representative being paid by any third parties. Under no circumstances will payment be dependent on acceptance of the equipment by the Owner.

Approval of Submittal: 20% of total

Delivery to Jobsite: 70% of total

Completion of Equipment Commissioning: 10% of total

Total invoice amount is due no later than 30 days following equipment start-up or 60 days after shipment, whichever occurs first. Payment shall not be dependent on the Contractor or Manufacturer's Representative being paid by any third parties. Under no circumstances will payment be dependent on acceptance of the equipment by the Owner. Any other payment terms must be approved in writing by Iᅀovair. On any past due invoice, Iᅀovair may charge (i) interest from the payment due date to the date of payment at 12% per annum, plus reasonable attorney fees and collection costs; or (ii) the maximum amount that is allowed under the applicable law if Iᅀovair's interest rate is deemed invalid. At any time, Iᅀovair may change the terms of Customer's credit, require financial data from Customer for verification of Customer's creditworthiness, require a bank guarantee or other security, or suspend any outstanding Orders of Customer. Iᅀovair may apply payments to any of Customer's accounts. If Customer defaults on any payment under this Agreement, Iᅀovair may reschedule or cancel any outstanding delivery and declare all outstanding invoices due and payable immediately. Unless otherwise provided by applicable law, any credit issued by Iᅀovair to Customer in respect of any of Customer's accounts will expire if unused for twelve (12) months following the date of issuance of such credit.

4. DELIVERY AND TITLE. Unless otherwise specified by Iᅀovair in writing, all deliveries by Iᅀovair are EXW Iᅀovair's warehouse (INCOTERMS 2013). Title shall pass to Customer upon delivery of the Products to the carrier. Iᅀovair's delivery dates are estimates only and subject to timely receipt of supplies by Iᅀovair. Iᅀovair is not liable for delays in delivery. Iᅀovair reserves the right to make partial deliveries and Customer will accept delivery and pay for the Products delivered. A delayed delivery of any part of an Order does not entitle Customer to cancel other deliveries.

5. IᅀOVAIR'S LIMITED WARRANTY. See included statement of warranty.

6. PRODUCT RETURN Customer may return Products to Iᅀovair only with a return material authorization ("RMA") number issued by Iᅀovair. Customer must notify Iᅀovair in writing of any damage to the outer packaging or the Products, shortage, or other discrepancy ("Visual Defect") within 3 days after receipt of the shipment; otherwise, Customer is deemed to have accepted the Products and may not revoke acceptance. RMAs will be issued only for Visual Defects created solely by Iᅀovair, and only if Customer satisfies the notice requirement. RMAs will not be granted for damage, shortage, or other discrepancy created by Customer, the carrier or freight provider, or any other third party. Product return pursuant to a warranty requires written notice from Customer to Iᅀovair within the warranty period detailing the Product defect. Customer must return the Products to Iᅀovair freight prepaid in original manufacturer's shipping cartons or equivalent, along with acceptable proof of purchase, within the warranty period and as specified in the RMA. At Iᅀovair's discretion, Iᅀovair will return all Products not eligible for return to Customer, freight collect, or hold Product for Customer's account at Customer's expense.

7. LIMITATION OF LIABILITY. To the extent permitted by law, neither Iqovair nor its employees or agents are liable for and Customer is not entitled to any indirect, special, incidental or consequential damages (for example, loss of profits or revenue, loss of data, loss of use, rework, manufacturing expense, injury to reputation, or loss of Customers). To the extent permitted by applicable law, Customer's recovery from Iqovair for any direct damages will not exceed the price of the Product at issue. To the extent the preceding limitation of liability is deemed invalid under applicable law, Iqovair's total liability in any event will not exceed USD 50,000 or the equivalent thereof. Customer will indemnify, defend and hold Iqovair harmless from any claims based on: (i) Iqovair's compliance with Customer's designs, specifications, or instructions, (ii) modification of any Product by anyone other than Iqovair, or (iii) use of Products in combination with other products or in violation of clause 9 below.

8. FORCES BEYOND IQOVAIR'S CONTROL. Iqovair is not liable for failure to fulfill its obligations under this Agreement due to causes beyond its reasonable control (for example: acts of nature, acts or omissions of the Customer, operational disruptions, man-made or natural disasters, epidemic medical crises, materials shortages, strikes, criminal acts, delays in delivery or transportation, or inability to obtain labor or materials through its regular sources).

9. USE OF PRODUCTS. Customer shall comply with the manufacturer's or supplier's Product specifications. Products are not authorized for use in critical safety or other applications where a failure may reasonably be expected to result in personal injury, loss of life, or serious property damage. If Customer uses or sells the Products for use in any such applications or fails to comply with the manufacturer's Product specifications, Customer acknowledges that such use, sale, or non-compliance is at Customer's sole risk.

10. EXPORT/IMPORT. Certain Products and related technology and documentation sold by Iqovair are subject to export control laws, regulations and orders of the United States, the European Union, and/or other countries ("Export Laws"). The Customer shall comply with such Export Laws and obtain any license, permit or authorization required to transfer, sell, export, re-export or import the Products and related technology and documentation.

The Customer will not export or re-export the Products and related technology and documentation to any country or entity to which such export or re-export is prohibited, including any country or entity under sanction or embargoes administered by the United Nations, U.S. Department of Treasury, U.S. Department of Commerce or U.S. Department of State. The Customer will not use the Products and related technology and documentation in relation to nuclear, biological or chemical weapons or missile systems capable of delivering same, or in the development of any weapons of mass destruction.

11. PRODUCT INFORMATION. Product information (for example, statements or advice (technical or otherwise) advertisement content, and information related to a Product's specifications, features, export/import control classifications, uses or conformance with legal or other requirements) is provided by Iqovair on an "AS IS" basis and does not form a part of the properties of the Product. Iqovair makes no representation as to the accuracy or completeness of the Product information, and DISCLAIMS ALL REPRESENTATIONS, WARRANTIES AND LIABILITIES UNDER ANY THEORY WITH RESPECT TO THE PRODUCT INFORMATION. Iqovair recommends Customer validate any Product Information before using or acting on such information. All Product information is subject to change without notice. Iqovair is not responsible for typographical or other errors or omissions in Product information.

12. GOVERNMENT CONTRACTS. Iqovair is a distributor of "Commercial Items" as defined in FAR 2.101. Iqovair agrees only to the clauses in the Federal Acquisition Regulation ("FAR") and Defense Federal Acquisition Regulation ("DFAR") that are required to be inserted in subcontracts for commercial items as set forth in FAR 52.244-6(c)(1), FAR 52.212-5(e)(1), and DFAR 252.244-7000 if it is a subcontract under a Department of Defense prime contract. In accordance with FAR 12.211, Customer will receive only those rights in technical data customarily provided to Iqovair by the manufacturers. By no means will this be interpreted as providing to Customer unlimited rights in data, software, or intellectual property rights provided by the manufacturers or any other third party. Iqovair specifically rejects the flow down of the requirements of the: (i) Trade Agreements Act, FAR 52.225-5 or DFARS 252.225-7021; (ii) the Buy American Act, FAR 52.225-1 or DFARS 252.225-7001; and (iii) any Preference for Domestic Specialty Metals regulation.

13. ELECTRONIC ORDERS. In the event that any part of the purchase and sale of Products, including Customer's acknowledgment, utilizes electronic data interchange, Customer's internal portal or third party portal, or any other electronic means ("Electronic Purchase Order"), this Agreement will continue to apply to the purchase and sale of Products between Customer and Iqovair. Customer's acceptance of Iqovair's acknowledgment request or Iqovair's specification of details with respect to Electronic Purchase Orders via writing, email or other electronic data interchange shall be binding on Customer.

14. GENERAL.

A. This Agreement shall be governed, construed, and enforced in accordance with the laws of the country where the Iqovair entity that accepted Customer's Order ("Governing Country") is located. The courts of the Governing Country shall have jurisdiction and venue over all controversies arising out of, or relating to, this Agreement. If the Governing Country is the United States of America, the laws and courts of the State of Kansas will apply without reference to Kansas' conflict of laws principles. The United Nations Convention for the International Sale of Goods shall not apply.

B. Customer may not assign this Agreement without the prior written consent of Iqovair, and Iqovair's affiliates may perform Iqovair's obligations under this Agreement. This Agreement is binding on successors and assigns.

C. This Agreement can only be modified in writing signed by authorized representatives of both Iqovair and Customer.

D. Iqovair and Customer are independent contractors and agree that this Agreement does not establish a joint venture,

agency relationship, or partnership.

E. Inovair's failure to object to any document, communication, or act of Customer will not be deemed a waiver of any of these terms and conditions.

F. The unenforceability of any of these terms or conditions will not affect the remainder of the terms or conditions.

G. Products, including software or other intellectual property, are subject to any applicable rights of third parties, such as patents, copyrights and/or user licenses, and Customer will comply with such rights.

H. Customer and Inovair will comply with applicable laws and regulations.

I. The parties agree to use electronic signatures and agree that any electronic signatures will be legally valid, effective, and enforceable.



Project: Key West FL - Scenario 2
Aero Stage: IF2-23-140
Altitude (ft): 10

Flow (scfm)	Pressure (psig)	Temp (F)	RH (%)	Shaft HP (hp)
1725	9.20	100	95%	94.4
1533	9.20	100	95%	80.7
1150	9.20	100	95%	58.8
1725	9.20	40	50%	76.9
1533	9.20	40	50%	66.7
1150	9.20	40	50%	49.9

HP bases on +/- 5% tolerance

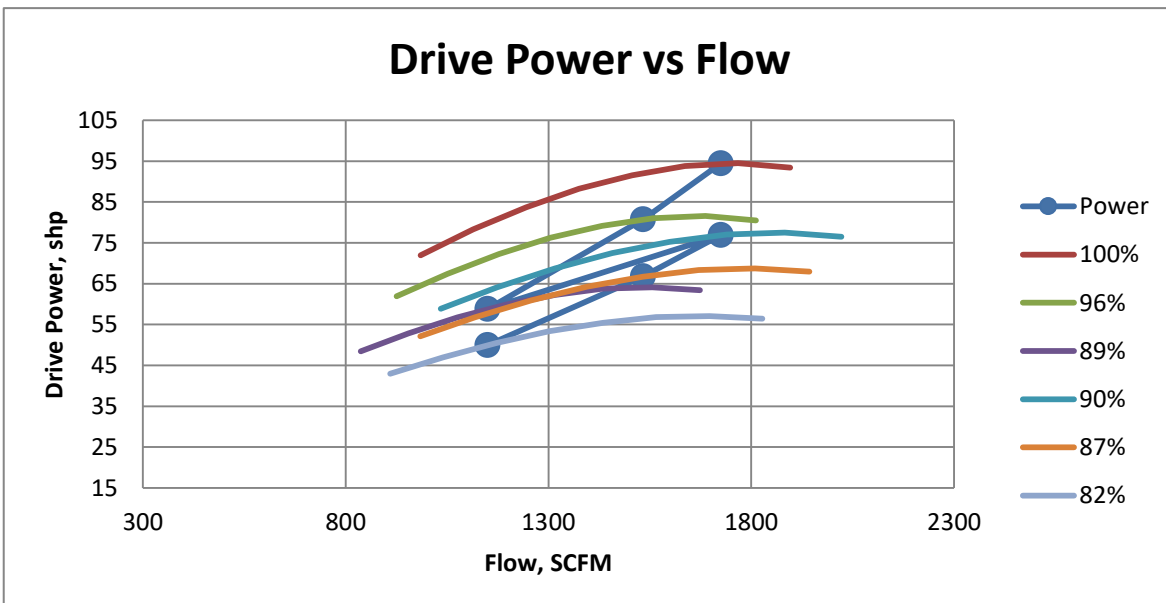
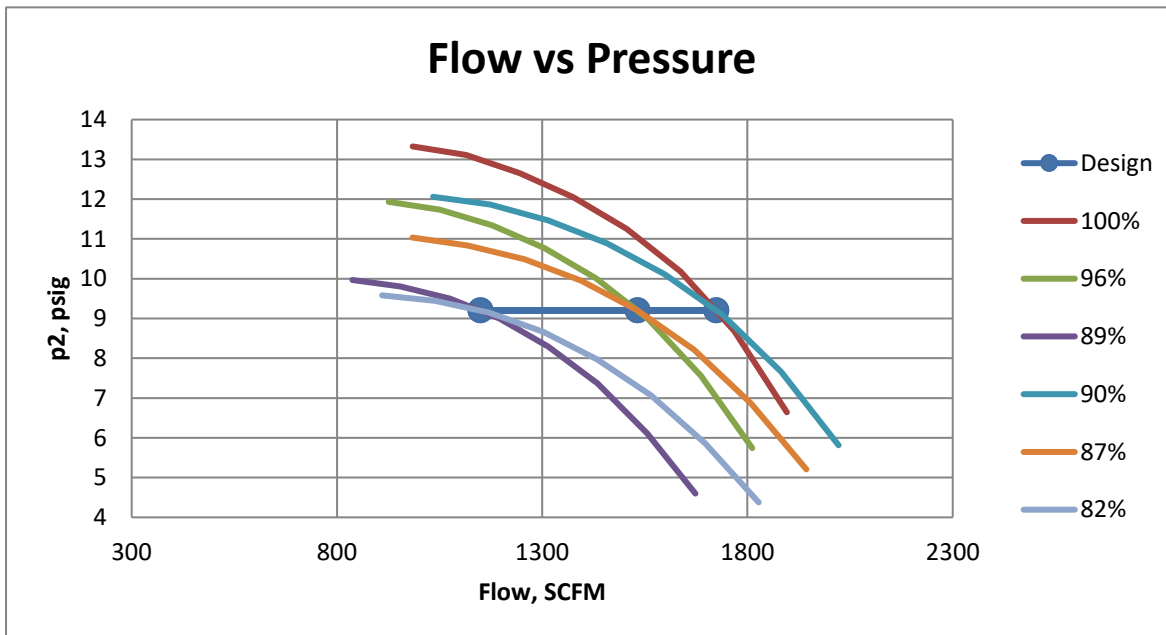

REVISIONS				
REV.	DESCRIPTION	ECO	DATE	ENG
C	UPDATED PERIMETER ACCESS NOTE	---	9/21/2016	RLJ
D	SHORTENED MAIN FRAME 1FT	---	4/12/2017	RLJ

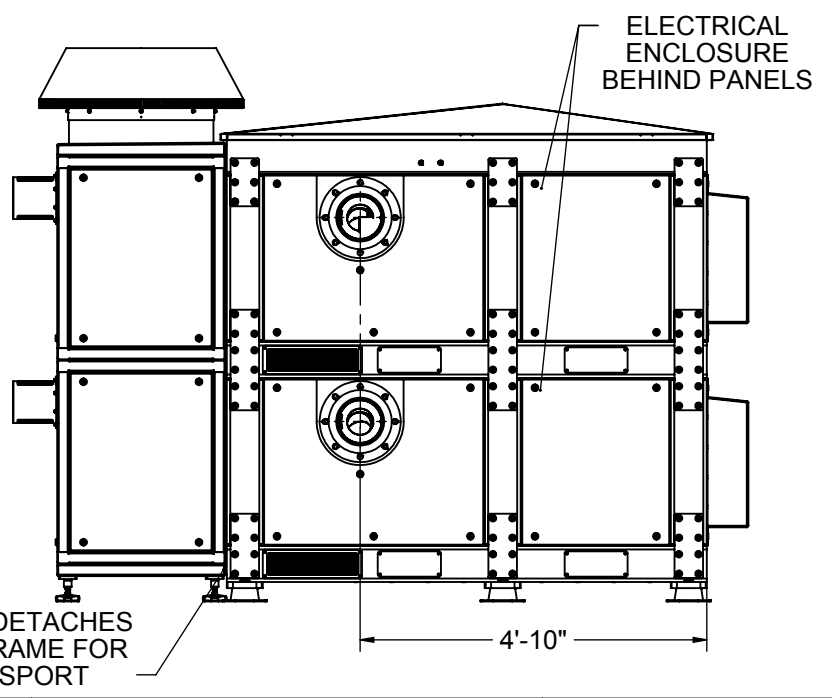
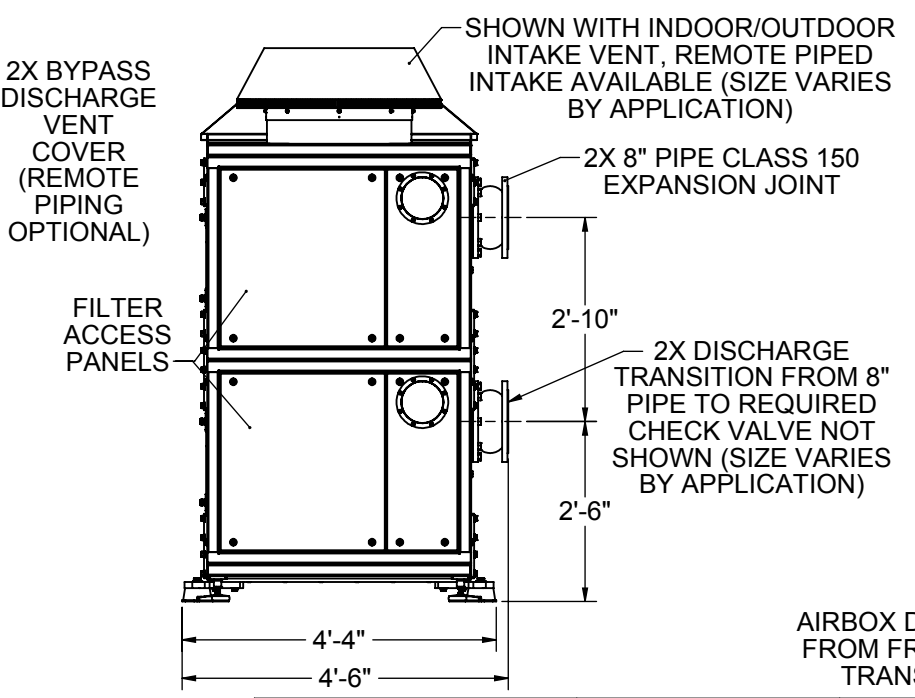
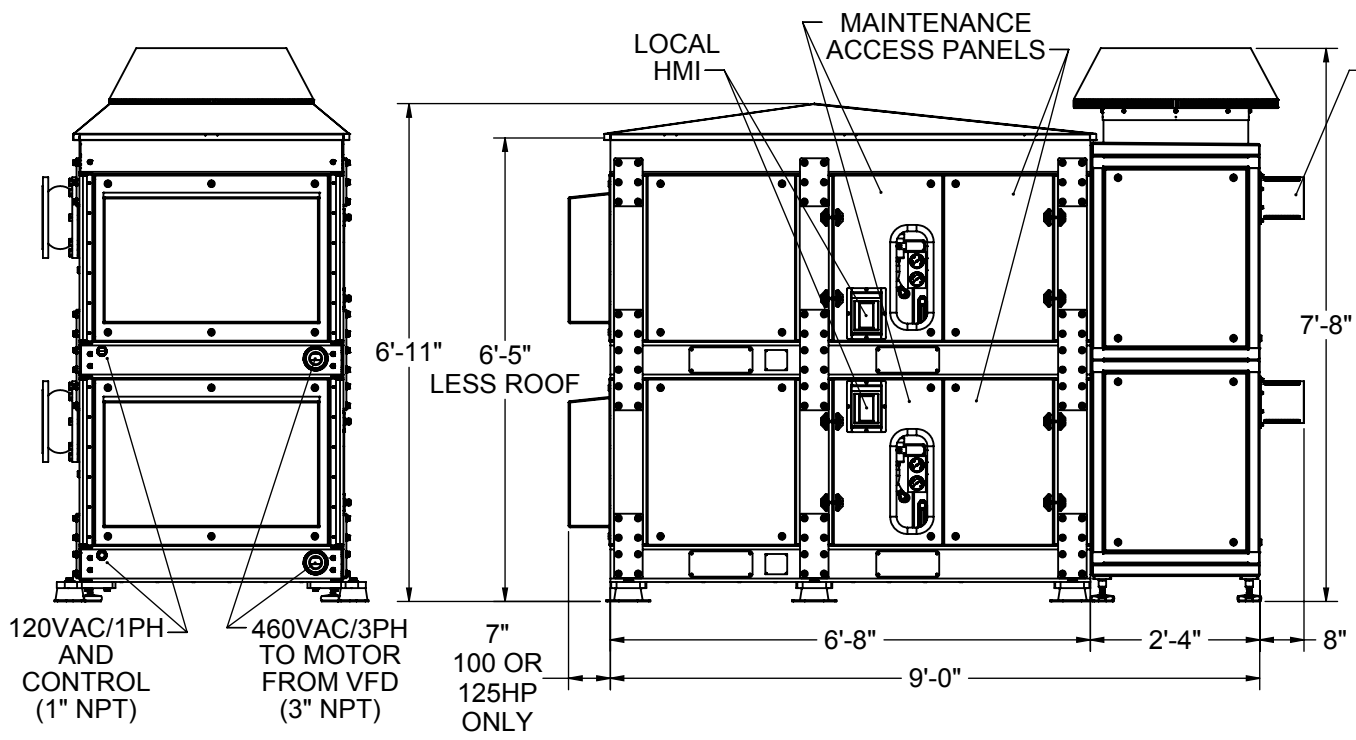
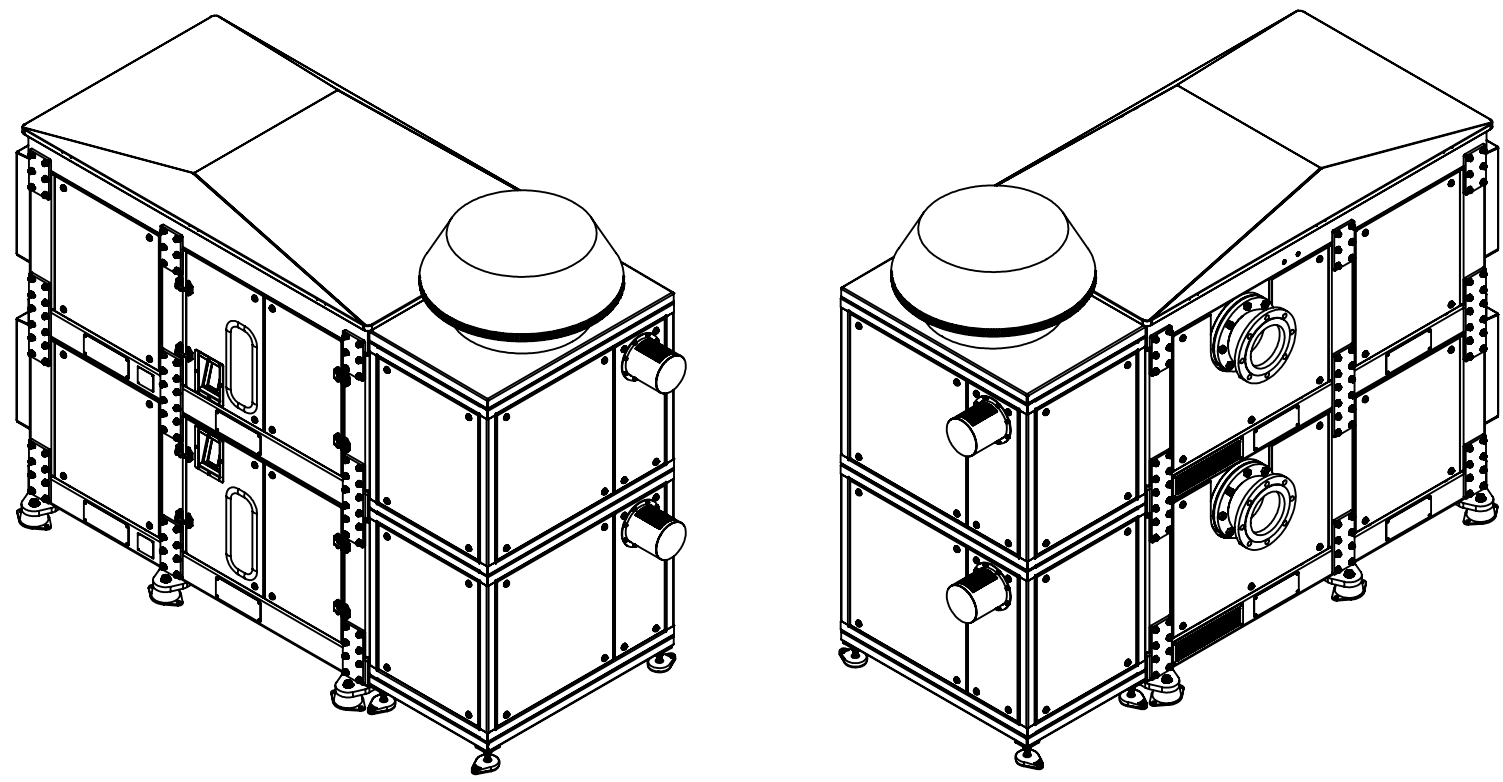
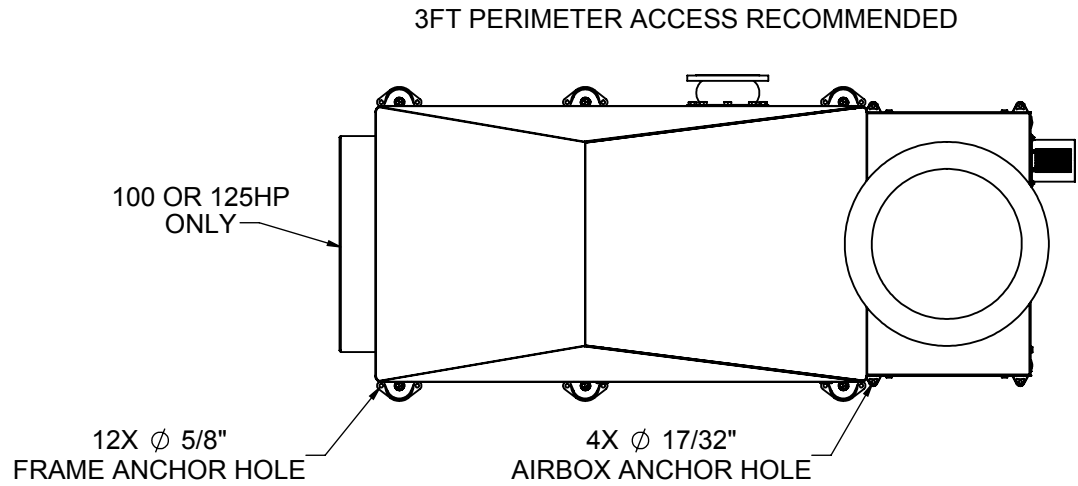

- NOTES:
- FOR INITIAL SALES/PLANNING PURPOSES ONLY
 - DETAILED LAYOUT TO BE PROVIDED WITH SUBMITTAL
 - 460VAC/3PH WIRING FROM VFD TO MOTOR IS REQUIRED TO BE EITHER SEPARATE CONDUITS OR SHIELDED CABLE IF COMBINED
 - 120VAC/1PH AND CONTROL MAY BE COMBINED

PROPRIETARY AND CONFIDENTIAL THE INFORMATION CONTAINED IN THIS DRAWING IS THE SOLE PROPERTY OF ACCESSIBLE TECHNOLOGIES. ANY REPRODUCTION IN PART OR AS A WHOLE WITHOUT THE WRITTEN PERMISSION OF ACCESSIBLE TECHNOLOGIES IS PROHIBITED.	ALL UNITS ARE INCHES UNLESS OTHERWISE SPECIFIED TOLERANCES UNLESS OTHERWISE SPECIFIED: 1 PLACE DECIMAL \pm 0.060 2 PLACE DECIMAL \pm 0.040 3 PLACE DECIMAL \pm 0.020 FRACTIONAL < 1" \pm 1/32 FRACTIONAL \geq 1" \pm 1/16 ANGULAR \pm 0.5	DWG. SIZE: B		Accessible Technologies 14801 W 114th Terr. Lenexa, KS 66215 PH: 913-338-2886 FAX: 913-338-2879	
	DESCRIPTION: IM SERIES 60-125HP STACKED UNITS	PART #: IM SERIES STACKED SALES LAYOUT FINISH: MATERIAL:	ENGINEER: RLJ SCALE: 1:32	CHECKED: -- DATE: 3/24/2016	DRAWN: RLJ SHEET 1 OF 1 REV: D

McGonigle, Miles

From: Torres, Hector R.
Sent: Wednesday, September 19, 2018 15:56
To: Torres, Hector R.
Subject: FW: Key West WWTP - Blower Eval - DryScrew Universal Blower PAC

From: Andrew Placek <aplacek@universalblowerpac.com>
Sent: Wednesday, September 05, 2018 8:58 AM
To: Torres, Hector R. <TorresHR@bv.com>
Subject: RE: Key West WWTP - Blower Eval - DryScrew Universal Blower PAC

Hector,

Curves attached. We'll want to direct drive these for 5% more efficiency. Turndown is as indicated; we'll have the entire range available below max flow. I have the following estimates:

Scenario:
2 x 250HP Screw Blowers \$256,000
2 x 250HP NEMA 12 VFD \$59,000
Upgrade to NEMA 4XSS VFD \$25,000

Costs include standard B&V requirements, freight, and startup. Let me know if you need anything else.

Sincerely,

Andrew Placek, P.E.
Director of Sales and Marketing

P: 317-773-7256 X4512
C: 317-690-0963



CycloBlower H.E. - 250CDL750 RC1 Low Compression DSL

Product Information

CORRECTED VALUES	ORIGINAL UNITS	ENGLISH UNITS	METRIC UNITS
Ambient Pressure	14.7 PSIA	14.700 PSIA	1.014 bar a
Elevation	-7 ALTI-FT	-7 ALTI-FT	-2 alti-m
Inlet Pressure	14.7 PSIA	0 PSIG	0 bar g
Inlet Pressure Loss	.4 PSIG	0.400 PSIG	0.028 bar g
Inlet Temp	100 F	100 °F	38 °C
Inlet Flow	3450 SCFM	3980 ICFM	6762 m³/h
Discharge Pressure	9.2 PSIG	9.200 PSIG	0.634 bar g
Discharge Pressure Loss	0 PSIG	0.000 PSIG	0 bar g

MEASURED VALUES	ORIGINAL UNITS	ENGLISH UNITS	METRIC UNITS
Speed	1586 RPM	1586 RPM	1586 RPM
RPM % Of Max	72	72	72
Power	178.9 HP	178.9 HP	133.406 kW
Discharge Temp	206 °F	206 °F	97 °C
Temp % of Max	59	59	59
Noise	dBa	dBa	dBa
Pressure % of Max	53	53	53
Adiabatic Efficiency	76.78%	76.78%	76.78%



PHYSICAL

Weight	3500 lbs.
Gear Diameter / Center Distance	in.
Connection Size	in.
Case Length	in.
WR ²	lb-ft ²
Orientation	horizontal

PERFORMANCE

Max Delta P	18 PSI
Max Temp	350 °F
Max Speed	2200 RPM
Min Speed	500 RPM
Max Case Pressure	40 PSIG
Max Delta T	250 °F

AMBIENT GAS PARAMETERS	ENGLISH UNITS	METRIC UNITS	GAS MIX:	VOL
Molecular Weight	28.282 lbm/lbmol	28.282 kg/kgmol	Air	100%
R Value	54.628 ft. lbf/lbm.R	0.294 kJ/kg.K		
Density	0.069 lbm/ft ³	1.109 kg/m ³		

Performance Curves

Temperature Rise

DEFINED CONDITIONS

106 F

RPM

1586

Published Data
Defined Conditions

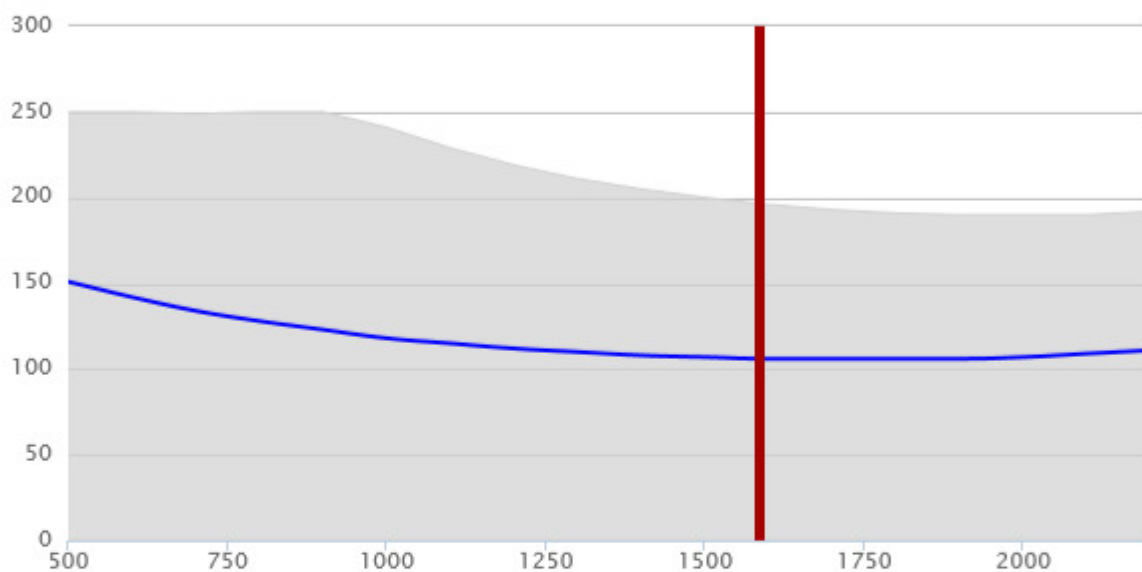

Flow

DEFINED CONDITIONS

3451 SCFM

RPM

1586

Published Data
Defined Conditions

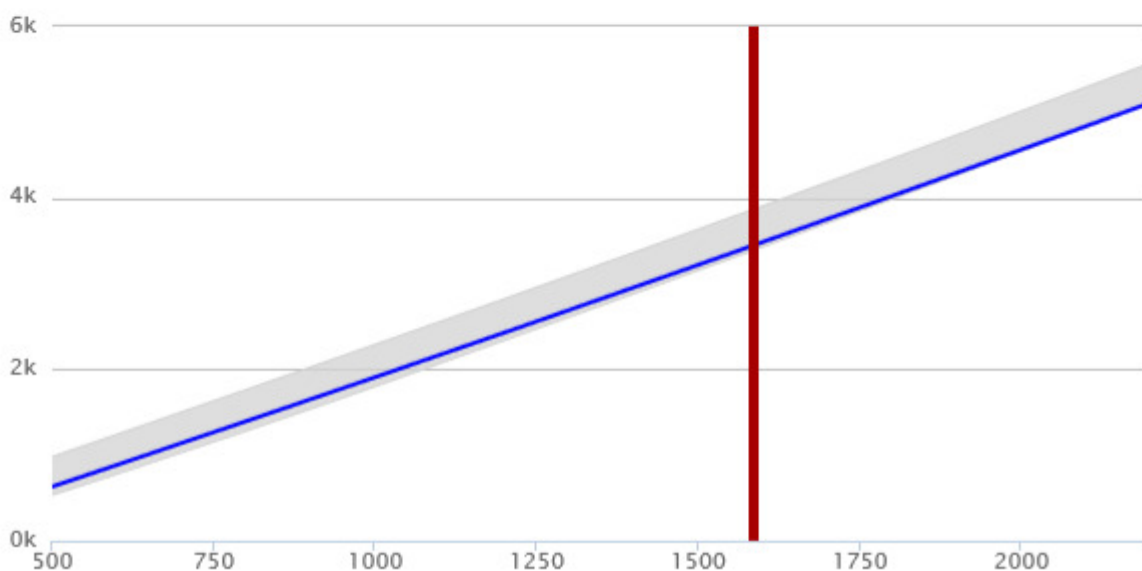

Performance Curves

Power

DEFINED CONDITIONS

178.9 HP

RPM

1586

Published Data

Defined Conditions

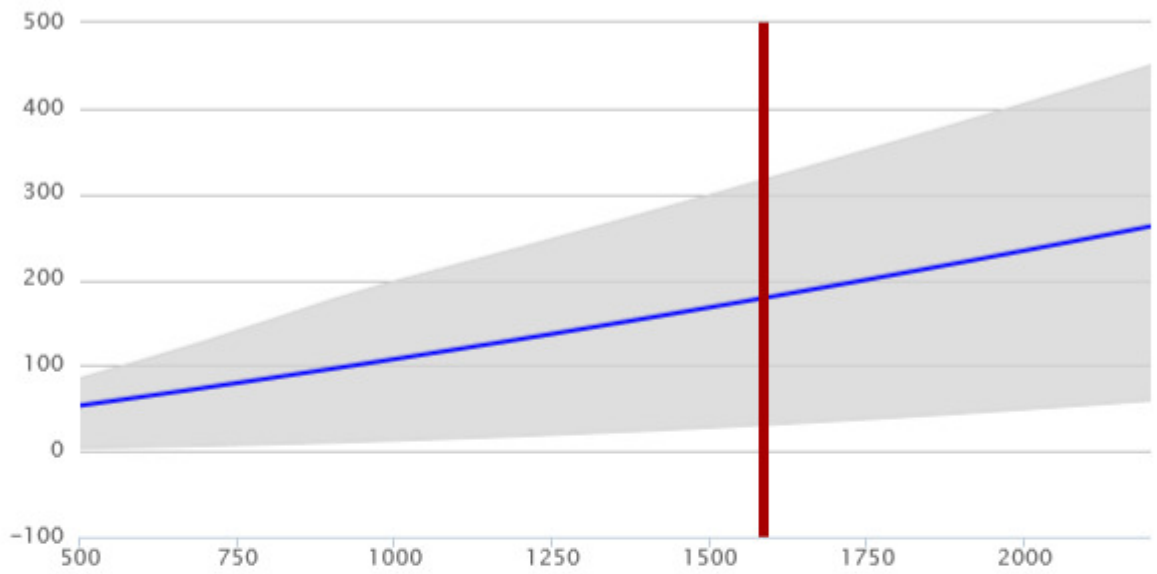

Torque

DEFINED CONDITIONS

592.5 ft-lb

RPM

1586

Published Data

Defined Conditions

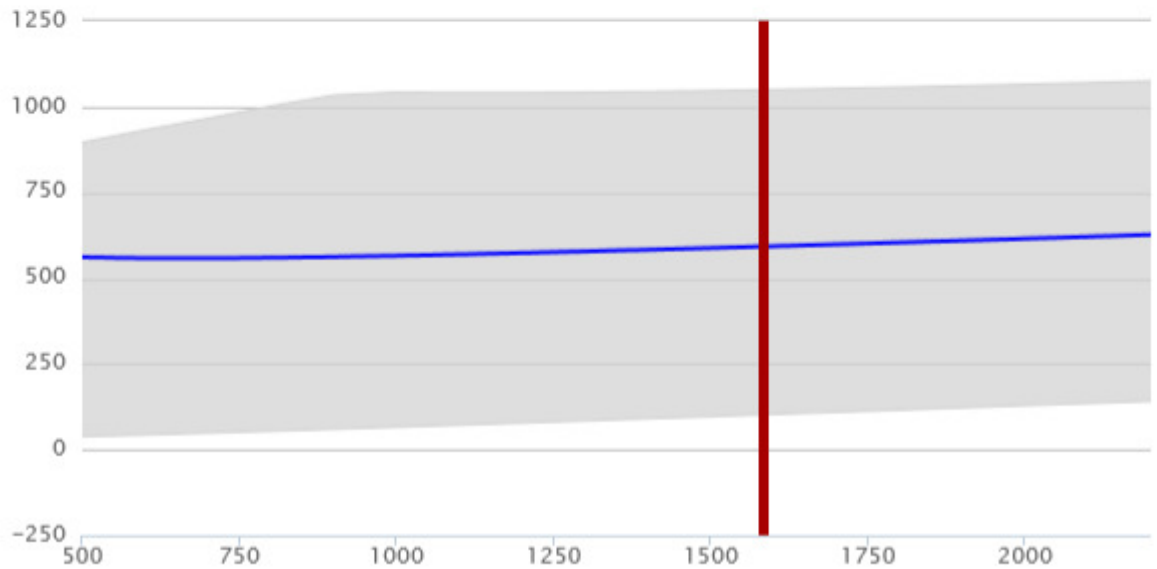

CycloBlower H.E. - 250CDL750 RC1 Low Compression DSL

Product Information

CORRECTED VALUES	ORIGINAL UNITS	ENGLISH UNITS	METRIC UNITS
Ambient Pressure	14.7 PSIA	14.700 PSIA	1.014 bar a
Elevation	-7 ALTI-FT	-7 ALTI-FT	-2 alti-m
Inlet Pressure	14.7 PSIA	0 PSIG	0 bar g
Inlet Pressure Loss	.4 PSIG	0.400 PSIG	0.028 bar g
Inlet Temp	40 F	40 °F	4 °C
Inlet Flow	3450 SCFM	3344 ICFM	5681 m³/h
Discharge Pressure	9.2 PSIG	9.200 PSIG	0.634 bar g
Discharge Pressure Loss	0 PSIG	0.000 PSIG	0 bar g

MEASURED VALUES	ORIGINAL UNITS	ENGLISH UNITS	METRIC UNITS
Speed	1378 RPM	1378 RPM	1378 RPM
RPM % Of Max	63	63	63
Power	152.7 HP	152.7 HP	113.868 kW
Discharge Temp	137 °F	137 °F	58 °C
Temp % of Max	39	39	39
Noise	dBa	dBa	dBa
Pressure % of Max	53	53	53
Adiabatic Efficiency	75.27%	75.27%	75.27%



PHYSICAL

Weight	3500 lbs.
Gear Diameter / Center Distance	in.
Connection Size	in.
Case Length	in.
WR ²	lb-ft ²
Orientation	horizontal

PERFORMANCE

Max Delta P	18 PSI
Max Temp	350 °F
Max Speed	2200 RPM
Min Speed	500 RPM
Max Case Pressure	40 PSIG
Max Delta T	250 °F

AMBIENT GAS PARAMETERS	ENGLISH UNITS	METRIC UNITS	GAS MIX:	VOL
Molecular Weight	28.912 lbm/lbmol	28.912 kg/kgmol	Air	100%
R Value	53.438 ft. lbf/lbm.R	0.287 kJ/kg.K		
Density	0.079 lbm/ft ³	1.270 kg/m ³		

Performance Curves

Temperature Rise

DEFINED CONDITIONS

97 F

RPM

1378

Published Data
Defined Conditions

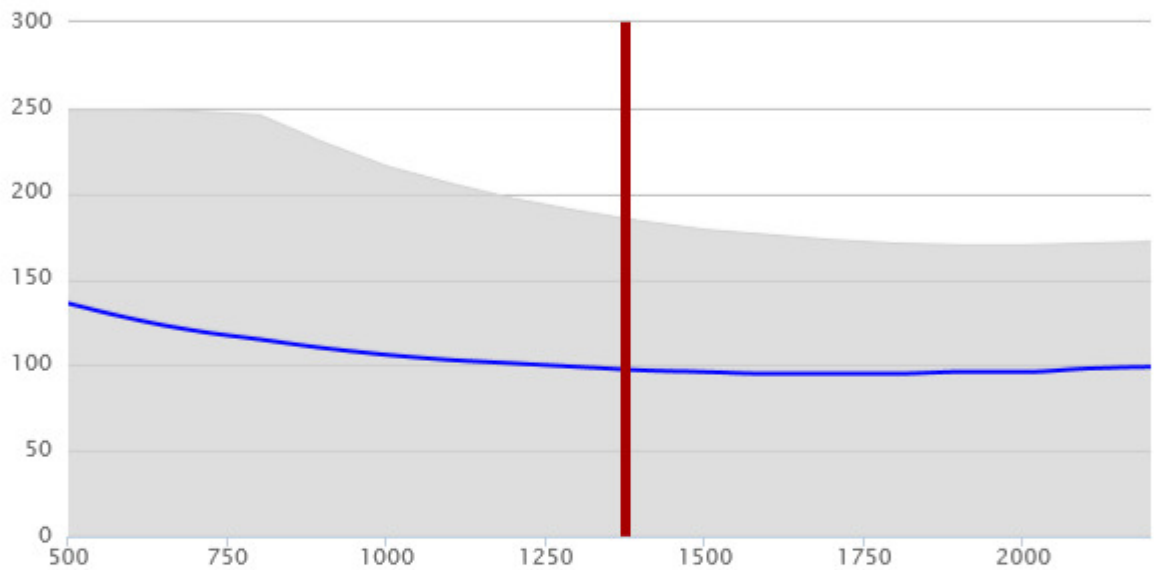

Flow

DEFINED CONDITIONS

3449 SCFM

RPM

1378

Published Data
Defined Conditions

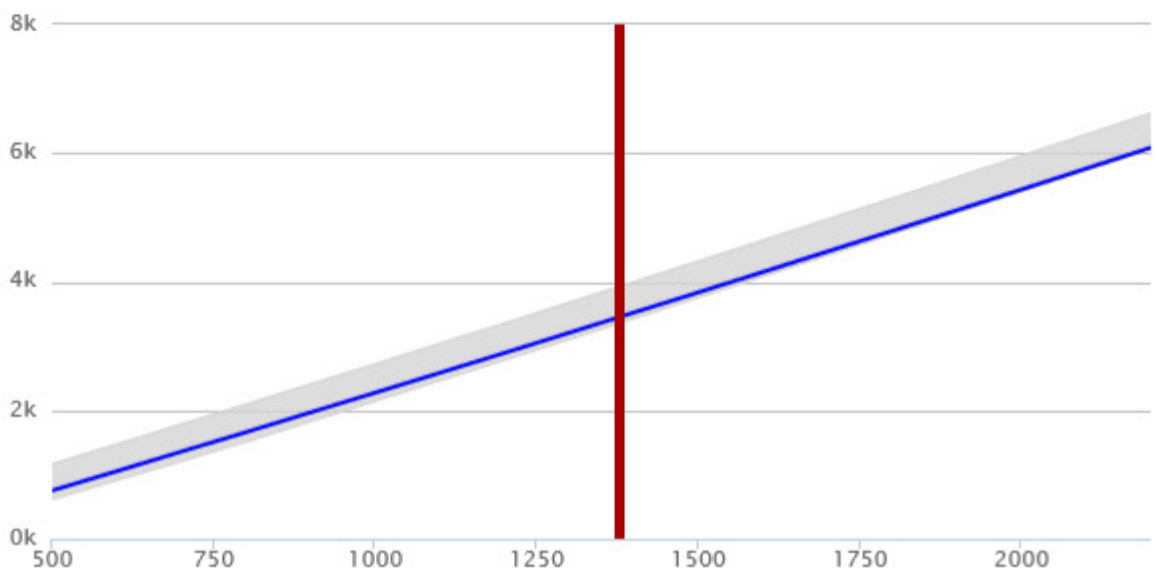

Performance Curves

Power

DEFINED CONDITIONS

152.7 HP

RPM

1378

Published Data

Defined Conditions

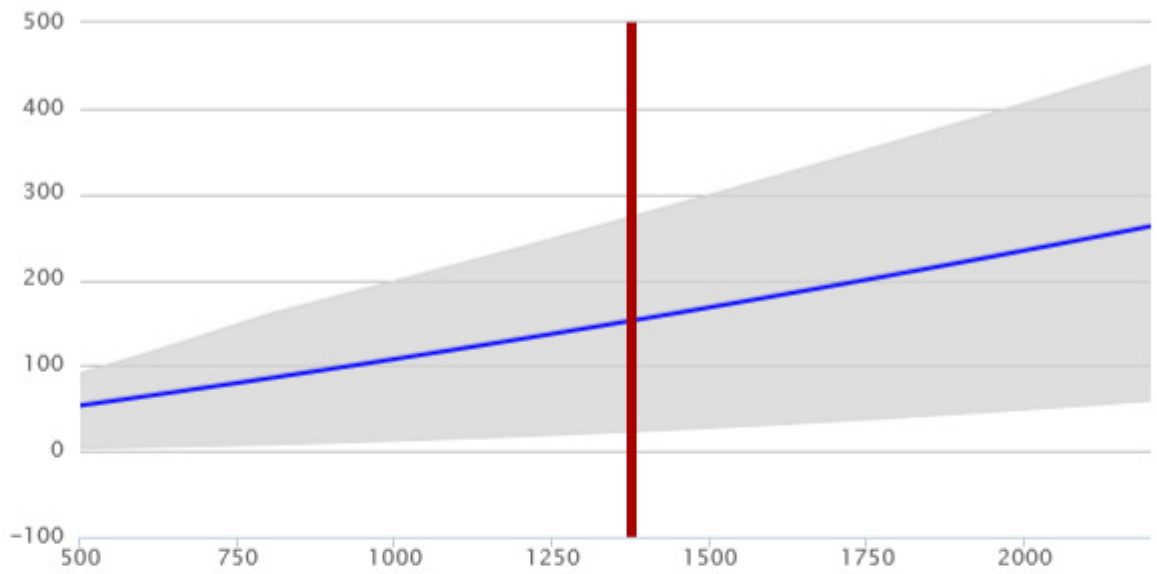

Torque

DEFINED CONDITIONS

582.1 ft-lb

RPM

1378

Published Data

Defined Conditions

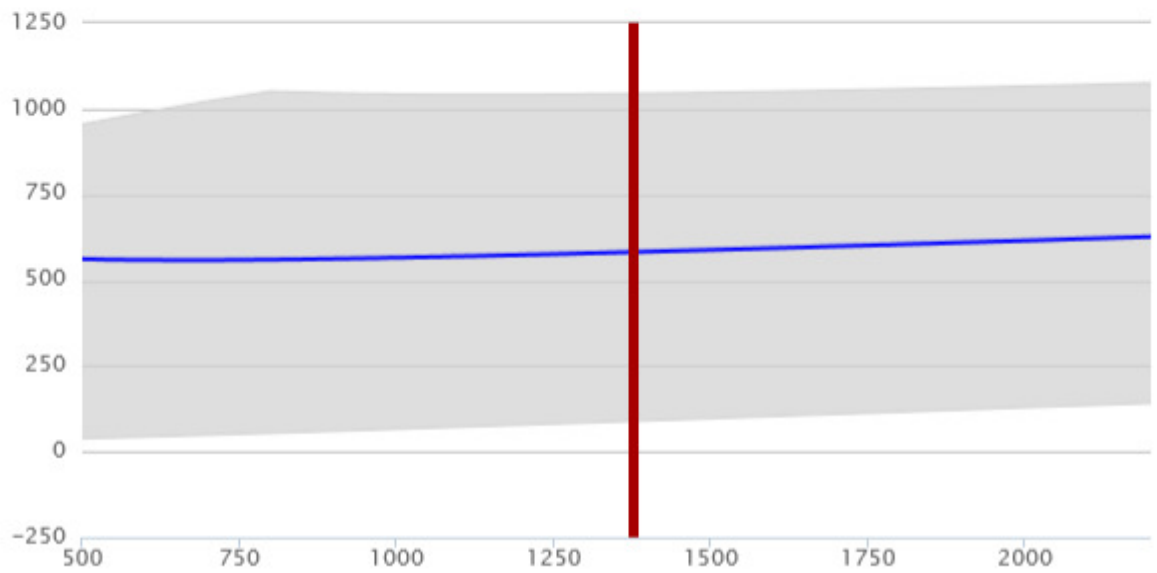

CycloBlower H.E. - 250CDL750 RC1 Low Compression DSL

Product Information

CORRECTED VALUES	ORIGINAL UNITS	ENGLISH UNITS	METRIC UNITS
Ambient Pressure	14.7 PSIA	14.700 PSIA	1.014 bar a
Elevation	-7 ALTI-FT	-7 ALTI-FT	-2 alti-m
Inlet Pressure	14.7 PSIA	0 PSIG	0 bar g
Inlet Pressure Loss	.4 PSIG	0.400 PSIG	0.028 bar g
Inlet Temp	100 F	100 °F	38 °C
Inlet Flow	4600 SCFM	5307 ICFM	9016 m³/h
Discharge Pressure	9.2 PSIG	9.200 PSIG	0.634 bar g
Discharge Pressure Loss	0 PSIG	0.000 PSIG	0 bar g

MEASURED VALUES	ORIGINAL UNITS	ENGLISH UNITS	METRIC UNITS
Speed	2013 RPM	2013 RPM	2013 RPM
RPM % Of Max	91	91	91
Power	236.1 HP	236.1 HP	176.06 kW
Discharge Temp	208 °F	208 °F	98 °C
Temp % of Max	59	59	59
Noise	dBa	dBa	dBa
Pressure % of Max	53	53	53
Adiabatic Efficiency	77.59%	77.59%	77.59%



PHYSICAL

Weight	3500 lbs.
Gear Diameter / Center Distance	in.
Connection Size	in.
Case Length	in.
WR ²	lb-ft ²
Orientation	horizontal

PERFORMANCE

Max Delta P	18 PSI
Max Temp	350 °F
Max Speed	2200 RPM
Min Speed	500 RPM
Max Case Pressure	40 PSIG
Max Delta T	250 °F

AMBIENT GAS PARAMETERS	ENGLISH UNITS	METRIC UNITS	GAS MIX:	VOL
Molecular Weight	28.282 lbm/lbmol	28.282 kg/kgmol	Air	100%
R Value	54.628 ft. lbf/lbm.R	0.294 kJ/kg.K		
Density	0.069 lbm/ft ³	1.109 kg/m ³		

Performance Curves

Temperature Rise

DEFINED CONDITIONS
108 F

RPM
2013

Published Data
Defined Conditions

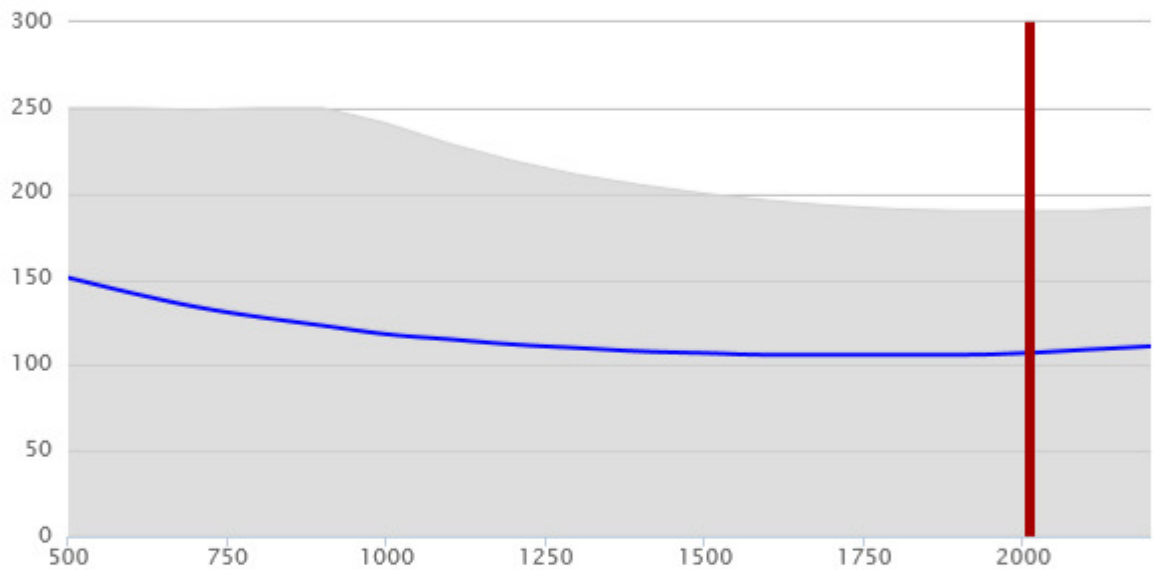

Flow

DEFINED CONDITIONS
4601 SCFM

RPM
2013

Published Data
Defined Conditions

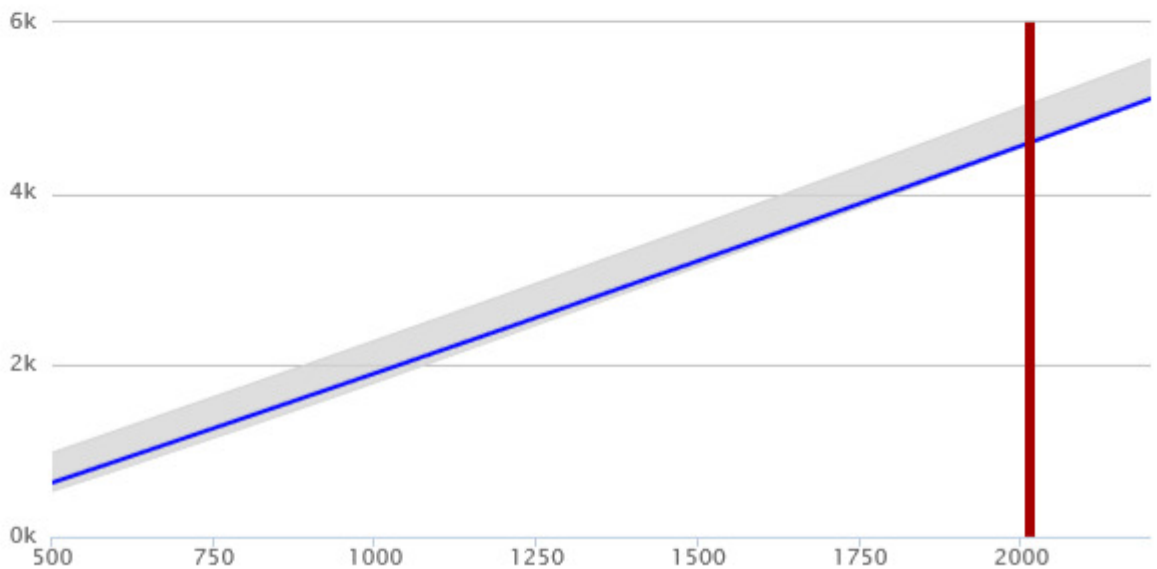

Performance Curves

Power

DEFINED CONDITIONS

236.1 HP

RPM

2013

Published Data

Defined Conditions

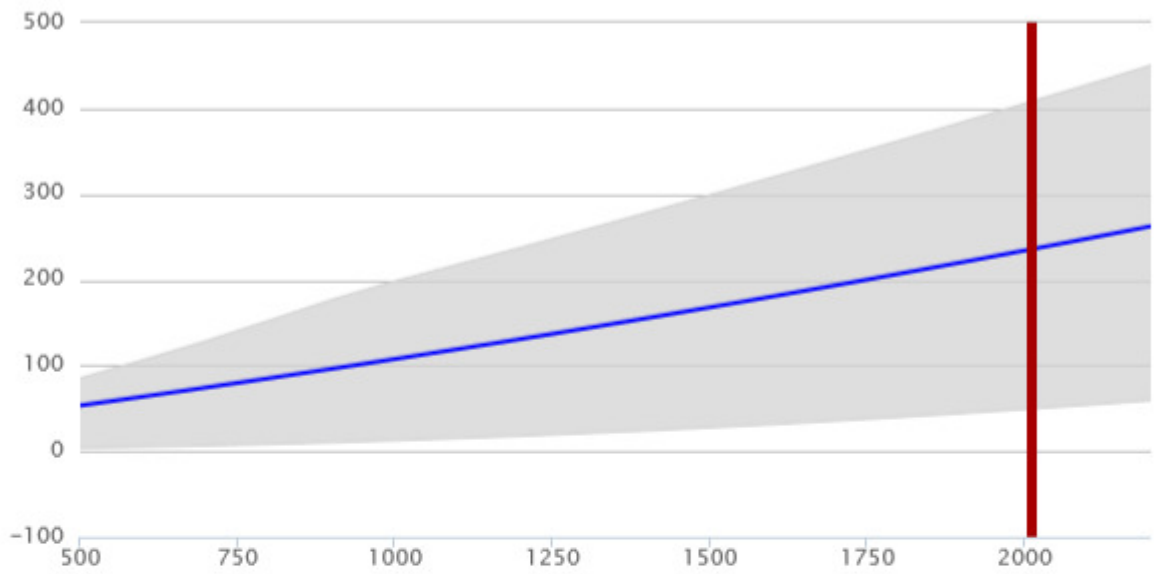

Torque

DEFINED CONDITIONS

616.1 ft-lb

RPM

2013

Published Data

Defined Conditions

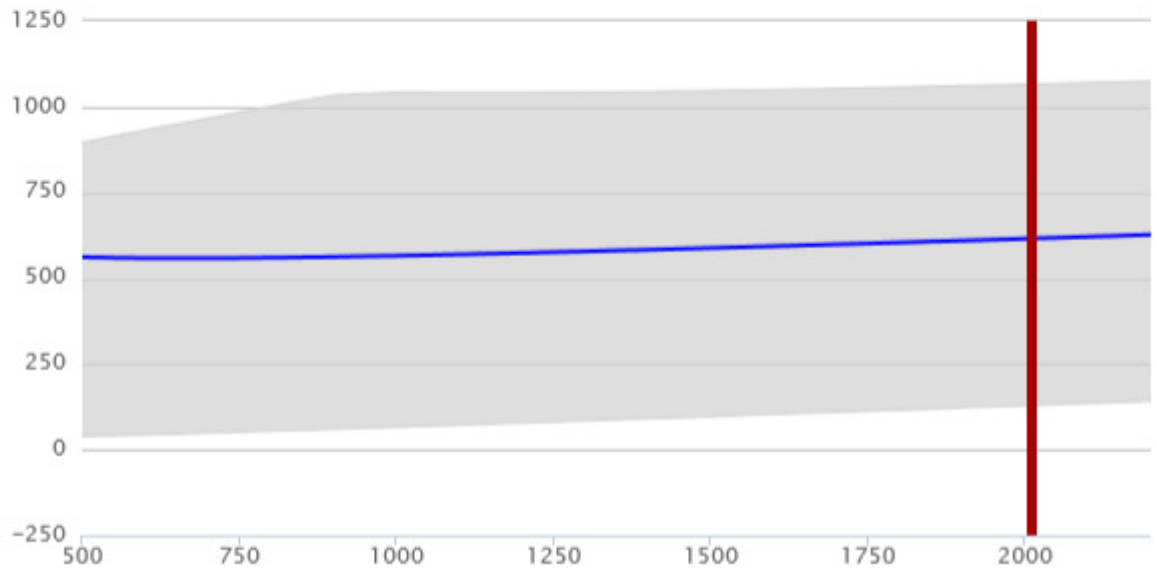

CycloBlower H.E. - 250CDL750 RC1 Low Compression DSL

Product Information

CORRECTED VALUES	ORIGINAL UNITS	ENGLISH UNITS	METRIC UNITS
Ambient Pressure	14.7 PSIA	14.700 PSIA	1.014 bar a
Elevation	-7 ALTI-FT	-7 ALTI-FT	-2 alti-m
Inlet Pressure	14.7 PSIA	0 PSIG	0 bar g
Inlet Pressure Loss	.4 PSIG	0.400 PSIG	0.028 bar g
Inlet Temp	40 F	40 °F	4 °C
Inlet Flow	4600 SCFM	4458 ICFM	7575 m³/h
Discharge Pressure	9.2 PSIG	9.200 PSIG	0.634 bar g
Discharge Pressure Loss	0 PSIG	0.000 PSIG	0 bar g

MEASURED VALUES	ORIGINAL UNITS	ENGLISH UNITS	METRIC UNITS
Speed	1741 RPM	1741 RPM	1741 RPM
RPM % Of Max	79	79	79
Power	199.2 HP	199.2 HP	148.543 kW
Discharge Temp	135 °F	135 °F	57 °C
Temp % of Max	38	38	38
Noise	dBa	dBa	dBa
Pressure % of Max	53	53	53
Adiabatic Efficiency	76.94%	76.94%	76.94%



PHYSICAL

Weight	3500 lbs.
Gear Diameter / Center Distance	in.
Connection Size	in.
Case Length	in.
WR ²	lb-ft ²
Orientation	horizontal

PERFORMANCE

Max Delta P	18 PSI
Max Temp	350 °F
Max Speed	2200 RPM
Min Speed	500 RPM
Max Case Pressure	40 PSIG
Max Delta T	250 °F

AMBIENT GAS PARAMETERS	ENGLISH UNITS	METRIC UNITS	GAS MIX:	VOL
Molecular Weight	28.912 lbm/lbmol	28.912 kg/kgmol	Air	100%
R Value	53.438 ft. lbf/lbm.R	0.287 kJ/kg.K		
Density	0.079 lbm/ft ³	1.270 kg/m ³		

Performance Curves

Temperature Rise

DEFINED CONDITIONS

95 F

RPM

1741

Published Data
Defined Conditions

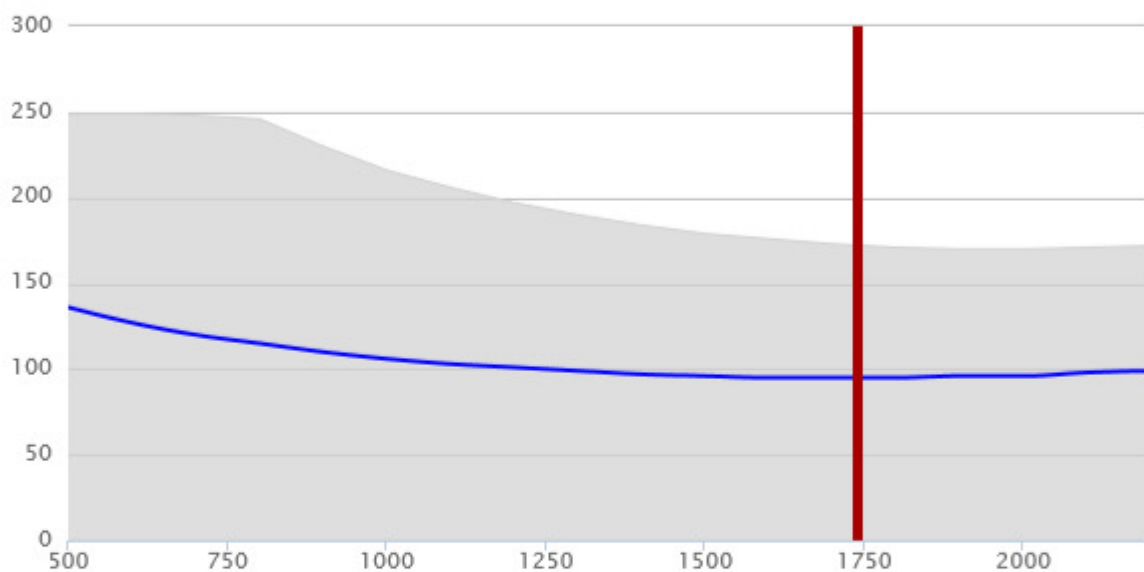

Flow

DEFINED CONDITIONS

4601 SCFM

RPM

1741

Published Data
Defined Conditions

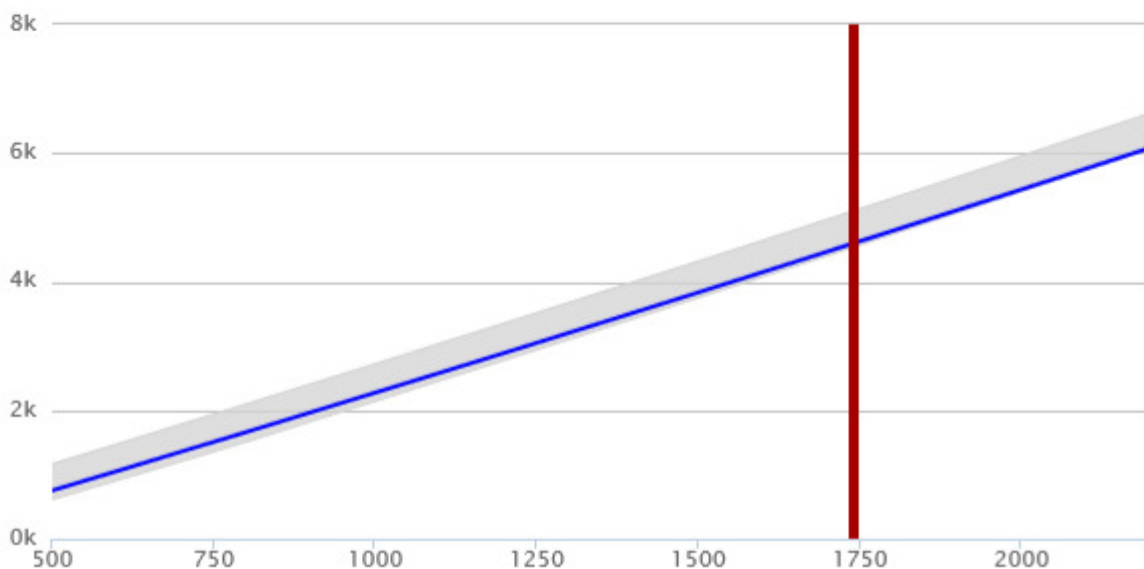

Performance Curves

Power

DEFINED CONDITIONS

199.2 HP

RPM

1741

Published Data

Defined Conditions

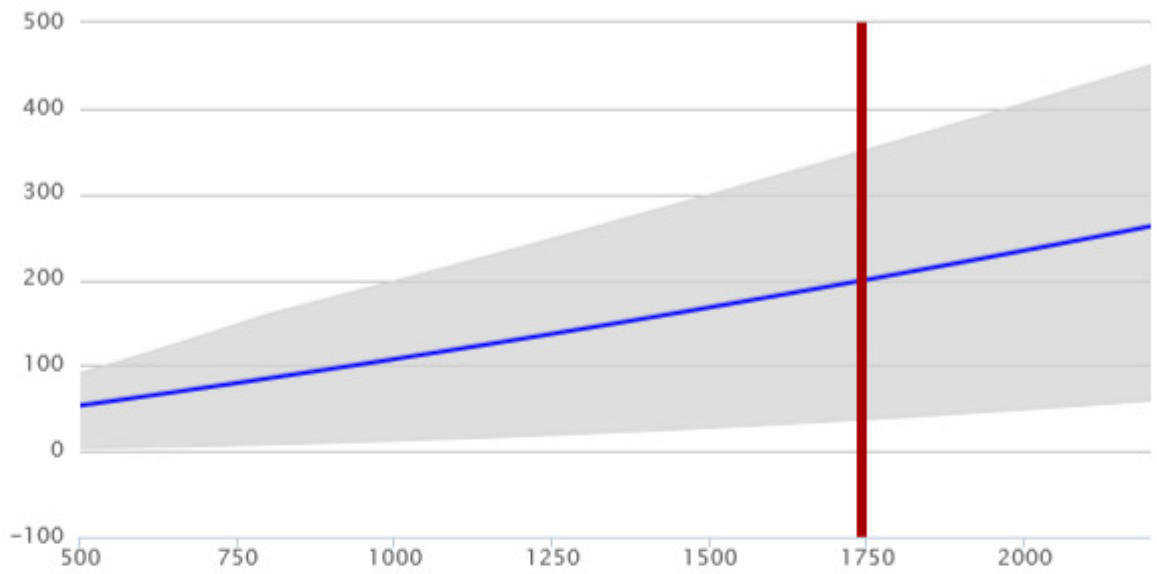

Torque

DEFINED CONDITIONS

601.0 ft-lb

RPM

1741

Published Data

Defined Conditions

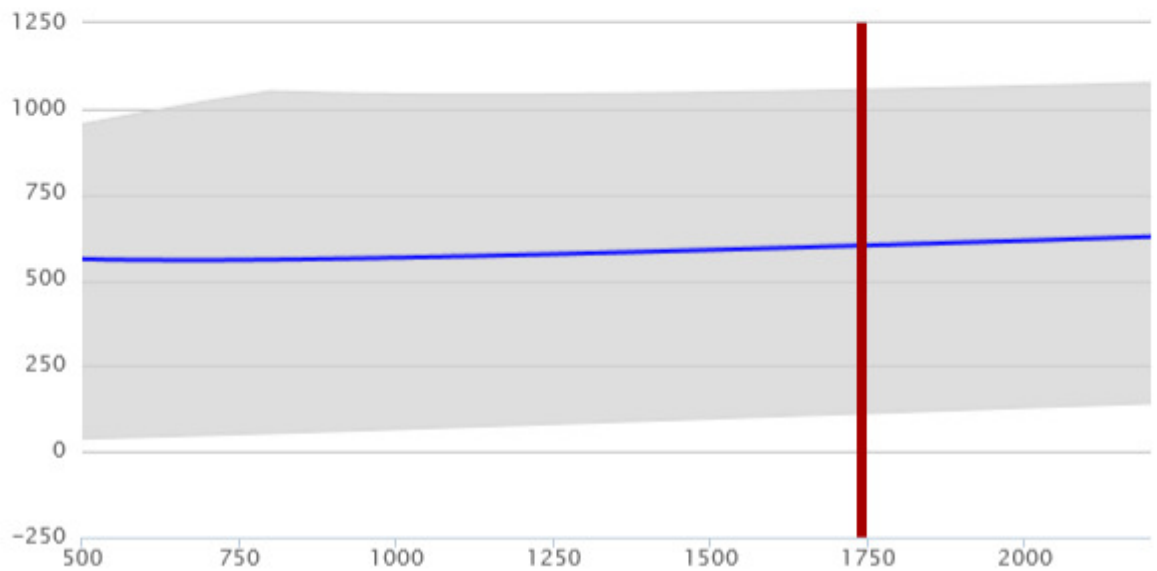

CycloBlower H.E. - 250CDL750 RC1 Low Compression DSL

Product Information

CORRECTED VALUES	ORIGINAL UNITS	ENGLISH UNITS	METRIC UNITS
Ambient Pressure	14.7 PSIA	14.700 PSIA	1.014 bar a
Elevation	-7 ALTI-FT	-7 ALTI-FT	-2 alti-m
Inlet Pressure	14.7 PSIA	0 PSIG	0 bar g
Inlet Pressure Loss	.4 PSIG	0.400 PSIG	0.028 bar g
Inlet Temp	100 F	100 °F	38 °C
Inlet Flow	2300 SCFM	2653 ICFM	4508 m³/h
Discharge Pressure	9.2 PSIG	9.200 PSIG	0.634 bar g
Discharge Pressure Loss	0 PSIG	0.000 PSIG	0 bar g

MEASURED VALUES	ORIGINAL UNITS	ENGLISH UNITS	METRIC UNITS
Speed	1150 RPM	1150 RPM	1150 RPM
RPM % Of Max	52	52	52
Power	125.1 HP	125.1 HP	93.287 kW
Discharge Temp	213 °F	213 °F	101 °C
Temp % of Max	61	61	61
Noise	dBa	dBa	dBa
Pressure % of Max	53	53	53
Adiabatic Efficiency	73.22%	73.22%	73.22%



PHYSICAL

Weight	3500 lbs.
Gear Diameter / Center Distance	in.
Connection Size	in.
Case Length	in.
WR ²	lb-ft ²
Orientation	horizontal

PERFORMANCE

Max Delta P	18 PSI
Max Temp	350 °F
Max Speed	2200 RPM
Min Speed	500 RPM
Max Case Pressure	40 PSIG
Max Delta T	250 °F

AMBIENT GAS PARAMETERS	ENGLISH UNITS	METRIC UNITS	GAS MIX:	VOL
Molecular Weight	28.282 lbm/lbmol	28.282 kg/kgmol	Air	100%
R Value	54.628 ft. lbf/lbm.R	0.294 kJ/kg.K		
Density	0.069 lbm/ft ³	1.109 kg/m ³		

Performance Curves

Temperature Rise

DEFINED CONDITIONS
113 F

RPM
1150

Published Data
Defined Conditions

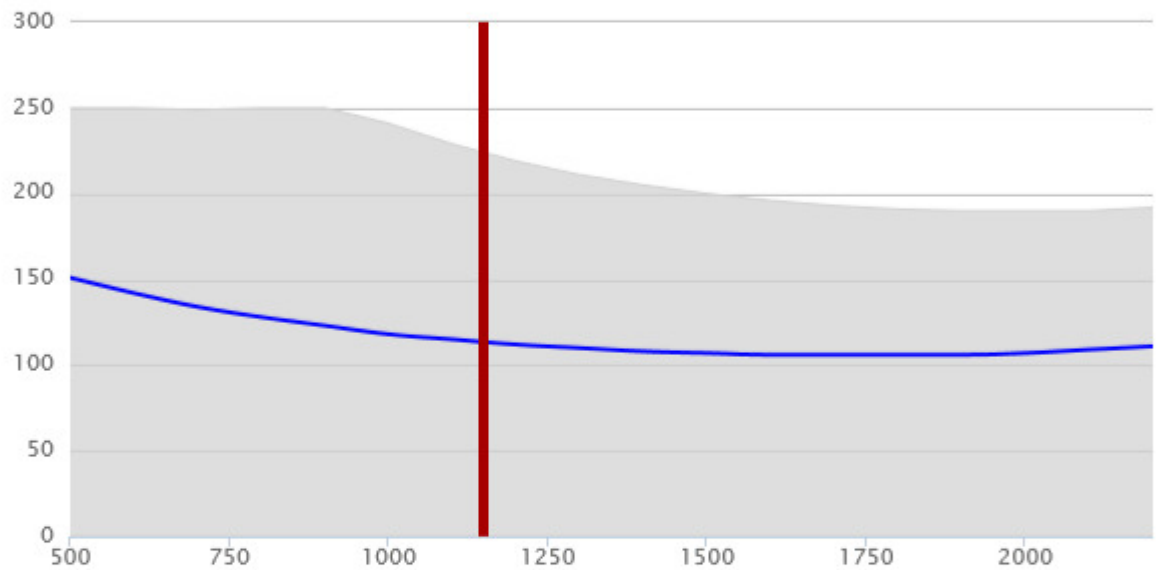

Flow

DEFINED CONDITIONS
2299 SCFM

RPM
1150

Published Data
Defined Conditions

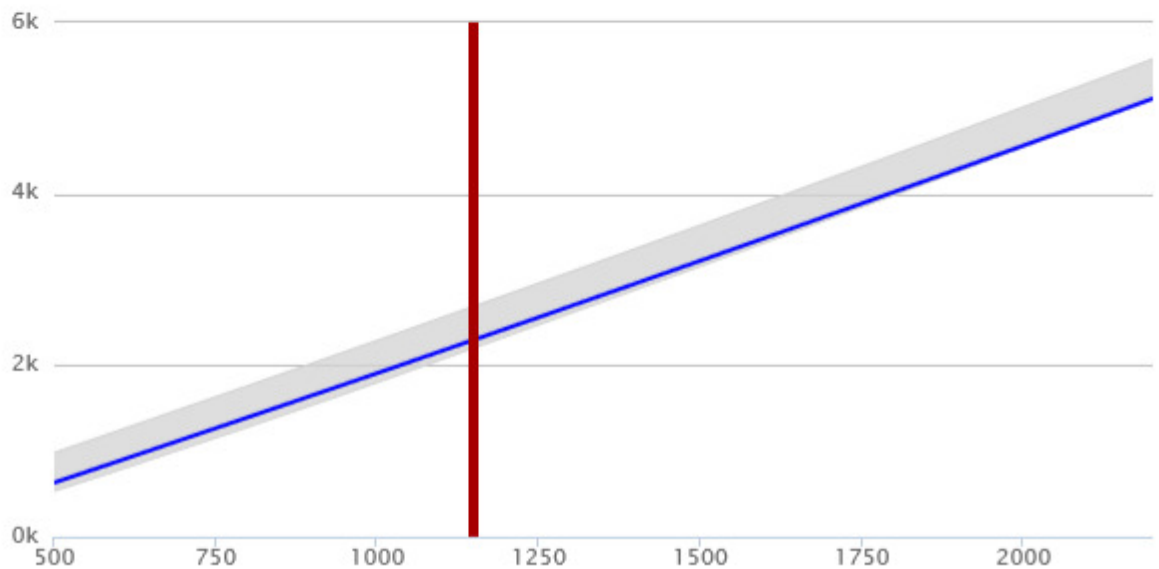

Performance Curves

Power

DEFINED CONDITIONS

125.1 HP

RPM

1150

Published Data

Defined Conditions

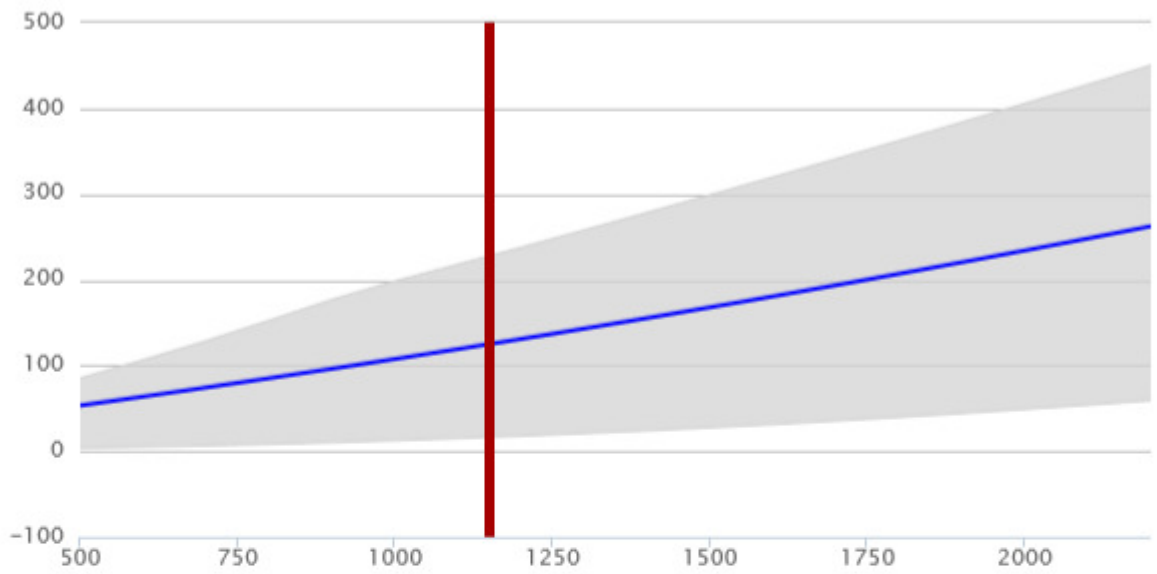

Torque

DEFINED CONDITIONS

571.6 ft-lb

RPM

1150

Published Data

Defined Conditions

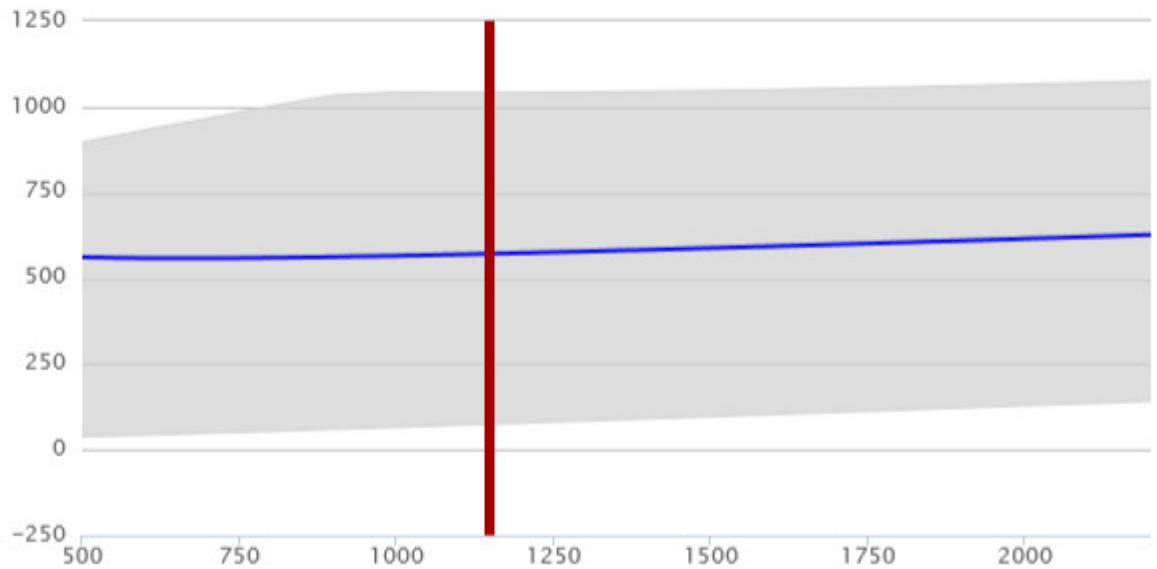

CycloBlower H.E. - 250CDL750 RC1 Low Compression DSL

Product Information

CORRECTED VALUES	ORIGINAL UNITS	ENGLISH UNITS	METRIC UNITS
Ambient Pressure	14.7 PSIA	14.700 PSIA	1.014 bar a
Elevation	-7 ALTI-FT	-7 ALTI-FT	-2 alti-m
Inlet Pressure	14.7 PSIA	0 PSIG	0 bar g
Inlet Pressure Loss	.4 PSIG	0.400 PSIG	0.028 bar g
Inlet Temp	40 F	40 °F	4 °C
Inlet Flow	2300 SCFM	2229 ICFM	3787 m³/h
Discharge Pressure	9.2 PSIG	9.200 PSIG	0.634 bar g
Discharge Pressure Loss	0 PSIG	0.000 PSIG	0 bar g

MEASURED VALUES	ORIGINAL UNITS	ENGLISH UNITS	METRIC UNITS
Speed	1008 RPM	1008 RPM	1008 RPM
RPM % Of Max	46	46	46
Power	108.7 HP	108.7 HP	81.058 kW
Discharge Temp	146 °F	146 °F	63 °C
Temp % of Max	41	41	41
Noise	dBa	dBa	dBa
Pressure % of Max	53	53	53
Adiabatic Efficiency	70.54%	70.54%	70.54%



PHYSICAL

Weight	3500 lbs.
Gear Diameter / Center Distance	in.
Connection Size	in.
Case Length	in.
WR ²	lb-ft ²
Orientation	horizontal

PERFORMANCE

Max Delta P	18 PSI
Max Temp	350 °F
Max Speed	2200 RPM
Min Speed	500 RPM
Max Case Pressure	40 PSIG
Max Delta T	250 °F

AMBIENT GAS PARAMETERS	ENGLISH UNITS	METRIC UNITS	GAS MIX:	VOL
Molecular Weight	28.912 lbm/lbmol	28.912 kg/kgmol	Air	100%
R Value	53.438 ft. lbf/lbm.R	0.287 kJ/kg.K		
Density	0.079 lbm/ft ³	1.270 kg/m ³		

Performance Curves

Temperature Rise

DEFINED CONDITIONS
106 F

RPM
1008

Published Data
Defined Conditions

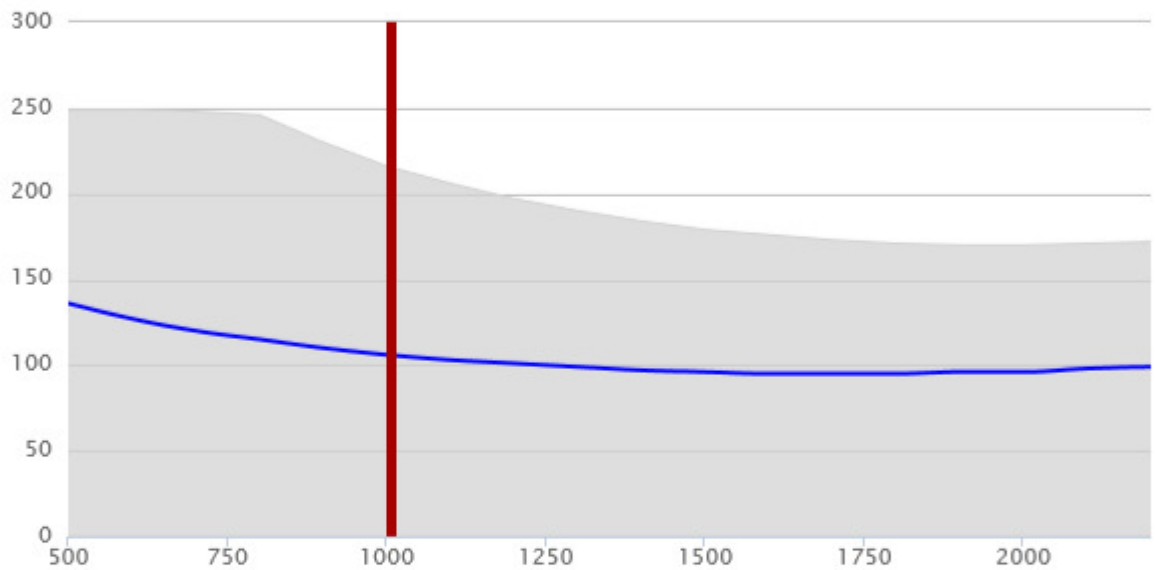

Flow

DEFINED CONDITIONS
2299 SCFM

RPM
1008

Published Data
Defined Conditions

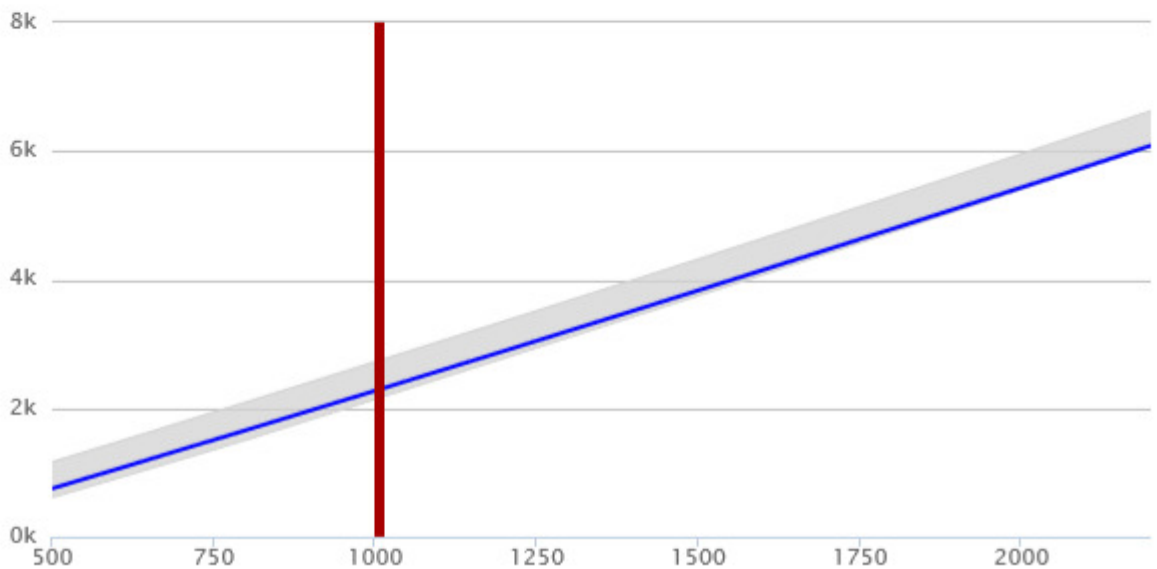

Performance Curves

Power

DEFINED CONDITIONS

108.7 HP

RPM

1008

Published Data

Defined Conditions

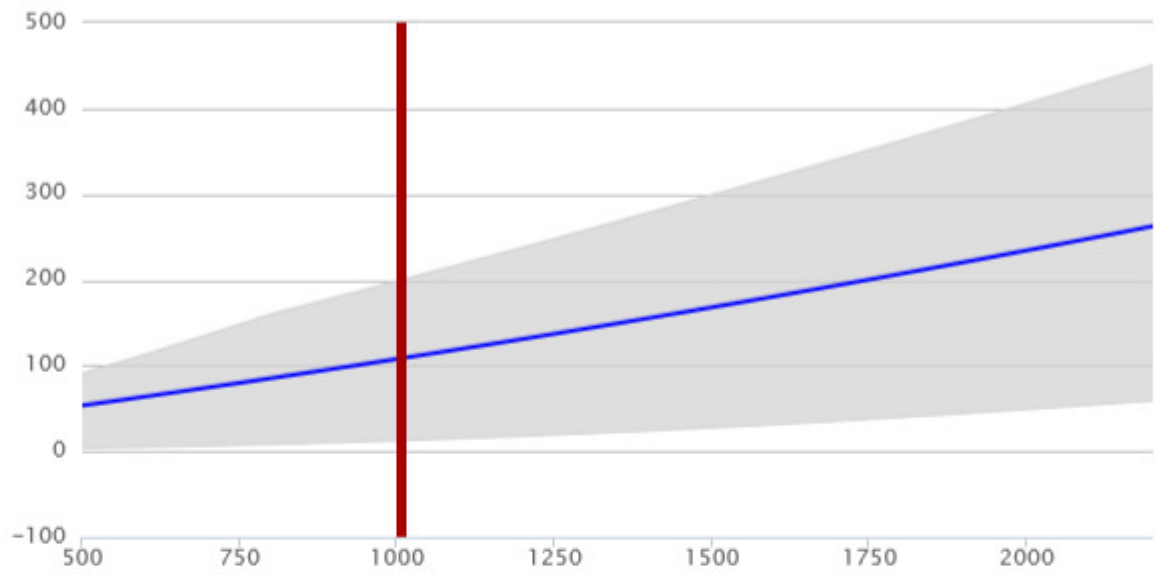

Torque

DEFINED CONDITIONS

566.4 ft-lb

RPM

1008

Published Data

Defined Conditions

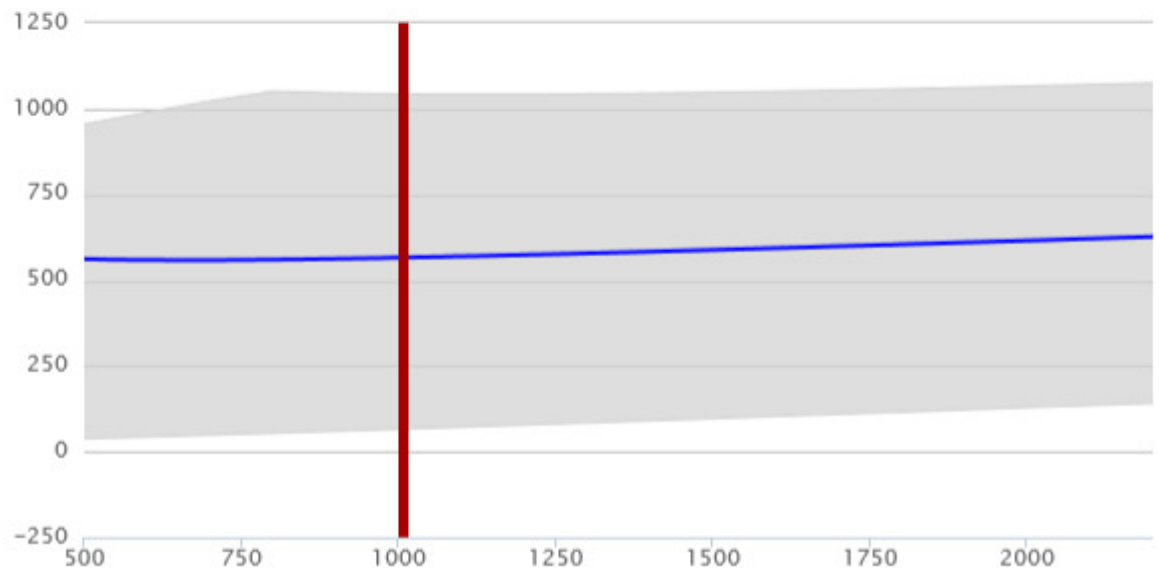

APPENDIX B

Statistical Evaluation Input Parameters

@RISK Model Inputs

Performed By: Botero, Lucas

Date: Thursday, September 20, 2018 10:45:44 AM

Name	Worksheet	Cell	Graph	Function	Min	Mean	Max
Category: 1277 3x A2+4x A3							
1277 3x A2+4x A3 / NA	Dimensions	R5		RiskNormal(202097,20000,RiskStatic(202097))	-∞	202097	+∞
Category: AveSummer							
AveSummer / OPERATING POINTS	Operation Info	AN8		RiskNormal(0.3,0.05,RiskStatic(0.3))	-∞	30%	+∞
Category: AveWinter							
AveWinter / OPERATING POINTS	Operation Info	AN11		RiskNormal(0.2,0.05,RiskStatic(0.2))	-∞	20%	+∞
Category: GL3							
GL3 / NA	Dimensions	R11		RiskWeibull(2,23000,RiskShift(230000),RiskStatic(230000))	230000	250383.2	+∞
Category: HST 9500-U250							
HST 9500-U250 / NA	Dimensions	R13		RiskNormal(170000,17000,RiskStatic(170000))	-∞	170000	+∞
Category: IF2-23-140							
IF2-23-140 / NA	Dimensions	R12		RiskWeibull(2,21000,RiskShift(214000),RiskStatic(214000))	214000	232610.8	+∞
Category: MaxSummer							
MaxSummer / OPERATING POINTS	Operation Info	AN7		RiskNormal(0.28,0.05,RiskStatic(0.28))	-∞	28%	+∞
Category: MaxWinter							
MaxWinter / OPERATING POINTS	Operation Info	AN10		RiskNormal(0.2,0.1,RiskTruncate(0.05,),RiskStatic(0.2))	5%	21%	+∞
Category: Power Cost							
Power Cost / Inputs	Operation Info	F9		RiskGamma(2,0.009,RiskShift(0.09),RiskStatic(0.11))	\$0.09	\$0.11	+∞