

PART 1

GENERAL REQUIREMENTS & CONDITIONS, CONTRACTUAL PROVISIONS



Contract #TRIPS-17-CA-FTS-G
CUTAWAY TRANSIT VEHICLES

Contract # TRIPS-17-CA-FTS-G

GENERAL REQUIREMENTS & CONDITIONS, CONTRACTUAL PROVISIONS

1.1 SCOPE

Notice is hereby given that the Transit Research Inspection Procurement Services Program (TRIPS) will establish a statewide Purchasing Agreement with Florida Transportation Systems, Inc. (herein known as contractor) and Goshen Coach (herein known as manufacturer) for the manufacture and delivery of 2017 model year:

STANDARD CUTAWAY CHASSIS TYPE TRANSIT VEHICLES

Minimum and maximum quantities are established as follows:

	<u>MIN</u>	<u>MAX</u>
STANDARD CUTAWAY TYPE TRANSIT VEHICLES	<u>0</u>	<u>750</u>

These numbers reflect the immediate and foreseeable needs of agencies within Florida and were determined by using the most recent state of Florida Program of Projects, historical data from previous TRIPS Purchasing Agreements, and Agency(s) vehicle replacement schedules. All or part of the quantity of vehicles stated herein may be assigned to other public transit agencies desiring to purchase the same equipment specified in **Part 2: Technical Specifications**.

The Purchasers will be allowed to purchase this vehicle as long as current production year chassis' are still available from the manufacturer or suppliers, under the same terms and conditions stated in this initial Purchasing Agreement.

Following award of the initial model production year, the TRIPS will have an option to extend the Purchasing Agreement for four succeeding model production years. Any optional Purchasing Agreements shall be subject to the same pricing, terms and conditions of the original Purchasing Agreement. However, a chassis model price increase will be considered when a model year change is specific to the automotive or bus industry. The Contractor shall provide a certification from the manufacturer to justify the chassis model price increase. The price may be adjusted only in the same amount as the price increase to the Contractor. The Contractor must submit the request and all necessary documentation to the TRIPS Program Administrator. The Contractor may request an increase in the second stage production costs after, or in conjunction with, the chassis increase request being received by the TRIPS Program Administrator. The TRIPS will compute the second stage costs utilizing the formula explained

in **Exhibit 1, FORMULA FOR COMPUTATION OF SECOND STAGE PRICE ESCALATION**. A final annual adjustment will then be authorized after combining the chassis increase with the second stage increase, if any. The date found on the Manufacturer’s letter, stating the new chassis cost, shall be the month used as the future Re-comp month for chassis only increases.

Each proposal shall be submitted with the understanding that acceptance in writing by any Purchaser of the offer to furnish any or all of the units therein, shall constitute a contract between the Proposer and that Purchaser only, and implies no duties or responsibilities on the part of the TRIPS or the Florida Department of Transportation (FDOT). The terms and conditions of said contract are to be administered and enforced by and between the Purchaser and the Proposer. The Purchaser is responsible for: providing the dealer with the properly completed forms and order information; resolution of issues relating to liquidated damages, late payment penalties, etc.; and adhering to the terms and conditions regarding Final Acceptance and Terms of Payment as stated in the Purchasing Agreement. The FDOT and the TRIPS are responsible, and have an obligation to, oversee the proper use of Federal and State grant monies; to ensure that all Federal, State and Purchasing Agreement requirements and certifications are met; monitor warranty and dealer services; conduct on-line and/or dealer inspections and intercede on behalf of the Purchasers.

This contract includes the following, incorporated herein:

- Part 1** - General Requirements & Conditions, Contractual Provisions
- Part 2** - Technical Specifications
- Part 3** - Options
- Part 4** - Quality Assurance Provisions
- Part 5** - Warranty Provisions
- Part 6** - Paint Schemes

GENERAL REQUIREMENTS AND CONDITIONS

1.2 DELIVERY AND ACCEPTANCE

- a. Completed units are to be delivered to purchaser within ninety (90) days from receipt of chassis or purchase order, whichever occurs last.
- b. Upon completion of a Pre-Delivery Inspection (PDI) by the licensed Florida dealer who is awarded this Purchasing Agreement, that dealer will be required to deliver the vehicles to the Purchaser. The dealer shall notify both the purchaser and the FDOT District Office a minimum of 48 hours in advance to arrange a delivery time. The name, address, telephone number, and contact person for each FDOT District Office is listed in **Exhibit 2: FDOT District Offices**.
- c. Failure to coordinate delivery may result in delay of vehicle being “signed for” as

delivered. The vehicles shall be delivered clean and in first class condition, complete and ready for service. Workmanship throughout shall conform to the highest standard of commercially accepted practice for the class of work and shall result in a complete, neat, and finished appearance.

- d. The Contractor shall assume all costs and responsibility relative to said delivery to purchaser.
- e. The vehicle shall be delivered with all Contractor/manufacturer's quality control checklists including road test and final inspection (properly completed and signed by an authorized plant representative). Other documents/items required at delivery include:
 - A copy of the Manufacturer's Certificate of Origin
 - Application for Certificate of Title
 - Bill of Sale
 - Warranty Papers (forms, policy, procedures)
 - Maintenance Schedule
 - Operators' manual
 - Invoice (To include contract number, P.O. number, VIN#, and agency name)
- f. If any of the items listed above are missing, defective, altered, incorrect, incomplete, etc., the vehicle will be automatically rejected. **Exhibit 3: Vehicle Delivery Checklist** contains a list of the minimum required items at delivery.
- g. Delivery to Purchaser is to be completed within ten (10) calendar days of receipt of vehicle at Contractor's site. Delivery shall be determined by signed receipt of the contact person or their designee, at the point of delivery. Further, since a common carrier is an independent concern, any delay in delivery resulting from the common carrier's operations, accident, or mechanical failures on route will be considered a cause beyond the control of the Contractor, provided vehicles were delivered to said carrier in ample time for delivery within normal operating conditions. Odometer readings cannot exceed 3,000 miles at time of final delivery of completed buses to agency(s). There will be one dollar (\$1.00) per mile charge for each vehicle with an odometer reading in excess of 3000 miles. Under NO circumstances are tow vehicles to be attached to any buses.
- h. In case delivery of completed units under this Purchasing Agreement shall be necessarily delayed because of weather, strike, injunctions, government controls, or by reason of any cause or circumstances beyond control of the Contractor, the time for completion of delivery shall be extended by the number of days to be determined in each instance in writing and by mutual agreement between the parties.
- i. All units shall consist of new parts and materials and in no case will used components

or reconditioned or obsolete parts be accepted. Any one part or component shall be an exact duplicate in manufacture and design as well as construction as all others proposed for each unit. Manufacturers must incorporate, in the units proposed, the newest technological advancement in order to achieve maximum service life and an attractive modern appearance.

- j. All vehicle data must be entered into the TRIPS DATACenter prior to its delivery to the Springhill Bus Testing and Inspection Facility (SBTIF) located in Tallahassee, Florida. VIN#'s shall also be entered into the TRIPS DATACenter within 10 days after issuance of the Purchase Order. Any vehicles arriving at the SBTIF without the VIN# entered in the DATACenter will not be inspected until this information is entered.

To schedule an inspection, the dealer shall send an email to the TRIPS Manager, Erin Schepers at erin.schepers@dot.state.fl.us to set up an inspection appointment. Information in the email should include the following:

- o Anticipated delivery date
- o Number of vehicles
- o Whether inspection is a drop off or a to be inspected while you wait

The TRIPS Manager will schedule the inspection and provide a confirmation to the Dealer via email. A copy of the sales order and build order should be sent to the TRIPS Manager once an inspection date has been established.

Each vehicle delivered to the SBTIF shall have a complete set of "as built" wiring diagrams. The Dealer should see that all noted write-ups are corrected prior to the final delivery to the procuring agency. This inspection by TRIPS is not represented as being "all inclusive" and in no way relieves the Dealer from the required PDI.

- k. Any vehicle delivered by the Contractor that does not comply with specifications, conditions, and requirements shall be considered not accepted.
- l. If a vehicle is delivered incomplete or contains any defective or damaged parts, said parts shall be removed and new parts furnished and installed by the Contractor at no cost to the Purchaser. In the event work is involved, whether warranty or otherwise, in repairing or placing the vehicle(s) in proper condition, then such repairs shall be made by an approved firm.
- m. Delivery of vehicle(s) by the Contractor does not constitute acceptance by the Purchaser. Vehicle(s) shall be considered "accepted" upon the inspection by the Purchaser and the issuance of a "Letter of Acceptance" to the Contractor. Purchaser will perform a post-delivery inspection and issue either a "Letter of Acceptance" or a "Letter of Rejection" to Contractor, stating areas found to be in non-compliance with the specifications, within ten (10) calendar days from receipt of vehicle(s). Placing any new vehicle into revenue service will automatically constitute acceptance of vehicle by

Purchaser. However, a Letter of Acceptance should still be sent to the Contractor prior to placing vehicle into revenue service.

n. Acceptance of the vehicles shall not release the Contractor from liability for faulty workmanship or materials.

o. **Training:**

Driver Orientation/Certification	8 hours @ 5 locations annually
Air Conditioning/Certification	4 hours @ 5 locations annually
Securement Device/Certification	4 hours @ 5 locations annually
Maintenance Familiarization	8 hours @ 5 locations annually
Electrical & Electronics Familiarization	8 hours @ 5 locations annually
Wheelchair Ramp Training	2 hours @ 3 locations annually

(Training will often be provided in conjunction with component supplier)
“Certificates of Training” will be provided for all component training classes.

Dealer Orientation Upon Delivery: The dealer shall provide a vehicle orientation with each vehicle delivered to an agency. If an agency orders more than one (1) unit of identical specifications; the orientation shall be provided on the first unit delivered. The orientation shall be conducted by the dealer for the maintenance and operations supervisory and training personnel. The orientation shall include, but not be limited to:

- Engine type and proper type of fuel
- How to check coolant level and type of coolant required
- Function of all controls on the OEM
- Function of all controls on the second stage driver control panel
- Identify location of and function of controls of all add-on equipment such as A/C, wheelchair ramp, restraint systems, etc.
- Locate and identify all alarms
- Locate and identify tire pressure ID plate
- Location of battery and how to service
- Location of Multiplexing components and their use
- Location of Event Data Recorder and demonstrate data download
- Location and inspection of Fire Suppression system

1.3 FEDERAL AND STATE TAX

The Purchasers are exempt from payment of Federal Excise Tax and Florida State Tax. Said taxes must not be included in the price. Any other sales tax, use tax, imports, revenues, excise or other taxes which may now or hereafter be imposed by Congress, by the State, or any political subdivision thereof and applicable to the sale and delivery of the product as a result of this proposal, and which by terms of the tax law, may be passed directly to a Purchaser, will

be paid by the Purchaser. Such taxes, as may be included, must be identified as to amount(s) and type of tax.

1.4 ON-LINE INSPECTIONS

The TRIPS reserves the right to perform an on-line inspection of any vehicles procured as a result of this proposal. If any defective or non-compliance items are found during the on-line inspection, the TRIPS may choose to perform subsequent on-line inspections at a date agreeable to both parties.

1.5 INDEMNIFICATION

Proposer must agree to save, keep, and bear harmless and fully indemnify any Purchaser and any of its officers, or TRIPS personnel from all damages, costs, or expenses in law or equity, that may at any time arise or to be set up, for any infringement of the patent rights of any person or persons in consequence of the use by a Purchaser or by any of its officers or proposal coordinators, of articles supplied under contract, arising from proposals submitted and which a Purchaser gives the Contractor notice in writing of any such claims or suit and provides necessary cooperation for the defense of said claim or suit.

1.6 MOTOR VEHICLE SAFETY STANDARDS

All vehicles covered by these specifications shall be in compliance with applicable Federal Motor Vehicle Safety Standards established by the National Highway Traffic Safety Administration. The manufacturer must include in their proposal package, either a letter stating the information that will be provided on the FMVSS sticker or a letter stating that the vehicles are not subject to FMVSS. Vehicles must be in compliance with all the requirements of the laws of the State of Florida as to lighting equipment, and all warning and safety devices. In the event there are changes in the Federal Motor Vehicles Safety Standards between date of proposal and date of manufacture, any new requirements applicable at time of manufacture will be considered separately and the price for same determined by mutual agreement. In granting this, the Contractor is not relieved of the responsibility of providing the Purchaser with all available information relative to the engineering structure, and design change so affected and the impact (if any) these changes may have on the durable-useful life and attractive appearance of the vehicle to be provided per these specifications.

1.7 LIQUIDATED DAMAGES

In the event of delay in completion of the delivery of vehicles beyond the date specified, in addition to any granted extensions agreed to in writing by the Purchaser, any affected Purchaser shall assess as liquidated damages, twenty five dollars (\$25.00) per calendar day per vehicle.

1.8 PARTS AND MANUALS

A supply of replacement parts for the vehicles specified must be guaranteed by the Contractor

for a ten-year period from date of purchase. The Contractor shall provide Purchaser with complete “**as built**” wiring diagrams for the entire vehicle, a current service manual and a current parts manual (“*as-built drawings, service manual and parts manual may be on a CD, as determined by the Purchaser*”). These should be provided for each vehicle with a maximum of two (2) sets per Purchaser if they are purchasing more than two (2) vehicles. One (1) Operator’s Manual shall be provided for each vehicle, regardless of the number of vehicles ordered by a given Purchaser. A list of any special tools or equipment will also be provided. The supplied operator’s and maintenance manuals and wiring diagrams shall incorporate the options ordered on purchaser’s vehicles.

1.9 ALTOONA TEST

Either a final report from the Altoona Bus Testing Center or documentation from the Federal Transit Administration stating that the vehicles are not required to undergo Altoona testing must be submitted with each proposal.

1.10 TITLING VEHICLES

Unless specified otherwise, Vehicles shall be titled to the Purchaser with the Florida Department Transportation, 605 Suwannee Street, Mail Station 26, Tallahassee, Florida 32399-0450 listed as the only lien holder.

The Contractor shall be responsible for applying for Title and purchasing a license tag on behalf of the Purchaser.

CONTRACTUAL PROVISIONS

1.11 FEDERAL TRANSIT ADMINISTRATION FUNDING

Any contract resulting from proposal submitted is subject to financial reimbursement by the Federal Transit Administration. Accordingly, federal requirements may apply to that contract and if those requirements change then the changed requirements shall apply as required.

1.12 INCLUSION OF PROVISIONS

All provisions stated in this Invitation to Proposal and Vehicle Specifications, including any addenda, shall be considered to be included in the contract between the Purchaser(s) and the successful proposer.

1.13 REQUIREMENTS OF PROPOSERS

a. Compliance With Regulations

The successful proposer, hereinafter called the Contractor, shall comply with regulations relative to nondiscrimination in Federally-assisted programs of the United

States Department of Transportation (hereinafter, "DOT") Title 49, Code of Federal Regulations, Part 21, as they may be amended from time to time (hereinafter referred to as the Regulations), as incorporated by reference and made a part of this Purchasing Agreement.

b. Nondiscrimination

The Contractor, with regard to the work performed by it during the Purchasing Agreement, shall not discriminate on the grounds of race, religion, color, sex, national origin or disability in the selection and retention of subcontractors, including procurement of materials and leases of equipment. The Contractor shall not participate either directly or indirectly in the discrimination prohibited by the regulations, including employment practices.

c. Equal Employment Opportunity

In connection with the execution of this Purchasing Agreement, the Contractor shall not discriminate against any employee or applicant for employment because of disability, race, religion, color, sex, or national origin. The Contractor shall take affirmative action to insure that applicants are employed and that employees are treated during their employment without regard to their disability, race, religion color, sex or national origin. Such action shall include, but not be limited to the following: employment, upgrading, demotion, or transfer; recruitment or recruitment advertising; layoff, or termination; rates of pay, or other forms of compensation; and selection for training, including apprenticeship.

d. Solicitations From Subcontracts, Including Procurement of Materials And Equipment

In all solicitations either by competitive proposals or negotiation made by the Contractor for work to be performed under this proposed Purchasing Agreement, including procurement of materials or leases of equipment, each potential subcontractor or supplier shall be notified by the Contractor of the obligations relative to nondiscrimination on the grounds of disability, race, color, sex, religion, or national origin.

e. Information and Reports

The Contractor shall provide all information and reports required by the regulations or directives issued pursuant thereto, and shall permit reasonable access to all its books, records, accounts, other sources of information, and its facilities as may be determined by the Proposal Administrator to be pertinent to ascertain compliance with said regulations, orders, and instructions. Included in this information shall be the manufacturer's certification of compliance with Federal Motor Vehicle Safety Standards, or if inapplicable, a written statement documenting that these standards do

not apply.

Where any information is required or a Contractor is in the exclusive possession of another who fails or refuses to furnish this information, the Contractor shall so certify to the Proposal Administrator, as appropriate, and shall set forth that efforts have been made to obtain the information.

f. Sanctions For Noncompliance

In the event of the Contractor's noncompliance with the nondiscrimination provisions of this Purchasing Agreement, the Purchaser shall impose such contract sanctions as it may determine to be appropriate, including but not limited to:

- (1) Withholding of payments to the Contractor until compliance; and/or
- (2) Cancellation, termination, or suspension of the Purchasing Agreement, in whole or in part.

1.14 BUY AMERICA

The Contractor agrees to comply with 49 U.S.C. 5323(j) and 49 CFR Part 661, which provide that Federal funds may not be obligated unless steel, iron, and manufactured products used in FTA-funded projects are produced in the United States, unless a waiver has been granted by FTA or the product is subject to a general waiver. General waivers are listed in 49 CFR 661.7, and include final assembly in the United States for 15 passenger vans and 15 passenger wagons produced by Chrysler Corporation, microcomputer equipment, software, and small purchases (currently less than \$100,000) made with capital, operating, or planning funds. Separate requirements for rolling stock are set out at 5323(j)(2)(C) and 49 CFR 661.11. Rolling stock not subject to a general waiver must be manufactured in the United States and have a 65 percent domestic content.

1.15 CARGO PREFERENCE-USE OF UNITED STATES-FLAG VESSELS

The Contractor agrees: a. to use privately owned United States-Flag commercial vessels to ship at least 50 percent of the gross tonnage (computed separately for dry bulk carriers, dry cargo liners, and tankers) involved, whenever shipping any equipment, material, or commodities pursuant to the underlying contract to the extent such vessels are available at fair and reasonable rates for United States-Flag commercial vessels; b. to furnish within 20 working days following the date of loading for shipments originating within the United States or within 30 working days following the date of loading for shipments originating outside the United States, a legible copy of a rated, "on-board" commercial ocean bill-of-lading in English for each shipment of cargo described in the preceding paragraph to the Division of National Cargo, Office of Market Development, Maritime Administration, Washington, DC 20590 and to the FTA recipient (through the Contractor in the case of a subcontractor's bill-of-lading.) c. to

include these requirements in all subcontracts issued pursuant to this Purchasing Agreement when the subcontract may involve the transport of equipment, material, or commodities by ocean vessel.

1.16 ENERGY CONSERVATION

The Contractor agrees to comply with mandatory standards and policies relating to energy efficiency that is contained in the state energy conservation plan issued in compliance with the Energy Policy and Conservation Act.

1.17 CLEAN WATER

- a. The Contractor agrees to comply with all applicable standards, orders or regulations issued pursuant to the Federal Water Pollution Control Act, as amended, 33 U.S.C. 1251 et seq. The Contractor agrees to report each violation to the Purchaser and understands and agrees that the Purchaser will, in turn, report each violation as required to assure notification to FTA and the appropriate EPA Regional Office.
- b. The Contractor also agrees to include these requirements in each subcontract exceeding \$100,000 financed in whole or in part with Federal assistance provided by FTA.

1.18 BUS TESTING

The Contractor [Manufacturer] agrees to comply with 49 U.S.C. A 5323© and FTA's implementing regulation at 49 CFR Part 665 and shall perform the following:

- a. A manufacturer of a new bus model or a bus produced with a major change in components or configuration shall provide a copy of the final test report to the recipient at a point in the procurement process specified by the recipient which will be prior to the recipient's final acceptance of the first vehicle.
- b. A manufacturer who releases a report under paragraph 1 above shall provide notice to the operator of the testing facility that the report is available to the public.
- c. If the manufacturer represents that the vehicle was previously tested, the vehicle being sold should have the identical configuration and major components as the vehicle in the test report, which must be provided to the recipient prior to recipient's final acceptance of the first vehicle. If the configuration or components are not identical, the manufacturer shall provide a description of the change and the manufacturer's basis for concluding that it is not a major change requiring additional testing.
- d. If the manufacturer represents that the vehicle is "grand fathered" (has been used in mass transit service in the United States before October 1, 1988, and is currently being produced without a major change in configuration or components), the manufacturer

shall provide the name and address of the recipient of such a vehicle and the details of that vehicle's configuration and major components.

1.19 PRE-AWARD AND POST-DELIVERY AUDIT REQUIREMENTS

The Contractor agrees to comply with 49 U.S.C. § 5323(l) and FTA's implementing regulation at 49 C.F.R. Part 663 and to submit the following certifications:

- a. Buy America Requirements: The Contractor shall complete and submit a declaration certifying either compliance or noncompliance with Buy America. If the Proposer/Offeror certifies compliance with Buy America, it shall submit documentation which lists 1) component and subcomponent parts of the rolling stock to be purchased identified by manufacturer of the parts, their country of origin and costs; and 2) the location of the final assembly point for the rolling stock, including a description of the activities that will take place at the final assembly point and the cost of final assembly.
- b. Solicitation Specification Requirements: The Contractor shall submit evidence that it will be capable of meeting the proposal specifications.
- c. Federal Motor Vehicle Safety Standards (FMVSS): The Contractor shall submit 1) manufacturer's FMVSS self-certification sticker information that the vehicle complies with relevant FMVSS or 2) manufacturer's certified statement that the contracted buses will not be subject to FMVSS regulations.

1.20 BYRD ANTI-LOBBYING AMENDMENT, 31 U.S.C. 1352, AS AMENDED BY THE LOBBYING DISCLOSURE ACT OF 1995, P.L. 104-65 [TO BE CODIFIED AT 2 U.S.C. § 1601, ET SEQ.]

Contractors who apply or propose for an award of \$100,000 or more shall file the certification required by 49 CFR part 20, "New Restrictions on Lobbying." Each tier certifies to the tier above that it will not and has not used Federal appropriated funds to pay any person or organization for influencing or attempting to influence an officer or employee of any agency, a member of Congress, officer or employee of Congress, or an employee of a member of Congress in connection with obtaining any Federal contract, grant or any other award covered by 31 U.S.C. 1352. Each tier shall also disclose the name of any registrant under the Lobbying Disclosure Act of 1995 who has made lobbying contacts on its behalf with non-Federal funds with respect to that Federal contract, grant or award covered by 31 U.S.C. 1352. Such disclosures are forwarded from tier to tier up to the recipient.

1.21 ACCESS TO RECORDS AND REPORTS

The following access to records and reports requirements applies to this Purchasing Agreement:

- a. Record Retention. The Contractor will retain, and will require its subcontractors of all tiers to retain, complete and readily accessible records related in whole or in part to the contract, including, but not limited to, data, documents, reports, statistics, sub-agreements, leases, subcontracts, arrangements, other third party agreements of any type, and supporting materials related to those records.
- b. Retention Period. The Contractor agrees to comply with the record retention requirements in accordance with 2 C.F.R. § 200.333. The Contractor shall maintain all books, records, accounts and reports required under this Contract for a period of at not less than three (3) years after the date of termination or expiration of this Contract, except in the event of litigation or settlement of claims arising from the performance of this Contract, in which case records shall be maintained until the disposition of all such litigation, appeals, claims or exceptions related thereto.
- c. Access to Records. The Contractor agrees to provide sufficient access to FTA and its contractors to inspect and audit records and information related to performance of this contract as reasonably may be required.
- d. Access to the Sites of Performance. The Contractor agrees to permit FTA and its contractors' access to the sites of performance under this contract as reasonably may be required.

1.22 FEDERAL CHANGES

Contractor shall at all times comply with all applicable FTA regulations, policies, procedures and directives, including without limitation those listed directly or by reference in the Agreement (Form FTA MA (2) dated October, 1995) between Purchaser and FTA, as they may be amended or promulgated from time to time during the term of this Purchasing Agreement. Contractor's failure to so comply shall constitute a material breach of this Purchasing Agreement.

1.23 CLEAN AIR

The Contractor agrees to comply with all applicable standards, orders or regulations issued pursuant to the Clean Air Act, as amended, 42 U.S.C. § 7401 *et seq.* The Contractor agrees to report each violation to the Purchaser and understands and agrees that the Purchaser will, in turn, report each violation as required to assure notification to FTA and the appropriate EPA Regional Office.

The Contractor also agrees to include these requirements in each subcontract exceeding \$100,000 financed in whole or in part with Federal assistance provided by FTA.

1.24 RECYCLED PRODUCTS

The Contractor agrees to comply with all the requirements of Section 6003 of the Resource Conservation and Recovery Act (RCRA), as amended (42 U.S.C. 6962), including but not limited to the regulatory provisions of 40 CFR Part 247, and Executive Order 12873, as they apply to the procurement of the items designated in Subpart B of 40 CFR Part 247.

1.25 CONTRACT WORK HOURS AND SAFETY STANDARDS ACT

- a. **Overtime requirements** - No Contractor or subcontractor contracting for any part of the contract work which may require or involve the employment of laborers or mechanics shall require or permit any such laborer or mechanic in any workweek in which he or she is employed on such work to work in excess of forty hours in such workweek unless such laborer or mechanic receives compensation at a rate not less than one and one-half times the basic rate of pay for all hours worked in excess of forty hours in such workweek.
- b. **Violation; liability for unpaid wages; liquidated damages** - In the event of any violation of the clause set forth in paragraph (1) of this section the Contractor and any subcontractor responsible therefore shall be liable for the unpaid wages. In addition, such Contractor and subcontractor shall be liable to the United States for liquidated damages. Such liquidated damages shall be computed with respect to each individual laborer or mechanic, including watchmen and guards, employed in violation of the clause set forth in paragraph (1) of this section, in the sum of \$ 10 for each calendar day on which such individual was required or permitted to work in excess of the standard workweek of forty hours without payment of the overtime wages required by the clause set forth in paragraph (1) of this section.
- c. **Withholding for unpaid wages and liquidated damages** - The purchaser(s) shall upon its own action or upon written request of an authorized representative of the Department of Labor withhold or cause to be withheld, from any moneys payable on account of work performed by the Contractor or subcontractor under any such contract or any other Federal contract with the same prime Contractor, or any other federally-assisted contract subject to the Contract Work Hours and Safety Standards Act, which is held by the same prime Contractor, such sums as may be determined to be necessary to satisfy any liabilities of such Contractor or subcontractor for unpaid wages and liquidated damages as provided in the clause set forth in paragraph (2) of this section.
- d. **Subcontracts** - The Contractor or subcontractor shall insert in any subcontracts the clauses set forth in this section and also a clause requiring the subcontractors to include these clauses in any lower tier subcontracts. The prime Contractor shall be responsible for compliance by any subcontractor or lower tier subcontractor with the clauses set forth in this section.
- e. **Payrolls and basic records** - Payrolls and basic records relating thereto shall be

maintained by the Contractor during the course of the work and preserved for a period of three years thereafter for all laborers and mechanics working at the site of the work (or under the United States Housing Act of 1937, or under the Housing Act of 1949, in the construction or development of the project). Such records shall contain the name, address, and social security number of each such worker, his or her correct classification, hourly rates of wages paid (including rates of contributions or costs anticipated for bona fide fringe benefits or cash equivalents thereof of the types described in section 1(b)(2)(B) of the Davis-Bacon Act), daily and weekly number of hours worked, deductions made and actual wages paid. Whenever the Secretary of Labor has found under 29 CFR 5.5(a)(1)(iv) that the wages of any laborer or mechanic include the amount of any costs reasonably anticipated in providing benefits under a plan or program described in section 1(b)(2)(B) of the Davis-Bacon Act, the Contractor shall maintain records which show that the commitment to provide such benefits is enforceable, that the plan or program is financially responsible, and that the plan or program has been communicated in writing to the laborers or mechanics affected, and records which show the costs anticipated or the actual cost incurred in providing such benefits. Contractors employing apprentices or trainees under approved programs shall maintain written evidence of the registration of apprenticeship programs and certification of trainee programs, the registration of the apprentices and trainees, and the ratios and wage rates prescribed in the applicable programs.

1.26 NO OBLIGATION BY THE FEDERAL GOVERNMENT

The Purchaser and Contractor acknowledge and agree that, notwithstanding any concurrence by the Federal Government in or approval of the solicitation or award of the underlying contract, absent the express written consent by the Federal Government, the Federal Government is not a party to this Purchasing Agreement and shall not be subject to any obligations or liabilities to the Purchaser, Contractor, or any other party (whether or not a party to that Purchasing Agreement) pertaining to any matter resulting from the underlying Purchasing Agreement. The Contractor agrees to include the above clause in each subcontract financed in whole or in part with Federal assistance provided by FTA. It is further agreed that the clause shall not be modified, except to identify the subcontractor who will be subject to its provisions.

1.27 PROGRAM FRAUD AND FALSE OR FRAUDULENT STATEMENTS AND RELATED ACTS

- a. The Contractor acknowledges that the provisions of the Program Fraud Civil Remedies Act of 1986, as amended, 31 U.S.C. § 3801 *et seq.* and U.S. DOT regulations, "Program Fraud Civil Remedies," 49 C.F.R. Part 31, apply to its actions pertaining to this Project. Upon execution of the underlying Purchasing Agreement, the Contractor certifies or affirms the truthfulness and accuracy of any statement it has made, it makes, it may make, or causes to be made, pertaining to the underlying Purchasing Agreement or the FTA assisted project for which this Purchasing Agreement work is being performed.

In addition to other penalties that may be applicable, the Contractor further acknowledges that if it makes, or causes to be made, a false, fictitious, or fraudulent claim, statement, submission, or certification, the Federal Government reserves the right to impose the penalties of the Program Fraud Civil Remedies Act of 1986 on the Contractor to the extent the Federal Government deems appropriate.

- b. The Contractor also acknowledges that if it makes, or causes to be made, a false, fictitious, or fraudulent claim, statement, submission, or certification to the Federal Government under a contract connected with a project that is financed in whole or in part with Federal assistance originally awarded by FTA under the authority of 49 U.S.C. § 5307, the Government reserves the right to impose the penalties of 18 U.S.C. § 1001 and 49 U.S.C. § 5307(n)(1) on the Contractor, to the extent the Federal Government deems appropriate.
- c. The Contractor agrees to include the above two clauses in each subcontract financed in whole or in part with Federal assistance provided by FTA. It is further agreed that the clauses shall not be modified, except to identify the subcontractor who will be subject to the provisions.

1.28 TERMINATION

- a. If the Contractor does not deliver supplies in accordance with the contract delivery schedule or the Contractor fails to perform in the manner called for in the contract, or if the Contractor fails to comply with any other provisions of the contract, the TRIPS may terminate this Purchasing Agreement for default. Termination shall be effected by serving a notice of termination on the Contractor, setting forth the manner in which the Contractor is in default. The Contractor will only be paid the contract price for supplies delivered and accepted, or services performed in accordance with the manner of performance set forth in the contract.
- b. If it is later determined by the TRIPS that the Contractor had an excusable reason for not performing, such as a strike, fire or flood, events which are not the fault of or are beyond the control of the Contractor, the TRIPS, after setting up a new delivery of performance schedule, may allow the Contractor to continue work, or treat the termination as a termination for convenience.

1.29 CERTIFICATION REGARDING DEBARMENT, SUSPENSION, AND OTHER RESPONSIBILITY MATTERS - Lower Tier Covered Transactions (Third Party Contracts over \$100,000).

- a. By signing and submitting this proposal or proposal, the prospective lower tier participant is providing the signed certification set out below.
- b. The certification in this clause is a material representation of fact upon which reliance

was placed when this transaction was entered into. If it is later determined that the prospective lower tier participant knowingly rendered an erroneous certification, in addition to other remedies available to the Federal Government, the TRIPS may pursue available remedies, including suspension and/or debarment.

- c. The prospective lower tier participant shall provide immediate written notice to the TRIPS if at any time the prospective lower tier participant learns that its certification was erroneous when submitted or has become erroneous by reason of changed circumstances.
- d. The terms "covered transaction," "debarred," "suspended," "ineligible," "lower tier covered transaction," "participant," "persons," "lower tier covered transaction," "principal," "proposal," and "voluntarily excluded," as used in this clause, have the meanings set out in the Definitions and Coverage sections of rules implementing Executive Order 12549 [49 CFR Part 29]. You may contact the TRIPS for assistance in obtaining a copy of those regulations.
- e. The prospective lower tier participant agrees by submitting this proposal that, should the proposed covered transaction be entered into, it shall not knowingly enter into any lower tier covered transaction with a person who is debarred, suspended, declared ineligible, or voluntarily excluded from participation in this covered transaction, unless authorized in writing by the TRIPS.
- f. The prospective lower tier participant further agrees by submitting this proposal that it will include the clause titled "Certification Regarding Debarment, Suspension, Ineligibility and Voluntary Exclusion - Lower Tier Covered Transaction", without modification, in all lower tier covered transactions and in all solicitations for lower tier covered transactions.
- g. A participant in a covered transaction may rely upon a certification of a prospective participant in a lower tier covered transaction that it is not debarred, suspended, ineligible, or voluntarily excluded from the covered transaction, unless it knows that the certification is erroneous. A participant may decide the method and frequency by which it determines the eligibility of its principals. Each participant may, but is not required to, check the Non-procurement List issued by U.S. General Service Administration.
- h. Nothing contained in the foregoing shall be construed to require establishment of system of records in order to render in good faith the certification required by this clause. The knowledge and information of a participant is not required to exceed that which is normally possessed by a prudent person in the ordinary course of business dealings.
- i. Except for transactions authorized under Paragraph (e) of these instructions, if a participant in a covered transaction knowingly enters into a lower tier covered

transaction with a person who is suspended, debarred, ineligible, or voluntarily excluded from participation in this transaction, in addition to all remedies available to the Federal Government, the TRIPS may pursue available remedies including suspension and/or debarment.

1.30 CERTIFICATION REGARDING DEBARMENT, SUSPENSION, INELIGIBILITY AND VOLUNTARY EXCLUSION - Lower Tier Covered Transaction

- a. The prospective lower tier participant certifies, by submission of this proposal or proposal, that neither it nor its "principals" [as defined at 49 C.F.R. § 29.105(p)] is presently debarred, suspended, proposed for debarment, declared ineligible, or voluntarily excluded from participation in this transaction by any Federal department or agency.
- b. When the prospective lower tier participant is unable to certify to the statements in this certification, such prospective participant shall attach an explanation to this proposal.

1.31 CIVIL RIGHTS

The following requirements apply to the underlying contract:

- a. Nondiscrimination - In accordance with Title VI of the Civil Rights Act, as amended, 42 U.S.C. § 2000d, section 303 of the Age Discrimination Act of 1975, as amended, 42 U.S.C. § 6103, section 203 of the Americans with Disabilities Act of 1990, 42 U.S.C. § 12132, and Federal transit law at 49 U.S.C. § 5332, the Contractor agrees that it will not discriminate against any employee or applicant for employment because of race, color, creed, national origin, sex, age, or disability. In addition, the Contractor agrees to comply with applicable Federal implementing regulations and other implementing requirements FTA may issue.
- b. Equal Employment Opportunity - The following equal employment opportunity requirements apply to the underlying contract:
 - (1) Race, Color, Creed, National Origin, Sex - In accordance with Title VII of the Civil Rights Act, as amended, 42 U.S.C. § 2000e, and Federal transit laws at 49 U.S.C. § 5332, the Contractor agrees to comply with all applicable equal employment opportunity requirements of U.S. Department of Labor (U.S. DOL) regulations, "Office of Federal Contract Compliance Programs, Equal Employment Opportunity, Department of Labor," 41 C.F.R. Parts 60 et seq ., (which implement Executive Order No. 11246, "Equal Employment Opportunity," as amended by Executive Order No. 11375, "Amending Executive Order 11246 Relating to Equal Employment Opportunity," 42 U.S.C. § 2000e note), and with any applicable Federal statutes, executive orders, regulations, and Federal policies that may in the future affect construction activities undertaken in the course of the Project. The Contractor agrees to take

affirmative action to ensure that applicants are employed, and that employees are treated during employment, without regard to their race, color, creed, national origin, sex, or age. Such action shall include, but not be limited to, the following: employment, upgrading, demotion or transfer, recruitment or recruitment advertising, layoff or termination; rates of pay or other forms of compensation; and selection for training, including apprenticeship. In addition, the Contractor agrees to comply with any implementing requirements FTA may issue.

- (2) Age - In accordance with section 4 of the Age Discrimination in Employment Act of 1967, as amended, 29 U.S.C. § 623 and Federal transit law at 49 U.S.C. § 5332, the Contractor agrees to refrain from discrimination against present and prospective employees for reason of age. In addition, the Contractor agrees to comply with any implementing requirements FTA may issue.
- (3) Disabilities - In accordance with section 103 of the Americans with Disabilities Act, as amended, 42 U.S.C. § 12112, the Contractor agrees that it will comply with the requirements of U.S. Equal Employment Opportunity Commission, "Regulations to Implement the Equal Employment Provisions of the Americans with Disabilities Act," 29 C.F.R. Part 1630, pertaining to employment of persons with disabilities. In addition, the Contractor agrees to comply with any implementing requirements FTA may issue.

- c. The Contractor also agrees to include these requirements in each subcontract financed in whole or in part with Federal assistance provided by FTA, modified only if necessary to identify the affected parties.

1.32 BREACHES AND DISPUTE RESOLUTION

Disputes arising in the performance of this Purchasing Agreement which are not resolved by agreement of the parties shall be decided by the Florida Department of Transportation. This decision shall be final and conclusive unless within ten (10) days from the date of receipt of its copy, the Contractor mails or otherwise furnishes a written appeal to the Florida Department of Transportation. Any appeal of decisions of the Florida Department of Transportation shall be filed and administered by the "Administrative Procedures Act," Chapter 120, Florida Statutes.

Should either party to the contract suffer injury or damage to person or property because of any act or omission of the party or of any of his employees, agents or others for whose acts he is legally liable, a claim for damages therefore shall be made in writing to such other party within a reasonable time after the first observance of such injury of damage.

Unless this Purchasing Agreement provides otherwise, all claims, counterclaims, disputes and other matters in question between the TRIPS and the Contractor arising out of or relating to

this agreement or its breach will be decided by arbitration if the parties mutually agree, or in a court of competent jurisdiction within the State of Florida.

The duties and obligations imposed by the contract documents and the rights and remedies available hereunder shall be in addition to and not a limitation of any duties, obligations, rights and remedies otherwise imposed or available by law. No action or failure to act by the TRIPS or the Contractor shall constitute a waiver of any right or duty afforded any of them under the contract, nor shall any such action or failure to act constitute an approval of or acquiescence in any breach there under, except as may be specifically agreed in writing.

1.33 DISADVANTAGED BUSINESS ENTERPRISE (DBE)

It is the policy of the TRIPS that Disadvantaged Business enterprises as defined in 49 CFR 26.49 shall have the maximum opportunity to participate in the performance of contracts financed in whole or in part with Federal funds under this agreement. Consequently the DBE requirements of 49 CFR 26.49 applies to this agreement.

The TRIPS Program Administrator on behalf of the Purchasers, or their Contractor, agree to ensure Disadvantaged Business Enterprises as defined in 49 CFR 26.49 have the maximum opportunity to participate in the performance of contracts and subcontracts financed in whole or in part with Federal funds provided under this agreement. In this regard, the Purchasers, or their Contractors, shall take all necessary and reasonable steps in accordance with 49 CFR 26.49 to ensure that Disadvantaged Business Enterprises have the maximum opportunity to compete for and perform contracts. The TRIPS Program Administrator on behalf of the Purchasers and their Contractors shall not discriminate on the basis of race, color, national origin, or sex in the award and performance of DOT assisted contracts.

1.34 STATE AND LOCAL LAW DISCLAIMER

The use of many suggested clauses are not governed by Federal law, but are significantly affected by State law. The language of the suggested clauses may need to be modified depending on state law. Before the suggested clauses are used in the grantees procurement documents, the grantees should consult their local attorney.

1.35 INCORPORATION OF FEDERAL TRANSIT ADMINISTRATION (FTA) TERMS

The preceding provisions include, in part, certain Standard Terms and Conditions required by DOT, whether or not expressly set forth in the preceding contract provisions. All contractual provisions required by DOT, as set forth in FTA Circular 4220.1F, dated March 18, 2013, are hereby incorporated by reference. Anything to the contrary herein notwithstanding, all FTA mandated terms shall be deemed to control in the event of a conflict with other provisions contained in this Agreement. The Contractor shall not perform any act, fail to perform any act, or refuse to comply with any grantees' requests that would cause the grantee to be in violation of the FTA terms and conditions.

EXHIBIT 1

FORMULA FOR COMPUTATION OF SECOND STAGE PRICE ESCALATION

Escalation will be calculated based on the following formula, which utilizes the U.S. Department of Labor/Bureau of Labor Statistics Producer Price Index (PPI) Industry Data. **Industry: Motor Vehicle Body Manufacturing; Product: Buses and Firefighting vehicles, complete, produced on purchased chassis; Series ID: PCU3362113362117**** In no event will the prices for any purchase release exceed, by more than 5%, the price(s) that would have been in effect twelve (12) months prior to the date of the release or the base price of the purchase order release if less than twelve (12) months after the initial contract award.

<u>Index Point Change</u>	<u>Examples</u>
PPI Index: Future Re-comp Month	141.1
Less PPI Index: Base Award Month	137.5
Equals Index Point Change	3.5

<u>Index Percent Change</u>	<u>Examples</u>
Index Point Change	3.5
Divided by PPI Index: Base Award Month	137.5
Equals	0.0254
Results multiplied by 100 equals Percent Change	2.54%

Total price of standard bus	=	\$42,850.00
Minus price of chassis	=	\$27,050.00
Equals total second stage price	=	\$15,800.00

“Certain Dollar Amount” = Cost of second stage price divided by 100

Certain Dollar Amount = $15,800 / 100 = 158$

Price of second stage will change \$158.00 per 1 percent movement in the producer price index (PPI)

In this example, 2.54% times \$158.00 equals \$401.32. This could be added to the total cost of the add-ons per bus. Chassis increase would be added separately per instructions in Section 1.2. Once recompilation of second stage pricing is completed, the last Re-comp month becomes the new award month.

** = *If discontinued, Category PCU3362113362119 “Other Trucks/Vehicles, complete, produced on purchased chassis:” will be used.*

NOTE: These figures provided for illustrative purposes only.

EXHIBIT 2

FDOT DISTRICT OFFICES

Debbie Stephens
FDOT District One
PO Box 1030
Fort Myers, FL 33902-10
(239) 225-1982

Janell Damato
FDOT District Two
2198 Edison Avenue, MS 2813
Jacksonville, FL 32204
(904) 360-5687

Kathy Rudd
FDOT District Three
1074 Hwy 90
Chipley, FL 32428-0607
(850) 330-1549

Jayne Pietrowski
FDOT District Four
3400 W. Commercial Blvd.
Ft. Lauderdale, FL 33309
(954) 777-4661

Sophia Villavicencio
FDOT District Five
133 S. Semoran Blvd.
Orlando, FL 32807
(407) 482-7887

Raymond Freeman
FDOT District Six
1000 N. W. 111th Ave., Room 6105
Miami, FL 33172
(305) 470-5255

Elba Lopez
FDOT District Seven
11201 N. McKinley Dr.
Tampa, FL 33612-6403
(813) 975-6402

EXHIBIT 3

VEHICLE DELIVERY CHECKLIST

The below items must be presented at time of delivery of vehicle to agency or vehicle will be considered non-acceptable.

- Vehicle properly serviced, clean and in first class operating condition. Includes front end alignment, wheels balanced, unnecessary stickers removed
- Proper "Application for Registration"
- GVWR - either on Certificate of Origin or Registration
- Four Wheel Weight Analysis Certification
- Odometer Certification
- "As Built" Wiring diagrams and chassis electrical manuals
- Service, chassis service and "As Built" Parts manuals
- Operator's manual
- Dealer Invoice
- Spare key(s)

- ❑ Bill of sale
- ❑ Warranty papers (forms, policy, procedures)
- ❑ Maintenance schedule
- ❑ Post-Delivery Audit documents-
 - ✓ Buy America Certificate and documentation annotating percentage breakdown and percentages, location and items present during final assembly (post-delivery breakdown document)
 - ✓ FMVSS
 - ✓ Specifications
- ❑ Blank Acceptance / Rejection Notification
- ❑ FDOT AMP Draw Analysis Worksheet

TRIPS PURCHASING AGREEMENT # TRIPS-17-CA-FTS-G

PRE-AWARD REVIEW CERTIFICATIONS

Edward Bart, acting on behalf of agencies purchasing vehicles under the contract established by TRIPS Proposal # TRIPS-17-CA-RFP, certifies the following:

I. PRE-AWARD BUY AMERICA COMPLIANCE CERTIFICATION

As required by Title 49 of the CFR, Part 663 - Subpart B, the recipient is satisfied that the buses to be purchased from Florida Transportation Systems, Inc. meet the requirements of Section 165(b)(3) of the Surface Transportation Assistance Act of 1982, as amended. The recipient has reviewed documentation provided by the manufacturer, which lists (1) the proposed component and subcomponent parts of the buses identified by manufacturer, country of origin, and cost; and (2) the proposed location of the final assembly point for the buses, including a description of the activities that will take place at the final assembly point and cost of final assembly.

Date: March 21, 2017

Signature:  Title: Program Administrator

II. PRE-AWARD PURCHASER'S REQUIREMENTS CERTIFICATION

As required by Title 49 of the CFR, Part 663 - Subpart B, the buses to be purchased from Florida Transportation Systems, Inc. are the same product described in the recipient's solicitation specification and that the proposed manufacturer is a responsible manufacturer with the capability to produce a bus that meets the specifications.

Date: March 21, 2017

Signature:  Title: Program Administrator

III. PRE-AWARD FMVSS COMPLIANCE CERTIFICATION

As required by Title 49, of the CFR, Part 663 - Subpart D, a copy of Florida Transportation Systems, Inc. self-certification information stating that the buses will comply with the relevant Federal Motor Vehicle Safety Standards issued by the National Highway Traffic Safety Administration in Title 49 of the Code of Federal Regulations, Part 571 has been submitted.

Date: March 21, 2017

Signature:  Title: Program Administrator

**Florida Department of Transportation
Office of Freight, Logistics and Passenger Operations**

Part 1

NOTE: PROPOSERS MUST USE THE FORMS PROVIDED. FAILURE TO DO SO WILL RESULT IN A NON-RESPONSIVE PROPOSAL.

1. PROPOSAL ACKNOWLEDGMENT

Gentlemen:

The undersigned, as proposer, hereby declares that the only person interested in this Proposal as principal are named herein and that no person other than herein mentioned has any interest in this Proposal or in the Purchasing Agreement to be entered into; that this Proposal is made without connection with any other person, company or parties making a Proposal; and that it is in all respects fair and in good faith without collusion or fraud.

The proposer further declares that they have examined the Proposal documents and informed themselves of all conditions pertaining to this requirement and have also examined other contract documents relative thereto and has read all of the addenda furnished before the opening of the Proposal, as acknowledged below; and that they have satisfied themselves about the work to be performed.

The proposer agrees, if this Proposal is accepted, to contract with the Purchasers, to furnish all necessary materials, equipment, apparatus, means of transportation and labor necessary to provide the units covered by this Proposal and other contract documents of this project entitled:

Transit Research Inspection Procurement Services Program

TRIPS CONTRACT PROPOSAL #TRIPS-17-CA-RFP

It is understood that the prices stated by the undersigned in the Price Proposal are one of the considerations in determining award of the Purchasing Agreement.

Acknowledgment is hereby made of the following addenda (identified by number) received since issuance of Specifications:

Addendum 1

Addendum 2

Addendum 3

DEALER

Date 4/4/17

Signature [Handwritten Signature]

Company Name Florida Transportation Systems, Inc

Title Commercial Sales Manager

MANUFACTURER

Date 4-6-17

Signature [Handwritten Signature]

Company Name Goshen Coach

Title Bid Manager

9. STANDARD ASSURANCES

Federal Requirements for Invitation for Proposal

I, Robert Frick, representing the Proposer, certify that I have read and understand all terms and conditions of the Federal Requirements for Invitation for Proposal and, if awarded this proposal, will comply with all terms and conditions contained therein.

Comptroller General's Proposer's Certification

Florida Transportation Systems Inc hereby certifies that they are NOT on the Comptroller General's list of ineligible Contractors. Manufacturers appearing on said list will be considered ineligible.

Other Assurances

I, Robert Frick, representing the Proposer, assure that the Proposer is licensed to sell vehicles in the State of Florida, under license # VF/1062254/1.

Florida Transportation Systems Inc assures that equipment proposal will meet or exceed all specifications, and that all equipment and items specified in the vehicle specifications arrive with the vehicle at time of delivery to the Purchaser.

Florida Transportation Systems Inc assures that local representation of the manufacturer has been secured and will be liable for warranty work on the vehicle(s).

DEALER

MANUFACTURER

Date 12/01/2016

Date 12-10-2016

Signature [Signature]

Signature [Signature]

Company Name Florida Transportation Systems Inc.

Company Name GOSHEN COACH

Title Commercial Sales Manager

Title Bid Manager

10. CERTIFICATION REQUIREMENT FOR PROCUREMENT OF STEEL, IRON, OR
MANUFACTURED PRODUCTS

Certificate of Compliance with 49 U.S.C. 5323(j)(1)

The proposer or Offeror hereby certifies that it will meet the requirements of 49 U.S.C. 5323(j)(1) and the applicable regulations in 49 CFR Part 661.

DEALER

MANUFACTURER

Date 12/21/2016

Date 12-10-2016

Signature [Handwritten Signature]

Signature [Handwritten Signature]

Company Name Florida Transportation Systems Inc

Company Name GOSHEN COACH

Title Commercial Sales Manager

Title BID MANAGER.

Certificate of Non-Compliance with 49 U.S.C. 5323(j)(1)

The proposer or Offeror hereby certifies that it cannot comply with the requirements of 49 U.S.C. 5323(j)(1), but it may qualify for an exception pursuant to 49 U.S.C. 5323(j)(2)(B) or (j)(2)(D) and the regulations in 49 CFR 661.7.

DEALER

MANUFACTURER

Date _____

Date _____

Signature _____

Signature _____

Company Name _____

Company Name _____

Title _____

Title _____

11. CERTIFICATION REQUIREMENT FOR PROCUREMENT OF BUSES, OTHER ROLLING STOCK AND ASSOCIATED EQUIPMENT

(Applicable to purchases over \$100,000.00)

Certificate of Compliance with 49 U.S.C. 5323(j)(2)(C).

The proposer or Offeror hereby certifies that it will comply with the requirements of 49 U.S.C. 5323(j)(2)(C) and the regulations at 49 CFR Part 661.

DEALER

MANUFACTURER

Date 12-21-2016

Date 12-10-2016

Signature [Handwritten Signature]

Signature [Handwritten Signature]

Company Name Florida Transportation Systems Inc

Company Name GOSHEN COACH

Title Commercial Sales Manager

Title BID MANAGER.

Certificate of Non-Compliance with 49 U.S.C. 5323(j)(2)(C)

The proposer or Offeror hereby certifies that it cannot comply with the requirements of 49 U.S.C. 5323(j)(2)(C), but may qualify for an exception pursuant to 49 U.S.C. 5323(j)(2)(B) or (j)(2)(D) and the regulations in 49 CFR 661.7.

DEALER

MANUFACTURER

Date _____

Date _____

Signature _____

Signature _____

Company Name _____

Company Name _____

Title _____

Title _____

**12. BUY AMERICA CERTIFICATE OF COMPLIANCE WITH FTA
REQUIREMENTS FOR BUSES, OTHER ROLLING STOCK, OR ASSOCIATED
EQUIPMENT**

(To be submitted with a proposal or offer exceeding the small purchase threshold for Federal assistance programs, currently set at \$100,000.)

Certificate of Compliance

The proposer hereby certifies that it will comply with the requirements of 49 U.S.C. Section 5323(j)(2)(C), Section 165(b)(3) of the Surface Transportation Assistance Act of 1982, as amended, and the regulations of 49 C.F.R. 661.11:

DEALER

MANUFACTURER

Date 12-21-2016

Date 12-10-2016

Signature [Handwritten Signature]

Signature [Handwritten Signature]

Company Name Florida Transportation Systems Inc

Company Name GOSHEN COACH

Title Commercial Sales Manager

Title BID MANAGER.

13. CERTIFICATION OF COMPLIANCE WITH FTA'S BUS TESTING
REQUIREMENTS

The undersigned [Contractor/Manufacturer] certifies that the vehicle offered in this procurement complies with 49 U.S.C. A 5323© and FTA's implementing regulation at 49 CFR Part 665.

The undersigned understands that misrepresenting the testing status of a vehicle acquired with Federal financial assistance may subject the undersigned to civil penalties as outlined in the Department of Transportation's regulation on Program Fraud Civil Remedies, 49 CFR Part 31. In addition, the undersigned understands that FTA may suspend or debar a manufacturer under the procedures in 49 CFR Part 29.

DEALER

MANUFACTURER

Date 12-21-2016

Date 12-10-2016

Signature [Handwritten Signature]

Signature [Handwritten Signature]

Company Name Florida Transportation Systems Inc.

Company Name GOSHEN COACH

Title Commercial Sales Manager

Title BID MANAGER.

14. CERTIFICATION REGARDING LOBBYING

(To be submitted with each proposal or offer exceeding \$100,000)

The undersigned [Contractor] certifies, to the best of his or her knowledge and belief, that:

1. No Federal appropriated funds have been paid or will be paid, by or on behalf of the undersigned, to any person for influencing or attempting to influence an officer or employee of an agency, a Member of Congress, an officer or employee of Congress, or an employee of a Member of Congress in connection with the awarding of any Federal contract, the making of any Federal grant, the making of any Federal loan, the entering into of any cooperative agreement, and the extension, continuation, renewal, amendment, or modification of any Federal contract, grant, loan, or cooperative agreement.

2. If any funds other than Federal appropriated funds have been paid or will be paid to any person for making lobbying contacts to an officer or employee of any agency, a Member of Congress, an officer or employee of Congress, or an employee of a Member of Congress in connection with this Federal contract, grant, loan, or cooperative agreement, the undersigned shall complete and submit Standard Form--LLL, "Disclosure Form to Report Lobbying," in accordance with its instructions [as amended by "Government wide Guidance for New Restrictions on Lobbying," 61 Fed. Reg. 1413 (1/19/96). Note: Language in paragraph (2) herein has been modified in accordance with Section 10 of the Lobbying Disclosure Act of 1995 (P.L. 104-65, to be codified at 2 U.S.C. 1601, *et seq.*)]

3. The undersigned shall require that the language of this certification be included in the award documents for all sub-awards at all tiers (including subcontracts, sub-grants, and contracts under grants, loans, and cooperative agreements) and that all sub-recipients shall certify and disclose accordingly.

This certification is a material representation of fact upon which reliance was placed when this transaction was made or entered into. Submission of this certification is a prerequisite for making or entering into this transaction imposed by 31, U.S.C. § 1352 (as amended by the Lobbying Disclosure Act of 1995). Any person who fails to file the required certification shall be subject to a civil penalty of not less than \$10,000 and not more than \$100,000 for each such failure.

[Note: Pursuant to 31 U.S.C. § 1352(c)(1)-(2)(A), any person who makes a prohibited expenditure or fails to file or amend a required certification or disclosure form shall be subject to a civil penalty of not less than \$10,000 and not more than \$100,000 for each such expenditure or failure.]

The Contractor, _____, certifies or affirms the truthfulness and accuracy of each statement of its certification and disclosure, if any. In addition, the Contractor understands and agrees that the provisions of 31 U.S.C. A 3801, *et seq.*, apply to this certification and disclosure, if any.

DEALER

MANUFACTURER

Signature of Contractor's Authorized Official:

[Handwritten Signature]

Signature of Contractor's Authorized Official:

[Handwritten Signature]

Name and Title of Contractor's Authorized Official:

Robert Frick Commercial Sales Mgr.

Name and Title of Contractor's Authorized Official:

JOE BRADSHAW VP/GM

Date 12-21-2016

Date 12-10-2016

15. DISADVANTAGED BUSINESS ENTERPRISE TVM CERTIFICATION

The proposer, if a transit vehicle manufacturer (TVM), hereby certifies that it has complied with the requirements of 49 CFR, Section 26.49 by submitting an annual DBE / WBE goal to the Federal Transit Administration (FTA). The goal has either been approved or not approved by FTA.

The proposer, if a Dealer or non-manufacturer supplier, hereby certifies that the manufacturer of the transit vehicle to be supplied has complied with the above-referenced requirement of 49 CFR~ Section. 26.49.

DEALER

MANUFACTURER

Date 12-21-2016

Date 12-10-2016

Signature [Handwritten Signature]

Signature [Handwritten Signature]

Company Name Florida Transportation Systems Inc.

Company Name GOSHEN COACH

Title Commercial Sales Manager

Title BID MANAGER

NOTE: An approved annual FTA certification must be received before a contract extension can be considered for each year.

16. MOTOR VEHICLE SAFETY STANDARDS CERTIFICATION

Certification of Compliance with all safety related items contained in Part 2: Technical Specifications.

The Proposer hereby certifies that it shall comply with the safety related requirements contained in Part 2: Technical Specifications (reference Federal Register Vol. 47, No. 195, Oct. 7, 1982 FTA Docket Nov. 81-3).

DEALER

MANUFACTURER

Date 12-21-2016

Date 12-10-2016

Signature [Handwritten Signature]

Signature [Handwritten Signature]

Company Name Florida Transportation Systems Inc

Company Name GOSHEN COACH

Title Commercial Sales Manager

Title BID MANAGER

**17. TITLE VI CIVIL RIGHTS ACT OF 1964
CONTRACTOR AGREEMENT**

During the performance of this Purchasing Agreement, the Contractor, for itself, its assignees and successors in interest (hereinafter referred to as the "Contractor"), agrees as follows:

(1) **Compliance with Regulations:** The Contractor shall comply with the Regulations relative to nondiscrimination in federally-assisted programs of the Department of Transportation (hereinafter, "DOT") Title 49, Code of Federal Regulations, Part 21, as they may be amended from time to time (hereinafter referred to as the Regulations), which are herein incorporated by reference and made a part of this Purchasing Agreement.

(2) **Nondiscrimination:** The Contractor, with regard to the work performed by it during the Purchasing Agreement, shall not discriminate on the grounds of race, religion, color, sex, age, national origin, or disability in the selection and retention of subcontractors, including procurement of materials and leases of equipment. The Contractor shall not participate either directly or indirectly in the discrimination prohibited by Section 21.5 of the Regulations, including employment practices when the Contract covers a program set forth in Appendix B of the Regulations.

(3) **Solicitations for Subcontracts, including procurement of materials and equipment:** In all solicitations either by competitive Proposal or negotiation made by the Contractor for work to be performed under a subcontract, including procurement of materials or leases of equipment, each potential subcontractor or supplier shall be notified by the Contractor of the Contractor's obligations under this Purchasing Agreement and the Regulations relative to nondiscrimination on the grounds of race, religion, color, sex, age, national origin, or disability.

(4) **Information and Reports:** The Contractor shall provide all information and reports required by the Regulations or directives issued pursuant thereto, and shall permit access to its books, records, accounts, other sources of information, and its facilities as may be determined by the Recipient or the FTA to be pertinent to ascertain compliance with such Regulations, orders and instructions. Where any information is required or a Contractor is in the exclusive possession of another who fails or refuses to furnish this information, the Contractor shall so certify to the TRIPS, or the FTA, as appropriate, and shall set forth what efforts it has made to obtain the information.

17. TITLE VI CIVIL RIGHTS ACT OF 1964
CONTRACTOR AGREEMENT

(5) Sanctions for Noncompliance: In the event of the Contractor's noncompliance with the nondiscrimination provisions of this Purchasing Agreement, the TRIPS shall impose such Contract sanctions as it or the FTA may determine to be appropriate, including but not limited to:

- (a) Withholding of payments to the Contractor under the Contract until the Contractor complies, and/or
- (b) Cancellation, termination or suspension of the Purchasing Agreement, in whole or in part.

(6) Incorporation of Provisions: The Contractor shall include the provisions of paragraph (1) through (6) of this section in every subcontract, including procurement of materials and leases of equipment, unless exempt by the Regulations, or directives issued pursuant thereto. The Contractor shall take such action with respect to any subcontract or procurement as the TRIPS or the FTA may direct as a means of enforcing such provisions including sanctions for noncompliance: Provided, however, that, in the event a Contractor becomes involved in, or is threatened with, litigation with a subcontractor or supplier as a result of such direction, the Contractor may request the TRIPS to enter into such litigation to protect the interests of the TRIPS, and in addition, the Contractor may request the services of the Attorney General in such litigation to protect the interests of the United States.

DEALER

MANUFACTURER

Date 12-21-2016

Date 12-10-2016

Signature [Handwritten Signature]

Signature [Handwritten Signature]

Company Name Florida Transportation Systems Inc.

Company Name GOSHEN COACH

Title Commercial Sales Manager

Title BO MANAGER

18. CERTIFICATION OF COMPLIANCE WITH
THE AMERICANS WITH DISABILITIES ACT OF 1990

The Proposer hereby certifies that it shall comply with all requirements contained in Part 2: Technical Specifications relating to bus design or special equipment required by the Americans with Disabilities Act of 1990.

DEALER

MANUFACTURER

Date 10-21-2016

Date 12-10-2016

Signature [Handwritten Signature]

Signature [Handwritten Signature]

Company Name Florida Transportation Systems Inc.

Company Name GOSHEN COACH

Title Commercial Sales Manager

Title Dist MANAGER

19. DEBARRED BIDDERS / INTEGRITY CERTIFICATION

Certification Regarding Debarment, Suspension, Ineligibility, and Voluntary Exclusion

1. Lower tier participant certifies, by submission of this bid proposal, that neither it nor its "principals" (as defined at 49 CFR Part 29) is presently debarred, suspended, proposed for debarment, declared ineligible, or voluntarily excluded from participating in this transaction by any Federal department or agency.
2. When the prospective lower tier participant is unable to certify to the statements in this certification, such prospective participant shall attach an explanation to this proposal.

DEALER

MANUFACTURER

Date 12-21-2016

Date 12-10-2016

Signature [Handwritten Signature]

Signature [Handwritten Signature]

Company Name Florida Transportation Systems Inc

Company Name GOSHEN COACH

Title Commercial Sales Manager

Title BID MANAGER.

20. E-VERIFY CERTIFICATION

Vendor/Contractor shall utilize the U.S. Department of Homeland Security's E-Verify system, in accordance with the terms governing use of the system, to confirm the employment eligibility of;

- 1. all persons employed by the Vendor/Contractor during the term of the Contract to perform employment duties within Florida; and
- 2. all persons, including subcontractors, assigned by the Vendor/Contractor to perform work pursuant to the contract with the Department.

DEALER

MANUFACTURER

Date 12-21-2016

Date 12-10-2016

Signature [Handwritten Signature]

Signature [Handwritten Signature]

Company Name Florida Transportation Systems Inc

Company Name GOSHEN COACH

Title Commercial Sales Manager

Title BIO MANAGER

BAFO

PRICE PROPOSAL FORM A

(Base Gas Engine Vehicle Price)

Base vehicle **includes** base W/C lift, base fire suppression, and base A/C

CHASSIS	CHASSIS PRICE
Cutaway Type Vehicle Chassis Chassis Manufacturer <u>FORD</u> Chassis GVWR (<i>pounds</i>) <u>11,500</u> Vehicle length (<i>feet/inches</i>) <u>260"</u>	\$ <u>22,639</u>
SECOND STAGE BODY	SECOND STAGE PRICE
Second Stage Body Design/Model <u>GOSHEN PACER</u>	\$ <u>39,065</u>
TOTAL PRICE	\$ <u>61,704</u>

BAFO

PRICE PROPOSAL FORM A

(Base Gas Engine Vehicle Price)

Base vehicle **includes** base W/C lift, base fire suppression, and base A/C

CHASSIS	CHASSIS PRICE
Cutaway Type Vehicle Chassis Chassis Manufacturer <u> Chevrolet </u> Chassis GVWR (<i>pounds</i>) <u> 12,300 </u> Vehicle length (<i>feet/inches</i>) <u> 263" </u>	\$ <u> 23,185 </u>
SECOND STAGE BODY	SECOND STAGE PRICE
Second Stage Body Design/Model <u> GOSHEN PACER </u>	\$ <u>38,855 </u>
TOTAL PRICE	\$ <u>62,040 </u>

BAFO

PRICE PROPOSAL FORM A

(Base Gas Engine Vehicle Price)

Base vehicle **includes** base W/C lift, base fire suppression, and base A/C

CHASSIS	CHASSIS PRICE
Cutaway Type Vehicle Chassis Chassis Manufacturer <u>Chevrolet</u> Chassis GVWR (pounds) <u>14,200</u> Vehicle length (feet/inches) <u>286"</u>	\$ <u>24,124</u>
SECOND STAGE BODY	SECOND STAGE PRICE
Second Stage Body Design/Model <u>GOSHEN IMPULSE</u>	\$ <u>40,255</u>
TOTAL PRICE	\$ <u>64,379</u>

BAFO

PRICE PROPOSAL FORM A

(Base Gas Engine Vehicle Price)

Base vehicle **includes** base W/C lift, base fire suppression, and base A/C

CHASSIS	CHASSIS PRICE
Cutaway Type Vehicle Chassis Chassis Manufacturer <u>FORD</u> Chassis GVWR (<i>pounds</i>) <u>12,500</u> Vehicle length (<i>feet/inches</i>) <u>280"</u>	\$ <u>22,855</u>
SECOND STAGE BODY	SECOND STAGE PRICE
Second Stage Body Design/Model <u>GOSHEN PACER</u>	\$ <u>39,507</u>
TOTAL PRICE	\$ <u>62,362</u>

BAFO

PRICE PROPOSAL FORM A

(Base Gas Engine Vehicle Price)

Base vehicle **includes** base W/C lift, base fire suppression, and base A/C

CHASSIS	CHASSIS PRICE
Cutaway Type Vehicle Chassis Chassis Manufacturer <u>FORD</u> Chassis GVWR (<i>pounds</i>) <u>14,500</u> Vehicle length (<i>feet/inches</i>) <u>281"</u>	\$ <u>24,258</u>
SECOND STAGE BODY	SECOND STAGE PRICE
Second Stage Body Design/Model <u>GOSHEN IMPULSE</u>	\$ <u>39,455</u>
TOTAL PRICE	\$ <u>63,713</u>

BAFO

PRICE PROPOSAL FORM A

(Base Gas Engine Vehicle Price)

Base vehicle **includes** base W/C lift, base fire suppression, and base A/C

CHASSIS	CHASSIS PRICE
Cutaway Type Vehicle Chassis Chassis Manufacturer <u>FORD</u> Chassis GVWR (<i>pounds</i>) <u>16,500</u> Vehicle length (<i>feet/inches</i>) <u>333"</u>	 \$ <u>32,640</u>
SECOND STAGE BODY	SECOND STAGE PRICE
Second Stage Body Design/Model <u>GOSHEN GFORCE</u>	 \$ <u>46,260</u>
TOTAL PRICE	 \$ <u>78,900</u>

BAFO

PRICE PROPOSAL FORM A

(Base Gas Engine Vehicle Price)

Base vehicle **includes** base W/C lift, base fire suppression, and base A/C

CHASSIS	CHASSIS PRICE
Cutaway Type Vehicle Chassis Chassis Manufacturer <u>FORD</u> Chassis GVWR (<i>pounds</i>) <u>19,500</u> Vehicle length (<i>feet/inches</i>) <u>351"</u>	\$ <u>34,085</u>
SECOND STAGE BODY	SECOND STAGE PRICE
Second Stage Body Design/Model <u>GOSHEN GFORCE</u>	\$ <u>49,765</u>
TOTAL PRICE	\$ <u>83,850</u>

TERMS OF PAYMENT

FORM F

The following terms of payment are proposed:

The agencies will submit their portion of the purchase price (local match) to the 5310 administrator at CUTR when the vehicle order is placed.

1. A 2% (24% per annum) service charge will be added to all past due accounts.
2. Total proposal price is based on payment terms of net sixty (60) days after acceptance of each vehicle. If Contractor has not received payment in full within the 60 day period following acceptance of vehicle, agencies will incur the 2% monthly service charge beginning on day 61.

The undersigned understands that any condition stated above, clarification made to the above or information submitted on or with this form, other than that requested, will render the proposal unresponsive.

Date 12/21/2016

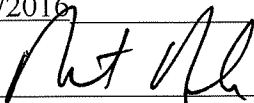
Signature 

Company Name Florida Transportation Systems, Inc.

Title Commercial Sales Manager

PART 2

TECHNICAL SPECIFICATIONS



Contract #TRIPS-17-CA-FTS-G

CUTAWAY TRANSIT VEHICLES

TECHNICAL SPECIFICATIONS

#TRIPS-17-CA-FTS-G

CUTAWAY TRANSIT VEHICLES

2.1.0 GENERAL INFORMATION

- 2.1.1 Shuttle Bus Package shall include the following: Chrome Appearance, Transmission Oil Cooler, Auxiliary Rear Heat Provisions, Tilt-Wheel, Cruise-Control, and largest fuel tank available on each model and configuration.

The first bus produced under this agreement shall be considered the “prototype” bus. After inspection of this vehicle, TRIPS reserves the right to clarify production build methods that are not specifically addressed in the technical specifications. Contract language will be revised to reflect these changes and subsequent manufactured vehicles shall include all changes as standard in production.

- 2.1.2 The vehicle shall conform in all respects to State of Florida Motor Vehicle laws (including, but not limited to, Chapter 316, Florida Statutes, Safety rules of the Department of Transportation, Chapter 14-90, promulgated under the requirements of Chapter 341, Florida Statutes) and the American with Disabilities Act, Title 49 Code of Federal Regulations, parts 38, Accessibility Specifications for Transportation Vehicles, Subpart B-Buses, Vans and Systems. This vehicle shall also comply with 40 CFR Parts 85 & 86 Air Pollution and Emission Standards for New Vehicles. Compliance with all applicable Federal Motor Vehicle Safety Standards shall also be required. The successful bidder will be required to provide any and all results of testing accomplished under the final rules issued by the Federal Transit Administration, 49 CFR Part 655 Bus Testing Program. Buses that have not met the minimum performance standards (passing score) established by the final rule effective October 31st, 2016 will not be eligible for sale from this contract. The tests include the evaluation of structural integrity and durability, safety, maintainability, reliability, fuel economy, emissions, noise, and performance (including brakes).

Test based on: 7 years/ 200,000 miles

- 2.1.3 Workmanship throughout the vehicle shall conform to the highest standards of accepted commercial practice and shall result in a neat and finished appearance. The complete vehicle(s) furnished must be of substantial and durable construction

in all respects. All sub-components must be installed per the sub-component manufacturer's standard mounting/installation/operations instructions. Any deviations on component mounting/installation/operations procedure must be approved in writing by the sub-component manufacturer and TRIPS prior to installation.

- 2.1.4 Welding procedures and materials shall be in accordance with standards of the American Society of Testing Materials and the American Welding Society. Welds not meeting these standards will be rejected. Rejection will result in the total replacement of sub-floor assemblies and/or cage assemblies. All exterior skin side welded surfaces shall be ground smooth and be free of unfriendly surfaces as part of the standard production process. All welds shall be inspected for quality and subject to on line inspection. All welding shall be performed using MIG welding machines utilizing Argon gas. All steel body/floor structure shall be coated rust inhibitor primer for corrosion protection and to prevent rust. All structural steel is galvanized and sprayed with cold galvanizing after welding. Pure Asphalt #76-M will be sprayed on all exposed bare steel/welds.
- 2.1.5 All parts, components and accessories shall be new. All exposed surfaces and edges shall be smooth, free from burrs and other projections and shall be neatly finished. The exhaust system and drive line shall be free from primer. Manufacturer shall certify that it has the equipment necessary to accomplish this task. Any sub-component installed underneath the vehicle shall not be primed.
- 2.1.6 All exposed surfaces and edges shall be smooth, free from burrs and other projections and shall be neatly finished. All fasteners used in the vehicle shall be backed by a Certificate of Quality by the manufacturer and have been found to be in accordance with all SAE and ANSI specifications.
- 2.1.7 Cutting of the chassis will not be permitted. This will be verified through serial number checks. The proposal shall include a detailed description and drawings of frame insert section. The rear overhang, measured from the center of the rear axle to the outer edge of the rear bumper, cannot exceed 1/3 of the overall vehicle length. Rear frame extensions shall be Butt-welded with a continuous weld and shall exceed the requirements of the chassis manufacturer. In addition, the FDOT requires a 4" x 12" x 1/4" steel plate to be installed and welded with a continuous weld around the entire circumference of the plate and bolted. Further, The FDOT will not allow re-certification of the chassis OEM GVWR and GAWR. Any vehicle that exceeds the OEM GVWR and/or GAWR will not be accepted. TRIPS reserves the right to accept any other chassis, meeting specifications, when offered by the manufacturer during the term of this contract.

2.1.8 All vehicles shall be weighed “as built” before release and manufacturer’s engineering department shall perform a four corner weight analysis on each vehicle that indicates the weight of the vehicle and any attachments, the maximum weight of the occupants (150 pounds per seated position and 250 pounds per wheel chair position), and the weight of a full tank of fuel for GAWR and GVWR evaluation. Vehicles shall be equipped with the largest fuel tank available for each model and configuration. A copy of the “as built” weight certification, four corner weight analysis and an “as built” floor plan shall be on each vehicle shipped to Florida for the TRIPS. The “as built” weight certification shall provide the following information for each individual bus:

- > VIN of the bus
- > Manufacturer
- > Body Serial Number
- > A description (type) of the bus
- > Date of certification
- > The number of ambulatory passenger capacity including driver
- > The number of wheelchair positions
- > Four wheel weight distribution of the actual completed weight of the bus including all attachments
- > Four wheel weight distribution of the weight of the ambulatory passengers including driver
- > Four wheel weight distribution of the weight of the wheelchairs
- > Four wheel weight distribution of the weight of the Fuel
- > Four wheel weight distribution of the total weight of the vehicle
- > Weight analysis must have signature and title of person submitting it

In addition to the manufacturer’s weight calculations and documents, TRIPS will require that the manufacturer’s complete and submit weight calculations on TRIPS Form #TRIPS-17-CA. TRIPS will perform random four wheel weight analysis at the Springhill Inspection, Testing & Research Facility in Tallahassee. The total weight at each wheel must not exceed 50% of the GAWR for that axle and GVWR must not be exceeded. Any bus that exceeds either condition will be rejected.

2.1.9 Manufacturer will be responsible for delivering vehicles that are properly serviced, clean, and in first class operating condition. Pre-delivery service, at a minimum, shall include the following:

1. Complete lubrication of chassis, engine, and operating mechanisms with manufacturer's recommended grades of lubricants.
2. Check all fluid levels to insure proper fill.
3. Ensure engine is in proper operating condition.
4. Inflate tires to proper pressure.

5. Check to insure proper operation of all components, accessories, gauges, lights, and mechanical and hydraulic features.
6. Cleaning of vehicle, and removal of all unnecessary stickers and debris.
7. Full front-end alignment utilizing heavy duty equipment and experienced trained technicians to perform proper alignment. All wheels shall be balanced, including spare tire. This alignment is to be performed only after vehicle is built complete and is at full curb weight. Vehicle shall be delivered with fully adjustable front end components installed to allow alignment in the field without replacing any components.
8. Focusing of headlights utilizing equipment designed for this purpose.

2.1.10 Manufacturer shall certify that it:

1. Has in operation or has the capacity to have in operation, a manufacturing plant.
2. Has adequate engineering personnel, or has the capability to have such personnel, to satisfy any engineering or service problem that may arise during the warranty period. Goshen employs 4-CAD operators, 4-Mechanical Engineers, 3-Electrical Engineers, 2-Manufacturing Engineers, and 4-RND Techs.
3. Has the necessary facilities and financial resources, or has the capability to obtain such facilities and resources, to complete the contract in a satisfactory manner within the required time.

2.1.11 Dealer will be required to submit vehicle production status updates into the TRIPS DATACenter, which tracks the progress of each individual vehicle through the procurement and production process, from receipt of order through delivery and acceptance of each individual vehicle by the agency. These updates will be verified weekly by the manufacturer's production report. See Part 2, **Exhibit 1: TRIPS DATACenter Dealer Requirements**, for information describing the process for Dealers to submit Weekly Status Reports to the TRIPS DATACenter.

2.1.12 Dealer shall be responsible for delivering vehicles that are properly serviced, clean and in first class operating condition. Pre-delivery service, at a minimum, shall include the following:

1. Correct and repair all deficiencies noted in the TRIPS Pre-delivery Inspection Report conducted on each individual vehicle at its Springhill Bus

Inspection Research & Testing facility in Tallahassee. All repairs must be completed before delivery to Purchaser. The Dealer must enter detail of the repair action into the TRIPS DATACenter for the specific VIN of each vehicle inspected by TRIPS Staff.

2. Check all fluid levels to insure proper fill levels.
3. Ensure engine is in proper operating condition.
4. Inflate tires to proper pressure.
5. Check to insure proper operation of all components, accessories, gauges, lights, and mechanical and hydraulic features.
6. Cleaning of vehicle, and removal of all unnecessary stickers, markings and debris.

2.1.13 All subcomponent manufacturer Installation Instructions must be submitted to TRIPS Assistant Program Manager prior to the first bus being delivered from this contract 60-days prior to each prototype inspection plant visit.

2.2.0 ENGINE

2.2.1 Gasoline engine shall be manufacturer's standard for this size bus considering components and accessories proposed. The proposed engine must give satisfactory performance over terrain encountered in Florida with maximum passenger load. Gas: **6.8L** = EFI-V10 306 HP@4250 RPM, 420 ft lbs-420 LB/FT @3250 RPM; **6.8L** 3-valve SOHC EFI TRITON V-10-362 HP@4,750 RPM. **6.0 Vortec 6000 V8 SFI 323 HP @ 4600 RPM-373 LB/FT @ 4400 RPM.** TRIPS reserves the right to accept any other Gas engine when offered by the manufacturer during the term of this contract.

2.2.2 Diesel engine shall be manufacturer's primary option for this size bus considering components and accessories proposed. The specified engine must give satisfactory performance over terrain encountered in Florida with maximum passenger load. TRIPS reserves the right to accept any other Diesel engine when offered by the manufacturer during the term of this contract. **Diesel: 6.7L OHV POWER STROKE DIESEL V-8 B20-300HP@2,800 RPM.**

2.2.3 An Alternative Fuel Engine, which is the manufacturer's standard for this size bus considering components and accessories proposed, must be provided as an alternative fuel option. The specified engine must give satisfactory performance over terrain encountered in Florida with maximum passenger load. Manufacturer shall propose engine horsepower and torque. Proposer shall provide company name(s) and contact information for alternative fuel engine equipment

manufacturer(s) and installer(s). TRIPS reserves the right to accept any other alternative fuel engines when offered by the manufacturer during the term of this contract. The Alternate Fuel equipment must be installed in the vehicle to meet or surpass the minimum requirements of Part 2, Exhibit 4: **GASEOUS FUEL SYSTEM INSTALLATION STANDARD.**

- 2.2.4 Heavy-duty, minimum 4-speed, automatic, overdrive transmission, with tow/haul mode, and the most extreme duty cycle available from OEM, compatible with the engine specified, is standard. Gross input power, gross input torque and rated input speed shall be compatible with the engine specified. All models are equipped with OEM 6 speed automatic transmissions. TRIPS reserves the right to accept any other transmission when offered by the manufacturer during the term of this contract.

2.3.0 LEFT BLANK

2.4.0 EXHAUST SYSTEM

- 2.4.1 The vehicle shall be equipped with a heavy duty, corrosion resistant exhaust system which meets or exceeds FMVSS and EPA noise level and exhaust emission (smoke and noxious gas) requirements. Heavy-duty exhaust hangers shall be standard equipment and shall be bolted to the frame. All hanger U-bolt thread orientation must be directed sideways. All altered exhaust joints shall be welded with a continuous weld.
- 2.4.2 The exhaust tailpipe shall terminate at the left rear corner of the bus.
- 2.4.3 Galvanized heat shielding shall run between the exhaust system and the floor of the vehicle, at a minimum, this shield shall meet OEM Up-Fitter Guide requirements, or approved equal.

2.5.0 DRIVE SHAFT

- 2.5.1 Protective metal guards for the drive shaft shall be provided to prevent a broken shaft from touching the ground, contact any brake line, or whipping through the floor. The drive shaft guards shall conform to 49 CFR. Goshen will provide at least 2 drive shaft guards per section of drive line. One will be located toward the front of each section, and one toward the rear. They will be made of 14 ga powder coated steel. The guards will be welded to the floor structure of the bus body.

For each drive shaft section, the protective metal guard shall be located within ¼ of the length of the shaft and behind the forward U-joint. The bottom portion of the hoop shall be no more than three (3) to four (4) inches from the outer surface of the drive shaft.

2.6.0 **SUSPENSION**

2.6.1 Suspension shall be manufacturer’s standard but, must incorporate add on components that enhance ride comfort and prevent vehicle “listing”. Proposer must provide product description along with their proposal. Final product must be load rated for the GVWR of the size bus involved. OEM standard shocks and leaf springs shall be proposed. Goshen utilizes the Mor Ryde system.

2.7.0 **AXLES**

2.7.1 Axles shall be manufacturer’s standard. Axle must be load rated for the GVWR of the size bus involved.

2.8.0 **BRAKES**

2.8.1 Brakes should be capable of stopping a fully loaded vehicle at a deceleration rate equivalent to a 22-foot stop from a speed of 20 miles per hour and meet the FDOT Performance Brake Test Procedure (**Part 2, Exhibit 7**). They must be capable of this type of stop 3 times in a rapid succession from a speed of 20 miles per hour without brake fade.

2.8.2 The parking brake shall be capable of holding a fully loaded vehicle on a 15 degree incline and meet the FDOT Emergency/Park Brake Procedure Test (**Part 2, Exhibit 8**). The system shall incorporate a warning light on the instrument panel to indicate to the driver when the parking brake is applied.

2.8.3 The controls for the wheel chair lift shall be interlocked with the vehicle parking brake system and transmission to ensure the vehicle cannot be moved from the park position when the wheel chair lift is activated. The interlock must meet ADA Title 49 Lift Interlock requirements.

2.8.4 The interlock system shall be a solid state, microprocessor-controlled unit that utilizes “Plug and Play” connections to the chassis, incorporating intermittent fault filter technology to eliminate false signals from activating the system, and have a dash mounted LED to display sub-system status. Intermotive Gateway 505 and 506 interlock system to be provided.

2.9.0 **TIRES & WHEELS**

2.9.1 Steel wheels are standard.

2.9.2 A spare tire, mounted and balanced on the same type wheel assembly of the tires mounted on bus, shall be provided as standard and shipped loose with each vehicle.

The spare tire shall be covered and secured so as not to damage the interior of the bus in shipment.

2.10.0 ELECTRICAL

2.10.1 The vehicle shall be equipped with a heavy-duty (12 volt) electrical system. All components are to be selected and integrated to function in an environment characterized by low engine (alternator) speeds and high amperage draws (due to lights, wheelchair lift, 4-way flashers, air conditioning, or heater, and other accessories in constant operation). The entire electrical system, shall comply with CFR 49 sections 393.29, 393.30, 393.31, 393.32, and 393.33 respectively.

2.10.2 Charging system must comply with **Exhibit 6-Charging System Performance Test**. If an alternator or alternators is/are equipped with a separate rectifier bridge or an external regulator, the rectifier and or regulator shall be mounted inside cab of the vehicle. If non-OEM alternator is utilized, manufacturer shall provide a permanent label under the hood stating brand, model number, serial number and alternator output.

2.10.3 The vehicle shall have dual batteries, based on **Exhibit 6- Charging System Performance Test**, located in a readily accessible area on a pullout stainless steel tray under the body. The vehicle shall be equipped with a storage battery electrical power main disconnect switch. All battery cable connections shall be coated to prevent corrosion. The disconnect switch shall be labeled in red lettering “Battery Disconnect, Emergency Use ONLY”. Batteries must be date stamped and be no older than 1 year from delivery date.

2.10.4 A fast idle system shall be installed which will automatically increase the engine speed (RPM) to approximately 1500 RPM on gasoline engines and 1200 RPM on Optional diesel engines. Include a Gateway Module capable of being actuated either by driver, a voltage sensor, an air conditioner, an air compressor command, or a low coolant temperature command. This fast speed idle shall engage only when the vehicle is in Park.

2.10.5 An ambient-sensitive self-adjusting reverse direction alarm (BUA) in compliance with SAE J994b with respect to acoustical performance for a Type B device, but emitting at least 82 dBA with a supply of 14 volts shall be installed. Conformity to the environmental test stipulated by the SAE shall not be required.

2.11.0 WIRING HARNESS & ROUTING

2.11.1 The wiring harness must be built by a reputable wiring harness manufacturer and must be built to length of bus. Precision Works wiring harnesses shall be

used. Each harness shall be as-built with the exception of optional items, but each wiring schematic must identify each optional circuit. Harness may incorporate wiring for options not selected by the end user. Schematics shall include each connector pin number and location. It shall also include symbols identifying electrical components along with location of each component. Each set of schematics shall have a legend that identifies each symbol used, including grounds.

All wiring shall be vinyl insulated to 200 degrees Fahrenheit, shall meet SAE standards, and shall be color coded and number coded at least every eighteen (18) inches and permanently labeled to identify their function. Battery cables shall be 1/0 gauge with minimum of 0.075" wall plastic insulation. All wiring shall be of sufficient size to carry the required currents without excessive voltage drop.

Entire harness system and mating electrical components shall be plug-connected with lock tab connectors; all terminals are machine crimped; all harnesses shall be covered in high temp conduit and all exterior under body/under hood connectors are Weather-Pak connectors.

All multi-pin connectors with 12 or more conductors shall be environmentally sealed electrical connectors with a tab connector. All connectors with 3 to 12 circuits that are under the hood and/or under the vehicle shall be environmentally sealed high impact plastic connectors with pull apart locking tabs. All connections containing one to two circuits shall be made with Posi-Lock connectors. Any solder joints must be pre-approved by FDOT. **NO BUTT CONNECTORS WILL BE ALLOWED.**

- 2.11.2 All body wiring shall be run inside the body in a protected area. All wiring shall be in a loom and secured for maximum protection. Clamps shall be rubber or plastic coated to prevent them from cutting the wiring insulation. When routing wiring under vehicle all wiring shall be encased in a loom and attached to the frame and sub-floor structure with rubber or plastic coated P-clamps every 12 inches and shall not be bundled with hoses. The harness shall run in straight lines as close to the chassis frame rails as possible.
- 2.11.3 All fuses and relays (other than chassis OEM) shall be placed in an electrical panel. The panel shall be accessible through a non-locking door. Connection to OEM electrical system shall be accomplished through connectors supplied by the chassis manufacturer using locking mating connectors. A legend shall be provided on the circuit box door that displays circuit fusing and identification information. All second stage body relays shall be plug-in replaceable type.
- 2.11.4 All electrical circuits shall be properly sized and protected as described by the applicable SAE standards. If multiple components are powered from a single power source, additional circuit protection shall be provided.

2.12.0 FDOT CRASH AND SAFETY TESTING STANDARDS

It is mandatory that the Proposer meet the approval requirements of the “Rollover Crashworthiness Assessment for Cutaway Buses Acquired by the State of Florida” (FL-STANDARD) (Part 2, Exhibit 17). A three-year lead time will be granted to allow for the design, testing, and development necessary to certify compliance to the new requirements. During this lead time Award of contract is contingent on successfully completing the “Pre-Qualification Structural Testing for Cutaway Buses Acquired by the State of Florida” (PRE-QUAL) (Part 2, Exhibit 16) and obtaining a Temporary Waiver Contract. The PRE-QUAL process must be completed prior to first build; no buses will be built until satisfactory results are obtained. The Florida Transit Research Inspection Procurement Services (TRIPS) will then issue a Temporary Waiver Contract Award for a period of no more than 36 months from issuance of the temporary waiver. Satisfactory Full Scale bus testing should be completed within 36-months.

2.13.0 FLOOR

- 2.13.1 Floor constructed utilizing 3” x 2 7/8” x 1 ½” 14 gauge “hot rolled” steel “C” channel, Cross sections are 2” x 2 7/8” x 2” 11 gauge “C” channels on 24” centers.
- 2.13.2 Goshen Coach will provide 3/4 inch thick Advantech engineered wood for sub-floor.
- 2.13.3 The entire body frame under structure of the vehicle shall be primed on all surfaces, allowing the primer to cover all metal surfaces, applied at the time of manufacture. Any sub-component installed underneath the vehicle shall not be primed. Primer to be utilized is Pure Asphalt #76-M.
- 2.13.4 Manufacturer shall provide an access panel for the fuel pump assembly.
- 2.13.5 Manufacturers shall provide a flat floor for vehicles requiring three (3) wheelchair positions or greater. Wheelchair position(s) will not be allowed in the center aisle (line) of the vehicle, from front of vehicle to rear door exit.
- 2.13.6 Only one (1) wheelchair position can be placed behind the rear axle in buses with an interior wall-to-wall measurement of eighty-nine (89) inches or less, measured at the floor.

2.14.0 WHEEL HOUSINGS

- 2.14.1 Rear wheel housing shall be constructed of 14 gauge (minimum) one-piece steel constructed and adequately reinforced to prevent deflection. Ample clearance shall be provided for tires under load and operating on both smooth and rough

terrain. All steel shall be treated for corrosion resistance. In the event that tires extend beyond side of the vehicle, splash aprons and fenders shall be provided.

2.14.2 Front wheel housings are to be provided with the chassis cab section.

2.15.0 LEFT BLANK

2.16.0 DOORS

2.16.1 Passenger entry door shall be a dual, electric swing out type with two glass windows. Clear door opening shall be a minimum of 30 inches wide by a minimum of 80 inches in height.

2.16.2 All entry doors shall utilize long-life friction reducing materials and/or methods at upper and lower door-leaf pivot points. All door header linkages and rotation points shall incorporate similar long-life friction reducing materials/methods in their construction.

2.16.3 If vehicle proposed has a passenger cab door, then the passenger entry door shall be in the body directly rearward of the passenger cab door.

2.16.4 The entry door shall be fully encompassed by an integrally welded steel door surround. The entire door surround shall be fully welded to the steel substructure (cage) and floor cross members and become an integral part of the vehicle structure. Entry doors shall incorporate gaskets and / or seals to provide a barrier against intrusion by wind, water, and dust around their perimeter. The seal at the center of the door shall be by means of full height overlapping rubber seals, and shall include a barrier or sweep at the bottom of both doors.

2.16.5 The passenger entry door shall function through the use of an electric door operator. This door operator shall be modular in design for easy installation and reliable performance. The door operator shall develop sufficient force to close the doors and keep closed during normal operation, while at the same time provide slam free operation. The door operator shall either open or close the door in approximately 2.5 seconds.

For emergency situations, a manual door release control shall be provided adjacent to the door, and shall be designed to permit simple operations to override the electric door operator. This manual door release control shall be quickly identified for emergency exit only. For normal operations, the door operator shall not open the passenger door until the transmission lever is placed in *PARK*. With the door in the open position, the transmission will remain locked in the *Park* position until the door is totally closed. The entry door shall be equipped with a sensitive edge as standard that will reopen the door when closed on a passenger or object in the doorway.

2.17.0 EMERGENCY EXITS

- 2.17.1 Hinge-out windows shall be installed for emergency escape. Emergency escape windows shall comply with FMVSS-217.
- 2.17.2 A rear emergency door with upper and lower windows and a positive latching mechanism shall be installed. This door shall have a lock to prevent entry from outside. In all seating arrangements, wheelchair position(s) will not be allowed in the center aisle (line) of the vehicle, from front of vehicle to rear door exit.
- 2.17.3 The vehicle transmission shall not shift out of the park position when the rear emergency door is locked or when the door is unlatched. An audible alert capable of 95 dBA and a dash warning light shall be produced any time the emergency door is locked or unlatched with the ignition on.
- 2.17.4 Emergency escape windows shall be clearly labeled and operation instructions shall be clearly visible at each escape window. The emergency release handle will meet FMVSS-217 requirements and shall not return to the locked position automatically; it shall require the driver or other authorized person to manually re-lock it. All emergency exits shall comply with F.A.C. 14-90.
- 2.17.5 Each emergency exit shall be identified with a 12 volt red LED lamp assembly, with a 10,000 hour life bulb, wired to the vehicle ignition circuit. This system, along with window signage, shall provide passengers with a clear identification of exit routes. Next to or immediately below each LED light fixture shall be a decal, one (1) inch Helvetica Medium white letters on red background, stating "Emergency Exit".
- 2.17.6 All vehicles shall be equipped with a low profile roof hatch that is equipped with both an internal and external operating handle. Hatch shall open from rear toward the front.

2.18.0 SASH AND GLASS

- 2.18.1 Side sash shall be T-slider type. The sash shall be equipped with latches. Sash shall not slide (open or close) upon brake application. Side sash and rear glass may be either laminated safety glass or tempered safety glass.

- Side sash glassdouble density*
- Rear end glassdouble density*
- Windshield glasssingle density
- Driver's window glasssingle density
- Right side glass opposite Driver.....single density
- Entrance door glasssingle density

- Tinting color shall be smoke (gray)single density
- *NOTE: Maximum tinting shall be 31% light transmittance.**

- 2.18.2 Glazing material shall be in accordance with the latest version of ANSI - Z26.1, Safety Code for Safety Glazing Materials for Motor Vehicles Operating on

Land Highways. Glass must be AS-3 tempered. Glass grade shall be visible on each window pane.

- 2.18.3 The street-side (left) rear most passenger window shall be fixed, not allowing the window to be opened. This is to keep exhaust fumes from entering the bus.
- 2.18.4 Windows frames shall have anodized black finish.

2.19.0 LIGHTS

2.19.1.0 Exterior Lights

- 2.19.1.1 Tail brake lights, rear turn signals, back-up lights shall be 7 inch round LED fixtures. Brake lights shall have a minimum output of 350 lumens measured at feet. A center-top 7 inch round third brake light shall be provided and it shall be an LED fixture. The mid-bus and front and rear marker lights along with the state license tag light shall all be LED fixtures. LED lighting shall be Optronics.

2.19.2.0 Interior Lights

- 2.19.2.1 Vehicles shall incorporate side and/or center ceiling mounted interior lighting and shall be LED fixtures.
- 2.19.2.2 The number of lights and their light output shall be determined by providing a minimum average of 15 foot-candles illumination on a 1 square foot plane at an angle of 45 degrees from horizontal, centered 33 inches above the floor and 24 inches in front of the seat back at each seat position. Floor surface in the aisles shall be a minimum of 10 foot-candles. For interior floor, seat and aisles the light fixture must maintain constant light output over a 12 volt range. Each light fixture must have an integral power driver to maintain proper current and voltage to the fixtures.
- 2.19.2.3 There shall be two (2) shielded front passenger door floor/step well lights, wired to illuminate when the passenger door opens and shall be mounted to provide light on the entry floor platform and steps. The floor light shall meet with ADA requirements and shall activate only when the doors open and will turn off when doors close. The lights shall be LED type.
- 2.19.2.4 A separate light shall be installed to illuminate the outside area on the ground surface to a level of no less than 1 foot-candle for a distance of three (3) feet beyond the doorway. The outside door light shall be located to prevent casting a shadow on the step tread and shall illuminate the ramp when deployed. Lamps at the front passenger door shall comply with ADA requirements and shall activate only when the doors open. The light fixtures shall be LED type.

- 2.19.2.5 Vestibule (area between passenger door and driver seat) shall be illuminated to a minimum of 4 foot-candles with the front doors open and a minimum of 2 foot-candles with the front doors closed.
- 2.19.2.6 The driver's seat and instrument panel area shall have a LED flush-mounted ceiling light to provide general illumination and it shall be capable of illuminating the area between the lower half of the steering wheel nearest the operator and the operator's seat, to a level of 10 to 15 foot-candles. This light shall be controlled by the operator through a switch on the front console or with the integral design of the light fixture. This light shall illuminate without ignition activation.
- 2.19.2.7 Instrument panel and switch panel shall be indirectly lighted in a way as to prevent casting a glare on the windshield. All light sources shall be located to minimize windshield glare when the bus is in motion, with distribution of the light focused primarily on the passengers' reading plane.
- 2.19.2.8 Light fixtures shall utilize an integral harness and weatherproof connector to inhibit water and dirt intrusion yet allow for easy removal and service. Lens material shall be polycarbonate. All light fixtures, excluding instrument panel and switch panel, in this section shall be LED.

2.20.0 REFLECTORS

- 2.20.1 Reflectors shall be size, type color and location required to comply with the requirements of both FMVSS - 108 and the regulations established by the State of Florida.

2.21.0 STANDARD SEATS

- 2.21.1 Standard seating must meet or exceed all applicable Federal Motor Vehicle Safety Standard including FMVSS 210 seat belt certification test. All seats shall have the following minimum requirements. Upholstery material will be vinyl 32 ounce per linear yard with Nanocide. Colors are shown in Order Packet. The Freedman Mid-Hi will be standard.

2.21.2 LEFT BLANK

- 2.21.3 All seat belts shall meet or exceed FMVSS 209 (seat belt assemblies, performance and strength) and FMVSS 210 (seat belt mounting certification.) The passenger seats, frames and seat belts should operate as a complete system. All two-point seat belts must be permanently mounted on the seat frame. Seat belts attached to the floor track or wall track are not acceptable. All seat belt retractors must be permanently located under or behind the seating position. All seat belts must be user friendly, easy to operate, lightweight, and durable with metal buckles.

- 2.21.4 All seat frames will be attached to the vehicle by the use of mounted tracks that are welded to the floor and walls.
- 2.21.5 All aisle seat positions are to have top grab rails. Grab rails must be molded and bolted to the seat frame structure. The grab rails must meet White Book test requirements.

2.22.0 FOLD-AWAY SEATS

- 2.22.1 Forward facing seating shall meet or exceed all applicable Federal Motor Vehicle Safety Standards including FMVSS 210 seat belt certification test. Upholstery material will be vinyl 32 ounce per linear yard with Nanocide. Colors are shown in Order Packet. The Freedman Mid-Hi will be standard.

2.23.0 LEFT BLANK

2.24.0 DRIVER SEAT

- 2.24.1 OEM driver seat with right arm rest shall be standard. Seat shall be fully adjustable type and shall include shoulder and lap restraining belt with retractor and right armrest. The seat shall be vinyl and shall be either solid gray or solid blue in color.

2.25.0 FLOOR COVERING

- 2.25.1 Floor covering shall be slip resistant rubber flooring. Steps shall have a yellow edge or nosing to pronounce the presence of the step. Cove molding to be provided on all Goshen Coach Buses for this Contract. The floor covering shall meet the requirements of FMVSS-302. At the step well(s), there shall be no lip or nosing overhang, the step tread flange shall be flush with the vertical riser to eliminate any tripping condition. Samples and a description of the standard and optional floor covering material, available patterns, and colors, shall be submitted with proposal. RCA flooring shall be standard, smooth under seats and ribbed in the aisle. Blue, Black, Tan, and Gray colors are available.
- 2.25.2 There shall be a 2" wide white "Standee Limit" stripe set into the aisle covering located to the rear of the driver's section. The Standee Line shall meet the requirement of 49CFR section 393.90 and include a notice to passengers "*Standing Forward of the White Line is Not Permitted While Vehicle is in Motion*", posted in an area adjacent to white line and in clear view of passengers facing forward.

2.26.0 INTERIOR FINISH

- 2.26.1 The interior walls and ceiling surface finish shall be reinforced plastic of sufficient thickness adequately supported to prevent buckling and provide a

washable surface. No Luan plywood shall be utilized in the vehicle construction. RFP interior with an Azdel Backer to be used, cut to fit in every area, color is light gray (off white).

2.26.2 All interior materials must comply with FMVSS-302.

2.27.0 GRAB RAILS & STANCHIONS

2.27.1 Handrails and stanchions shall be provided in the entrance of the vehicle and elsewhere in a configuration as specified in 49 Code of Federal Regulation, Part 38, Subpart B, and Section 38.29.

2.27.2 There shall be a continuous ceiling-mounted grab rail on both sides of the aisle (except over doorways), vertical stanchions from floor to ceiling or seat back grab handles to provide a passenger with secure holding areas from front of the vehicle to the rear. In the positioning of stanchions and grab handles, there shall be no more than 38 inches between one holding device and the next, from one end of the aisle way to the other. The 38-inch dimension can be figured longitudinally of the body, across the body or diagonally from one to the other.

2.27.3 Ceiling grab rails shall terminate into vertical stanchions or turn up into the ceiling. No exposed ends will be accepted.

2.27.4 A modesty panel shall be positioned at the rear side of the entry door. Panel shall be mounted with 1½ - 2 inch spacing between the bottom of the panel and the floor to facilitate cleaning the floor. Fastening of the panel shall be by bolts or rivets, screws will not be acceptable. The forward side of this panel shall include a handle for boarding and alighting passengers in line with the door grab handles described above.

2.27.5 Grab rails and stanchions shall be made of 1¼ inch diameter stainless clad tubing, stainless clad shall be 0.02 inches thick. Fitting ells, tees, flanges and bolts shall be stainless steel. Ceiling grab rail support brackets shall be stainless steel or anodized cast aluminum. Grab rails/handles shall be mounted on both sides of the passenger door entry.

2.28.0 CONTROLS AND SWITCHES

2.28.1 All controls and switches shall be mounted within easy reach of the driver. They shall be permanently labeled for quick and unmistakable identification. Glued identification decals are not acceptable. All controls and switches shall be lighted for night time operation in such a way as to prevent glare in the windshield or driver's side windows. The gauges and alarms required are further described in **Part 2, Exhibit 2: Instruments**.

2.29.0 HEATER/DEFROSTER

- 2.29.1 The OEM and passenger heater unit(s) must achieve a 65 degree interior temperature with an empty coach when the ambient temperature is “30” degrees Fahrenheit within 30 minutes (measured at front mid-vehicle and rear in the vehicle). Additional passenger compartment heater(s) shall be mounted to the floor under seats at the manufacturer’s standard location to produce an even interior temperature. The blower motors for the passenger compartment heater system(s) shall be easily accessible for servicing and controlled by a three-position switches having *HIGH*, *LOW*, and *OFF* positions. All passenger compartment heaters shall be shielded to prevent blowing hot air onto the passenger’s legs. Interior heating must meet performance standards described above. Manufacturer must submit testing results with the proposal.
- 2.29.2 There shall be vacuum/electric shut-off valves in the heater piping. A booster pump may be required to meet the above performance standard with gasoline engines and shall be standard with diesel engines.
- 2.29.3 Heater hoses shall be of top quality silicon material. Elite® Blue Xtreme Heater Hose to be used. Hose clamps shall be stainless steel constant torque type. Hoses will be insulated with wrap-around foam pipe insulation.
- 2.29.4 Hoses shall be protected and supported by approved clamps in all locations where they are close to or pass through metal frame members to prevent chafing. Hoses shall be shielded against heat at any location where they pass over or near any part of the exhaust system. All heater hose shall be routed below floor level to ensure passenger safety. All heater components above floor level containing engine coolant shall be shielded in a manner that protects passengers from injury in the event of a failure. All components of any roof mounted heater system containing coolant must be completely drainable to the outside of bus by means of drain pans, hoses/tubes, conduit, etc., and must first be approved by the TRIPS program.

2.30.0 SUN VISOR

- 2.30.1 Sun visor shall be padded type, fully adjustable, to provide sun glare protection at the windshield or the driver's side window. A friction device shall hold it securely in either location and in any position during travel over rough road surfaces.

2.31.0 MIRRORS

- 2.31.1 Two (2) exterior rear view mirrors shall be provided; one (1) at the driver’s left side mounted in the OEM location, one (1) on the right/curb side. The mirrors shall have a minimum of 60 square inch reflective area. The mirrors shall be mounted out of the driver’s normal driving line of vision to prevent “blind spots. Mirror must be adjustable to meet FAC 14-90.

- 2.31.2 One interior Dead angle view mirror shall be located above the windshield. One OEM rear view mirror shall be windshield mounted.
- 2.31.3 All mirror mountings will be sufficiently rigid to prevent viewing distortion due to vibration. Exterior mirror mountings shall permit moving out of position to prevent mirror damage from automatic bus washers.
- 2.31.4 Provision shall be made for a minimum 5 inch convex mirror on each side of the vehicle attached permanently to the exterior view mirrors.

2.32.0 EXTERIOR FINISH

- 2.32.1 All welds shall be chipped to remove slag. All metal parts shall be de-greased and properly cleaned and sanded in preparation for painting. All metal surfaces shall be sprayed with primer. Parts and surfaces that will be covered in the finished vehicle shall be given a second coat of primer to prevent corrosion as much as possible. If any parts are pre-primed prior to assembly and should any welding be done during assembly then the weld shall be chipped. The weld and the surrounding area shall be primed again.
- 2.32.2 All surfaces that will be exposed on the finished vehicle shall be properly sanded prior to finish color paint application. Vehicles shall come standard with a quality painted white finish. Black-out windows are standard.
- 2.32.3 Proposals shall include samples of the manufacturer's most popular paint schemes with pricing, as noted in **Part 6, Paint Schemes**.

2.33.0 RUST PROOFING

- 2.33.1 The entire underbody, including wheel housings shall be rust proofed with Primer.
- 2.33.2 Proper care shall be taken to prevent any coating from being deposited on grease fittings, moving parts, brake hoses, and drive shaft. Goshen Coach will use Pure Asphalt #76-M for the underbody undercoating. Goshen Coach will fill in all of the cavities at the cross members with a 2 part spray-in closed cell foam insulation. After the insulation, the #76-M undercoating will be applied to all of the bare steel, using a pneumatic spray gun.

2.34.0 BUMPERS

- 2.34.1 Bumpers shall be provided at both front and rear of the vehicle. The front bumper shall be OEM chrome. Rear bumper shall be steel and painted black. The rear bumper shall be installed using heavy duty brackets bolted to the frame or frame extensions (not welded). The bumper shall be bolted directly to the bumper brackets with a minimum of 8 bolts (4-each side). Bolts shall be a

minimum 7/16 inch grade 8 or approved, and must have a flat transition panel from the body to the bumper.

2.35.0 INSULATION

- 2.35.1 Insulation is spray-in-place urethane foam in side walls, roof, under the floor, and rear wall. The foam fills all the voids in the structures to provide maximum thermal and acoustical insulation while providing adhesion for interior and exterior paneling. The "R" value averages about 4 for the foam.

2.36.0 AIR CONDITIONING

Only an FDOT approved supplier is qualified for installation on TRIPS Contract vehicles.

- 2.36.1 Vehicle shall be equipped with a base air conditioning system. ACC Climate Control, Skirt Mounted Condensers and Ceiling Mounted Rear Evaporator is the base system on all models. The air conditioning equipment **must** be capable of cooling buses to meet or surpass the minimum requirements of **Part 2, Exhibit 5: Air Conditioning Pull-Down Test Procedure**.
- 2.36.2 Vehicles shall have a totally split system. No "Add-On Systems" shall tie into OEM System in any way. Proposer shall provide and identify base system as standard, and provide pricing for the other two systems: either Rooftop condenser only system; Rooftop with both condenser/evaporator system; and skirt mounted system.
- 2.36.3 Air circulation shall be high volume with low velocity to provide draft-free passenger comfort.
- 2.36.4 All hoses shall be routed and secured in such a way that they will not rub or chafe. Routing of these hoses shall not interfere with the access of routine maintenance items such as dip-sticks, air filters, or access doors. When routing hoses under the coach the hoses shall be run in a straight line and shall be secured with rubber or plastic coated p-clamps every 12 inches. Refrigerant hoses shall be a refrigerant type double braided barrier construction. Refrigerant fittings shall be "Quick Click" or equivalent. Hoses and fittings must be qualified to SAE specification J2064. AC System shall be equipped with a digital control panel with diagnostic capabilities.
- 2.36.5 All brackets, pulleys, and belts required for the operation of A/C compressors and alternators shall be considered to be part of the second stage A/C system, and must be specifically engineered for each chassis provided. All mounting brackets will be purchased from the selected A/C supplier. All of the warranty will go through the bus body manufacturer. The mounting bracket will be manufactured by BSI.

- 2.36.6 Skirt mounted air conditioning condensers shall be accessible through externally removable and/or hinged panels.

2.37.0 WHEEL CHAIR LIFT

- 2.37.1 The wheel chair lift, its design, installation and operation shall comply with the Americans with Disabilities Act (ADA), Regulations and Requirements, as amended (Title 49 Code of Federal Regulations, Part 38, Subpart B, Section 38.23) and 49 CFR Part 571, and Florida Rule Chapter 14-90 [Equipment and Operational Safety Standards Governing Public-Sector Bus Transit Systems]. *General guidelines for the ramp are provided below. Omission in this guidance does not relieve proposer from compliance requirements of the ADA or Florida Statute – Chapter 14-90.*
- 2.37.2 Vehicle shall be equipped with a fully automatic wheelchair lift mounted on the curbside of the vehicle, accessible via access doors. Buses fewer than 22 feet in length shall have a minimum 56-inch door height. Buses 22 feet and greater shall have a minimum 68-inch door height. The lift door shall have a minimum 44-inch width. The lift mechanism shall be designed to provide clearance for applicable door height. The lift shall be mounted so as not to detract from structural integrity of the vehicle. The lift gate shall be of heavy-duty frame design. The wheelchair entrance door shall be open swinging type with window. The outer edges of the wheelchair access doors shall be weather-stripped with a continuous strip to provide a watertight seal. A cylinder type gas shock mechanism for opening and closing the door shall be installed. This mechanism shall be capable of holding the door in the fully open position when the lift is in use. The wheelchair lift shall be installed using the instructions and hardware provided by the lift manufacturer. A minimum of four (4) support bars installed underneath the floor are required for Ricon lift installations.
- 2.37.3 The lift shall have a self-cleaning, see through; non-skid platform (minimum 32” wide) which shall fold and unfold. The lift shall have provision for manual operation in the event of a power failure so that the platform can be operated. The useable platform space must be fully maintained in operation from ground surface to provide a minimum 5 inch barrier to prevent the wheelchair from rolling off the lift during operation. If the hinged barrier is automatically activated, it must be designed to allow for manual operation. A barrier at least 4 inches high shall also be provided on each side of the platform to prevent wheelchairs from rolling over the side edges. All W/C lifts shall utilize an occupant safety belt to prevent passenger from rolling off of outboard end of platform.
- 2.37.4 The occupant restraint system (lap/shoulder belt) shall be a combination type with double retractors and a shoulder height adjustment of at least 12 inches.

- 2.37.5 A strip of 3-inch reflective tape shall be added to the outer edge of the lift platform side barrier and shall run the full length of the side barriers.
- 2.37.6 All lift manufacturers or installers shall legibly and permanently mark each wheelchair lift assembly with the following minimum information in a location easily visible without deploying the ramp:
1. The manufacturers name and address.
 2. The month and year of manufacture.
 3. A certification that the wheel chair lift and installation conforms to State of Florida requirements applicable to accessible vehicles.
- 2.37.7 An audible warning signal shall be activated in the vehicle in the event that the lift doors are opened and the interlock is not engaged.

2.38.0 SECUREMENT DEVICES

- 2.38.1 Securement devices, their design, installation and operation shall comply with the Americans with Disabilities Act (ADA), Regulations and Requirements, as amended (Title 49 Code of Federal Regulations, Part 38, Subpart B, Section 38.23) and 30 mph/20G impact Test Criteria per SAE J2249. *General guidance for securement devices is provided below. Omission in this specification does not relieve the bidder from compliance requirements of the ADA and SAE J2249.*
- 2.38.2 In vehicles with securement device or system for mobility aid devices shall face toward the front of the vehicle.
- 2.38.3 Retractors shall be heavy duty with heat treated components and a metal or impact resistant plastic housing.
- 2.38.4 The retractor shall be complete with combination retractor straps with height and vertical adjustment for securing the wheelchair or mobility aid and two retractors for the occupant restraint system.
- 2.38.5 The wheel chair mobility aid retractors shall be equipped with self-adjusting tension controllers for tightening and have the ability for quick release.
- 2.38.6 The wheelchair or mobility aid retractors shall be equipped with “S” or “J” hooks to simplify operation.

- 2.38.7 The wheel chair or mobility aid retractors shall be capable of being mounted directly to the vehicle structure using a retractor mounting kit. Retractors with a slide and click type system, is preferred.
- 2.38.8 **LEFT BLANK**
- 2.38.9 The tie-down system shall be able to secure a standard wheelchair or mobility aid in less than 10 seconds. A set of four (4) “webbing loops” is to be provided at each station.
- 2.38.10 The retractor securement system shall meet the following requirements:
1. 30MPH/20G impact test criteria per SAE J2249; and
 2. 49 CFR Part 38 Americans with Disabilities Act (ADA).
- 2.38.11 The occupant restraint system shall meet the following requirements when used in conjunction with the retractor system:
1. Federal Motor Vehicle Safety Standards (FMVSS209 & MVSS302);
 2. 49 CFR Part 38 Americans with disabilities Act (ADA); and
 3. 30MPH/20G impact test criteria SAE J2249.
 4. Floor attachments shall be installed according to appendix F in SAE J 2249.
- 2.38.12 Storage containers for restraint system belts and instructions for use of restraint system shall be included and mounted in safe and convenient location.
- 2.38.13 Manufacturer shall install all restraint hardware provided (including under floor backer plates) by the sub-component supplier and by the instructions provided by the sub-component supplier. All securement stations must be ADA compliant.
- 2.38.14 A WC-18 compliant occupant restraint system shall be provided as an option.

2.39.0 SAFETY EQUIPMENT

Each vehicle shall be provided with the following equipment as standard:

- 2.39.1 Provide a Deluxe Medical Truck Kit, (see **Part 2, Exhibit 3: Medical Kit Supplies**), mounted in an accessible location.
- 2.39.2 Provide a Fire Extinguisher, 5 pound rechargeable ABC type, with charge status gauge and decal noting most recent charge date. This unit shall be mounted in an easily accessible interior location near the driver’s position and/or vestibule areas.
- 2.39.3 Provide Warning Triangles, reflective type, three (3) unit kit, secured in a location readily accessible to the driver.

- 2.39.4 Provide two (2) Seat Belt Cutters, mounted in an accessible location, one near the wheelchair ramp and the other accessible to the driver.
- 2.39.5 Provide a Blood Pathogen/Bodily Fluid Spill Kit, secured in a location readily accessible to the driver, and manufactured by the First Aid Only Company, or approved equal. The Kit must meet federal OSHA regulation 29CFR1910.1030(d)(3)(i).
- 2.39.6 Provide an optional Oxygen Tank Holder, shipped loose inside each bus at delivery. Dealer to install at a location selected by Purchaser.
- 2.39.7 Provide a G-force accelerometer monitor and recorder as standard, configured with 2 Accelerometer devices allowing it to detect and record G-forces in 3 axes, front/rear – left/right – up/down. System should also provide the following inputs: reverse, brake and left and right turn signals. Data shall be recorded and retained for a maximum of 60 seconds before and 15 seconds after an event. Signal Quest will be used.
- 2.39.8 Provide a fire suppression system as standard equipment. System to be equipped with 4 nozzles at minimum, located in the engine compartment connected to a piston accumulator that contains a water-based liquid fire suppressant agent. The size of the piston/accumulator and number of nozzles shall be determined by the manufacturer based on vehicle size and configuration. Fogmaker system to be used.

2.40.0 PA & ENTERTAINMENT SYSTEMS

2.40.1 Standard bus contains no PA or Entertainment System.

2.41.0 DESTINATION SIGN

2.41.1 Standard bus contains no Destination Sign.

EXHIBITS

Exhibit 1

DATACenter Dealer Requirements

(VERSION 1)

The Transit Research Inspection Procurement Services (TRIPS) DATACenter is managed by the Florida Department of Transportation (FDOT) and administered by the Center for Urban Transportation Research (CUTR). The TRIPS DATACenter is an online application developed to capture data related to vehicles procured from TRIPS vehicle contracts.

The TRIPS DATACenter can be found at www.cutr.usf.edu/fvpp2

The Dealer is required to enter various information into the DATACenter as the vehicle moves through the procurement process, from order origination to agency acceptance.

All pertinent vehicle data must be entered into the TRIPS DATACenter prior to vehicle arriving at the TRIPS Springhill Bus Inspection & Testing facility (SBITF), located in Tallahassee, FL. Any vehicle(s) arriving at the TRIPS Springhill facility without complete “Vehicle Information Form” data in the DATACenter will not be inspected, which may delay the vehicle delivery process. Failure to enter prescribed vehicle information into the TRIPS DATACenter may result in contract suspension after two (2) violations.

Once the vehicle has been inspected, the dealer is required to enter all actions taken to correct defects found during the SBITF vehicle inspection. These actions are entered into the DATACenter through the “Inspection Letter” form that is generated from the inspection.

The Dealer is required to input any reported and actionable *standard repair* issues with the vehicle after the vehicle has been delivered and is put into service, and report the actions taken to fix these issues during the vehicle’s entire useful life period. These actions are entered into the DATACenter through the “*Vehicle Defect Form*”, accessed through the “**Repairs**” Tab. Select “standard” on the form.

The Dealer is required to input any reported and actionable *warranty repair* issues with the vehicle after the vehicle has been delivered and put into service, and report the actions taken to fix these issues during the entire warranty period. These actions are entered into the DATACenter through the “*Vehicle Defect Form*”, accessed through the “**Repairs**” Tab. Select “warranty” on the form.

The DATACenter provides various other means of extracting information for the dealer, including PO management, searches, and reporting features. Please refer to the provided User’s Manuals as needed for complete information.

Exhibit 2

Instruments

DISPLAY	GAUGE	LIGHT(S)	AUDIBLE
VOLTMETER	X	X	
HIGH ENGINE WATER TEMP	X	X	X
LOW ENGINE OIL PRESSURE		X	X
FUEL GAUGE	X	X (Low fuel warning)	X
GENERATOR/ALTERNATOR NOT CHARGING	X	X	X
REAR EMERGENCY DOOR OPEN or UNLATCHED		X	X
DIRECTIONAL / HAZARD SIGNALS		X	X
HEADLIGHT HIGH BEAM		X	
PARKING BRAKE ON		X	
SPEEDOMETER WITH ODOMETER	X		

NOTE: The instrument package above shall be provided by the chassis manufacturer. After market substitutes will not be accepted.

Exhibit 3
Medical Kit Supplies

<u>Contents</u>	<u>Amount</u>
Deluxe Kit, Metal, Empty	1 box
Clean Wipes 50/Bx	5 each
Antibacterial Towelettes	20/box / 1 box
Tape, ½" X 5 Yd. Spool	1 each
Eye Wash, Sterile	1 each 4 oz.
Sheer Strip 1"	100 per box
QR Wound Seal	2 per package
Sterile Dressing 5" X 9"	1 each
Elastic Roller Gauze N/S	2" X 4.5 YD, 1 each
Pain-Aid	100 per Box (Zee)
First Aid Pocket Guide	1 each
Small Instant Ice Pack	1 each
Bandage, Triangular 40" N/S	1/Un, 1 each
3-in-1 Antibiotic Ointment	6 per unit, 1 each
Fingertip Bandages	10 per unit, 1 each
Gauze Pads, 3" X 3"	1 each
Knuckle Bandages	10 per unit, 1 each
Water-Jell Burn Jell	6 per box, 1 each
Eye Pads w/Adhesive Strips	2 per unit, 1 each
Nitrile Gloves, Large	2 pairs, 1 each
Disposable Tweezers, Sterile	1 each

Exhibit 4

FLORIDA DEPARTMENT OF TRANSPORTATION

GASEOUS FUEL SYSTEM INSTALLATION STANDARD

(VERSION 1)

OVERVIEW

The gaseous fuel system installation standard will be evaluated on all vehicles procured from TRIPS vehicle contracts in support of both performance standards and quality star ratings. Testing conditions will replicate severe duty transit operations. Evaluation will be performed on all vehicles up-fitted with an after-market gaseous fuel system.

EVALUATION CRITERIA

Evaluation will occur at FDOT's Springhill Bus Testing and Inspection Facility (SBTIF) located at 2612 Springhill Road, Tallahassee, FL 32305. A gaseous fuel powered engine, which is the manufacturer's standard for this size bus considering components and accessories proposed, will be provided. The specified engine must give satisfactory performance over terrain encountered in Florida with maximum passenger load.

Gaseous fuel systems shall include up-graded components to ensure durability when used with gaseous fuels. The only fuels covered by this program are compressed natural gas (CNG) and liquefied petroleum gas (LPG). Gaseous fuel systems shall meet all current applicable **FMVSS**, **NFPA** and **OEM UPFITTER** guidelines.

INSTALLATION REQUIREMENTS

1. A service and parts manual shall be made available that specifies all gaseous fuel system components along with tank removal and installation methods and any special tools that may be required to prevent damage or injury to the tanks, facilities, and personnel. This manual should state that the fuel tank must be grounded prior to servicing the system and include a grounding procedure.
2. The CNG/LPG fuel system maximum pressure and working pressure shall be specified in the installation documentation. The working pressure of CNG is the settled pressure at a uniform gas temperature of 70°F at full gas content.
3. Heat shields shall be added for all new fuel components located within 8 inches of the exhaust system. Isolate all fuel handling components at least 8 inches from unshielded heat sources or at least 3 inches if shielded.
4. All components for the gaseous fuel fill and de-fuel ports shall be located in the normal fueling location. An interlock switch shall be provided to prevent starting the vehicle when fueling or de-fueling. All gaseous fuel lines, fittings and tubes shall be stainless steel or

flex tubing approved for use with CNG at 3600PSI; LPG at 300PSI to meet current NFPA 52 and 58 guidelines and:

- Be routed away from, and not attached to, items that are likely to move during normal vehicle operation
- Be routed in such a manner that they will not be affected by the deformation or displacement of adjacent components during a crash
- Be routed inboard of the frame rails (except for connection to the filler) and above the plane of the lower frame flange
- Have adequate flexibility to avoid rupture or disconnection during crash situations
- Be routed away from sharp objects and be retained adequately to prevent movement into such regions or against such objects
- Be clear of moving suspension components
- Avoid exposure to road debris or undercoating
- Be properly grommeted where they pass through panels

5. When CNG/LPG fuel tanks are mounted outside of the OEM frame rails, an additional crash barrier structure shall be provided to surround the tanks. This structure must equal or exceed the section modulus and material strength of the OEM frame rail. Final design shall be approved by FDOT.

6. The CNG fuel tanks shall be a minimum Type III; aluminum and carbon fiber construction with a minimum twenty (20) year life that complies with current NGV2-2007 and FMVSS 304 regulations. The conversion shall include stainless steel dust and gravel shields to protect the tanks and valves. The tanks shall have a production date of no more than 24 months from the date the vehicle is delivered.

7. A methane detection system shall be provided that alerts the driver with an audible and visual alarm when fumes exceed the specified threshold greater than 20% and disable the fuel system when fumes exceed specified threshold greater than 50%. The power supply for the methane detection system shall be separate from the chassis.

8. This standard is written to compliment and to be in compliance with NFPA 52 and 58. In the event of conflicting standards, NFPA 52 and 58 take precedence.

Exhibit 5

FLORIDA DEPARTMENT OF TRANSPORTATION

AIR CONDITIONING PULL-DOWN TEST PROCEDURE

(VERSION 2)

OVERVIEW

This test will be performed on all air-conditioning systems installed in vehicles procured from TRIPS vehicle contracts in support of both performance standards and quality star ratings. Testing conditions will replicate severe duty transit operations. FDOT will test one or more buses (systems) from each contract within the first award year. If a system fails the test, FDOT reserves the right to suspend vehicle orders utilizing this system, or terminate the contract associated with the failed system. FDOT reserves the right to randomly test new buses at any time during the contract period to ensure compliance.

TEST CONDITIONS / EQUIPMENT

The test will be performed on an asphalt parking lot in direct sunlight. The vehicle will be surrounded by a wall five (5) feet high, fifteen (15) feet wide and the length adjusted to the length of the bus. The minimum testing conditions require an ambient temperature of 94 degrees Fahrenheit (F) (+- 3 degrees) with 60% relative humidity.

All temperature measurements will be recorded in degrees of F and be captured using the Measurement Computing Data Acquisition capturing device. This device is configured with the manufacturer's latest edition of the TracerDAQ software. Calibration of the device is conducted prior to the test using the manufacturer's InstaCal Software.

Pressure readings are captured using the Yellow Jacket 686800 Manifold gauge set.

Voltage readings are captured using the Fluke model 78 automotive multi-meter.

Amperage readings are captured using the Fluke model 336 True RMS Clamp Meter.

TEST SET-UP

1. Perform a complete ultrasonic leak detection test of the air conditioning system. If the system fails the leak detection test, do not proceed
2. Ensure all windows and doors are closed properly, with no gaps or leaks. Ensure interior engine cover is sealed properly
3. Connect all test equipment:

- a. C0 Lead: An Omega Engineering J-Type 5 position Fine Wire Thermocouple will be placed outside of the vehicle, away from mechanical and radiant heat sources, to capture ambient temperature
- b. C1 Lead: An Omega Engineering J-Type 5 position Fine Wire Thermocouple will be placed 48 inches to 52 inches from the rear wall and four feet above the floor surface to capture bus interior temperature
- c. C2 Lead: An Omega Engineering J-Type 5 position Fine Wire Thermocouple will be placed at the center line of the bus interior, four feet above the floor surface, to capture bus interior temperature
- d. C3 Lead: An Omega Engineering J-Type 5 position Fine Wire Thermocouple will be placed at the first row of seats, four feet above the floor surface, to capture bus interior temperature
- e. C4 Lead: An Omega Engineering J-Type ICSS Thermocouple will be placed near the center of the evaporator core to capture rear evaporator core temperature
- f. C5 Lead: An Omega Engineering J-Type 5 position Fine Wire Thermocouple will be placed above the engine, near the fire wall, to capture the bus engine compartment temperature
- g. C6 Lead: An Omega Engineering J-Type ICSS Thermocouple will be placed near the center at the air-in side of the condenser to capture the condenser core temperature
- h. C7 Lead: An Omega Engineering J-Type 5 position Fine Wire Thermocouple will be placed near the center of the air-out side of the condenser to capture the condenser air temperature
- i. Connect the manifold gauge set to the add-on A/C system
- j. Connect the multi-meter to the battery (s)
- k. Connect the ammeter to the battery cable

TEST PROCEDURE

1. Heat-soak the bus under test conditions for a minimum of two hours. Record the date, time of day, vehicle identification number, and location.
2. With the vehicle in park and all doors and windows closed, start the engine.
3. Turn on the air conditioning system, set the a/c system to maximum cooling position, and turn on all interior and exterior lights.

4. Let vehicle run with the high idle on (approximately 1200 RPM on diesel engines and approximately 1500 RPM on gasoline engines). If the high idle is designed to automatically turn off after the first 15 minutes, the driver's door will be opened and the high idle immediately turned back on to complete the test. This action will not invalidate the test
5. Record all temperature readings (seven leads) in 15 second increments
6. Record pressure readings at the service ports of the add-on / second stage A/C system at the beginning of the test and at ten (10) minute increments thereafter
7. Record battery voltage readings at the battery (s) at the beginning of the test and at ten (10) minute increments thereafter
8. Record amperage readings at the positive cable coming off the battery (s) at the beginning of the test and at ten (10) minute increments thereafter
9. At the end of the 30 minute A/C pull down test there will be a 30 minute heat-gain test performed to determine the efficiency of the insulation in the bus using the same measurement equipment used for the A/C pull down test. Record all temperature readings (seven leads) in 15 second increments to determine fastest rise and total rise in bus interior temperature

SYSTEM TEST RESULTS

During the test, the interior temperature of the bus should lower uniformly throughout and should lower the interior temperature within the prescribed time.

The system will **fail** the test if:

- a) The temperature difference between C1, C2, and C3 varies more than two degrees during each 15 second reading during the last 15 minutes of the test
- b) The system fails to lower the interior temperature to a minimum of 70 degrees F (+ or - 2 degrees) measured at C1 by the end of the 30 minute test (conditions must reflect an ambient temperature of 94 degrees F (+ or - 3 degrees) measured at C0, with a minimum of 60% relative humidity)
- c) The voltage readings at the batteries fall below 12.9 volts at any time during the test

Additional data will be captured to allow the TRIPS program to analyze and compare system attributes and configurations:

- i. Fastest time to achieve 70 degrees with the lowest amperage draw
- ii. Fastest overall time to achieve 70 degrees
- iii. Lowest temperature retained during the 30 minute heat-gain test
- iv. Lowest head pressure reading captured during step 6 of the test
- v. Highest voltage output captured during step 7 of the test
- vi. Lowest amperage draw captured during step 8 of the test

Exhibit 6

FLORIDA DEPARTMENT OF TRANSPORTATION

CHARGING SYSTEM PERFORMANCE TEST PROCEDURE

Overview:

An FDOT compliant vehicle shall be equipped with a heavy-duty (12 volt) electrical system. All components are to be selected and integrated to function in an environment characterized by low engine (alternator) speeds and high amperage draws. The entire electrical system, shall comply with 49 CFR sections 393.29, 393.30, 393.31, 393.32, and 393.33 respectively. Test results shall be recorded on the Amp Draw analysis form in **Exhibit 15**, which shall incorporate all add-on componentry to include items listed on the Agency's **Anticipated Usage** form.

Alternator:

Under standard operating conditions with the engine running, the electrical load should be powered by the alternator alone, and the battery itself becomes a load. The alternator's rated output shall be 50% more than vehicle recorded load. Under vehicle idle, the alternator maximum output will be approximately 40% of the rated output. At idle, the load must not exceed 150% of the idle output.

When testing, the battery must be fully charged and maintain 12.6 volts with ignition off.

1. With the engine "OFF" and the battery in a good state of charge (12.6 volts), connect an accurate ammeter (50 Amperes range or less), in series, with the grounded terminal of the battery and the ground cable.
2. With the ignition ON, switch each individual continuous electrical load ON and OFF separately. Record the reading(s) on the FDOT Amp Draw Analysis Worksheet under the SYSTEMS paragraph. The sum of these values, divided by 2 (50 percent) is the total electrical requirement with the switch "ON" and the engine "OFF." Record the Total Amp Draw (b) on the FDOT AMP Draw Analysis Worksheet.
3. Connect a Snap-On MT3750 AVR.
4. Start the engine, disable the FAST IDLE, and turn off all accessories.
5. Using the load knob, slowly introduce the load to the alternator until the voltage measures 12.0 VDC on the display. Record the amperage output at 12.0 VDC on the FDOT AMP Draw Analysis Worksheet, Total Idle Amp Output (a). The system fails if the Total Amp Draw (b) is within 10% of the Total Idle Amp Output (a).

Parasitic draw:

Battery must be fully charged and maintain 12.6 volts with ignition off.

1. With the ignition "OFF" and the battery in a good state of charge (12.6 volts), connect an accurate ammeter (20 Amperes range or less), in series, with the grounded terminal of the battery and the ground cable.
2. Parasitic draw cannot exceed 50 milliamps. If it exceeds 50 milliamps the system fails.

Reserve capacity/customer add on components:

The reserve capacity defined during the alternator test (c) should sufficiently support all add on components identified at the time of bus order. The bus fails if the reserve capacity is not within **10%** of the reserve capacity listed in the delivery package.

Exhibit 7

FLORIDA DEPARTMENT OF TRANSPORTATION

BRAKE TEST PROCEDURE

(VERSION 2)

OVERVIEW

This test is the brake performance standard for all transit equipment purchased through Florida Vehicle Procurement Program contracts. The FDOT will test one or more vehicles from each contract within the first year of a contract agreement. If a bus fails to meet the performance test, the FDOT reserves the right to suspend placement of further orders or terminate the contract. The FDOT also reserves the right to randomly test new buses at any time during the contract period, to ensure compliance.

TEST CONDITIONS / EQUIPMENT

The test will be performed on a level asphalt parking lot or street in dry conditions. The test will be performed using a VC-4000 Brake Meter that records acceleration, test speed, brake efficiency and stopping distance. The test will be performed at a speed of 20 miles per hour. The test will be performed with 150 pounds in each seat position and 250 pounds in each wheelchair position to simulate the bus loaded to maximum passenger capacity.

TEST SET-UP

1. Using the, VC-4000 Brake Meter ensure the battery is charged sufficiently.
2. Choose a safe test area in the vehicle that is level as possible.
3. Place the Brake meter in the vehicle with the arrow pointing in the direction of travel.
4. Press MENU until the current mode is service brake test.
5. Press the auto start button and the display will indicate whether or not the unit is level enough to perform the test.

TEST PROCEDURE

1. With vehicle in stopped position, driver will accelerate to 22 miles per hour;
2. Without causing the vehicle to skid, apply heavy and consistent pressure to the service brake until the vehicle comes to a complete stop as quickly as possible.

3. The test is now complete. Unit will calculate 20 miles per hour stopping distance.

Perform the test at 20 miles per hour. Record the stopping distance of each test using a VC-4000 to record brake performance, speed and stopping distance. Perform the test without passenger load, and then perform the test with the vehicle fully loaded to seating capacity. The test without passenger load is for FDOT information purposes only.

SYSTEM TEST RESULTS

Each test at 20 miles per hour will be performed 3 times in a rapid succession and recorded. From the time the brakes are applied the bus must stop within 22 feet without brake fade.

The bus will fail the test if;

- a. The vehicle fails to stop all 3 times, from 20 miles per hour in 22 feet.
- b. The brakes fade or overheat during the test.

INVALID TEST

The test will be deemed invalid if;

- a. Surface conditions change due to rain;
- b. Recordings are checked and any conditions are not met

Exhibit 8

FLORIDA DEPARTMENT OF TRANSPORTATION

EMERGENCY/PARK BRAKE TEST PROCEDURE

(VERSION 1)

OVERVIEW

This test is the park brake performance standard for all transit equipment purchased through Transit Research Inspection Procurement Services program contracts. The FDOT will test one or more vehicles from each contract within the first year of a contract agreement. If a bus fails to meet the performance test, the FDOT reserves the right to suspend placement of further orders or terminate the contract. The FDOT also reserves the right to randomly test new buses at any time during the contract period, to ensure compliance.

TEST CONDITIONS / EQUIPMENT

The test will be performed on a 15 degree incline ramp in dry conditions. The surface angle will be verified using a Johnson Angle Locator. The test will be performed with 150 pounds in each seat position and 250 pounds in each wheelchair position to simulate the bus loaded to maximum passenger capacity.

TEST SET-UP / PROCEDURE

1. Perform a complete system check assuring the emergency/park brakes are in proper working condition, tires are in good condition and properly inflated, minimum of ¼ tank of fuel.
2. Install and secure correct testing ballast weight in each seating and wheelchair position;
3. Verify that ramp angle is at 15 degrees;
4. Position bus on ramp in forward position (front end up);
5. Place wheel chocks two inches behind right side and left side rear tires;
6. Place indicator marks on both rear tires and ramp surface;
7. Set parking brake to the fully on position;
8. Place transmission in the neutral position;
9. Monitor and record any movement of the bus for 30 minutes;

After 30 minutes, reposition bus to be in a rearward position (front end down);

Repeat the above procedure.

SYSTEM TEST RESULTS

The bus will fail the test if;

- a. There is more than one inch of movement in the 30 minute time period in either position;
- b. The brakes display any signs of slippage during the test.

INVALID TEST

The test will be deemed invalid if:

- a. Any of the specified procedure steps are not followed;
- b. Surface conditions change due to rain.

Exhibit 9

After Sales Service

After Sales Service support and Warranty support functions at FTS are managed by Doug Revelle, Manager of Customer Support. Doug oversees the Service, Parts and Warranty Departments in his capacity at FTS.

FTS has six full time personnel in parts sales, warehousing and distribution. Parts calls are directed to our parts department, or customers may dial directly to a specific parts sales individual (customers are given support personnel contact information upon delivery). Customer calls are handled by either Julie Yadao, Marlon Brown or Tom Lukens, Parts Manager. Parts orders are processed, packed and shipped from the FTS warehouse in Tampa by Langston Freeman and Angelo Freeman. Customers within a 50-mile radius from either Tampa or our Pompano office may receive complimentary FTS delivery on their parts if time critical.

Warranty calls are directed to our Warranty Administrator, Lucy Hood. Lucy is responsible for gathering the vehicle information, customer contact information, description of issue and preference for resolving issue (in-house repair by customer, local vendor, FTS location or FTS mobile repair). If additional information is required (documentation or photos), Lucy will request this information from the customer. If the repair requires approval from a manufacturer or if the repair is potentially not warrantable, information will be relayed to Doug Revelle to assist in determination. Doug will consult with the end user and the manufacturer to determine course of action.

Once the repair has been determined to be, the Warranty Administrator will ship parts to customer, coordinate reimbursement and recovery of return parts if necessary (for agency in-house repair), provide local vendor option for consideration and coordinate with agency and local vendor, coordinate communications with service department and customer (for repairs at FTS locations) or coordinate scheduling with customer for FTS mobile service.

It is the ultimate end goal of these efforts to provide any end user with a vehicle that is operational and minimize any potential downtime. With over 33 years of Florida history, two Florida facilities (Tampa and Pompano Beach), 5 dedicated parts personnel, 19 service technicians, 11 service vehicles and over 40 employees, FTS stands ready to support its customer base.

Exhibit 10

TRIPS PROGRAM-STAR RATING GUIDELINES

Air Conditioner

(Version 5)

Stars are earned for achievements in each of the categories listed below. Air conditioner manufacturers have the ability to receive up to 5 stars (one per category). Continuous type data will be averaged by contract to obtain ratings. Ratings will be updated semi-annually.

Category One: Temperature: One star will be earned if the temperature captured individually by the C1, C2, and C3 Leads during the A/C pull-down test is between 67-69 degrees F. If unable to obtain this metric, a half star will be earned if the *average* on all three sensors as captured by the C1, C2, and C3 Leads during the A/C pull-down test is between 67- 69 degrees.

Category Two: Amperage Draw: One star will be earned if the system has the lowest amperage draw as captured by step 8 of the A/C pull-down test. A half star will be earned if the system has the second lowest amperage draw as captured by step 8 of the A/C pull-down test. A quarter star will be earned if the system has the third lowest amperage draw as captured by step 8 of the A/C pull-down test.

Category Three: After Sales Service: One star will be earned if the A/C manufacturer displays timeliness in repairing any and all system defects. TRIPS defines “timeliness” as four (4) business days or less, from notification of defective system/component to completion of repairs. A half star will be earned if the repair occurs between five (5) and eight (8) days, a quarter star will be earned for repairs taking longer than eight (8) days.

Category Four: Warranty: A half star will be earned for providing the longest system warranty as detailed in the vehicle purchasing agreement. A half star will be earned for *exceeding* the provisions of Part 5, Section 5.4.0 of the vehicle purchasing agreement, “work necessary to affect the repairs defined in Section 5.1.2 shall commence within ten (10) working days after receipt of notification by Dealer.” A quarter star will be earned for *meeting* the provisions of Part 5, Section 5.4.0.

Category Five: Product Reliability: One star will be earned for having ten percent (10%) or less of A/C systems encountering any type of defect for the useful life of the system (as determined by vehicle type), excluding post-delivery inspection results. A half star will be earned for having less than fifteen percent (15%) but greater than ten percent (10%) of A/C systems encountering any type of defect for the useful life of the system (as determined by vehicle type), excluding post-delivery inspection results.

Exhibit 11

TRIPS PROGRAM-STAR RATING GUIDELINES

Alternator

(Version 5)

Stars are earned for achievements in each of the categories listed below. Alternator manufacturers have the ability to receive up to 5 stars (one per category). Continuous type data will be averaged by contract to obtain ratings. Ratings will be updated semi-annually.

Category One: Temperature: One star will be earned for the lowest average temperature captured on the housing surface, stator, rotors and both bearings as compared to alternators with similar characteristics. A half star will be earned for the second lowest average temperature captured on the housing surface, stator, rotors and both bearings as compared to alternators with similar characteristics

Category Two: Performance: One star will be earned if alternator maintains a 150 amp output with a minimum of fourteen (14) volts supplied to the battery for 30 minutes, at an alternator rotor speed of 2000 RPM.

Category Three: After Sales Service: One star will be earned if the alternator manufacturer displays timeliness in repairing any and all product defects. TRIPS defines “timeliness” as four (4) business days or less, from notification of defective system/component to completion of repairs. A half star will be earned if the repair occurs between five (5) and eight (8) days, a quarter star will be earned for repairs taking longer than eight (8) days.

Category Four: Warranty: A half star will be earned for longest alternator warranty provided as detailed in the vehicle purchasing agreement. A half star will be earned for *exceeding* the provisions of Part 5, Section 5.4.0 of the vehicle purchasing agreement, “work necessary to affect the repairs defined in Section 5.1.2 shall commence within ten (10) working days after receipt of notification by Dealer.” A quarter star will be earned for *meeting* the provisions of Part 5, Section 5.4.0.

Category Five: Product Reliability: One star will be earned for having ten percent (10%) or less of alternators encountering any type of defect for the useful life of the system (as determined by vehicle type), excluding post-delivery inspection results. A half star will be earned for having less than fifteen percent (15%) but greater than ten percent (10%) of alternators encountering any type of defect for the useful life of the system (as determined by vehicle type), excluding post-delivery inspection results.

Exhibit 12

TRIPS PROGRAM-STAR RATING GUIDELINES

Manufacturer

(Version 5)

Stars are earned for achievements in each of the categories listed below. Manufacturers have the ability to receive up to 5 stars (one per category). Continuous type data will be averaged by contract to obtain ratings. Ratings will be updated semi-annually.

Category One: Quality: One star will be earned if the results of the post-delivery inspection conducted at the SBTIF reveal an average of four (4) defects or less for all vehicles inspected, specific to purchasing agreement. A half star will be earned if the results of the post-delivery inspection conducted at the SBTIF reveal an average of between five (5) and eight (8) defects for all vehicles inspected, specific to purchasing agreement. A quarter star will be earned if the results of the post-delivery inspection conducted at the SBTIF reveal an average of between nine (9) or greater defects for all vehicles inspected, specific to purchasing agreement.

Category Two: Category Two: TRIPS Overall Satisfaction Survey: One star will be earned if the dealer receives an average score of four (4) or above from the TRIPS Overall Satisfaction survey. A half star will be earned if the dealer receives an average score of greater than three (3) but less than four (4) from the TRIPS Overall Satisfaction survey. A quarter star will be earned if the dealer receives an average score of greater than two (2) but less than three (3) from the TRIPS Overall Satisfaction survey.

Category Three: Compliance: One star will be earned for complying with Part 4, Quality Assurance Provisions, of the contract, in its entirety and having a completed TRIPS generated Plant Inspection report on file for the current production year. A half star will be earned for meeting one of the two requirements of this Category.

Category Four: Product Reliability: One star will be earned for having twenty five percent (25%) or less of vehicles encountering any type of defect for the useful life of the system (as determined by vehicle type), specific to purchasing agreement and excluding post-delivery inspection results. A half star will be earned for having less than thirty five percent (35%) but greater than twenty five percent (25%) of vehicles encountering any type of defect for the useful life of the system (as determined by vehicle type), specific to purchasing agreement and excluding post-delivery inspection results.

Category Five: Insulation / R value: One star will be earned for the lowest retained temperature captured during the 30 minute heat-gain test conducted as part of the A/C pull down test, specific to purchasing agreement. A three quarter star will be earned for the second lowest retained temperature captured during the 30 minute heat-gain test

conducted as part of the A/C pull down test, specific to purchasing agreement. A half star will be earned for the third lowest retained temperature captured during the 30 minute heat-gain test conducted as part of the A/C pull down test, specific to purchasing agreement. A quarter star will be earned for the fourth lowest retained temperature captured during the 30 minute heat-gain test conducted as part of the A/C pull down test, specific to purchasing agreement.

Exhibit 13

TRIPS PROGRAM-STAR RATING GUIDELINES

Dealer

(Version 5)

Stars are earned for achievements in each of the categories listed below. Dealers have the ability to receive up to 5 stars (one per category). Continuous type data will be averaged by contract to obtain ratings. Ratings will be updated semi-annually.

Category One: After Sales Service: One star will be earned if the dealer fully complies with Exhibit 9, After Sales Service, as defined in the purchasing agreement, and receives an average score of four (4) or above from the agency post-delivery surveys. A three-quarter star will be earned if the dealer is in partial compliance with **Exhibit 9, After Sales Service**, as defined in the purchasing agreement and receives an average score of at least four (4) or above from the agency post-delivery surveys. A half star will be earned if the dealer is in full or partial compliance with **Exhibit 9, After Sales Service**, as defined in the purchasing agreement and receives an average score of greater than three (3) but less than four (4) from the agency post-delivery surveys.

Category Two: Warranty: One star will be earned if the dealer starts work immediately on warranty claims, as defined in Part 5, Section 5.4.0 and fully complies with Part 5, Section 5.10.5. A half star will be earned for complying with one of the two Sections referenced in this Category.

Category Three: Compliance: One star will be earned if the dealer is in full compliance with **Exhibit 1, DATACenter Dealer Requirements**, of the contract.

Category Four: TRIPS Satisfaction Survey: One star will be earned if the dealer receives an average score of four (4) or above from the TRIPS Overall Satisfaction survey. A half star will be earned if the dealer receives an average score of greater than three (3) but less than four (4) from the TRIPS Overall Satisfaction survey. A quarter star will be earned if the dealer receives an average score of greater than two (2) but less than three (3) from the TRIPS Overall Satisfaction survey.

Category Five: Contract Management: One star will be earned if both the dealer and manufacturer participate in TRIPS requested annual meeting to review contract status and problem solve. One half star will be earned for dealer-only participation.

Exhibit 14

Provide signs #1, #2, and #3 with black letters on white background. Agency is to be consulted on exact wording prior to delivery.

Sign #1

*Transportation
services provided by
this vehicle are open
to the general public.*

Sign #2

Florida Law and Title VI of the Civil Rights Act of 1964 Prohibits Discrimination in: Public accommodations on the basis of race, color, national origin, sex, age, disability or income. In addition, the Florida Civil Rights Act does not permit discrimination on the basis of religion or family status. Persons believing they have been discriminated against on these conditions may file a complaint with the Florida Commission on Human Relations at 850-488-7082 or 800-342-8170 (voice messaging).

Sign #3

Florida Law and Title VI of the Civil Rights Act of 1964 Prohibits Discrimination in: Public accommodations on the basis of race, color, national origin, sex, age, disability or income. In addition, the Florida Civil Rights Act does not permit discrimination on the basis of religion or family status. Persons believing they have been discriminated against on these conditions may file a complaint with the (transit agency name) at (transit agency phone number).

Exhibit 15

FDOT AMP Draw Analysis Worksheet

CHASSIS

MANUFACTURER & MODEL _____ VIN# _____ BUS NO. _____

DATE: _____ VEHICLE DESCRIPTION _____

ALTERNATOR MANUFACTURER _____ RATED AMP. OUTPUT _____

TOTAL IDLE AMP. OUTPUT (a) _____

SYSTEMS

AMP. DRAW

OEM Chassis _____

Lift _____

Entry Door _____

Second Stage A/C _____

Additional Second Stage Components _____

TOTAL AMP. DRAW (b) _____

{ (a)-(b)=(c) } TOTAL RESERVE AMPS. AVAILABLE (c) _____

Amp. Draw of Anticipated Components to be added _____

NOTE: Anticipated and/or Add on component(s)
Amp draw should not total more than 90% of
(c) above.

Bus Manufacturer: _____

Address: _____

Prepared By: _____

Signed: _____

Title: _____

Exhibit 16

Pre-Qualification Structural Testing for Cutaway Buses Acquired by the State of Florida

1. Scope

Pre-Qualification Structural Testing for Cutaway Buses Acquired by the State of Florida (PRE-QUAL) applies to all cutaway type vehicles procured through TRIPS contracts that have not undergone the Rollover Crashworthiness Assessment for Cutaway Buses Acquired by the State of Florida (FL-STANDARD).

2. Purpose

The purpose of the PRE-QUAL tests is to ensure that all cutaway buses acquired through FDOT contracts have a minimum level of structural integrity. PRE-QUAL is not intended to predict performance on the FL-STANDARD.

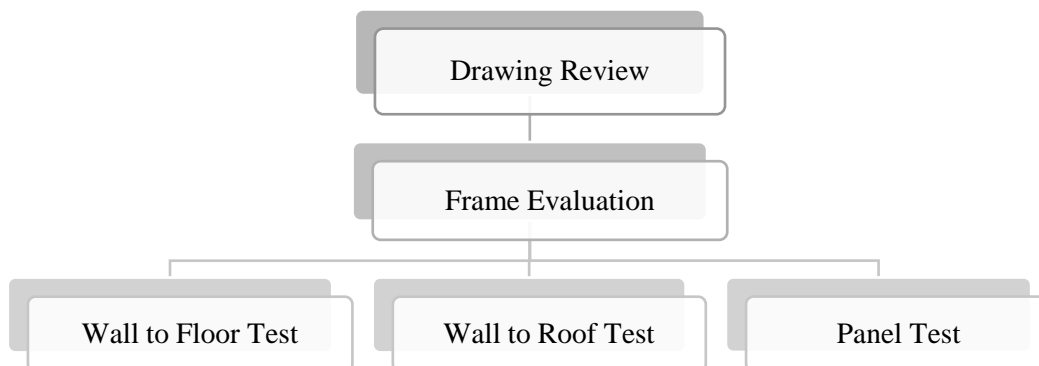

Figure 1: PRE-QUAL Testing Hierarchy

3. Approval

- 3.1. The PRE-QUAL process consists of five items, shown in Figure 1 and described in section 4, all of which must be successfully passed before a manufacturer is considered Pre-Qualified. FDOT will then grant a Temporary Waiver Contract. The PRE-QUAL process must be completed prior to first build; no buses will be built until satisfactory results are obtained.
- 3.2. The PRE-QUAL process is intended to be completed in 90 days. This time period assumes prompt supply of all required test materials by the manufacturer.

4. Requirements

- 4.1. Drawing Review – The manufacturer will be required to provide complete assembly drawings of the passenger compartment frame for evaluation. The drawings must include a detailed description of all structural connections.
- 4.2. Frame Evaluation – The manufacturer will be required to provide a passenger compartment frame consisting of only structural tubing that includes the entry stairwell and front cap (if the flooring material is an integral part of the floor to wall connection it should also be included) and one skinned sidewall panel. The frame and sidewall panel should be constructed using normal production methods. These components will be delivered to FDOT Springhill Road Bus Testing Facility in Tallahassee, FL.
 - 4.2.1 The provided frame will be compared with the assembly drawings. The frame will fail the evaluation if it is inconsistent with the previously provided assembly drawings or found not representative of normal production.
- 4.3. Wall to Floor (WF) Connection Test – The WF test is conducted to assess the strength of the sidewall to floor connection. In this test the floor portion of the test panel is fixed, and a force is then slowly applied to the sidewall portion. The applied load and the resulting rotation about the connection will be recorded simultaneously during the test. The energy required to rotate the sidewall through 16.7 deg. is then calculated and compared to the required threshold value. To account for different column spacing (and thus total number of columns in the frame), the threshold values are relative to the typical longitudinal distance

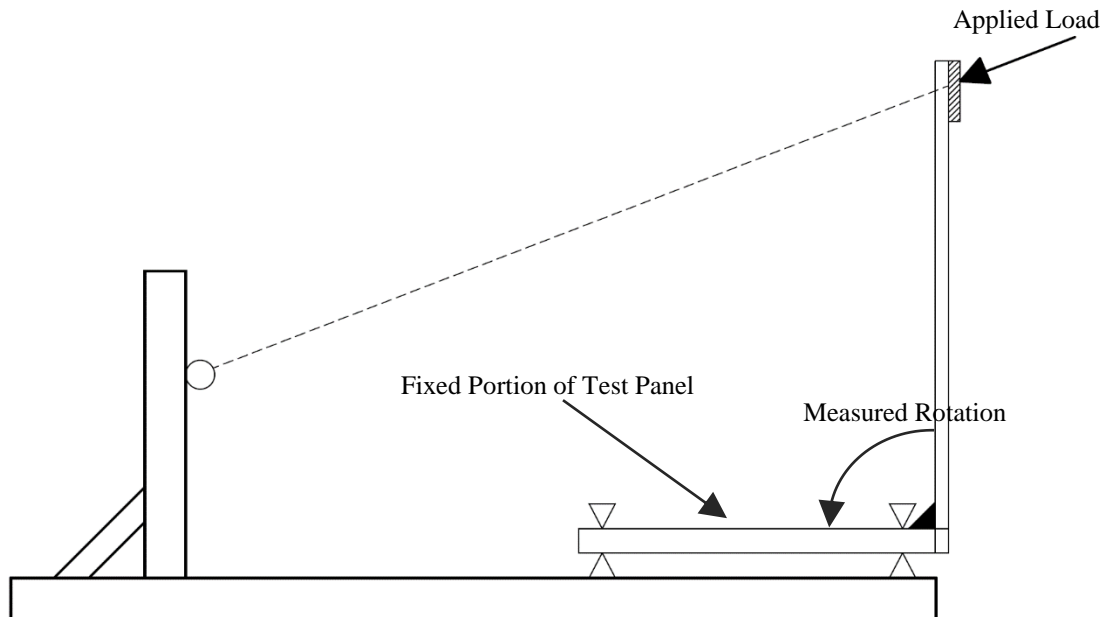

Figure 2: PRE-QUAL Connection Test

between adjacent columns in the passenger compartment frame.4.3.1 The test panel will include two adjacent sidewall columns plus 150mm to each side measured from the outside column face.

4.3.2 Application of loading may be in either direction (either towards or away from the inside face of the column).

4.3.3 A minimum of three WF connections cut from the provided body cage will be tested.

4.3.4 The WF connection will be considered “passed” if the average energy dissipated by all of the WF test specimens is greater than the following threshold:

WF = 300 J per meter of panel width measured over 16.7 degrees of rotation.

- 4.4. Wall to Roof (WR) Connection Test – The WR test is conducted to assess the strength of the sidewall to roof connection. In this test the roof portion of the test panel is fixed, and a force is then slowly applied to the sidewall portion. The applied load and the resulting rotation about the connection will be recorded simultaneously during the test. The energy required to rotate the sidewall through 23.0 deg. is then calculated and compared to the required threshold value. To account for different column spacing (and thus total number of columns in the frame), the threshold values are relative to the typical longitudinal distance between adjacent columns in the passenger compartment frame.

- 4.4.1 The test panel will include two adjacent sidewall columns plus 150mm to each side measured from the outside column face.
 - 4.4.2 Application of loading may be in either direction (either towards or away from the inside face of the column).
 - 4.4.3 A minimum of three WR connections cut from the provided body cage will be tested.
 - 4.4.4 The WR connection will be considered “passed” if the average energy dissipated by all of the WR test specimens is greater than the following threshold:
WR = 450 J per meter of panel width measured over 23.0 degrees of rotation.
- 4.5 Sidewall Panel Test – The Panel Impact test uses an impact hammer to dynamically deliver a calculated amount of kinetic energy to the test panel, as shown in Figure 3. The test energy is scaled according to the typical panel width of the passenger compartment (longitudinal distance between two adjacent columns). The resulting maximum permanent panel deflection is then measured after impact and compared to the threshold value.
- 4.5.1 The test panel will include two adjacent sidewall columns (plus 150mm of the sidewall structure on each side measured from the outside column face in the case of a continuous waistrail).
 - 4.5.2 A minimum of two panels cut from the skinned sidewall will be tested.
 - 4.5.3 The impact will be to the exterior side of the panel.
 - 4.5.3 The hammer will be raised to the height calculated to give the required kinetic energy at initial impact with the test panel surface, cleanly released, and allowed to fall under only the force of gravity until it impacts the test panel.
 - 4.5.4 The Panel Test will be considered “passed” if after impact with the energy specified below the average maximum permanent deflection is less than or equal to the following threshold:

Panel Test = 600 J per meter of panel width with less than 150 mm permanent deflection.

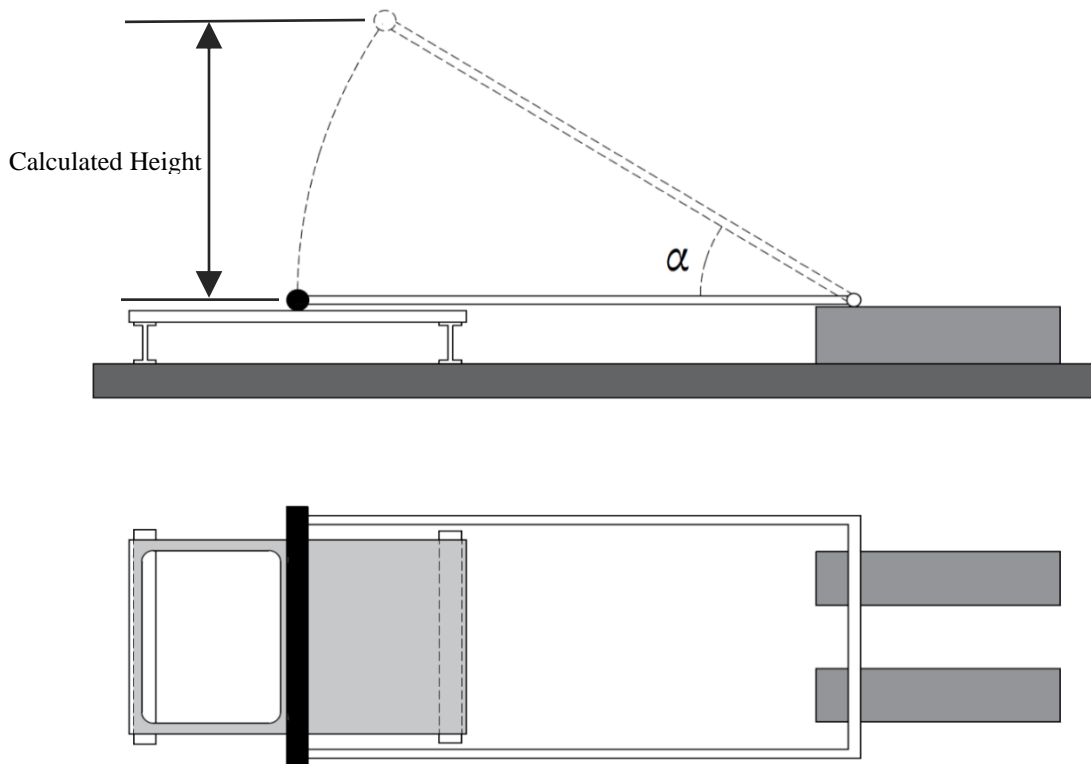

Figure 3: PRE-QUAL Sidewall Panel Test

4.6 PRE-QUAL Star Rating – In addition to pass or fail, the tested passenger compartment frame may earn up to five stars (*) as part of the FDOT PRE-QUAL Testing Star Rating (see Exhibit 12 - Star Rating Guidelines). One star will be awarded for each the following thresholds that are met or exceeded:

- a) WF = 400 J per meter of panel width measured over 16.7 degrees of rotation.
- b) WR = 600 J per meter of panel width measured over 23 degrees of rotation.
- c) Panel Test = 800 J per meter of panel width with less than 150 mm permanent deflection.

One additional star will be awarded if any two of the thresholds are met or exceeded, and two additional stars will be awarded if all three thresholds are met or exceeded.

5. Disclaimer

Neither the Crashworthiness and Impact Analysis Laboratory of the FAMU-FSU College of Engineering, its faculty, Florida State University, Florida A&M University, and their respective Boards of Trustees, nor the Florida Department of Transportation make any warranty, express or implied, as to the accuracy, quality, or usefulness of the information

contained in this publication for any purpose. In no event will FAMU-FSU College of Engineering, Florida State University, Florida A & M University, their respective Boards of Trustees, nor the Florida Department of Transportation be liable for any direct, indirect, punitive, incidental, special, consequential damages, or any damages whatsoever arising out of or connected with the use or misuse of this document. The parties do not warrant that the prescribed tests and calculations are sufficient to guarantee safety or structural integrity of any vehicle in an actual collision.

Exhibit 17

Rollover Crashworthiness Assessment for Cutaway Buses Acquired by the State of Florida

1. Scope

The Rollover Crashworthiness Assessment for Cutaway Buses Acquired by the State of Florida (FL-STANDARD) applies to all cutaway-type buses procured through FDOT contracts. It establishes the procedures and performance criteria for assessment of rollover crashworthiness.

2. Purpose

The purpose of this Standard is to reduce death and injuries resulting from the collapse of the cutaway bus passenger compartment during rollover accidents.

3. Approval

Approval under the FL-STANDARD consists of pre-test, test, and post-test requirements. The approval process is initiated by the manufacturer through Request for Approval. The request is followed by a Rollover Test of a cutaway bus (Figure 1). Successful completion of the Rollover Test grants approval. Approval is then maintained through meeting the Modification of Approval and Conformity of Production requirements.

4. Requirements

More detailed descriptions of the required approval procedures may be found in the FL-STANDARD Test Procedure. The Test Procedure will be available Sept. 2015.

- 4.1 ***Request for Approval*** - The request for approval will be submitted by the vehicle manufacturer to FDOT.

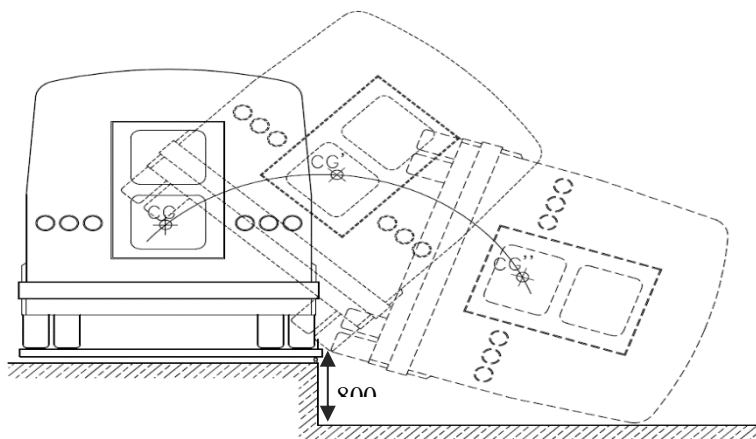

Figure 1: FL-STANDARD Rollover Test.

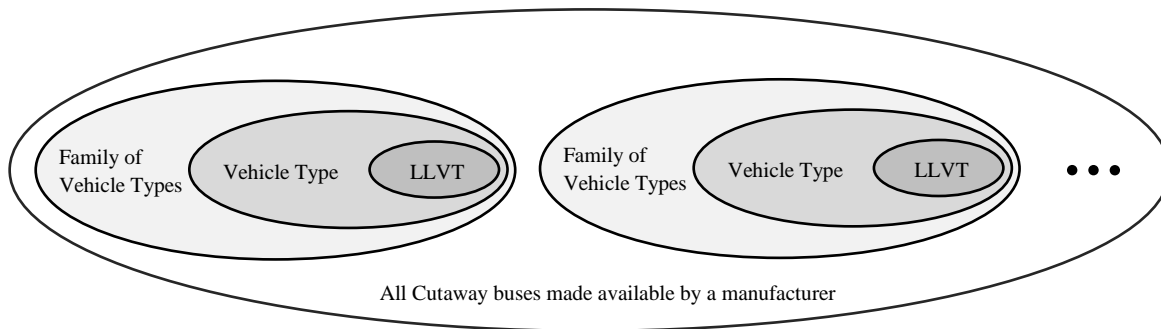

Figure 2: Relationship between the required bus categories.

The manufacturer must categorize their available cutaway vehicles into Vehicle Types. A Vehicle Type is a cutaway bus produced with the same design technical specification, main dimensions, and constructional arrangement. For example, a 22 ft. 158" WB bus, a 24 ft. 159" WB bus, and a 24 ft. 176" WB bus would be three different vehicle types, while two 22 ft. 158" WB buses with different interior configurations would be considered a single vehicle type.

- 4.1.2. For all declared Vehicle Types, the manufacturer will provide the following information to FDOT:
- a) Descriptions and dimensioned drawings of the passenger compartment and chassis.
 - b) The unloaded mass of the vehicle and the associated axle loads.
 - c) The exact position of the unloaded vehicle's center of gravity (including height).
- 4.1.3. At the request of FDOT, a complete vehicle will be presented to check its unloaded mass, axle loads, position of the center of gravity, and all other data and information related to the Vehicle Type definition.
- 4.1.4. The manufacturer must categorize the submitted vehicle types into Family of Vehicle Types. A Family of Vehicle Types is a collection of Vehicle Types in which the design of the passenger compartment frame is similar enough for them to be considered together as a group for the purposes of this Standard.
- 4.1.5. For each Family of Vehicle Types, FDOT will determine the Vehicle Type least likely to meet the requirements of this Standard. This determination will primarily be based on the loaded vehicle mass and the COG location. The Least Likely Vehicle Type (LLVT) will then be considered

representative of the Family of Vehicle Types for the purposes of this Standard.

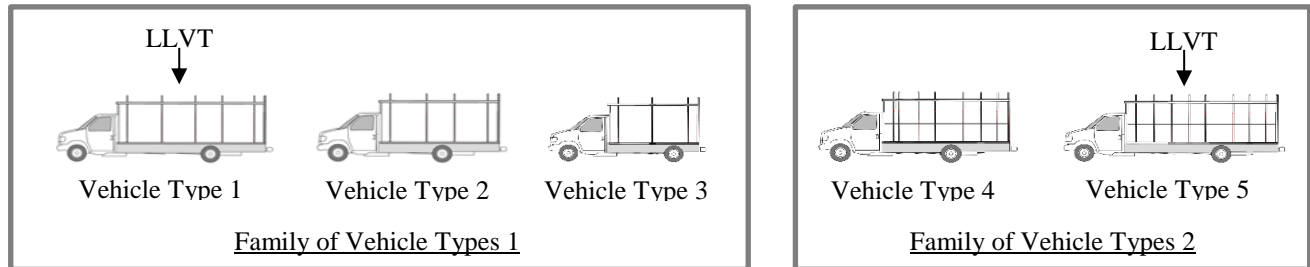

Figure 3: Example of required bus categorization showing five vehicle types split into two families due to structural differences, and the LLVT chosen from each family.

4.2. Rollover Test – The Rollover Test will be conducted by FDOT.

- 4.2.1. The manufacturer will build the LLVT passenger compartment onto a suitable chassis. A used chassis with a model year ≤ 10 years from the date of test, or an approved reusable generic chassis (as defined in the Test Procedure) is allowed in place of a new cutaway chassis.
- 4.2.2. The LLVT test bus must be built using normal production methods to the submitted Vehicle Type design specification. All structural and high mass items must be included, however, all parts do not need to be new, cosmetically perfect, or (in some cases) operational. Non-structural or low mass items can be omitted. The FL-STANDARD Test Procedure contains more detailed test bus build requirements and guidelines.
- 4.2.3. The LLVT test bus will be transported to the FDOT Springhill Bus Testing Facility in Tallahassee FL.
- 4.2.4. The Rollover Test is conducted by placing the prepared LLVT on a tilt table that is 800 mm above a smooth and level concrete surface, as illustrated in Figure 1. One side of the tilt table is raised until the vehicle becomes unstable, rolls off the platform, and impacts the concrete surface below. The rollover test will be carried out on that side of the vehicle that is determined to be most vulnerable.

4.2.4. The Rollover Test is conducted by placing the prepared LLVT on a tilt table that is 800 mm above a smooth and level concrete surface, as illustrated in Figure 1. One side of the tilt table is raised until the vehicle becomes unstable, rolls off the platform, and impacts the concrete surface below. The rollover test will be carried out on that side of the vehicle that is determined to be most vulnerable.

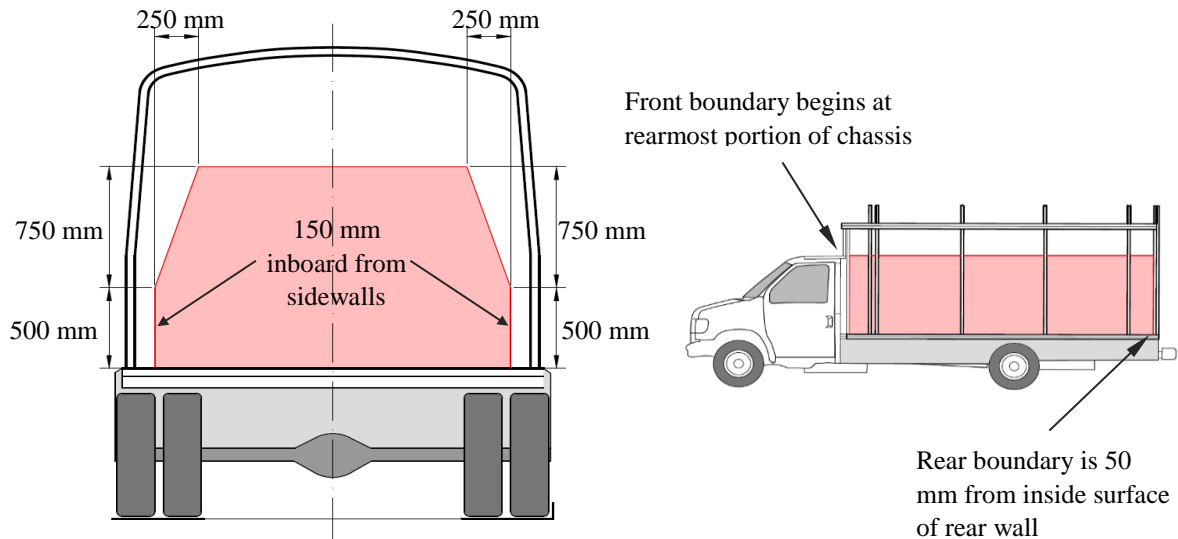

Figure 4: FL-STANDARD Survival Space.

4.2.5. Performance on the FL-STANDARD is evaluated using the concept of Survival Space. The Survival Space is a three-dimensional volume defined within the passenger compartment as shown in Figure 4. The Survival Space begins at the rearmost portion of the chassis cab and ends 50 mm from the inside surface of the passenger compartment rear wall. The outer boundary of the survival space at any transverse cross section between or at the front and rear boundaries is defined by the following symmetric polygon:

- a) Segment 1 extends vertically from the floor to an end point that is 500 mm above the floor and 150 mm inboard of the side wall;
- b) Segment 2 starts at the end point of Segment 1. The end point of Segment 2 is 750 mm vertically above and 250 mm horizontally inboard of the end point of Segment 1.
- c) Segment 3 is a horizontal line that starts at the end point of Segment 2 and ends at the vertical longitudinal center plane of the vehicle.

- 4.2.6. In order for approval to be granted, the passenger compartment frame of the vehicle must have sufficient strength to ensure that no part of the vehicle outside the survival space at the start of the test will intrude into the survival space at any time during the test. Any structural parts originally within the survival space will be ignored when evaluating the intrusion into the survival space.
- 4.2.7. Each anchorage of all vehicle seats and other permanently fastened interior items (if present) will not completely separate from its mounting structure during at any time during the rollover test.
- 4.2.8. After the vehicle comes to rest on the impact surface and while still resting on its side, each roof and rear emergency exit of the vehicle will be capable of releasing and opening with a force of not more than 60 pounds applied perpendicular to the door surface.

4.3. Modification of Approval

- 4.3.1 Every proposed modification of an approved Vehicle Type by the manufacturer will be submitted to FDOT, which will proceed with one of the three following courses of action:
 - a) Agree that the modifications made are unlikely to have any negative effect on rollover crashworthiness and that the modified vehicle type still complies with the requirements of this Standard.
 - b) Require a further test report to prove that the modified vehicle type complies with the requirements of this Standard.
 - c) Refuse the extension of approval and require a new approval procedure to be carried out.
- 4.3.2. The decision of FDOT, in cooperation with the manufacturer, will be based on an evaluation of how the proposed changes will affect the Vehicle Type's rollover crashworthiness.

4.4. Conformity of Production

- 4.4.1. Every vehicle manufactured under this Standard will conform to an approved Vehicle Type.
- 4.4.2. The normal frequency of inspections authorized by FDOT to check conformity will be once every year. If non-conformity is discovered in the course of one of these visits, FDOT may increase the visit frequency to re-establish the conformity of production as rapidly as possible.
- 4.4.3. The approval granted in respect of a Vehicle Type pursuant to this standard may be withdrawn if the requirements specified in this section are not complied with.

5. FL-STANDARD Rollover Star Rating

In addition to pass or fail, the tested vehicle may earn up to five stars (*) as part of the FDOT FL-STANDARD Rollover Star Rating (see Exhibit 12 - Star Rating Guidelines). The number of stars awarded will be determined by the front and rear Deformation Index (DI) values which will be calculated as defined in the FL-STANDARD Test Procedure. Stars will be awarded as shown below (both the front and rear DI must be \leq the given threshold):

Table 1: FL-Standard Rollover Star Rating

Rating	Required DI (both front and rear)
*	≤ 0.90
**	≤ 0.85
***	≤ 0.80
****	≤ 0.75
*****	≤ 0.70

6. Disclaimer

This specification is extracted from, and is consistent with, bus safety standards as required by the referenced U.S., U.N., and E.U. regulations as of the date of release of this Revision.

Neither the Crashworthiness and Impact Analysis Laboratory of the FAMU-FSU College of Engineering, its faculty, Florida State University, Florida A&M University, and their respective Boards of Trustees, nor the Florida Department of Transportation make any warranty, express or implied, as to the accuracy, quality, or usefulness of the information contained in this publication for any purpose. In no event shall FAMU-FSU College of Engineering, Florida State University, Florida A & M University, their respective Boards of Trustees, or the Florida Department of Transportation be liable for any direct, indirect, punitive, incidental, special, or consequential damages, or any damages whatsoever arising out of or connected with the use or misuse of this document. The parties do not warrant that the prescribed tests and calculations are sufficient to establish the safety or structural integrity of any vehicle in an actual collision.

PART 3

OPTIONS



Contract #TRIPS-17-CA-FTS-G

CUTAWAY TRANSIT VEHICLES

OPTIONS

#TRIPS-17-CA-FTS-G

3.1.0 ALTERNATIVE ENGINE, DIESEL OR ALTERNATIVE FUEL

- 3.1.1 Diesel engine meeting current EPA requirements in place of the standard gasoline engine. Engine must meet standards described in Part 2, Section 2.2.2.
- 3.1.2 A Compressed Natural Gas (CNG) or Alternative Fuel engine meeting current EPA requirements in place of the standard gasoline engine. Engine must meet standards described in Part 2, Section 2.2.3. Pricing for Alternate Fuel Vehicles include upcharge for delivery and Methane detection system (CNG only).
- 3.1.3 (CNG) Make: Westport/IMPCO, Installer: A1 Alternatives
- 3.1.4 Propane - Roush system
- 3.1.5 Propane – ICOM system

3.2.0 SUSPENSION

- 3.2.1 Kelderman 2-Stage Rear Air Suspension

3.3.0 WHEELS

- 3.3.1 Equip bus with stainless steel wheel liners / inserts on both front and rear wheels. Liner / inserts shall be Versa-Liner or approved equal, and made of 304L stainless steel with permanently attached simulated lug nuts. The simulated lug nuts shall not interfere with the actual lug nut to wheel contact surfaces.

3.4.0 SEATS, BELT EXTENSIONS, & SEAT UPHOLSTERY

- 3.4.5 Extend the length of the standard seat belts provided.

3.5.0 DRIVER'S SEAT

- 3.5.1 USSC Evolution G2E with pedestal
- 3.5.2 Freedman Sport Driver's seat with Relaxor, four zone eight motor system with lumbar heat in place of standard driver's seat.
- 3.5.3 Recaro Ergo LXS driver's seat.

3.6.0 FLOOR

3.6.1 A Flat-Floor option shall be provided.

3.7.0 FLOOR COVERING

3.7.1 Provide Altro Transflor slip resistant sheet vinyl flooring with smooth, all welded seams. Each customer will determine color / design selection. Include Altro step tread material with *yellow* step nosing and *white* “standee line” insert.

3.7.2 Provide Gerfloor slip resistant sheet vinyl flooring with smooth, all welded seams. Each customer will determine color / design selection. Include Gerfloor step tread material with *yellow* step nosing and *white* “standee line” insert.

3.8.0 DRIVER SAFETY PARTITION

3.8.1 To prevent passenger physical contact with the driver, install a 1/4” Lexan, or approved equal, shield wall, 3” below the ceiling to 36” above the floor; and a modesty panel from below the Lexan Plex shield frame to 3” above the floor, supported by stainless-steel tubing, similar in construction and design to the modesty panel adjacent to the front passenger door. Unit shall be designed to permit attachment of customer notification panel and/or pamphlet holder units.

3.9.0 GRAB RAILS AND STANCHIONS

3.9.1 Powder-Coated handrails and stanchions to match the vehicle interior and manufactured by Bentec, Inc, or approved equal.

3.10.0 REMOTE EXTERIOR MIRRORS

3.10.1 Provide right and left side exterior remote controlled mirrors, adjustable from the driver’s seat.

3.11.0 BUMPERS & REVERSE ASSISTANCE DETECTION SYSTEM

3.11.1 Provide Romeo Rim HELP bumper as an option.

3.11.2 Rear energy absorbing Romeo Rim HELP bumper assembled with HawKEye Reverse Assistance System, (Romeo Rim Help Guard) in place of standard rear steel bumper.

3.11.3 Reverse camera and monitor backing system, in lieu of HawkEye System above.

3.12.0 AIR PURIFICATION SYSTEM

3.12.1 SanUVAire UVGI Breathe-Safe Air purification and Coil Disinfection/Cleaning System. The system shall be designed for Paratransit bus application to eliminate the

spread of virus, bacteria, odors, mold and fungus growth within the bus air conditioning evaporator coils and drain pan.

3.13.0 WHEEL CHAIR LIFT

3.13.1 Braun Model NCL919IB-2 (or latest) Century

3.13.2 Braun Model NCL954IB3454-2 1000 lb Lift

3.13.3 Ricon Model S5510 (or latest)

3.13.4 Ricon Model S or K Titanium 1000 lb Lift

3.13.5 Ricon Klear-View lift (**prior approval from FDOT required**)

3.13.6 Braun model NVL917IB lift (**prior approval from FDOT required**)

3.14.0 SECUREMENT DEVICES

3.14.1 SURE-LOK Titan restraint system.

3.14.2 WC-18 Compliant restraint system.

3.15.0 SAFETY EQUIPMENT

3.15.1 Fogmaker Fire Suppression System, a complete turn-key automatic fire suppression system as standard equipment.

3.15.2 Kidde Fire Suppression System, a complete turn-key automatic fire suppression system.

3.15.3 SEON 2 camera system, 4 camera system, 6 camera system, 8-12 camera system

3.15.4 REI 2 camera system, 4 camera system, 6 camera system, 8 camera system

3.15.5 Gatekeeper 2 camera system, 4 camera system, 6 camera system, 8 camera system

3.15.6 AngelTrax 2 camera system, 4 camera system, 6 camera system, 8 camera system

3.15.7 Apollo 2 camera system, 4 camera system, 6 camera system, 8 camera system

3.15.9 Provide replacement surveillance camera

3.16.0 PA & ENTERTAINMENT SYSTEMS

3.16.1 Install a Radio Engineering Industries (REI) public address system with hand-held

microphone within easy reach of the driver with a microphone jack for optional hands-free use by driver. If an audio entertainment center is installed, utilize its speakers in mid and rear bus and install a cancel switch to turn off entertainment center system when microphone transmit button is depressed by driver. Provide a 20' long microphone extension cord and provide a microphone jack adjacent to the front curbside seat.

- 3.16.2 Upgrade the standard vehicle AM/FM Radio, providing an AM/FM/CD Stereo and MP3 Player with digital clock, with front, mid-bus and rear speakers.

3.17.0 DESTINATION SIGNS

- 3.17.1 A manually operated destination sign for limited destination readings shall be offered. Front destination sign shall be a Transign LLC, single roller curtain type installed above the windshield with a glass exposure of 8 inches x 60 inches. The side destination sign for a front door only bus will be a single roller type installed in the upper curbside window immediately behind the entrance door with a glass exposure of 5-3/4" x 28". The side destination sign for a front and rear door bus shall be installed in the upper curbside window immediately in front of the rear door. Destination signs will be electrically operated, LED, fluorescent or incandescent backlit display, single curtain, .003 mil. thick Mylar anti-glare material, with provisions for a minimum of 25 readings and a maximum of 175 readings of 5 inch high Helvetica medium font letters for the front sign and Helvetica medium font letters 4" high characters for the side sign. Control switch is to be located on the left hand of the driver's console. Curtain destination signs will conform to the Americans With Disabilities Act Part 38. Characters on these signs will have a width-to-height ratio between 3:5 and 1:1 and a stroke width-to-height ratio between 1:5 and 1:10. Generally, the space between letters will be 1/16 the height of upper case letters and will contrast with the background using either yellow letters on green or black background; or white letters on red, green, blue or black background per the purchaser's choice, for route and destination identification. The following destination readings will be standard on all destination signs ordered under this contract, with colors noted:

Bus Garage (yellow letters on black background)
Not In Service (yellow letters on black background)
Special Service (yellow letters on black background)
Shuttle Service (yellow letters on black background)
Downtown (yellow letters on green background)
Town Center (yellow letters on green background)
Public Transportation (yellow letters on green background)
Emergency Service (white letters on red background)
Emergency Shelter (white letters on red background)
Evacuation Route (white letters on red background)
Express (white letters on red background)

- 3.17.2 Twin Vision Elyse software Electronic Destination system full front and side signs; and a separate rear number only sign shall be provided. The system shall be compatible with Windows 2000 or Windows XP software, using IBM 486 or higher PC/AT capacity, PCMCIA memory download technology. Electronic destination signs will conform to the Americans With Disabilities Act Part 38. The electronic destination sign shall utilize Helvetica yellow medium lettering on black background. The readings listed in 3.16.1 above shall also be standard in all Elsyse electronic destination signs ordered under this contract.
- 3.17.3 A Twin Vision Mobi-Lite electronic destination sign, or approved equal, with side destination sign, using amber LED's and has fully programmable features that allow both large single and double line capabilities. The readings listed in 3.16.1 above shall also be standard in all Mobi-Lite electronic signs ordered under this contract.
- 3.17.4 A Transign Vista Star electronic destination sign, or approved equal, with side destination sign, using amber LED's and has fully programmable features that allow both large single and double line capabilities. The readings listed in 3.16.1 above shall also be standard in all Transign electronic signs ordered under this contract.
- 3.17.5 A Transign LLC 2-digit incandescent backlight, with anti-glare finish, dash mounted Block/Run Number Box, or approved equal, shall be provided. White, red or yellow LED letters/numbers on a black background, displayed in a plastic or metal frame, to operate on a 12 volt system.
- 3.17.6 A Transign LLC 3-digit incandescent backlight, with anti-glare finish, dash mounted Block/Run Number Box, or approved equal, shall be provided. White, red or yellow LED letters/numbers on a black background, displayed in a plastic or metal frame, to operate on a 12 volt system.
- 3.17.7 A "STOP REQUESTED" sign, as manufactured by Transign LLC, or approved equal, installed in the front vestibule area. Sign is activated by passengers and de-activates with the opening of the passenger entry door. Injected molded with display area of 2.5 X 19.75 minimum. Provide a silk screened lens display face with yellow letters on green background, or as required by Purchaser.
- 3.18.0 LIST OTHER MANUFACTURER OPTIONS AVAILABLE FOR CONSIDERATION**
- 3.18.1 Avail MDT – Includes Para Transit Kit #FC-2012 – Driver Interface, Communications, Interface Expansion Box (IEB), Emergency Alarm, and Navigational Assistance Unit
- 3.18.2 2-Position Sportworks bike rack (black)
- 3.18.3 2-Position Sportworks bike rack (stainless)

- 3.18.4 Bike rack prep
- 3.18.5 GFI farebox prep
- 3.18.6 Velvac manual mirrors
- 3.18.7 Velvac remote control mirrors
- 3.18.8 Latch attachment 2253.18.9 child seat restraint system
- 3.18.10 Delete blackout windows
- 3.18.11 Advertising racks (interior) mounted on facer pad above windows
- 3.18.12 Two-way radio prep fee
- 3.18.13 Mesh pocket for securement straps, on seat back, (per seat)
- 3.18.14 Armrests-Aisle or Wall side-each passenger seat location
- 3.18.15 MDT prep fee
- 3.18.16 Fleet numbers per location
- 3.18.17 Drivers running board to ease entry for the operator
- 3.18.18 12V outlets additional in operators' area, (per location)
- 3.18.19 Front mud flaps
- 3.18.20 Extra spare tire
- 3.18.21 Extra set of ignition keys
- 3.18.22 Overhead cab storage cabinet
- 3.18.23 Power seat base (drivers)
- 3.19.0 AIR CONDITIONING**
- 3.19.1 Change standard A/C to ACC Roof Mount Condenser:
- 3.19.2 Change standard A/C to ACC Roof Mount Complete
- 3.19.3 Change standard A/C to TK Skirt

- 3.19.4 Change standard A/C to TK Roof Complete
- 3.19.5 Change standard A/C to ACT Skirt
- 3.19.6 Change standard A/C to ACT Roof Mount Condenser
- 3.19.7 Change standard A/C to ACT Roof Mount Complete

3.20.0 MORE OPTIONS

- 3.20.1 LYTX Drive Cam helps you prevent accidents and exonerate drivers. Identify, prioritize and correct poor driving before an accident ever occurs.
- 3.20.2 Rosco Dual Vision is a continuous video and automotive event recorder.

PART 4

QUALITY ASSURANCE



Contract #TRIPS-17-CA-FTS-G

CUTAWAY TRANSIT VEHICLES

QUALITY ASSURANCE PROVISIONS

#TRIPS-17-CA-FTS-G

4.1.0 CONTRACTORS IN-PLANT QUALITY ASSURANCE REQUIREMENTS

4.1.1 QUALITY ASSURANCE ORGANIZATION

Manufacturer shall establish and maintain an effective in-plant quality assurance organization. It shall be a specifically defined organization and should be directly responsible to Manufacturer's top management.

4.1.2 CONTROL

The quality assurance organization shall exercise quality control over all phases of production from initiation of design through manufacture and preparation for delivery. The organization shall also control the quality of supply articles.

4.1.3 AUTHORITY AND RESPONSIBILITY

The quality assurance organization shall have the authority and responsibility for reliability, quality control, inspection planning, establishment of the quality control system, and the acceptance/rejection of materials and manufactured articles in the production of the vehicles.

4.2.0 QUALITY ASSURANCE ORGANIZATION FUNCTIONS

The quality assurance organization shall include the following minimum functions.

4.2.1 WORK INSTRUCTIONS

The quality assurance organization shall verify inspection operation instructions to ascertain that the manufactured product meets all prescribed requirements.

4.2.2 RECORDS MAINTENANCE

The quality assurance organization shall maintain and use records and data essential to the effective operation of its program. These records and data shall be available for review by the resident inspectors. Inspection and test records for this procurement shall be available for a minimum of one (1) year following the completion of the inspections and tests.

4.2.3 CORRECTIVE ACTION

The quality assurance organization shall detect and promptly assure correction of any conditions that may result in the production of defective vehicles. These conditions may occur in design, purchases, manufacture, tests or operations that culminate in defective supplies, services, facilities, technical data, or standards.

4.3.0 STANDARDS AND FACILITIES

The following standards and facilities shall be basic in the quality assurance process.

4.3.1 CONFIGURATION CONTROL

Manufacturer shall maintain drawings and other documentation that completely describe a qualified vehicle that meets all of the options and special requirements of this procurement. The quality assurance organization shall verify that each transit vehicle is manufactured in accordance with these controlled drawings and documentation.

4.3.2 MEASURING AND TESTING FACILITIES

Manufacturer shall provide and maintain the necessary gauges and other measuring and testing devices for use by the quality assurance organization to verify that the vehicles conform to all specification requirements. These devices shall be calibrated at established periods against certified measurement standards that have known valid relationships to national standards.

4.3.3 PRODUCTION TOOLING AS MEDIA OF INSPECTION

When production jigs, fixtures, tooling masters, templates, patterns, and other devices are used as media of inspection, they shall be proved for accuracy at formally established intervals and adjusting, replaced, or repaired as required to maintain quality.

4.3.4 EQUIPMENT USE BY TRIPS LINE INSPECTORS

Manufacturer's gauges and other measuring and testing devices shall be made available for use by the resident inspectors to verify the vehicles conform to all specification requirements. If necessary, Manufacturer's personnel shall be made available to operate the devices and to verify their condition and accuracy.

4.4.0 CONTROL OF PURCHASES

Manufacturer shall maintain quality control of purchases.

4.4.1 SUPPLIER CONTROL

Manufacturer shall require that each supplier maintains a quality control program for the services and supplies that it provides. Manufacturer's quality assurance organization shall inspect and test materials provided by suppliers for conformance to specification requirements. Materials that have been inspected, tested, and approved shall be identified as acceptable to the point of use in the manufacturing or assembly processes. Controls shall be established to prevent inadvertent use of nonconforming materials.

4.4.2 PURCHASING DATA

Manufacturer shall verify that all applicable specification requirements are properly included or referenced in purchase orders of articles to be used on vehicles.

4.5.0 MANUFACTURING CONTROL

Manufacturer shall ensure that all basic production operations, as well as other processing and fabricating, are performed under controlled conditions. Establishment of these controlled conditions shall be based on the documented work instructions, adequate production equipment, and special work environments if necessary.

4.5.1 COMPLETED ITEMS

A system for final inspection and test of completed vehicles shall be provided by the quality assurance organization. It shall measure the overall quality of each completed vehicle.

4.5.2 NONCONFORMING MATERIALS

The quality assurance organization shall monitor Manufacturer's system for controlling nonconforming materials. The system shall include procedures for identification, segregation, and disposition.

4.5.3 STATISTICAL TECHNIQUES

Statistical analysis, tests, and other quality control procedures may be used when appropriate in the quality assurance processes.

4.5.4 INSPECTION STATUS

A system shall be maintained by the quality assurance organization for identifying the inspection status of components and completed vehicles. Identification may include cards, tags, or other normal quality control devices.

4.6.0 INSPECTION SYSTEM

The quality assurance organization shall establish, maintain, and periodically audit a fully-documented inspection system. The system shall prescribe inspection and test of materials, work in progress, and completed articles. As a minimum, it shall include the following controls.

4.6.1 INSPECTION STATIONS

Inspection stations shall be at the best locations to provide for the work content and characteristics to be inspected. Stations shall provide the facilities and equipment to inspect structural, electrical, hydraulic, and other components and assemblies for compliance with the design requirements. Stations shall also be at the best locations to inspect or test characteristics before they are concealed by subsequent fabrication or assembly operations. These locations shall minimally include, as practicable, under-body structure completion, body framing completion, body prior to paint preparation, water test before interior trim and insulation installation, engine installation completion, under-body dress-up and completion, vehicle prior to final paint touch-up, vehicle prior to road test, and vehicle final road completion.

4.6.2 INSPECTION PERSONNEL

Sufficiently trained inspectors shall be used to ensure that all materials, components, and assemblies are inspected for conformance with the qualified vehicle design.

4.6.3 INSPECTION RECORDS

Acceptance, rework, or rejection identification shall be attached to inspected articles. Articles that have been accepted as a result of approved materials review actions shall be identified. Articles that have been reworked to specified drawing configurations shall not require special identification. Articles rejected as unsuitable or scrap shall be plainly marked and controlled to prevent installation on the vehicle. Articles that become obsolete as a result of engineering changes or other actions shall be controlled to prevent unauthorized assembly or installation. Unusable articles shall be isolated and then scrapped. Discrepancies noted by Manufacturer during assembly shall be entered on a record that accompanies the major component, subassembly, assembly, or vehicle from start of assembly through final inspection. Actions shall be taken to correct discrepancies or deficiencies in the manufacturing processes, procedures, or other conditions that cause articles to be in nonconformity with the requirements of the contract specifications. The inspection personnel shall verify the collective actions and mark the discrepancy record. If discrepancies cannot be corrected by replacing the nonconforming materials, the procuring agency shall approve the modification, repair, or method of correction to the extent that the contract specifications are affected.

4.6.4 QUALITY ASSURANCE AUDITS

The quality assurance organization shall establish and maintain a quality control audit program. Records of this program shall be subject to review by the TRIPS.

4.7.0 ACCEPTANCE TESTS**4.7.1 RESPONSIBILITY**

Fully documented tests shall be conducted on each production vehicle following manufacture to determine its acceptance to the TRIPS. These acceptance tests shall include pre-delivery inspections and testing by Manufacturer, and inspections and testing by the TRIPS prior to and after the vehicles have been delivered.

4.7.2 PRE-DELIVERY TESTS

Manufacturer shall conduct acceptance tests at its plant on each vehicle following completion of manufacture and before delivery to the TRIPS. The pre-delivery tests shall include visual and measured inspections, as well as testing the total vehicle operation. The tests shall be conducted and documented in accordance with written test plans. Additional tests may be conducted at Manufacturer's discretion to ensure that the completed vehicles have attained the desired quality and have met the requirements in **Part 2: Technical Specifications**. This additional testing shall be recorded on appropriate test forms provided by Manufacturer. The pre-delivery tests shall be scheduled and conducted with sufficient notice so that they may be witnessed by TRIPS line inspectors, who may accept or reject the results of the tests. The results of pre-delivery test, and any other tests, shall be filed with the assembly inspection records for each vehicle. The under-floor equipment shall be made available for inspection by the resident inspectors, using a pit or vehicle hoist provided by Manufacturer. A hoist, scaffold, or elevated platform shall be provided by Manufacturer to easily and safely inspect vehicle roofs. The TRIPS shall also conduct pre-delivery tests at the Springhill facility located in Tallahassee. It is Proposer's responsibility to ensure that the vehicle arrives at the Springhill facility prior to Proposer taking delivery of vehicle from Manufacturer. The results of this inspection will accompany the vehicle upon delivery to the purchaser.

4.7.3 INSPECTION-VISUAL AND MEASURED

Visual and measured inspections shall be conducted with the vehicle in a static condition. The purpose of the inspection testing is to verify overall dimensional and weight requirements, to verify that the required components are included and are ready for operation, and to verify that components and subsystems that are designed to operate with the vehicle in the static condition do function as designed.

4.7.4 TOTAL VEHICLE OPERATION

Total vehicle operation shall be evaluated during road tests. The purpose of the road tests is to observe and verify the operation of the vehicle as a system and to verify the functional operation of the subsystem that can be operated only while the vehicle is in motion. Each vehicle shall be driven for a minimum of fifteen (15) miles during the road tests. Observed defects shall be recorded on the test forms. The vehicle shall be retested when defects are corrected and adjustments are made. This process shall continue until defects or required adjustments are no longer detected. Results shall be pass/fail for these vehicle operation tests. After the road test, the line inspector representing the TRIPS reserves the right to have Manufacturer either raise the vehicle or drive the vehicle across a pit to allow the inspector to check the undercarriage.

4.8.0 POST-DELIVERY TESTS

The TRIPS may conduct acceptance tests on each delivered vehicle. These tests shall be completed within ten (10) working days after vehicle delivery. The purpose of these tests are to identify defects that have become apparent between the time of vehicle release and delivery to the purchaser. The post-delivery tests shall include visual inspection and vehicle operations. Vehicles that fail to pass the post-delivery tests are subject to non-acceptance. The TRIPS shall record details of all defects and notify Manufacturer of non-acceptance of each vehicle within five (5) working days after completion of these tests. The defects detected during these tests shall be repaired according to the procedures defined in **Part 1; Section 1.2, paragraph L**.

4.8.1 VISUAL INSPECTION

The post-delivery inspection is similar to the inspection at Manufacturer's plant and shall be conducted with the vehicle in a static condition.

4.8.2 VEHICLE OPERATION

The road tests for total vehicle operation are similar to those conducted at Manufacturer's plant. Operational deficiencies of each vehicle shall be identified and recorded.

PART 5

WARRANTY



Contract #TRIPS-17-CA-FTS-G

CUTAWAY TRANSIT VEHICLES

WARRANTY PROVISIONS**#TRIPS-17-CA- FTS-G****5.0.0 BASIC PROVISIONS****5.1.0 WARRANTY REQUIREMENTS**

Warranties in this document are in addition to any statutory remedies or warranties imposed on Contractor. A description of the local dealer warranty process shall be included in the Purchasing Agreement package including information on how warranty issues are tracked. The Contractor warrants and guarantees to the TRIPS each complete vehicle, and specific subsystems and components as follows:

5.1.1 COMPLETE VEHICLE

The vehicle is warranted and guaranteed to be free from defects for a minimum of Thirty-six (36) months or thirty-six thousand (36,000) miles, whichever comes first, beginning on the date of acceptance of each vehicle. During this warranty period, the vehicle shall maintain its structural and functional integrity. The warranty is based on regular operation of the vehicle under the operating conditions prevailing in the purchaser's locale.

5.1.2 SUBSYSTEMS AND COMPONENTS

Specific subsystems and components are warranted and guaranteed to be free from defects and related defects for the times and/or mileages given in **Exhibit 5-1**.

NOTE: *Parts and labor to be covered in all warranty provisions.*

Exhibit 5-1

STANDARD WARRANTY

Subsystem and Component Minimum Warranty, whichever occurs first.

NOTE: Parts and labor to be covered in all warranty provisions.

Item	Years	Mileage
OEM Chassis	3	36,000
Powertrain (gas)	5	60,000 Ford
	5	100,000 Chevrolet
Powertrain (diesel)	5	100,000
Air Conditioning System	4	unlimited
After Market Alternator	3	100,000
Wheelchair Lift	4	unlimited

SECOND STAGE BODY AND COMPONENTS

Body Structural	3	unlimited
Intermotive electrical	3	unlimited
Electrical system	3	unlimited
Auxiliary Heaters (Underseat)	3	unlimited
Electric Door System	3	unlimited
Electric Mirrors	3	unlimited
Alternative Fuels System	3	unlimited
Windows	3	unlimited
LED Lighting	3	unlimited
Event Data Recorder	3	unlimited

Note: Where OEM alternator is used, the OEM alternator warranty will prevail.

Note: Second stage components not mentioned above will be 3 years/unlimited mileage.

5.2.0 VOIDING OF WARRANTY

The warranty shall not apply to any part or component of the vehicle that has been subject to misuse negligence, accident, or that has been repaired or altered in any way so as to affect adversely its performance or reliability, except insofar as such repairs were in accordance with Contractor's maintenance manuals and the workmanship was in accordance with recognized standards of the industry. The warranty shall also be void if the purchaser fails to conduct normal inspections and scheduled preventive maintenance procedures as recommended in Contractor's maintenance manuals.

5.3.0 EXCEPTIONS TO WARRANTY

The warranty shall not apply to scheduled maintenance items, and items such as tires and tubes, nor to items furnished by the purchaser such as radios, fare boxes, and other auxiliary equipment, except insofar as such equipment may be damaged by the failure of a part or component for which Contractor is responsible.

5.4.0 DETECTION OF DEFECTS

If the purchaser detects a defect within the warranty periods defined in **Section 5.1.1**, it shall promptly notify the Dealer representative. Within five (5) working days after receipt of notification, Dealer representative shall either agree that the defect is in fact covered by the "complete vehicle" warranty, or reserve judgment until the subsystem or component is inspected by Dealer's representative and/or is removed and examined at the purchaser's property or at the Contractor's facility. At that time, the status of warranty coverage, either subsystem or vehicle, shall be mutually resolved between the purchaser and Dealer. If the defect belongs to a subsystem or component, then work necessary to affect the repairs defined in **Section 5.1.2** shall commence within ten (10) working days after receipt of notification by Dealer. Otherwise, **Section 5.1.1** applies and repairs will be started immediately.

5.5.0 SCOPE OF WARRANTY REPAIRS

When warranty repairs are required, the purchaser and Dealer's representative shall agree within five (5) days after notification on the most appropriate course for the repairs and the exact scope of the repairs to be performed under the warranty. If no agreement is obtained within the five (5) day period, the purchaser reserves the right to commence the repairs in accordance with **Section 5.7.1**.

5.6.0 FLEET DEFECTS

A fleet defect is defined as the failure of identical items covered by the warranty and occurring in the warranty period in a proportion of the vehicles delivered under this contract. For the purpose of this bid, identical defects occurring in sixty (60) percent of vehicles delivered shall be considered a "fleet defect."

5.6.1 SCOPE OF WARRANTY PROVISIONS

Dealer shall correct a fleet defect under the warranty provisions defined in **Section 5.4.0**. After correcting the defect, Dealer shall promptly undertake and complete a work program reasonably designed to prevent the occurrence of the same defect in all other vehicles purchased under this contract. The work program shall include inspection and/or correction of the potential or defective parts in all of the vehicles. The warranty on items determined to be fleet defects shall be extended for the time and/or miles of the original warranty. This extended warranty shall begin on the date a fleet defect was determined to exist, or on the repair/replacement date for corrected items.

5.6.2 VOIDING OF WARRANTY PROVISIONS

The fleet defect provisions shall not apply to vehicle defects caused by noncompliance with Dealer's recommended normal maintenance practices and procedures.

5.6.3 EXCEPTIONS TO WARRANTY PROVISIONS

Fleet defect warranty provisions shall not apply to damage that is a result of normal wear and tear in service to such items as seats, floor covering, windows, interior trim, and paint. The provisions shall not apply to purchaser supplied items such as fareboxes, two-way radios, and tires.

5.7.0 REPAIR PROCEDURES

5.7.1 REPAIR PERFORMANCE

In some instances, the TRIPS may require Dealer or its designated representative to perform warranty-covered repairs that are clearly beyond the scope of its capabilities. In these cases, this work will be done by TRIPS personnel with reimbursement by Dealer.

5.7.2 REPAIRS BY CONTRACTOR

If the TRIPS requires Dealer to perform warranty-covered repairs, Dealer's representative must begin within ten (10) working days after receiving notification of a defect from the purchaser, work necessary to effect repairs. The purchaser shall make the vehicle available to complete repairs timely with Dealer repair schedule. Dealer shall provide at its own expense all spare parts, tools, and space required to complete repairs. At the TRIPS option, Dealer may be required to remove the vehicle from the purchaser's property while repairs are being affected. If the vehicle is removed from the purchaser's property, repair procedures must be diligently pursued by Dealer's representative.

5.8.0 REPAIRS BY THE PURCHASER

5.8.1 PARTS USED

If the purchaser performs the warranty-covered repairs, it shall correct or repair the defect and any related defects using contractor-specified spare parts available from its own stock or those supplied by Dealer specifically for this repair. Monthly (or at a period to be mutually agreed upon) reports of all repairs covered by this warranty shall be submitted by the purchaser to Proposer for reimbursement or replacement of parts. Dealer shall provide forms for these reports.

5.8.2 CONTRACTOR SUPPLIED PARTS

The TRIPS may request that Dealer supply new parts for warranty-covered repairs being performed by the purchaser. These parts shall be shipped prepaid to the purchaser, from any source selected by Dealer, the “next business day” from receipt of the request for said parts.

5.8.3 DEFECTIVE COMPONENTS RETURN

Dealer may request that parts covered by the warranty be returned to the manufacturing plant. The total cost for this action shall be paid by Dealer. Materials should be returned in accordance with contractor's instructions.

5.8.4 REIMBURSEMENT FOR LABOR

The purchaser shall be reimbursed by Dealer for labor. The amount shall be determined by multiplying the number of man-hours actually required to correct the defect by the purchaser’s current per hour, master mechanic, straight wage rate, plus 32 percent fringe benefits, plus the cost of towing in the vehicle if such action was necessary and if the vehicle was in the normal service area. These wage and fringe benefit rates shall not exceed the rates in effect in the purchaser’s service garage at the time the defect correction is made. The purchaser shall not accept parts credit as payment of warranty labor claims.

5.8.5 REIMBURSEMENT FOR PARTS

The purchaser shall be reimbursed by Dealer for defective parts and for parts that must be replaced to correct the defect. The reimbursement shall be at the invoice cost of the part(s) at the time of repair and shall include taxes where applicable and 2 percent handling charges. The purchaser shall not accept parts credit as payment of warranty part claims.

5.9.0 WARRANTY AFTER REPLACEMENT / REPAIRS

If any component, unit, or subsystem is repaired, rebuilt, or replaced by Dealer or by the TRIPS personnel, with the concurrence of Dealer, the subsystem shall have the unexpired warranty period of the original subsystem.

monitoring that the agency receives correct replacement parts; return shipping and proper labor reimbursements in a timely manner.

5.10.5 WARRANTY REPORTING

The Dealer is required to input any reported and actionable *warranty repair* issues with the vehicle after the vehicle has been delivered and put into service, and report the actions taken to fix these issues during the entire warranty period. Information should include dates, contact persons, telephone numbers, description of the problem, repair facility, release date from the repair facility, agency notification dates and agency follow-up dates. These actions are entered into the DATACenter through the “**Vehicle Defect Form**”, accessed through the “**Repairs**” Tab. Select “warranty” on the form. Failure to enter prescribed warranty claims information into the TRIPS DATACenter will result in contract suspension after two (2) violations.”

PART 6

PAINT SCHEMES



Contract #TRIPS-17-CA-FTS-G

CUTAWAY TRANSIT VEHICLES

PAINT SCHEMES

#TRIPS-17-CA-FTS-G

6.1.0 EXTERIOR VEHICLE IDENTIFICATION

- 6.1.1 Window exterior black out and anodized black window frame shall be a customer option on all three paint schemes. Proposer shall submit pricing, including cost of blackout and finish of passenger window frames.
- 6.1.2 Individual corporate logos, agency name in specific size block lettering, reflective material, vinyl wrap or other vehicle identification requested by the Purchaser will be negotiated separately between the Purchaser and the Dealer outside of the TRIPS contract, but included in the final Purchase Order specifications and pricing for each vehicle.
- 6.1.3 FDOT assigns a specific number to each vehicle purchased using its Capital funding sources. The identification shall be displayed as **FDOT #000000** in 3M reflective material, or approved equal, Helvetica Medium two inch lettering/numbering. The numbering will be displayed on the rear and front of the vehicle at locations agreed to by TRIPS. It will be the dealer's responsibility to obtain this number from FDOT and post on the vehicle at delivery or immediately thereafter.
- 6.1.4 All buses purchased with funding provided through the American Recovery & Reinvestment Act (ARRA) shall have an official ARRA logo (see **Exhibit 6A**) attached to the rear surface of the vehicle above the bumper.

6.2.0 INTERIOR VEHICLE IDENTIFICATION

- 6.2.1 Manufacturer must post a "maximum capacity" of each vehicle placard on the interior bulkhead, including maximum number of standees. It must be visible from within the coach, mounted as far forward as practical, and within close proximity of the entrance door. Lettering to be a minimum of 2 inches.

EXHIBIT 6A



PAINT SCHEME #1 Optional

Paint Scheme
Unit # 1- 6" Beltline Stripe

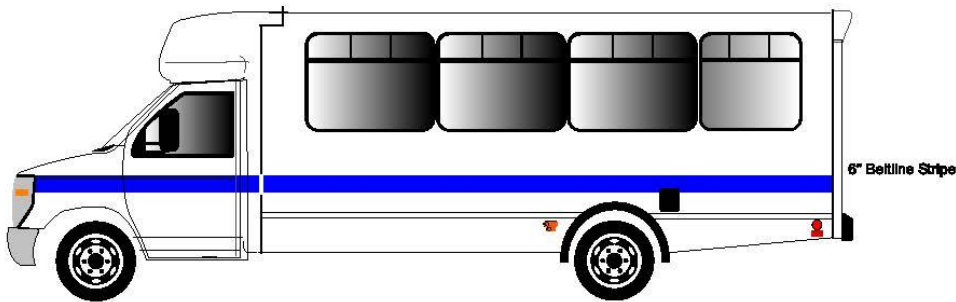

Sales Brian Beebe

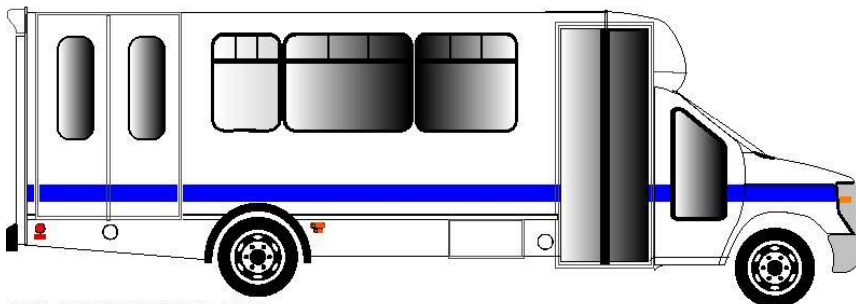

Paint and Vinyl Color & Number

- 1.)
- 2.)
- 3.)

04/10/2017

FloorPlan CH-25 Rear Lift
190" Wheelbase Overall Length 313.50"

Created by: Robin Miller
Graphics Department

PAINT SCHEME #2 Optional

Paint Scheme
Unit # 2- Beltline Stripes

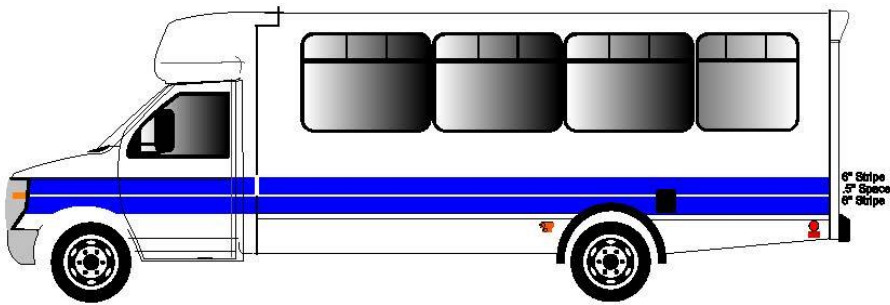

Sales Brian Beebe

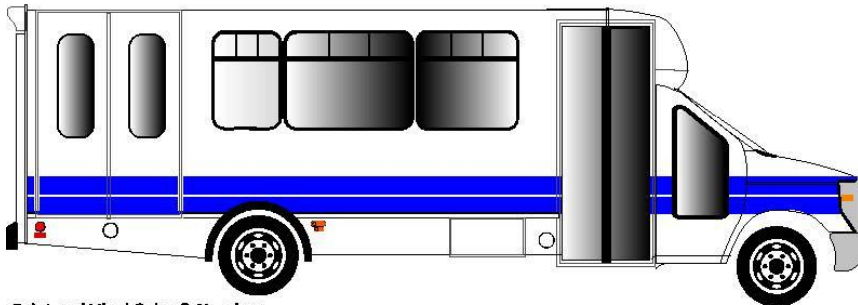

Paint and Vinyl Color & Number

- 1.)
- 2.)
- 3.)



04/10/2017

FloorPlan CH-25 Rear Lift
190" Wheelbase Overall Length 313.50"

Created by: Robin Miller
Graphics Department

PAINT SCHEME #3 Optional

Paint Scheme
Unit #3- 6" Beltline Stripes

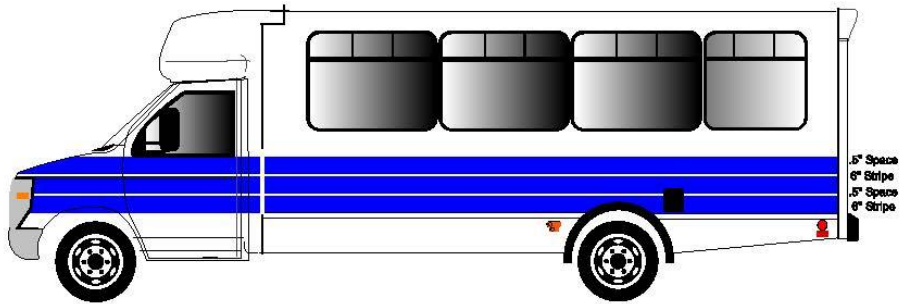

Sales Brian Beebe

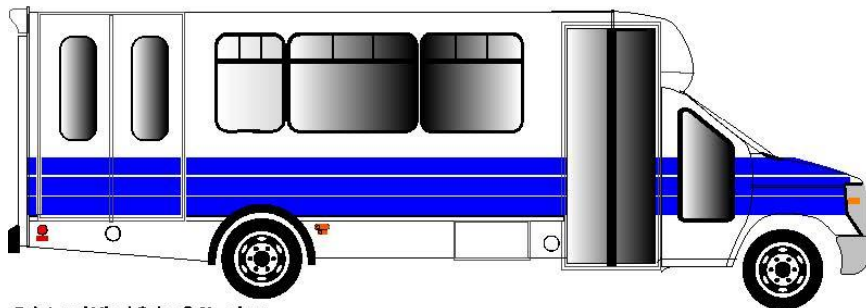
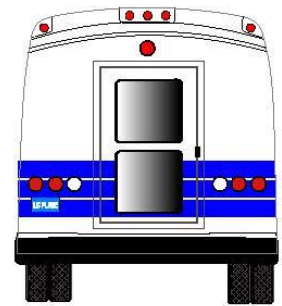

Paint and Vinyl Color & Number
1.)
2.)
3.)



04/10/2017

FloorPlan CH-25 Rear Lift:
190" Wheelbase Overall Length 313.50"

Created by: Robin Miller
Graphics Department