



---

## Historic Architectural Review Commission Staff Report for Item 9

To: Chairman Haven Burkee and Historic Architectural Review  
Commission Members

From: Enid Torregrosa-Silva, MSHP  
Historic Preservation Planner

Meeting Date: April 23, 2024

Applicant: Pope-Scarborough Architects

Application Number: H2024-0015

Address: 1104 Margaret Street

### **Description of Work:**

Demolition of non-historic front porch on principal house.

### **Site Facts:**

The site under review consists of two units; the principal house, facing Margaret Street, is listed as a contributing resource to the district. The second unit, 1104 Margaret Street Rear, is not listed in the surveys. The survey states that the one and a half-story frame vernacular house was built circa 1920, the Property Appraisers Records have 1932 as the construction date. If this is a reconstruction of a historic house, the front porch has a similar floor footprint as the circa 1965 photograph, which at the time increased the depth of said porch. The unique hip roof reflects the same form and height as the circa 1965 photograph.

When the owners bought the house, they were told that the principal house was built in 1985 after a fire burn the old house. The Sanborn Maps and the Florida Master Site Files depict a similar house and location as the circa 1965 photograph from the library. The house has no historic unpainted wood siding, windows, or doors and have pronounced eaves, which the circa 1965 photograph does not show.

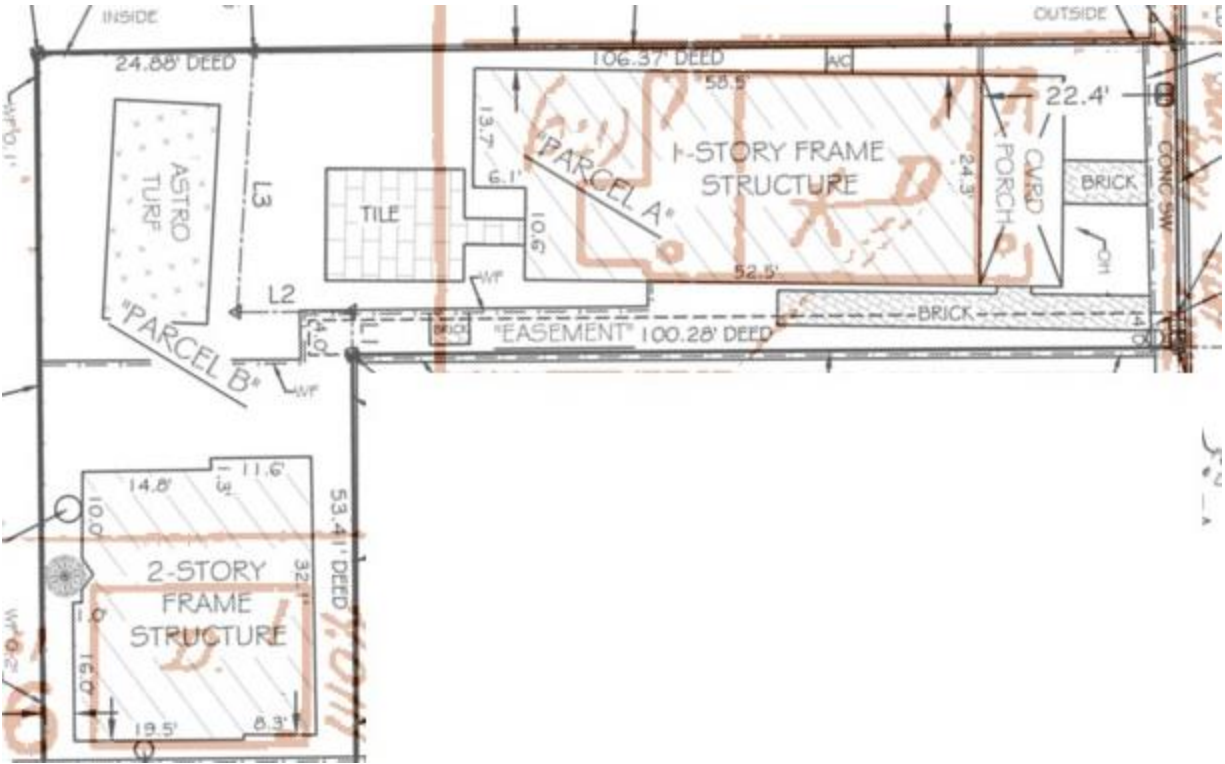

*1962 Sanborn Map and current survey overlay.*



*Principal house on the site circa 1965.*



*Front elevation.*

**Ordinance Cited on Review:**

- Section 102-217 (3), demolition for historic but non-contributing, non-contributing, or non-historic structures of the Land Development Regulations.

**Staff Analysis:**

The Certificate of Appropriateness proposes the demolition of a non-historic front porch. The applicant has submitted plans for a proposed new front porch that will reduce the depth of the existing architectural element.





*Aerial photographs, upper 1972 and bottom March 1994.*

Since the structure under review is not historic, the evaluation shall be based on section 102-217 (3) of the Land Development Regulations, which requires the following criteria for demolitions:

The historic architectural review commission shall not issue permits that would result in:

- (1) *Removing buildings or structures that are important in defining the overall historic character of a district or neighborhood so that the character is diminished;*

It is staff's opinion that although the front porch is a character defining feature of the house, its proportions, specifically the depth, do not respond to traditional front porched find in the area. A new porch will be built as a substitution.

- (2) *Removing historic buildings or structures and thus destroying the historic relationship between buildings or structures and open space;*

The proposed elements to be demolished are not historic.

- (3) *Removing an historic building or structure in a complex; or removing a building facade; or removing a significant later addition that is important in defining the historic character of a site or the surrounding district or neighborhood.*

The non-historic structure under review will be replaced with a new front porch that will have more traditional proportions and will better fit to the historic character of the neighborhood.

- (4) *Removing buildings or structures that would otherwise qualify as contributing, as set forth in section 102-62(3).*

That will not be the case.

In conclusion, it is staff's opinion that the request for demolition of the front porch can be considered by the Commission as it meets the criteria for demolition stated under the Land Development Regulations. If approved, this will be the only required reading for the demolition.

PAGE 1  
Original x  
Update 3-1-98

HISTORICAL STRUCTURES FORM  
FLORIDA MASTER SITE FILE

SITE Mo2785  
Recorder JD

SITE NAME: D.E. & S.K. Bennett, House  
HISTORIC CONTEXTS: Boom Times  
NAT. REGISTER CATEGORY: Building  
OTHER NAMES OR MSF NOS:  
COUNTY: Monroe OWNERSHIP TYPE: Private  
PROJECT NAME: Key West Historic Sites Survey DHR NO:  
LOCATION:  
ADDRESS: 1104 Margaret Street CITY: Key West  
VICINITY OF/ROUTE TO: south side of Margaret between Virginia and  
Catherine  
SUBDIVISION: BLOCK NO: 5 LOT NO: 9  
PLAT OR OTHER MAP: TAX PARCEL NUMBER RE-30430.000000  
TOWNSHIP: RANGE: SECTION: 1/4: 1/4-1/4:  
IRREGULAR SEC? LAND GRANT:  
USGS 7.5' MAP:  
UTM: ZONE: EASTING: NORTHING:  
COORDINATES: LATITUDE: LONGITUDE:

HISTORY

ARCHITECT: unknown  
BUILDER: unknown  
CONST DATE: CIRCA: 1920s RESTORATION DATE (S):  
MODIFICATION DATE (S):  
MOVE: DATE: ORIG LOCATION:  
ORIGINAL USE (S): residence  
PRESENT USE (S): residence

DESCRIPTION

STYLE: Frame Vernacular  
PLAN: EXTERIOR: irregular  
INTERIOR:  
NO: STORIES: 1 OUTBUILDINGS: PORCHES: 1 DORMERS:  
STRUCTURAL SYSTEM (S): wood frame  
EXTERIOR FABRIC (S): wood  
FOUNDATION: TYPE: piers MATLS: block  
INFILL:  
PORCHES: 3-bay projecting entry-N.  
ROOF: TYPE: hip SURFACING: v-crimp  
SECONDARY STRUCT.: hip  
CHIMNEY: NO: MATLS: LOCNS:  
WINDOWS: 8/8 DHS

EXTERIOR ORNAMENT: shutters, skylight, exp. rafters  
CONDITION: excellent SURROUNDINGS: residential  
NARRATIVE: This house is similar in size and style to others in the  
immediate area.

ARCHAEOLOGICAL REMAINS AT THE SITE

FMSF ARCHAEOLOGICAL FORM COMPLETED? Y x N (IF Y, ATTACH)  
ARTIFACTS OR OTHER REMAINS none observed

RECORDER'S EVALUATION OF SITE

AREAS OF SIGNIFICANCE: architecture

ELEGIBLE FOR NAT. REGISTER?	Y	N	LIKELY, NEED INFO x	INSF	INF
SIGNF. AS PART OF DISTRICT? x	Y	N	LIKELY, NEED INFO	INSF	INF
SIGNIFICANT AT LOCAL LEVEL?	Y	N	LIKELY, NEED INFO x	INSF	INF

SUMMARY ON SIGNIFICANCE

This is a good example of a Frame Vernacular style residence that was constructed during the Boom Times.

\* \* \*DHR USE ONLY \* \* \* \* \* DHR USE O\*

\* DATE LISTED ON NR \_\_\_\_\_ \*

\* KEEPER DETERMINATION OF ELIG. (DATE): -YES \_\_\_\_\_ -NO \_\_\_\_\_ \*

\* SHPO EVALUATION OF ELIGIBILITY (DATE): -YES \_\_\_\_\_ -NO \_\_\_\_\_ \*

\* LOCAL DETERMINATION OF ELIG. (DATE): -YES \_\_\_\_\_ -NO \_\_\_\_\_ \*

\* OFFICE \_\_\_\_\_ \*

\* \* \* \* DHR USE ONLY\* \* \* \* \* DHR USE ONLY\* \* \*

RECORDER INFORMATION: NAME F Jane M S L Day  
DATE: MO 2 YR 98 AFFILIATION Research Atlantica, Boca Raton, Florida

PHOTOGRAPHS

LOCATION OF NEGATIVES  
NEGATIVE NUMBERS roll #60, neg. #25

PHOTOGRAPH

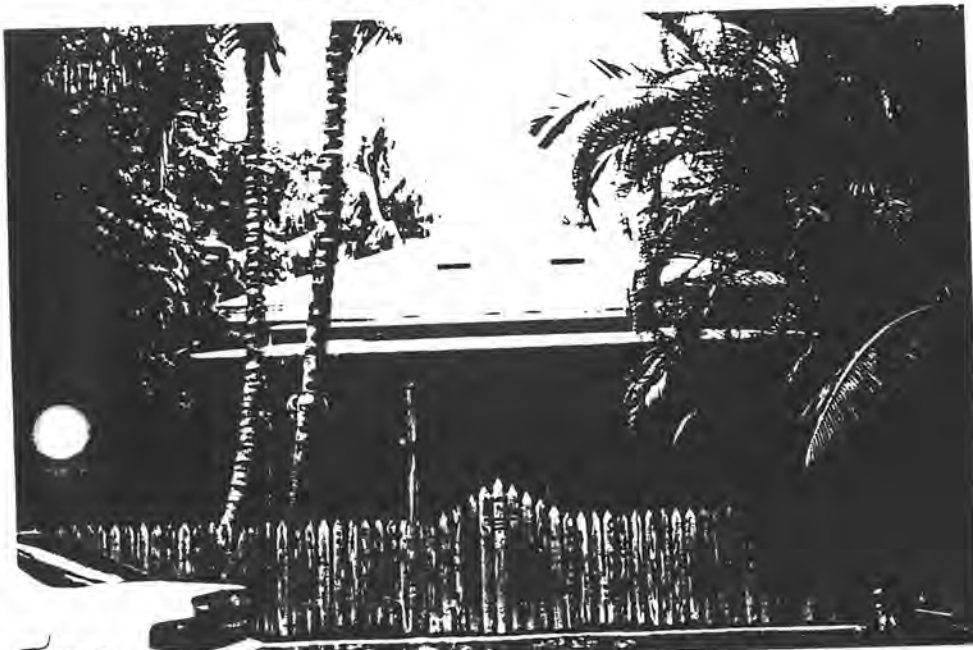

MAP

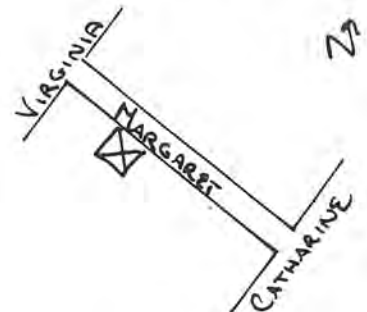

8Mo 02785  
1104 MARGARET  
Key West, FLORIDA



# HISTORICAL STRUCTURE FORM

Electronic Version 1.1.0

Site #8 MO02785  
Recorder # \_\_\_\_\_  
Field Date \_\_\_\_\_  
Form Date \_\_\_\_\_  
FormNo 200402  
FormNo = Field Date (YYYYMM)

First Site Form Recorded for this Site? NO

## GENERAL INFORMATION

Site Name (address if none) BENNETT, DE AND SK HOUSE Multiple Listing (DHR only) \_\_\_\_\_  
Other Names \_\_\_\_\_ >> \_\_\_\_\_  
Survey or Project Name Key West Historic Resources Survey Survey# \_\_\_\_\_  
National Register Category Building(s)

## LOCATION & IDENTIFICATION

### Address

Street No.	Direction	Street Name	Street Type	Direction Suffix
<u>1104</u>		<u>MARGARET</u>	<u>Street</u>	

Cross Streets (nearest/ between) VIRGINIA/CATHERINE  
City / Town (within 3 miles) KEY WEST In Current City Limits? YES  
County Monroe Tax Parcel #(s) RE-30430.000000  
Subdivision Name \_\_\_\_\_ Block 5 Lot 9  
Ownership Private Individual  
Name of Public Tract (e.g., park) \_\_\_\_\_  
Route to (especially if no street address) S SIDE OF MARGARET BETWEEN VIRGINIA AND CATHERINE

## MAPPING

USGS 7.5' Map Name \_\_\_\_\_ Publication Date \_\_\_\_\_ >> KEY WEST; 1971  
Township: \_\_\_\_\_ Range: \_\_\_\_\_ Section: \_\_\_\_\_ 1/4 section: \_\_\_\_\_ >> 67S ; 25E ; 34 ; UNSP  
Irregular Section Name: \_\_\_\_\_  
Landgrant \_\_\_\_\_  
UTM: Zone 0 Easting 0 Northing 0  
Plat or Other Map (map's name, location) \_\_\_\_\_

## DESCRIPTION

Style Frame Vernacular Other Style \_\_\_\_\_  
Exterior Plan Irregular Other Exterior Plan \_\_\_\_\_  
Number of Stories 1  
Structural System(s) \_\_\_\_\_ >> Wood frame  
Other Structural System(s) \_\_\_\_\_  
Foundation Type(s) \_\_\_\_\_ >> Piers  
Other Foundation Types \_\_\_\_\_  
Foundation Material(s) \_\_\_\_\_ >> Other  
Other Foundation Material(s) BLOCK  
Exterior Fabric(s) \_\_\_\_\_ >> Weatherboard  
Other Exterior Fabric(s) \_\_\_\_\_  
Roof Type(s) \_\_\_\_\_ >> Hip  
Other Roof Type(s) \_\_\_\_\_  
Roof Material(s) \_\_\_\_\_ >> Other  
Other Roof Material(s) V CRIMP  
Roof Secondary Structure(s) (dormers etc) \_\_\_\_\_ >> Other  
Other Roof Secondary Structure(s) HIP  
Number of Chimneys 0  
Chimney Material Not applicable  
Other Chimney Material(s) \_\_\_\_\_  
Chimney Location(s) NOT APPLICABLE



# HISTORICAL STRUCTURE FORM

8MO02785

## DESCRIPTION (continued)

Window Descriptions 8/8 DHS

Main Entrance Description (stylistic details) \_\_\_\_\_

Porches: #open 1 #closed \_\_\_\_\_ #incised \_\_\_\_\_ Location(s) 3 BAY PROJECTING ENTRY N

Porch Roof Types(s) \_\_\_\_\_

Exterior Ornament SHUTTERS, SKYLIGHT, EXP RAFTERSInterior Plan Unspecified

Other Interior Plan \_\_\_\_\_

Condition Excellent

### Structure Surroundings

Commercial: NONE of this category Residential: ALL this categoryInstitutional: NONE of this category Undeveloped: NONE of this category

Ancillary Features (Number / type of outbuildings, major landscape features) \_\_\_\_\_

Archaeological Remains (describe): NONE OBSERVEDIf archaeological remains are present, was an Archaeological Site Form completed? NONarrative Description (optional) THIS HOUSE IS SIMILAR IN SIZE AND STYLE TO OTHERS IN THE IMMEDIATE AREA.

## HISTORY

Construction year C1920Architect (last name first): UNKNOWNBuilder (last name first): UNKNOWN

### Changes in Locations or Conditions

Type of Change	Year of Change	Date Change Noted	Description of Changes
>> <u>Unspecified;;</u>			

### Structure Use History

Use \_\_\_\_\_ Year Use Started \_\_\_\_\_ Year Use Ended \_\_\_\_\_ >> Private residence;;

Other Structure Uses \_\_\_\_\_

Ownership History (especially original owner, dates, profession, etc.) unspecified

## RESEARCH METHODS

Research Methods >> Examine local tax recordsOther research methods Sanborn Maps

## SURVEYOR'S EVALUATION OF SITE

Potentially Eligible for a Local Register? YESName of Local Register if Eligible Key West Historic DistrictIndividually Eligible for National Register? NOPotential Contributor to NR District? YESArea(s) of historical significance >> Architecture

Other Historical Associations \_\_\_\_\_

Explanation of Evaluation (required) This is a contributing resource in the Key West Historic District, listed in the National Register

# HISTORICAL STRUCTURE FORM

8MO02785

## DOCUMENTATION (Photos, Plans, etc.)

Photographic Negatives or Other Collections Not Filed with FMSF, Including Field Notes, Plans, other Important Documents.

Document type: \_\_\_\_\_ Maintaining Organization: \_\_\_\_\_

File or Accession #: \_\_\_\_\_ Descriptive Information: \_\_\_\_\_

>> ;;;Photographs (Archived)

## RECORDER INFORMATION

Recorder Name (Last, First) Geoff Henry, Shelby Spillers, Heather Yost

Recorder Address / Phone 200 Orchard Ridge Dr, Suite 101, Gaithersburg, MD 20878 (301)258-9780

Recorder Affiliation Other Other Affiliation URS Corporation

Is a Text-Only Supplement File Attached (Surveyor Only)? NO

## \*\*\*\*\* MASTER SITE FILE USE ONLY \*\*\*\*\*

Cultural Resource Type: SS

Electronic Form Used: S110

Form Type Code: NORM

Form Quality Ranking: NEW

Form Status Code: SCAT

Supplement Information Status: NO SUPPLEMENT

Supplement File Status: NO SUPPLEMENT FILE

FMSF Staffer: RECORDERS SMARTFORM

Computer Entry Date: 3/8/2004

SHPO's Evaluation of Resource

\_\_\_\_\_ Date \_\_\_\_\_

Form Comments: \_\_\_\_\_  
\_\_\_\_\_  
\_\_\_\_\_

### **REQUIRED PAPER ATTACHMENTS**

- (1) USGS 7.5" MAP WITH STRUCTURE PINPOINTED IN RED
- (2) LARGE SCALE STREET OR PLAT MAP
- (3) PHOTO OF MAIN FACADE, B&W, AT LEAST 3"X5"

# MO02785-200402

## Supplementary Printout

- > **[Other name(s)]:**
  
- > **USGS map name/year of publication or revision:**  
KEY WEST;1971
  
- > **Township/Range/Section/Qtr:**  
67S ;25E ;34;UNSP
  
- > **Foundation types:**  
Piers
  
- > **Foundation materials:**  
Other
  
- > **Exterior fabrics:**  
Weatherboard
  
- > **Roof types:**  
Hip
  
- > **Roof materials:**  
Other
  
- > **Roof secondary structures (dormers etc):**  
Other
  
- > **Change status/year changed/date noted/nature:**  
Unspecified;;;
  
- > **Original, intermediate, present uses/year started/year ended:**  
Private residence;;  
Private residence;C1920;
  
- > **Research methods:**  
Examine local tax records
  
- > **Area(s) of historical significance:**  
Architecture
  
- > **Repositories: Collection/Housed/Accession#/Describe**  
;;;Photographs (Archived)
  
- > **Structural system(s):**  
Wood frame

CONTINUED OF

CONTINUED ON PAGE NO. 28

WINDSOR LANE

VIRGINIA

CONTINUED ON PAGE NO. 38

STREET

CONTINUED ON PAGE NO. 43

WILLIAM

UNITED

CONTINUED ON PAGE NO. 43

WILLIAM STREET

ROYAL STREET

MARGARET

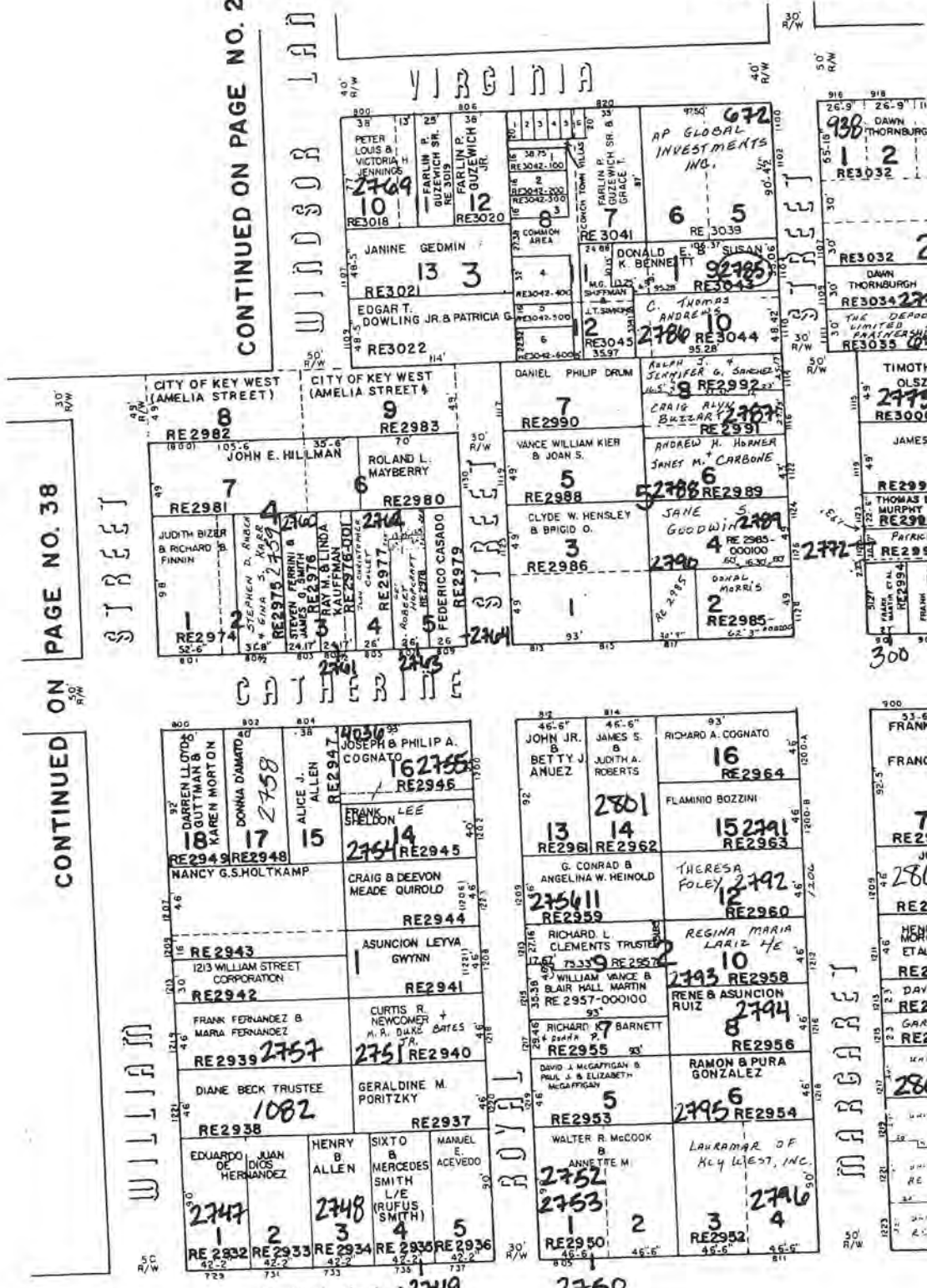





M02785  
1104 Margaret Street  
Key West  
Monroe  
Feb. 2004

**RECEIVED**  
 MAR 13 2024  
 TK

**HARC MAJOR PROJECTS CERTIFICATE OF APPROPRIATENESS**  
 \$420 NON-REFUNDABLE BASE APPLICATION FEE - OTHER FEES MAY BE APPLICABLE Rev 12/14/2020ET



**City of Key West**  
 1300 WHITE STREET  
 KEY WEST, FLORIDA 33040

HARC COA # <b>HARC 2024-0015</b>	REVISION #	INITIAL & DATE <b>TK 3/13/2024</b>
FLOOD ZONE	ZONING DISTRICT	BLDG PERMIT #

**A PRE-APPLICATION MEETING WITH HARC STAFF IS REQUIRED PRIOR TO SUBMITTAL**

ADDRESS OF PROPOSED PROJECT:	1104 Margaret	
NAME ON DEED:	Craig Reynolds & Marjorie Booton	PHONE NUMBER
OWNER'S MAILING ADDRESS:	1104 Margaret	EMAIL
APPLICANT NAME:	Pope Scarbrough Architects	PHONE NUMBER 305-942-9935
APPLICANT'S ADDRESS:	610 White Street	EMAIL holly@p-s-architects.com
APPLICANT'S SIGNATURE:		DATE 2-26-24

**ANY PERSON THAT MAKES CHANGES TO AN APPROVED CERTIFICATE OF APPROPRIATENESS MUST SUBMIT A NEW APPLICATION.**

FLORIDA STATUTE 837.06: WHOEVER KNOWINGLY MAKES A FALSE STATEMENT IN WRITING AND WITH THE INTENT TO MISLEAD A PUBLIC SERVANT IN THE PERFORMANCE OF HIS OR HER OFFICIAL DUTY SHALL BE GUILTY OF A MISDEMEANOR OF THE SECOND DEGREE PUNISHABLE PER SECTION 775.082 OR 775.083. THE APPLICANT FURTHER HEREBY ACKNOWLEDGES THAT THE SCOPE OF WORK AS DESCRIBED IN THE APPLICATION SHALL BE THE SCOPE OF WORK THAT IS CONTEMPLATED BY THE APPLICANT AND THE CITY. THE APPLICANT FURTHER STIPULATES THAT SHOULD FURTHER ACTION BE TAKEN BY THE CITY FOR EXCEEDING THE SCOPE OF THE DESCRIPTION OF WORK, AS DESCRIBED HEREIN, AND IF THERE IS CONFLICTING INFORMATION BETWEEN THE DESCRIPTION OF WORK AND THE SUBMITTED PLANS, THE AFOREMENTIONED DESCRIPTION OF WORK SHALL BE CONTROLLING.

PROJECT INCLUDES: REPLACEMENT OF WINDOWS  RELOCATION OF A STRUCTURE  ELEVATION OF A STRUCTURE   
 PROJECT INVOLVES A CONTRIBUTING STRUCTURE: YES  NO  INVOLVES A HISTORIC STRUCTURE: YES  NO   
 PROJECT INVOLVES A STRUCTURE THAT IS INDIVIDUALLY LISTED ON THE NATIONAL REGISTER: YES  NO

DETAILED PROJECT DESCRIPTION INCLUDING MATERIALS, HEIGHT, DIMENSIONS, SQUARE FOOTAGE, LOCATION, ETC.	
GENERAL:	Remove and construct new front porch. New composite decking. New 184 sq. ft. accessory structure in rear of property.
MAIN BUILDING:	Reconfigure front porch.
DEMOLITION (PLEASE FILL OUT AND ATTACH DEMOLITION APPENDIX):	Remove front porch.

APPLICATIONS MUST BE SUBMITTED IN PERSON WITH HARD COPIES BY 3PM ON THE SCHEDULED DEADLINE  
PLEASE SEND AN ELECTRONIC COPY OF ALL DOCUMENTS TO HARC@CITYOFKEYWEST-FL.GOV

ACCESSORY STRUCTURE(S): New 184 sq. ft. Accessory Structure at rear of property.	
<b>PAVERS:</b>	<b>FENCES:</b>
<b>DECKS:</b>	<b>PAINTING:</b>
Composite decking on front porch.	Natural wood finish to match existing.
<b>SITE (INCLUDING GRADING, FILL, TREES, ETC.):</b>	<b>POOLS (INCLUDING EQUIPMENT):</b>
<b>ACCESSORY EQUIPMENT (GAS, A/C, VENTS, ETC.):</b>	<b>OTHER:</b>

<b>OFFICIAL USE ONLY:</b>	<b>HARC COMMISSION REVIEW</b>	<b>EXPIRES ON:</b>
MEETING DATE:	___ APPROVED ___ NOT APPROVED ___ DEFERRED FOR FUTURE CONSIDERATION	INITIAL:
MEETING DATE:	___ APPROVED ___ NOT APPROVED ___ DEFERRED FOR FUTURE CONSIDERATION	INITIAL:
MEETING DATE:	___ APPROVED ___ NOT APPROVED ___ DEFERRED FOR FUTURE CONSIDERATION	INITIAL:
REASONS OR CONDITIONS:		
STAFF REVIEW COMMENTS:		
FIRST READING FOR DEMO:	SECOND READING FOR DEMO:	
HARC STAFF SIGNATURE AND DATE:	HARC CHAIRPERSON SIGNATURE AND DATE:	

**THIS APPLICATION MAY BE REVIEWED BY PLANNING DEPARTMENT STAFF.**

# APPLICATION



# HARC Certificate of Appropriateness: Demolition Appendix



**City of Key West**

1300 WHITE STREET  
KEY WEST, FLORIDA 33040

HARC COA # <i>H. 2024.0015</i>	INITIAL & DATE
ZONING DISTRICT	BLDG PERMIT #

ADDRESS OF PROPOSED PROJECT:	1104 Margaret Street
PROPERTY OWNER'S NAME:	Craig Reynolds
APPLICANT NAME:	Pope - Scarbrough Architects

*I hereby certify I am the owner of record and that the work shall conform to all applicable laws of this jurisdiction. By receiving a Certificate of Appropriateness, I realize that this project will require a Building Permit approval **PRIOR to proceeding with the work outlined above** and that a final inspection is required under this application. I also understand that **any changes to an approved Certificate of Appropriateness must be submitted for review.***

PROPERTY OWNER'S SIGNATURE	<i>Craig Reynolds</i> <i>3/12/2024</i> DATE AND PRINT NAME
----------------------------	---

DETAILED PROJECT DESCRIPTION OF DEMOLITION
Demolition of existing non-historic porch.

CRITERIA FOR DEMOLITION OF CONTRIBUTING OR HISTORIC STRUCTURES:
<p><b>Before any Certificate of Appropriateness may be issued for a demolition request, the Historic Architectural Review Commission must find that the following requirements are met (please review and comment on each criterion that applies);</b></p>
<p>(1) If the subject of the application is a contributing or historic building or structure, then it should not be demolished unless its condition is irrevocably compromised by extreme deterioration or it does not meet any of the following criteria:</p>
<p style="padding-left: 40px;">(a) The existing condition of the building or structure is irrevocably compromised by extreme deterioration.</p>
<p style="padding-left: 40px;">No, however the structure is non-historic</p>
<p>(2) Or explain how the building or structure meets the criteria below:</p>
<p style="padding-left: 40px;">(a) Embodies no distinctive characteristics of a type, period, or method of construction of aesthetic or historic significance in the city and is not a significant and distinguishable building entity whose components may lack individual distinction.</p>
<p style="padding-left: 40px;">Structure is not significant</p>

Nothing in this application is intended to alter the authority of the Building Official to condemn for demolition dangerous buildings, as provided in Section 102-218 of the Land Development Regulations and Chapter 14 of the Code of Ordinances.

(b) Is not specifically associated with events that have made a significant contribution to local, state, or national history.

Structure is not significant

(c) Has no significant character, interest, or value as part fo the development, heritage, or cultural characteristics of the city, state or nation, and is not associated with the life of a person significant in the past.

Structure is not significant

(d) Is not the site of a historic event with significant effect upon society.

Structure is not significant

(e) Does not exemplify the cultural, political, economic, social, or historic heritage of the city.

Structure does not exemplify the cultural, political, economic, social or historic heritage of the city

(f) Does not portray the environment in an era of history characterized by a distinctive architectural style.

Correct

(g) If a part of or related to a square, park, or other distinctive area, nevertheless should not be developed or preserved according to a plan based on the area's historic, cultural, natural, or architectural motif.

NA

(h) Does not have a unique location or singular physical characteristic which represents an established and familiar visual feature of its neighborhood or of the city, and does not exemplify the best remaining architectural type in a neighborhood.

Nothing in this application is intended to alter the authority of the Building Official to condemn for demolition dangerous buildings, as provided in Section 102-218 of the Land Development Regulations and Chapter 14 of the Code of Ordinances.

(i) Has not yielded, and is not likely to yield, information important in history.
Correct

CRITERIA FOR DEMOLITION OF NON-CONTRIBUTING OR NON-HISTORIC STRUCTURES:
<b>The following criteria will also be reviewed by the Historic Architectural Review Commission for proposed demolitions. The Commission shall not issue a Certificate of Appropriateness that would result in the following conditions (please review and comment on each criterion that applies);</b>
(1) Removing buildings or structures that are important in defining the overall historic character of a district or neighborhood so that the character is diminished.
Removal will not cause diminished character
(2) Removing historic buildings or structures and thus destroying the historic relationship between buildings or structures and open space.
Removal will not have any impact on historic relationship between building or structures and open space
(3) Removing an historic building or structure in a complex; or removing a building facade; or removing a significant later addition that is important in defining the historic character of a site or the surrounding district or neighborhood.
Removal of structure will have no impact on the historic character of the site or the surrounding district or neighborhood
(4) Removing buildings or structures that would otherwise qualify as contributing.
NA

# SANBORN MAPS



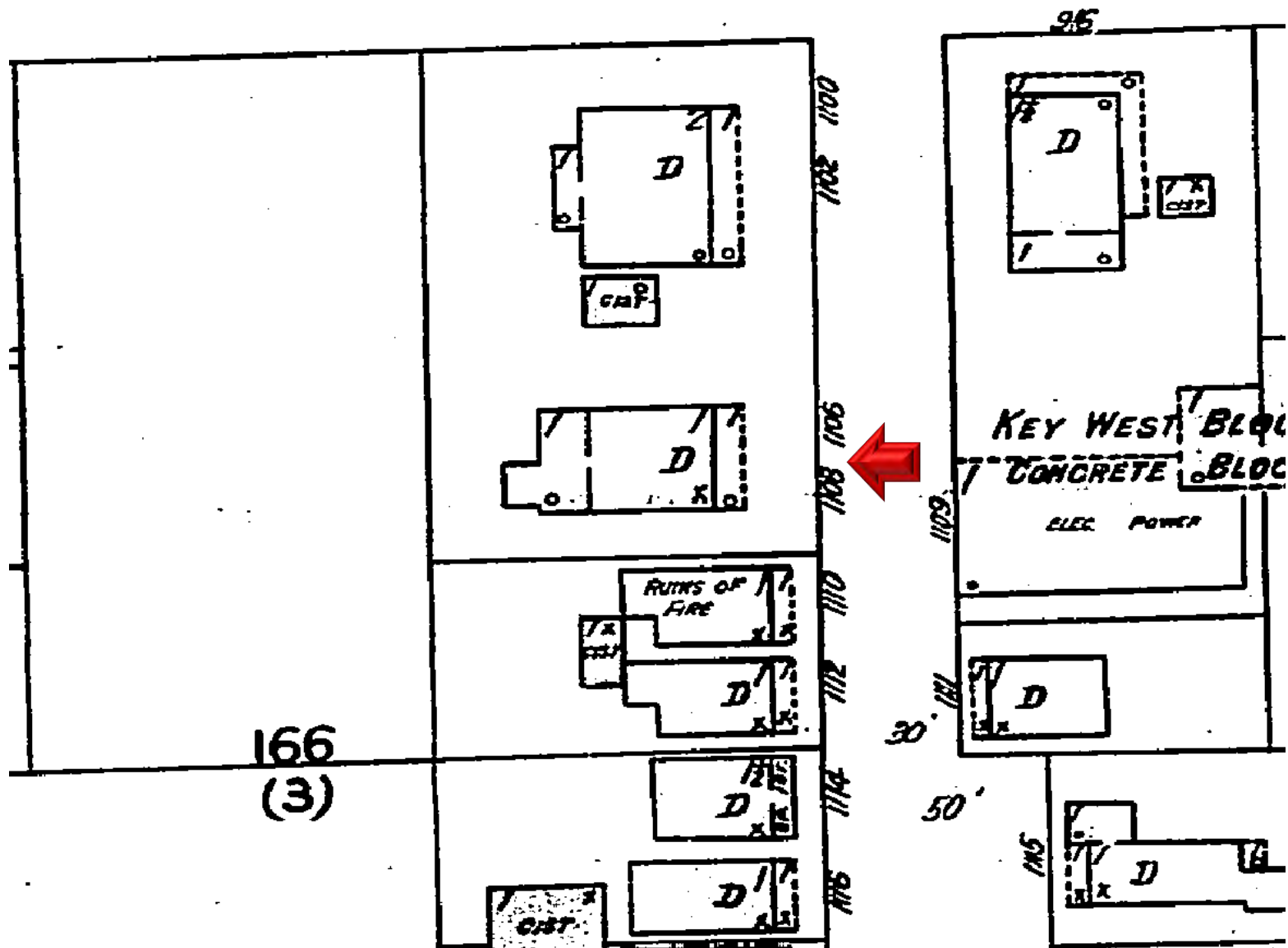

1926 Sanborn Map

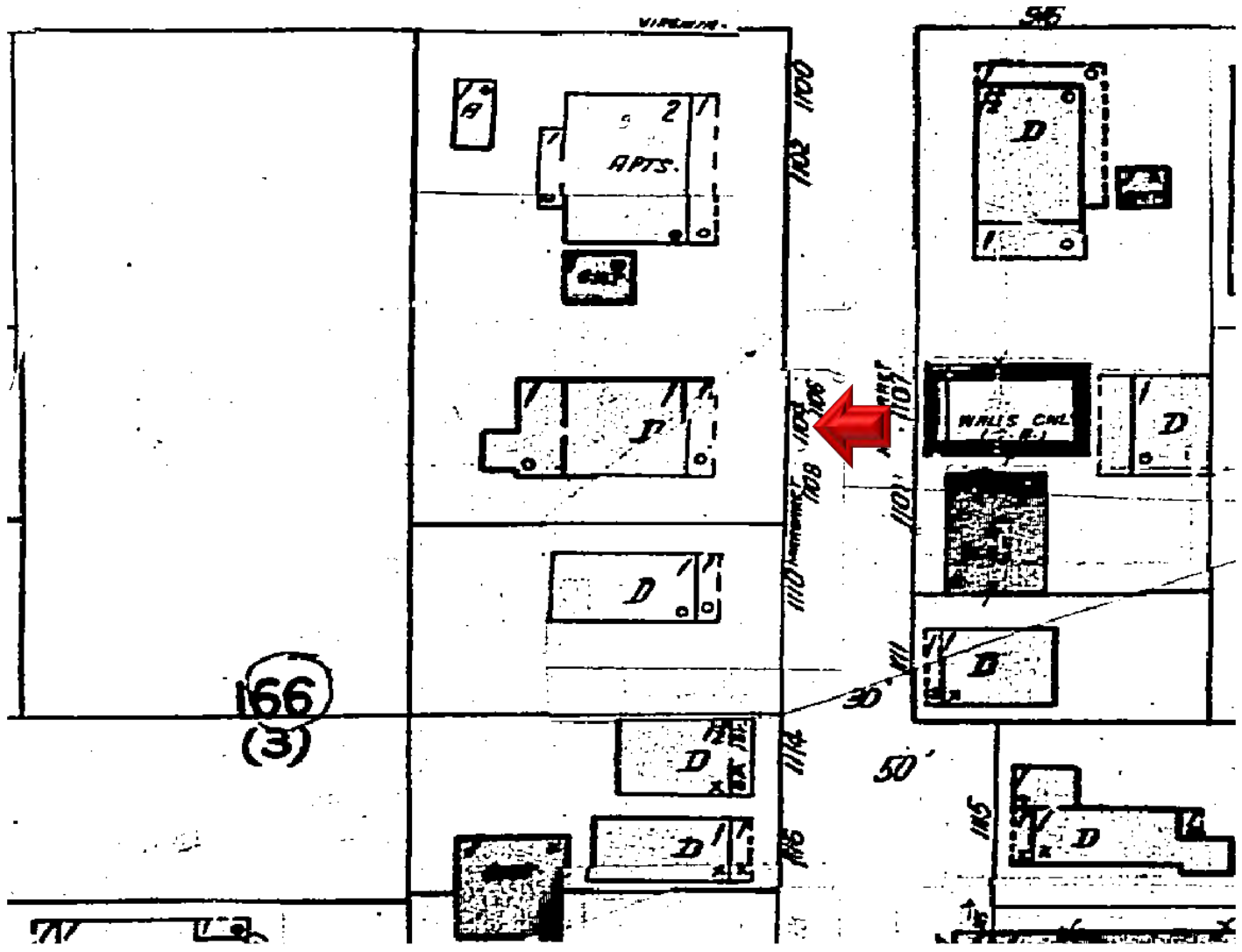

1948 Sanborn Map

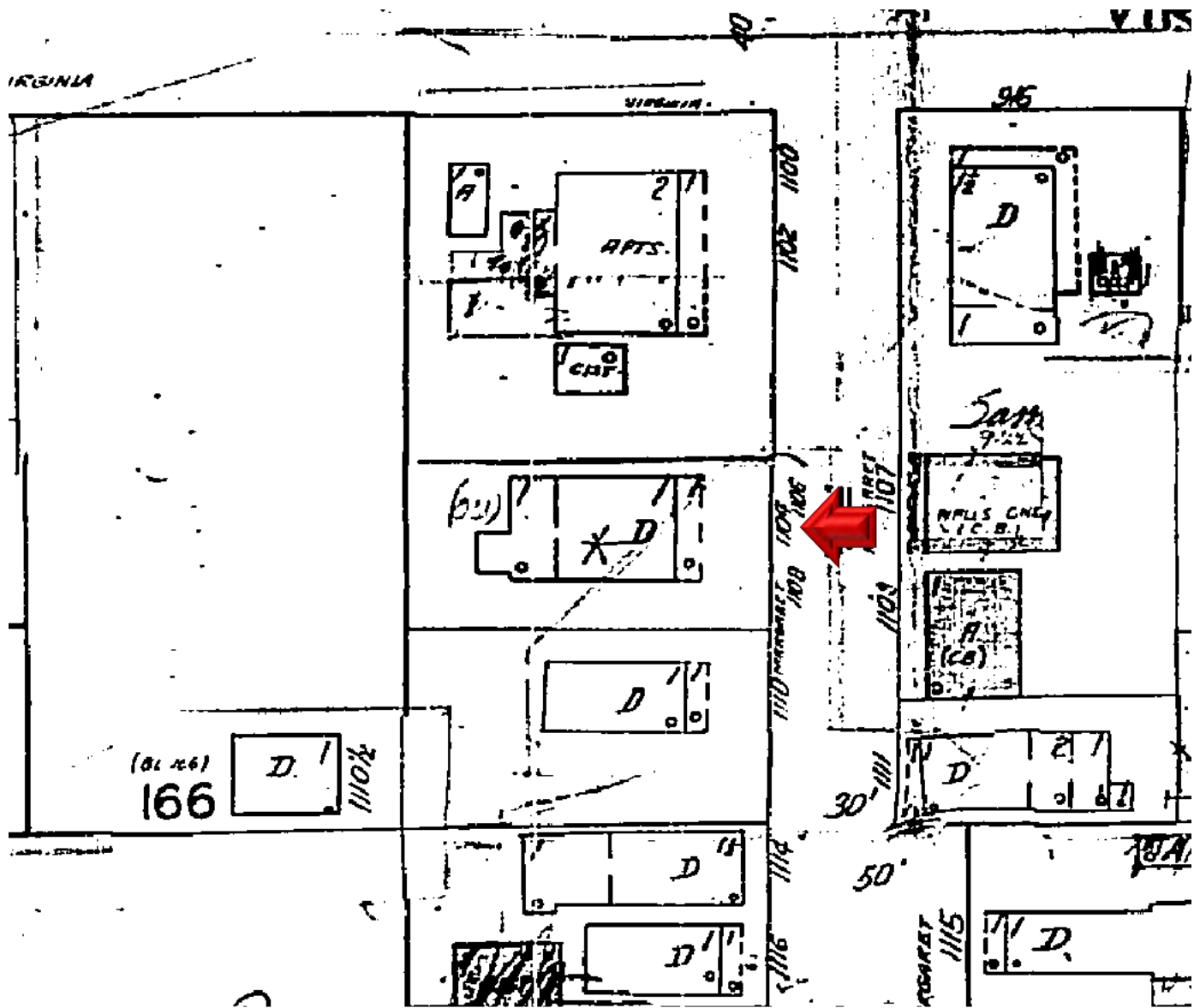

1962 Sanborn Map

# PROJECT PHOTOS





**1104 Margaret Street circa 1965. Monroe County Library.**

# 1104 Margaret



Façade / Street View





Photo of location of Accessory Structure





# 1100 Margaret Street



## Neighboring House



# 1112 Margaret Street



## Neighboring House

# 1103 Margaret Street



Across Street on Margaret



# 1109 Margaret Street



Across Street on Margaret

# SURVEY



# MAP OF BOUNDARY SURVEY

BEARING BASE:  
ALL BEARINGS ARE BASED  
ON S31°38'32"E ASSUMED  
ALONG THE CENTERLINE OF  
MARGARET STREET.

ALL ANGLES DEPICTED  
ARE 90 DEGREES UNLESS  
OTHERWISE INDICATED

ALL UNITS ARE SHOWN IN  
U.S. SURVEY FEET

ADDRESS:  
1104 MARGARET STREET #  
1112 MARGARET STREET REAR  
KEY WEST, FL 33040

COMMUNITY NO.: 120168  
MAP NO.: 12087C-1516K  
MAP DATE: 02-18-2005  
FLOOD ZONE: X-SHADED  
BASE ELEVATION: N/A

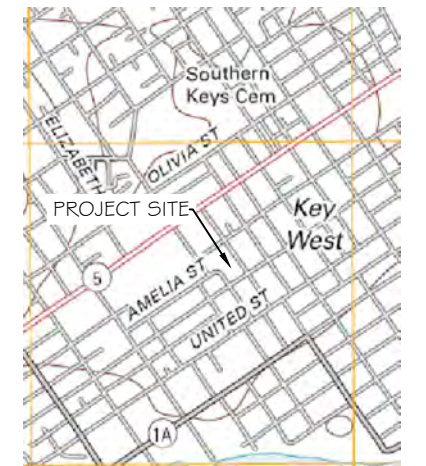

LOCATION MAP - NTS  
SEC. 05-T685-R25E

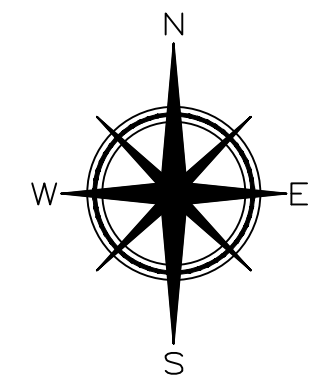

ASSUMED

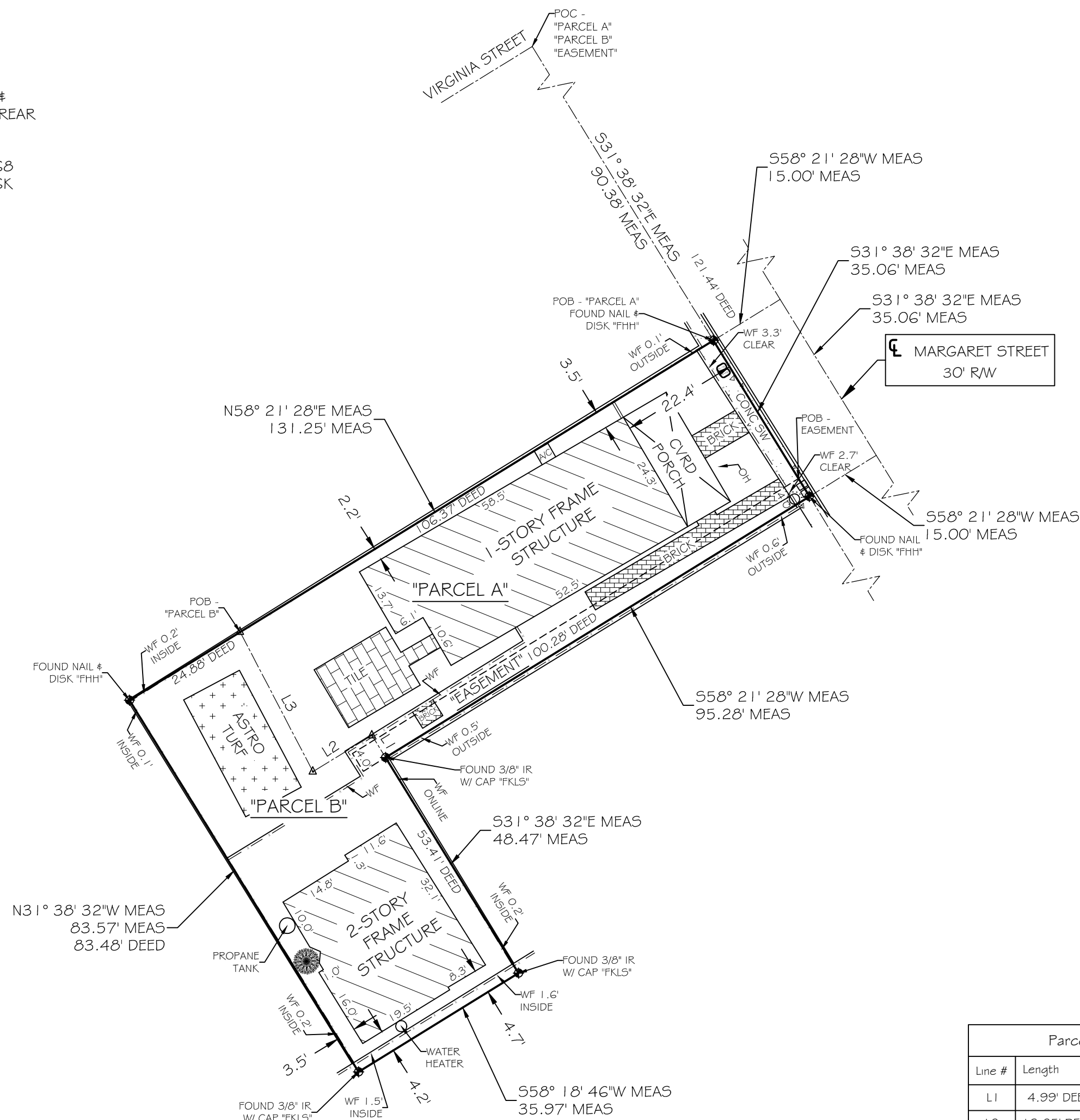

Parcel Line Table		
Line #	Length	Direction
L1	4.99' DEED	N31° 38' 32"W MEAS
L2	13.25' DEED	S58° 21' 28"W MEAS
L3	30.15' DEED	N27° 32' 22"W MEAS

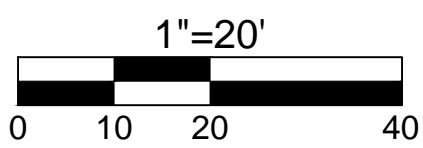

"PARCEL A" AREA = 3,706.81 SQFT±

"PARCEL B" AREA = 2,639.33 SQFT±

TOTAL AREA = 6,346.14 SQFT±

### SYMBOL LEGEND:

- - WATER METER
  - - SANITARY SEWER CLEAN OUT
  - - MAILBOX
  - ⊙ - WOOD POWER POLE
  - ⊠ - CONCRETE POWER POLE
  - - 8" WOOD PYLON
  - ⊗ - TREE (UNKNOWN SPECIES)
- NOTE: FOUNDATIONS BENEATH THE SURFACE ARE NOT SHOWN. MEASURED DIMENSIONS EQUAL PLATTED OR DESCRIBED DIMENSIONS UNLESS INDICATED OTHERWISE. THE FOLLOWING IS A LIST OF ABBREVIATIONS THAT MAY BE FOUND ON THIS SHEET.
- |                                   |  |                                      |
|-----------------------------------|--|--------------------------------------|
| BFP = BACK-FLOW PREVENTER         | GLY = GUY WIRE                                 | POC = POINT OF COMMENCEMENT          |
| BO = BLOW OUT                     | HB = HOSE BIB                                  | PRC = POINT OF REVERSE CURVE         |
| C & G = 2" CONCRETE CURB & GUTTER | IP = IRON PIPE                                 | PRM = PERMANENT REFERENCE MONUMENT   |
| CB = CONCRETE BLOCK               | IR = IRON ROD                                  | PT = POINT OF TANGENT                |
| CBW = CONCRETE BLOCK WALL         | L = ARC LENGTH                                 | R = RADIUS                           |
| CL = CENTERLINE                   | LS = LANDSCAPING                               | RW = RIGHT OF WAY LINE               |
| CU = CHAINLINK FENCE              | MB = MAILBOX                                   | SSCO = SANITARY SEWER CLEAN-OUT      |
| CM = CONCRETE MONUMENT            | MEAS = MEASURED                                | TS = TEMPORARY BENCHMARK             |
| CONC = CONCRETE                   | MF = METAL FENCE                               | TOS = TOP OF BANK                    |
| COP = CONCRETE POWER POLE         | MHWL = MEAN HIGH WATER LINE (SEE NOTE)         | TOE = TOE OF SLOPE                   |
| COV = COVERED                     | NGVD = NATIONAL GEODETIC VERTICAL DATUM (1929) | TS = TRAFFIC SIGN                    |
| DELTA = CENTRAL ANGLE             | NTS = NOT TO SCALE                             | TYP = TYPICAL                        |
| DEASE = DRAINAGE EASEMENT         | OH = ROOF OVERHANG                             | UR = UNREADABLE                      |
| EL = ELEVATION                    | OHV = OVERHEAD WIRES                           | UE = UTILITY EASEMENT                |
| ENCL = ENCLOSURE                  | PC = POINT OF CURVE                            | WD = WOOD DECK                       |
| EP = EDGE OF PAVEMENT             | PF = FINISHED FLOOR ELEVATION                  | WF = WOOD FENCE                      |
| FF = FINISHED FLOOR ELEVATION     | PK = PARKING METER                             | WL = WOOD LANDING                    |
| FI = FIRE HYDRANT                 | PCP = POINT OF COMPOUND CURVE                  | WM = WATER METER                     |
| FI = FENCE INSIDE                 | PCF = PERMANENT CONTROL POINT                  | WPP = WOOD POWER POLE                |
| FND = FOUND                       | PK = PARKER KALIN NAIL                         | WRACK LINE = LINE OF DEBRIS ON SHORE |
| FO = FENCE OUTSIDE                | POB = POINT OF BEGINNING                       | WV = WATER VALVE                     |
| FOL = FENCE ON LINE               | PI = POINT OF INTERSECTION                     |                                      |

### LEGAL DESCRIPTION -

"PARCEL A"  
In the City of Key West and is part of Tract 12, according to the map or plan of said City delineated by William A. Whitehead in February, A.D. 1829; Commence at the intersection of the Southwesterly right of way line of Virginia Street, and run thence Southeasterly on Margaret Street for a distance of 90.38 feet; thence at right angles in a Southwesterly direction for a distance of 35.06 feet; thence at right angles in a Southwesterly direction for a distance of 4.99 feet; thence at right angles in a Southwesterly direction for a distance of 13.25 feet; thence along a line deflected 94° 06' 10" to the right for a distance of 30.15 feet; thence along a line deflected 85° 53' 50" to the right for a distance of 106.37 feet back to the Point of Beginning.

"PARCEL B"  
In the City of Key West and is part of Tract 12 according to the map or plan of the said City delineated by William A. Whitehead in February, A.D. 1829; Commence at the intersection of the Southwesterly right-of-way line of Margaret Street with the Southeasterly right-of-way line of Virginia Street, and run thence Southeasterly on Margaret Street for a distance of 90.38 feet; thence at right angles in a Southwesterly direction for a distance of 106.37 feet to the Point of Beginning; thence along a line deflected 85° 53' 50" to the left for a distance of 30.15 feet; thence along a line deflected 94° 06' 10" to the left for a distance of 13.25 feet; thence at right angles in a Southeasterly direction for a distance of 53.41 feet; thence at right angles in a Southwesterly direction for a distance of 35.97 feet; thence at right angles in a Northwesterly direction for a distance of 83.48 feet; thence at right angles in a Northeasterly direction for a distance of 24.88 feet back to the Point of Beginning.

"EASEMENT"  
Together With an easement for ingress and egress as hereinafter described: In the City of Key West and is part of Tract 12 according to the map or plan of the said City delineated by William A. Whitehead in February, A.D. 1829; Commencing at the intersection of the Southwesterly right-of-way line of Virginia Street, and run thence Southeasterly on Margaret Street 121.44 feet for a Point of Beginning; thence along Margaret Street in a Southwesterly direction 4 feet; thence at right angles in a Southwesterly direction 4 feet; thence at right angles in a Northeasterly direction 100.28 feet on the Point of Beginning on Margaret Street.

CERTIFIED TO -

Craig C. Reynolds & Marjorie H. Booton;

NOTE: LEGAL DESCRIPTIONS HAVE BEEN FURNISHED BY THE CLIENT OR HIS/HER REPRESENTATIVE. ADDITIONS OR DELETIONS TO SURVEY MAP OR REPORT BY OTHER THAN THE SIGNING PARTY IS PROHIBITED WITHOUT WRITTEN CONSENT OF THE SIGNING PARTY. THE BOLD LINE SHOWN HEREON REPRESENTS THE SURVEYOR'S OPINION OF THE DEED LINES. THE MEAN HIGH WATER LINE AS SHOWN ON THIS SURVEY MAP WAS IDENTIFIED IN THE FIELD BY PHYSICAL EVIDENCE ON SITE SUCH AS DISCOLORATION, VEGETATION INDICATORS OR WRACK LINES. THIS IS NOT A TIDAL WATER SURVEY AND DOES NOT COMPLY WITH CHAPTER 177, PART II, FLORIDA STATUTES. THE SAID MEAN HIGH WATER LINE IS SHOWN FOR REFERENCE ONLY.

SCALE: 1"=20'  
FIELD WORK DATE: 03/04/2024  
MAP DATE: 03/05/2024  
REVISION DATE: XXXXXXXX  
SHEET: 1 OF 1  
DRAWN BY: MPB  
JOB NO.: 24-051

I HEREBY CERTIFY THAT THIS SURVEY WAS MADE UNDER MY RESPONSIBLE CHARGE AND MEETS THE STANDARDS OF PRACTICE AS SET FORTH BY THE FLORIDA BOARD OF PROFESSIONAL SURVEYORS AND MAPPERS IN CHAPTERS 2014-147 & 5J-17.05, FLORIDA ADMINISTRATIVE CODE, PURSUANT TO SECTION 472.027, FLORIDA STATUTES.

NOT VALID WITHOUT THE SIGNATURE AND THE RAISED SEAL OF A FLORIDA SURVEYOR AND MAPPER

SIGNED: ERIC A. ISAAC, FLSM #6783, PROFESSIONAL SURVEYOR AND MAPPER, LB# 7847



FLORIDA KEYS  
LAND SURVEYING  
21460 OVERSEAS HWY, SUITE 4  
CUDJOE KEY, FL 33042  
PHONE: (305) 394-3690  
EMAIL: FKLSEmail@Gmail.com

# PROPOSED DESIGN



# UNIT 1 - 1104 MARGARET STREET - KEY WEST

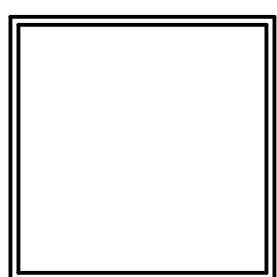

Reynolds Residence  
1104 Margaret St. Key West, FL

POPE-SCARBROUGH-ARCHITECTS  
THOMAS E. POPE, P.A.  
(305) 296 3611 610 White St, Key West FL

date:  
03/05/24  
revision:

sheet:  
A0.0

**SITE DATA & STORMWATER CALCS.**

**SITE DATA:**  
 PROPERTY ADDRESS: 1104 MARGARET STREET UNIT 1  
 ZONE: HMDR  
 FLOOD ZONE: "X"  
 STATUS: NON-CONTRIBUTING, BUILT NEW 1986 PDST FIRE-DESTRUCTION

**LOT AREA:** 4,105 FT<sup>2</sup>

**IMPERVIOUS SURFACE AREA:**

ALLOWED (MAXIMUM):	EXISTING	PROPOSED
OPEN SPACE 35% (1,437 FT <sup>2</sup> )	53.3% (2,188 FT <sup>2</sup> )	51.4% (2,110 FT <sup>2</sup> )
BUILDING COVERAGE 40% (1,642 FT <sup>2</sup> ) (HOUSE & PORCH)	38.1% (1,563 FT <sup>2</sup> )	40.0% (1,642 FT <sup>2</sup> )
IMPERVIOUS SURFACE 60% (2,463 FT <sup>2</sup> )	8.6% (354 FT <sup>2</sup> )	48.6% (1,995 FT <sup>2</sup> )

**STORMWATER RETENTION CALCULATIONS:**

LOT AREA: (4,105 FT<sup>2</sup>)  
 NEW IMPERVIOUS AREA: 1.9% (76 FT<sup>2</sup>)  
 NEW SHED (11.5' x 16' = 184 FT<sup>2</sup>) - REDUCTION OF PORCH (108 FT<sup>2</sup>)  
 RAINFALL: (1")

**CUBIC FEET REQUIRED** ((IMPERVIOUS AREA X RAINFALL)/12): (6.33 FT<sup>3</sup>)

**CUBIC FEET SUPPLIED** (S.F. RETENTION X AVG. DEPTH IN FEET): (8 FT<sup>3</sup>)

GROSS SQUARE FEET OF RETENTION AREA: (16 FT<sup>2</sup>)  
 AVERAGE DEPTH OF RETENTION AREA: (6")

MEETS REQUIREMENT  
 MEETS REQUIREMENT  
 MEETS REQUIREMENT

**SCOPE OF WORK**

- REDUCE SIZE OF FRONT PORCH TO ALLOW S.F. FOR NEW SHED
- NEW 1 STORY SHED

**NOTE:** CONTRACTOR TO CONFIRM ALL JURISDICTIONAL APPROVALS ARE IN PLACE BEFORE PROCEEDING WITH ANY PROPOSED SITE WORK, DEMOLITION, ETC. **NO EXCEPTIONS.**

**ENGINEERING NOTE:**

THIS DRAWING SET DOES **NOT** INCLUDE ALL STRUCTURAL INFORMATION - SOLICIT ANY NECESSARY ENGINEERING FROM A LICENSED AND QUALIFIED STRUCTURAL ENGINEER THAT IS FAMILIAR WITH THE EXISTING CONDITIONS UNIQUE TO THIS SITE.

**LANDSCAPE ARCHITECT TO REVIEW AND APPROVE ALL ENGINEERING DETAILS PRIOR TO IMPLEMENTATION TO ENSURE CONSISTENCY WITH THE FIT AND FINISHES OUTLINED WITHIN THIS DRAWING SET. NO EXCEPTIONS.**

**ABBREVIATIONS**

A.E.G. ABOVE EXISTING GRADE  
 APPX. APPROXIMATELY  
 C.L. CENTER LINE  
 CONC. CONCRETE  
 ELEV. ELEVATION  
 EQ. EQUAL  
 F.F.E. FINISH FLOOR ELEV.  
 H.P. HIGH POINT  
 H.T. HEIGHT  
 L.A. LANDSCAPE ARCHITECT  
 L.P. LOW POINT  
 MAX. MAXIMUM  
 MIN. MINIMUM  
 D.C. ON CENTER  
 P.L. PROPERTY LINE  
 P.T. PRESSURE TREATED  
 SPEC. TYPICAL  
 TYP. TYPICAL  
 W.W.M. WELDED WIRE MESH

DRAWING LIST	DATE
A0.1 PROPOSED SITE PLAN.....	03-05-24
A0.2 GOOGLE EARTH CONTEXT.....	03-05-24
A1.1 PORCH PLANS AND ELEVATIONS.....	03-05-24
A1.2 ACCESSORY STRUCTURE PLANS & ELEVATIONS.....	03-05-24
A2.1 SITE SECTIONS.....	03-05-24

THE DRAWINGS, SPECIFICATIONS, AND OTHER DOCUMENTS PREPARED BY THE LANDSCAPE ARCHITECT ARE INSTRUMENTS OF THE LANDSCAPE ARCHITECT'S SERVICE AND ARE COPYRIGHT © 2024, CRAIG REYNOLDS, INC., DBA, CRAIG REYNOLDS LANDSCAPE ARCHITECTURE.

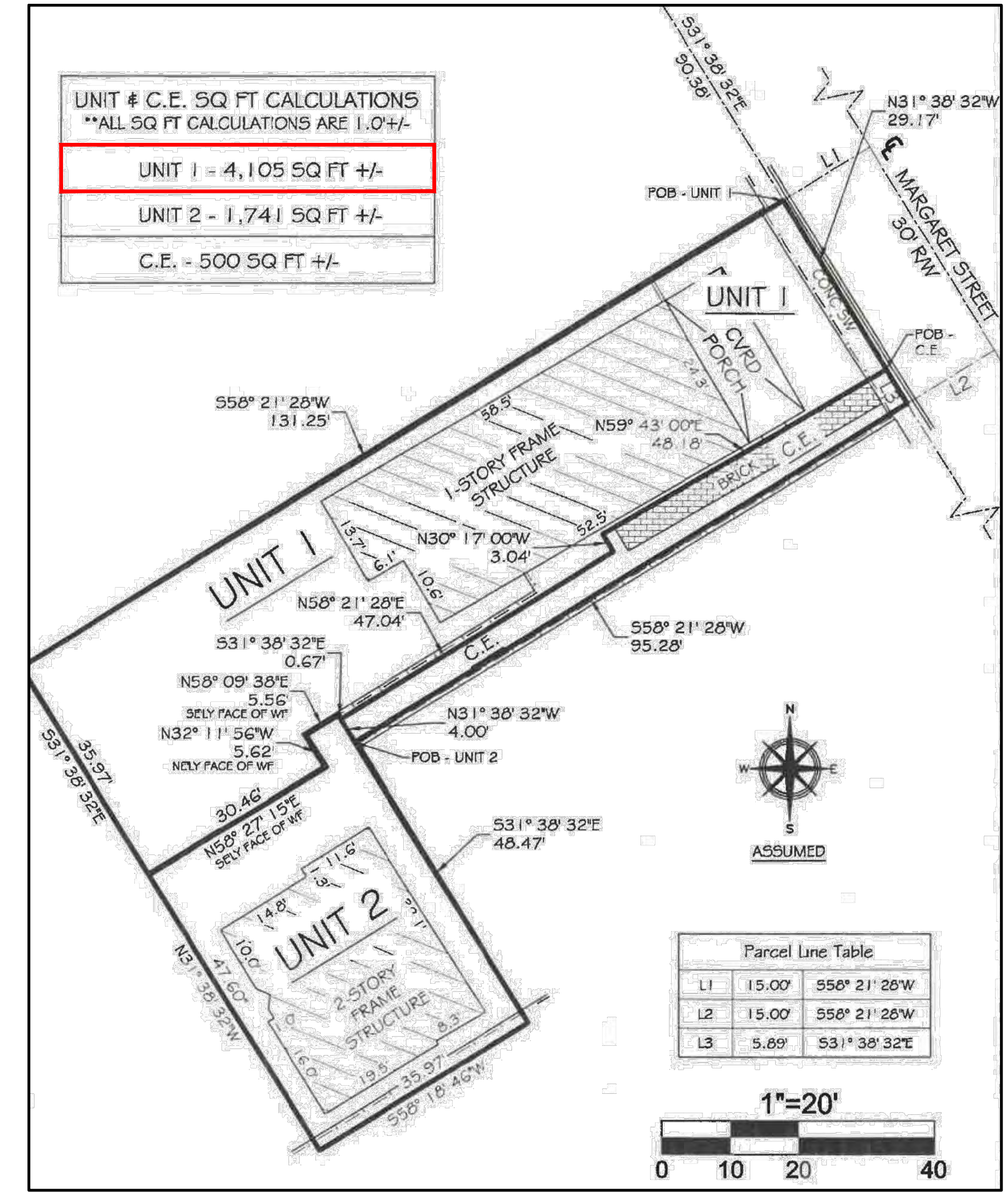



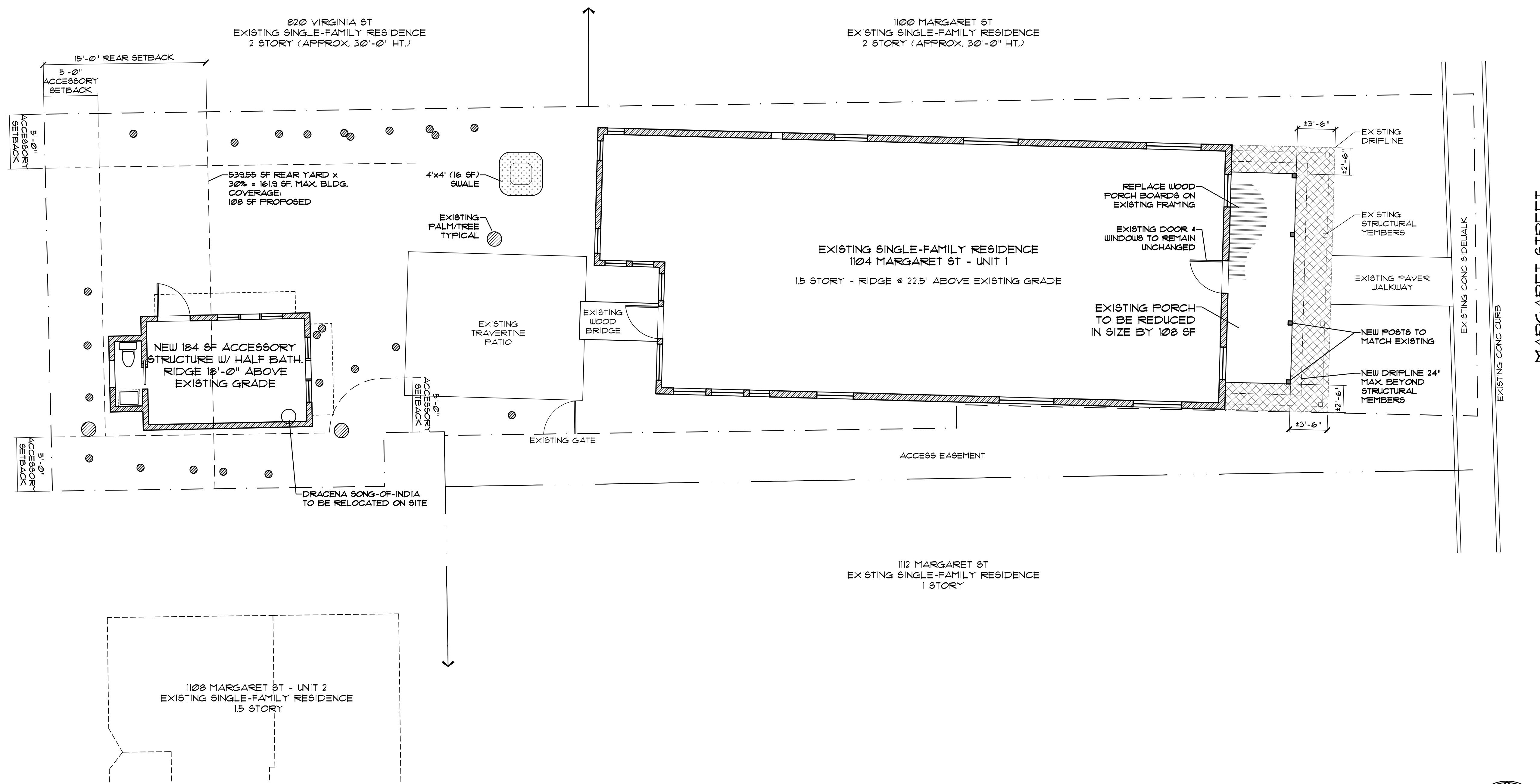

Proposed Site Plan

3/16" = 1' - 0"

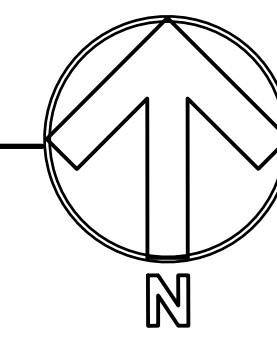

Reynolds Residence  
1104 Margaret St. Key West, FL

POPE-SCARBROUGH-ARCHITECTS  
THOMAS E. POPE, P.A.  
(305) 296 3611 610 White St, Key West FL

date:  
03/05/24  
revision:

sheet:  
A0.1





Google Earth Site Context

NTS

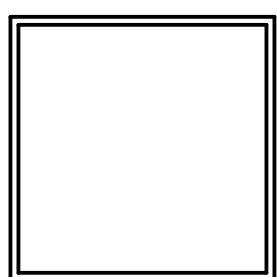

Reynolds Residence  
1104 Margaret St. Key West, FL

POPE-SCARBROUGH-ARCHITECTS  
THOMAS E. POPE, P.A.  
(305) 296 3611 610 White St, Key West FL

date:  
03/05/24  
revision:

sheet:  
A0.2



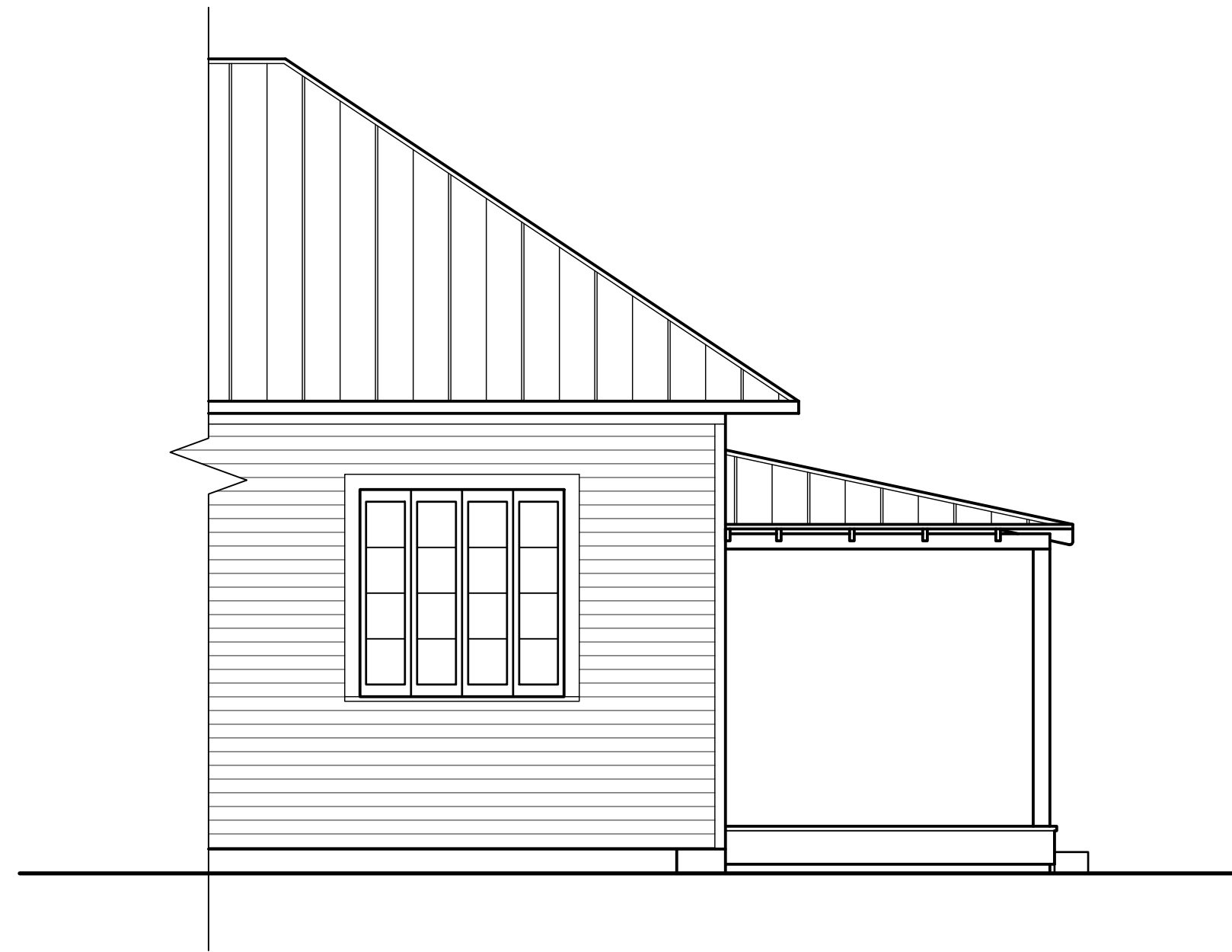

**Existing Porch Elevation**

1/4" = 1' - 0"



**Existing Porch Elevation**

1/4" = 1' - 0"

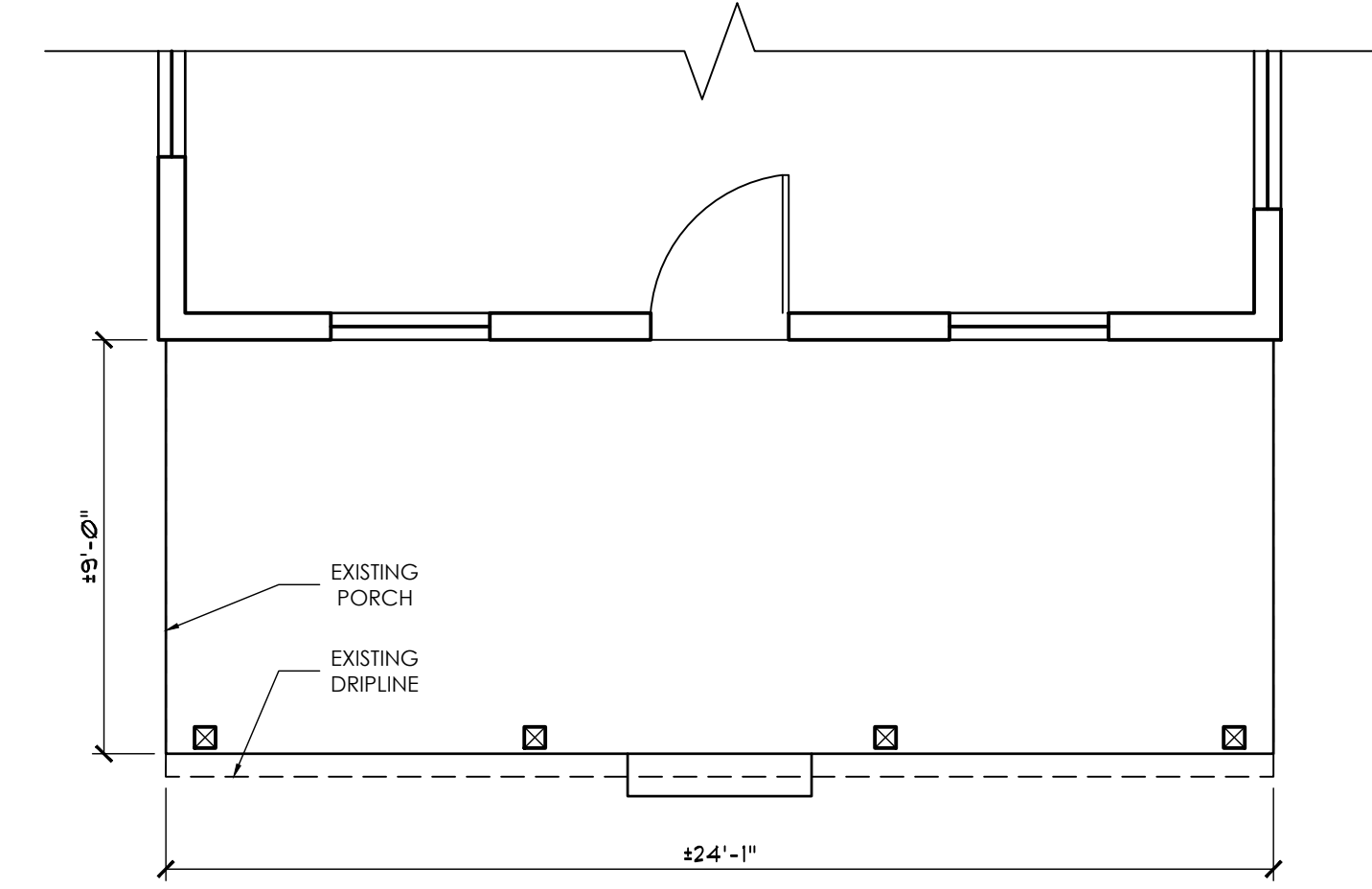

**Existing Porch Plan**

1/4" = 1' - 0"

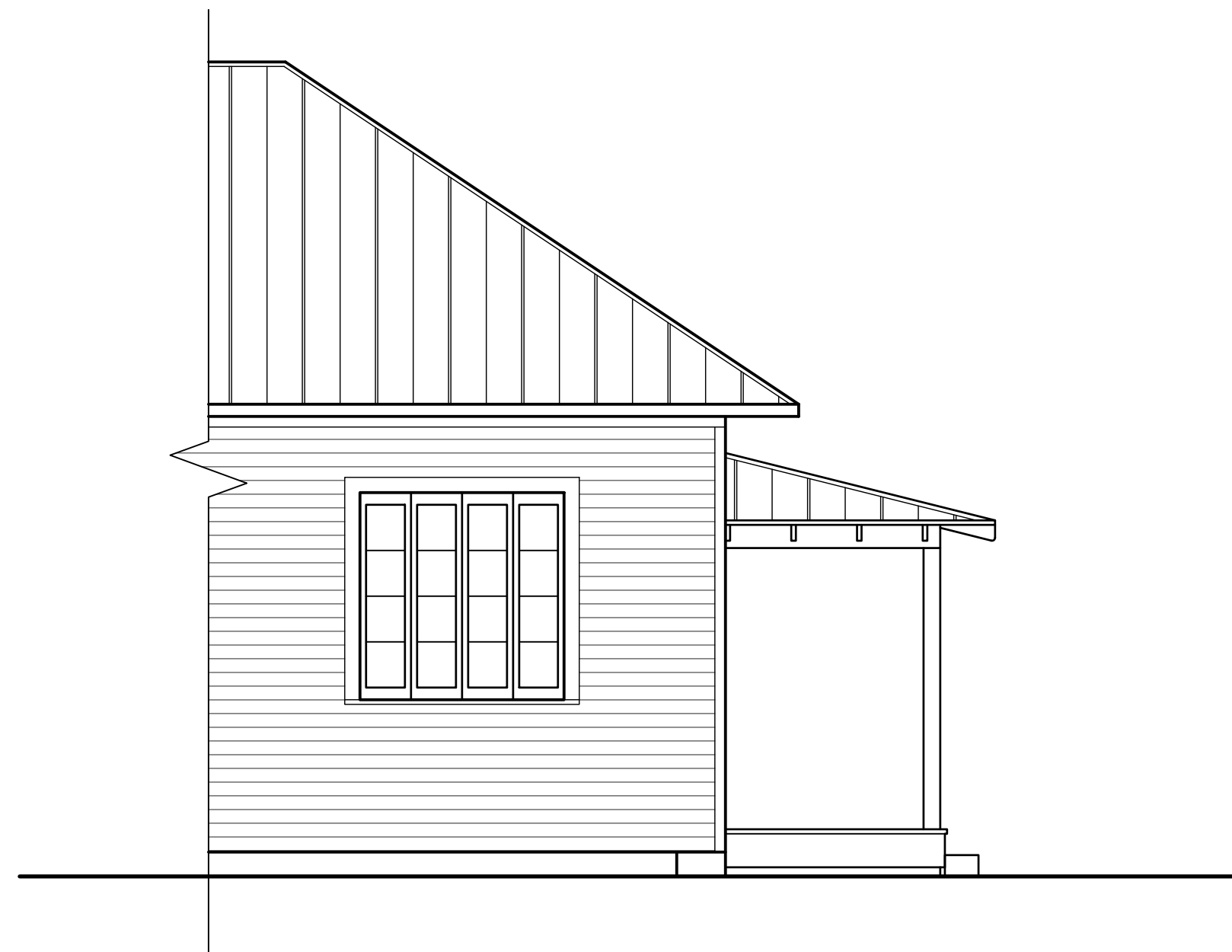

**Proposed Porch Elevation**

1/4" = 1' - 0"



**Proposed Porch Elevation**

1/4" = 1' - 0"

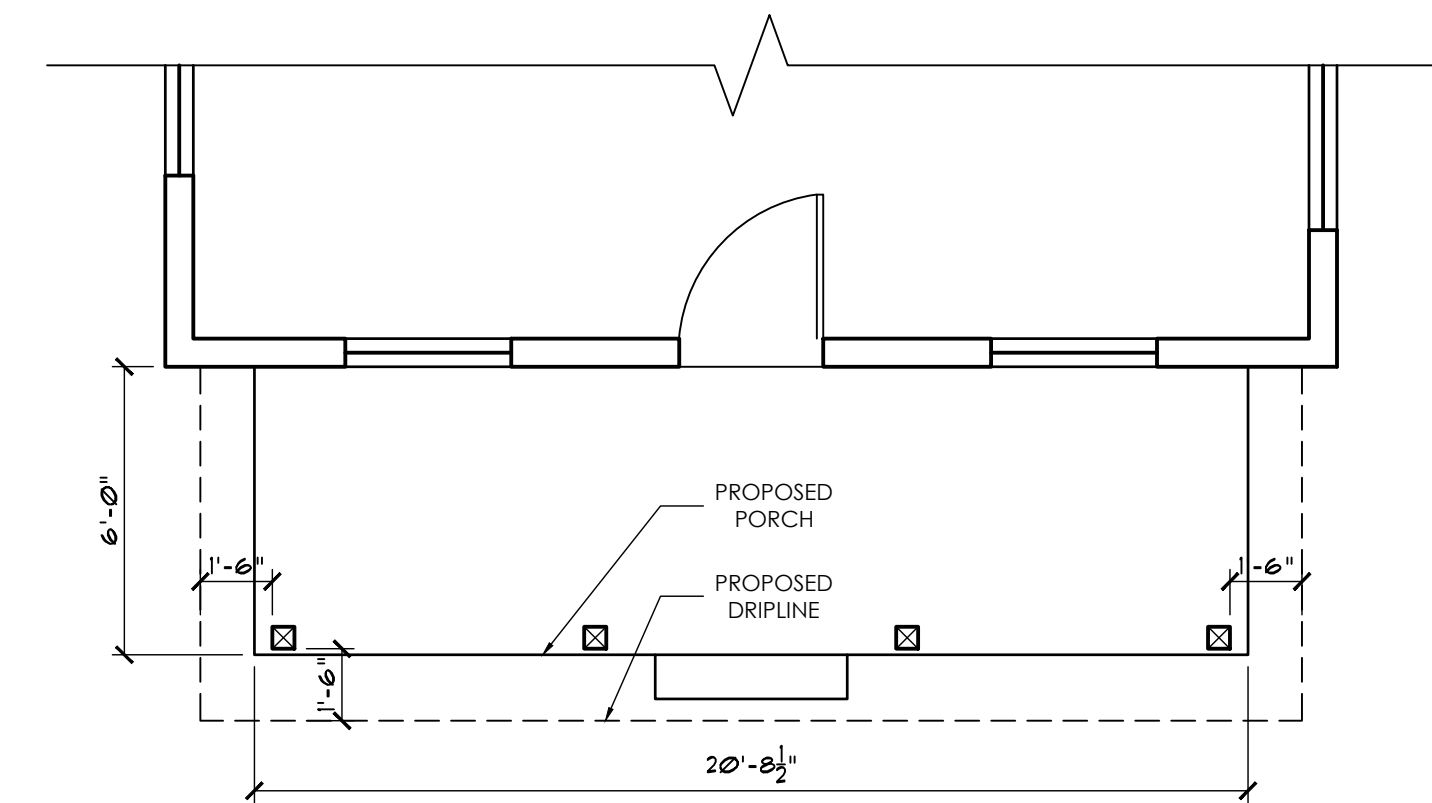

**Proposed Porch Plan**

1/4" = 1' - 0"

Reynolds Residence  
1104 Margaret St. Key West, FL.

POPE-SCARBROUGH-ARCHITECTS  
THOMAS E. POPE, P.A.  
(305) 296 3611 610 White St. Key West FL

date:  
03/05/24  
revision:

sheet:  
A1.1

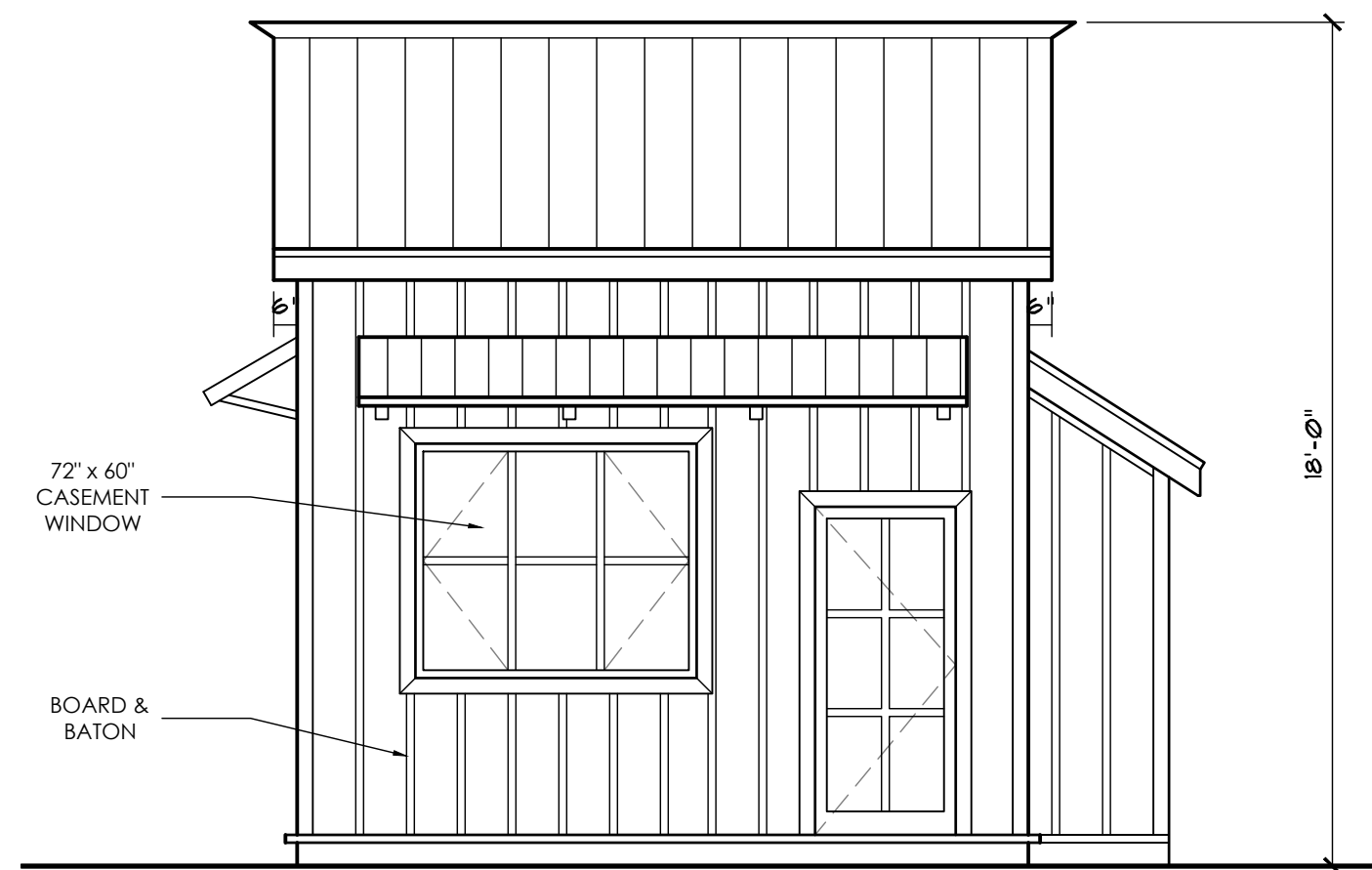

**Proposed Elevation B**

1/4" = 1' - 0"

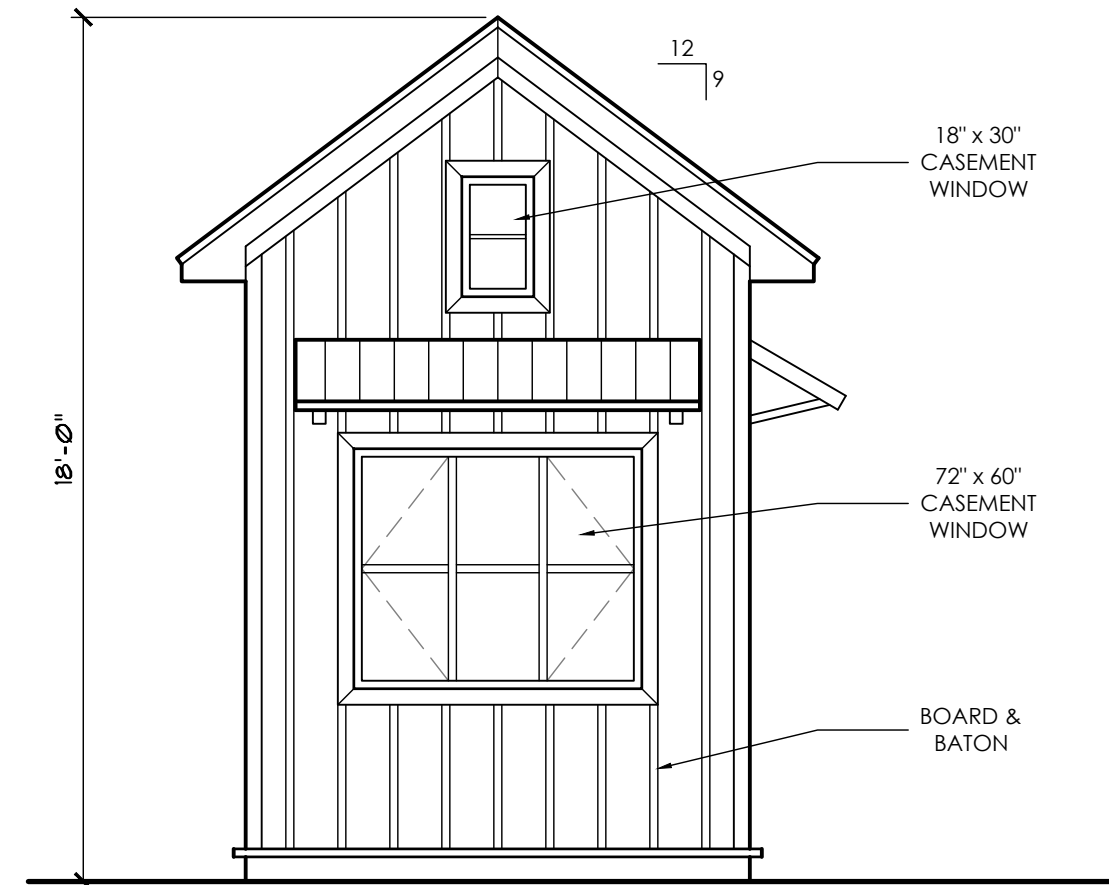

**Proposed Elevation A**

1/4" = 1' - 0"

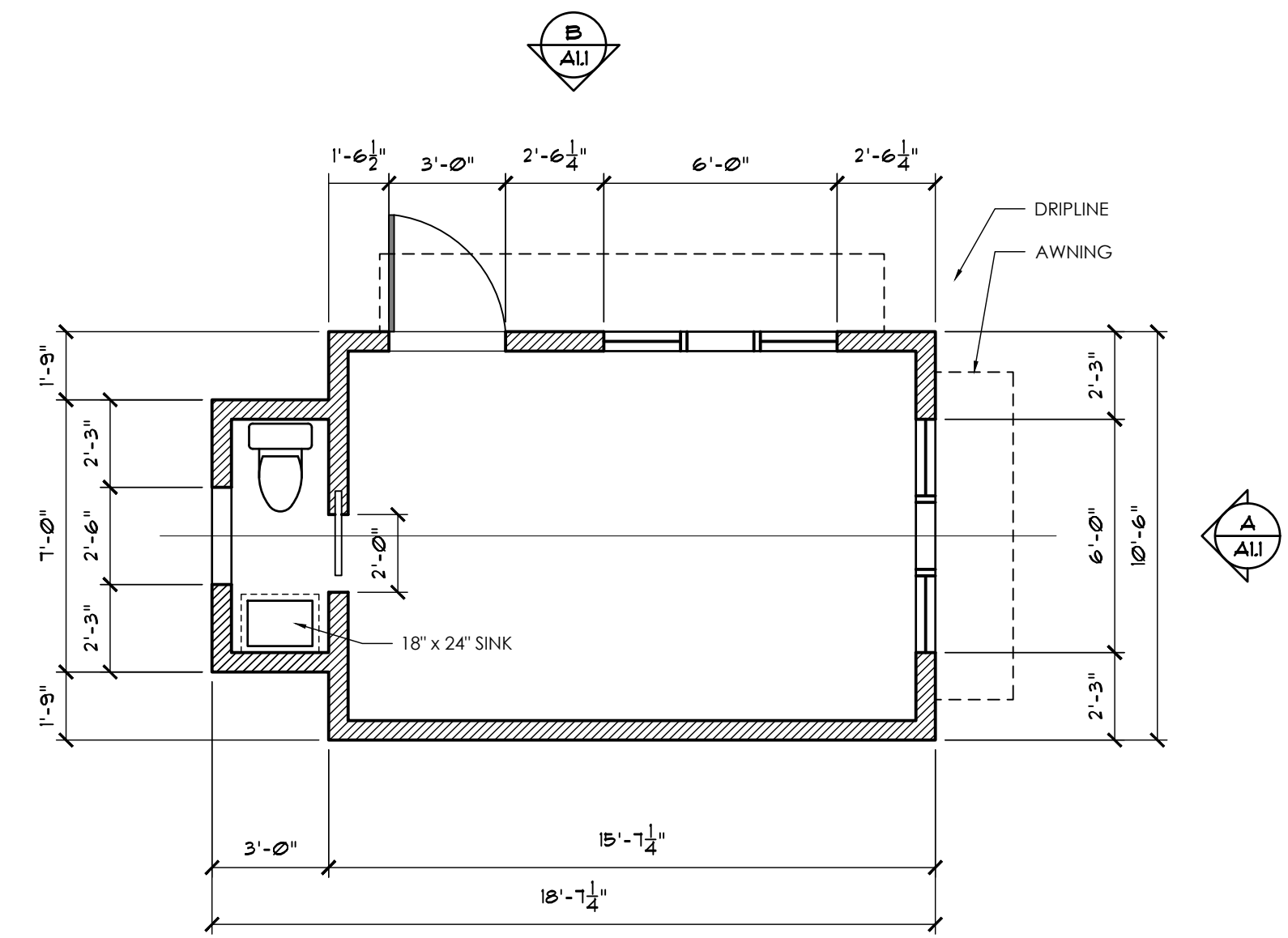

**Proposed Floor Plan**

1/4" = 1' - 0"

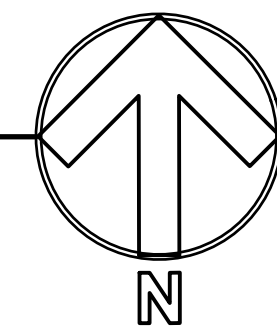

POPE-SCARBROUGH-ARCHITECTS  
THOMAS E. POPE, P.A.

(305) 296 3611 610 White St, Key West FL

date:  
03/05/24  
revision:

sheet:

A1.2

Reynolds Residence

1104 Margaret St. Key West, FL

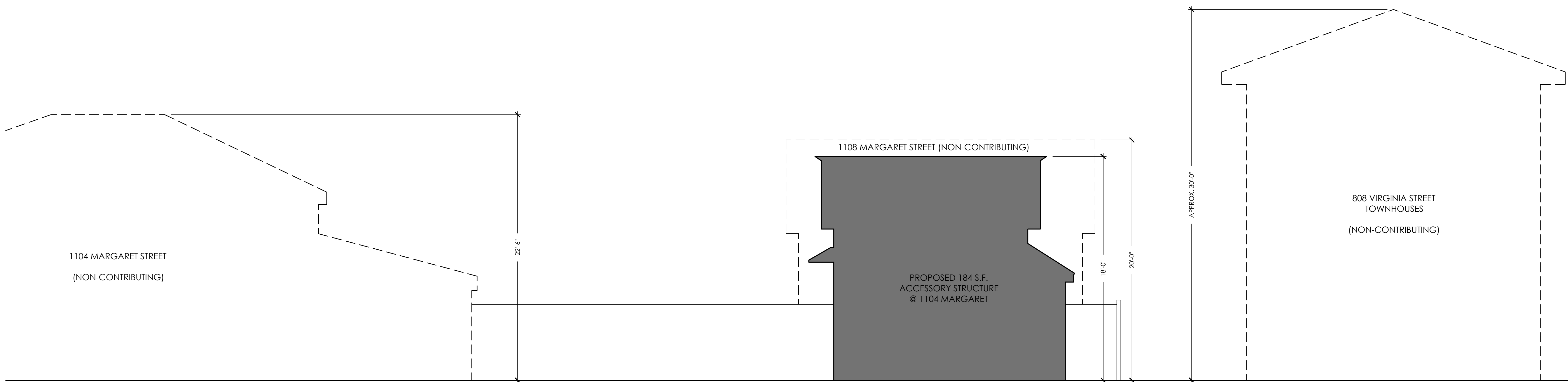
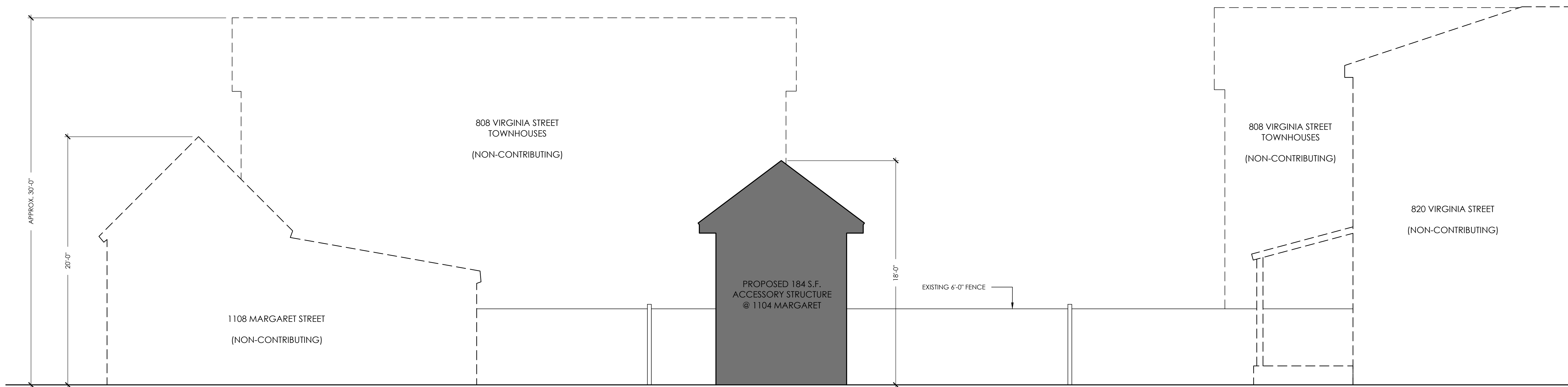

**Site Sections**

1/4" = 1' - 0"

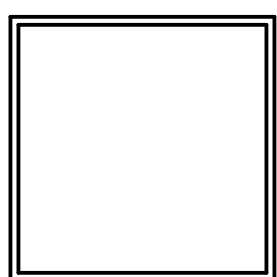

**Reynolds Residence**  
1104 Margaret St. Key West, FL

**POPE-SCARBROUGH-ARCHITECTS**  
THOMAS E. POPE, P.A.  
(305) 296 3611 610 White St, Key West FL

date:  
03/05/24  
revision:

sheet:  
**A2.1**

# NOTICING

# Public Meeting Notice

The Historic Architectural Review Commission will hold a public meeting at **5:00 p.m., April 23, 2024, at City Hall, 1300 White Street**, Key West, Florida. In order to view the live feed of the meeting, you can tune in to Comcast channel 77, AT&T Uverse channel 99. If you wish to participate virtually, please contact HARC staff at 305-809-3975. The purpose of the hearing will be to consider a request for:

**NEW FRONT PORCH ON PRINCIPAL HOUSE. NEW ACCESSORY STRUCTURE AT REAR OF MAIN HOUSE. DEMOLITION OF NON-HISTORIC FRONT PORCH ON PRINCIPAL HOUSE.**

**#1104 MARGARET STREET**

**Applicant – Pope-Scarborough Architects    Application #H2024-0015**

If you wish to see the application or have any questions, you may visit the Planning Department during regular office hours at 1300 White Street, call 305-809-3973 or visit our website at [www.cityofkeywest-fl.gov](http://www.cityofkeywest-fl.gov).

**THIS NOTICE CAN NOT BE REMOVED FROM THE SITE UNTIL HARC FINAL DETERMINATION**

ADA ASSISTANCE: It is the policy of the City of Key West to comply with all requirements of the Americans with Disabilities Act (ADA). Please call the TTY number at 800-955-8771 or 800-955-8770 (Voice) or the ADA Coordinator at 305-809-3811 at least five business days in advance for sign language interpreters, assistive listening devices, or materials in accessible format.



# PROPERTY APPRAISER INFORMATION

# Monroe County, FL

## Disclaimer

The Monroe County Property Appraiser's office maintains data on property within the County solely for the purpose of fulfilling its responsibility to secure a just valuation for ad valorem tax purposes of all property within the County. The Monroe County Property Appraiser's office cannot guarantee its accuracy for any other purpose. Likewise, data provided regarding one tax year may not be applicable in prior or subsequent years. By requesting such data, you hereby understand and agree that the data is intended for ad valorem tax purposes only and should not be relied on for any other purpose.

By continuing into this site you assert that you have read and agree to the above statement.

## Summary

**Parcel ID** 00030430-000000  
**Account#** 1031208  
**Property ID** 1031208  
**Millage Group** 10KW  
**Location** 1104 MARGARET St, KEY WEST  
**Address**  
**Legal** KW LOT 9 AND PT LOT 11-12 OF TR 12, (AKA UNIT 1) OR2-240/41 OR665-805/07 OR670-451/52 OR679-637 OR686-140 OR686-141/42  
**Description** OR946-1800/04 OR1113-1279/92 OR1091-2202 OR1114-240/42 OR1114-1993/94 OR1114-251/53 OR2064-1825/26 OR3025-2390 OR3078-1004 OR3173-1826  
(Note: Not to be used on legal documents.)  
**Neighborhood** 6096  
**Property Class** SINGLE FAMILY RESID (0100)  
**Subdivision**  
**Sec/Twp/Rng** 05/68/25  
**Affordable** No  
**Housing**



## Owner

REYNOLDS CRAIG C 1104 Margaret St Key West FL 33040	BOOTON MARJORIE H 1104 Margaret St Key West FL 33040
---	--

## Valuation

	2023 Certified Values	2022 Certified Values	2021 Certified Values	2020 Certified Values
+ Market Improvement Value	\$194,190	\$188,057	\$164,647	\$159,336
+ Market Misc Value	\$4,843	\$4,867	\$4,890	\$4,913
+ Market Land Value	\$725,846	\$624,124	\$465,507	\$510,334
= Just Market Value	\$924,879	\$817,048	\$635,044	\$674,583
= Total Assessed Value	\$443,665	\$430,743	\$418,198	\$412,425
- School Exempt Value	(\$25,000)	(\$25,000)	(\$25,000)	(\$25,000)
= School Taxable Value	\$418,665	\$405,743	\$393,198	\$387,425

### Historical Assessments

Year	Land Value	Building Value	Yard Item Value	Just (Market) Value	Assessed Value	Exempt Value	Taxable Value	Maximum Portability
2022	\$624,124	\$188,057	\$4,867	\$817,048	\$430,743	\$25,000	\$405,743	\$386,305
2021	\$465,507	\$164,647	\$4,890	\$635,044	\$418,198	\$25,000	\$393,198	\$216,846
2020	\$510,334	\$159,336	\$4,913	\$674,583	\$412,425	\$25,000	\$387,425	\$262,158
2019	\$483,698	\$134,550	\$4,936	\$623,184	\$403,153	\$25,000	\$378,153	\$220,031
2018	\$477,861	\$138,091	\$4,959	\$620,911	\$395,636	\$25,000	\$370,636	\$225,275

The Maximum Portability is an estimate only and should not be relied upon as the actual portability amount. Contact our office to verify the actual portability amount.

### Land

Land Use	Number of Units	Unit Type	Frontage	Depth
RESIDENTIAL DRY (010D)	4,105.00	Square Foot	0	0

### Buildings

<b>Building ID</b>	2358	<b>Exterior Walls</b>	ABOVE AVERAGE WOOD
<b>Style</b>	1 STORY ELEV FOUNDATION	<b>Year Built</b>	1938
<b>Building Type</b>	S.F.R. - R1 / R1	<b>EffectiveYearBuilt</b>	2016
<b>Building Name</b>		<b>Foundation</b>	WD CONC PADS
<b>Gross Sq Ft</b>	2556	<b>Roof Type</b>	GABLE/HIP
<b>Finished Sq Ft</b>	984	<b>Roof Coverage</b>	METAL
<b>Stories</b>	1 Floor	<b>Flooring Type</b>	SFT/HD WD
<b>Condition</b>	AVERAGE	<b>Heating Type</b>	NONE with 0% NONE
<b>Perimeter</b>	130	<b>Bedrooms</b>	1
<b>Functional Obs</b>	0	<b>Full Bathrooms</b>	1
<b>Economic Obs</b>	0	<b>Half Bathrooms</b>	0
<b>Depreciation %</b>	6	<b>Grade</b>	500
<b>Interior Walls</b>	WALL BD/WD WAL	<b>Number of Fire Pl</b>	0

Code	Description	Sketch Area	Finished Area	Perimeter
SPX	EXEC SC PORCH	204	0	0
FAT	FINISHED ATTIC	720	0	0
FLA	FLOOR LIV AREA	984	984	0
OPU	OP PR UNFIN LL	324	0	0
OPF	OP PRCH FIN LL	240	0	0
SBF	UTIL FIN BLK	84	0	0
<b>TOTAL</b>		<b>2,556</b>	<b>984</b>	<b>0</b>

### Yard Items

Description	Year Built	Roll Year	Size	Quantity	Units	Grade
FENCES	1989	1990	0 x 0	1	780 SF	5
BRICK PATIO	2001	2002	0 x 0	1	122 SF	2
FENCES	1990	1991	4 x 35	1	140 SF	2

### Sales

Sale Date	Sale Price	Instrument	Instrument Number	Deed Book	Deed Page	Sale Qualification	Vacant or Improved	Grantor	Grantee
4/11/2022	\$100	Warranty Deed	2375537	3173	1826	11 - Unqualified	Improved		
2/22/2021	\$392,700	Quit Claim Deed	2306189	3078	1004	30 - Unqualified	Improved		
12/1/2004	\$725,000	Warranty Deed		2064	1825	Q - Qualified	Improved		
12/1/1989	\$175,000	Warranty Deed		1114	251	Q - Qualified	Improved		
2/1/1976	\$33,000	Conversion Code		686	141	Q - Qualified	Improved		

**Permits**

Number ↕	Date Issued ↕	Date Completed ↕	Amount ↕	Permit Type ↕	Notes ↕
22-3121	11/2/2022	11/10/2022	\$4,000	Residential	Demo new building structure including slab, walls.
22-2561	10/4/2022	11/21/2022	\$17,000	Residential	INSTALL 378 S.F. ( 4 SQS.) OF GALVALUME V-CRIMP WITH WATERPROOF SCREWS 16" ON CENTER AS PER BUILDING CODE.
0201129	5/3/2002	9/10/2002	\$2,011	Residential	NEW V-CRIMP ROOF
A954092	11/1/1995	8/1/1996	\$850	Residential	ROOF

**View Tax Info**

[View Taxes for this Parcel](#)

**Sketches (click to enlarge)**

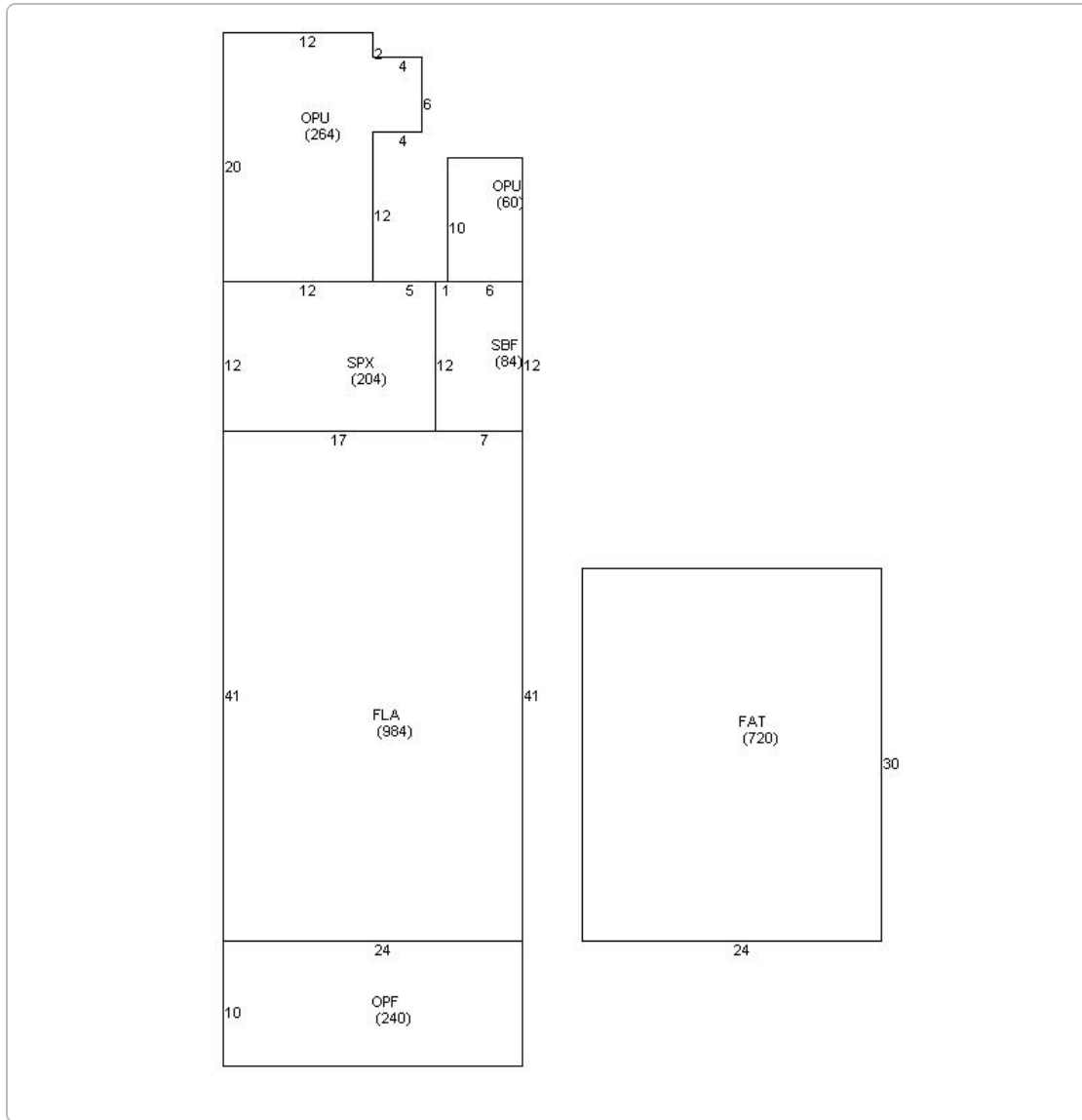

Photos





Map



TRIM Notice



[User Privacy Policy](#) [GDPR Privacy Notice](#)  
Last Data Upload: 2/26/2024, 4:04:39 AM