



Staff Report for Item 8b

To: Chairman Bryan Green and Historic Architectural Review
Commission Members

From: Kelly Perkins, MHP
HARC Assistant Planner

Meeting Date: July 28, 2015

Applicant: One Call Construction

Application Number: H15-01-0958

Address: #626 Grinnell Street

Description of Work:

Demolition of wood frame shed and wood trellis.

Site Facts:

The frame vernacular structure at 626 Grinnell Street is listed as a contributing resource, constructed c.1906. This house currently has a trellis and a shed in the rear. Neither of these structures appear on the 1962 Sanborn map or in any historic photos, and it is obvious they are not historic.

Ordinance Cited in Review:

Sec. 102-217 (2): Demolition of non-historic or non-contributing buildings, Sec. 102-218: Criteria for demolitions, and Sec. 102-125: Historic architectural review commission findings precedent to issuance in the Land Development Regulations.

Staff Analysis

This Certificate of Appropriateness proposes the demolition of a non-historic shed and trellis. Staff believes the structures do not meet any of the criteria listed in Sec.102-125, and therefore can be considered for demolition. Only one reading is required for demolition.

APPLICATION

COMBINATION APPLICATION: FLOODPLAIN, CONSTRUCTION AND HARC

\$50.00 APPLICATION FEE NON-REFUNDABLE



City of Key West

3140 FLAGLER AVENUE
KEY WEST, FLORIDA 33040

Phone: 305.809.3956

HARC PERMIT NUMBER 15-01-958		BUILDING PERMIT NUMBER 15-2574		INITIAL & DATE
FLOODPLAIN PERMIT				REVISION #
FLOOD ZONE	PANEL #	ELEV. L. FL.	SUBSTANTIAL IMPROVEMENT <input type="checkbox"/> YES <input type="checkbox"/> NO _____ %	

ADDRESS OF PROPOSED PROJECT:	626 Grinnell St. Key West, Fl 33040			# OF UNITS
RE # OR ALTERNATE KEY:	00011020-000000			
NAME ON DEED:	Christopher Belland	PHONE NUMBER		
OWNER'S MAILING ADDRESS:	626 Grinnell St. Key West, Fl 33040	EMAIL		
CONTRACTOR COMPANY NAME:	One Call Construction, Inc	PHONE NUMBER 305-294-0945		
CONTRACTOR'S CONTACT PERSON:	David Pouliot	EMAIL dave@constructionkeywest.com		
ARCHITECT / ENGINEER'S NAME:	James Hoffman	PHONE NUMBER (615) 955-0975		
ARCHITECT / ENGINEER'S ADDRESS:	7680 Buffalo Road, Nashville TN 37221	EMAIL auburnarchitect@gmail.com		

HARC: PROJECT LOCATED IN HISTORIC DISTRICT OR IS CONTRIBUTING: YES NO (SEE PART C FOR HARC APPLICATION.)

CONTRACT PRICE FOR PROJECT OR ESTIMATED TOTAL FOR MATERIALS, LABOR & PROFIT: **\$800.00**

FLORIDA STATUTE 837.06: WHOEVER KNOWINGLY MAKES A FALSE STATEMENT IN WRITING AND WITH THE INTENT TO MISLEAD A PUBLIC SERVANT IN THE PERFORMANCE OF HIS OR HER OFFICIAL DUTY SHALL BE GUILTY OF A MISDEMEANOR OF THE SECOND DEGREE PUNISHABLE PER SECTION 775.082 OR 775.083.

PROJECT TYPE:	<input checked="" type="checkbox"/> ONE OR TWO FAMILY	<input type="checkbox"/> MULTI-FAMILY	<input type="checkbox"/> COMMERCIAL	<input type="checkbox"/> NEW	<input checked="" type="checkbox"/> REMODEL
	<input type="checkbox"/> CHANGE OF USE / OCCUPANCY	<input type="checkbox"/> ADDITION	<input type="checkbox"/> SIGNAGE	<input type="checkbox"/> WITHIN FLOOD ZONE _____	
	<input type="checkbox"/> DEMOLITION	<input type="checkbox"/> SITE WORK	<input type="checkbox"/> INTERIOR	<input checked="" type="checkbox"/> EXTERIOR	<input type="checkbox"/> AFTER-THE-FACT

DETAILED PROJECT DESCRIPTION INCLUDING QUANTITIES, SQUARE FOOTAGE ETC., Remove existing
Tool Shed. Demo trellis. Construct new trellis

I'VE OBTAINED ALL NECESSARY APPROVALS FROM ASSOCIATIONS, GOVT AGENCIES AND OTHER PARTIES AS APPLICABLE TO COMPLETE THE DESCRIBED PROJECT:	
OWNER PRINT NAME: Christopher Belland	QUALIFIER PRINT NAME: David Pouliot
OWNER SIGNATURE: <i>[Signature]</i>	QUALIFIER SIGNATURE: <i>[Signature]</i>
Notary Signature as to owner:	Notary Signature as to qualifier:
STATE OF FLORIDA; COUNTY OF MONROE, SWORN TO AND SCRIBED BEFORE ME THIS <u>20</u> DAY OF <u>June</u> , 20 <u>15</u>	STATE OF FLORIDA; COUNTY OF MONROE, SWORN TO AND SCRIBED BEFORE ME THIS <u>20</u> DAY OF <u>June</u> , 20 <u>15</u>
Personally known or produced _____ as identification.	Personally known or produced _____ as identification.

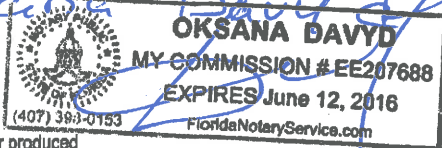

32794-1111-06

PART B: SUPPLEMENTARY PROJECT DETAILS TO AVOID DELAYS / CALL-BACKS

PROPERTY STRUCTURES AFFECTED BY PROJECT: MAIN STRUCTURE ACCESSORY STRUCTURE SITE

ACCESSORY STRUCTURES: GARAGE / CARPORT DECK FENCE OUTBUILDING / SHED

FENCE STRUCTURES: 4 FT. 6 FT. SOLID 6 FT. / TOP 2 FT. 50% OPEN

POOLS: INGROUND ABOVE GROUND SPA / HOT TUB PRIVATE PUBLIC
 PUBLIC POOLS REQUIRE BD. OF HEALTH LICENSE APPLICATION AT TIME OF CITY APPLICATION.
 PUBLIC POOLS REQUIRE BD. OF HEALTH LICENSE PRIOR TO RECEIVING THE CITY CERTIFICATE OF OCCUPANCY.

ROOFING: NEW ROOF-OVER TEAR-OFF REPAIR AWNING
 5 V METAL ASPLT. SHGLS. METAL SHGLS. BLT. UP TPO OTHER

FLORIDA ACCESSIBILITY CODE: 20% OF PROJECT FUNDS INVESTED IN ACCESSIBILITY FEATURES.

SIGNAGE: # OF SINGLE FACE # OF DOUBLE FACE REPLACE SKIN ONLY BOULEVARD ZONE
 POLE WALL PROJECTING AWNING HANGING WINDOW
 SQ. FT. OF EACH SIGN FACE: _____

SUBCONTRACTORS / SPECIALTY CONTRACTORS SUPPLEMENTARY INFORMATION:

MECHANICAL: DUCTWORK COMMERCIAL EXH. HOOD INTAKE / EXH. FANS LPG TANKS
 A / C: COMPLETE SYSTEM AIR HANDLER CONDENSER MINI-SPLIT

ELECTRICAL: LIGHTING RECEPTACLES HOOK-UP EQUIPMENT LOW VOLTAGE
 SERVICE: OVERHEAD UNDERGROUND 1 PHASE 3 PHASE _____ AMPS

PLUMBING: ONE SEWER LATERAL PER BLDG. INGROUND GREASE INTCPTRS. LPG TANKS

RESTROOMS: MEN'S WOMEN'S UNISEX ACCESSIBLE

PART C: HARC APPLICATION FOR A CERTIFICATE OF APPROPRIATENESS

APPLICATION FEES: PAINTING SINGLE FAMILY: \$10 STAFF APPROVAL: \$50 COMMISSION REVIEW \$100
 PLEASE ATTACH APPROPRIATE VARIANCES / RESOLUTIONS FROM HARC, PLANNING BOARD OR TREE COMMISSION.
 ATTENTION: NO BUILDING PERMITS WILL BE ISSUED PRIOR TO HARC APPROVAL.

PLEASE SEND ELECTRONIC SUBMISSIONS TO: harc@cityofkewest-fl.gov
 INDICATE TYPE OF CERTIFICATE OF APPROPRIATENESS: GENERAL DEMOLITION SIGN PAINTING OTHER
 ADDITIONAL INFORMATION: _____

PROJECT SPECIFICATIONS: PLEASE PROVIDE PHOTOS OF EXISTING CONDITIONS, PLANS, PRODUCT SAMPLES, TECHNICAL DATA

ARCHITECTURAL FEATURES TO BE ALTERED:	ORIGINAL MATERIAL:	PROPOSED MATERIAL:

DEMOLITION: PLEASE FILL OUT THE HARC APPENDIX FOR PROPOSED DEMOLITION.
 DEMOLITION OF HISTORIC STRUCTURES IS NOT ENCOURAGED BY THE HISTORIC ARCHITECTURAL REVIEW COMMISSION.
 SIGNAGE: (SEE PART B) BUSINESS SIGN BRAND SIGN OTHER: _____

BUSINESS LICENSE # _____ IF FAÇADE MOUNTED, SQ. FT. OF FAÇADE _____

User: KEYWBLD
 Date: 6/24/15 5:38 PM Type: OC Drawer: 1
 Receipt no: 26349
 * BUILDING PERMITS-NEW
 Trans number: 1.00 \$100.00
 VM VISA/MASTERC 3053983
 \$350.00
 Trans date: 6/24/15 Time: 12:34:03

SIGN SPECIFICATIONS		
SIGN COPY:	PROPOSED MATERIALS:	SIGNS WITH ILLUMINATION:
		TYPE OF LTG.:
		LTG. LINEAL FTG.:
MAX. HGT. OF FONTS:		COLOR AND TOTAL LUMENS:
IF USING LIGHT FIXTURES PLEASE INDICATE HOW MANY: INCLUDE SPEC. SHEET WITH LOCATIONS AND COLORS.		

OFFICIAL USE ONLY: HARC STAFF OR COMMISSION REVIEW		
<input type="checkbox"/> APPROVED <input type="checkbox"/> NOT APPROVED <input type="checkbox"/> DEFERRED FOR FUTURE CONSIDERATION <input type="checkbox"/> Tabled for add'l. info.		
HARC MEETING DATE:	HARC MEETING DATE:	HARC MEETING DATE:
REASONS OR CONDITIONS:		
STAFF REVIEW COMMENTS:		
HARC PLANNER SIGNATURE AND DATE:		HARC CHAIRPERSON SIGNATURE AND DATE:

PART D: STATE OF FLORIDA OFFICIAL NOTIFICATIONS AND WARNINGS

FLORIDA STATUTE 713.135: WARNING TO OWNER: YOUR FAILURE TO RECORD A 'NOTICE OF COMMENCEMENT' MAY RESULT IN YOUR PAYING TWICE FOR IMPROVEMENTS TO YOUR PROPERTY. A NOTICE OF COMMENCEMENT MUST BE RECORDED WITH THE COUNTY RECORDER AND A COPY POSTED ON THE JOB SITE BEFORE THE FIRST INSPECTION. IF YOU INTEND TO OBTAIN FINANCING CONSULT WITH YOUR LENDER OR AN ATTORNEY BEFORE RECORDING A NOTICE.

FLORIDA STATUTE 469: ABESTOS ABATEMENT. AS OWNER / CONTRACTOR / AGENT OF RECORD FOR THE CONSTRUCTION APPLIED FOR IN THIS APPLICATION, I AGREE THAT I WILL COMPLY WITH THE PROVISIONS F. S. 469.003 AND TO NOTIFY THE FLORIDA D. E. P. OF MY INTENT TO DEMOLISH / REMOVE ASBESTOS. IN ADDITION TO THE REQUIREMENTS OF THIS PERMIT APPLICATION, THERE MAY BE DEED RESTRICTIONS AND / OR ADDITIONAL RESTRICTIONS APPLICABLE TO THIS PROPERTY THAT MAY BE FOUND IN THE PUBLIC RECORDS OF MONROE COUNTY AND THERE MAY BE ADDITIONAL PERMITS REQUIRED FROM OTHER GOVERNMENT ENTITIES SUCH AS AQUADUCT ATHORITY, FLORIDA DEP OR OTHER STATE AGENCIES; ARMY CORPS OF ENGINEERS OR OTHER FEDERAL AGENCIES.

FEDERAL LAW REQUIRES LEAD PAINT ABATEMENT PER THE STANDARDS OF THE USDEP ON STRUCTURES BUILT PRIOR TO 1978.

OFFICIAL USE ONLY BY PLANS EXAMINER OR CHIEF BUILDING OFFICIAL:				CBO OR PL. EXAM. APPROVAL:
HARC FEES:	BLDG. FEES:	FIRE MARSHAL FEE:	IMPACT FEES:	DATE:

SANBORN MAPS

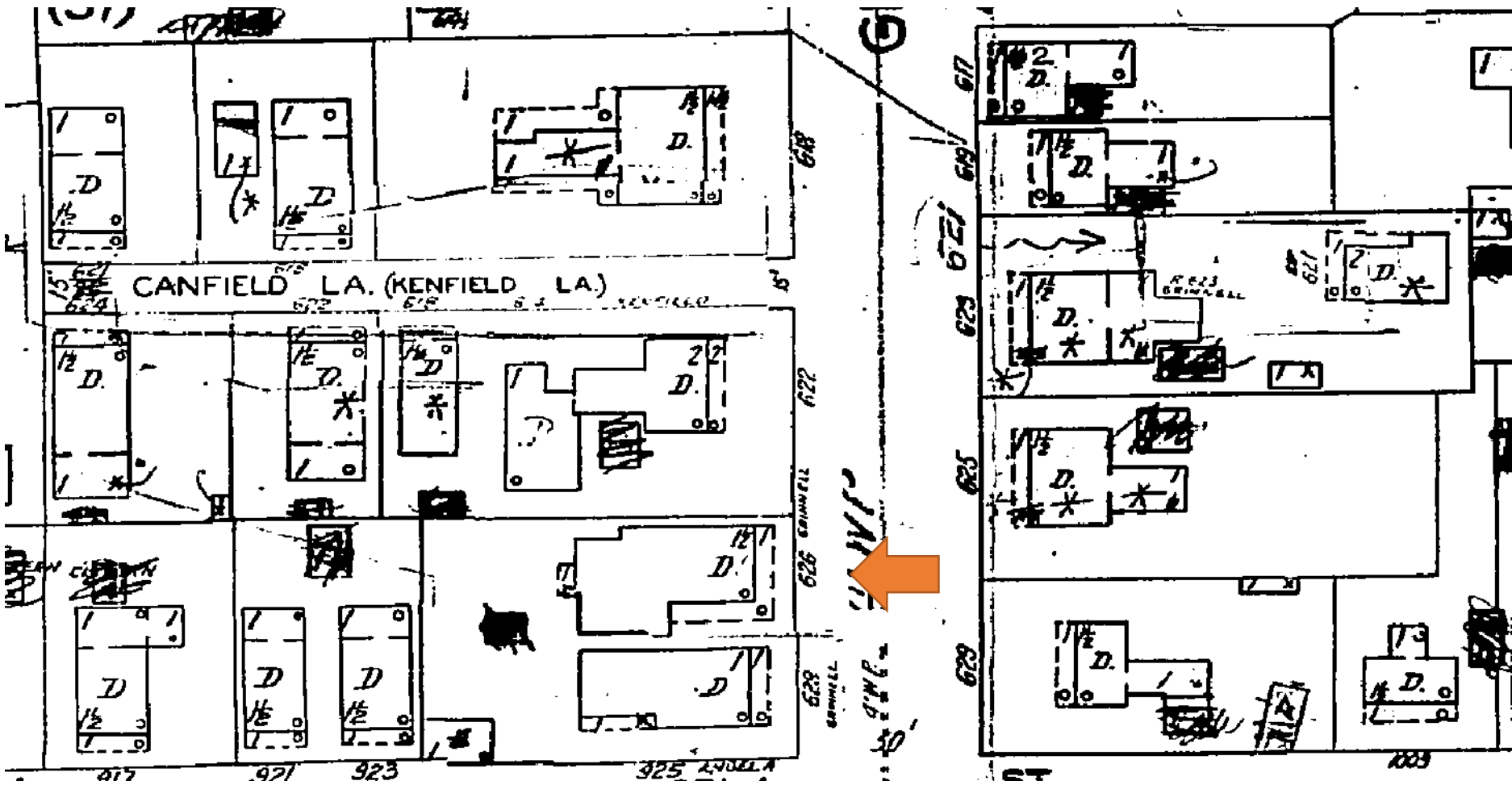

1962 Sanborn Map

PROJECT PHOTOS



Property Appraiser's Photograph, c. 1965. Monroe County Public Library.









PROPOSED DESIGN

Chris Belland
626 Grinnell St.
Key West, FL 33040

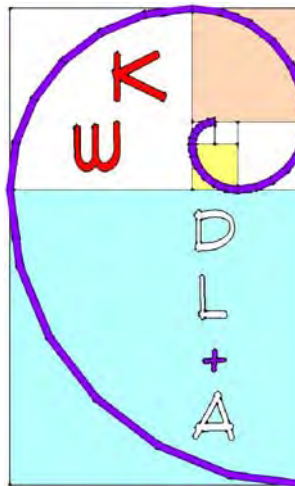

KEY WEST DESIGN LAB
+
ASSOCIATES, LLC
AA26002848
1901 FLAGLER AVENUE
KEY WEST, FL 33040
(305) 440-3960

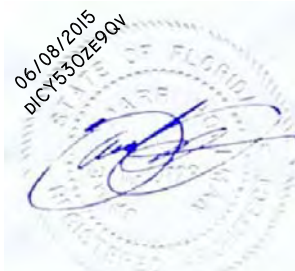

JAMES MARR HOFFMAN
AR 15,729 (615) 955-0975
AUBURNARCHITECT@GMAIL.COM

Project Information:

Site Address: 626 Grinnell St.
Key West, FL

Owner: Chris Belland

APN: 00011020000000

Scope: Exterior Improvements

Vicinity Map:

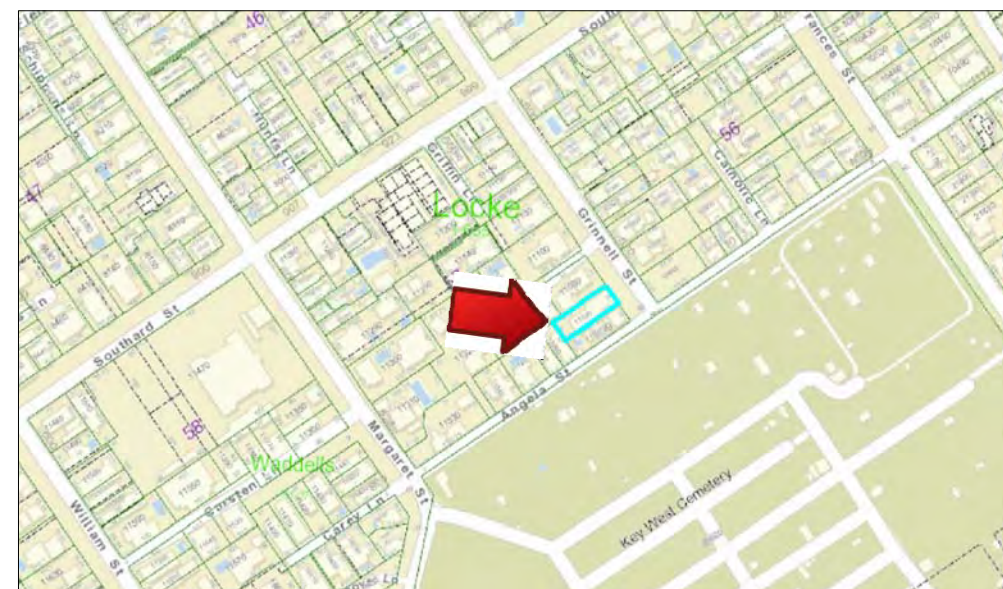

Sheet Index:

- G-1 General Information
- G-2 Site Survey
- G-3 General Notes & Design Pressures
- A-1 As-Built GF
 - A-1.1 Demolition Plan GF
 - A-1.2 Proposed GF
 - A-1.3 Sliding Door Details
- A-2 As-Built SF
 - A-2.1 Demolition Plan SF
 - A-2.2 Proposed SF
- A-3 As-Built Rear Yard
 - A-3.1 Demolition Plan Rear Yard
 - A-3.2 Proposed Deck Foundation
 - A-3.3 Proposed Deck Framing Plan
 - A-3.4 Proposed Trellis
 - A-3.5 Trellis Details
 - A-3.6 Gate Details
 - A-3.7 Proposed Pool Equipment Shed
- A-4 Details

Exterior Improvements
Chris Belland
626 Grinnell St.
Key West, FL 33040

General Information

06/08/2015

G-1

Sheet 01 of 19

ONE CALL CONSTRUCTION, INC.

"One Call Does It All"
1901 Flagler Ave - Key West, FL 33040
Tel: 305-294-0945 - Fax: 305-359-3226
E-mail: info@constructionkeywest.com

CGC1507029
CGC1327352
SL3188768

Boundary Survey Map of part of Lot 1, Square 57, Island of Key West

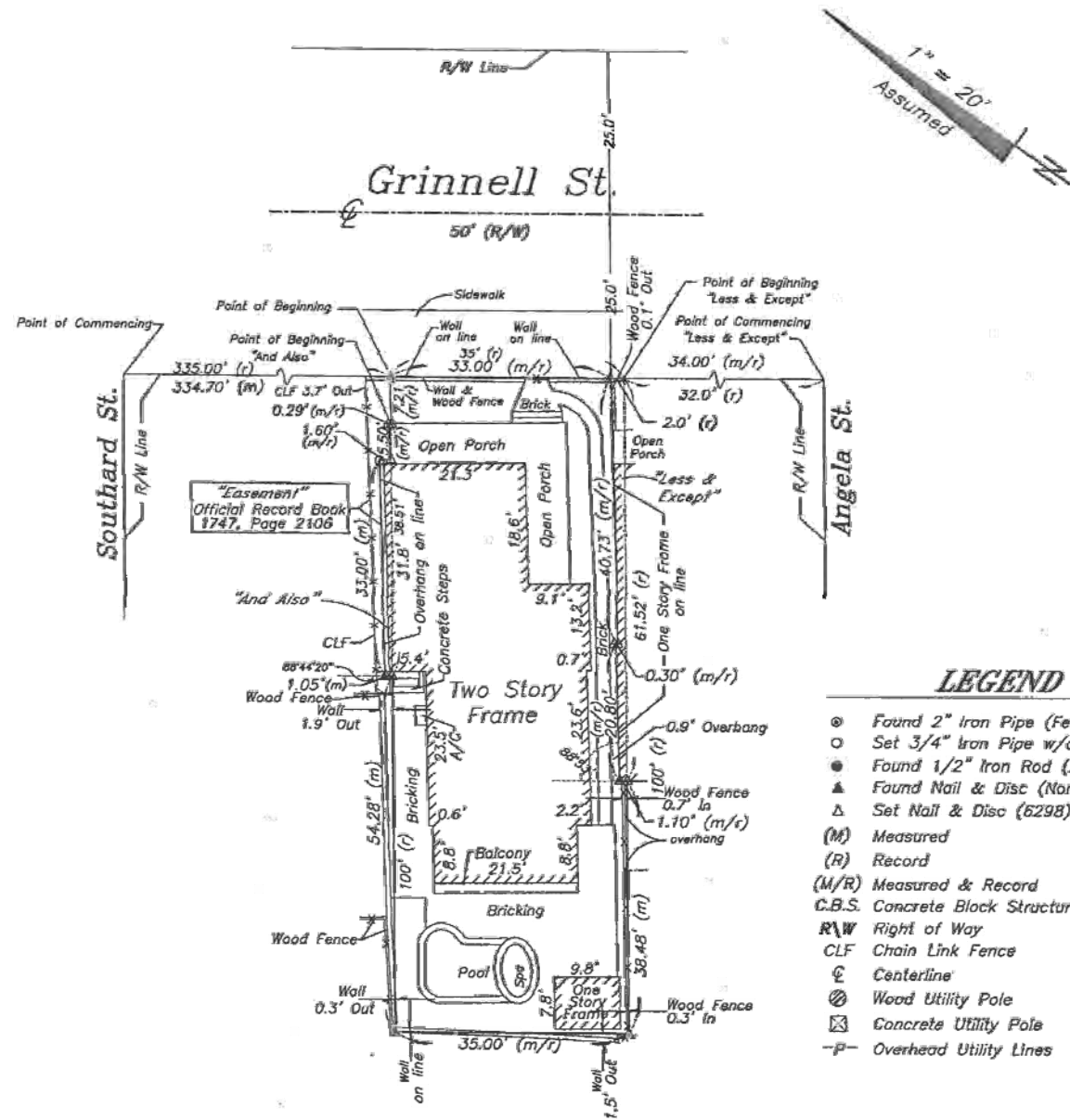

- NOTES:**
1. The legal description shown hereon was furnished by the client or their agent. This survey does not determine or imply ownership.
 2. Underground foundations and utilities were not located.
 3. All angles are 90° (Measured & Record) unless otherwise noted.
 4. Street address: 626 Grinnell Street, Key West, FL.
 5. This survey is not valid without the signature and the original raised seal of a Florida licensed surveyor and mapper.
 6. Lands shown hereon were not abstracted for rights-of-way, easements, ownership, or other instruments of record.
 7. North Arrow is assumed and based on the legal description.
 8. Date of field work: March 2, 2015
 9. Ownership of fences is undeterminable, unless otherwise noted.
 10. Adjainers are not furnished.
 11. The Survey Report is not full and complete without the attached Survey Map.
 12. All bricking and concrete is not shown.

BOUNDARY SURVEY OF: In the City of Key West, Monroe County, Florida, being a part of Lot One (1), Square Fifty-seven (57), of the Map of the Island of Key West, delineated in February 1829 by William A. Whitehead, but more particularly described as follows: COMMENCING at a point Three Hundred Thirty-five (335) feet from the corner of Southard and Grinnell Streets and running thence along said Grinnell Street in a Southeasterly direction Thirty-five (35) feet; thence at right angles in a Southwesterly direction One Hundred (100) feet; thence at right angles in a Northwesterly direction Thirty-five (35) feet; thence at right angles in a Northeasterly direction One Hundred (100) feet, back to the Point of Beginning.

LESS & EXCEPT;
A parcel of land on the Island of Key West and known on William A. Whitehead's map of said Island delineated in February A.D. 1829, as a part of Lot One (1) in Square Fifty-seven (57), said parcel being further described by metes and bounds as follows: COMMENCING at the intersection of the NW'y right of way line of Angela Street with the SW'y right of way line of Grinnell Street and run thence NW'y along the SW'y right of way line of the said Grinnell Street for a distance of 32.0 feet to the Point of Beginning; thence SW'y and at right angles for a distance of 61.52 feet to the SW'y face of an existing one story frame structure; thence NW'y at right angles and along the said structure for a distance of 1.10 feet; thence NE'y with a deflection angle of 88°53' to the right and along the said structure for a distance of 20.8 feet; thence SE'y at right angles and along the said structure for a distance of 0.30 feet; thence NE'y at right angles and along the said structure and along an existing wood fence for a distance of 40.73 feet to the SW'y right of way line of the said Grinnell Street; thence SE'y and along the said Grinnell Street for a distance of 2.0 feet back to the Point of Beginning.

AND ALSO;
A parcel of land on the Island of Key West and known on William A. Whitehead's map of said Island delineated in February A.D. 1829, as a part of Lot One (1) in Square Fifty-seven (57), said parcel being further described by metes and bounds as follows: COMMENCING at the intersection of the Southeasterly right of way line of Southard Street with the Southwesterly right of way line of Grinnell Street and run thence Southeasterly along the Southwesterly right of way line of the said Grinnell Street for a distance of 335.00 feet; thence Southwesterly and at right angles for a distance of 7.21 feet to the Northeasterly face of an existing open porch, said point also being the Point of Beginning; thence continue Southwesterly along the previously mentioned course for a distance of 38.51 feet to the Southwesterly face of an overhang on an existing two story frame structure; thence Northwesterly with a deflection angle of 88°44'20" to the right and along the said face of the overhang for a distance of 1.05 feet; thence Northeasterly and at right angles along the Northwesterly face of said overhang for a distance of 33.00 feet; thence Southeasterly and at right angles along the Northeasterly face of said overhang for a distance of 1.60 feet to the Northwesterly face of the said open porch; thence Northeasterly and at right angles along the Northwesterly face of said porch for a distance of 5.50 feet; thence Southeasterly and at right angles along the Northeasterly face of said open porch for a distance of 0.29 feet back to the Point of Beginning.

BOUNDARY SURVEY FOR: Chris Belland and Piper Smith;
City National Bank of Florida;
Smith Oropeza Hawks, P.L.;
Old Republic National Title Insurance Company;

I HEREBY CERTIFY that this survey was made under my responsible charge and meets the Standard of Practice as set forth by the Florida Board of Professional Surveyors & Mappers in Chapter 5J-17, Florida Administrative Code, pursuant to Section 472.027, Florida Statutes.

J. LYNN O'FLYNN, INC.
[Signature]
J. Lynn O'Flynn, PSM
Florida Reg. #6298

THIS SURVEY
IS NOT
ASSIGNABLE

March 6, 2015

Sheet Two of Two Sheets

J. LYNN O'FLYNN, Inc.
Professional Surveyor & Mapper
FSM #6298

3430 Duck Ave., Key West, FL 33040
(305) 296-7422 FAX (305) 296-2244

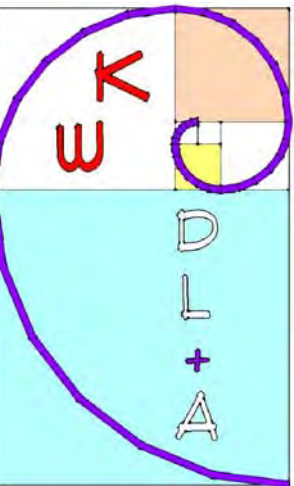

**KEY WEST DESIGN LAB
+
ASSOCIATES, LLC**
AA26002848
1901 FLAGLER AVENUE
KEY WEST, FL 33040
(305) 440-3960

Exterior Improvements
Chris Belland
626 Grinnell St.
Key West, FL 33040

Survey

06/08/15

Basic Wind Speed, V:	180 mph	ASD: P = 0.6w
Exposure Category:	C	K _d = 1.0
Mean Roof Height, h:	20.0 ft	GC _{pi} = 0.18
Enclosure Type:	Enclosed	K _{zt} = 1.0
Roof Type:	Gable	K _h = 0.90
Roof Pitch:	7.00 : 12 (30.3 degrees)	q _h = 74.81 psf
		Minimum Building Dimension, L: 65.0 ft
		End Zone (a): 6.5 ft
		a = 10% of LHD (6.5 ft) or 0.4h (8.0 ft), whichever is smaller but not less than 4% of LHD (2.6 ft) or 3 ft.

Mark	Width Height		Zone	Shutter?	Area (sqft)	K _z	q _z	GC _{p+}	GC _{p-}	Design Pressures (psf)	
	(in)	(in)								+	-
1	42.0	52.0	5		15.17	0.90	74.81	0.97	-1.34	+51.53	-68.05
2	42.0	52.0	5		15.17	0.90	74.81	0.97	-1.34	+51.53	-68.05

Basic Wind Speed, V:	180 mph	ASD: P = 0.6w
Exposure Category:	C	K _d = 1.0
Mean Roof Height, h:	20.0 ft	GC _{pi} = 0.18
Enclosure Type:	Enclosed	K _{zt} = 1.0
Roof Type:	Gable	K _h = 0.90
Roof Pitch:	7.00 : 12 (30.3 degrees)	q _h = 74.81 psf
		Minimum Building Dimension, L: 22.0 ft
		End Zone (a): 3.0 ft
		a = 10% of LHD (2.2 ft) or 0.4h (8.0 ft), whichever is smaller but not less than 4% of LHD (0.9 ft) or 3 ft.

Mark	Width Height		Zone	Shutter?	Area (sqft)	K _z	q _z	GC _{p+}	GC _{p-}	Design Pressures (psf)	
	(in)	(in)								+	-
1	180.0	80.0	5		100.00	0.90	74.81	0.82	-1.05	+45.04	-55.06

1 Design Pressures for new Sliding Glass Doors - See (A-1.3)

General Conditions
American Institute of Architects A201,
 General Conditions of the Contract for Construction, is hereby incorporated by reference and shall be the guideline for direction for subjects related to the work not expressly described in this document -

Code Data - 2010 FBC - Existing Building
 This work shall comply with the **2010 Florida Building Code** and with **The City of Key West's** ordinances, amendments, rules and regulations -

Chapter 7 - Alterations, Level 2
 Alterations outlined in this scope of work shall comply with this chapter -

Chapter 14 - Construction Safeguards:
 Project is not accessible to the public. Private SFR shall be maintained in a safe workmanlike manner during the execution of alterations -

1401.3 - Required exits, existing structural elements, fire protection devices, and sanitary safeguards shall be maintained at all times during repairs.

Prior to selective demolition of areas, walls, floors and roof structures shall be appropriately braced and shored to prevent collapse. Adjacent building areas are to be unoccupied during the demolition process.

Hidden Conditions:

During repairs, if structural components are determined to be damaged, damaged materials shall be removed and replaced with like kind and new connections/anchorage shall be made with appropriate *Simpson* hardware or conventional hardware as necessary -

Attachment Details	
Footers to Beams	Simpson HD5B
Internal Structural Framing	Simpson HUS Hangars*
Deck Framing	Simpson LUS Hangars*
Wall Framing Bottom Plate	Simpson SP1
Wall Framing Top Plate	Simpson SP2
Top Plate to Roof	Simpson MTS16 MIN
Flat Straps on all structural Headers from Jack to Cripple	Simpson HRS*

*Use correct size hardware for lumber being utilized per Simpson.

ONE CALL CONSTRUCTION, INC.
One Call Does It All

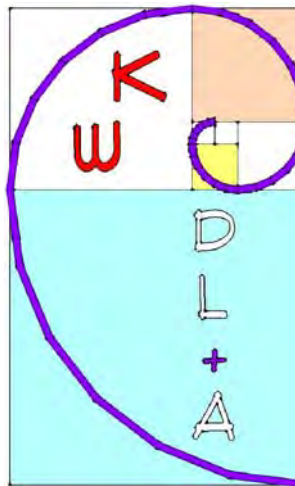

KEY WEST DESIGN LAB
 +
ASSOCIATES, LLC
 AA26002848
 1901 FLAGLER AVENUE
 KEY WEST, FL 33040
 (305) 440-3960

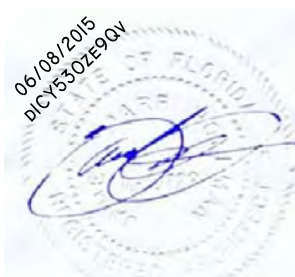

JAMES MARR HOFFMAN
 AR 15,729 (615) 955-0975
 AUBURNARCHITECT@GMAIL.COM

Exterior Improvements
Chris Belland
626 Grinnell St.
Key West, FL 33040

General Notes &
 Design Pressures

06/08/15
G-3
 Sheet 03 of 19

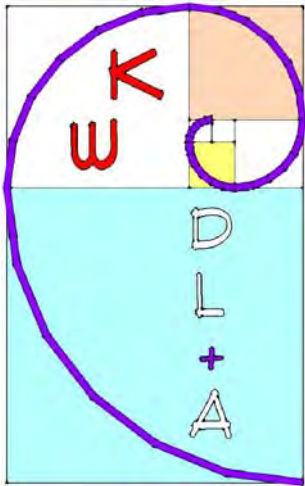

KEY WEST DESIGN LAB
+
ASSOCIATES, LLC
AA26002848
1901 FLAGLER AVENUE
KEY WEST, FL 33040
(305) 440-3960

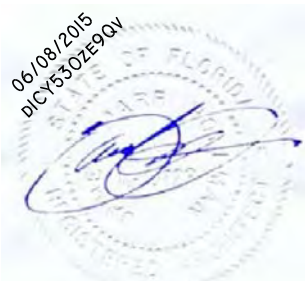

JAMES MARR HOFFMAN
AR 15,729 (615) 955-0975
AUBURNARCHITECT@GMAIL.COM

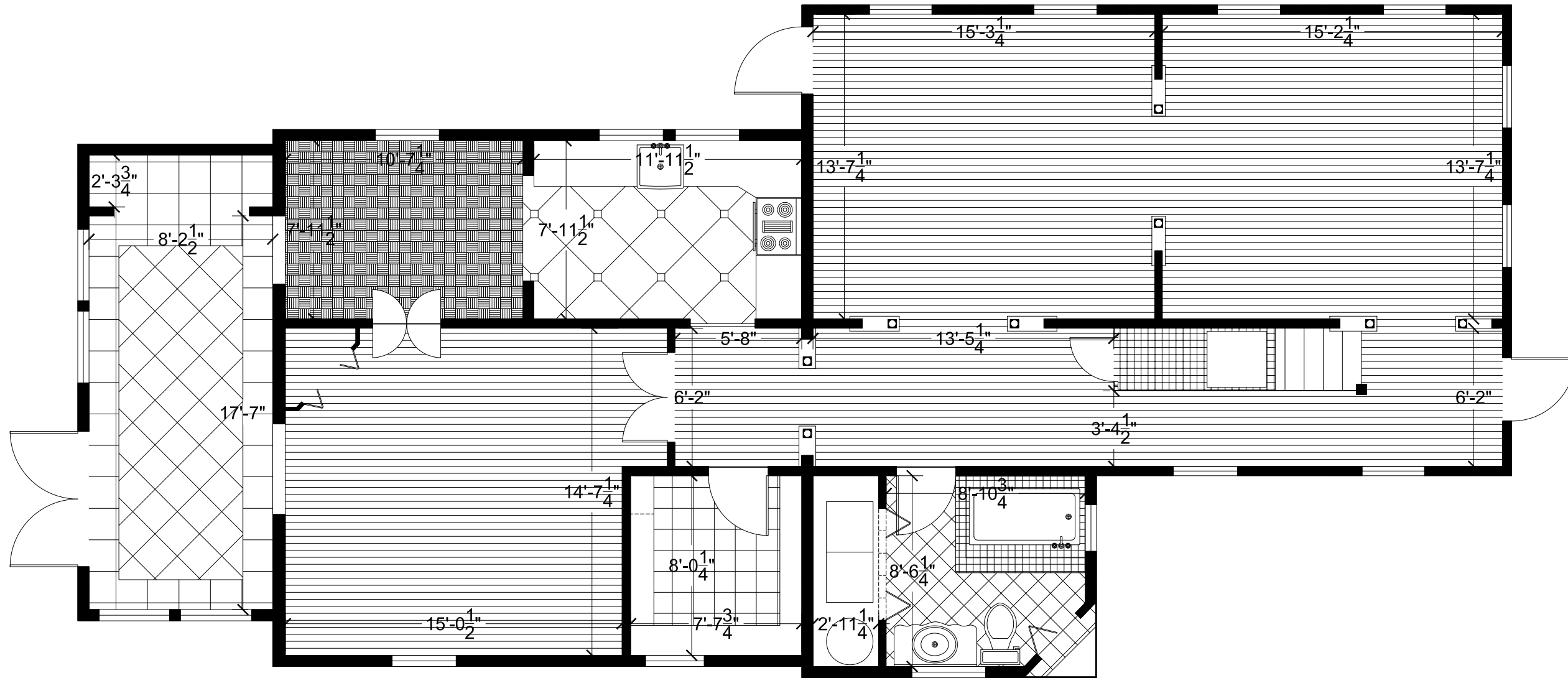

1
A-1

As-Built Ground Floor

Scale: 3/16" = 1'-0"

Exterior Improvements
Chris Belland
626 Grinnell St.
Key West, FL 33040

As-Built
GF Floor Plan

06/08/15

A-1

Sheet 04 of 19

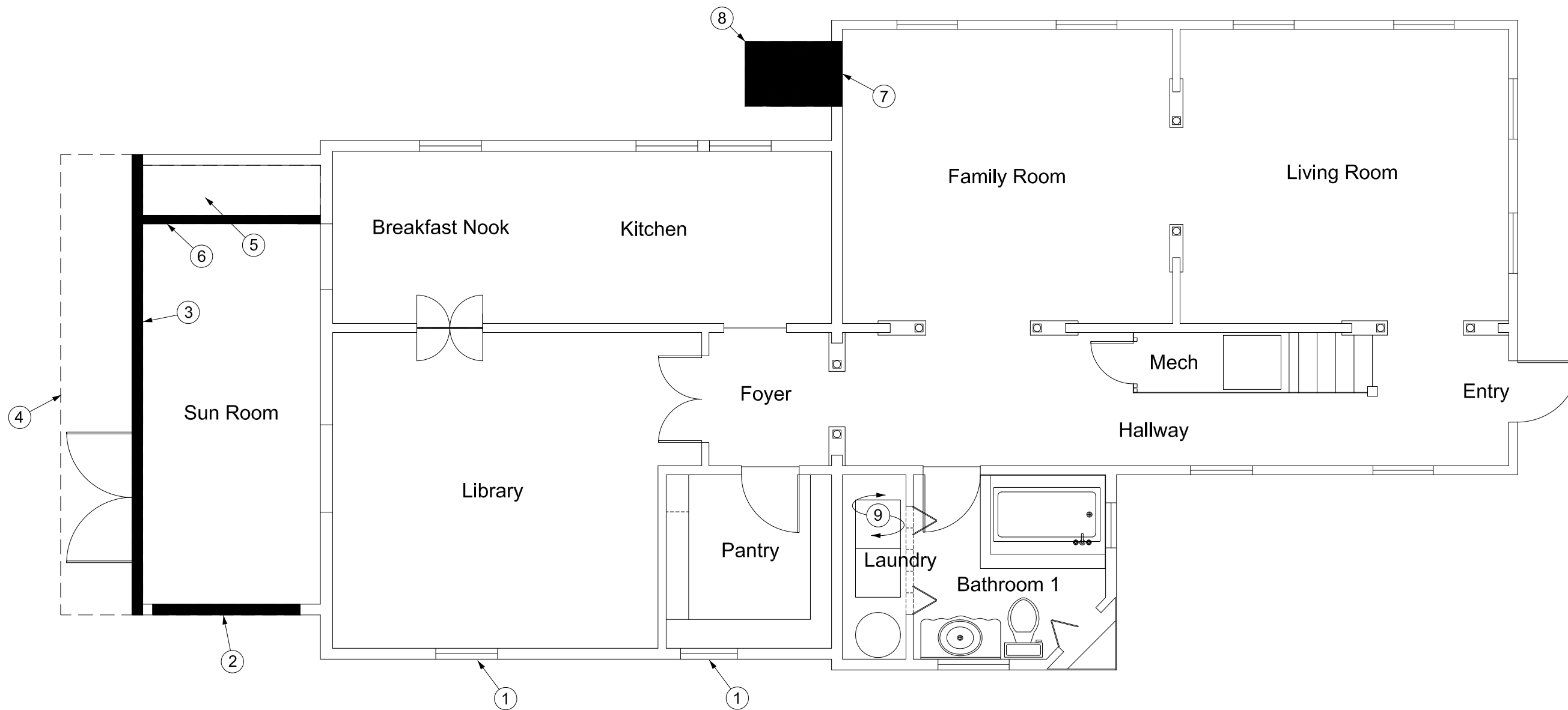

1
A-1.1

Ground Floor Demolition Plan

Scale: 3/16" = 1'-0"

Notes/Scope of Work:

- (1) Remove Plexiglas Covers Over Side Windows -
- (2) Remove (2) Side Windows and Wall Material in Sun Room for New Windows and Mull Bar -
- (3) Remove Exterior Wall in Sun Room -
- (4) Remove Fascia and Roof back to Exterior Wall -
- (5) Remove of Interior Finishes in Sun Room Closet -
- (6) Remove Wall Material in Sun Room Closet -
- (7) Remove Exterior Door in Family Room -
- (8) Remove Roof Overhang from Exterior Door in Family Room -
- (9) Remove Ceiling Material as Necessary in Laundry Room for Laundry Chute -

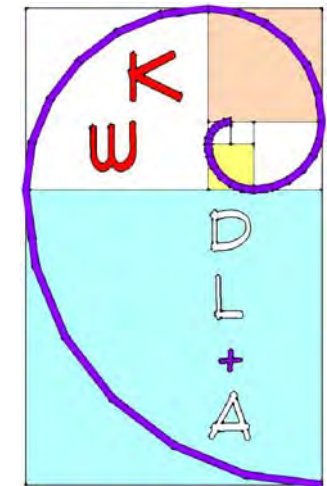

**KEY WEST DESIGN LAB
+
ASSOCIATES, LLC**
AA26002848
1901 FLAGLER AVENUE
KEY WEST, FL 33040
(305) 440-3960

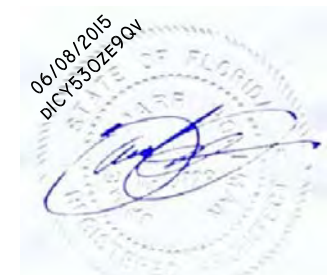

JAMES MARR HOFFMAN
AR 15,729 (615) 955-0975
AUBURNARCHITECT@GMAIL.COM

Exterior Improvements
Chris Belland
626 Grinnell St.
Key West, FL 33040

Ground Floor
Demolition Plan

06/08/15

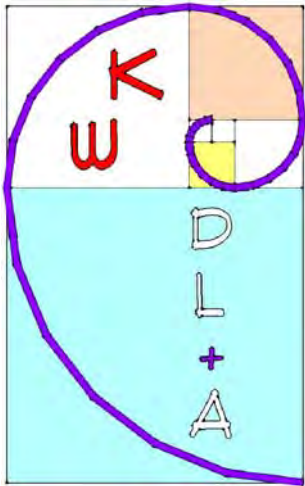

**KEY WEST DESIGN LAB
+
ASSOCIATES, LLC**
AA26002848
1901 FLAGLER AVENUE
KEY WEST, FL 33040
(305) 440-3960

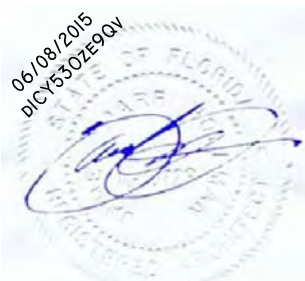

JAMES MARR HOFFMAN
AR 15,729 (615) 955-0975
AUBURNARCHITECT@GMAIL.COM

Exterior Improvements
Chris Belland
626 Grinnell St.
Key West, FL 33040

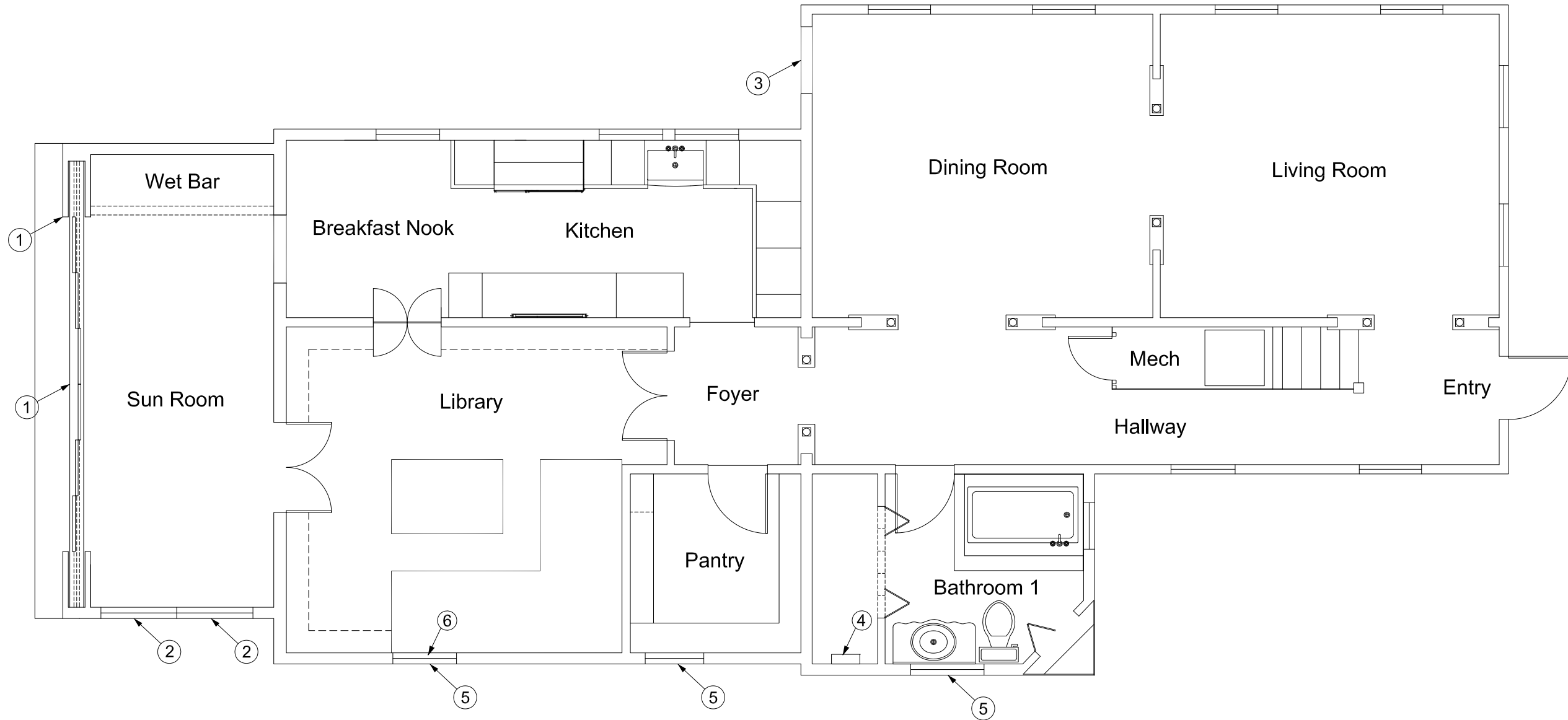

1 Proposed Ground Floor Plan

A-1.2

Scale: 3/16" = 1'-0"

Notes/Scope of Work:

- | | |
|---|--|
| <p>(1) Replace Exterior Wall in Sun Room with Sliding Pocket Door (See Details on Sheet (A-1.3) - See Design Pressures on (G-3) -</p> <p>(2) Replace Side Wall Windows in Sun Room with (2) larger windows separated by mull bar - See Design Pressures on (G-3) -</p> <p>(3) Fill in wall cavity from Exterior Door - Provide PT 2x4 framing with Simpson SP1 brackets on top and bottom of new framing - Provide Lap Siding saw-toothed into existing - Provide R-13 Insulation - Provide 1x4 wood infill on interior wall, saw-tooth into existing -</p> | <p>(4) Replace Water Heater with New Tankless Water heater -</p> <p>(5) Provide new poly carb shutters - See Details (A-4)</p> <p>(6) Infill Window in Library w/ PT 2x framing - Provide 1x4 wood infill on interior wall saw-toothed into existing -</p> |
|---|--|

Proposed GF Plan

06/08/15

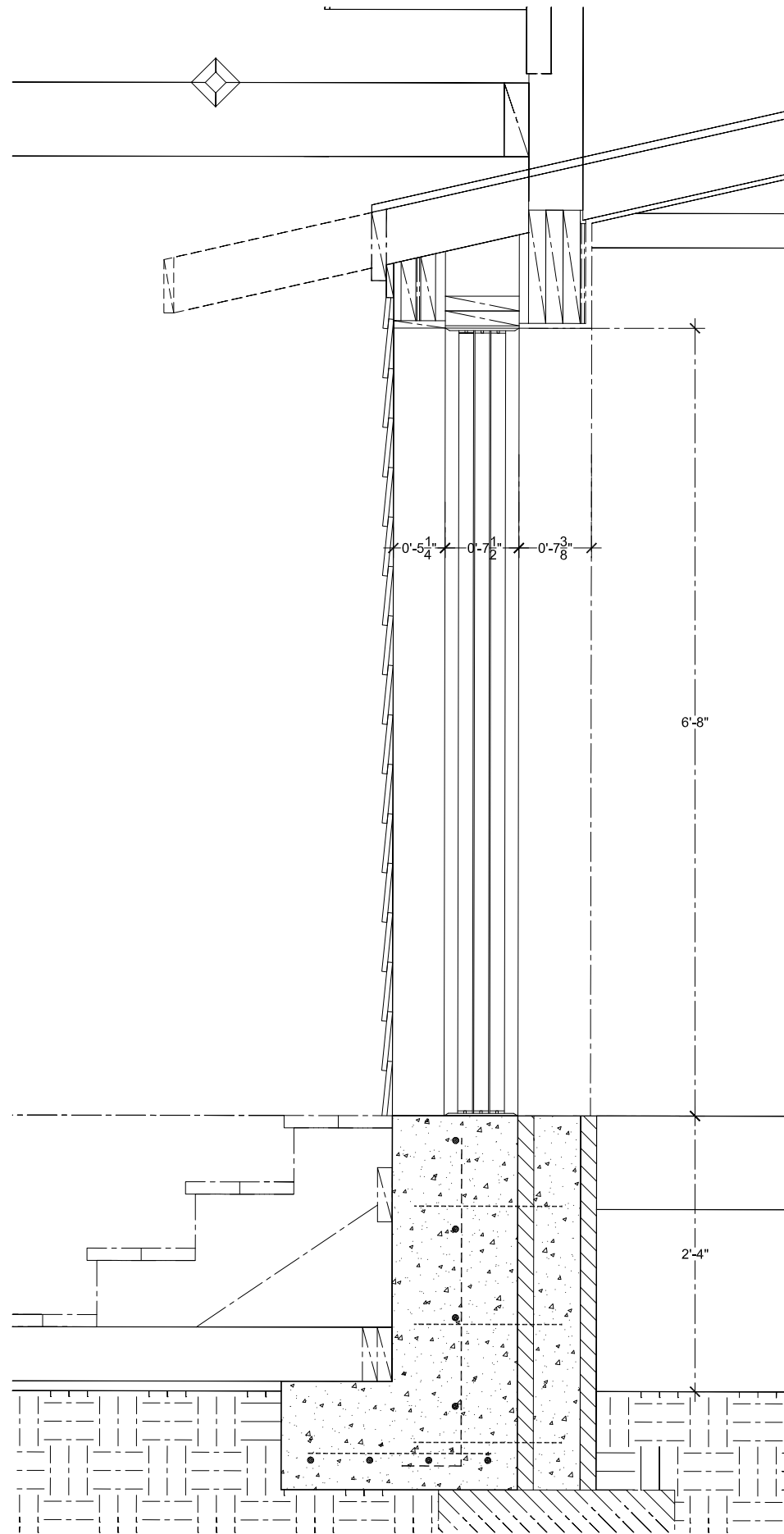

1 Proposed Wall Section
A-1.3
Scale: 3/4" = 1'-0"

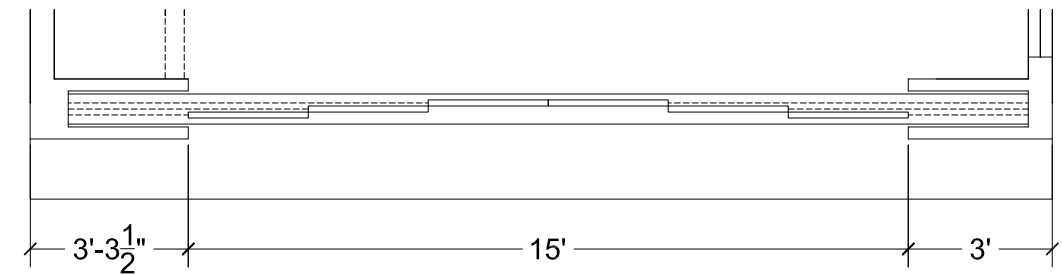

2 Proposed Plan
A-1.3
Scale: 1/4" = 1'-0"

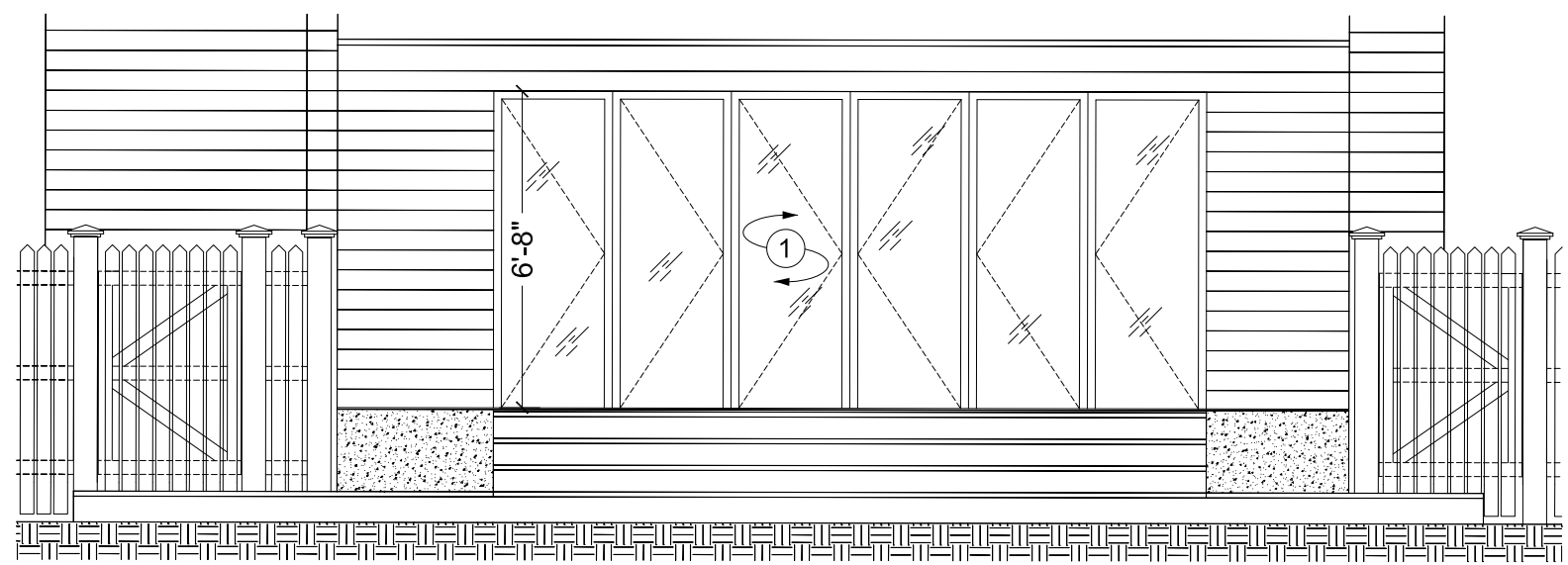

3 Proposed Rear Elevation
A-1.3
Scale: 1/4" = 1'-0"

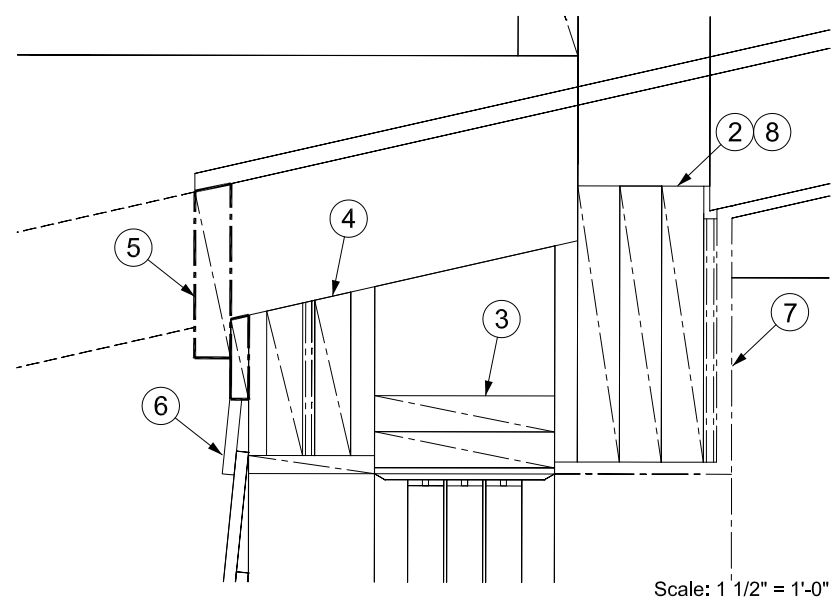

4 Header Detail
A-1.3
Scale: 1 1/2" = 1'-0"

Notes/Scope of Work:

- (1) Replace Exterior Wall in Sun Room with Sliding Pocket Door - See Details this Sheet -
- (2) Provide (3) 1 3/4" x 11 1/2" LVL's - See Detail (A-4)
- (3) Provide PT (2) 2x Track Header -
- (4) Provide PT 3 1/2" x Varies Header -
- (5) Provide PT 2x Fascia -
- (6) Provide PT Lap Siding to match existing on
30# Felt on
3/4" CDX Exp1 Plywood on
PT 2x4 Studs @ 16"oc w/
3/4" CDZ Exp1 Plywood interior w/
1/4" Cement Board interior -
- (7) Provide Gypsum Wall Board on
3/4" CDX Exp 1 Plywood on
(3) LVL Header w/
3/4" CDX Exp 1 Plywood exterior w/
1/4" Cement Board exterior -
- (8) Provide (4) PT 2x6 Jacks at LVL Beam Ends - Provide Simpson HD9B @ base of jacks -

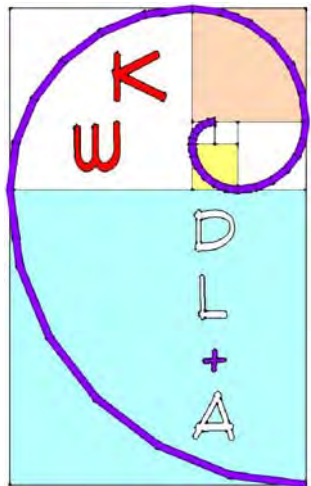

**KEY WEST DESIGN LAB
+
ASSOCIATES, LLC**
AA26002848
1901 FLAGLER AVENUE
KEY WEST, FL 33040
(305) 440-3960

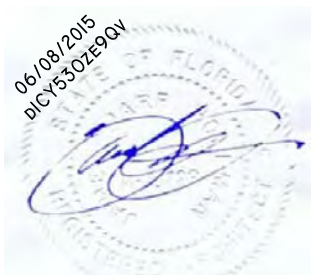

JAMES MARR HOFFMAN
AR 15,729 (615) 955-0975
AUBURNARCHITECT@GMAIL.COM

ONE CALL CONSTRUCTION, INC.
One Call Does It All!

Exterior Improvements
Chris Belland
626 Grinnell St.
Key West, FL 33040

New Pocket
Slider Details

06/08/15

A-1.3

Sheet 07 of 19

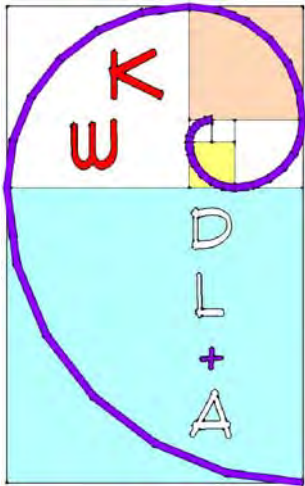

KEY WEST DESIGN LAB
+
ASSOCIATES, LLC
AA26002848
1901 FLAGLER AVENUE
KEY WEST, FL 33040
(305) 440-3960

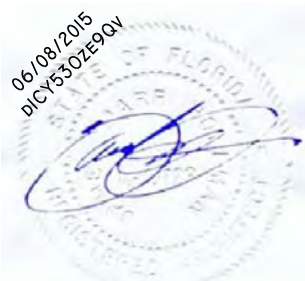

JAMES MARR HOFFMAN
AR 15,729 (615) 955-0975
AUBURNARCHITECT@GMAIL.COM

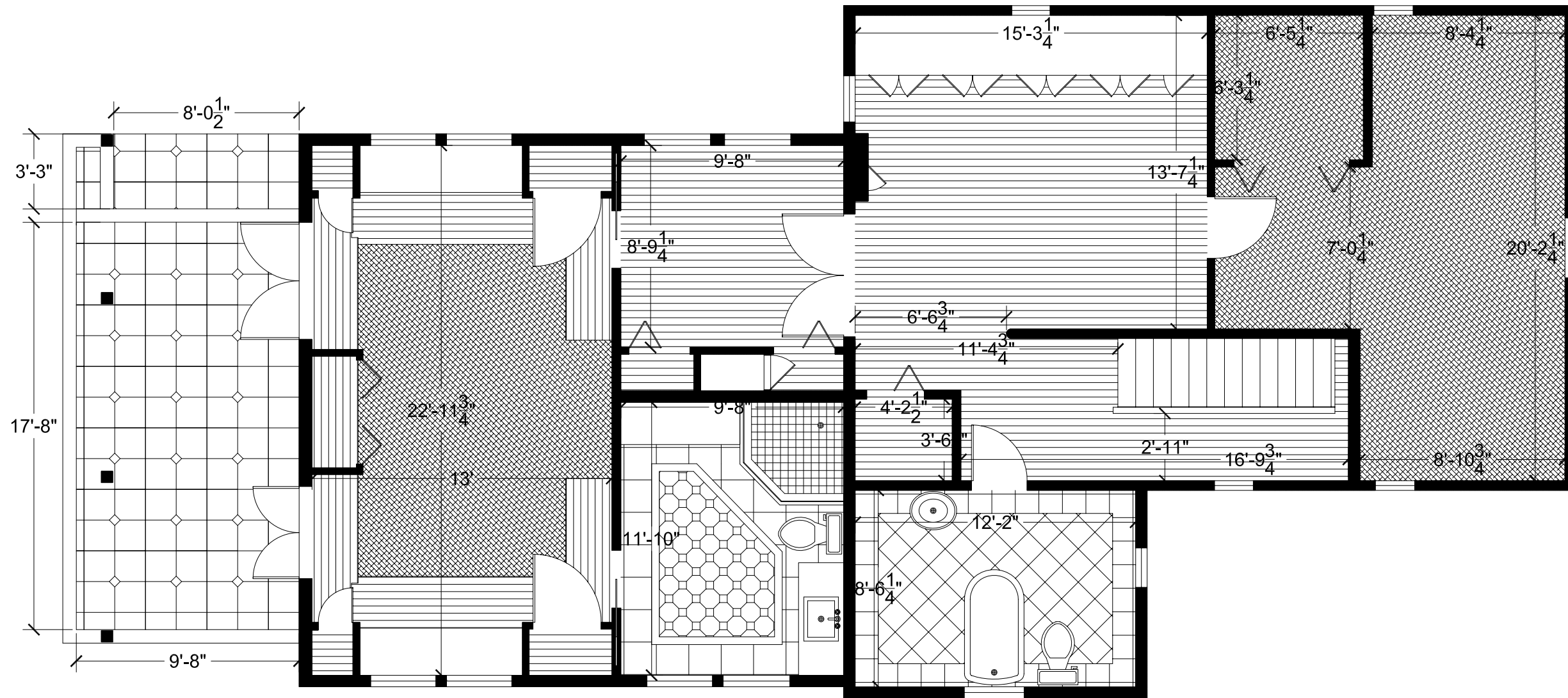

1
A-2

As-Built Second Floor

Scale: 3/16" = 1'-0"

Exterior Improvements
Chris Belland
626 Grinnell St.
Key West, FL 33040

As-Built
SF Floor Plan

06/08/15

 **ONE CALL CONSTRUCTION, INC.**
One Call Does It All

A-2

Sheet 08 of 19

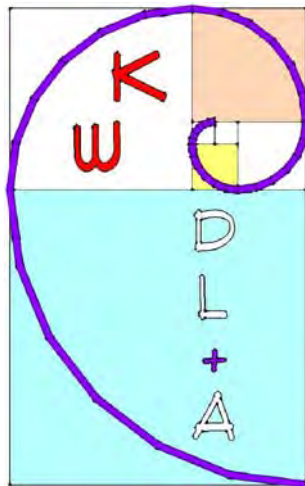

**KEY WEST DESIGN LAB
+
ASSOCIATES, LLC**
AA26002848
1901 FLAGLER AVENUE
KEY WEST, FL 33040
(305) 440-3960

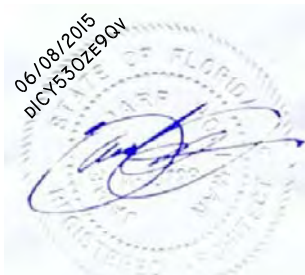

JAMES MARR HOFFMAN
AR 15,729 (615) 955-0975
AUBURNARCHITECT@GMAIL.COM

Exterior Improvements
Chris Belland
626 Grinnell St.
Key West, FL 33040

Second Floor
Demolition Plan

06/08/15

A-2.1

Sheet 09 of 19

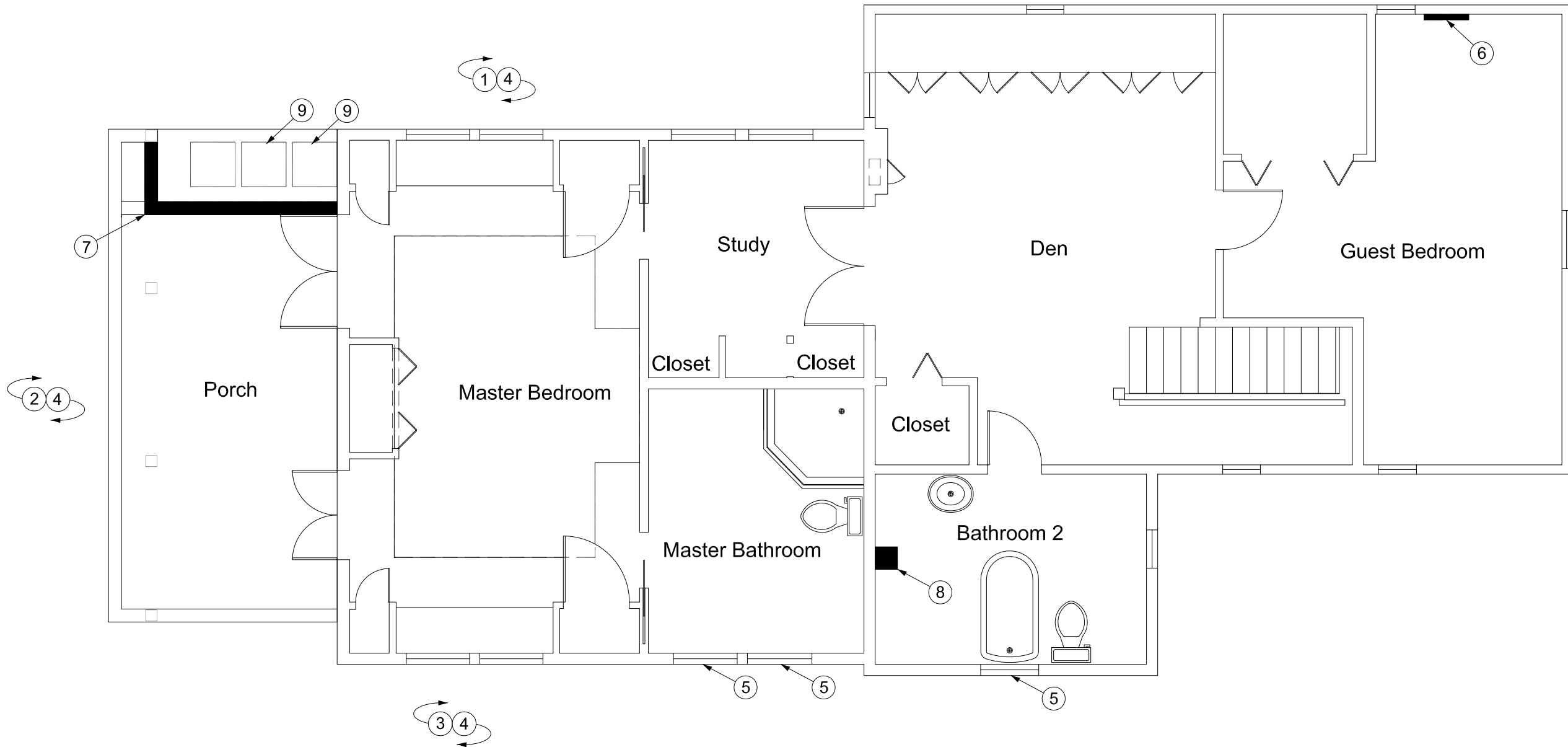

1
A-2.1 **Second Floor Demolition Plan**

Scale: 3/16" = 1'-0"

Notes/Scope of Work:

- | | |
|--|---|
| (1) Remove Gutter Systems (approx. 38 LF) on Left of House - | (6) Remove A/C Unit in Guest Bedroom - |
| (2) Remove Gutter Systems (approx. 25 LF) on Rear of House - | (7) Remove Rail System on Upper Deck Separating
Condensing Units from Deck - |
| (3) Remove Gutter Systems (approx. 3 LF) on Right of House - | (8) Remove Floor Material as Necessary in Bathroom 2 for
Laundry Chute - |
| (4) Remove Damaged Fascia Board as Necessary - | (9) Remove (2) Condensing Units - |
| (5) Remove Yellowing Plexiglas Shutters Over Side Windows - | |

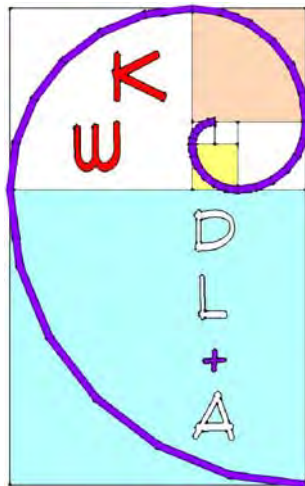

**KEY WEST DESIGN LAB
+
ASSOCIATES, LLC**
AA26002848
1901 FLAGLER AVENUE
KEY WEST, FL 33040
(305) 440-3960

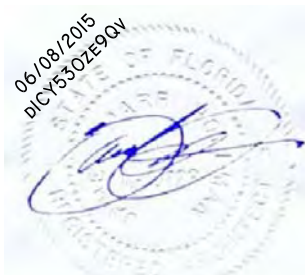

JAMES MARR HOFFMAN
AR 15,729 (615) 955-0975
AUBURNARCHITECT@GMAIL.COM

Exterior Improvements
Chris Belland
626 Grinnell St.
Key West, FL 33040

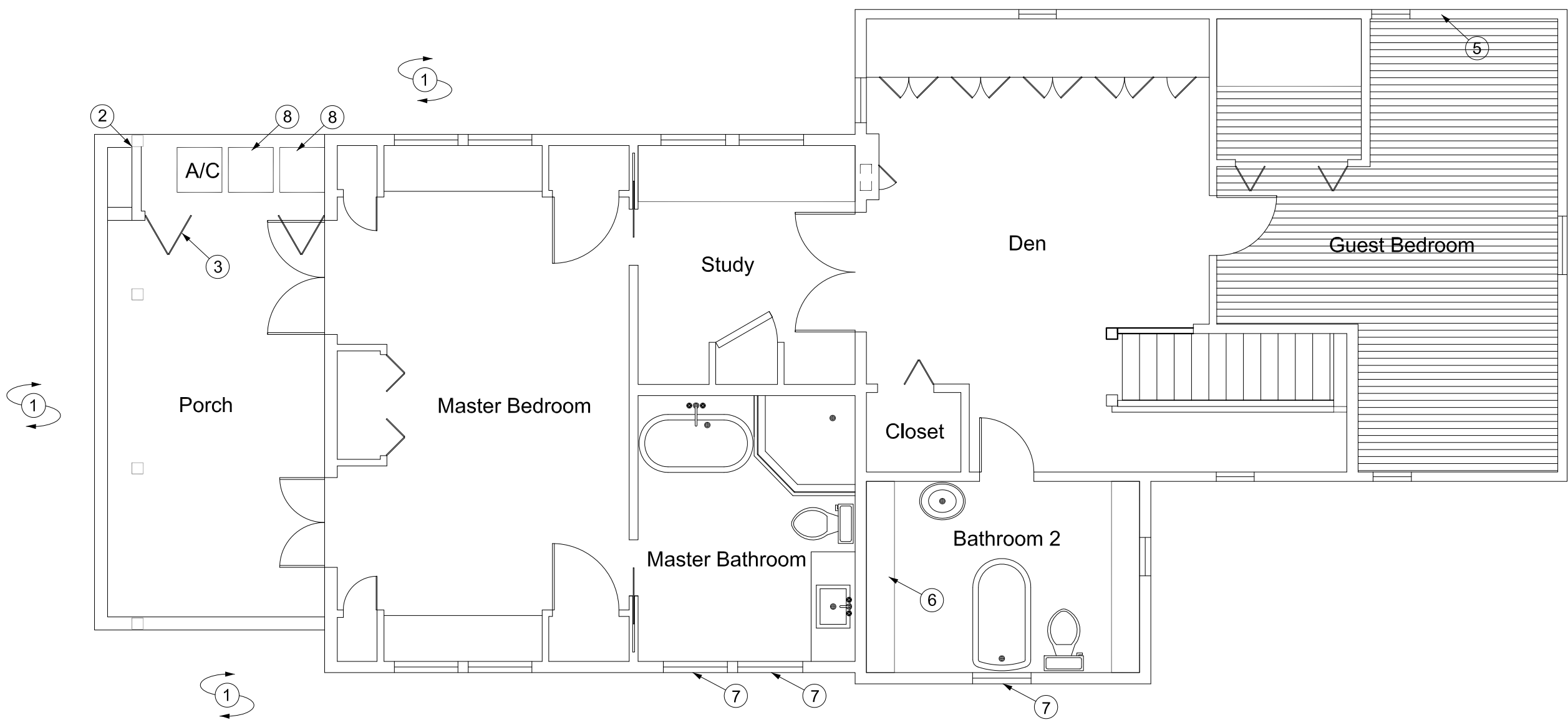

1 Proposed Second Floor Plan
A-2.2

Scale: 3/16" = 1'-0"

Notes/Scope of Work:

- (1) Replace damaged Fascia Board with 1x Pressure Treated Material -
- (2) Replace Railing in Porch Area with New Wall - Provide PT 2x4 framing with appropriate *Simpson* hardware - Provide *Simpson* SP1 anchors top and bottom of studs - Provide Lap Siding saw-toothed into existing -
- (3) Provide Plantation Louvered Doors in New Framing for Access to AC Units -
- (4) Provide (2) New 2 Ton 16 SEER REEM AC Units -
- (5) Fill In Wall Cavity from Removed AC Unit - Provide PT 2x4 framing with *Simpson* SP1 anchors on top and bottom of New Framing - Provide Lap Siding saw-toothed into existing - Provide of R-13 Insulation - Provide 1x4 infill on Interior Wall, saw-tooth into existing -
- (6) Provide Laundry Chute from Bathroom 2 to Laundry Room with appropriate framing and finishes -
- (7) Replace damaged Poly Carbonate - See Details (A-4)
- (8) Provide (2) New 2 Ton 16 SEER REEM AC Units -

Proposed SF Plan

06/08/15

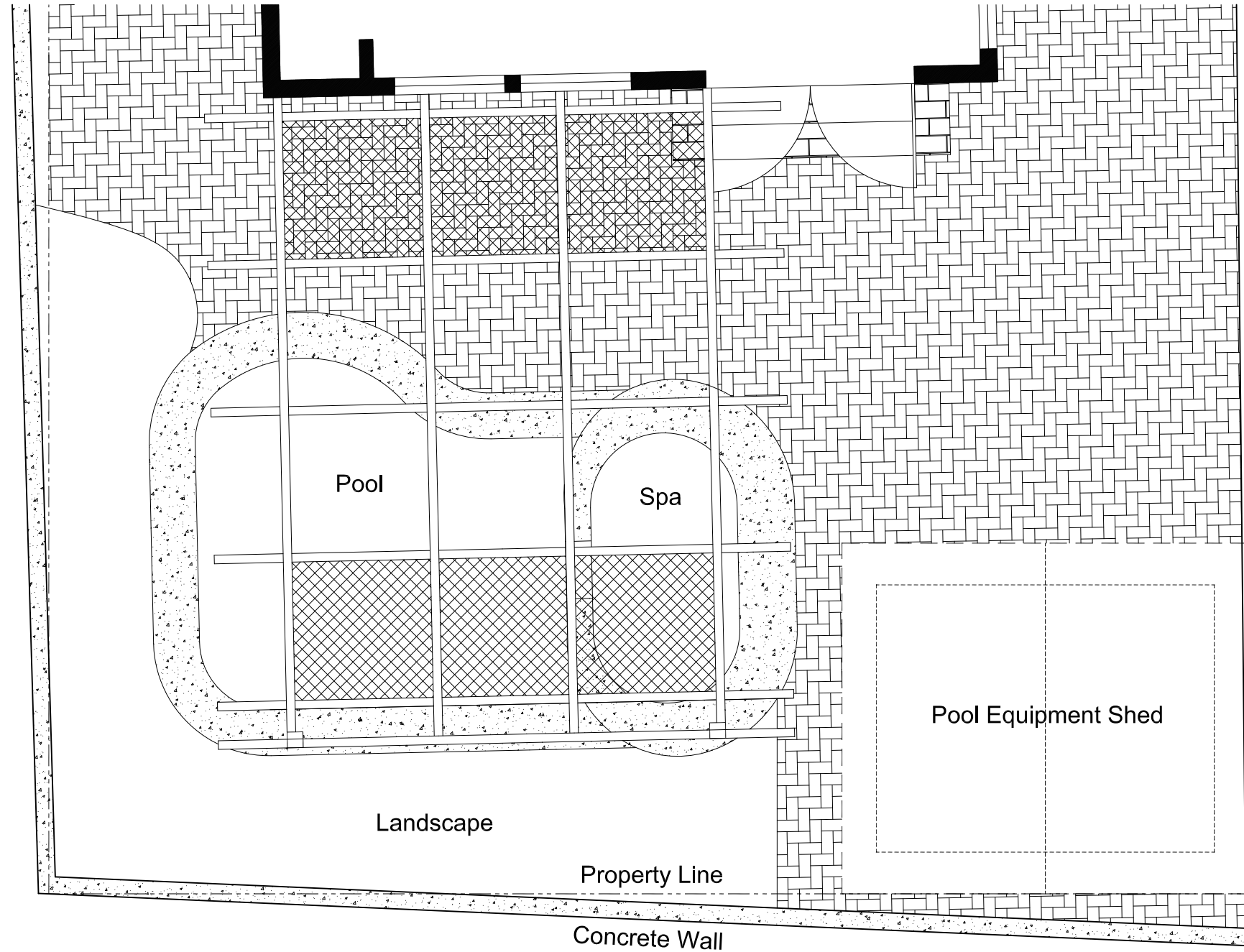

1
A-3

Existing Rear Yard

Scale: 1/4" = 1'-0"

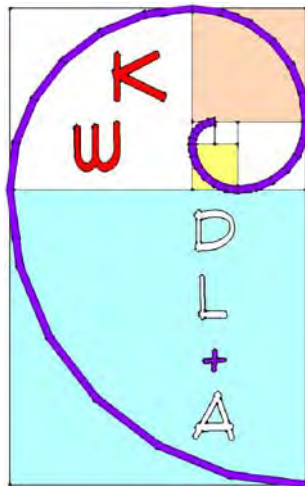

KEY WEST DESIGN LAB
+
ASSOCIATES, LLC
AA26002848
1901 FLAGLER AVENUE
KEY WEST, FL 33040
(305) 440-3960

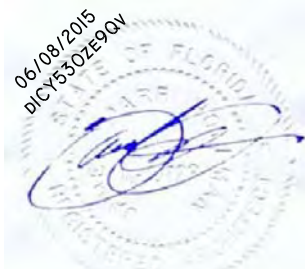

JAMES MARR HOFFMAN
AR 15,729 (615) 955-0975
AUBURNARCHITECT@GMAIL.COM

Exterior Improvements
Chris Belland
626 Grinnell St.
Key West, FL 33040

As-Built
Rear Yard

06/08/15

A-3

Sheet 11 of 19

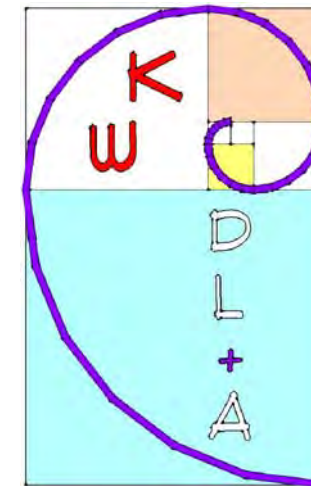
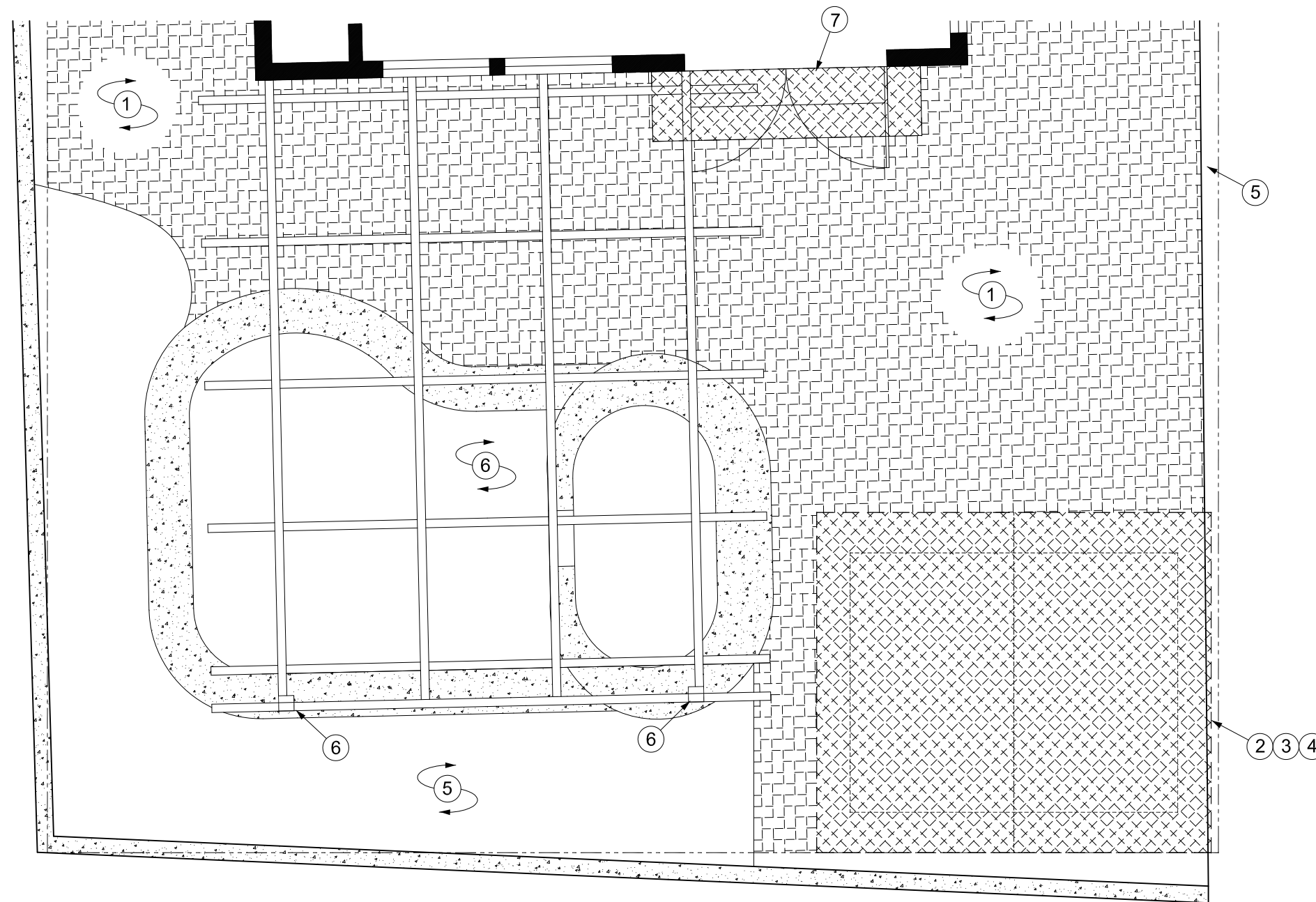

**KEY WEST DESIGN LAB
+
ASSOCIATES, LLC**
AA26002848
1901 FLAGLER AVENUE
KEY WEST, FL 33040
(305) 440-3960



JAMES MARR HOFFMAN
AR 15,729 (615) 955-0975
AUBURNARCHITECT@GMAIL.COM

**Exterior Renovations
Chris Belland
626 Grinnell St.
Key West, FL 33040**

1
A-3.1

Rear Yard Selective Demolition

Scale: 1/4" = 1'-0"

Notes / Scope of Work:

- (1) Remove of brick pavers from rear yard -
- (2) Remove of pool equipment from pool shed (Salvage Equipment) -
- (3) Remove pool shed -
- (4) Remove concrete slab in shed area -
- (5) Remove landscaping -
- (6) Selectively remove existing damaged trellis materials (Parts of the existing trellis shall remain) -
- (7) Remove Stair -

Rear Yard Selective Demolition

06/08/15

A-3.1

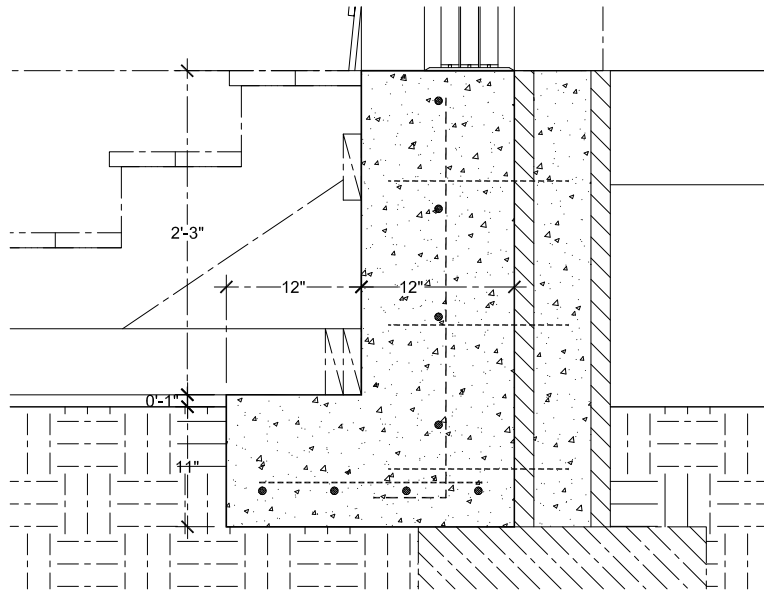

A Stem Wall & Footing

A-3.2 Scale: 3/4" = 1'-0"

Notes:

- (1) Provide 12x39 Stem Wall with integral 24x12 Footing - Provide 4,000psi Regular Concrete - Provide #5 @ 8"oc both ways in Stem Wall, Provide 6" hook on vertical bars in Stem Wall, Provide 15" #4 dowels embedded 4" in existing block 12" oc vertical & 24"oc horizontal - Remove face of block at top course and fill cells solid or epoxy set dowels in existing wall if cells are filled and embed a minimum of 4" - Provide 12x24 footing w/ 4,000psi Regular Concrete and #5 @ 6"oc in both directions -

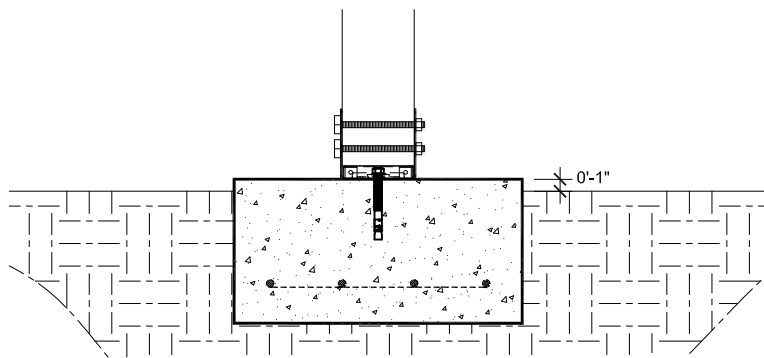

B Trellis Spot Footer

A-3.2 Scale: 3/4" = 1'-0"

Notes:

- (1) Provide 24x24x12 Spot Footing - Provide 4,000psi Regular Concrete - Provide #5 @ 6" Both Ways -
- (2) Provide Simpson CB66 post base for new PT6x6 - Anchor Simpson CB66 with 5/8" x 6" wedge anchor or equivalent threaded rod epoxy set -
- (3) Provide new PT 6x6 post with (2) 5/8" thru bolt assemblies -

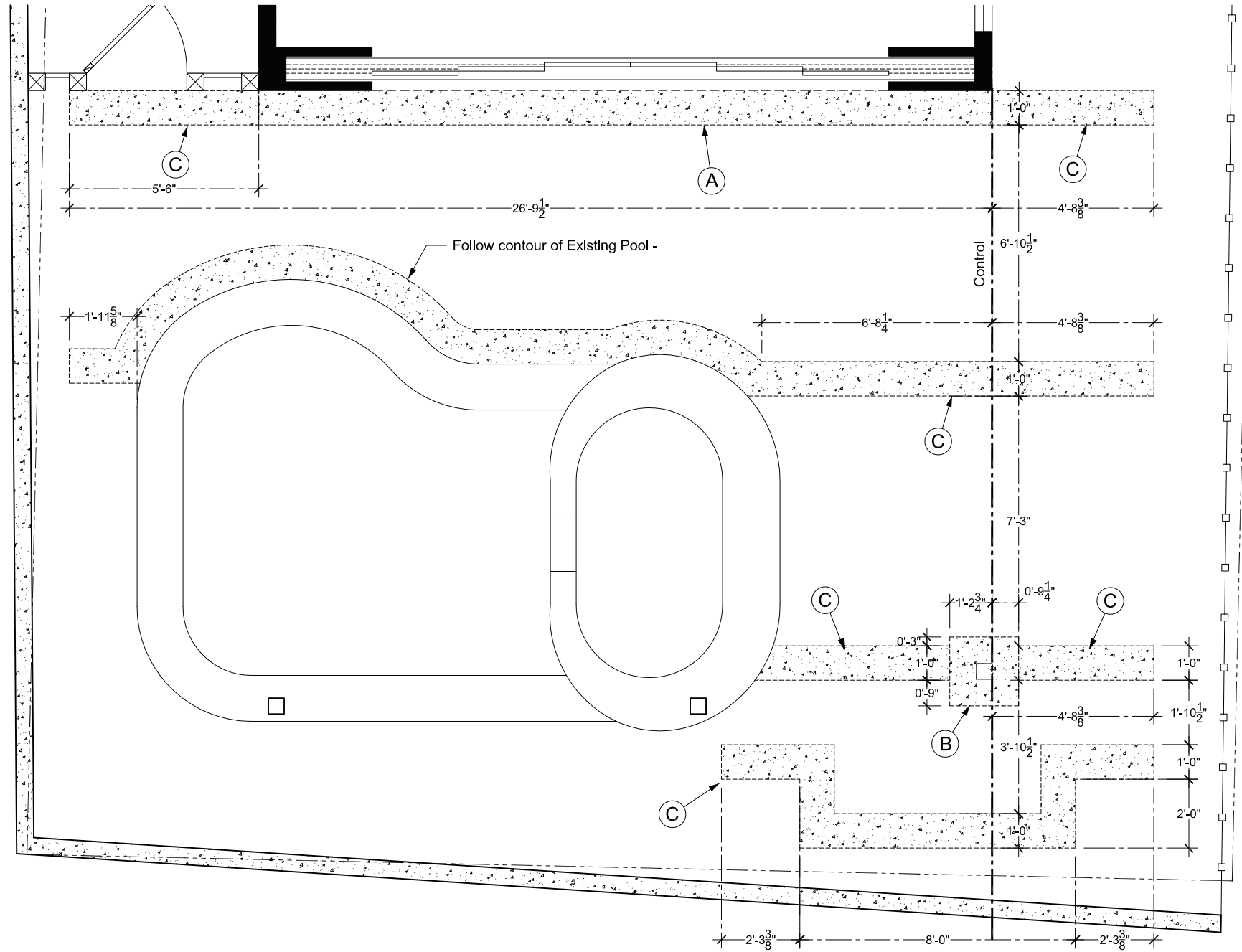

1 Proposed Rear Deck Foundation

A-3.2 Scale: 1/4" = 1'-0"

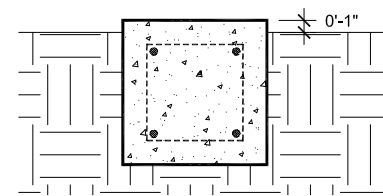

C Typical Deck Grade Beam

A-3.2 Scale: 1" = 1'-0"

Notes:

- (1) Provide 12x12 Grade Beam as shown - Provide 4,000 psi Regular Concrete - Provide (4)#5 & 8x8 hoops @ 6" o.c. - Provide 30" laps each way @ each bar @ corners & other locations where bars are not continuous -

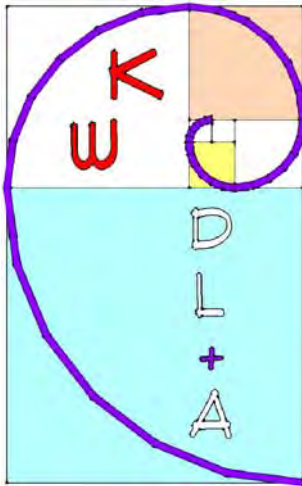

**KEY WEST DESIGN LAB
+
ASSOCIATES, LLC**
AA26002848
1901 FLAGLER AVENUE
KEY WEST, FL 33040
(305) 440-3960

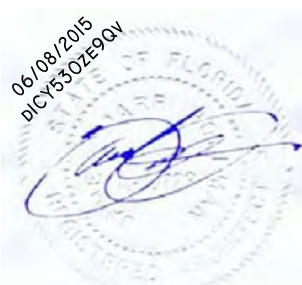

JAMES MARR HOFFMAN
AR 15,729 (615) 955-0975
AUBURNARCHITECT@GMAIL.COM

Exterior Improvements
Chris Belland
626 Grinnell St.
Key West, FL 33040

Proposed Rear Deck Foundation

06/08/2015

A-3.2

Sheet 13 of 19

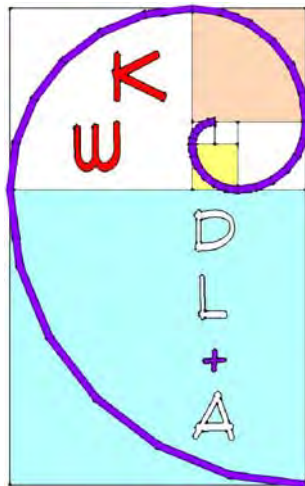

**KEY WEST DESIGN LAB
+
ASSOCIATES, LLC**
AA26002848
1901 FLAGLER AVENUE
KEY WEST, FL 33040
(305) 440-3960



JAMES MARR HOFFMAN
AR 15,729 (615) 955-0975
AUBURNARCHITECT@GMAIL.COM

Exterior Improvements
Chris Belland
626 Grinnell St.
Key West, FL 33040

Proposed Deck Framing Plan

06/08/15

A-3.3

Sheet 14 of 19

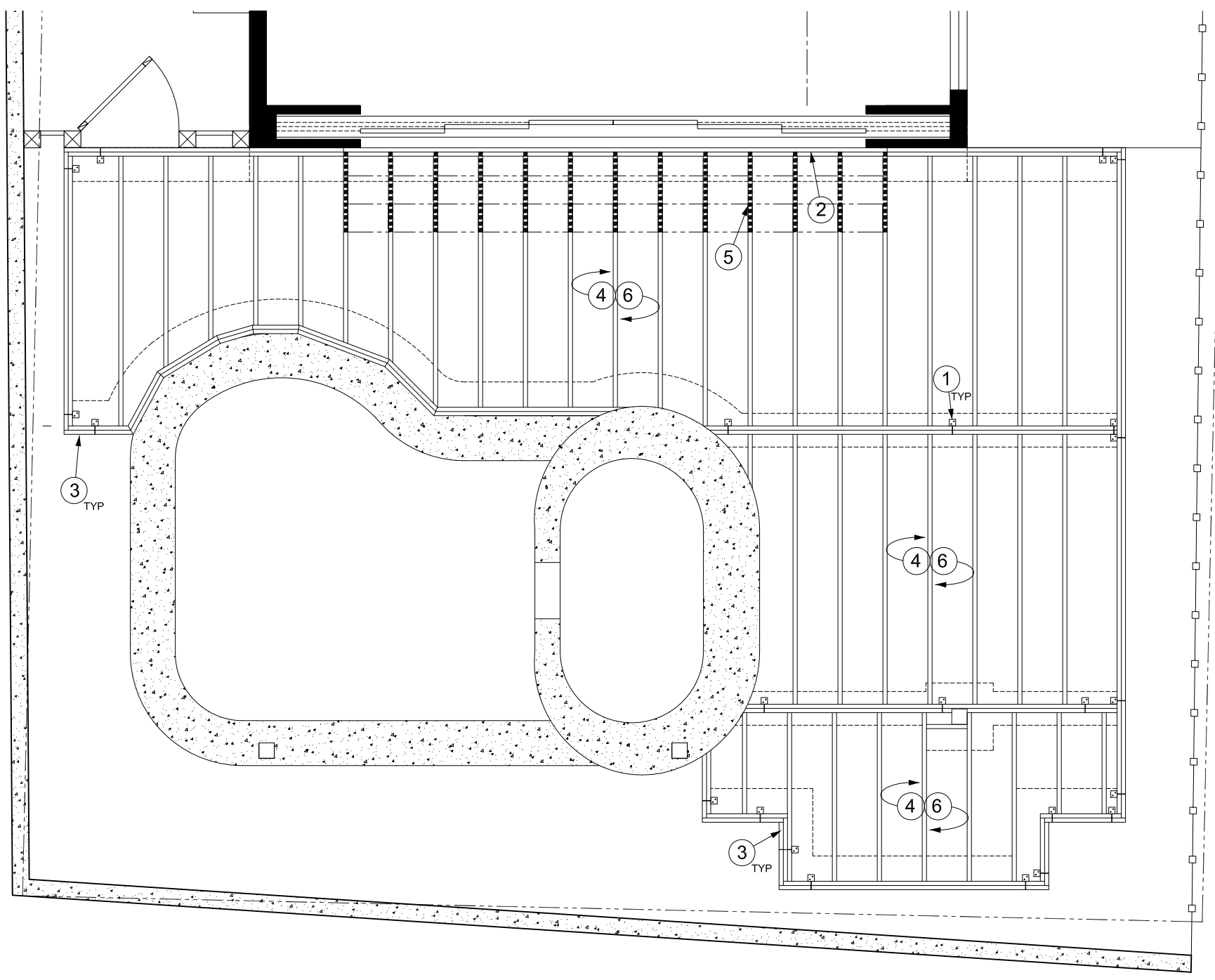

Notes/Scope of Work:

- (1) Provide appropriate *Simpson* hardware cast in concrete to anchor outer rim joists and beams - See *Simpson* Schedule on sheet (G-3) - Or, 4x4x4x1/4" Galv clip angles w/ (2) 5/8" threaded rod epoxy set in concrete, embed minimum of 4" & (2) 5/8" thru bolt assemblies thru beams - Anchorage at beam ends & intersections & @ 2'-8"oc with embedded straps or 8'-0"oc with clip angles -
- (2) Provide PT 2x6 ledger board against concrete stem wall for stair bearing & attach with 1/4" *Redheads* @ 8"oc staggered - Double Pt 2x6 ledger below for deck joist w/ same attachment -
- (3) Provide double PT 2x6 outer rim joists around deck perimeter - Wrap rim joist around pool edge and attach to pool wall w/ 1/4" *Redheads* @ 8"oc staggered -
- (4) Provide PT 2x6 deck joist @ 16"o.c. anchored to rim joists with *Simpson* LUS26 hangers -
- (5) Provide PT 2x stringers for three steps from house to deck - Provide risers no more than 7" and 11" treads - Provide appropriate *Simpson* hangers to ledger and *Simpson* straps to deck framing - See *Simpson* schedule sheet (G-3) -
- (6) Provide PT 5/4 decking over deck joist -

1 Proposed Deck Framing Plan
A-3.3

Scale: 1/4" = 1'-0"

Notes/Scope of Work:

- (1) Provide new PT 6x6 post -
- (2) Modify existing 6x6 posts with lap joints as required to remove damaged material (See lap detail (3/A-3.5))
- (3) Provide PT 3x12 beam (See connection detail (5/A-3.5))
- (4) Provide PT 3x12 rafters 24" o.c. with rafter tail (see (6/3.5))
- (5) Provide PT 4x4 purlins every 24"oc with decorative ends (See (4/A-3.5))
- (6) Existing Trellis elements to remain -

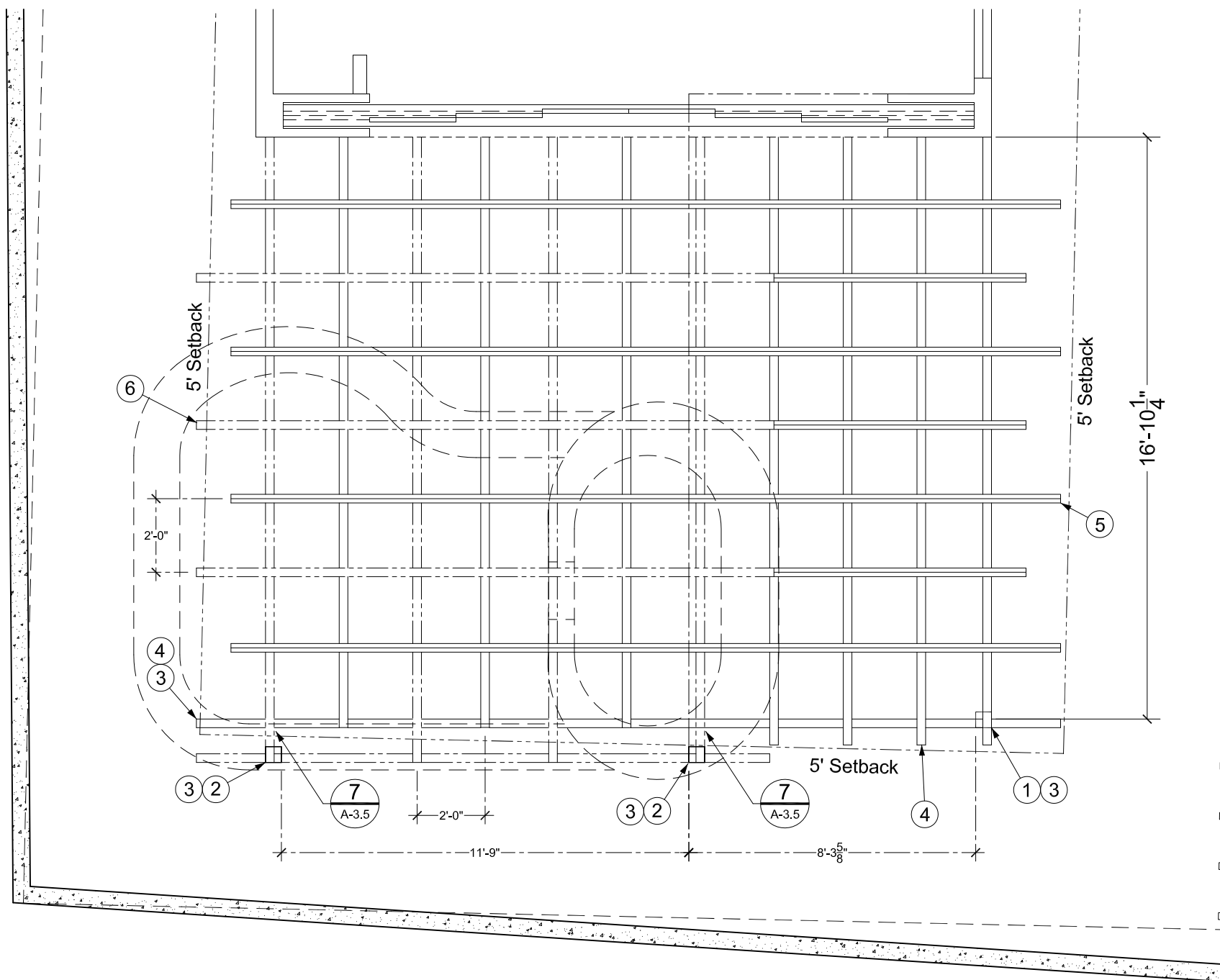

1
A-3.4

Proposed Trellis Plan

Scale: 1/4" = 1'-0"

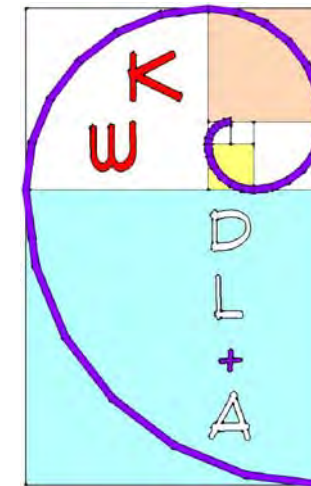

**KEY WEST DESIGN LAB
+
ASSOCIATES, LLC**
AA26002848
1901 FLAGLER AVENUE
KEY WEST, FL 33040
(305) 440-3960



JAMES MARR HOFFMAN
AR 15,729 (615) 955-0975
AUBURNARCHITECT@GMAIL.COM

Exterior Improvements
Chris Belland
626 Grinnell St.
Key West, FL 33040

Proposed Trellis

06/08/15

Notes/Scope of Work:

- (1) Provide new PT 6x6 post -
- (2) Modify existing 6x6 posts with lap joints as required to remove damaged material (See lap detail (3/A-3.5))
- (3) Provide PT 3x12 beam (See connection detail (5/A-3.5))
- (4) Provide PT 3x12 rafters 24" o.c. with rafter tail (see (6/3.5))
- (5) Provide PT 4x4 purlins every 24"oc with decorative ends (See (4/A-3.5))

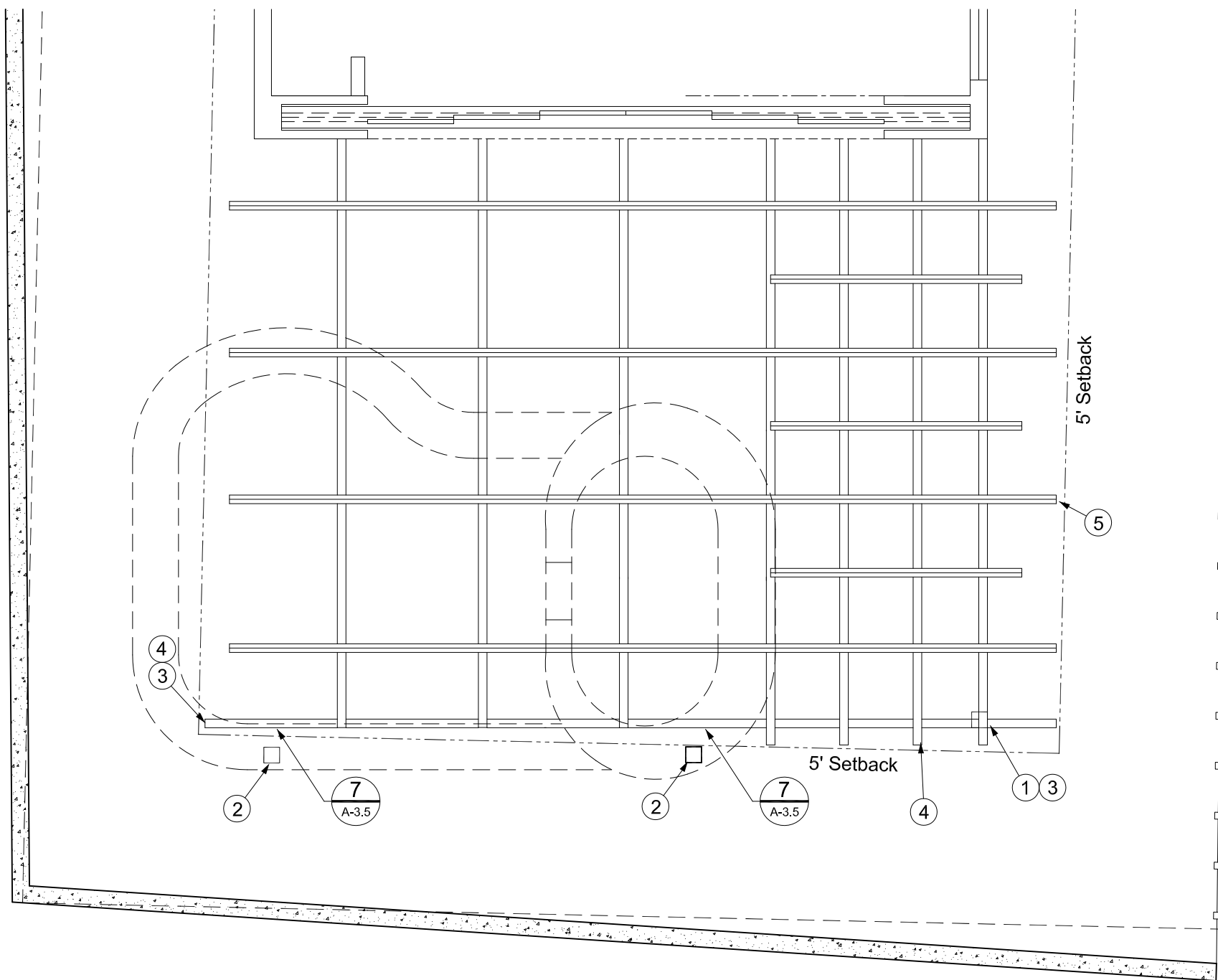

1
A-3.4

Proposed Trellis Plan

Scale: 1/4" = 1'-0"

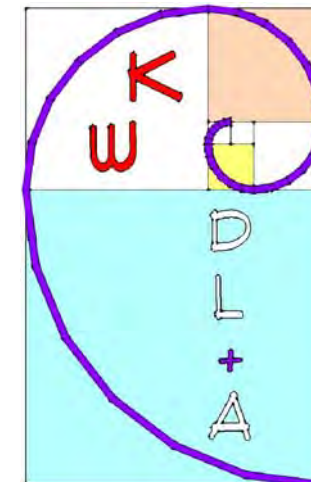

**KEY WEST DESIGN LAB
+
ASSOCIATES, LLC**
AA26002848
1901 FLAGLER AVENUE
KEY WEST, FL 33040
(305) 440-3960

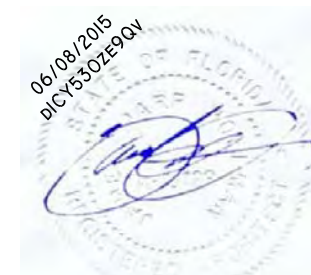

JAMES MARR HOFFMAN
AR 15,729 (615) 955-0975
AUBURNARCHITECT@GMAIL.COM

Exterior Improvements
Chris Belland
626 Grinnell St.
Key West, FL 33040

Proposed Trellis
(see original for existing
and proposed final)

07/17/15
Rev 1

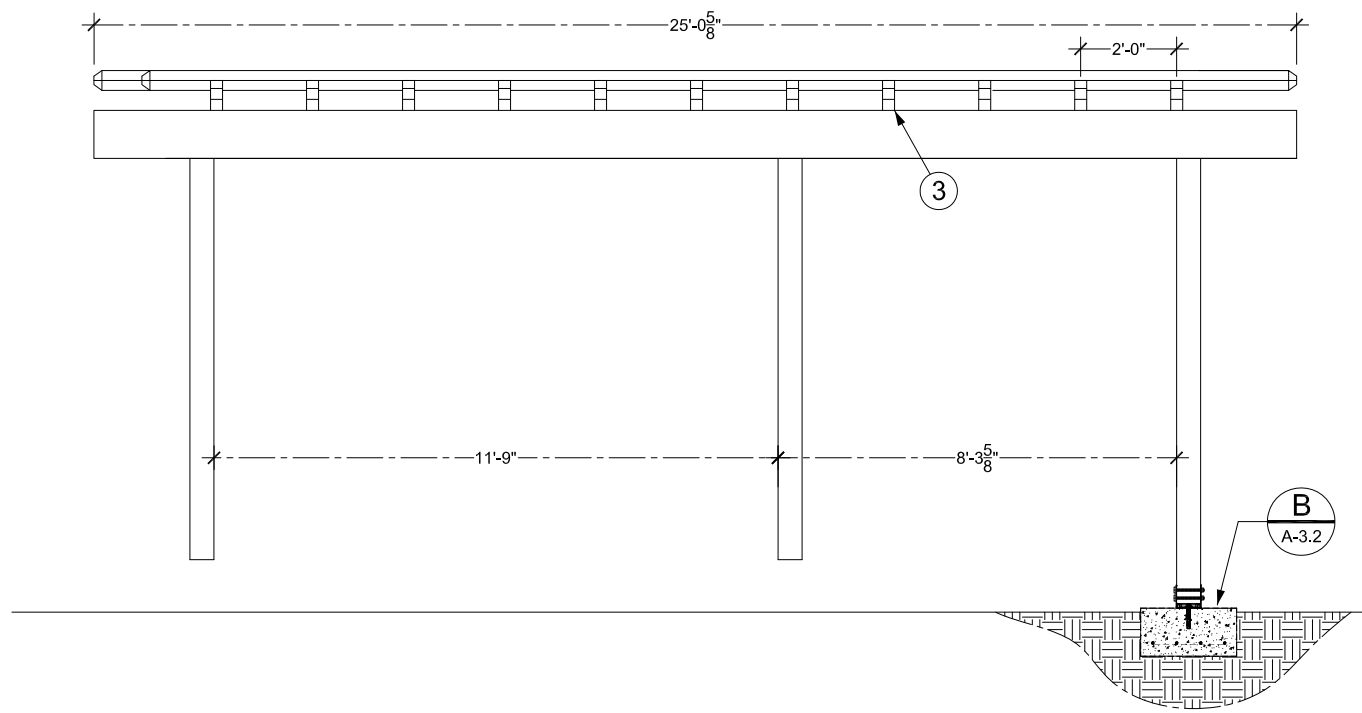

1 Proposed Southwest Elevation
 A-3.5 Scale: 1/4" = 1'-0"

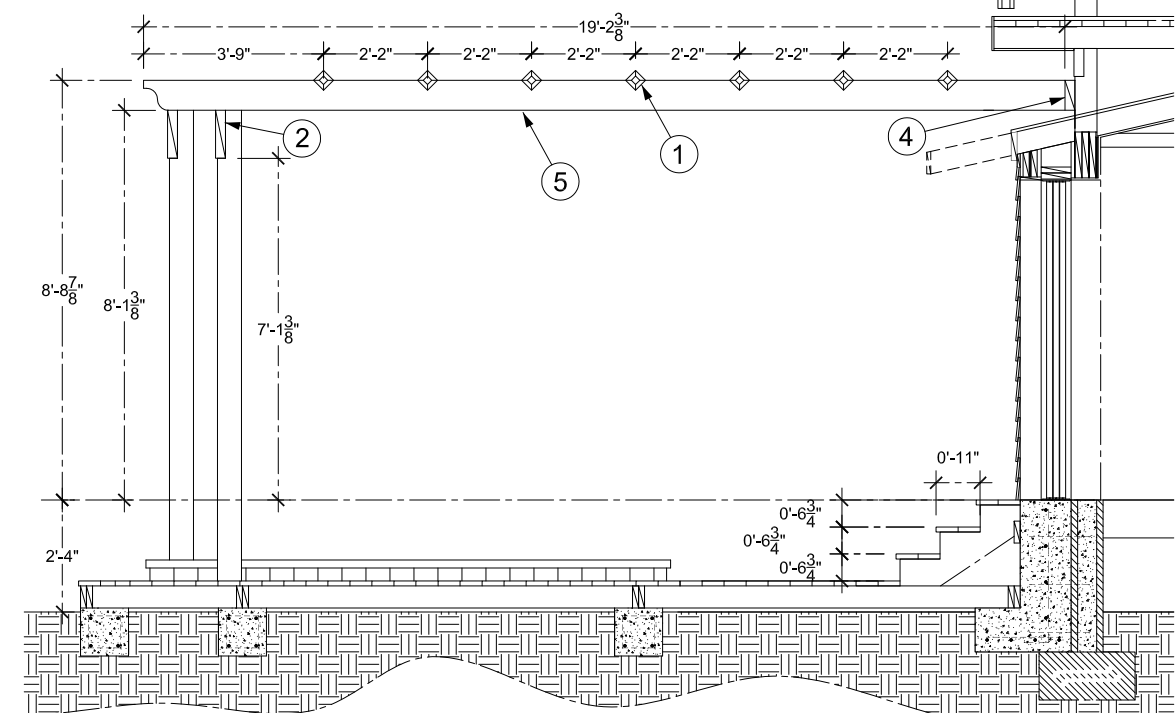

2 Proposed Southeast Elevation
 A-3.5 Scale: 1/4" = 1'-0"

Notes/Scope of Work:

- (1) Anchor PT 4x4 purlins w/ 6" Timber Tech's (TYP) -
- (2) Provide PT 3x12 w/ (2) 5/8" thru bolt assemblies thru beam and post top (TYP) See (5/A-3.5)
- (3) Provide Simpson H2.5A both sides of rafter at rear beam -
- (4) Provide PT 3x8 Ledger w/ (2) 5/8" x 6" Galv Lag Bolts to Existing Posts -
- (5) Provide PT 3x8 Rafters - Provide appropriate Simpson hangers at ledger w/ reverse flanges -
- (6) Provide PT 6"x8"x18" Brace w/ (3) galv 5/8" thru bolt assemblies -

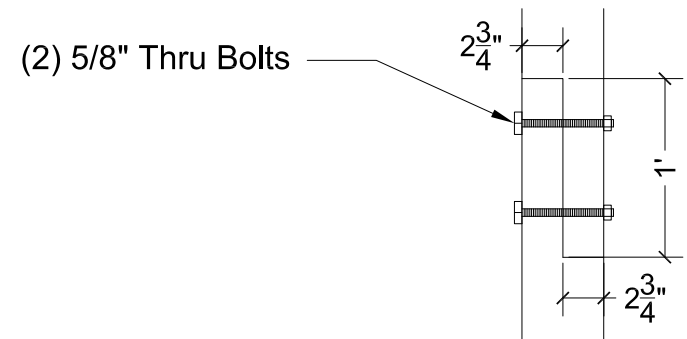

3 Typ. Lap Joint
 A-3.5 Scale: 1 1/2" = 1'-0"

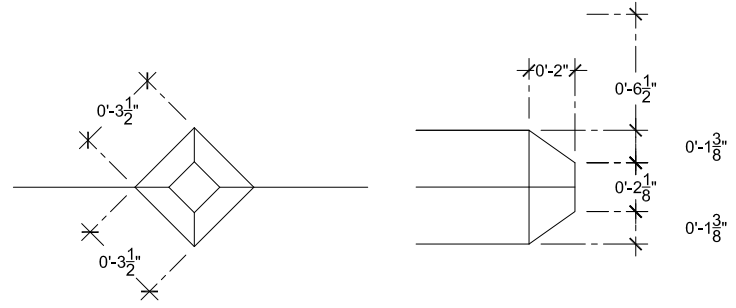

4 Typical Purlin End Detail
 A-3.5 Scale: 1 1/2" = 1'-0"

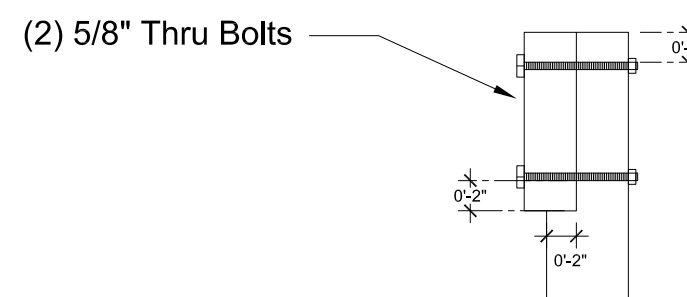

5 Typ. Bm/Post
 A-3.5 Scale: 1 1/2" = 1'-0"

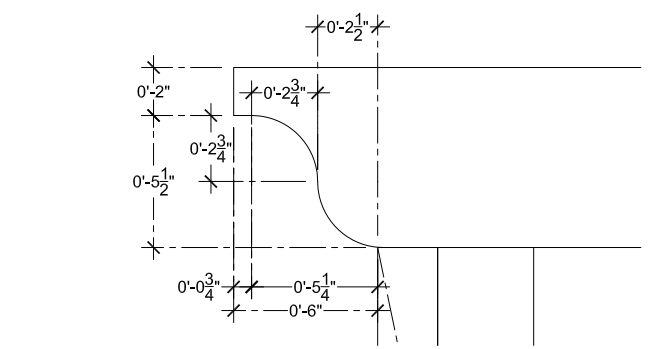

6 Typical Rafter Tail Detail
 A-3.5 Scale: N.T.S.

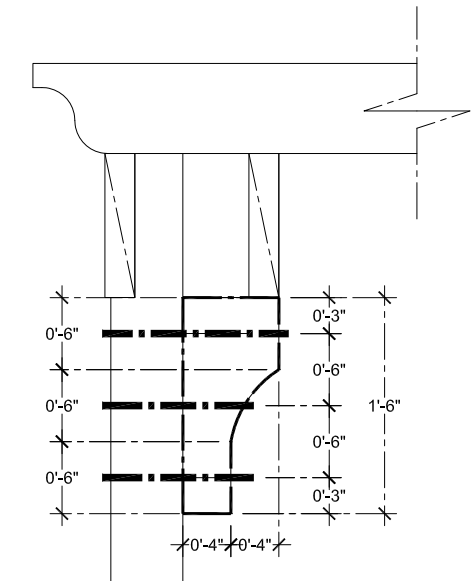

7 Trellis Brace
 A-3.5 Scale: 3/4" = 1'-0"

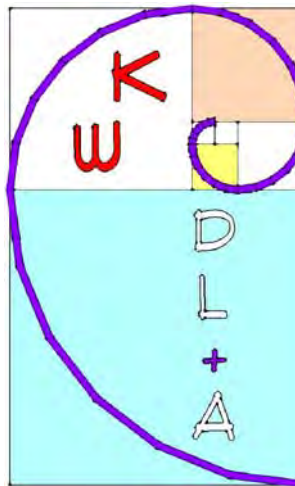

**KEY WEST DESIGN LAB
 +
 ASSOCIATES, LLC**
 AA26002848
 1901 FLAGLER AVENUE
 KEY WEST, FL 33040
 (305) 440-3960

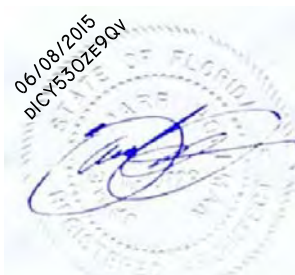

JAMES MARR HOFFMAN
 AR 15,729 (615) 955-0975
 AUBURNARCHITECT@GMAIL.COM

ONE CALL CONSTRUCTION, INC.
One Call Does It All!

Exterior Improvements
 Chris Belland
 626 Grinnell St.
 Key West, FL 33040

Proposed Trellis
 & Details
 06/08/15

A-3.5

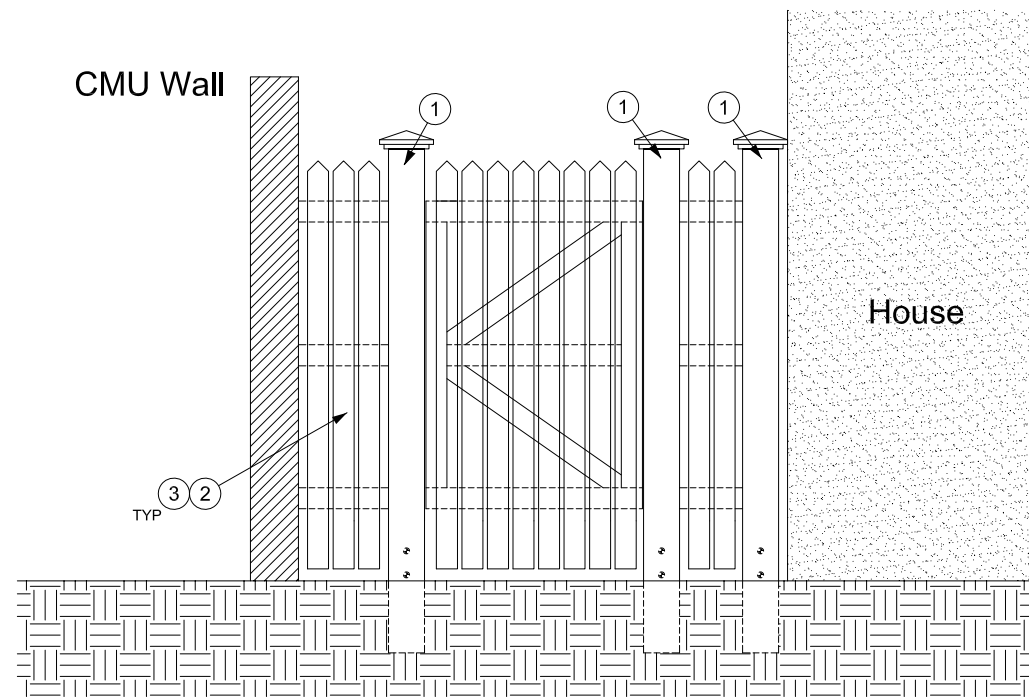

1
A-3.6

Gate Elevation

Scale: 3/8" = 1'-0"

Notes/Scope of Work:

- (1) Provide PT 6x6 posts - Anchor posts to decking rim joist w/ (2) galv 5/8" thru bolt assemblies - Drive post 12" deep - Provide PT blocking as required at house and CMU wall -
- (2) Provide fencing sections and gates to match existing fencing and gate system -
- (3) PT 2x4 runners and cross bracing, inset runners into back of posts - Provide PT 1x4 pickets to match existing -
- (4) Provide Sherman Williams Prep Right primer - Apply (2) coats Sherman Williams Duration gloss white -

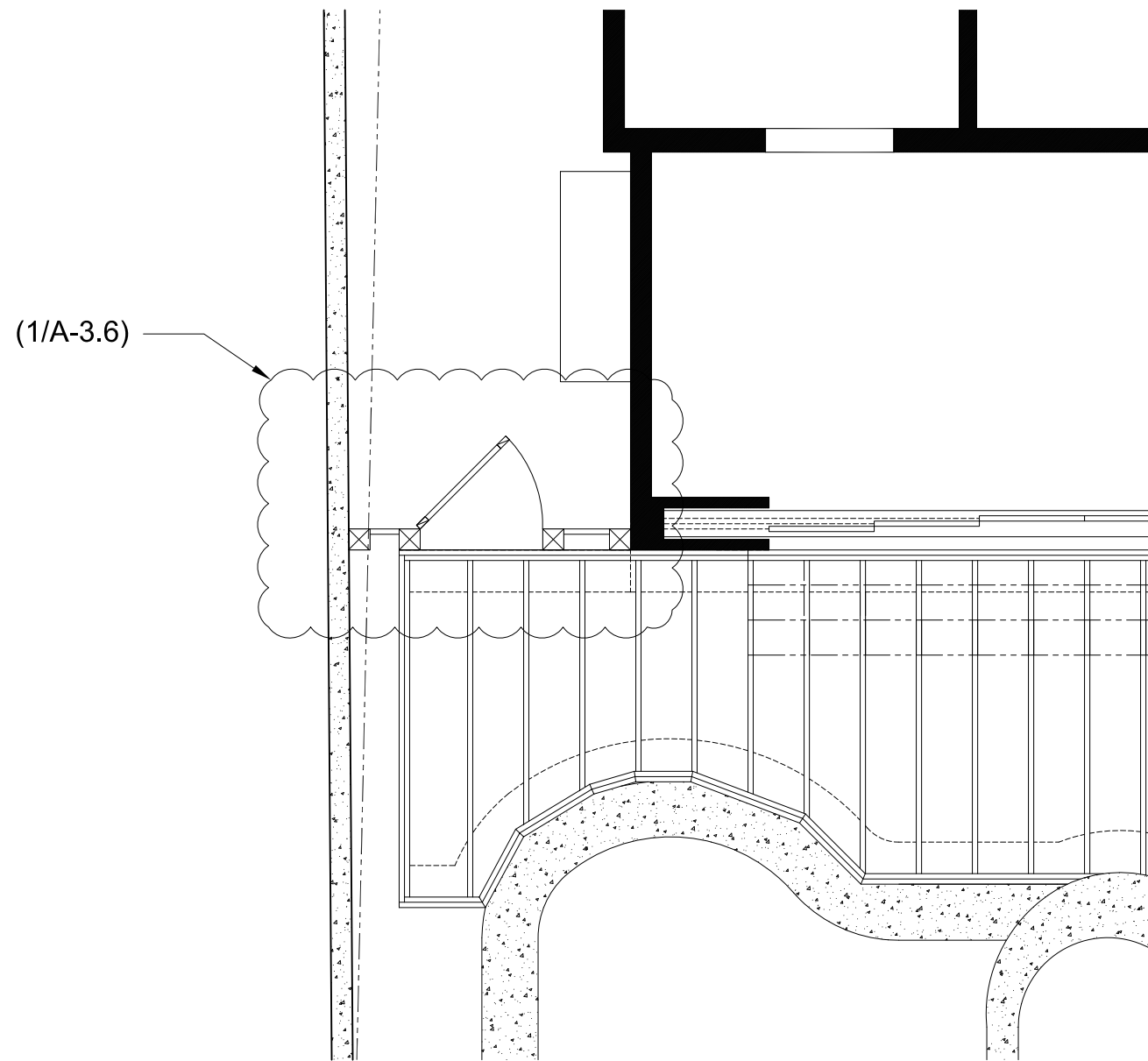

2
A-3.6

Gate Plan

Scale: 1/4" = 1'-0"

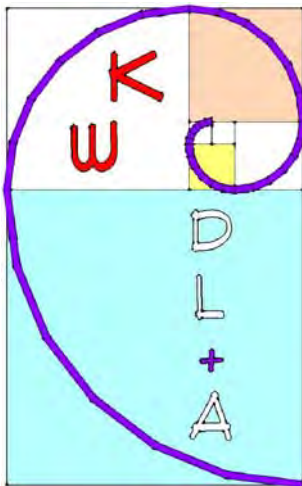

**KEY WEST DESIGN LAB
+
ASSOCIATES, LLC**
AA26002848
1901 FLAGLER AVENUE
KEY WEST, FL 33040
(305) 440-3960

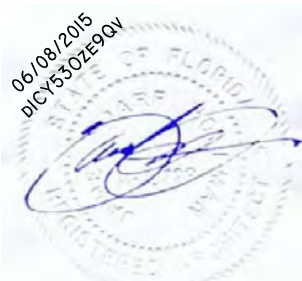

JAMES MARR HOFFMAN
AR 15,729 (615) 955-0975
AUBURNARCHITECT@GMAIL.COM

Exterior Improvements
Chris Belland
626 Grinnell St.
Key West, FL 33040

Gate Details

06/08/15

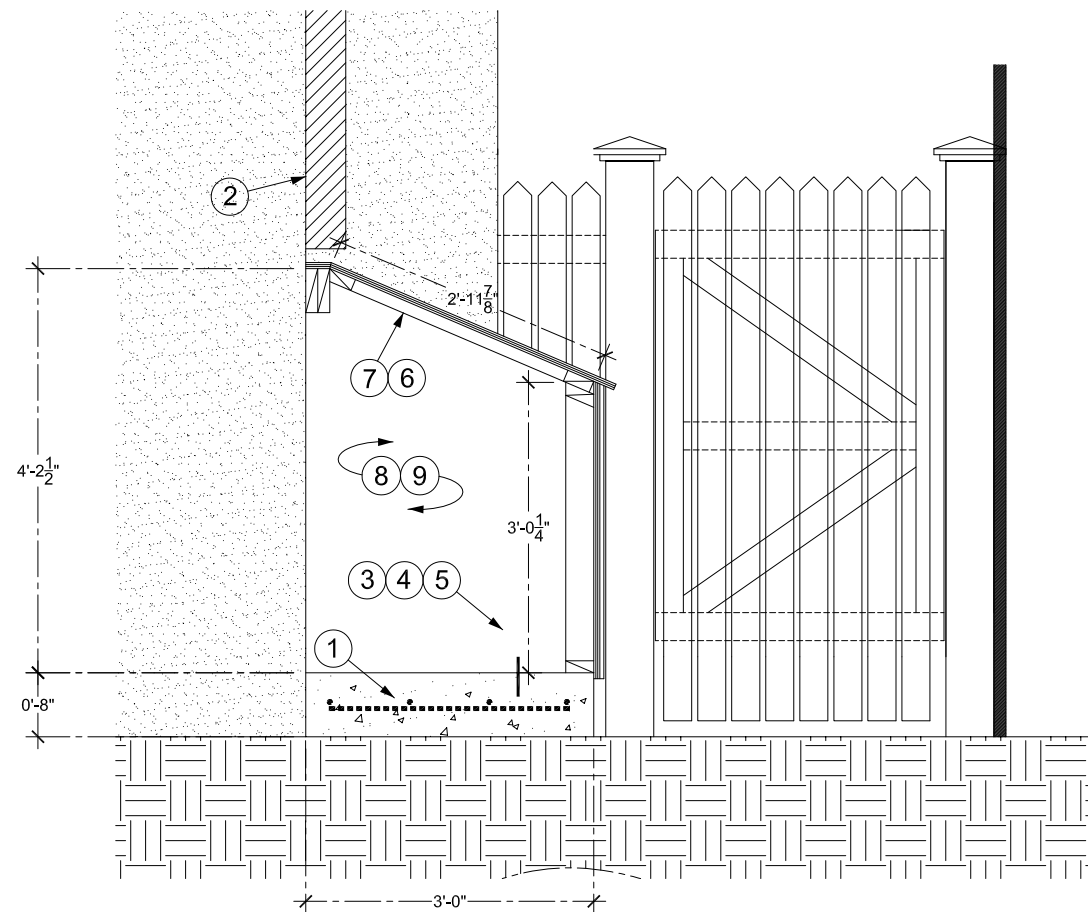

1 Pool Shed Section
A-3.7

Scale: 1/2" = 1'-0"

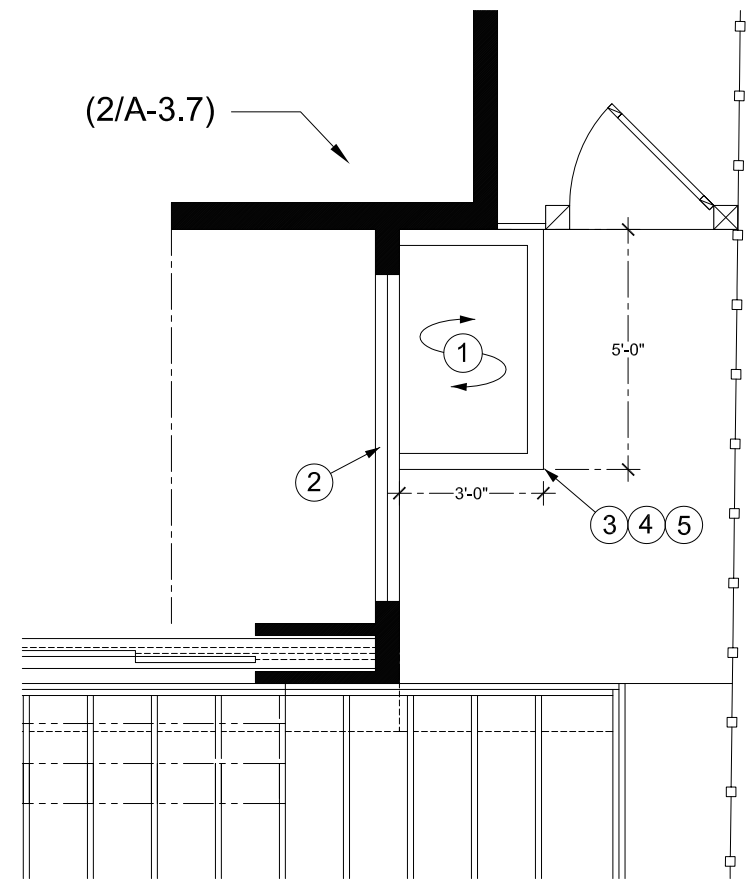

2 Pool Shed Plan
A-3.7

Scale: 1/4" = 1'-0"

Notes/Scope of Work:

- (1) Provide 3'x5'x8" concrete pad - Provide 4,000psi regular concrete - Provide #5 @ 8"oc both ways -
- (2) Pool Equipment Shed below existing window -
- (3) Provide PT 2x4 framing - Anchor to pad with appropriate Simpson hardware - See Schedule sheet (G-3) -
- (4) Provide 3/4" plywood sheathing on PT 2x4 framing - Provide 10d ring shank nails @ 4"oc around perimeters and 6" in the field -
- (5) Provide 1/2" x 6" PT siding over plywood -
- (6) Provide 3/4" plywood roof system hinged to PT2x6 blocking attached to the side of the house - Provide PT2x4 frame on the flat for roof/door frame - Shape edges as necessary as shown -
- (7) Provide galvanized aluminum roof -
- (8) Relocate existing pool equipment to new location -
- (9) Provide rough electrical and plumbing as necessary for salvaged equipment -

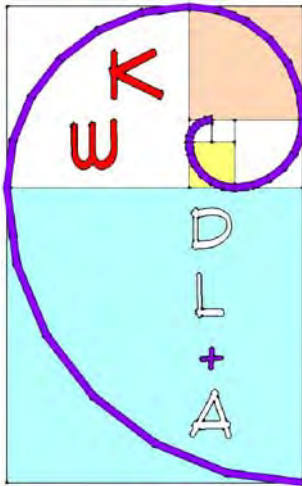

**KEY WEST DESIGN LAB
+
ASSOCIATES, LLC**
AA26002848
1901 FLAGLER AVENUE
KEY WEST, FL 33040
(305) 440-3960

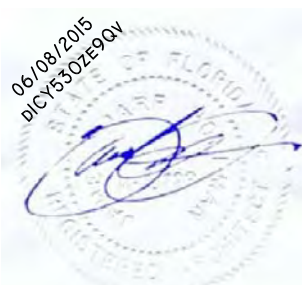

JAMES MARR HOFFMAN
AR 15,729 (615) 955-0975
AUBURNARCHITECT@GMAIL.COM

**Exterior Improvements
Chris Belland
626 Grinnell St.
Key West, FL 33040**

Proposed Pool
Equipment Shed

06/08/15

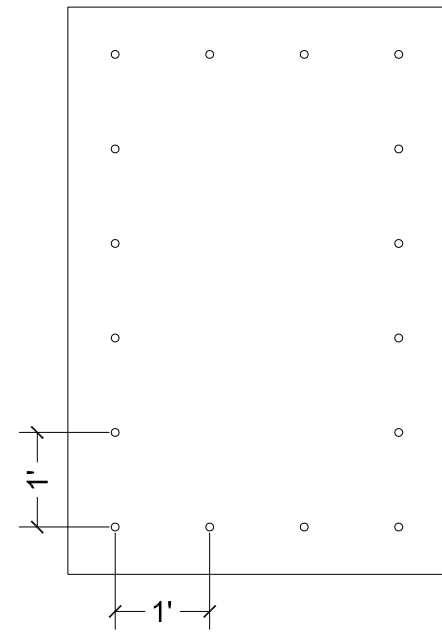

1
A-4 **Poly Carb Window Shutter**
Scale: 1/2" = 1'-0"

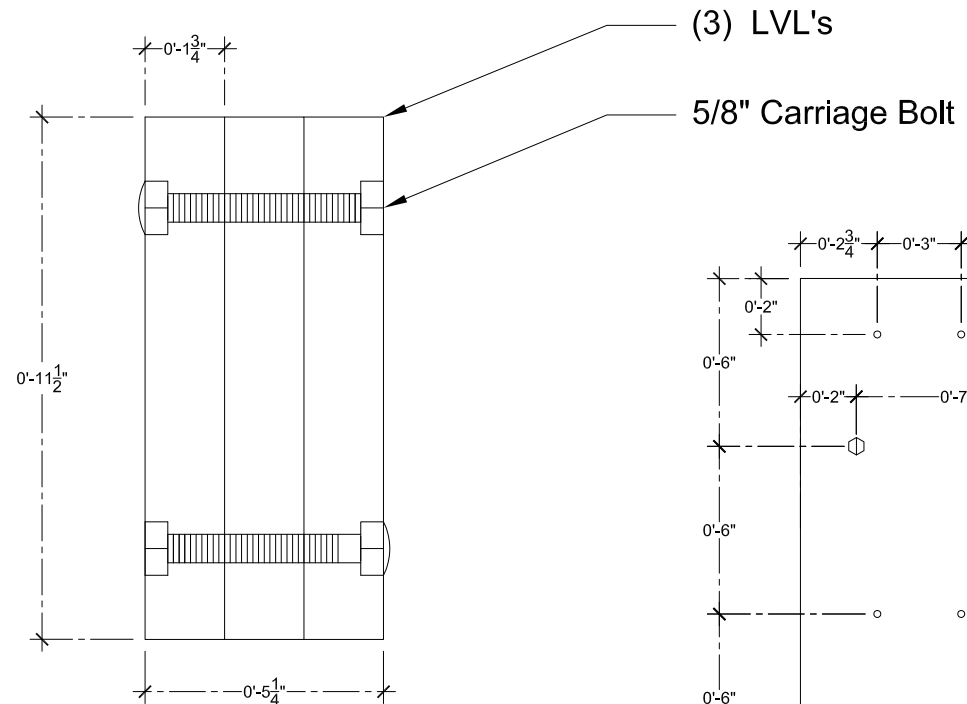

2
A-4 **Sliding Door Header**
Scale: 1/2" = 1'-0"

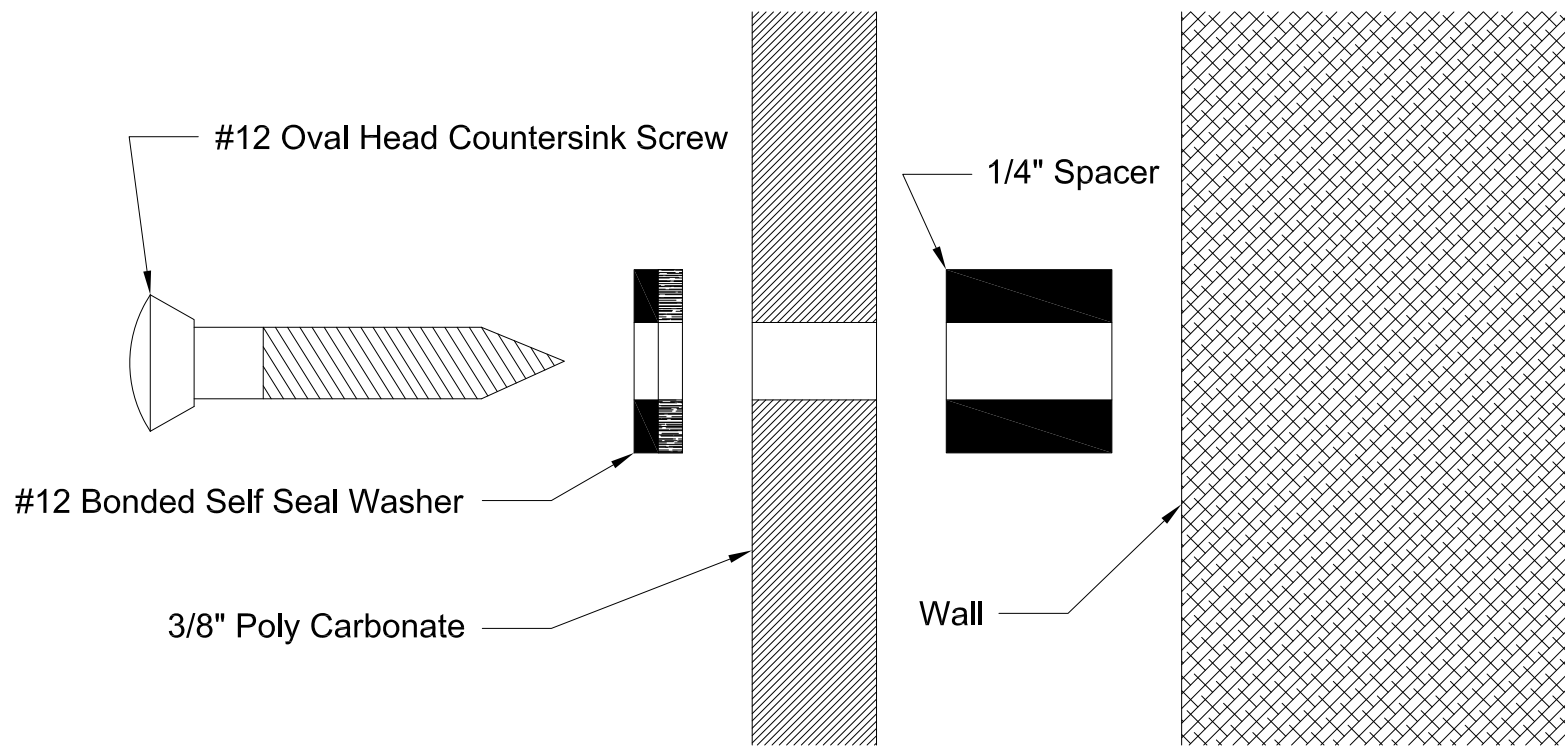

3
A-4 **Poly Carbonate Window Shutter Fastener Detail**
Scale: NTS

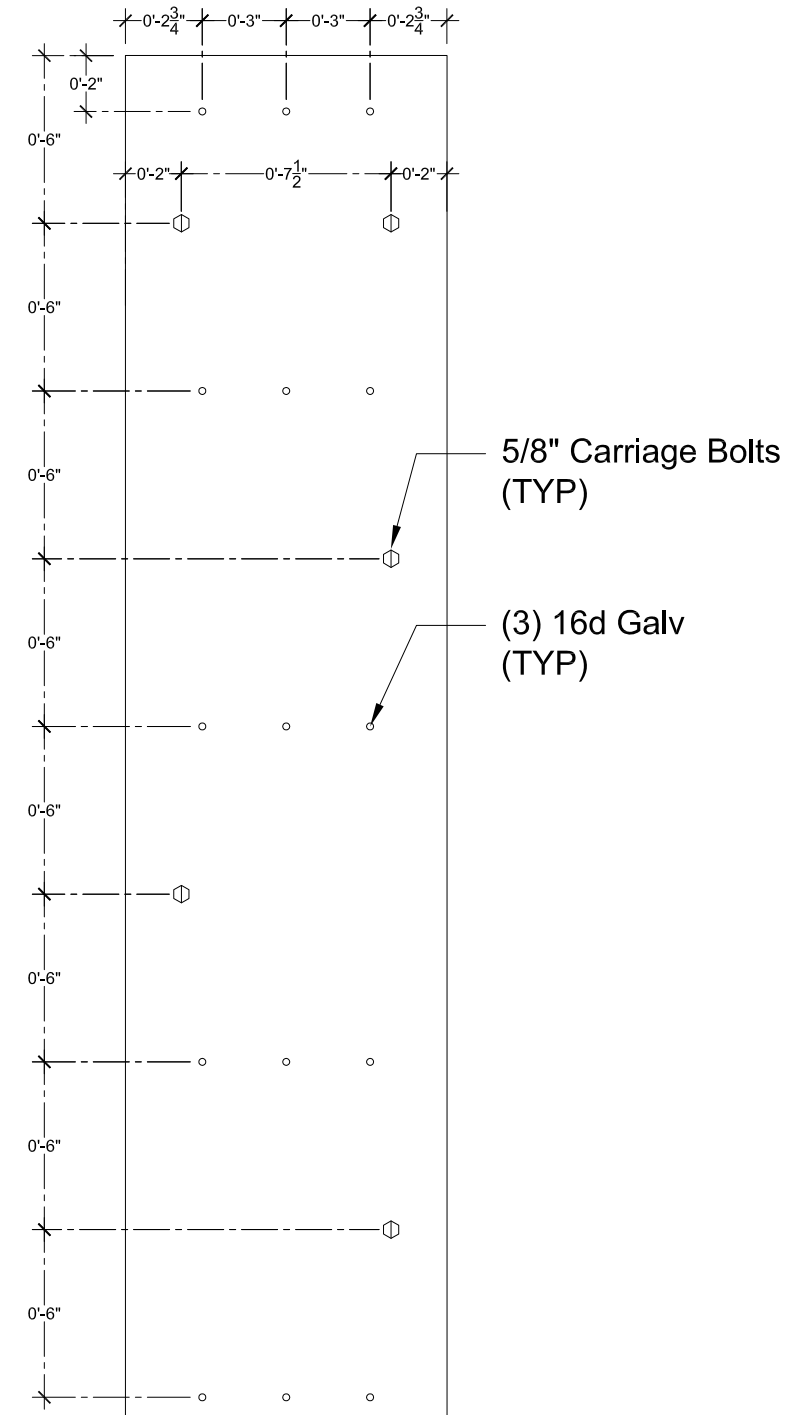

4
A-4 **Slider Header - Lam Detail**
Scale: 1/2" = 1'-0"

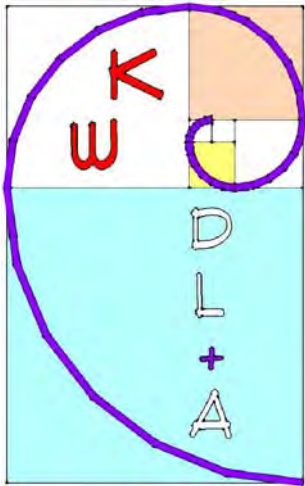

KEY WEST DESIGN LAB
+
ASSOCIATES, LLC
AA26002848
1901 FLAGLER AVENUE
KEY WEST, FL 33040
(305) 440-3960

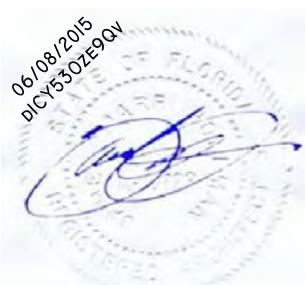

JAMES MARR HOFFMAN
AR 15,729 (615) 955-0975
AUBURNARCHITECT@GMAIL.COM

Exterior Improvement
Chris Belland
626 Grinnell St.
Key West, FL 33040

Details

06/08/15

A-4

Sheet 19 of 19

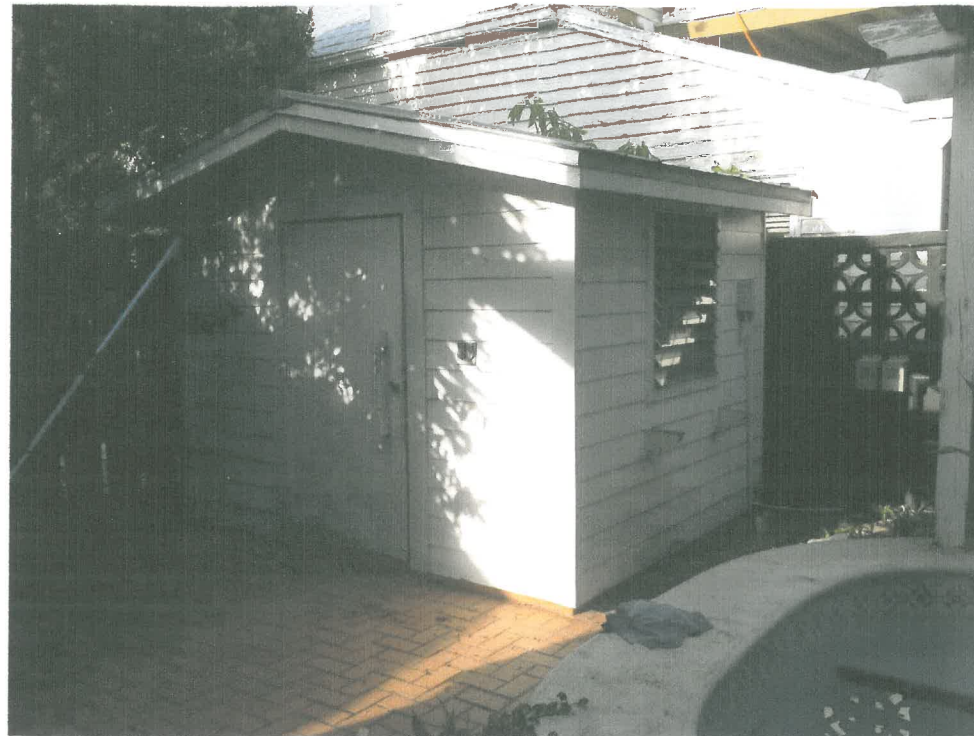

Notes/Scope of Work:

Removal pool shed

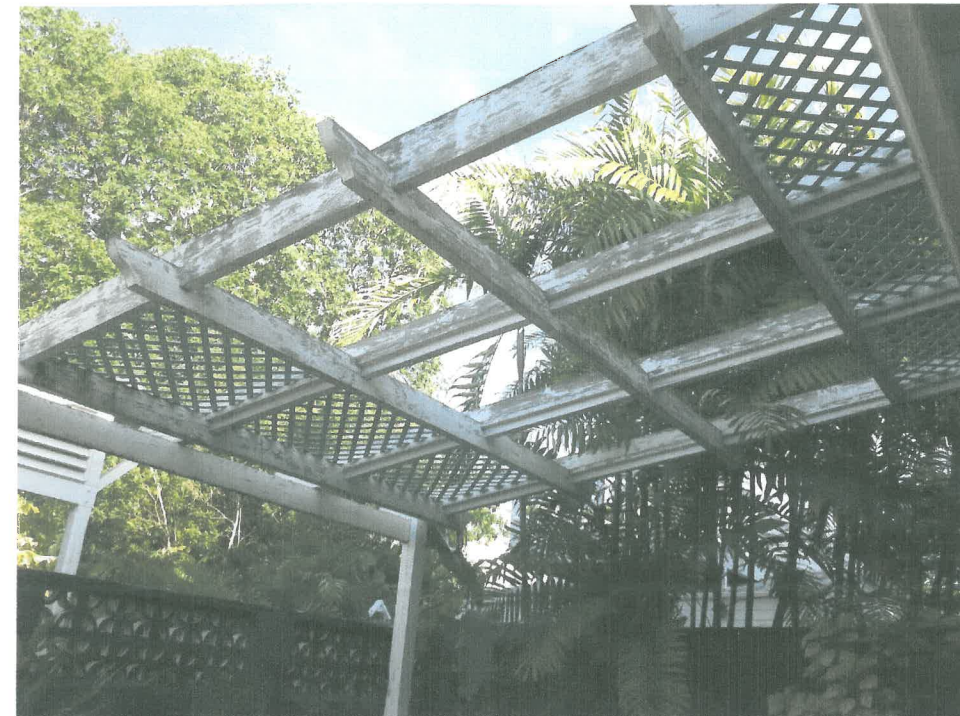

Notes/Scope of Work:

Removal of damages 6x6 posts and damaged trellis members



Notes/Scope of Work:

Removal of damaged trellis members and lattice



Notes/Scope of Work:

Example trellis - framing is identical as well as spacing of members
The ends of the framing members have the same decorative ending that we would like to use as well.

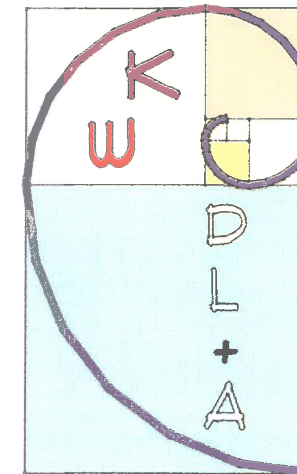

KEY WEST DESIGN LAB
+
ASSOCIATES, LLC
AA2600284.8
1901 FLAGLER AVENUE
KEY WEST, FL 33040
(305) 440-3960

JAMES MARR HOFFMAN
AR 15,729 (615) 955-0975
AUBURNARCHITECT@GMAIL.COM

Home Remodel
Chris Belland
626 Grinnell St.
Key West, FL 33040

Demolition Plan

4.03.15

A-6

Sheet 04 of 12

NOTICING

Public Meeting Notice

The Historic Architectural Review Commission will hold a public hearing at 5:30 p.m., July 28, 2015 at Old City Hall, 510 Greene Street, Key West, Florida. The purpose of the hearing will be to consider a request for:

**CONSTRUCTION OF NEW TRELLIS. DEMOLITION OF WOOD
FRAME SHED AND WOOD TRELLIS.**

FOR- #626 GRINNELL STREET

Applicant – One Call Construction

Application #H15-01-0958

If you wish to see the application or have any questions, you may visit the Planning Department during regular office hours at 3140 Flagler Avenue, call 305-809-3975 or visit our website at www.cityofkeywest-fl.gov.

THIS NOTICE CAN NOT BE REMOVED FROM THE SITE UNTIL HARC FINAL DETERMINATION

Public Meeting Notice

City of ...
Public Meeting Notice
Date: ...
Time: ...
Location: ...



HARC POSTING AFFIDAVIT

STATE OF FLORIDA:
COUNTY OF MONROE:

BEFORE ME, the undersigned authority, personally appeared David Poulriot, who, first being duly sworn, on oath, depose and says that the following statements are true and correct to the best of his/her knowledge and belief:

1. That a legal notice for Public Notice of Hearing of the Historic Architectural Review Commission (HARC) was placed on the following address: 626 Grinnell Street, Key West FL 33040 on the 22nd day of July, 2015.

This legal notice(s) contained an area of at least 8.5"x11".

The property was posted to notice a public hearing before the Key West Historic Architectural Review Commission to be held on July 28th, 2015.

The legal notice(s) is/are clearly visible from the public street adjacent to the property.

The Certificate of Appropriateness number for this legal notice is _____.

2. A photograph of that legal notice posted in the property is attached hereto.

Signed Name of Affiant: [Signature]

Date: 7/22/15

Address: 1901 Flagler Ave

City: Key West FL 33040

State, Zip: FL 33040

The forgoing instrument was acknowledged before me on this 22nd day of July, 2015.

By (Print name of Affiant) David Poulriot who is personally known to me or has produced _____ as identification and who did take an oath.

NOTARY PUBLIC

Sign Name: [Signature]

Print Name: Sherree Clark

Notary Public - State of Florida (seal)

My Commission Expires: 03/18

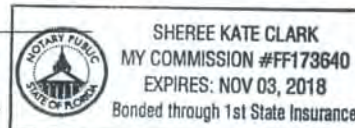

PROPERTY APPRAISER INFORMATION



Scott P. Russell, CFA
Property Appraiser
Monroe County, Florida

Key West (305) 292-3420
Marathon (305) 289-2550
Plantation Key (305) 852-7130

Property Record Card -

Maps are now launching the new map application version.

Alternate Key: 1011312 Parcel ID: 00011020-000000

Ownership Details

Mailing Address:

BELLAND CHRISTOPHER C
626 GRINNELL ST
KEY WEST, FL 33040-7177

All Owners:

BELLAND CHRISTOPHER C, SMITH PIPER L H/W

Property Details

PC Code: 01 - SINGLE FAMILY

Millage Group: 10KW

Affordable Housing: No

Section-

Township- 06-68-25

Range:

Property Location: 626 GRINNELL ST KEY WEST

Legal Description: KW PT LOT 1 SQR 57 H3-98 OR64-371/72 OR249-513/14 OR665-454-459 OR910-2477AFF OR1039-1062/1063P/R OR1747-2095/96 OR1747-2097/99 OR1747-2100/01 OR1747-2102/03 OR1747-2104/05 OR1747-2106/11E OR1987-1343/45R/S OR1987-1346/48 OR2731-1383/84

Click Map Image to open interactive viewer



Exemptions

Exemption	Amount
44 - ADDL HOMESTEAD	25,000.00
39 - 25000 HOMESTEAD	25,000.00

Land Details

Land Use Code	Frontage	Depth	Land Area
01SD - RES SUPERIOR DRY	0	0	3,456.00 SF

Building Summary

Number of Buildings: 1
 Number of Commercial Buildings: 0
 Total Living Area: 2529
 Year Built: 1908

Building 1 Details

Building Type R1 Condition A Quality Grade 600
 Effective Age 15 Perimeter 324 Depreciation % 16
 Year Built 1908 Special Arch 0 Grnd Floor Area 2,529
 Functional Obs 0 Economic Obs 0

Inclusions: R1 includes 1 3-fixture bath and 1 kitchen.
 Roof Type IRR/CUSTOM Roof Cover METAL Foundation WD CONC PADS
 Heat 1 FCD/AIR DUCTED Heat 2 NONE Bedrooms 2
 Heat Src 1 ELECTRIC Heat Src 2 NONE

Extra Features:

2 Fix Bath	0	Vacuum	0
3 Fix Bath	2	Garbage Disposal	0
4 Fix Bath	0	Compactor	0
5 Fix Bath	0	Security	0
6 Fix Bath	0	Intercom	0
7 Fix Bath	0	Fireplaces	0
Extra Fix	0	Dishwasher	0



Sections:

Nbr	Type	Ext Wall	# Stories	Year Built	Attic A/C	Basement %	Finished Basement %	Area
1	<u>FLA</u>	12:ABOVE AVERAGE WOOD	1	1989	N Y	0.00	0.00	1,563

2	<u>OPX</u>		1	1989		0.00	0.00	276
3	<u>PTO</u>		1	2002		0.00	0.00	504
4	<u>FLA</u>	12:ABOVE AVERAGE WOOD	1	1989	N Y	0.00	0.00	966
5	<u>FHS</u>	12:ABOVE AVERAGE WOOD	1	1989	N Y	0.00	0.00	399
6	<u>OPX</u>		1	2002		0.00	0.00	198
7	<u>DUF</u>	1:WD FRAME	1	1989	N N	0.00	0.00	80
8	<u>OPX</u>		1	1989		0.00	0.00	66

Misc Improvement Details

Nbr	Type	# Units	Length	Width	Year Built	Roll Year	Grade	Life
1	FN2:FENCES	273 SF	39	7	1986	1987	2	30
3	FN2:FENCES	390 SF	65	6	1979	1980	4	30
6	FN2:FENCES	140 SF	35	4	1988	1989	2	30
7	PT5:TILE PATIO	24 SF	0	0	2002	2003	4	50
8	PT5:TILE PATIO	42 SF	0	0	2002	2003	1	50
9	PO4:RES POOL	128 SF	16	8	2002	2003	5	50
10	HT2:HOT TUB	1 UT	0	0	2002	2003	2	50

Appraiser Notes

2013-11-25 MLS \$1,379,000 2/3 VERY MOTIVATED SELLER; OFFERS ENCOURAGED. GRACIOUS HOME WITH LARGE, COMFORTABLE LIVING AREAS HIDDEN BEHIND THE FACADE OF A CONCH COTTAGE. CURRENTLY CONFIGURED AS A TWO BEDROOM /THREE FULL BATH HOME, THIS PROPERTY HAS THE POTENTIAL AND SQUARE FOOTAGE FOR RECONFIGURATION TO A THREE BEDROOM HOME. FORMAL LIVING AND DINING ROOMS, A MASTER BEDROOM WITH PRIVATE PORCH AND A HEATED POOL AND SPA IN A SECLUDED SETTING MAKE THIS A PROPERTY THAT SHOULD BE SEEN BY ANYONE INTERESTED IN THE OLD TOWN AREA. PLENTY OF STORAGE & CLOSET SPACE. HURRICANE SHUTTERS ALL AROUND, SOLAR ASSISTED HOT WATER AND FOUR ZONE A/C ARE AMONG THE MANY CONVENIENCE AND GREEN LIVING FEATURE

2011-04-26 MLS SEE626GRINNELL.COM

3/11/04: SOLD FOR \$1,325,000 - BKC

2012-03-09 MLS \$1,175,000 2/3 MAJOR PRICE REDUCTION. GRACIOUS HOME WITH LARGE, COMFORTABLE LIVING AREAS HIDDEN BEHIND THE FACADE OF A CONCH COTTAGE. CURRENTLY CONFIGURED AS A TWO BEDROOM /THREE FULL BATH HOME, THIS PROPERTY HAS THE POTENTIAL AND SQUARE FOOTAGE FOR RECONFIGURATION TO A THREE BEDROOM HOME. IT IS A SUPERB RENOVATION WITH PLENTY OF SPACES TO LIVE IN AND ENJOY, LOCATED IN A GREAT AREA. FORMAL LIVING AND DINING ROOMS, A MASTER BEDROOM WITH PRIVATE DECK AND A HEATED POOL AND SPA IN A SECLUDED SETTING MAKE THIS A PROPERTY THAT SHOULD BE SEEN BY ANYONE INTERESTED IN THE OLD TOWN AREA. PLENTY OF STORAGE & CLOSET SPACE. HURRICANE SHUTTERS ALL AROUND, SOLAR ASSISTED HOT WATER AND FOUR ZONE A/C ARE AMONG THE MANY CONVENIENCE AND GREEN LIVING FEATURE

2011-02-17 MLS \$1,389,400 2/3 CURRENTLY CONFIGURED AS A TWO BEDROOM /THREE FULL BATH HOME, THIS PROPERTY HAS THE POTENTIAL AND SQUARE FOOTAGE FOR RECONFIGURATION TO A THREE BEDROOM HOME. IT IS A SUPERB RENOVATION WITH PLENTY OF SPACES TO LIVE IN AND ENJOY, LOCATED IN A GREAT AREA. FORMAL LIVING AND DINING ROOMS, A MASTER BEDROOM WITH PRIVATE DECK AND A HEATED POOL AND SPA IN A SECLUDED SETTING MAKE THIS A PROPERTY THAT SHOULD BE SEEN BY ANYONE INTERESTED IN THE OLD TOWN AREA. HURRICANE SHUTTERS ALL AROUND, SOLAR ASSISTED HOT WATER AND FOUR ZONE A/C ARE AMONG THE MANY CONVENIENCE AND GREEN LIVING FEATURES

2002 - PROPERTY WAS CHANGED FROM A 2 FAMILY TO A SINGLE FAMILY. 2003-05-02 (005) ASKING \$1,375,000 FROM THE KWCITZEN

Building Permits

Bldg Number	Date Issued	Date Completed	Amount	Description	Notes
15-1944	05/20/2015		1,800		WALL DEMO CONSISTS OF NON STRUCTURAL WALLS FOR BOTH FLOORS. GROUND FLOOR: REMOVAL OF ENTERTAINMENT CLOSET IN LIBRARY, KITCHEN FINISHES, WALL MATERIAL AS NECESSARY IN KITCHEN FOR ELECTRICAL AND PLUMBING UPGRADES AND WALL BETWEEN KITCHEN AND BREAKFAST NOOK. SECOND FLOOR: REMOVAL OF RAILING ON PORCH AREA, TWO VANITIES IN MASTER BATHROOM. BI-FOLD DOORS IN STUDY (IN CLOSET), WALL IN STUDY BETWEEN BOTH CLOSETS, HALF RAILINGS ON TOP OF STAIRWAY, RAILINGS ON GUEST BEDROOM SIDE , CARPET IN MASTER BEDROOM AND CARPET IN GUEST BEDROOM TO EXPOSE WOOD FLOOR.
15-2325	06/15/2015		7,500		100 AMP CIRCUIT PANEL, OUTLETS, KITCHEN AND LIBRARY FIXTURES, HARD-WIRE SMOKE DETECTORS. (FULL DESCRIPTION ATTACHED TO PLANS)
15-2274	06/15/2015		3,500		INSTALLATION OF ROUGH PLUMBUNG: FOR WET BAR IN FLORIDA ROOM, IN KITCHEN FOR SINK, FOR POT FILLER OVER KITCHEN STOVE, CLAW FOOT TUB WAS REMOVED. REMOVE AND REPLACE TOILET IN LOWER BATHROOM. REMOVAL OF VANITY IN MASTER BATH.
15-2324	06/15/2015		55,000		INTERIOR RENOVATION : KITCHEN, WET BAR, LIBRARY, STUDY, M/B, MASTER BATH, UPPER BEDROOM, UPPER COMMON ROOM AND STAIRWAY. ATTACHMENT TO PLANS HAS FULL SCOPE.
B941241	04/01/1994	12/01/1994	900		REPLACE SIDING & PAINT
0104049	01/02/2002	09/04/2002	10,000		CENTRAL AC
01-4076	01/04/2002	09/04/2002	20,000		MASTER BEDRM & BATH
02-0301	02/08/2002	09/04/2002	16,700		POOL
02-0512	03/01/2002	09/04/2002	15,000		RENOVATIONS
03-2104	06/13/2003	09/15/2003	18,000		METAL SHINGLE ROOF
03-2112	06/13/2003	09/15/2003	800		PORCH ROOF
04-0745	03/11/2004	09/29/2004	2,400		INTERIOR REPAIRS

Parcel Value History

Certified Roll Values.

[View Taxes for this Parcel.](#)

Roll Year	Total Bldg Value	Total Misc Improvement Value	Total Land Value	Total Just (Market) Value	Total Assessed Value	School Exempt Value	School Taxable Value
2014	340,390	17,103	685,897	1,043,390	752,378	25,000	727,378
2013	348,400	17,488	573,537	939,425	741,259	25,000	716,259
2012	352,404	17,874	525,442	895,720	728,868	25,000	703,868
2011	352,404	18,259	598,257	968,920	707,639	25,000	682,639
2010	358,681	18,646	319,854	697,181	697,181	25,000	672,181
2009	403,012	19,031	486,178	908,221	908,221	25,000	883,221
2008	374,427	19,417	602,823	996,667	996,667	25,000	971,667
2007	529,834	16,711	459,867	1,006,412	1,006,412	25,000	981,412
2006	964,442	17,045	327,247	1,308,734	1,256,098	25,500	1,230,598
2005	909,331	17,382	292,800	1,219,513	1,219,513	25,500	1,194,013
2004	488,187	17,745	241,129	747,061	747,061	747,061	0

2003	468,321	18,116	124,180	610,617	610,617	610,617	0
2002	497,317	3,410	106,440	607,167	607,167	607,167	0
2001	432,834	3,454	105,000	541,288	250,655	25,000	225,655
2000	445,564	3,805	66,500	515,869	242,100	25,000	217,100
1999	376,820	3,294	66,500	446,614	228,495	25,000	203,495
1998	241,862	2,451	66,500	310,813	208,157	25,000	183,157
1997	219,363	2,322	59,500	281,186	201,501	25,000	176,501
1996	144,635	1,686	59,500	205,821	186,900	25,000	161,900
1995	131,779	1,598	59,500	192,876	181,312	25,000	156,312
1994	113,879	1,484	59,500	174,863	174,863	25,000	149,863
1993	113,879	1,548	59,500	174,926	174,926	25,000	149,926
1992	114,225	1,624	59,500	175,349	175,349	25,000	150,349
1991	114,225	1,698	59,500	175,424	175,424	25,000	150,424
1990	113,408	1,782	46,375	161,565	161,565	25,000	136,565
1989	61,783	1,505	45,500	108,788	108,788	25,000	83,788
1988	50,661	1,134	40,250	92,045	92,045	25,000	67,045
1987	39,895	0	23,975	63,870	63,870	25,000	38,870
1986	40,082	0	23,100	63,182	63,182	25,000	38,182
1985	39,021	0	14,245	53,266	53,266	25,000	28,266
1984	36,781	0	14,245	51,026	51,026	25,000	26,026
1983	36,781	0	14,245	51,026	51,026	25,000	26,026
1982	37,425	0	14,245	51,670	51,670	25,000	26,670

Parcel Sales History

NOTE: Sales do not generally show up in our computer system until about two to three months after the date of sale. If a recent sale does not show up in this list, please allow more time for the sale record to be processed. Thank you for your patience and understanding.

Sale Date	Official Records Book/Page	Price	Instrument	Qualification
3/25/2015	2731 / 1383	1,300,000	<u>WD</u>	<u>02</u>
3/11/2004	1987 / 1343	1,325,000	<u>WD</u>	<u>Q</u>
11/30/2001	1747 / 2095	625,000	<u>WD</u>	<u>Q</u>

This page has been visited 124,614 times.

Monroe County Property Appraiser
 Scott P. Russell, CFA
 P.O. Box 1176 Key West, FL 33041-1176