

CONTRACT DOCUMENTS FOR:



---

**ITB #21-013**

**TARPON FINGER PIER EXTENSIONS  
CITY MARINA at GARRISON BIGHT**

JUNE 2021

---

**CITY OF KEY WEST**

MAYOR: TERI JOHNSTON

COMMISSIONERS:

JIMMY WEEKLEY

SAMUEL KAUFMAN

BILLY WARDLOW

GREGORY DAVILA

MARY LOU HOOVER

CLAYTON LOPEZ

PREPARED BY:  
Port & Marine Services

A small, handwritten mark or signature, possibly a stylized letter or symbol, located in the bottom right corner of the page.

CITY OF KEY WEST

KEY WEST, FLORIDA

CONTRACT DOCUMENTS

for

**TARPON FINGER PIER EXTENSIONS**

\*\*\*\*

CONSISTING OF:

BIDDING REQUIREMENTS  
CONTRACT FORMS  
SUPPLEMENTAL INFORMATION

\*\*\*\*

CITY MARINA at GARRISON BIGHT

JUNE 2021

12

**TABLE OF CONTENTS**

	<u>Page</u>
<b>PART 1 - <u>BIDDING REQUIREMENTS</u></b>	
INVITATION TO BID .....	1
INSTRUCTIONS TO BIDDERS .....	2
BID FORM .....	9
BID BOND .....	20
ANTI-KICKBACK AFFIDAVIT .....	22
PUBLIC ENTITIES CRIME FORM.....	23
CITY OF KEY WEST INDEMNIFICATION.....	25
EQUAL BENEFITS FOR DOMESTIC PARTNERS AFFIDAVIT.....	26
CONE OF SILENCE .....	27
NON-COLLUSION AFFIDAVIT.....	28
LOCAL VENDOR CERTIFICATION .....	29
BIDDER'S CHECKLIST .....	30
<b>PART 2 - <u>CONTRACT FORMS</u></b>	
CONTRACT .....	32
LICENSE REQUIREMENT AND COST .....	34
<b>PART 3 - <u>SUPPLEMENTAL INFORMATION</u>.....</b>	<b>35</b>
DRAWINGS	
ENVIRONMENTAL PERMITS	

T  
E

---

**PART 1**

**BIDDING REQUIREMENTS**

---

**INVITATION TO BID**

Sealed Bids for the City of Key West (CITY) “**TARPON FINGER PIER REPLACEMENT – CITY MARINA at GARRISON BIGHT**,” addressed to the City of Key West, will be received at the office of the City Clerk, 1300 White Street, Key West, Florida until **3:30 p.m.**, local time, on the **28<sup>th</sup> day of July 2021**, and then will be publicly opened and read. Any bids received after the time and date specified will not be considered.

**Please submit one (1) original bid package and two (2) electronic copies on USB drives with a single PDF file of the entire bid package.** Bid package shall be enclosed in a sealed envelope, clearly marked on the outside “**ITB #21-013 TARPON FINGER PIER REPLACEMENT – CITY MARINA at GARRISON BIGHT**” addressed and delivered to the City Clerk at the address noted above.

The CITY is seeking BIDS from qualified individuals or firms installation of nineteen (19) 10-0’ floating finger pier extensions as described in the Scope of Work and drawings.

The full Invitation to Bid may be obtained from Demand Star by Onvia and The City of Key West website. Please contact Demand Star at [www.demandstar.com](http://www.demandstar.com) or call 1-800-711-1712 or [www.cityofkeywest-fl.gov](http://www.cityofkeywest-fl.gov)

A **Mandatory pre-bid meeting** will be held outside the Dockmaster building, 1801 N. Roosevelt Blvd, Key West, Florida on **July 13, 2021 at 9:30 a.m.**

**EACH BID MUST BE SUBMITTED ON THE PRESCRIBED FORM AND ACCOMPANIED BY BID SECURITY AS PRESCRIBED IN THE INSTRUCTIONS TO BIDDERS, PAYABLE TO THE CITY OF KEY WEST, FLORIDA, IN AN AMOUNT NOT LESS THAN FIVE (5) PERCENT OF THE AMOUNT BID.**

For information concerning the proposed work please contact Karen Olson, Deputy Director, Port and Marine Services by email at [kolson@cityofkeywest-fl.gov](mailto:kolson@cityofkeywest-fl.gov). Verbal communications, per the City’s “Cone of Silence” ordinance are not allowed.

As stated above at the time of the BID submittal the Bidder must provide satisfactory documentation of State Licenses. The Bidder shall furnish documentation showing that he is in compliance with the licensing requirements of County, and City licenses as would be required within ten days of the award. The successful Bidder must also be able to satisfy the City Attorney as to such insurance coverage and legal requirements as may be demanded by the Proposal in question. The CITY may reject BID for any and/or all of the following reasons: (1) for budgetary reasons, (2) if the proposer misstates or conceals a material fact in its bid, (3) if the proposal does not strictly conform to the law or is non-responsive to the bid requirements, (4) if the proposal is conditional, or (5) if a change of circumstances occurs making the purpose of the proposal unnecessary to the CITY. (6) if such rejection is in the best interest of the CITY. The CITY may also waive any minor formalities or irregularities in any proposal.

The CITY retains the right to award bid to the bidder that best meet the needs of the City.

\*\*\*\*\*

## INSTRUCTIONS TO BIDDERS

### 1. CONTRACT DOCUMENTS

#### A. FORMAT

The Contract Documents are divided into parts, divisions, and sections for convenient organization and reference. Generally, there has been no attempt to divide the Specification sections into work performed by the various building trades, work by separate subcontractors, or work required for separate facilities in the Project.

#### B. DOCUMENT INTERPRETATION

Separate sections contained within these Contract Documents are intended to be mutually cooperative and provide all details reasonably required for the execution of proposed work.

Should there be any doubt as to the meaning or intent of said Contract Documents, the Bidder should request of the Deputy Port and Marine Services Director, in writing (at least 8 calendar days prior to Bid opening (**July 21<sup>st</sup>**)) an interpretation thereof. Any interpretation or change in said Contract Documents will be made only in writing in the form of Addenda to the Documents, which will be furnished to all registered holders of Contract Documents. Bidders shall submit with their Bids, or indicate receipt of all Addenda. The Owner will not be responsible for any other explanation or interpretations of said Documents.

### 2. SCOPE OF SERVICES

Provide all labor and material necessary to install nineteen (19) owner supplied 10' finger pier extensions to existing 25' finger piers as shown on the attached drawings. Work also includes the following:

- Float finger pier extensions from seawall, north of Dolphin Pier, to Tarpon Pier.
- Remove and reinstalling 20" pipe pile and caps to existing elevation (EL +11.4' NGVD). Provide touch-up paint to match existing.
- Remove and reinstall existing roller assemblies.
- Remove and dispose of 17 existing outer mooring piles.
- Temporarily shifting or moving existing vessels or floating structures to accommodate removals and installation.
- Applying for and obtaining local building permits.

*The intent of this Scope of Work is to describe a functionally complete project (or part thereof) to be constructed in accordance with all applicable codes. Any work, materials, or equipment that may reasonably be inferred from this Scope of Work, as being required to produce the intended result shall be supplied whether or not specifically called for.*

### 3. REQUIRED QUALIFICATIONS

The prospective Proposers must meet the statutorily prescribed requirements before award of Contract by the CITY. Proposers must hold or obtain all licenses and/or certificates as required by the State and Local Statutes in order to bid and perform the work specified herein.

4. BIDDER'S UNDERSTANDING

Each Proposer must inform himself of the conditions relating to the execution of the work and make himself thoroughly familiar with all the Contract Documents. Failure to do so will not relieve the successful Proposer of his obligation to enter into a Contract and complete the contemplated work in strict accordance with the Contract Documents.

Each Proposer shall inform himself of, and the Proposer awarded a Contract shall comply with, federal, state, and local laws, statutes, and ordinances relative to the execution of the work. This requirement includes, but is not limited to, applicable regulations concerning minimum wage rates, nondiscrimination in the employment of labor, protection of public and employee safety and health, environmental protection, the protection of natural resources, fire protection, permits, fees, and similar subjects.

5. TYPE OF BID

UNIT PRICE

The Proposal for the work is to be submitted on a unit price basis. All items required to complete the work specified or shown on the Drawings but not included in the Proposal shall be considered incidental to those set forth in the Proposal. Payment to the Contractor will be made on the measurement of the work actually performed by the Contractor, as specified in the Contract Documents.

The Bidder further proposes to accept as full payment for the Work proposed herein, the amounts computed under the provisions of the Contract Documents and based on the following unit price amounts. The Bidder agrees that the unit prices include all allowances for overhead and profit for each type and unit of work called for in these Contract Documents.

Total allowable cost for Mobilization and Demobilization (bid schedule line item 1) shall be 10% maximum of total construction costs (bid schedule line items 3 through 6).

6. PREPARATION OF BIDS

A. GENERAL

All blank spaces in the BID form must be filled in for all schedules and associated parts, as required, preferably in BLACK INK. All price information shall be clearly shown in both words and figures where required. No changes shall be made in the phraseology of the forms. Written amounts shall govern in case of discrepancy between the amounts stated in writing and the amounts stated in figures. In case of discrepancy between unit prices and extended totals, unit prices shall prevail.

Any BID shall be deemed informal which contains omissions, erasures, alterations, or additions of any kind, or prices uncalled for, or in which any of the prices are obviously unbalanced, or which in any manner shall fail to conform to the conditions of the published Invitation to BID.



Only one BID from any individual, firm, partnership, or corporation, under the same or different names, will be considered. Should it appear to the Owner that any Bidder is interested in more than one BID for work contemplated; all Bids in which such Bidder is interested will be rejected.

**B. SIGNATURE**

The Bidder shall sign his BID in the blank space provided therefor. If Bidder is a corporation, the legal name of the corporation shall be set forth above together with the signature of the officer or officers authorized to sign Contracts on behalf of the corporation. If Bidder is a partnership, the true name of the firm shall be set forth above together with the signature of the partner or partners authorized to sign Contracts in behalf of the partnership. If signature is by an agent, other than an officer of a corporation or a member of a partnership, a notarized power-of-attorney must be on file with the Owner prior to opening of Bids or submitted with the Bid otherwise the Bid will be regarded as not properly authorized.

**C. SPECIAL BIDDING REQUIREMENTS**

The Bidder shall submit with his Bid his experience record showing his experience and expertise in marina construction and related work. Such experience record shall provide at least five current or recent projects of similar work, not more than 5 years old within the State Florida and preferably Monroe County. For each project the following information shall be provided:

1. Description and location of work.
2. Contract amount.
3. Dates work was performed.
4. Owner.
5. Name of Owner's contact person and phone number.
6. Engineer.
7. Name of Engineer's contact person and phone number.

The bidder shall submit at least 3 references from the above work experience.

**D. ATTACHMENTS**

Bidder shall complete and submit the following forms with his bid:

1. Anti-Kickback Affidavit
2. Public Entity Crimes Form
3. City of Key West Indemnification Form
4. Equal Benefits for Domestic Partners Affidavit
5. Cone of Silence
6. Local Vendor Certification
7. Non-Collusion Affidavit
8. Proof of Required Insurance

**7. MODIFICATION OR WITHDRAWAL OF BID**

Prior to the time and date designated for receipt of Bids, any Bid submitted may be withdrawn by notice to the party receiving Bids at the place designated for receipt of Bids. Such notice shall be in writing over the signature of the Bidder or by telegram. If by telegram, written confirmation over the signature of the Bidder shall be mailed and postmarked on or before the date and time set for receipt of Bids. No Bid may be withdrawn after the time scheduled for





opening of Bids unless the time specified in paragraph AWARD OF CONTRACT of these Instructions to Bidders shall have elapsed.

8. BID SECURITY

BIDS must be accompanied by cash, a certified check, or cashier's check drawn on a bank in good standing, or a bid bond issued by a Surety authorized to issue such bonds in the state where the work is located, in the amount of five (5) percent of the total amount of the Proposal submitted. This bid security shall be given as a guarantee that the Bidder will not withdraw his BID for a period of ninety (90) days after bid opening, and that if awarded the Contract, the successful Bidder will execute the attached Contract and furnish properly executed Performance and Payment Bonds, each in the full amount of the Contract price within the time specified. Agent and Surety phone numbers must be provided.

The Attorney-in-Fact who executes this bond in behalf of the Surety must attach a notarized copy of his power-of-attorney as evidence of his authority to bind the Surety on the date of execution of the bond. Where State Statute requires, certification by a resident agent shall also be provided.

If the Bidder elects to furnish a Bid Bond, he shall use the Bid Bond form bound herewith, or one conforming substantially thereto in form and content.

9. AWARD OF CONTRACT

Within 90 calendar days after the opening of Bids the CITY will accept one or more of the Bids. The acceptance of the Bid will be by written notice of award mailed to the office designated in the Bid or delivered to the Bidder's representative.

The CITY reserves the right to accept or reject any or all Bids and to waive any formalities and irregularities in said Bids.

10. BASIS OF AWARD

The award will be made by the Owner on the basis of the BID from the lowest, responsive, responsible BIDDER which, in the Owner's sole and absolute judgment will best serve the interest of the Owner.

11. EXECUTION OF CONTRACT

The successful Bidder shall, within 10 working days after receiving Notice of Award, sign and deliver to the Owner a Contract in the form hereto attached together with the insurance certificate examples of the bonds as required in the Contract Documents and evidence of holding required licenses and certificates. Within 10 working days after receiving the signed Contract from the successful Bidder, the Owner's authorized agent will sign the Contract. Signature by both parties constitutes execution of the Contract.

12. CONTRACT BONDS

A. PERFORMANCE AND PAYMENT BONDS (NOT APPLICABLE)

The successful Bidder shall file with the CITY, at the time of delivery of the signed Contract, a Performance Bond and Payment Bond on the form bound herewith, each in the full amount of the Contract price in accordance with the requirements of Florida Statutes Section 255.05 or 713.23, as applicable, as security for the faithful

performance of the Contract and the payment of all persons supplying labor and materials for the construction of the work, and to cover all guarantees against defective workmanship or materials, or both, during the warranty period following the date of final acceptance of the work by the CITY. The Surety furnishing this bond shall have a sound financial standing and a record of service satisfactory to the CITY, shall be authorized to do business in the State of Florida, and shall be listed on the current U.S. Department of Treasury Circular Number 570, or amendments thereto in the Federal Register, of acceptable Sureties for federal projects. The CONTRACTOR shall supply the OWNER with phone numbers, addresses, and contacts for the Surety and their agents. Pursuant to Section 255.05(7), Florida Statutes, in lieu of the bond required by law, the contractor may file with the city an alternative form of security in the form of cash, a money order, a certified check, a cashier's check or an irrevocable letter of credit.

B. POWER-OF-ATTORNEY

The Attorney-in-Fact (Resident Agent) who executes this Performance and Payment Bond in behalf of the Surety must attach a notarized copy of his power-of-attorney as evidence of his authority to bind the Surety on the date of execution of the bond. All Contracts, Performance and Payment Bonds, and respective powers-of-attorney will have the same date.

13. FAILURE TO EXECUTE CONTRACT AND FURNISH BOND

The Bidder who has a Contract awarded to him and who fails to promptly and properly execute the Contract or furnish the required Bonds shall forfeit the bid security that accompanied his bid, and the bid security shall be retained as liquidated damages by the CITY, and it is agreed that this said sum is a fair estimate of the amount of damages the CITY will sustain in case the Bidder fails to enter into a Contract or furnish the required Bonds. Bid security deposited in the form of cash, a certified check, or cashier's check shall be subject to the same requirement as a Bid Bond.

14. PUBLIC RECORDS REQUIREMENTS

In addition to other contract requirements provided by law, each public agency contract for services must include a provision that requires the contractor to comply with public records laws, specifically to (a) keep and maintain public records that ordinarily and necessarily would be required by the public agency in order to perform the service; (b) provide the public with access to public records on the same terms and conditions that the public agency would provide the records and at a cost that does not exceed the cost provided in this chapter or as otherwise provided by law; (c) ensure that public records that are exempt or confidential and exempt from public records disclosure requirements are not disclosed except as authorized by law; and (d) meet all requirements for retaining public records and transfer, at no cost, to the public agency all public records in possession of the contractor upon termination of the contract and destroy any duplicate public records that exempt or confidential and exempt from public records disclosure requirements. All records stored electronically must be provided to the public agency in a format that is compatible with the information technology systems of the public agency. If a contractor does not comply with a public records request, the public agency shall enforce the contract provisions in accordance with the contract.

15. CERTIFICATES OF INSURANCE

Bidder agrees to furnish the Owner, before commencing the work under this Contract, the certificates of insurance as specified in these Documents.

16. TIME OF COMPLETION

The time of completion of the work to be performed under this Contract is the essence of the Contract. Delays and extensions of time may only be allowed in accordance with the provisions stated in the General Conditions. Time allowed for completion of the work authorized is stated in Bid.

When the Contractor receives a Notice to Proceed, he shall commence work as soon as possible and shall complete all work within the number of calendar days stipulated in the Contract.

The term of this contract will be sixty (60) calendar days.

17. SUBMITTALS

ENGINEER will act upon CONTRACTOR's Product Submittal and transmit response to CONTRACTOR not later than 30 days after receipt.

18. PERMITS AND FEES

The Bidder awarded this project shall procure and pay all permits and licenses, charges, and fees, and give notices necessary and incidental to the due and lawful prosecution of the work, the cost of which shall be included in the fee received for the work, except where separately agreed.

19. WARRANTY PERIOD

The CONTRACTOR hereby agrees to make, at his own expense, all repairs or replacements necessitated by defects in materials or workmanship, Provided under terms of this Contract, and pay for any damage to other works resulting from such defects, which become evident within 2 years after the date of final acceptance of the work or within 2 years after the date of substantial completion established by the ENGINEER for specified items of equipment, or within such longer period as may be Prescribed by law or by the terms of any applicable special guarantee required by the Contract Documents. Un-remedied defects identified for correction during the warranty period but remaining after its expiration shall be considered as part of the obligations of the warranty. Defects in material, workmanship, or equipment which are remedied as a result of obligations of the warranty shall subject the remedied portion of the work to an extended warranty period of 2 years after the defect has been remedied.

The CONTRACTOR further assumes responsibility for a similar guarantee for all work and materials provided by SUBCONTRACTORS or manufacturers of packaged equipment components. The effective date for the start of the guarantee or warranty period for equipment qualifying as substantially complete is the date of SUBSTANTIAL COMPLETION.

The CONTRACTOR also agrees to hold the OWNER and the ENGINEER harmless from liability of any kind arising from damage due to said defects. The CONTRACTOR shall make all repairs and replacements promptly upon receipt of written order for same from the



OWNER. If the CONTRACTOR fails to make the repairs and replacements promptly, or in an emergency where delay would cause serious risk, or loss, or damage, the OWNER may have the defective work corrected or the rejected work removed and replaced, and the CONTRACTOR and his Surety shall be liable for the cost thereof.

\* \* \* \* \*

A handwritten signature or mark, possibly initials, located at the bottom right of the page. It consists of a horizontal line above a stylized, cursive-like character.

**BID FORM**

To: City of Key West, Florida  
Address: 1300 White Street, Key West, Florida 33040  
Project Title: **TARPON FINGER PIER EXTENSION  
CITY MARINA at GARRISON BIGHT**  
Project No.: ITB #21-013

Bidder's person to contact for additional information on this Bid:

Company Name: KEARNS CONSTRUCTION COMPANY

Contact Name & Telephone #: JOHN KEARNS 305.461.0310

Email Address: JKEARNS@KEARNSCONSTRUCTION.COM

**BIDDER'S DECLARATION AND UNDERSTANDING**

The undersigned, hereinafter called the Bidder, declares that the only persons or parties interested in this Bid are those named herein, that this Bid is, in all respects, fair and without fraud, that it is made without collusion with any official of the Owner, and that the Bid is made without any connection or collusion with any person submitting another Bid on this Contract.

The Bidder further declares that he has carefully examined the Contract Documents, that he has personally inspected the Project, that he has satisfied himself as to the quantities involved, including materials and equipment, and conditions of work involved, including the fact that the description of the quantities of work and materials, as included herein, is brief and is intended only to indicate the general nature of the work and to identify the said quantities with the detailed requirements of the Contract Documents, and that this Bid is made according to the provisions and under the terms of the Contract Documents, which Documents are hereby made a part of this Proposal.

The Bidder further agrees that the Owner may "non-perform" the work in the event that the low bid is in excess of available funding. Non-performance will be determined prior to Notice of Award.

The intent of the Bid Documents is to describe a functionally complete project (or part thereof) to be constructed in accordance with the Contract Documents. Any work, materials, or equipment that may reasonably be inferred from the Contract Documents, as being required to produce the intended result shall be supplied, whether or not specifically called for in the Contract Documents.

**CERTIFICATES OF INSURANCE**

CONTRACTOR is to secure, pay for, and file with the City of Key West, prior to commencing any work under the Contract, all certificates for workers' compensation, public liability, and property damage liability insurance, and such other insurance coverages as may be required by specifications and addenda thereto, in at least the following minimum amounts with specification amounts to prevail if greater than minimum amounts indicated. Notwithstanding any other provision of the

Contract, the CONTRACTOR shall provide the minimum limits of liability insurance coverage as follows:

Type of Insurance	Limits	Comments
Commercial General Liability	\$1,000,000	The proposers may have these coverages combined in 1 policy
Watercraft Liability	\$1,000,000	
Business Automobile Liability	\$1,000,000	
Workers' Compensation	Statutory	
Employers Liability	\$1,000,000/\$1,000,000/\$1,000,000	
USL&H and Jones Act Coverage	\$1,000,000	

CONTRACTOR shall furnish an original Certificate of Insurance indicating, and such policy providing coverage to, City of Key West named as an additional insured on a PRIMARY and NON CONTRIBUTORY basis utilizing an ISO standard endorsement at least as broad as CG 2010 (11/85) or its equivalent, (combination of CG 20 10 07 04 and CG 20 37 07 04, providing coverage for completed operations, is acceptable) including a waiver of subrogation clause in favor of City of Key West on all policies. CONTRACTOR will maintain the General Liability and Umbrella Liability insurance coverages summarized above with coverage continuing in full force including the additional insured endorsement until at least 3 years beyond completion and delivery of the work contracted herein.

Notwithstanding any other provision of the Contract, the CONTRACTOR shall maintain complete workers' compensation coverage for each and every employee, principal, officer, representative, or agent of the CONTRACTOR who is performing any labor, services, or material under the Contract. Further, CONTRACTOR shall additionally maintain the following minimum limits of coverage:

Bodily Injury Each Accident	\$1,000,000
Bodily Injury by Disease Each Employee	\$1,000,000
Bodily Injury by Disease Policy Limit	\$1,000,000

The City of Key West confirms that the scope of services specified in the Contract requires work on or near a navigable waterway. Water description: City of Key West Mooring Field. Therefore, the CONTRACTOR's workers' compensation policy shall be endorsed to provide the following:

- Workers Compensation/Employer Liability
- USL&H Coverage (Longshore and Harbor Workers' Compensation Act) Endorsement
- WC 000106A
- Jones Act Coverage\* Endorsement WC 000201A

**Note:** Jones Act (Crew) coverage may be provided under the P&I policy, if Contractor is using an OWNED vessel during the course of the work.

CONTRACTOR shall provide the City of Key West with a Certificate of Insurance verifying compliance with the workman's compensation coverage as set forth herein and shall provide as often

as required by the City of Key West such certification which shall also show the insurance company, policy number, effective and expiration date, and the limits of workman's compensation coverage under each policy.

CONTRACTOR's insurance policies shall be endorsed to give 30 days written notice to the City of Key West in the event of cancellation or material change, using form CG 02 24, or its equivalent.

Certificates of Insurance submitted to the City of Key West will not be accepted without copies of the endorsements being requested. This includes additional insured endorsements, cancellation/material change notice endorsements, and waivers of subrogation. Copies of USL&H Act and Jones Act endorsements will also be required if necessary. PLEASE ADVISE YOUR INSURANCE AGENT ACCORDINGLY.

CONTRACTOR will comply with any and all safety regulations required by any agency or regulatory body including but not limited to OSHA. CONTRACTOR will notify City of Key West immediately by telephone at (305) 809-3811 any accident or injury to anyone that occurs on the jobsite and is related to any of the work being performed by the CONTRACTOR.

#### SURETY AND INSURER QUALIFICATIONS

All bonds (if required), insurance contracts, and certificates of insurance shall be either executed by or countersigned by a licensed resident agent of the Surety or insurance company, having his place of business in the State of Florida, and in all ways complying with the insurance laws of the State of Florida. Further, the said Surety or insurance company shall be duly licensed and qualified to do business in the State of Florida.

#### START OF CONSTRUCTION AND CONTRACT COMPLETION TIME

The Bidder agrees to begin work within fourteen (14) calendar days after the date of the Notice to Proceed and to fully complete all work under this contract within sixty (60) calendar days.

#### LIQUIDATED DAMAGES

In the event the Bidder is awarded the Contract and fails to complete the work within the time limit or extended time limit agreed upon, as more particularly set forth in the Contract Documents, liquidated damages shall be paid to the Owner at the rate of \$250.00 per day for all work awarded until the work has been satisfactorily completed as provided by the Contract Documents. Sundays and legal holidays shall be excluded in determining days in default.

Owner will recover such liquidated damages by deducting the amount owed from the final payment or any retainage held by Owner.

#### ADDENDA

The Bidder hereby acknowledges that he has received Addenda No's. 1, \_\_\_\_\_, \_\_\_\_\_, \_\_\_\_\_, \_\_\_\_\_ (Bidder shall insert No. of each Addendum received) and agrees that all addenda issued are hereby made part of the Contract Documents, and the Bidder further agrees that his Bid(s) includes all impacts resulting from said addenda.

SALES AND USE TAXES

The Bidder agrees that all federal, state, and local sales and use taxes are included in the stated bid prices for the work.

UNIT PRICE WORK ITEMS

The Bidder further proposes to accept as full payment for the Work proposed herein the amounts computed under the provisions of the Contract Documents and based on the following unit price amounts.

The Bidder agrees that the unit price represent a true measure of labor and materials required to perform the Work, including all allowances for overhead and profit for each type of work called for in these Contract Documents. The amounts shall be shown in both words and figures. In case of discrepancy, the amount shown in words shall govern.

\* \* \* \* \*





## BID SCHEDULE

### CONCH REPUBLIC ROOF / WALL REPLACEMENT KEY WEST HISTORIC SEAPORT

#### UNIT PRICE BID

Bid unit prices stated in this proposal include all costs and expenses for labor, equipment, materials, disposal and contractor's overhead and profit. Unit prices for the various work items are intended to establish a total price for completing the project in its entirety. All work and incidental costs shall be included for payment under the several scheduled items of the overall contract, and no separate payment will be made therefore.

*Any work, materials, or equipment that may reasonably be inferred from the Scope of Work, as being required to produce the intended result shall be supplied whether or not specifically called for in the Bid Schedule and is incidental to the project.*

#### 1. Mobilization and Demobilization

a. Mobilization	1	each	\$ <u>14,000.00</u>	
b. Demobilization	1	each	\$ <u>14,000.00</u>	
	1	LS (10% of Construction Cost Max.)		\$ <u>28,000.00</u>

#### 2. Permit Fees (to be paid at cost)

	1	LS		\$ <u>4,000.00</u>
--	---	----	--	--------------------

#### 3. Remove/ Dispose Outer Mooring Piles

	17	EA	Unit Price \$ <u>1,000.00</u>	TOTAL	\$ <u>17,000.00</u>
--	----	----	-------------------------------	-------	---------------------

#### 4. Remove/ Re-Install 20" Pipe Pile w/ Caps and Roller Assemblies

	19	EA	Unit Price \$ <u>7,500.00</u>	TOTAL	\$ <u>142,500.00</u>
--	----	----	-------------------------------	-------	----------------------

#### 5. Install 10' Floating Dock Sections (Owner Furnished)

	19	EA	Unit Price \$ <u>6,600.00</u>	TOTAL	\$ <u>125,400.00</u>
--	----	----	-------------------------------	-------	----------------------

#### 6. Allowance (only to be used with Owner's written direction)

	1	LS		\$ <u>5,000.00</u>
--	---	----	--	--------------------

#### **TOTAL OF ALL EXTENDED LINE ITEMS LISTED ABOVE:**

Total of lump sum items 1 - 6 \$ 321,900.00

Three Hundred Twenty One Thousand Nine Hundred Dollars & Zero Cents  
(amount written in words)

**NOTE: THE TOTAL BID WILL BE THE BASIS OF EVALUATING LOW BIDDER AND BASIS OF AWARD**

**BIDDER'S INFORMATION**

Company Name: KEARNS CONSTRUCTION COMPANY

Address: 2550 S. BAYSHORE DR. STE 206B

MIAMI, FL 33133

Contact Name: JOHN KEARNS

Email: JKEARNS@KEARNSCONSTRUCTION.COM

Telephone: 305.461.0310

Fax: 305.461.1892

Signature: 

Date: 7/28/22



CONTRACTOR'S PROJECTED OPERATIONS LOAD AND COST ESTIMATE

List items to be performed by Contractor's own forces and the estimated total cost of these items.  
(Use additional sheets if necessary.)

<u>Mobilization</u>	<u>\$14,000</u>
<u>Demobilization</u>	<u>\$14,000</u>
<u>Permitting</u>	<u>\$4,000</u>
<u>Remove/Dispose Outer Mooring Piles</u>	<u>\$17,000</u>
<u>Remove/Re-Install 20" Pipe Pile</u>	<u>\$100,000</u>
<u>Remove/Re-Install 20" Pile Caps</u>	<u>\$10,000</u>
<u>Remove/Re-Install Roller Assemblies</u>	<u>\$32,500</u>
<u>Install 10' Floating Dock Sections</u>	<u>\$125,400</u>
<u> </u>	<u> </u>
<u> </u>	<u> </u>
<u> </u>	<u> </u>



SUBCONTRACTORS

The Bidder further proposes that the following subcontracting firms or businesses will be awarded subcontracts for the following portions of the work in the event that the Bidder is awarded the Contract:

TOWING VESSELS (AS NEEDED)

Portion of Work \_\_\_\_\_

TOW BOAT US

Name \_\_\_\_\_

1635 N BISCAYNE DRIVE, MIAMI, FL, 33132  
Street City State Zip

N/A

Portion of Work \_\_\_\_\_

N/A

Name \_\_\_\_\_

N/A, N/A, N/A, N/A  
Street City State Zip

N/A

Portion of Work \_\_\_\_\_

N/A

Name \_\_\_\_\_

N/A, N/A, N/A, N/A  
Street City State Zip

N/A

Portion of Work \_\_\_\_\_

N/A

Name \_\_\_\_\_

N/A, N/A, N/A, N/A  
Street City State Zip



SURETY

Nielson Hoover & Company whose address is

15050 NW 79th Court Suite 200, Miami Lakes, FL, 33016  
Street City State Zip

305.722.2663 Gicelle Pajon, CCSR  
Phone Resident Agent

BIDDER

The name of the Bidder submitting this Bid is KEARNS CONSTRUCTION COMPANY

\_\_\_\_\_ doing business  
at

2550 S. BAYSHORE DR. STE 206B, MIAMI, FL, 33133  
Street City State Zip

JKEARNS@KEARNSCONSTRUCTION.COM  
email address

which is the address to which all communications concerned with this Bid and with the Contract shall be sent.

The names of the principal officers of the corporation submitting this Bid, or of the partnership, or of all persons interested in this Bid as principals are as follows:

Name	Title
<u>CHARLES S. KEARNS</u>	<u>CEO</u>
<u>JOHN W. KEARNS III</u>	<u>CFO</u>
<u>JAMES B. SULLIVAN</u>	<u>COO</u>
_____	_____

If Sole Proprietor or Partnership

IN WITNESS hereto the undersigned has set his (its) hand this \_\_\_\_ day of \_\_\_\_\_ 20\_\_.

\_\_\_\_\_  
Signature of Bidder

\_\_\_\_\_  
Title

If Corporation

IN WITNESS WHEREOF the undersigned corporation has caused this instrument to be executed and its seal affixed by its duly authorized officers this \_\_\_\_ day of \_\_\_\_\_ 20\_\_.

(SEAL)



KEARNS CONSTRUCTION COMPANY

Name of Corporation

By John Kearns

Title CFO

Attest Secretary [Signature]

[Signature]

EXPERIENCE OF BIDDER

The Bidder states that he is an experienced Contractor and has completed similar projects within the last five (5) years.

(List similar projects, with types, names of owners, construction costs, Engineers, and references with phone numbers. Use additional sheets if necessary.)

PLEASE REFER TO ATTACHED PROJECT REFERENCE SHEET.

---

---

---

---

---

---

---

---

---

---

---

---

---

---

---

---

---

---

---

---

---

---

\* \* \* \* \*



FLORIDA BID BOND

*See Attached*

BOND NO. \_\_\_\_\_

AMOUNT: \$ \_\_\_\_\_

KNOW ALL MEN BY THESE PRESENTS, that \_\_\_\_\_

\_\_\_\_\_ hereinafter called the PRINCIPAL, and \_\_\_\_\_

\_\_\_\_\_ a corporation duly organized under the laws of the State of \_\_\_\_\_

\_\_\_\_\_ having its principal place of business at \_\_\_\_\_

\_\_\_\_\_ in the State of \_\_\_\_\_,

and authorized to do business in the State of Florida, as SURETY, are held and firmly bound unto

\_\_\_\_\_ hereinafter CITY OF KEY WEST called the OBLIGEE, in the sum of \_\_\_\_\_

\_\_\_\_\_ DOLLARS (\$ \_\_\_\_\_) for

the payment for which we bind ourselves, our heirs, executors, administrators, successors, and assigns, jointly and severally, firmly by these present.

THE CONDITION OF THIS BOND IS SUCH THAT:

WHEREAS, the PRINCIPAL is herewith submitting his or its Bid Proposal for **ITB #21-013 Tarpon Finger Pier Extensions – City Marina at Garrison Bight**, said Bid Proposal, by reference thereto, being hereby made a part hereof.

WHEREAS, the PRINCIPAL contemplates submitting or has submitted a bid to the OBLIGEE for the furnishing of all labor, materials (except those to be specifically furnished by the CITY),



equipment, machinery, tools, apparatus, means of transportation for, and the performance of the work covered in the Proposal and the detailed Specifications, entitled:

**ITB #21-013**

**TARPON FINGER PIER EXTENSIONS**

**CITY MARINA at GARRISON BIGHT**

WHEREAS, it was a condition precedent to the submission of said bid that a cashier's check, certified check, or bid bond in the amount of 5 percent of the base bid be submitted with said bid as a guarantee that the Bidder would, if awarded the Contract, enter into a written Contract with the CITY for the performance of said Contract, within 10 working days after written notice having been given of the award of the Contract.

NOW, THEREFORE, the conditions of this obligation are such that if the PRINCIPAL within 10 consecutive calendar days after written notice of such acceptance, enters into a written Contract with the OBLIGEE and furnishes the Performance and Payment Bonds, each in an amount equal to 100 percent of the base bid, satisfactory to the CITY, then this obligation shall be void; otherwise the sum herein stated shall be due and payable to the OBLIGEE and the Surety herein agrees to pay said sum immediately upon demand of the OBLIGEE in good and lawful money of the United States of America, as liquidated damages for failure thereof of said PRINCIPAL.

Signed and sealed this \_\_\_\_\_ day of \_\_\_\_\_, 20\_\_.

By \_\_\_\_\_  
PRINCIPAL

\_\_\_\_\_  
SURETY

By \_\_\_\_\_  
Attorney-In-Fact



ANTI-KICKBACK AFFIDAVIT

STATE OF FLORIDA )

: SS

COUNTY OF MIAMI-DADE )

I, the undersigned hereby duly sworn, depose and say that no portion of the sum herein bid will be paid to any employees of the City of Key West as a commission, kickback, reward or gift, directly or indirectly by me or any member of my firm or by an officer of the corporation.

By: JOHN KEARNS

*John Kearns*

Sworn and subscribed before me this 28<sup>th</sup> day of July 2021.

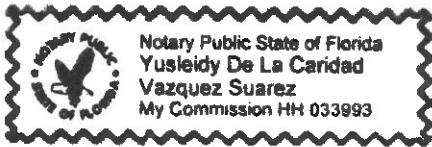

*Yusleidy*

NOTARY PUBLIC, State of Florida at Large

My Commission Expires: 08/18/2024

\* \* \* \* \*

*bc*

**SWORN STATEMENT UNDER SECTION 287.133(3)(A)  
FLORIDA STATUTES, ON PUBLIC ENTITY CRIMES**

*THIS FORM MUST BE SIGNED IN THE PRESENCE OF A NOTARY PUBLIC OR OTHER OFFICER AUTHORIZED TO ADMINISTER OATHS.*

1. This sworn statement is submitted with Bid or Proposal for TARPON FINGER PIER EXTENSION  
CITY MARINA at GARRISON BIGHT

2. This sworn statement is submitted by KEARNS CONSTRUCTION COMPANY  
(name of entity submitting sworn statement)

whose business address is 2550 S BAYSHORE DR STE 206B MIAMI, FL 33133

and (if applicable) its Federal Employer Identification Number (FEIN) is 77-0615005

(If the entity has no FEIN, include the Social Security Number of the individual

signing this sworn statement N/A

3. My name is JOHN KEARNS  
(please print name of individual signing)

and my relationship to the entity named above is CFO

4. I understand that a "public entity crime" as defined in Paragraph 287.133(1)(g), Florida Statutes, means a violation of any state or federal law by a person with respect to and directly related to the transaction of business with any public entity or with an agency or political subdivision of any other state or with the United States, including but not limited to, any bid or contract for goods or services to be provided to any public or an agency or political subdivision of any other state or of the United States and involving antitrust, fraud, theft, bribery, collusion, racketeering, conspiracy, material misrepresentation.

5. I understand that "convicted" or "conviction" as defined in Paragraph 287.133(1)(b), Florida Statutes, means a finding of guilt or a conviction of a public entity crime, with or without an adjudication of guilt, in any federal or state trial court of record relating to charges brought by indictment information after July 1, 1989, as a result of a jury verdict, nonjury trial, or entry of a plea of guilty or nolo contendere.

6. I understand that an "affiliate" as defined in Paragraph 287.133(1)(a), Florida Statutes, means

1. A predecessor or successor of a person convicted of a public entity crime; or
2. An entity under the control of any natural person who is active in the management of the entity and who has been convicted of a public entity crime. The term "affiliate" includes those officers, directors, executives, partners, shareholders, employees, members, and agents who are active in the management of an affiliate. The ownership by one person of shares constituting controlling interest in another person, or a pooling of equipment or income among persons when not for fair market value under an arm's length agreement, shall be a prima facie case that one person controls another person. A person who knowingly enters into a joint venture with a person who has been convicted of a public entity crime in Florida during the preceding 36 months shall be considered an affiliate.



7. I understand that a "person" as defined in Paragraph 287.133(1)(8), Florida Statutes, means any natural person or entity organized under the laws of any state or of the United States with the legal power to enter into a binding contract and which bids or applies to bid on contracts for the provision of goods or services let by a public entity, or which otherwise transacts or applies to transact business with public entity. The term "person" includes those officers, directors, executives, partners, shareholders, employees, members, and agents who are active in management of an entity.
8. Based on information and belief, the statement which I have marked below is true in relation to the entity submitting this sworn statement. (Please indicate which statement applies).

Neither the entity submitting this sworn statement, nor any officers, directors, executives, partners, shareholders, employees, members, or agents who are active in management of the entity, nor any affiliate of the entity have been charged with and convicted of a public entity crime subsequent to July 1, 1989, AND (Please indicate which additional statement applies.)

There has been a proceeding concerning the conviction before a hearing of the State of Florida, Division of Administrative Hearings. The final order entered by the hearing officer did not place the person or affiliate on the convicted vendor list. (Please attach a copy of the final order.)

The person or affiliate was placed on the convicted vendor list. There has been a subsequent proceeding before a hearing officer of the State of Florida, Division of Administrative Hearings. The final order entered by the hearing officer determined that it was in the public interest to remove the person or affiliate from the convicted vendor list. (Please attach a copy of the final order.)

The person or affiliate has not been put on the convicted vendor list. (Please describe any action taken by or pending with the Department of General Services.)

John Kearns  
 (signature)  
7/28/2021  
 (date)

STATE OF FLORIDA

COUNTY OF MIAMI-DADE

PERSONALLY APPEARED BEFORE ME, the undersigned authority,

JOHN KEARNS who, after first being sworn by me, affixed his/her  
 (name of individual signing)

signature in the space provided above on this 28<sup>th</sup> day of July, 2021.

My commission expires: 08/18/2024

[Signature]  
 NOTARY PUBLIC  
 Notary Public State of Florida  
 Yusleidy De La Caridad  
 Vazquez Suarez  
 My Commission HH 033993  
 EXP. 08/18/2024

T

**CITY OF KEY WEST INDEMNIFICATION FORM**

To the fullest extent permitted by law, the CONTRACTOR expressly agrees to indemnify and hold harmless the City of Key West, their officers, directors, agents and employees \*(herein called the "indemnitees") from liabilities, damages, losses and costs, including but not limited to, reasonable attorney's fees and court costs, such legal expenses to include costs incurred in establishing the indemnification and other rights agreed to in this Paragraph, to persons or property, to the extent caused by the negligence, recklessness, or intentional wrongful misconduct of the CONTRACTOR, its Subcontractors or persons employed or utilized by them in the performance of the Contract. Claims by indemnitees for indemnification shall be limited to the amount of CONTRACTOR's insurance or \$1 million per occurrence, whichever is greater. The parties acknowledge that the amount of the indemnity required hereunder bears a reasonable commercial relationship to the Contract and it is part of the project specifications or the bid documents, if any.

The indemnification obligations under the Contract shall not be restricted in any way by any limitation on the amount or type of damages, compensation, or benefits payable by or for the CONTRACTOR under Workers' Compensation acts, disability benefits acts, or other employee benefits acts, and shall extend to and include any actions brought by or in the name of any employee of the CONTRACTOR or of any third party to whom CONTRACTOR may subcontract a part or all of the Work. This indemnification shall continue beyond the date of completion of the work.

CONTRACTOR: 2550 S BAYSHORE DR STE 206B MIAMI, FL 33133

SEAL:

Address

Signature

JOHN KEARNS

Print Name

CFO

Title

DATE:

07/28/2021



**EQUAL BENEFITS FOR DOMESTIC PARTNERS AFFIDAVIT**

STATE OF FLORIDA )

: SS

COUNTY OF MIAMI-DADE )

I, the undersigned hereby duly sworn, depose and say that the firm of \_\_\_\_\_  
**KEARNS CONSTRUCTION COMPANY**

provides benefits to domestic partners of its employees on the same basis as it provides benefits to employees' spouses, per City of Key West Code of Ordinances Sec. 2-799.

By: **JOHN KEARNS**

*John Kearns*

Sworn and subscribed before me this 28<sup>th</sup> day of July 2021.

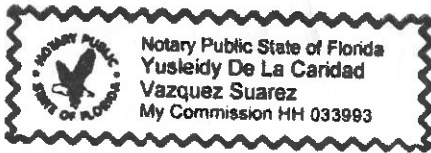

*Yusleidy*

NOTARY PUBLIC, State of Florida at Large

My Commission Expires: 08/18/2024

\* \* \* \* \*

*Te*

**CONE OF SILENCE AFFIDAVIT**

STATE OF FLORIDA )

: SS

COUNTY OF MIAMI-DADE )

I, the undersigned hereby duly sworn, depose and say that all owner(s), partners, officers, directors, employees and agents representing the firm of KEARNS CONSTRUCTION COMPANY have read and understand the limitations and procedures regarding communications concerning City of Key West Code of Ordinances Sec. 2-773 Cone of Silence.

By: JOHN KEARNS 

Sworn and subscribed before me this

28<sup>th</sup> day of July 20 21.

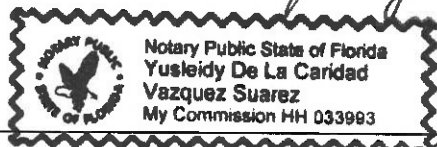



NOTARY PUBLIC, State of FLORIDA at Large

My Commission Expires: 08/18/2024



**NON-COLLUSION AFFIDAVIT**

STATE OF FLORIDA            )

:

SS COUNTY OF MONROE        )

I, the undersigned hereby declares that the only persons or parties interested in this Proposal are those named herein, that this Proposal is, in all respects, fair and without fraud, that it is made without collusion with any official of the Owner, and that the Proposal is made without any connection or collusion with any person submitting another Proposal on this Contract.

By: *[Handwritten Signature]*

Sworn and subscribed before me this

28<sup>th</sup> day of July, 2021.

*[Handwritten Signature]*  
NOTARY PUBLIC, State of Florida at Large

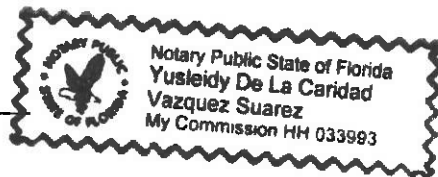

My Commission Expires: 08/18/2024

*[Handwritten Mark]*



**LOCAL VENDOR CERTIFICATION  
PURSUANT TO CITY OF KEY WEST CODE OF ORDINANCES SECTION 2-798**

The undersigned, as a duly authorized representative of the vendor listed herein, certifies to the best of his/her knowledge and belief, that the vendor meets the definition of a "Local Business." For purposes of this section, "local business" shall mean a business which:

- a. Principle address as registered with the FL Department of State located within 30 miles of the boundaries of the city, listed with the chief licensing official as having a business tax receipt with its principle address within 30 miles of the boundaries of the city for at least one year immediately prior to the issuance of the solicitation.
- b. Maintains a workforce of at least 50 percent of its employees from the city or within 30 miles of its boundaries.
- c. Having paid all current license taxes and any other fees due the city at least 24 hours prior to the publication of the call for bids or request for proposals.
  - Not a local vendor pursuant to Code of Ordinances Section 2-798
  - Qualifies as a local vendor pursuant to Code of Ordinances Section 2-798

If you qualify, please complete the following in support of the self-certification & submit copies of your County and City business licenses. Failure to provide the information requested will result in denial of certification as a local business.

Business Name \_\_\_\_\_

Phone: \_\_\_\_\_

Current Local Address: \_\_\_\_\_  
(P.O Box numbers may not be used to establish status)

Fax: \_\_\_\_\_

Length of time at this address \_\_\_\_\_

\_\_\_\_\_  
Signature of Authorized Representative

\_\_\_\_\_  
Date

STATE OF \_\_\_\_\_  
COUNTY OF \_\_\_\_\_

The foregoing instrument was acknowledged before me this \_\_\_\_\_ day of \_\_\_\_\_, 20\_\_.

By \_\_\_\_\_, of \_\_\_\_\_,  
(Name of officer or agent, title of officer or agent) Name of corporation acknowledging)  
or has produced \_\_\_\_\_ as identification  
(type of identification)

\_\_\_\_\_  
Signature of Notary

\_\_\_\_\_  
Print, Type or Stamp Name of Notary

\_\_\_\_\_  
Title or Rank

Return Completed form with  
Supporting documents to:  
City of Key West Purchasing

## BIDDER'S CHECKLIST

(Note: The purpose of this checklist is to serve as a reminder of major items to be addressed in submitting a bid and is not intended to be all inclusive. It does not alleviate the Bidder from the responsibility of becoming familiar with all aspects of the Contract Documents and Proper completion and submission of his bid.)

1. All Contract Documents thoroughly read and understood
2. All blank spaces in Bid filled in black ink.
3. Total and unit Prices added correctly.
4. Addenda acknowledged.
5. Subcontractors are named as indicated in the Bid.
6. Experience record included.
7. Bid signed by authorized officer.
8. Bid Bond completed and executed, including power-of-attorney, dated the same date as Bid Bond.
9. Bidder familiar with federal, state, and local laws, ordinances, rules and regulations affecting performance of the work.
10. Bidder, if successful, able to obtain and/or demonstrate possession of required licenses and certificates within (10) ten days after receiving a Notice of Award.
11. Bid submitted intact with the volume containing the Bidding Requirements, Contract Forms and Conditions of the Contract, one (1) original, two (2) USB drives.
12. Bid Documents submitted in sealed envelope and addressed and labeled in conformance with the instructions in the Invitation to Bid.
13. Anti-kickback Affidavit; Public Entity Crime Form; City of Key West Indemnification Equal Benefits for Domestic Partners Affidavit; Local Vendor Certification; Non-Collusion Affidavit; Proof of Required Insurance

\* \* \* \* \*



---

---

**PART 2**

**CONTRACT FORMS**

---

---



**DRAFT CONTRACT AGREEMENT**

This Contract, made and entered into \_\_\_\_\_ day of \_\_\_\_\_ 20\_\_\_\_, by and between the City of Key West, hereinafter called the "Owner", and \_\_\_\_\_, hereinafter called the "Contractor";

WITNESSETH:

The Contractor, in consideration of the sum to be paid him by the Owner and of the covenants and agreements herein contained, hereby agrees at his own proper cost and expense to do all the work and furnish all the materials, tools, labor, and all appliances, machinery, and appurtenances for **ITB #21-013 TARPON FINGER PIER EXTENSIONS – CITY MARINA at GARRISON BIGHT**

Key West, Florida to the extent of the Bid made by the Contractor, dated the \_\_\_\_\_ day of \_\_\_\_\_, 20\_\_\_\_, all in full compliance with the Contract Documents referred to herein.

The BIDDING REQUIREMENTS, including the signed copy of the BID FORM, the CONTRACT FORMS, DRAWINGS and/or SUPPLEMENTAL INFORMATION (if any), are hereby referred to and by reference made part of this Contract as fully and completely as if the same were fully set forth herein and are mutually cooperative therewith.

In consideration of the performance of the work as set forth in these Contract Documents, the Owner agrees to pay to the Contractor the amount bid in the Bid as adjusted in accordance with the Contract Documents, or as otherwise herein provided, and to make such payments in the manner and at the times provided in the Contract Documents.

The Contractor agrees to complete the work within sixty (60) calendar days and to accept as full payment hereunder the amounts computed as determined by the Contract Documents and based on the said Bid.

The Contractor agrees to remedy all defects appearing in the work or developing in the materials furnished and the workmanship performed under this Contract during the warranty period after the date of final acceptance of the work by the Owner, and further agrees to indemnify and save the Owner harmless from any costs encountered in remedying such defects.

Liquidated Damages: The Contractor recognizes that time is of the essence and that the Owner will suffer financial loss if the Work is not completed within the dates specified in the paragraphs above, plus any extensions thereof allowed, in accordance with Article 58 of the General Conditions.



In the event the Contractor fails to complete the work within the time limit or extended time limit agreed upon, as more particularly set forth in the Contract Documents, liquidated damages shall be paid at a rate of **\$250.00** per day. Sundays and legal holidays shall be included in determining days in default.

This contract will automatically expire upon completion of the project. Contractors warranty obligations remain in affect.

IN WITNESS WHEREOF, we, the parties hereto, each herewith subscribe the same this

\_\_\_\_\_ day of \_\_\_\_\_, A.D., 20\_\_.

**CITY OF KEY WEST**

By \_\_\_\_\_

Printed \_\_\_\_\_

Title \_\_\_\_\_

**CONTRACTOR**

By \_\_\_\_\_

Printed \_\_\_\_\_

Title \_\_\_\_\_

APPROVED AS TO FORM

\_\_\_\_\_  
Attorney for Owner

\* \* \* \* \*



**LICENSE REQUIREMENT AND COST**

License required for this Project. Contractor must be general contractor or building contractor.

Cost Not To Exceed \$410.00.

**CITY OF KEY WEST BUSINESS LICENSE TAX RECEIPT**

A City of Key West Business License Tax Receipt is required for this project. Contractor must be general contractor, building contractor or engineering contractor. Cost not to exceed \$410.00.

City of Key West Business License Tax Receipt may be found on the city website.

<http://www.keywestcity.com/egov/docs/1162843921181.htm>

---

---

**PART 3**

**SUPPLEMENTAL INFORMATION**

---

---





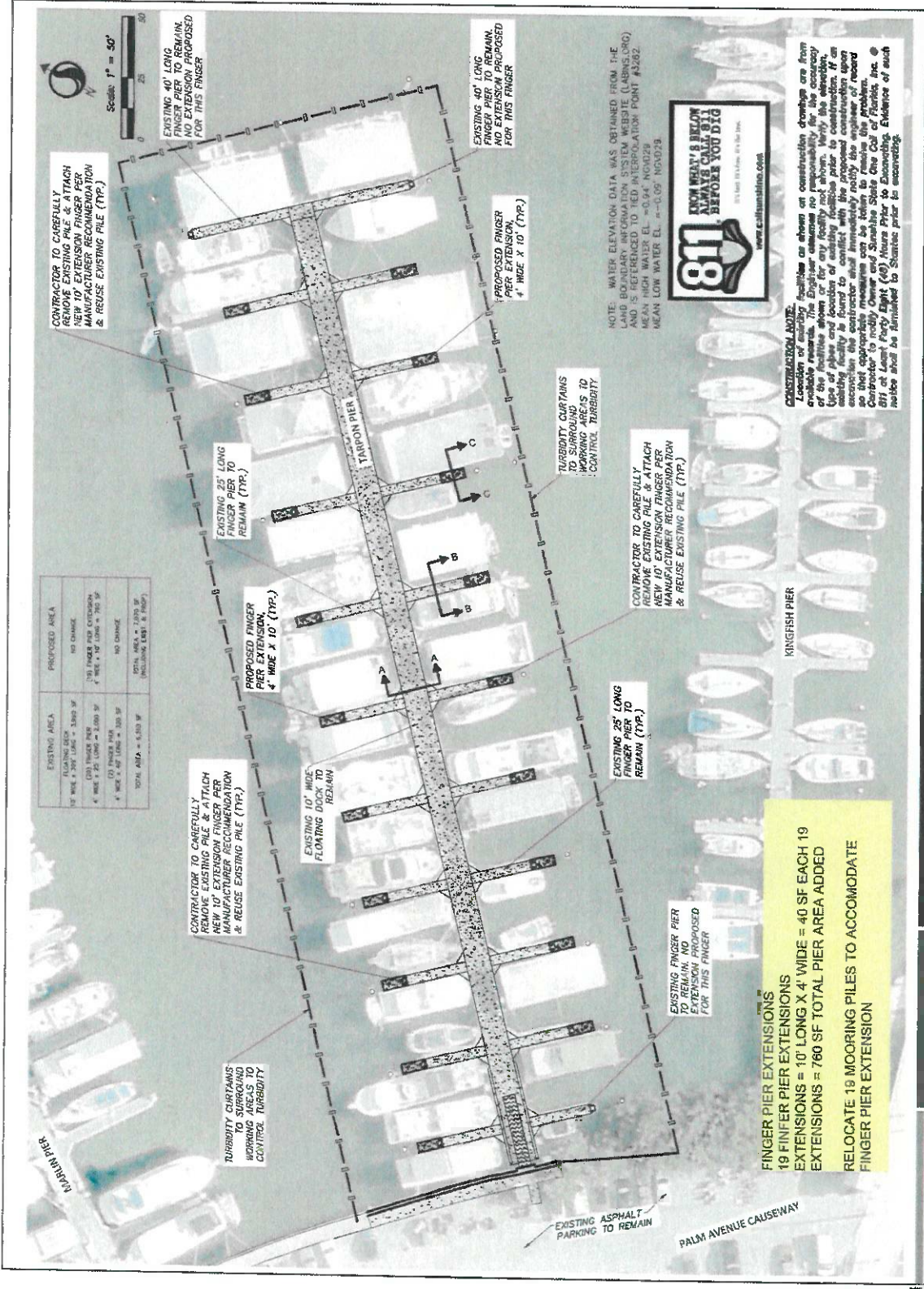

EXISTING AREA	PROPOSED AREA
10' WIDE X 20' LONG = 200 SF	NO CHANGE
(2) 10' FINGER PIER	760 FINGER PIER EXTENSION
4' WIDE X 25' LONG = 1,000 SF	4' WIDE X 10' LONG = 400 SF
(3) FINGER PIER	NO CHANGE
4' WIDE X 40' LONG = 160 SF	
TOTAL AREA = 4,300 SF	TOTAL AREA = 2,470 SF (INCLUDING 1,830' & 640')

**FINGER PIER EXTENSIONS**  
 19 FINFER PIER EXTENSIONS  
 EXTENSIONS = 10' LONG X 4' WIDE = 40 SF EACH 19  
 EXTENSIONS = 760 SF TOTAL PIER AREA ADDED

**RELOCATE 18 MOORING PILES TO ACCOMMODATE FINGER PIER EXTENSION**



**CONSTRUCTION NOTE:**  
 Location of existing facilities as shown on construction drawings are from available records. The Engineer assumes no responsibility for the accuracy of the facilities shown or for any facility not shown. Verify the elevation, location and depth of existing utilities before construction. If an existing facility is found to conflict with the proposed construction, the contractor shall immediately notify the engineer of record so that appropriate measures can be taken to resolve the problem. The contractor is responsible for obtaining all necessary permits from the appropriate authority prior to commencing. Evidence of such notice shall be furnished to Stantec prior to commencing.

**Stantec**  
 800 North West 10th Street, Suite 200  
 Fort Lauderdale, FL 33304  
 Phone: 954.473.8800  
 Fax: 954.473.8801  
 Email: info@stantec.com

**CITY OF KEY WEST**  
 KEY WEST, FLORIDA  
 Project No. 210615028  
 Drawing No. C-05  
 Date 08/11/2021  
 Scale 1" = 50'

Sheet 5 of 6

*[Handwritten signature]*

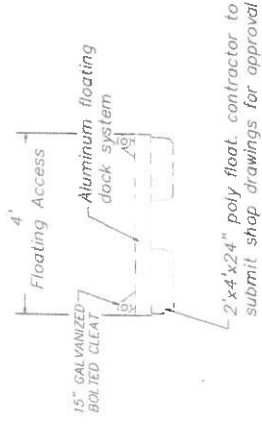

SECTION B-B/C-05  
2'x4'x24" poly float, contractor to submit shop drawings for approval

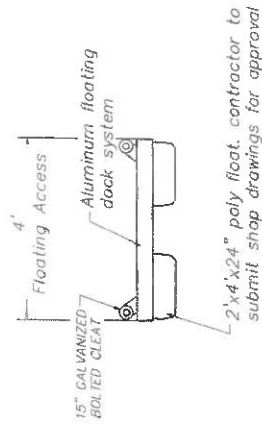

SECTION C-C/C-05  
2'x4'x24" poly float, contractor to submit shop drawings for approval

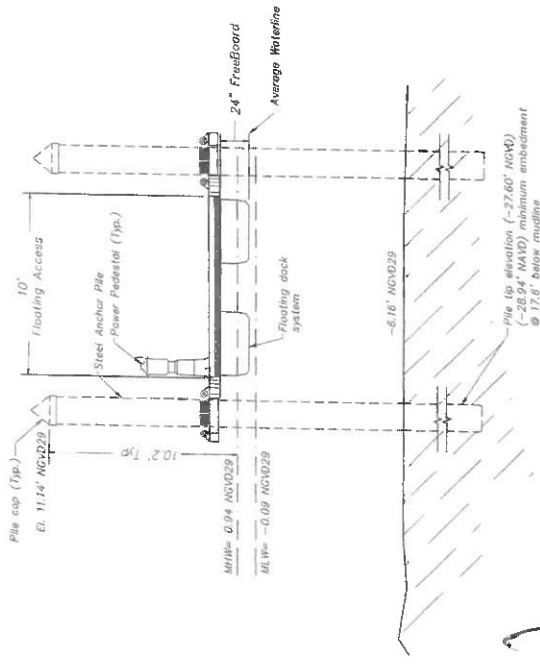

NOTE: WATER ELEVATION DATA WAS OBTAINED FROM THE LAND BOUNDARY INFORMATION SYSTEM (LBIS) AND IS REFERENCED TO MEAN HIGH WATER EL. = 0.94' NGVD29 MEAN LOW WATER EL. = -0.09' NGVD29.

EXISTING SECTION A-A/C-05  
N.T.S.

<p>951 Ponce de Leon Blvd. Suite 190 Coral Gables, Florida 33134</p> <p><small>The Contractor and user shall be responsible for all dimensions. DO NOT scale the drawings. The responsibility for all delays and omissions shall be the contractor's. All drawings are subject to change without notice.</small></p>		<p><b>CITY OF NEW WEST</b> <b>TARPON PIER EXTENSION</b> Key West, Florida</p> <p>J.B. Miller: _____ Date: _____</p>		<p><b>CROSS SECTIONS</b></p> <p>Project No. 21851908 Scale NO SCALE Drawing No. C-06 Sheet 27 of 27</p>	
<p>Contractor: _____</p>		<p>Client: _____</p>		<p>DATE: _____</p>	
<p>DESIGNED BY: _____</p>		<p>CHECKED BY: _____</p>		<p>DATE: _____</p>	



2880 WELLSVILLE AVE. SANFORD, FL 32773  
 800/235-8855 FAX 407/325-0780  
 THE SOLE PROPERTY OF GATOR DOCK & MARINE, INC. ANY REPRODUCTION IN PART OR AS A WHOLE WITHOUT THE WRITTEN PERMISSION OF GATOR DOCK & MARINE, INC. IS PROHIBITED.

No.	DATE	DESCRIPTION:
1	5/12/21	DRAFT
2	5/13/21	FOR APPROVAL

PROJECT NAME:  
**FINGER DOCK  
 EXTENSIONS**

CUSTOMER NAME:  
**CITY OF KEY WEST**

CUSTOMER ADDRESS:  
 PO BOX 1409, KEY WEST,  
 FL 33041-1409

PROJECT LOCATION:  
 18011 N. ROOSEVELT BLVD.,  
 KEY WEST, FL 33040

CMI ORDER NO.: 152708

QUST. PO NO.: 093791

DATE	NAME	DATE
5/12/21	JS	5/12/21
5/13/21	CSM	5/13/21

DRAWING NO.:  
**S-101**

FINGER DOCK EXTENSION PLAN

SHEET: 1 of 3

Approval: This drawing is hereby approved for construction. The contractor shall be responsible for obtaining all necessary permits and for ensuring that the work is done in accordance with the approved drawings. The contractor shall be responsible for ensuring that the work is done in accordance with the approved drawings. The contractor shall be responsible for ensuring that the work is done in accordance with the approved drawings.

CHAD S. McDONALD, PE  
 2880 SANDY PLAINS ROAD,  
 SANFORD, FL 32773  
 PHONE: 404-565-9283

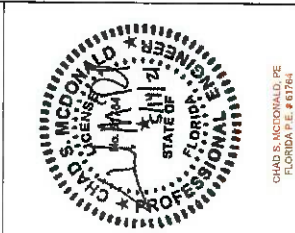

NO SITE VISIT OR ENGINEERING TESTING WAS PERFORMED TO DETERMINE FIT FOR USE FOR ANY APPLICATION. THE USER OF THIS DRAWING SHALL BE RESPONSIBLE FOR VERIFYING THAT ALL ASSUMPTIONS, AND GEOMETRY ARE MET AND SUPPORTED. THE USER SHALL BE RESPONSIBLE FOR VERIFYING THAT ALL ASSUMPTIONS, AND GEOMETRY ARE MET AND SUPPORTED. THE USER SHALL BE RESPONSIBLE FOR VERIFYING THAT ALL ASSUMPTIONS, AND GEOMETRY ARE MET AND SUPPORTED.

DATE: \_\_\_\_\_

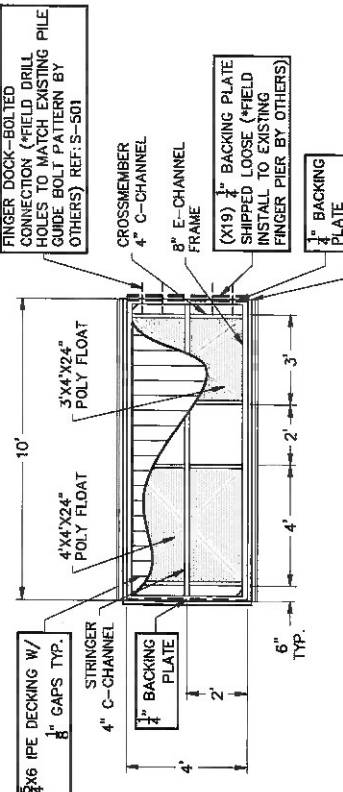

**(X19) FINGER DOCK  
 EXTENSION PLAN**  
 SCALE: 1/4" = 1'-0"  
 APPROX. WEIGHT = 1125 lbs.

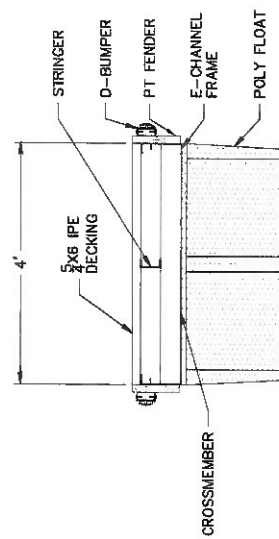

**FINGER DOCK  
 EXTENSION SECTION**  
 SCALE: 1/2" = 1'-0"

**NOTES:**

- ALL STRUCTURAL ALUMINUM IS ALLOY 6061-T6, MILL FINISH.
- ALL JOINTS ARE FULLY WELDED UNLESS NOTED OTHERWISE. FILLER METAL TO BE 5356 SERIES WIRE.
- ALL HARDWARE IS STAINLESS STEEL, SERIES 304. USE PERMATAX ANTI-SEIZE LUBRICANT OR EQUAL.
- ALL WOOD FENDERS TO BE S.Y.P. #1 PRESSURE TREATED TO 0.40 PCF ACQ MINIMUM OR EQUAL. ISOLATE WOOD FROM ALUMINUM WITH BITUMINOUS PAINT, CARBOLINE BIT 50 OR EQUAL.
- FLOATING DOCKS DESIGNED FOR ~2'-4"± UNLOADED FREEBOARD AND A MINIMUM 9" LOADED FREEBOARD UNDER A 50 PSF LIVE LOAD.
- DOCK DIMENSIONS SHOWN ARE NOMINAL FROM ALUMINUM TO ALUMINUM FRAME. FINAL FINISHED DIMENSIONS WILL VARY ACCORDING TO INSTALLED FENDERS & BUMPERS.



2800 MELLONVILLE AVE., SANFORD, FL 32773  
800/256-8857 407/323-0180

THE INFORMATION CONTAINED IN THIS DRAWING IS THE SOLE PROPERTY OF GATOR DOCK & MARINE. IT IS TO BE USED ONLY FOR THE PROJECT AND SITE SPECIFICALLY IDENTIFIED ON THE DRAWING. WITHOUT THE WRITTEN PERMISSION OF GATOR DOCK & MARINE, LLC, IT IS PROHIBITED.

RECORD OF REVISIONS	
No.	DATE DESCRIPTION
1	5/12/21 DRAFT
2	5/13/21 FOR APPROVAL

PROJECT NAME:  
**FINGER DOCK EXTENSIONS**

CUSTOMER NAME:  
**CITY OF KEY WEST**

CUSTOMER ADDRESS:  
PO BOX 1409, KEY WEST, FL 33041-1409

PROJECT LOCATION:  
18011 N. ROOSEVELT BLVD., KEY WEST, FL 33040

COM ORDER NO.: 152708

QUANTITY NO.: 093791

NAME	DATE
DRAWN BY: JS	5/12/21
CHECKED BY: CSM	5/13/21

DRAWING NO.: **S-501**

COMPONENT DETAIL

SHEET: 2 of 3

CHAD S. McDONALD, PE  
1000 S. PALM BEACH ROAD, SUITE 200, PALM BEACH, FL 33480  
PHONE: 404-956-6923

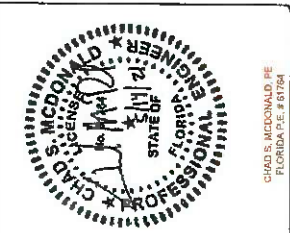

CHAD S. McDONALD, PE  
FLORIDA P.E. #12112

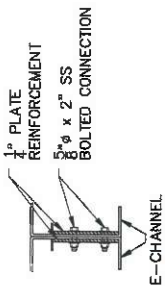

**FINGER DOCK - BOLTED CONNECTION**  
SCALE: NTS

- \*FIELD DRILL HOLES TO MATCH EXISTING PILE GUIDE BOLT PATTERN (BY OTHERS)
- \*FIELD INSTALL 1/2" BACKING PLATE TO EXISTING FINGER PIER (BY OTHERS)

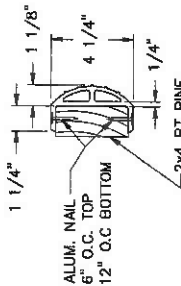

**VINYL D-BUMPER**  
SCALE: NTS  
STANDARD = BLACK

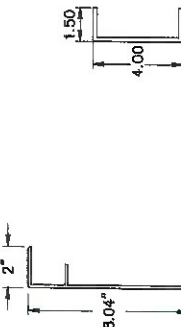

**8" E-CHANNEL**  
SCALE: NTS

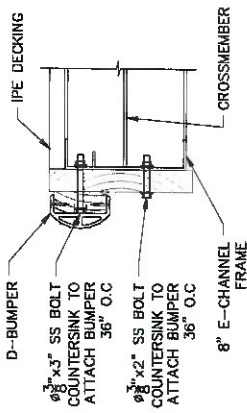

**BUMPER MOUNTING DETAIL**  
SCALE: NTS

CUSTOMER INITIAL

*Handwritten initials*

RECORD OF REVISIONS	
No.	DATE DESCRIPTION
1	5/12/21 DRAFT
2	5/13/21 FOR APPROVAL

PROJECT NAME:  
**FINGER DOCK EXTENSIONS**

CUSTOMER NAME:  
**CITY OF KEY WEST**

CUSTOMER ADDRESS:  
PO BOX 1409, KEY WEST, FL 33041-1409

PROJECT LOCATION:  
18011 N. ROOSEVELT BLVD., KEY WEST, FL 33040

CMI ORDER NO.: 152708

CIST. PO NO.: 093791

NAME	DATE
DRAWN BY: JS	5/12/21
CHECKED BY: CSM	5/13/21

DRAWING NO.: **S-602**  
WELD DETAILS

SHEET: 3 of 3  
CHAD S. MCDONALD, PE  
2582 SANDY PLAINS ROAD  
SUITE 100, KEY WEST, FL 33066  
PHONE: 404-585-6824

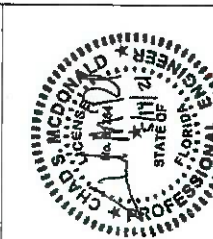

CUSTOMER INITIALS

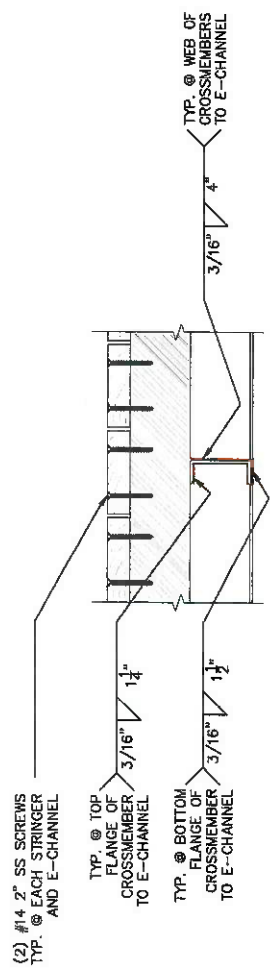

**E-CHANNEL WELDS @  
CROSSMEMBER**

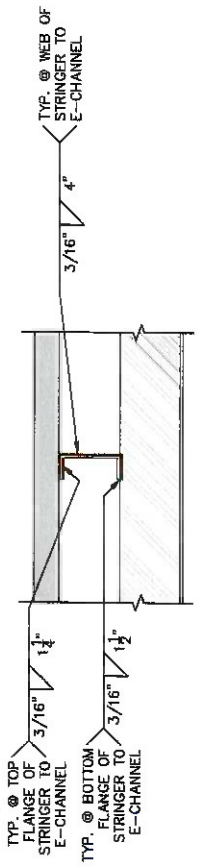

**8" E-CHANNEL WELDS  
@ STRINGER**

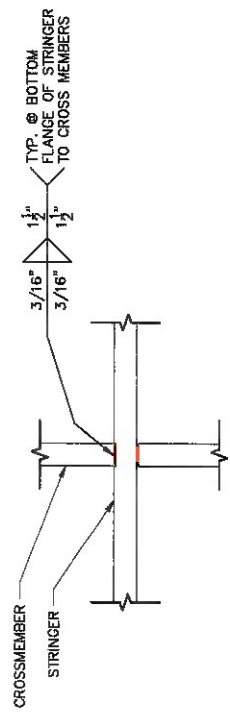

**WELDS @ CROSSMEMBERS TO  
STRINGERS**

*Handwritten initials*



# FLORIDA DEPARTMENT OF Environmental Protection

**Ron DeSantis**  
Governor

**Jeanette Nuñez**  
Lt. Governor

**Noah Valenstein**  
Secretary

South District  
Post Office Box 2549  
Fort Myers, Florida 33902-2549  
[SouthDistrict@FloridaDEP.gov](mailto:SouthDistrict@FloridaDEP.gov)

**Permittee/Authorized Entity:**  
City of Key West – Karen Olson  
1300 White Street  
Key West, FL 33040  
[kolson@cityofkeywest-fl.gov](mailto:kolson@cityofkeywest-fl.gov)

Pier Extensions for Tarpon Pier

**Authorized Agent:**  
Philip Frank  
1242 Crane Blvd  
Sugarloaf Key, FL 33042  
[Terramar.env@gmail.com](mailto:Terramar.env@gmail.com)

**Environmental Resource Permit  
State-owned Submerged Lands Authorization – Not Applicable**

**U.S. Army Corps of Engineers Authorization – Separate Corps Authorization  
Required**

Permit No.: 0116528-014 EI

**Permit Issuance Date: February 11, 2021  
Permit Construction Phase Expiration Date: February 11, 2026**

## Environmental Resource Permit

Permittee: City of Key West Marina @ Garrison Bight  
Permit No: 0116528-014 EI

### PROJECT LOCATION

The activities authorized by this permit are located at 1801 N Roosevelt Blvd, 0072070 000000, Key West, Florida 33040, in Section 32, Township 67, Range 25, in Monroe County.

### PROJECT DESCRIPTION

The permittee is authorized to extend 19 finger piers at the City of Key West's Tarpon Pier for a new total over water structure of 7,070 square feet in Garrison Bight, Class III Waters. Authorized activities are depicted on the attached exhibits.

### AUTHORIZATIONS

Pier Extensions for Tarpon Pier

#### Environmental Resource Permit

The Department has determined that the activity qualifies for an Environmental Resource Permit. Therefore, the Environmental Resource Permit is hereby granted, pursuant to Part IV of Chapter 373, Florida Statutes (F.S.), and Chapter 62-330, Florida Administrative Code (F.A.C.).

#### Sovereignty Submerged Lands Authorization

As staff to the Board of Trustees of the Internal Improvement Trust Fund (Board of Trustees), the Department has determined the activity is not on submerged lands owned by the State of Florida. Therefore, your project is not subject to the requirements of Chapter 253, F.S. or Rule 18-21, F.A.C.

#### Federal Authorization

Your proposed activity as outlined on your application and attached drawings does not qualify for Federal authorization pursuant to the State Programmatic General Permit and a SEPARATE permit or authorization shall be required from the Corps. You must apply separately to the Corps using their *APPLICATION FOR DEPARTMENT OF THE ARMY PERMIT*, ENG FORM 4345, or alternative as allowed by their regulations. More information on Corps permitting may be found online in the Jacksonville District Regulatory Division Source Book at:

<https://www.saj.usace.army.mil/Missions/Regulatory/Source-Book/>.

Authority for review - an agreement with the USACOE entitled "Coordination Agreement Between the U. S. Army Corps of Engineers (Jacksonville District) and the Florida Department of Environmental Protection, or Duly Authorized Designee, State Programmatic General Permit", Section 10 of the Rivers and Harbor Act of 1899, and Section 404 of the Clean Water Act.

#### Coastal Zone Management

Issuance of this authorization also constitutes a finding of consistency with Florida's Coastal Zone Management Program, as required by Section 307 of the Coastal Zone Management Act.



Water Quality Certification

This permit also constitutes a water quality certification under Section 401 of the Clean Water Act, 33 U.S.C. 1341.

Other Authorizations

You are advised that authorizations or permits for this activity may be required by other federal, state, regional, or local entities including but not limited to local governments or municipalities. This permit does not relieve you from the requirements to obtain all other required permits or authorizations.

The activity described may be conducted only in accordance with the terms, conditions and attachments contained in this document. Issuance and granting of the permit and authorizations herein do not infer, nor guarantee, nor imply that future permits, authorizations, or modifications will be granted by the Department.

**PERMIT CONDITIONS**

The activities described must be conducted in accordance with:

- **The Specific Conditions**
- **The General Conditions**
- **The limits, conditions and locations of work shown in the attached drawings**
- **The term limits of this authorization**

You are advised to read and understand these conditions and drawings prior to beginning the authorized activities, and to ensure the work is conducted in conformance with all the terms, conditions, and drawings herein. If you are using a contractor, the contractor also should read and understand these conditions and drawings prior to beginning any activity. Failure to comply with these conditions, including any mitigation requirements, shall be grounds for the Department to revoke the permit and authorization and to take appropriate enforcement action.

Operation of the facility is not authorized except when determined to be in conformance with all applicable rules and this permit, as described.

**SPECIFIC CONDITIONS – ADMINISTRATIVE**

1. All required submittals, such as certifications, monitoring reports, notifications, etc., shall be submitted to the Florida Department of Environmental Protection, South District Office, Submerged Lands and Environmental Resource Permitting, P.O. Box 2549, Fort Myers, FL 33902-2549 or via e-mail to [FTMERP\\_Compliance@dep.state.fl.us](mailto:FTMERP_Compliance@dep.state.fl.us) . All submittals shall include the project name and indicated permit number when referring to this project.

*Note: In the event of an emergency, the Permittee should contact the Department by calling (800)320-0519. During normal business hours, the permittee should call (239)344-5600.*





### **SPECIFIC CONDITIONS – CONSTRUCTION ACTIVITIES**

2. Best management practices (primarily turbidity screens) for erosion and turbidity control shall be implemented and maintained at all times during construction and operation of the permitted activity to prevent siltation and turbid discharges in excess of State water standards pursuant to Rule 62-302, F.A.C. The Permittee shall be responsible for ensuring that erosion and turbidity control devices and procedures are inspected and maintained daily during all phases of construction authorized by this permit until all areas that were disturbed during construction are sufficiently stabilized to prevent erosion, siltation, and turbid discharges.
3. The project shall comply with applicable State Water Quality Standards of Chapters 62-302 and 62-4, F.A.C., namely:  
62-302.500 – Minimum Criteria for All Waters at All Times and All Places  
62-302.530 – Surface Water Quality Criteria

### **SPECIFIC CONDITIONS LISTED SPECIES**

4. This permit does not authorize the permittee to cause any adverse impact to or “take” of state listed species and other regulated species of fish and wildlife. Compliance with state laws regulating the take of fish and wildlife is the responsibility of the owner or applicant associated with this project. Please refer to Chapter 68A-27 of the Florida Administrative Code for definitions of “take” and a list of fish and wildlife species. If listed species are observed onsite, FWC staff are available to provide decision support information or assist in obtaining the appropriate FWC permits. Most marine endangered and threatened species are statutorily protected and a “take” permit cannot be issued. Requests for further information or review can be sent to [FWCConservationPlanningServices@MyFWC.com](mailto:FWCConservationPlanningServices@MyFWC.com).

### **SPECIFIC MANATEE PROTECTION CONDITIONS**

5. All personnel associated with the project shall be instructed about the presence of manatees and manatee speed zones, and the need to avoid collisions with, and injury to manatees. The permittee shall advise all construction personnel that there are civil and criminal penalties for harming, harassing, or killing manatees which are protected under the Marine Mammal Protection Act, the Endangered Species Act, and the Florida Manatee Sanctuary Act.
6. All vessels associated with the construction project shall operate at "Idle Speed/No Wake" at all times while in the immediate area and while in water where the draft of the vessel provides less than a four-foot clearance from the bottom. All vessels shall follow routes of deep water whenever possible.
7. Siltation or turbidity barriers shall be made of material in which manatees cannot become entangled, shall be properly secured, and shall be regularly monitored to avoid manatee entanglement or entrapment. Barriers shall not impede manatee movement.



8. All on-site project personnel are responsible for observing water-related activities for the presence of manatees. All in-water operations, including vessels, shall be shutdown if a manatee comes within 50 feet of the operation. Activities shall not resume until every manatee has moved beyond the 50-foot radius of the project operation, or until 30 minutes has elapsed wherein a manatee has not reappeared within 50 feet of the operation. Animals shall not be herded away or harassed into leaving.
9. Any collision with or injury to a manatee shall be reported immediately to the FWC Hotline at 1-888-404-FWCC. Collision and/or injury should also be reported to the U.S. Fish and Wildlife Service in Jacksonville (1-904-731-3336) for north Florida or Vero Beach (1-772-562-3909) for south Florida.
10. Temporary signs concerning manatees shall be posted prior to and during all in-water project activities. All signs are to be removed by the permittee upon completion of the project. Awareness signs that have already been approved for this use by the Florida Fish and Wildlife Conservation Commission (FWC) must be used. One sign measuring at least 3 ft. by 4 ft. which reads *Caution: Manatee Area* must be posted. A second sign measuring at least 8 1/2" by 11" explaining the requirements for "Idle Speed/No Wake" and the shutdown of in-water operations must be posted in a location prominently visible to all personnel engaged in water-related activities. Please see the Florida Fish and Wildlife Conservation Commission website for information on how to obtain appropriate signs: [http://www.myfwc.com/docs/WildlifeHabitats/Manatee\\_EducationalSign.pdf](http://www.myfwc.com/docs/WildlifeHabitats/Manatee_EducationalSign.pdf)

#### **GENERAL CONDITIONS FOR INDIVIDUAL PERMITS**

The following general conditions are binding on all individual permits issued under chapter 62-330, F.A.C., except where the conditions are not applicable to the authorized activity, or where the conditions must be modified to accommodate project-specific conditions.

1. All activities shall be implemented following the plans, specifications and performance criteria approved by this permit. Any deviations must be authorized in a permit modification in accordance with Rule 62-330.315, F.A.C. Any deviations that are not so authorized may subject the permittee to enforcement action and revocation of the permit under Chapter 373, F.S.
2. A complete copy of this permit shall be kept at the work site of the permitted activity during the construction phase, and shall be available for review at the work site upon request by the Agency staff. The permittee shall require the contractor to review the complete permit prior to beginning construction.
3. Activities shall be conducted in a manner that does not cause or contribute to violations of state water quality standards. Performance-based erosion and sediment control best management practices shall be installed immediately prior to, and be maintained during and after construction as needed, to prevent adverse impacts to the water resources and adjacent lands. Such practices shall be in accordance with the *State of Florida Erosion and Sediment Control Designer and Reviewer Manual (Florida Department of Environmental Protection and Florida Department of Transportation June 2007)*, and the *Florida Stormwater Erosion and Sedimentation Control*



*Inspector's Manual (Florida Department of Environmental Protection, Nonpoint Source Management Section, Tallahassee, Florida, July 2008)*, which are both incorporated by reference in subparagraph 62-330.050(9)(b)5., F.A.C., unless a project-specific erosion and sediment control plan is approved or other water quality control measures are required as part of the permit.

4. At least 48 hours prior to beginning the authorized activities, the permittee shall submit to the Agency a fully executed Form 62-330.350(1), "Construction Commencement Notice," [October 1, 2013], which is incorporated by reference in paragraph 62-330.350(1)(d), F.A.C., indicating the expected start and completion dates. A copy of this form may be obtained from the Agency, as described in subsection 62-330.010(5), F.A.C. If available, an Agency website that fulfills this notification requirement may be used in lieu of the form.
5. Unless the permit is transferred under Rule 62-330.340, F.A.C., or transferred to an operating entity under Rule 62-330.310, F.A.C., the permittee is liable to comply with the plans, terms and conditions of the permit for the life of the project or activity.
6. Within 30 days after completing construction of the entire project, or any independent portion of the project, the permittee shall provide the following to the Agency, as applicable:
  - a. For an individual, private single-family residential dwelling unit, duplex, triplex, or quadruplex "Construction Completion and Inspection Certification for Activities Associated With a Private Single-Family Dwelling Unit" [Form 62-330.310(3)]; or
  - b. For all other activities "As-Built Certification and Request for Conversion to Operational Phase" [Form 62-330.310(1)].
  - c. If available, an Agency website that fulfills this certification requirement may be used in lieu of the form.
7. If the final operation and maintenance entity is a third party:
  - a. Prior to sales of any lot or unit served by the activity and within one year of permit issuance, or within 30 days of as-built certification, whichever comes first, the permittee shall submit, as applicable, a copy of the operation and maintenance documents (see sections 12.3 thru 12.3.3 of Volume I) as filed with the Department of State, Division of Corporations and a copy of any easement, plat, or deed restriction needed to operate or maintain the project, as recorded with the Clerk of the Court in the County in which the activity is located.
  - b. Within 30 days of submittal of the as-built certification, the permittee shall submit "Request for Transfer of Environmental Resource Permit to the Perpetual Operation Entity" [Form 62-330.310(2)] to transfer the permit to the operation and maintenance entity, along with the documentation requested in the form. If available, an Agency website that fulfills this transfer requirement may be used in lieu of the form.
8. The permittee shall notify the Agency in writing of changes required by any other regulatory agency that require changes to the permitted activity, and any required modification of this permit must be obtained prior to implementing the changes.



9. This permit does not:
  - a. Convey to the permittee any property rights or privileges, or any other rights or privileges other than those specified herein or in Chapter 62-330, F.A.C.;
  - b. Convey to the permittee or create in the permittee any interest in real property;
  - c. Relieve the permittee from the need to obtain and comply with any other required federal, state, and local authorization, law, rule, or ordinance; or
  - d. Authorize any entrance upon or work on property that is not owned, held in easement, or controlled by the permittee.
  
10. Prior to conducting any activities on state-owned submerged lands or other lands of the state, title to which is vested in the Board of Trustees of the Internal Improvement Trust Fund, the permittee must receive all necessary approvals and authorizations under Chapters 253 and 258, F.S. Written authorization that requires formal execution by the Board of Trustees of the Internal Improvement Trust Fund shall not be considered received until it has been fully executed.
  
11. The permittee shall hold and save the Agency harmless from any and all damages, claims, or liabilities that may arise by reason of the construction, alteration, operation, maintenance, removal, abandonment or use of any project authorized by the permit.
  
12. The permittee shall notify the Agency in writing:
  - a. Immediately if any previously submitted information is discovered to be inaccurate; and
  - b. Within 30 days of any conveyance or division of ownership or control of the property or the system, other than conveyance via a long-term lease, and the new owner shall request transfer of the permit in accordance with Rule 62-330.340, F.A.C. This does not apply to the sale of lots or units in residential or commercial subdivisions or condominiums where the stormwater management system has been completed and converted to the operation phase.
  
13. Upon reasonable notice to the permittee, Agency staff with proper identification shall have permission to enter, inspect, sample and test the project or activities to ensure conformity with the plans and specifications authorized in the permit.
  
14. If any prehistoric or historic artifacts, such as pottery or ceramics, stone tools or metal implements, dugout canoes, or any other physical remains that could be associated with Native American cultures, or early colonial or American settlement are encountered at any time within the project site area, work involving subsurface disturbance in the immediate vicinity of such discoveries shall cease. The permittee or other designee shall contact the Florida Department of State, Division of Historical Resources, Compliance and Review Section, at (850) 245-6333 or (800) 847-7278, as well as the appropriate permitting agency office. Such subsurface work shall not resume without verbal or written authorization from the Division of Historical Resources. If unmarked human remains are encountered, all work shall stop immediately and notification shall be provided in accordance with Section 872.05, F.S.
  
15. Any delineation of the extent of a wetland or other surface water submitted as part of the permit application, including plans or other supporting documentation, shall not be considered



binding unless a specific condition of this permit or a formal determination under Rule 62-330.201, F.A.C., provides otherwise.

16. The permittee shall provide routine maintenance of all components of the stormwater management system to remove trapped sediments and debris. Removed materials shall be disposed of in a landfill or other uplands in a manner that does not require a permit under Chapter 62-330, F.A.C., or cause violations of state water quality standards.

17. This permit is issued based on the applicant's submitted information that reasonably demonstrates that adverse water resource-related impacts will not be caused by the completed permit activity. If any adverse impacts result, the Agency will require the permittee to eliminate the cause, obtain any necessary permit modification, and take any necessary corrective actions to resolve the adverse impacts.

18. A Recorded Notice of Environmental Resource Permit may be recorded in the county public records in accordance with subsection 62-330.090(7), F.A.C. Such notice is not an encumbrance upon the property.

## **NOTICE OF RIGHTS**

This action is final and effective on the date filed with the Clerk of the Department unless a petition for an administrative hearing is timely filed under Sections 120.569 and 120.57, F.S., before the deadline for filing a petition. On the filing of a timely and sufficient petition, this action will not be final and effective until further order of the Department. Because the administrative hearing process is designed to formulate final agency action, the hearing process may result in a modification of the agency action or even denial of the application.

### Petition for Administrative Hearing

A person whose substantial interests are affected by the Department's action may petition for an administrative proceeding (hearing) under Sections 120.569 and 120.57, F.S. Pursuant to Rule 28-106.201, F.A.C., a petition for an administrative hearing must contain the following information:

- (a) The name and address of each agency affected and each agency's file or identification number, if known;
- (b) The name, address, any email address, any facsimile number, and telephone number of the petitioner; the name, address, and telephone number of the petitioner's representative, if any, which shall be the address for service purposes during the course of the proceeding; and an explanation of how the petitioner's substantial interests are or will be affected by the agency determination;
- (c) A statement of when and how the petitioner received notice of the agency decision;
- (d) A statement of all disputed issues of material fact. If there are none, the petition must so indicate;
- (e) A concise statement of the ultimate facts alleged, including the specific facts that the petitioner contends warrant reversal or modification of the agency's proposed action;



- (f) A statement of the specific rules or statutes that the petitioner contends require reversal or modification of the agency's proposed action, including an explanation of how the alleged facts relate to the specific rules or statutes; and
- (g) A statement of the relief sought by the petitioner, stating precisely the action that the petitioner wishes the agency to take with respect to the agency's proposed action.

The petition must be filed (received by the Clerk) in the Office of General Counsel of the Department at 3900 Commonwealth Boulevard, Mail Station 35, Tallahassee, Florida 32399-3000. Also, a copy of the petition shall be mailed to the applicant at the address indicated above at the time of filing.

#### Time Period for Filing a Petition

In accordance with Rule 62-110.106(3), F.A.C., petitions for an administrative hearing by the applicant must be filed within 21 days of receipt of this written notice. Petitions filed by any persons other than the applicant, and other than those entitled to written notice under Section 120.60(3), F.S., must be filed within 21 days of publication of the notice or within 21 days of receipt of the written notice, whichever occurs first. Under Section 120.60(3), F.S., however, any person who has asked the Department for notice of agency action may file a petition within 21 days of receipt of such notice, regardless of the date of publication. The failure to file a petition within the appropriate time period shall constitute a waiver of that person's right to request an administrative determination (hearing) under Sections 120.569 and 120.57, F.S., or to intervene in this proceeding and participate as a party to it. Any subsequent intervention (in a proceeding initiated by another party) will be only at the discretion of the presiding officer upon the filing of a motion in compliance with Rule 28-106.205, F.A.C.

#### Extension of Time

Under Rule 62-110.106(4), F.A.C., a person whose substantial interests are affected by the Department's action may also request an extension of time to file a petition for an administrative hearing. The Department may, for good cause shown, grant the request for an extension of time. Requests for extension of time must be filed with the Office of General Counsel of the Department at 3900 Commonwealth Boulevard, Mail Station 35, Tallahassee, Florida 32399-3000, before the applicable deadline for filing a petition for an administrative hearing. A timely request for extension of time shall toll the running of the time period for filing a petition until the request is acted upon.

#### Mediation

Mediation is not available in this proceeding.

#### FLAWAC Review

The applicant, or any party within the meaning of Section 373.114(1)(a) or 373.4275, F.S., may also seek appellate review of this order before the Land and Water Adjudicatory Commission under Section 373.114(1) or 373.4275, F.S. Requests for review before the Land and Water Adjudicatory Commission must be filed with the Secretary of the Commission and served on the Department within 20 days from the date when this order is filed with the Clerk of the Department.



Judicial Review

Once this decision becomes final, any party to this action has the right to seek judicial review pursuant to Section 120.68, F.S., by filing a Notice of Appeal pursuant to Rules 9.110 and 9.190, Florida Rules of Appellate Procedure, with the Clerk of the Department in the Office of General Counsel, 3900 Commonwealth Boulevard, M.S. 35, Tallahassee, Florida 32399-3000; and by filing a copy of the Notice of Appeal accompanied by the applicable filing fees with the appropriate District Court of Appeal. The Notice of Appeal must be filed within 30 days from the date this action is filed with the Clerk of the Department.

Executed in Orlando, Florida.

STATE OF FLORIDA DEPARTMENT  
OF ENVIRONMENTAL PROTECTION



\_\_\_\_\_  
Jon M. Iglehart  
District Director  
South District Office

**Attachments:**

6 project drawing(s)

**CERTIFICATE OF SERVICE**

The undersigned duly designated deputy clerk hereby certifies that this document and all attachments, including all copies, were sent to the addressee and to the following listed persons:

U.S. Army Corps of Engineers, Miami Office, SEAppls@usace.army.mil  
Monroe County Property Appraiser, rshaw@mcpafl.org

**FILING AND ACKNOWLEDGMENT**

FILED, on this date, pursuant to Section 120.52(7), F.S., with the designated Department clerk, receipt of which is hereby acknowledged.



\_\_\_\_\_  
Clerk

February 11, 2021  
Date





**Received Electronically**  
 October 30, 2020  
 South District



# CITY OF KEY WEST TARPON PIER - FINGER PIER MODIFICATIONS CITY MARINA AT GARRISON BIGHT, ITB# 00-000

MONROE COUNTY, FLORIDA  
 STANTEC PROJECT NO. 215615888  
 SECTION : 32  
 TOWNSHIP: 67S  
 RANGE: 25E  
 LATITUDE: 24°33'36"  
 LONGITUDE: 81°47'01"

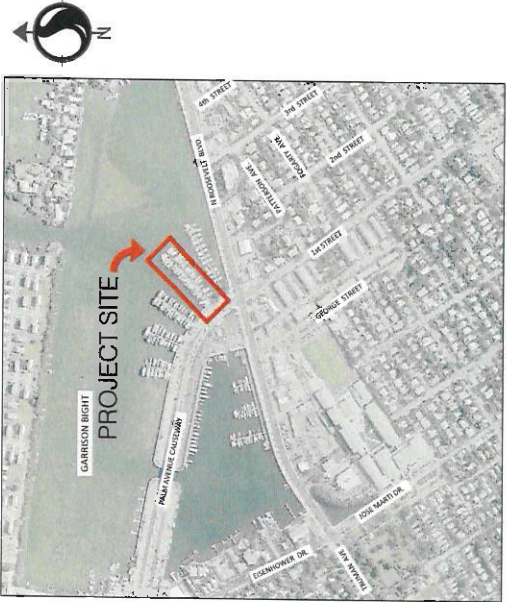

**MAYOR & COMMISSION:**  
 Teri Johnston, Mayor  
 Jimmy Weekley, Commissioner  
 Samuel Kaufman, Commissioner  
 Billy Wardlow, Commissioner  
 Gregory Davila, Commissioner  
 Mary Lou Hoover, Commissioner  
 Clayton Lopez, Commissioner  
 City Manager: Greg Veliz

**INDEX OF SHEETS**

SHEET NO.	SHEET DESCRIPTION
C-01	COVER
C-02	OVERALL PLAN
C-03	#####
C-04	#####
C-05	#####
C-06	CROSS SECTIONS

**LOCATION MAP**  
 Scale: N.T.S.

**PERMIT SET**  
 SEPTEMBER 2020



**Stantec**  
 901 Ponce de Leon Blvd., Suite 900  
 Coral Gables, Florida, 33134  
 Tel. 305-445-2800  
 Fax. 305-445-3344  
 www.stantec.com

*****APPROVALS*****		PERMIT NUMBER
AGENCY	SUBMITTAL DATE	APPROVAL DATE

APPROVED BY  
 CARLOS M. HERDOCIA  
 REGISTERED ENGINEER NO. 47660  
 STATE OF FLORIDA

*Handwritten signature*



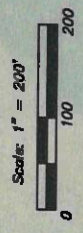

GARRISON BIGHT

PROJECT BOUNDARY

PROP. STAGING AREA CONTRACTOR TO PROVIDE SECURITY FENCE & LIGHTING AROUND PARKING AND STAGE AREA.



NOTE: WATER ELEVATION DATA WAS OBTAINED FROM THE LAND BOUNDARY INFORMATION SYSTEM WEBSITE (LABINS.ORG) AND IS REFERENCED TO TIED INTERPOLATION POINT #3262.  
MEAN HIGH WATER EL. = 0.94' NGVD29  
MEAN LOW WATER EL. = -0.09' NGVD29.

<p>901 Rosewood Boulevard, Suite 100 Coral Gables, Florida 33134 www.stantec.com</p>		<p>CITY OF KEY WEST DOLPHIN PIER EXTENSION KEY WEST, FLORIDA</p>		<p>OVERALL PLAN Project No. 21819888 Drawing No. C-02 Scale Sheet of 5</p>	
<p>CONSULTANTS</p>		<p>DATE: 10/30/20 BY: [Signature]</p>		<p>DATE: 10/30/20 BY: [Signature]</p>	
<p>ORIS H. JOHNSON, P.E. REGISTERED PROFESSIONAL ENGINEER STATE OF FLORIDA</p>		<p>DATE: 10/30/20 BY: [Signature]</p>		<p>DATE: 10/30/20 BY: [Signature]</p>	

*[Handwritten signature]*

NOTE: ELEVATIONS SHOWN HEREON ARE IN FEET AND BASED ON THE NATIONAL GEODETIC VERTICAL DATUM OF 1929 (NGVD 1929)  
 BENCHMARK DESCRIPTION: NATIONAL GEODETIC SURVEY BENCHMARK, DESIGNATION W267, P.I.D. AA0022, ELEVATION 5.09' (NGVD 1929)  
 MEAN LOW WATER ELEVATION AT TIME OF SURVEY = -0.09 NGVD 1929  
 MEAN HIGH WATER ELEVATION AT TIME OF SURVEY = 0.94 NGVD 1929

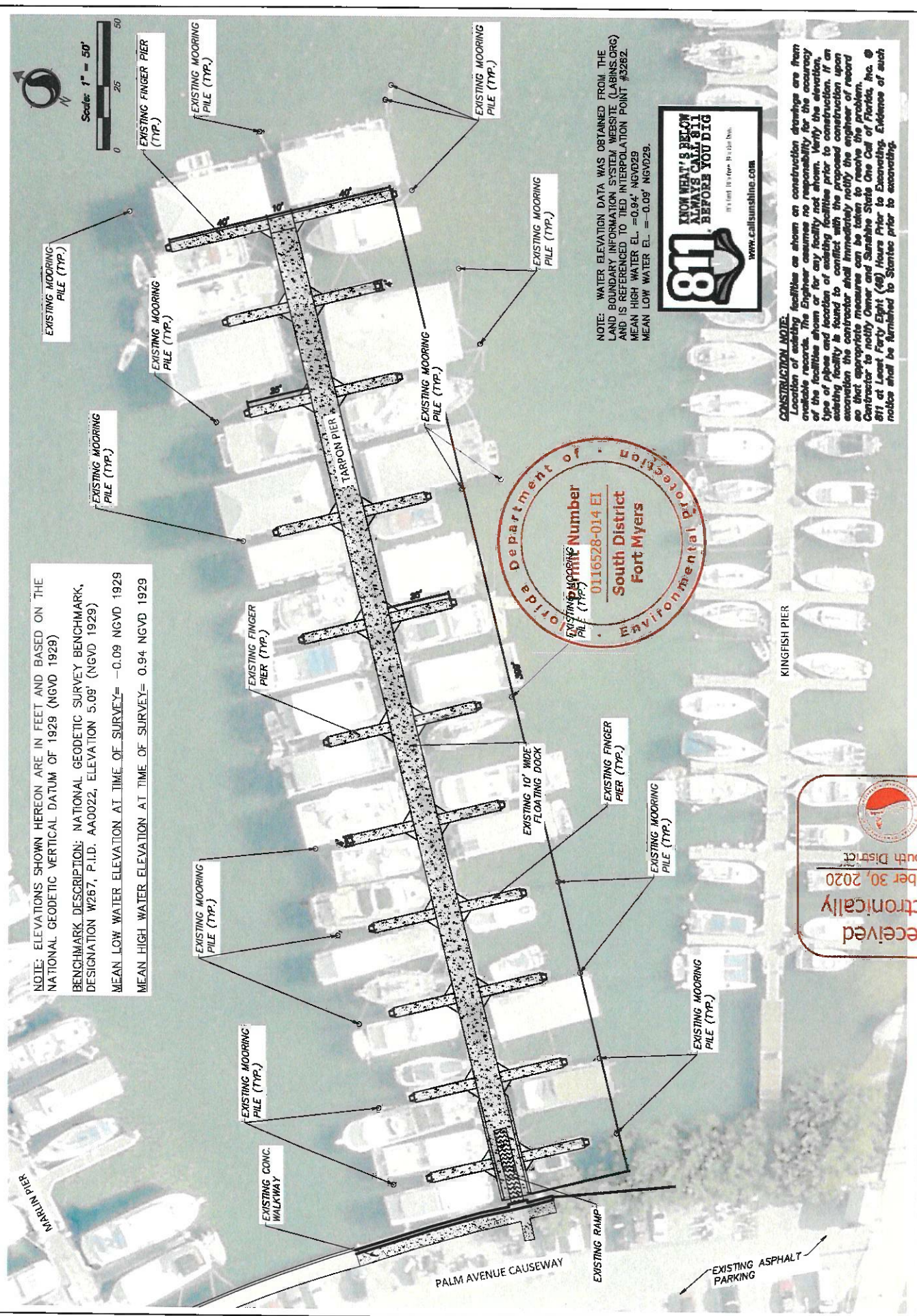

Florida Department of  
 Environmental Protection  
 Permitting Number  
 0116528-014 EI  
 South District  
 Fort Myers

NOTE: WATER ELEVATION DATA WAS OBTAINED FROM THE LAND BOUNDARY INFORMATION SYSTEM WEBSITE (LUBINS.ORG) AND IS REFERENCED TO TIED INTERPOLATION POINT #3282.  
 MEAN HIGH WATER EL. = -0.94' NGVD29  
 MEAN LOW WATER EL. = -0.09' NGVD29.



**CONSTRUCTION NOTE:**  
 Location of existing facilities as shown on construction drawings are from available records. The Engineer assumes no responsibility for the accuracy of the facilities shown or for any facility not shown. Verify the elevation, type of pipe and location of existing facilities prior to construction. If an existing facility is found to conflict with the proposed construction upon excavation the contractor shall immediately notify the engineer of record so that appropriate measures can be taken to resolve the problem. Contractor to notify Owner and Sunshine State One Call of Florida, Inc. @ 811 at Least Forty Eight (48) Hours Prior to Excavating. Evidence of such notice shall be furnished to Stantec prior to excavating.

Received  
 Electronically  
 October 30, 2020  
 South District

<b>DEMOLITION PLAN</b> Project No. 21501588 Sheet C-04 of 5 Revision	
CITY OF KEY WEST DOLPHIN PIER EXTENSION KEY WEST, FLORIDA	Date Issued: _____ Date: _____ Drawn By: _____ Check By: _____ Title: _____
 Stantec 9011 Florida Ave, Suite 200 Fort Myers, FL 33907 Phone: (941) 336-1314 Fax: (941) 336-1315	PROJECT NO. 21501588 SHEET NO. C-04 OF 5
RECEIVED ELECTRONICALLY OCTOBER 30, 2020 SOUTH DISTRICT	FOR THE ENGINEER, P.E. REGISTERED ENGINEER IN FLORIDA STATE OF FLORIDA
Issued By: _____ Title: _____ Date: _____	Checked By: _____ Title: _____ Date: _____

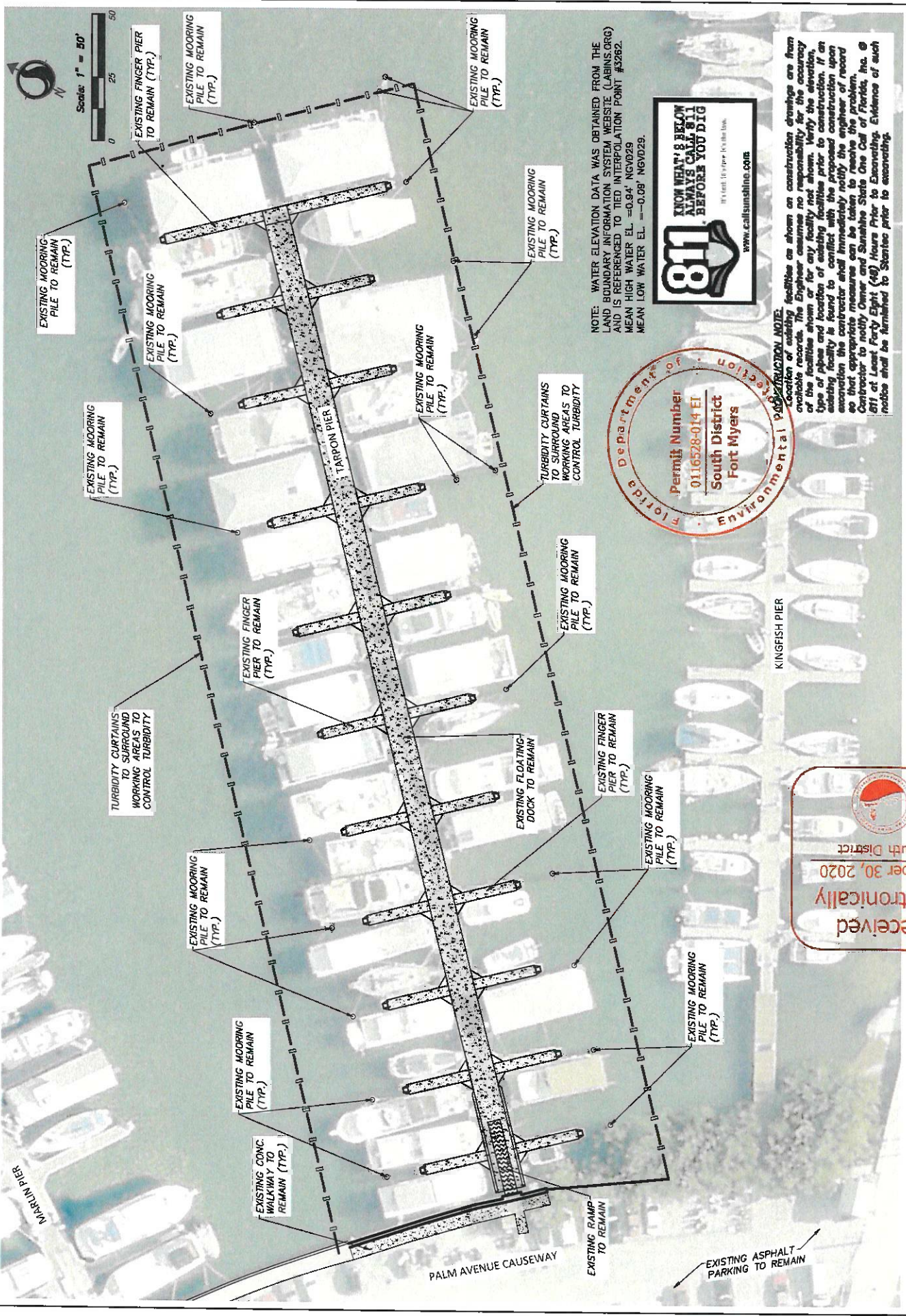

<b>DEMOLITION PLAN</b> Project No. 219615888 Sheet C-04 of 5	
CITY OF KEY WEST DOLPHIN PIER EXTENSION KEY WEST, FLORIDA	
Date: _____ Drawn: _____ Check: _____ Title: _____	Date: _____ Drawn: _____ Check: _____ Title: _____
<b>Stantec</b> <small>9911 Executive Parkway, Suite 100          Fort Myers, FL 33907          www.stantec.com</small>	
CONSTRUCTION NOTE: Location of existing facilities as shown on construction drawings are from available records. The Engineer assumes no responsibility for the accuracy of the facilities shown or for any facility not shown. Verify the elevation, type of pipe and location of existing facilities prior to construction. If an existing facility is found to conflict with the proposed construction upon excavation the contractor shall immediately notify the engineer of record so that appropriate measures can be taken to resolve the problem. Contractor to notify Owner and Sunshine State One Call of Florida, Inc. @ 811 at Least Forty Eight (48) Hours Prior to Excavating. Evidence of such notices shall be furnished to Stantec prior to excavating.	
Permit Number: 0116528-014 EI South District Fort Myers Florida Department of Environmental Protection	
Received Electronically October 30, 2020 South District	
Received: _____ By: _____ Title: _____	Received: _____ By: _____ Title: _____

EXISTING AREA	PROPOSED AREA
FLATBANK DOCK 10' WIDE X 384' LONG = 3,840 SF	NO CHANGE
(10) FINGER PIER EXTENSIONS 4' WIDE X 25' LONG = 1,000 SF	(10) FINGER PIER EXTENSIONS 4' WIDE X 10' LONG = 400 SF
(2) FINGER PIER 4' WIDE X 40' LONG = 320 SF	NO CHANGE
TOTAL AREA = 5,160 SF (INCLUDING EXIST. & PROPOSED)	TOTAL AREA = 7,070 SF (INCLUDING EXIST. & PROPOSED)

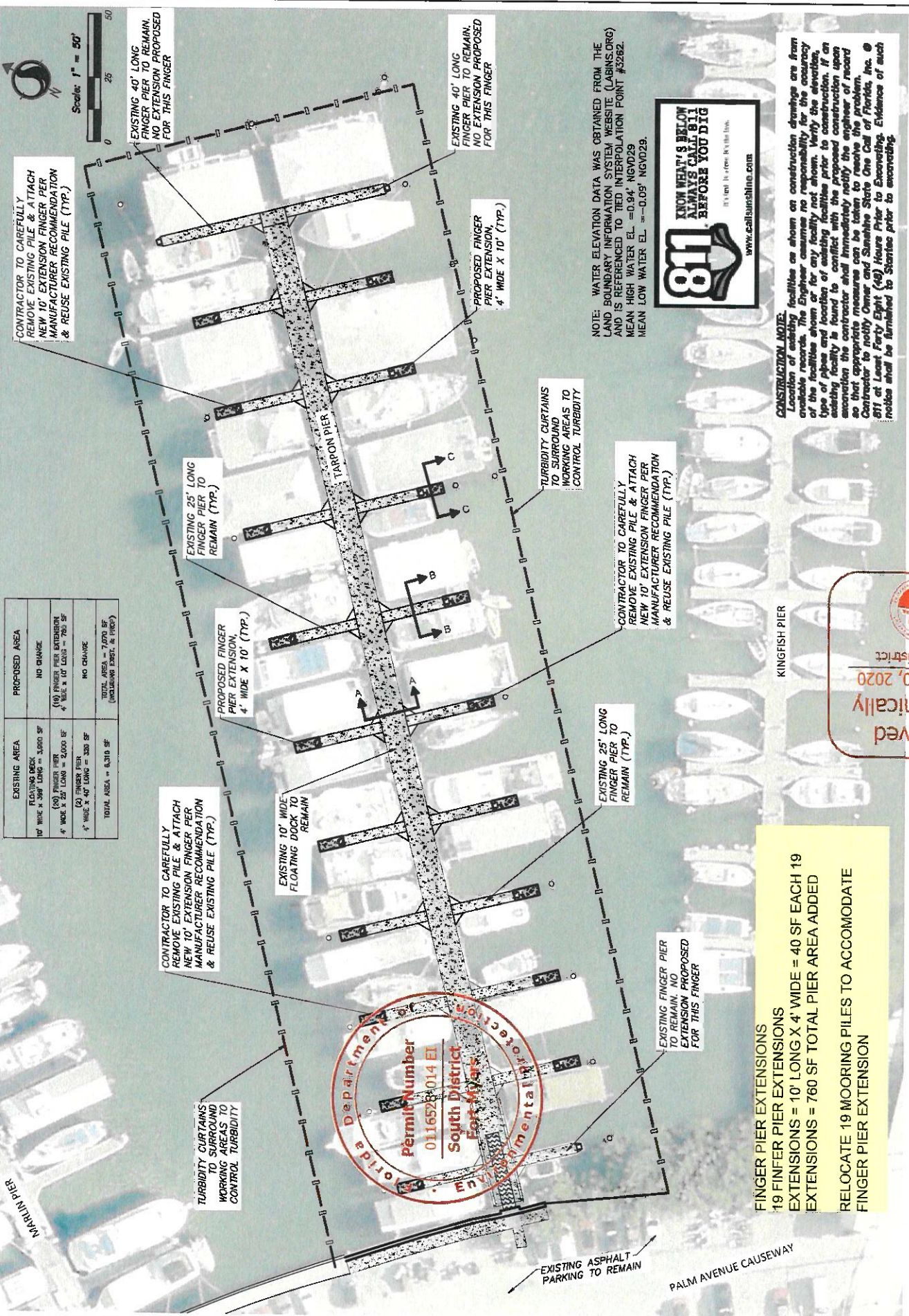

Florida Department of  
**Permit Number**  
**01165264014 EI**  
**South District**  
**Fort Myers**  
 Environmental Protection

**FINGER PIER EXTENSIONS**  
**19 FINFER PIER EXTENSIONS**  
**EXTENSIONS = 10' LONG X 4' WIDE = 40 SF EACH 19**  
**EXTENSIONS = 760 SF TOTAL PIER AREA ADDED**  
**RELOCATE 19 MOORING PILES TO ACCOMMODATE**  
**FINGER PIER EXTENSION**



NOTE: WATER ELEVATION DATA WAS OBTAINED FROM THE LAND BOUNDARY INFORMATION SYSTEM WEBSITE (LABINS.ORG) AND IS REFERENCED TO TIED INTERPOLATION POINT #3262. MEAN HIGH WATER EL. = -0.94' NGVD29. MEAN LOW WATER EL. = -0.09' NGVD29.

**CONSTRUCTION NOTE:**  
 Location of existing facilities as shown on construction drawings are from available records. The Engineer assumes no responsibility for the accuracy of the facilities shown or for any facility not shown. Verify the elevation, type of pipe and location of existing facilities prior to construction. If an existing facility is found to conflict with the proposed construction upon excavation the contractor shall immediately notify the engineer of record so that appropriate measures can be taken to resolve the problem. Contractor to notify Owner and Sunshine State One Call of Florida, Inc. @ 811 at Least Forty Eight (48) Hours Prior to Excavating. Evidence of such notice shall be furnished to Stantec prior to excavating.

**Stantec**  
 9910 Pine Ridge Road, Suite 100  
 Fort Myers, FL 33903  
 (941) 938-3333  
 www.stantec.com

Received Electronically  
 October 30, 2020  
 South District

CHARLES H. JOHNSON, P.E.  
 REGISTERED PROFESSIONAL ENGINEER  
 STATE OF FLORIDA  
 License No. 11000

NO.	DATE	BY	APPROVED	REVISION

Scale: 1" = 50'  
 Project No.: 21-051588  
 Drawing No.: C-05  
 Sheet: 5 of 5

CONSTRUCTION PLAN

CITY OF KEY WEST  
 DOLPHIN PIER EXTENSION  
 KEY WEST, FLORIDA

CONTRACTOR TO CAREFULLY REMOVE EXISTING PILE & ATTACH NEW 10' EXTENSION FINGER PER MANUFACTURER RECOMMENDATION & REUSE EXISTING PILE (TYP.)

CONTRACTOR TO CAREFULLY REMOVE EXISTING PILE & ATTACH NEW 10' EXTENSION FINGER PER MANUFACTURER RECOMMENDATION & REUSE EXISTING PILE (TYP.)

CONTRACTOR TO CAREFULLY REMOVE EXISTING PILE & ATTACH NEW 10' EXTENSION FINGER PER MANUFACTURER RECOMMENDATION & REUSE EXISTING PILE (TYP.)

CONTRACTOR TO CAREFULLY REMOVE EXISTING PILE & ATTACH NEW 10' EXTENSION FINGER PER MANUFACTURER RECOMMENDATION & REUSE EXISTING PILE (TYP.)

CONTRACTOR TO CAREFULLY REMOVE EXISTING PILE & ATTACH NEW 10' EXTENSION FINGER PER MANUFACTURER RECOMMENDATION & REUSE EXISTING PILE (TYP.)

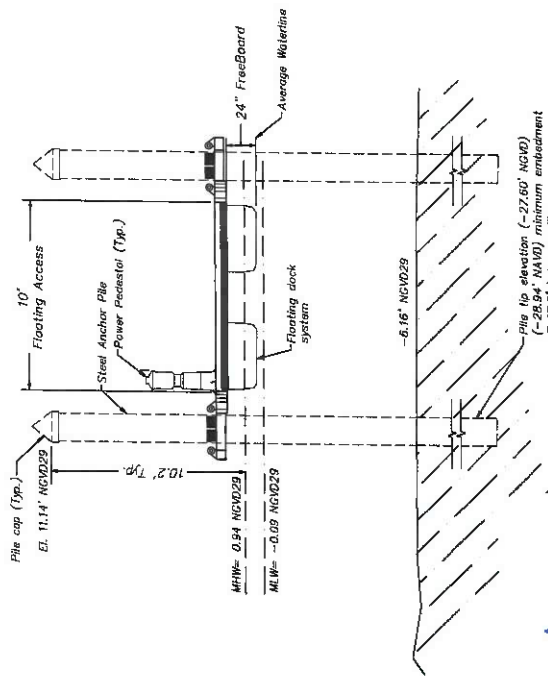

NOTE: WATER ELEVATION DATA WAS OBTAINED FROM THE LAND BOUNDARY INFORMATION SYSTEM WEBSITE (LABINS.ORG) AND IS REFERENCED TO TIED INTERPOLATION POINT #3282. MEAN HIGH WATER EL. = 0.94' NGVD29. MEAN LOW WATER EL. = -0.08' NGVD29.

**EXISTING SECTION A-A/C-05**  
N.T.S.

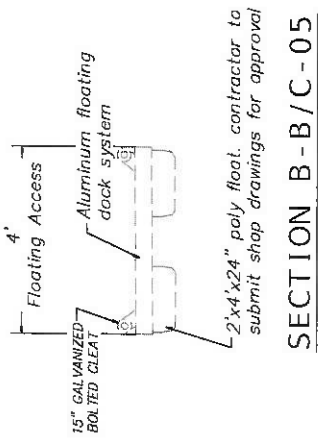

2'x4'x24" poly float, contractor to submit shop drawings for approval

**SECTION B-B/C-05**

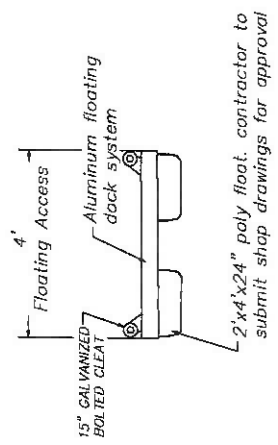

2'x4'x24" poly float, contractor to submit shop drawings for approval

**SECTION C-C/C-05**



<b>Stantec</b> 901 Bruce Dr. Suite 100 Coral Gables, Florida 33134 <small>The Company and its personnel are not to be held responsible for any errors or omissions in this drawing. The user of this drawing is to be held responsible for any errors or omissions in this drawing. The user of this drawing is to be held responsible for any errors or omissions in this drawing.</small>		<b>CITY OF KEY WEST</b> <b>TARPOON PIER EXTENSION</b> Key West, Florida Title Block: _____ No. _____ Date _____ Rev. _____ Page _____ Total _____		<b>CROSS SECTIONS</b> Project No. 21961988 Scale: NO SCALE Drawing No. C-06 Sheet 27 of 27 Reason:	
Created: _____ Checked: _____ Approved: _____ Date: _____	Soils: _____ Foundation: _____ Structural: _____ Mechanical: _____ Electrical: _____ Civil: _____ Environmental: _____ Other: _____	By: _____ Title: _____ Date: _____	By: _____ Title: _____ Date: _____	By: _____ Title: _____ Date: _____	By: _____ Title: _____ Date: _____



**UNITED STATES DEPARTMENT OF COMMERCE**  
**National Oceanic and Atmospheric Administration**  
**NATIONAL OCEAN SERVICE**

**Florida Keys National Marine Sanctuary**  
33 East Quay Road  
Key West, FL 33040

January 5, 2021

Ms. Adriana Cabrera  
Department of the Army Jacksonville District Corps of Engineers  
Miami Regulatory Office  
9900 Southwest 107<sup>th</sup> Avenue, Suite 203  
Miami, FL 33176

Dear Ms. Cabrera:

NOAA Florida Keys National Marine Sanctuary (FKNMS or sanctuary) has reviewed Department of the Army Corps of Engineers (DA Corps) application no. 1999-05418 (SP-AMC). The applicant, City of Key West c/o Karen Olson, is requesting a permit to install (19) 4' x 10' finger pier extensions and relocate (19) existing pier pilings at the Tarpon Pier at the City Marina at Garrison Bight located at 1801 North Roosevelt Boulevard, Key West, Monroe County, FL. The proposed activity is prohibited by FKNMS regulations at 15 CFR §922.163(a)(3).

NOAA has reviewed the project described in the DA Corps application and determined that the proposed project will have a negligible impact on sanctuary resources. Therefore, pursuant to 15 CFR § 922.49, NOAA does not object to the issuance of a DA Corps permit for the project as proposed, and a separate FKNMS permit will not be required.

This determination is only applicable to DA Corps application no. 1999-05418 (SP-AMC), including all project plans and methods detailed in that application and any additional information submitted or follow-up correspondence between the applicant and NOAA FKNMS. If any changes are made to the project description or methods deviate from those provided to NOAA FKNMS, in the application, the applicant shall notify NOAA and this letter of authorization will be rescinded. Upon such notification, NOAA shall re-review the project and special conditions and provide a supplementary determination. Further information on sanctuary permit review and authorization is set forth at 15 CFR § 922.49.

This project has been assigned authorization #FKNMS-2021-003. Please contact FKNMS Enforcement Coordinator Steve Werndli at [Stephen.Werndli@noaa.gov](mailto:Stephen.Werndli@noaa.gov) if you have questions about NOAA's determination on this project. Thank you for your continued cooperation with the Florida Keys National Marine Sanctuary.

Sincerely,

Sarah Fangman  
Superintendent

cc: Phil Frank, Terramar Environmental Services



**Special Conditions:**

1. **REPORTING ADDRESS:** The Permittee shall submit all reports, notifications, documentation and correspondence required by the conditions of this permit shall be submitted to the following address:

- a. For electronic mail (preferred): SAJ-RD-Enforcement@usace.army.mil (not to exceed 25 MB).

- b. For standard mail: U.S. Army Corps of Engineers, Regulatory Division, Enforcement Section, P.O. Box 4970, Jacksonville, FL 32232-0019.

The Permittee shall reference this permit number, SAJ-1999-05418 (LP-AMC), on all submittals.

2. **SELF-CERTIFICATION:** Within 60 days of completion of the work authorized by this permit, the Permittee shall complete the attached "Self-Certification Statement of Compliance" form (Attached) and submit it to the Corps. In the event that the completed work deviates in any manner from the authorized work, the Permittee shall describe the deviations between the work authorized by this permit and the work as constructed on the "Self-Certification Statement of Compliance" form. The description of any deviations on the "Self-Certification Statement of Compliance" form does not constitute approval of any deviations by the Corps.
3. **ASSURANCE OF NAVIGATION AND MAINTENANCE:** The Permittee understands and agrees that, if future operations by the United States require the removal, relocation, or other alteration, of the structures or work herein authorized, or if in the opinion of the Secretary of the Army or his authorized representative, said structure or work shall cause unreasonable obstruction to the free navigation of the navigable waters, the Permittee will be required, upon due notice from the Corps of Engineers, to remove, relocate, or alter the structural work or obstructions caused thereby, without expense to the United States. No claim shall be made against the United States on account of any such removal or alteration.
4. **MANATEE CONDITIONS:** The Permittee shall abide by the enclosed standard construction conditions designed to protect the endangered West Indian manatee, 2011.
5. **POSTING OF PERMIT:** The Permittee shall have available and maintain for review a copy of this permit and approved plans at the construction site.
6. **AGENCY CHANGES/APPROVALS:** Should any other agency require and/or approve changes to the work authorized or obligated by this permit, the Permittee is





advised a modification to this permit instrument is required prior to initiation of those changes. It is the Permittee's responsibility to request a modification of this permit from the Miami Permits Section. The Corps reserves the right to fully evaluate, amend, and approve or deny the request for modification of this permit.

**7. CULTURAL RESOURCES/HISTORIC PROPERTIES:**

a. No structure or work shall adversely affect impact or disturb properties listed in the National Register of Historic Places (NRHP) or those eligible for inclusion in the NRHP.

b. If during the ground disturbing activities and construction work within the permit area, there are archaeological/cultural materials encountered which were not the subject of a previous cultural resources assessment survey (and which shall include, but not be limited to: pottery, modified shell, flora, fauna, human remains, ceramics, stone tools or metal implements, dugout canoes, evidence of structures or any other physical remains that could be associated with Native American cultures or early colonial or American settlement), the Permittee shall immediately stop all work and ground-disturbing activities within a 100-meter diameter of the discovery and notify the Corps within the same business day (8 hours). The Corps shall then notify the Florida State Historic Preservation Officer (SHPO) and the appropriate Tribal Historic Preservation Officer(s) (THPO(s)) to assess the significance of the discovery and devise appropriate actions.

c. Additional cultural resources assessments may be required of the permit area in the case of unanticipated discoveries as referenced in accordance with the above Special Condition ; and if deemed necessary by the SHPO, THPO(s), or Corps, in accordance with 36 CFR 800 or 33 CFR 325, Appendix C (5). Based, on the circumstances of the discovery, equity to all parties, and considerations of the public interest, the Corps may modify, suspend or revoke the permit in accordance with 33 CFR Part 325.7. Such activity shall not resume on non-federal lands without written authorization from the SHPO for finds under his or her jurisdiction, and from the Corps.

d. In the unlikely event that unmarked human remains are identified on non-federal lands, they will be treated in accordance with Section 872.05 Florida Statutes. All work and ground disturbing activities within a 100-meter diameter of the unmarked human remains shall immediately cease and the Permittee shall immediately notify the medical examiner, Corps, and State Archeologist within the same business day (8-hours). The Corps shall then notify the appropriate SHPO and THPO(s). Based, on the circumstances of the discovery, equity to all parties, and considerations of the public interest, the Corps may modify, suspend or revoke



the permit in accordance with 33 CFR Part 325.7. Such activity shall not resume without written authorization from the State Archeologist and from the Corps.

8. **TURBIDITY BARRIERS:** Prior to the initiation of any of the work authorized by this permit the Permittee shall install floating turbidity barriers with weighted skirts that extend to within one foot of the bottom around all work areas that are in, or adjacent to, surface waters. The turbidity barriers shall remain in place and be maintained until the authorized work has been completed and all erodible materials have been stabilized. Turbidity barriers shall be removed upon stabilization of the work area.

9. **JACKSONVILLE DISTRICT PROGRAMMATIC BIOLOGICAL OPINION (JAXBO), NOVEMBER 2017, PROJECT DESIGN CRITERIA (PDCS):** Structures authorized under this permit must comply with all applicable PDCs, based on the permitted activity, as required by JAXBO. Please note that failure to comply with the applicable PDCs, where a take of listed species occurs, would constitute an unauthorized take, and noncompliance with this permit. The NMFS is the appropriate authority to enforce the terms and conditions of JAXBO. The most current version of JAXBO can be accessed at the Jacksonville District Regulatory Division internet webpage in the Endangered Species section of the Sourcebook located at: <http://www.saj.usace.army.mil/Missions/Regulatory/SourceBook.aspx>  
**Note - JAXBO may be subject to revision at any time. The most recent version of these conditions must be utilized during the design and construction of the permitted work. In accordance with the Endangered Species Act, and for those projects which do not comply with JAXBO, the Corps will seek individual consultation with the NMFS.**

**Note -** some authorized activities may deviate from the PDCs. In cases, where the activity (i.e., structure dimensions, length, etc.) deviates from the PDCs, the permit drawings shall supersede the PDCs.

For each of the following authorized activities subject of this permit, the permittee shall adhere to the following PDCs, which are attached to, and made part of, this authorization/verification letter.

Activity 2 - Pile-supported Structures and Anchored Buoys: (AP.1-14; A2.1-16; S.1; S.2; S.4)

10. **COMMENCEMENT NOTIFICATION:** Within 10 days from the date of initiating the work authorized by this permit the Permittee shall submit a completed "Commencement Notification" Form (Attached).

If the work authorized is not completed on or before May 11, 2026 authorization, if not previously revoked or specifically extended, shall cease and be null and void.

**Instructions for Objecting to Permit Terms and Conditions:** This letter contains an initial proffered permit for your proposed project/permit application. If you object to



certain terms and conditions contained within the permit, you may request that the permit be modified. Enclosed you will find a Notification of Administrative Appeal Options and Process fact sheet and Request for Appeal (RFA) form. If you choose to object to certain terms and conditions of the permit, you must follow the directions provided in Section 1, Part A and submit the completed RFA form to the letterhead address.

In order for an RFA to be accepted by the Corps, the Corps must determine that it is complete, that it meets the criteria under 33 CFR Part 331.5, and that it has been received by the District office within 60 days of the date of the RFA. Should you decide to submit an RFA form, it must be received July 11, 2021.

Should you have any questions regarding this letter, please contact the project manager Adriana Cabrera in writing the letterhead address, by telephone at (305) 526-7183, or by email at [Adriana.M.Cabrera@usace.army.mil](mailto:Adriana.M.Cabrera@usace.army.mil).

The Corps Jacksonville District Regulatory Division is committed to improving service to our customers. We strive to perform our duty in a friendly and timely manner while working to preserve our environment. We invite you to take a few minutes to visit [http://corpsmapu.usace.army.mil/cm\\_apex/f?p=regulatory\\_survey](http://corpsmapu.usace.army.mil/cm_apex/f?p=regulatory_survey) and complete our automated Customer Service Survey. Your input is appreciated – favorable or otherwise.

BY AUTHORITY OF THE SECRETARY OF THE ARMY:



for

ANDREW D. KELLY, JR.  
Colonel, EN  
Commanding

Enclosures

Copy/ies Furnished:  
CESAJ-RD-PE (w/ enclosures)  
Mr. Philip Frank, Terramar Environmental Services, agent- email



REQUEST PERMIT TRANSFER: PERMIT NUMBER: SAJ-1999-05418 (LP-AMC)

When the structures or work verified by this permit are still in existence at the time the property is transferred, the terms and conditions of this permit will continue to be binding on the new owner(s) of the property. To validate the transfer of this permit and the associated liabilities associated with compliance with its terms and conditions, the present permittee and the transferee should sign and date below. This document must then be provided to the U.S. Army Corps of Engineers, Regulatory Division, Post Office Box 4970, Jacksonville, Florida 32232-0019.

\_\_\_\_\_  
(TRANSFEREE SIGNATURE)

\_\_\_\_\_  
(DATE)

\_\_\_\_\_  
(Name - Printed)

\_\_\_\_\_  
Lot/Block of site

\_\_\_\_\_  
(Street Address)

\_\_\_\_\_  
(City, State, and Zip Code)

**Flood Plain Information:**

This Department of the Army permit does not give absolute authority to perform the work as specified on your application. The proposed work may be subject to local building restrictions. You should contact the local office in your area that issues building permits to determine if your site is located in a flood-prone or floodway area, and if you must comply with the local building requirements mandated by the National Flood Insurance Program. If your local office cannot provide you the necessary information, you may request a flood hazard evaluation of the site by providing this office with a letter and a small scale map showing the location of the site. The request should be addressed to the **Chief, Flood Control and Floodplain Management Branch, Jacksonville District, U.S. Army Corps of Engineers, P.O. Box 4970, Jacksonville, Florida 32232-0019.** Phone inquiries may be made at 904-232-2515.

\_\_\_\_\_

GENERAL CONDITIONS  
33 CFR PART 320-330  
PUBLISHED FR DATED 13 NOVEMBER 1986

1. The time limit for completing the work authorized ends on **the date noted in the permit letter**. If you find that you need more time to complete the authorized activity, submit your request for a time extension to this office for consideration at least one month before the above date is reached.
2. You must maintain the activity authorized by this permit in good condition and in conformance with the terms and conditions of this permit. You are not relieved of this requirement if you abandon the permitted activity, although you may make a good faith transfer to a third party in compliance with General Condition 4 below. Should you wish to cease to maintain the authorized activity or should you desire to abandon it without a good faith transfer, you must obtain a modification of this permit from this office, which may require restoration of the area.
3. If you discover any previously unknown historic or archeological remains while accomplishing the activity authorized by this permit, you must immediately notify this office of what you have found. We will initiate the Federal and state coordination required to determine if the remains warrant a recovery effort of if the site is eligible for listing in the National Register of Historic Places.
4. If you sell the property associated with this permit you must obtain the signature of the new owner in the space provided and forward a copy of the permit to this office to validate the transfer of this authorization.
5. If a conditioned water quality certification has been issued for your project, you must comply with the conditions specified in the certification as special conditions to this permit. For your convenience, a copy of the certification is attached if it contains such conditions.
6. You must allow a representative from this office to inspect the authorized activity at any time deemed necessary to ensure that it is being or has been accomplished in accordance with the terms and conditions of your permit.

T  
R

**NOTIFICATION OF ADMINISTRATIVE APPEAL OPTIONS AND PROCESS AND REQUEST FOR APPEAL**

Applicant: Karen Olson		File Number: SAJ-1999-05418 (LP-AMC)	Date: May 10, 2021
Attached is:			See Section below
X	INITIAL PROFFERED PERMIT (Standard Permit or Letter of permission)		A
	PROFFERED PERMIT (Standard Permit or Letter of permission)		B
	PERMIT DENIAL		C
	APPROVED JURISDICTIONAL DETERMINATION		D
X	PRELIMINARY JURISDICTIONAL DETERMINATION		E

SECTION I - The following identifies your rights and options regarding an administrative appeal of the above decision. Additional information may be found at [http://www.usace.army.mil/CECW/Pages/reg\\_materials.aspx](http://www.usace.army.mil/CECW/Pages/reg_materials.aspx) or Corps regulations at 33 CFR Part 331.

A: INITIAL PROFFERED PERMIT: You may accept or object to the permit.

- ACCEPT: If you received a Standard Permit, you may sign the permit document and return it to the district engineer for final authorization. If you received a Letter of Permission (LOP), you may accept the LOP and your work is authorized. Your signature on the Standard Permit or acceptance of the LOP means that you accept the permit in its entirety, and waive all rights to appeal the permit, including its terms and conditions, and approved jurisdictional determinations associated with the permit.

- OBJECT: If you object to the permit (Standard or LOP) because of certain terms and conditions therein, you may request that the permit be modified accordingly. You must complete Section II of this form and return the form to the district engineer. Your objections must be received by the district engineer within 60 days of the date of this notice, or you will forfeit your right to appeal the permit in the future. Upon receipt of your letter, the district engineer will evaluate your objections and may: (a) modify the permit to address all of your concerns, (b) modify the permit to address some of your objections, or (c) not modify the permit having determined that the permit should be issued as previously written. After evaluating your objections, the district engineer will send you a proffered permit for your reconsideration, as indicated in Section B below.

B: PROFFERED PERMIT: You may accept or appeal the permit

- ACCEPT: If you received a Standard Permit, you may sign the permit document and return it to the district engineer for final authorization. If you received a Letter of Permission (LOP), you may accept the LOP and your work is authorized. Your signature on the Standard Permit or acceptance of the LOP means that you accept the permit in its entirety, and waive all rights to appeal the permit, including its terms and conditions, and approved jurisdictional determinations associated with the permit.

- APPEAL: If you choose to decline the proffered permit (Standard or LOP) because of certain terms and conditions therein, you may appeal the declined permit under the Corps of Engineers Administrative Appeal Process by completing Section II of this form and sending the form to the division engineer. This form must be received by the division engineer within 60 days of the date of this notice.

C: PERMIT DENIAL: You may appeal the denial of a permit under the Corps of Engineers Administrative Appeal Process by completing Section II of this form and sending the form to the division engineer. This form must be received by the division engineer within 60 days of the date of this notice.

D: APPROVED JURISDICTIONAL DETERMINATION: You may accept or appeal the approved JD or provide new information.

- ACCEPT: You do not need to notify the Corps to accept an approved JD. Failure to notify the Corps within 60 days of the date of this notice, means that you accept the approved JD in its entirety, and waive all rights to appeal the approved JD.
- APPEAL: If you disagree with the approved JD, you may appeal the approved JD under the Corps of Engineers Administrative Appeal Process by completing Section II of this form and sending the form to the division engineer. This form must be received by the division engineer within 60 days of the date of this notice.

**SECTION II - REQUEST FOR APPEAL or OBJECTIONS TO AN INITIAL PROFFERED PERMIT**

**REASONS FOR APPEAL OR OBJECTIONS:** (Describe your reasons for appealing the decision or your objections to an initial proffered permit in clear concise statements. You may attach additional information to this form to clarify where your reasons or objections are addressed in the administrative record.)

**ADDITIONAL INFORMATION:** The appeal is limited to a review of the administrative record, the Corps memorandum for the record of the appeal conference or meeting, and any supplemental information that the review officer has determined is needed to clarify the administrative record. Neither the appellant nor the Corps may add new information or analyses to the record. However, you may provide additional information to clarify the location of information that is already in the administrative record.

**POINT OF CONTACT FOR QUESTIONS OR INFORMATION:**

If you have questions regarding this decision and/or the appeal process you may contact:

**Project Manager as noted in letter**

If you only have questions regarding the appeal process you may also contact:

Phillip A. Shannin  
404-562-5137

**RIGHT OF ENTRY:** Your signature below grants the right of entry to Corps of Engineers personnel, and any government consultants, to conduct investigations of the project site during the course of the appeal process. You will be provided a 15 day notice of any site investigation, and will have the opportunity to participate in all site investigations.

\_\_\_\_\_  
Signature of appellant or agent.

Date:

Telephone number:

5

**COMMENCEMENT NOTIFICATION**

*Within ten (10) days of initiating the authorized work, submit this form via electronic mail to [saj-rd-enforcement@usace.army.mil](mailto:saj-rd-enforcement@usace.army.mil) (preferred, not to exceed 15 MB) or by standard mail to U.S. Army Corps of Engineers, Enforcement Section, P.O. Box 4970, Jacksonville, FL 32232-0019.*

1. Department of the Army Permit Number: SAJ-1999-05418 (LP-AMC)

2. Permittee Information:

Name: \_\_\_\_\_

Email: \_\_\_\_\_

Address: \_\_\_\_\_

Phone: \_\_\_\_\_

3. Construction Start Date: \_\_\_\_\_

4. Contact to Schedule Inspection:

Name: \_\_\_\_\_

Email: \_\_\_\_\_

Phone: \_\_\_\_\_

\_\_\_\_\_  
Signature of Permittee

\_\_\_\_\_  
Printed Name of Permittee

\_\_\_\_\_  
Date

Dated 9/18/2019





**SELF-CERTIFICATION STATEMENT OF COMPLIANCE**

*Within sixty (60) days of completion of the authorized work, submit this form via electronic mail to [saj-rd-enforcement@usace.army.mil](mailto:saj-rd-enforcement@usace.army.mil) (preferred, not to exceed 15MB) **or** by standard mail to U.S. Army Corps of Engineers, Enforcement Section, P.O. Box 4970, Jacksonville, FL 32232-0019.*

- 1. Department of the Army Permit Number: SAJ-1999-05418 (LP-AMC)
- 2. Permittee Information: Name: \_\_\_\_\_  
Email: \_\_\_\_\_  
Address: \_\_\_\_\_  
\_\_\_\_\_  
Phone: \_\_\_\_\_
- 3. Date Authorized Work Started: \_\_\_\_\_ Completed: \_\_\_\_\_
- 4. Contact to Schedule Inspection: Name: \_\_\_\_\_  
Email: \_\_\_\_\_  
Phone: \_\_\_\_\_

5. Description of Authorized Work (e.g. bank stabilization, fill placed within wetlands, docks, dredging, etc.): \_\_\_\_\_  
\_\_\_\_\_  
\_\_\_\_\_

6. Acreage or Square Feet of Impacts to Waters of the United States: \_\_\_\_\_

7. Describe Mitigation completed (if applicable): \_\_\_\_\_  
\_\_\_\_\_  
\_\_\_\_\_

8. Describe any Deviations from Permit (attach drawing(s) depicting the deviations): \_\_\_\_\_  
\_\_\_\_\_  
\_\_\_\_\_

\*\*\*\*\*

I certify that all work and mitigation (if applicable) was done in accordance with the limitations and conditions as described in the permit. Any deviations as described above are depicted on the attached drawing(s).

\_\_\_\_\_  
Signature of Permittee

\_\_\_\_\_  
Printed Name of Permittee

\_\_\_\_\_  
Date

Dated 9/18/2019



DEPARTMENT OF THE ARMY PERMIT TRANSFER REQUEST

PERMIT NUMBER: SAJ- 1999-05418 (LP-AMC)

When the structures or work authorized by this permit are still in existence at the time the property is transferred, the terms and conditions of this permit will continue to be binding on the new owner(s) of the property. Although the construction period for works authorized by Department of the Army permits is finite, the permit itself, with its limitations, does not expire.

To validate the transfer of this permit and the associated responsibilities associated with compliance with its terms and conditions, have the transferee sign and date below and mail to the U.S. Army Corps of Engineers, Enforcement Branch, Post Office Box 4970, Jacksonville, FL 32232-0019.

\_\_\_\_\_  
(TRANSFEEE-SIGNATURE)

\_\_\_\_\_  
(SUBDIVISION)

\_\_\_\_\_  
(DATE)

\_\_\_\_\_  
(LOT)

\_\_\_\_\_  
(BLOCK)

\_\_\_\_\_  
(NAME-PRINTED)

\_\_\_\_\_  
(STREET ADDRESS)

\_\_\_\_\_  
(MAILING ADDRESS)

\_\_\_\_\_  
(CITY, STATE, ZIP CODE)

# CAUTION: MANATEE HABITAT

All project vessels

**IDLE SPEED / NO WAKE**

When a manatee is within 50 feet of work  
all in-water activities must

**SHUT DOWN**

Report any collision with or injury to a manatee:



Wildlife Alert:

**1-888-404-FWCC(3922)**

cell \*FWC or #FWC

Fr

# Save Sea Turtles, Sawfish, and Dolphins

## While Fishing, Following These Tips:

- Report injured, entangled, hooked, or stranded dolphins and sea turtles to the 24-hour hotline:

**1-877-942-5343**

Download the  
Dolphin & Whale 911 app  
on your iPhone or Android  
for reporting  
marine mammals.

- Never cast towards dolphins, sea turtles, or sawfish.
- Change location or reel in your line if a dolphin, sea turtle, or sawfish shows interest in your bait or catch.
- Release catch away from dolphins when and where possible without violating any state or federal fishing regulations.
- Do not feed or attempt to feed wild dolphins or sea turtles - it's harmful and illegal.
- Do not dispose of leftover bait or cleaned fish remains in water.
- Use circle or corrodible (non-stainless steel) hooks to reduce injury.
- Use recycling bins for fishing line and do not throw trash or unwanted line in the water.
- If you hook a **SEA TURTLE**, immediately call the 24-hour hotline at **1-877-942-5343** and follow response team instructions.



If you cannot reach a response team, follow these guidelines to reduce injuries:

- 1) If possible, use a net or lift by the shell to bring the turtle on pier or land.  
Do NOT lift by hook or line.
  - 2) Cut the line close to the hook, removing as much line as possible.
  - 3) Release turtle.
- If you hook a **SAWFISH**:
    - 1) Do not remove the fish from the water.
    - 2) Cut the line close to the hook.
    - 3) Release it as quickly as possible.
    - 4) Report it immediately to **1-941-255-7403**.

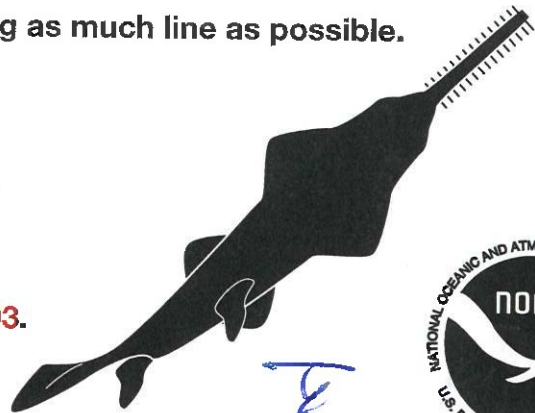

## STANDARD MANATEE CONDITIONS FOR IN-WATER WORK

2011

The permittee shall comply with the following conditions intended to protect manatees from direct project effects:

- a. All personnel associated with the project shall be instructed about the presence of manatees and manatee speed zones, and the need to avoid collisions with and injury to manatees. The permittee shall advise all construction personnel that there are civil and criminal penalties for harming, harassing, or killing manatees which are protected under the Marine Mammal Protection Act, the Endangered Species Act, and the Florida Manatee Sanctuary Act.
- b. All vessels associated with the construction project shall operate at "Idle Speed/No Wake" at all times while in the immediate area and while in water where the draft of the vessel provides less than a four-foot clearance from the bottom. All vessels will follow routes of deep water whenever possible.
- c. Siltation or turbidity barriers shall be made of material in which manatees cannot become entangled, shall be properly secured, and shall be regularly monitored to avoid manatee entanglement or entrapment. Barriers must not impede manatee movement.
- d. All on-site project personnel are responsible for observing water-related activities for the presence of manatee(s). All in-water operations, including vessels, must be shutdown if a manatee(s) comes within 50 feet of the operation. Activities will not resume until the manatee(s) has moved beyond the 50-foot radius of the project operation, or until 30 minutes elapses if the manatee(s) has not reappeared within 50 feet of the operation. Animals must not be herded away or harassed into leaving.
- e. Any collision with or injury to a manatee shall be reported immediately to the Florida Fish and Wildlife Conservation Commission (FWC) Hotline at 1-888-404-3922. Collision and/or injury should also be reported to the U.S. Fish and Wildlife Service in Jacksonville (1-904-731-3336) for north Florida or Vero Beach (1-772-562-3909) for south Florida, and to FWC at [ImperiledSpecies@myFWC.com](mailto:ImperiledSpecies@myFWC.com)
- f. Temporary signs concerning manatees shall be posted prior to and during all in-water project activities. All signs are to be removed by the permittee upon completion of the project. Temporary signs that have already been approved for this use by the FWC must be used. One sign which reads *Caution: Boaters* must be posted. A second sign measuring at least 8 ½" by 11" explaining the requirements for "Idle Speed/No Wake" and the shut down of in-water operations must be posted in a location prominently visible to all personnel engaged in water-related activities. These signs can be viewed at [MyFWC.com/manatee](http://MyFWC.com/manatee). Questions concerning these signs can be sent to the email address listed above.



## Project Design Criteria (PDCs) Applicable to All Projects

**NOTE** - You are required to comply with the following PDCs, which serve to address requirements pursuant to Section 7, Endangered Species Act (ESA) for those listed species and designated critical habitat under purview of the National Marine Fisheries Service Protected Resources Division. These PDCs are taken from the Programmatic Biological Opinion (PBO) referred to as JaxBO. These criteria serve to address ESA requirements only, and additional conditions may be required to address other Federal laws, including the Magnuson-Stevens Fishery Conservation and Management Reauthorization Act. Authorization under this permit is conditional upon your compliance with all applicable PDCs, which are made part of this permit. You are reminded that you must complete the attached self-certification statement of compliance following completion of the authorized work. Your statement of compliance does not obviate the need to satisfy all PDCs, including those requirements (e.g., such as structural dimensions and educational signs) that are observable post-construction, and those requirements (e.g., construction methods or procedures to be followed) that are not observable post-construction. Please note that failure to comply with the applicable PDCs of this PBO, where a take of the listed species occurs, would constitute an unauthorized take, and it would also constitute noncompliance with this permit. The NMFS is the appropriate authority to determine compliance with the terms and conditions of this PBO.

**AP.1.** The applicant must agree to adhere to PDCs for *In-Water Activities* (provided below).

**AP.2.** All projects involving the installation of piles or sheet piles shall follow the PDCs for *In-Water Noise from Pile and Sheet Pile Installation* (Section 2.2). This Opinion does not cover projects that use seismic surveys, low frequency sonar, explosions, and seismic air guns.

**AP.3.** All projects proposed in or near areas with mangroves, seagrasses, corals, or hard bottom habitat must refer to PDCs for *Mangroves, Seagrasses, Corals, and Hard Bottom for All Projects* (provided below) to determine whether the project is covered under the Opinion and, if it is covered, to ensure it is sited, designated, and implemented following all of the PDCs in that section.

**AP.4.** For every project, the USACE must determine if the project is located within:

- a) Smalltooth sawfish critical habitat limited exclusion zones (Section 2.1.1.1)
- b) Gulf sturgeon critical habitat migratory restriction zones (Section 2.1.1.2)
- c) Atlantic sturgeon critical habitat exclusion zone (St. Marys River) (Section 2.1.1.3)
- d) North Atlantic right whale educational sign zones (Section 2.1.1.4)
- e) U.S. Caribbean sea turtle critical habitat restriction zones (Section 2.1.1.5)
- f) Bryde's whale exclusion zone (Section 2.1.1.6)

Where the activity is excluded from the Opinion within a particular zone, the application must be processed under a separate consultation. Where additional restrictions apply to activities within that zone, the USACE or other authorizing entity must ensure that the project meets the requirements for that zone.

**AP.5.** This Opinion only covers new construction (i.e., installation, repair, replacement) and does not apply to after-the-fact consultations or enforcement actions handled by the Corps.

**AP.6.** All activities must be completed during daylight hours.



## Project Design Criteria (PDCs) for In-Water Activities

**AP.7. Education and Observation:** The permittee must ensure that all personnel associated with the project are instructed about the potential presence of species protected under the ESA and the Marine Mammal Protection Act (MMPA). All on-site project personnel are responsible for observing water-related activities for the presence of protected species. All personnel shall be advised that there are civil and criminal penalties for harming, harassing, or killing ESA-listed species or marine mammals. To determine which species may be found in the project area, please review the relevant Protected Species List at:

[http://sero.nmfs.noaa.gov/protected\\_resources/section\\_7/threatened\\_endangered/index.html](http://sero.nmfs.noaa.gov/protected_resources/section_7/threatened_endangered/index.html)

**AP.8. Reporting Interactions with Protected Species:**

- a) Any collision(s) with and/or injury to any sea turtle, sawfish, whale, or sturgeon occurring during the construction of a project, shall be reported immediately to NMFS's Protected Resources Division (PRD) at (1-727-824-5312) or by email to: [takereport.nmfs@noaa.gov](mailto:takereport.nmfs@noaa.gov) and [SAJ-RD-Enforcement@usace.army.mil](mailto:SAJ-RD-Enforcement@usace.army.mil).
- b) Smalltooth sawfish: Report sightings to 1-844-SAWFISH or email: [Sawfish@MyFWC.com](mailto:Sawfish@MyFWC.com)
- c) Sturgeon: Report dead sturgeon to 1-844-STURG 91 (1-844-788-7491) or email: [nmfs.ser.sturgeonnetwork@noaa.gov](mailto:nmfs.ser.sturgeonnetwork@noaa.gov)
- d) Sea turtles and marine mammals: Report stranded, injured, or dead animals to 1-877-WHALE HELP (1-877-942-5343).
- e) North Atlantic right whale: Report injured, dead, or entangled right whales to the USCG via VHF Channel 16.

**AP.9. Vessel Traffic and Construction Equipment:** All vessel operators must watch for and avoid collision with species protected under the ESA and MMPA. Vessel operators must avoid potential interactions with protected species and operate in accordance with the following protective measures:

- a) *Construction Equipment:*
  - i) All vessels associated with the construction project shall operate at "Idle Speed/No Wake" at all times while operating in water depths where the draft of the vessel provides less than a 4-foot (ft) clearance from the bottom, and in all depths after a protected species has been observed in and has departed the area.
  - ii) All vessels will follow marked channels and/or routes using the maximum water depth whenever possible.
  - iii) Operation of any mechanical construction equipment, including vessels, shall cease immediately if a listed species is observed within a 50-ft radius of construction equipment and shall not resume until the species has departed the area of its own volition.
  - iv) If the detection of species is not possible during certain weather conditions (e.g., fog, rain, wind), then in-water operations will cease until weather conditions improve and detection is again feasible.

- b) *All Vessels:*
- i) Sea turtles: Maintain a minimum distance of 150 ft.
  - ii) North Atlantic right whale: Maintain a minimum 1,500-ft distance (500 yards).
  - iii) Vessels 65 ft in length or longer must comply with the Right Whale Ship Strike Reduction Rule (50 CFR 224.105) which includes reducing speeds to 10 knots or less in Seasonal Management Areas (<http://www.fisheries.noaa.gov/pr/shipstrike/>).
  - iv) Mariners shall check various communication media for general information regarding avoiding ship strikes and specific information regarding right whale sightings in the area. These include NOAA weather radio, USCG NAVTEX broadcasts, and Notices to Mariners.
  - v) Marine mammals (i.e., dolphins, whales [other than North Atlantic right whales], and porpoises): Maintain a minimum distance of 300 ft.
  - vi) When these animals are sighted while the vessel is underway (e.g., bow-riding), attempt to remain parallel to the animal's course. Avoid excessive speed or abrupt changes in direction until they have left the area.
  - vii) Reduce speed to 10 knots or less when mother/calf pairs or groups of marine mammals are observed, when safety permits.

**AP.10. Turbidity Control Measures during Construction:** Turbidity must be monitored and controlled. Prior to initiating any of the work covered under this Opinion, the Permittee shall install turbidity curtains as described below. In some instances, the use of turbidity curtains may be waived by the USACE project manager if the project is deemed too minimal to generate turbidity (e.g., certain ATON installation, scientific survey device placement, marine debris removal) or if the current is too strong for the curtains to stay in place. Turbidity curtains specifications:

- a) Install floating turbidity barriers with weighted skirts that extend to within 1 ft of the bottom around all work areas that are in, or adjacent to, surface waters.
- b) Use these turbidity barriers throughout construction to control erosion and siltation and ensure that turbidity levels within the project area do not exceed background conditions.
- c) Position turbidity barriers in a way that does not block species' entry to or exit from designated critical habitat.
- d) Monitor and maintain turbidity barriers in place until the authorized work has been completed and the water quality in the project area has returned to background conditions.
- e) In the range of ESA-listed corals (St. Lucie Inlet, Martin County south to the Dry Tortugas and the U.S. Caribbean) and Johnson's seagrass (Turkey Creek/Palm Bay south to central Biscayne Bay in the lagoon systems on the east coast of Florida):
  - i. Projects that include upland earth moving (e.g., grading to install a building or parking lot associated with a dock and seawall project), must install sediment control barriers to prevent any upland sediments from reaching estuarine or marine waters.
  - ii. The turbidity curtain requirement cannot be waived for any project that moves or removes sediment (e.g., dredging, auger to create a pile, trenching to install a cable





line). If turbidity curtains are not feasible in an area based on site conditions such as water current, high wave action, or stormy conditions, the project must undergo individual Section 7 consultation and is not covered under this Programmatic Opinion.

**AP.11. Entanglement:** All turbidity curtains and other in-water equipment must be properly secured with materials that reduce the risk of entanglement of marine species (described below). Turbidity curtains likewise must be made of materials that reduce the risk of entanglement of marine species.

- a) In-water lines (rope, chain, and cable, including the lines to secure turbidity curtains) must be stiff, taut, and non-looping. Examples of such lines are heavy metal chains or heavy cables that do not readily loop and tangle. Flexible in-water lines, such as nylon rope or any lines that could loop or tangle, must be enclosed in a plastic or rubber sleeve/tube to add rigidity and prevent the line from looping and tangling. In all instances, no excess line is allowed in the water.
- b) Turbidity curtains and other in-water equipment must be placed in a manner that does not entrap species within the construction area or block access for them to navigate around the construction area.



**Dock PDCs for Scenario B in the table above:**

1. To avoid and minimize impacts to Johnson's seagrass and native, non-listed seagrasses to the maximum extent practicable:
  - The dock must be positioned to avoid and minimize effects to Johnson's seagrass
  - Over any area that contains Johnson's seagrass or native, non-listed seagrasses, the dock shall be oriented in a north-south orientation to the maximum extent that is practicable to allow maximum sunlight under the structure.
  - If practicable, terminal platforms shall be placed in deep water, waterward of Johnson's seagrass beds or native, non-listed seagrasses beds or in an area devoid of Johnson's seagrass or native, non-listed seagrasses.
  - Piles must be spaced a minimum of 10 ft apart in any area that contains Johnson's seagrass to minimize direct impacts.
  - Piles shall be installed in a manner that will not result in the formation of sedimentary deposits (e.g., donuts or halos) around the newly installed pilings.
  - No covered boat lifts are allowed over any Johnson's seagrass.
2. Decking options: Deck surfaces (parallel with the water) that are located waterward of the MHWL must be constructed of grated materials or plank construction or a combination of the both methods (e.g. plank decking on the walkway and grated decking on the terminal platform). These decking options are described below:

*Grated decking:*

- Height requirement: The surface of the structure, including the dock walkway (the over-water narrow portion connecting the terminal platform to the shore and any over-water ramp required for access) and the dock, must be a minimum of 3 ft above MHW when constructed with grated decking.
- Size limitations: The dock walkway is limited to a width of 4 ft. The terminal platform is limited to a total area of 160 ft<sup>2</sup>. Marginal docks are limited to a width of 5 ft. The 5 ft width restriction is measured from wet side of the seawall. For example, if a seawall cap is 3 feet overwater then the dock would be limited to 2 feet.
- Material description: Decking materials shaped in the form of grids, grates, lattices, etc., to allow the passage of light through the open spaces. These materials must provide a minimum of 43% open space.

*Plank decking:*

- Height requirement: The surface of the structure, including the dock walkway (the over-water narrow portion connecting the terminal platform to the shore and any over-water ramp required for access) and the dock, must be a minimum of 5 ft above MHW when constructed of plank decking.
- Size limitations: The dock walkway is limited to a width of 4 ft. The terminal platform is limited to a total area of 120 ft<sup>2</sup>. Marginal docks are limited to a width of 5 ft.
- Material description: Deck boards may be constructed of any material. Deck boards must be installed to provide a minimum of a 0.5-in gap between individual deck boards.



## Project Design Criteria (PDCs) Specific to Activity 2 for Pile-Supported Structures and Anchored Buoys

- A2.1.** Activities covered by this Opinion include the installation, repair, replacement, and removal of structures as described below:
- A2.1.1. The pile-supported and anchored structures included in this Opinion are: docks and piers, boatlifts, mooring piles and dolphin piles associated with docks/piers; ATONs and PATONs; floating docks; pile-supported chickees (i.e., small, back-country, over-water, pile-supported, primitive camping shelters); boardwalks (as long as they are designed and clearly marked to prohibit fishing and vessel mooring); mooring fields and buoys; and other minor pile-supported structures. This does not include structures that support large commercial vessels including ferries, tankers, and cargo ships such as ferry terminals and large ports.
  - A2.1.2. Pile-supported docks/piers for a single-family residential lot are limited to 4 slips for motorized vessels. Slips for non-motorized vessels (e.g., kayak, canoe, and paddleboard) and associated launching areas do not count toward the total slip number.
  - A2.1.3. Pile-supported structures for marinas, multi-family facilities (e.g., condo complexes, trailer parks, subdivisions when the homeowners association owns and controls the in-water structures). Docks and piers for multi-family residential properties (e.g., condos, trailer parks, apartment complexes), and marinas are limited to a maximum of 50 total slips (i.e., combination of wet and dry slips for existing plus proposed slips).
  - A2.1.4. Anchored buoys and temporary pile-supported structures associated with marine events. Upon completion of the event, these structures must be removed and, to the maximum extent practical, the site must be restored to pre-construction elevations. Water depths in the area of marine events must be deep enough to support at least 5 ft of water depth under the keel of a vessel and between the keel of a vessel and ESA-listed coral colonies when transiting to the mooring areas. There is no limit on the number of vessel slips allowed for temporary structures associated marine events such as boat shows.
  - A2.1.5. Mooring fields are limited to a maximum of 50 motorized vessels (there is no limit on the number of non-motorized vessels).
  - A2.1.6. All pile-supported structures constructed must comply with PDC 2.17 for *Docks or Other Minor Structures Constructed in Florida Under this Opinion* (see below).

**The following PDCs apply to all the activities described in PDC A2.1 above:**

- A2.2.** For commercial, multi-family, or public facilities, and marine events, signs must be posted in a visible location(s), alerting users of listed species in the area susceptible to vessel strikes and hook-and-line captures. The most current version of the signs that must be downloaded and sign installation guidance are available at: [http://sero.nmfs.noaa.gov/protected\\_resources/section\\_7/protected\\_species\\_educational\\_signs/index.html](http://sero.nmfs.noaa.gov/protected_resources/section_7/protected_species_educational_signs/index.html)). The signs required to be posted by area are stated below:
- A2.2.1. All projects in Florida shall use the Save Sea Turtle, Sawfish, and Dolphin sign. These signs shall include contact information to the sea turtle and marine

- mammal stranding networks and smalltooth sawfish encounter database.
- A2.2.2. Projects within the North Atlantic right whale educational sign zone (as defined in Section 2.1.1.4) shall post the Help Protect North Atlantic Right Whales sign.
- A2.2.3. On the east coast of Florida, projects located within the St. John's River and those occurring north of the St. Johns River to the Florida-Georgia line shall post the Report Sturgeon sign. On the west coast of Florida, projects occurring from the Cedar Key, Florida north to the Florida-Alabama line.
- A2.2.4. We are still developing the signs to be used in the U.S. Caribbean. Once developed, those signs will be included at the website above.
- A2.3.** For commercial, multi-family, or public facilities, monofilament recycling bins must be provided at the docking facility to reduce the risk of turtle or sawfish entanglement in, or ingestion of, marine debris. Monofilament recycling bins must:
- A2.3.1. Be constructed and labeled according to the instructions provided at <http://mrrp.myfwc.com>.
- A2.3.2. Be maintained in working order and emptied frequently (according to <http://mrrp.myfwc.com> standards) so that they do not overflow.
- A2.4.** For any dock project (new construction, repair, or replacement) at a private residence located within 11 nautical miles of North Atlantic right whale critical habitat (as measured in a radius from the center of the nearest inlet to open ocean and described in Section 2.1.1.4), the property owner will be provided a handout with their USACE permit describing the presence of North Atlantic right whales in the area and the Federal regulations governing the approach to North Atlantic right whales (Appendix C).
- A2.5.** ATONs and PATONs must be approved by and installed in accordance with the requirements of the USCG (see 33 CFR, chapter I, subchapter C, part 66 and RHA Section 10 and any other pertinent requirements).
- A2.6.** Chickees must be less than 500 ft<sup>2</sup> and support no more than 2 slips.
- A2.7.** No activities associated with municipal or commercial fishing piers are covered under this Opinion.
- A2.8.** Docks installed within visible distance of ocean beaches are required to comply with turtle-friendly lighting, if lighting is necessary to the project. Turtle-friendly lighting is explained and examples are provided on the Florida Fish and Wildlife Conservation Commission website:  
<http://myfwc.com/wildlifehabitats/managed/sea-turtles/lighting/>
- A2.9.** Project construction will take place from uplands or from floating equipment (e.g., barge); prop or wheel-washing is prohibited.



### Additional PDCs for Activity 2 applicable in Critical Habitat

- A2.10.** *Acropora* critical habitat and the U.S. Caribbean: This Opinion does not cover new and expanded pile-supported structures in *Acropora* critical habitat where the essential features are present. The distance from ATONs to ESA-listed corals and <sup>NW-AMG</sup> *Acropora* critical habitat shall ensure there are no impacts to the corals or the essential feature of *Acropora* critical habitat from the movement of buoys and tackle. The appropriate distance shall be based on the size of the anchor chain or other tackle to be installed to secure the buoy to its anchor, particularly when the design of the ATON does not prohibit contact of tackle with the marine bottom. In all cases, buoy tackle will include flotation to ensure there is no contact between the anchor chain or line and the marine bottom.
- A2.11.** Gulf sturgeon critical habitat: Additional noise restrictions are required for pile and sheet pile installation in the Gulf sturgeon critical habitat migratory restriction zones defined in Section 2.1.1.2. The noise restrictions are described in that section.
- A2.12.** Smalltooth sawfish critical habitat: This Opinion does not cover activities occurring in areas identified as smalltooth sawfish limited exclusion zones defined in Section 2.1.1.1.
- A2.13.** North Atlantic right whale critical habitat: This Opinion does not cover installation of anchored ATONs and permanent buoys in North Atlantic right whale critical habitat; temporary buoys for marine events are allowed in North Atlantic right whale critical habitat.
- A2.14.** Johnson's seagrass critical habitat: This Opinion does not cover new marinas or multi-family facilities in Johnson's seagrass critical habitat. Repair, replacement, and reconfiguration of existing marinas or multi-family facilities may be covered if it (1) occurs within same overall footprint (out to the perimeter of the facility, including the outer limits of the structure and permitted mooring locations), (2) does not increase the total aerial extent (i.e., area of coverage from the dock structures) of the existing facility, and (3) does not affect Johnson's seagrass. Mooring fields are allowed in Johnson's seagrass critical habitat and within the range of Johnson's seagrass so long as they occur in waters deeper than -13 ft (-4 m).
- A2.15.** NWA DPS of loggerhead sea turtle critical habitat: ATONs (pile-supported and anchored buoys) are allowed in nearshore reproductive habitat of the NWA DPS of loggerhead sea turtles under this Opinion. No other pile-supported structures are allowed in nearshore reproductive habitat under this Opinion.
- A2.16.** U.S. Caribbean sea turtle critical habitat (hawksbill, leatherback, and the NA DPS of green sea turtle critical habitat): ATONs (pile-supported and anchored buoys) are allowed near sea turtle nesting beaches under this Opinion. No other pile-supported structures are allowed near sea turtle nesting beaches under this Opinion.

**Project Design Criteria (PDCs) for Docks or Other Minor Structures (PDC A2.17)**

These PDCs address the anticipated dock construction scenarios expected within Florida and the U.S. Caribbean and provide NMFS PRD's construction guidelines for projects occurring (1) within Johnson's seagrass critical habitat; (2) within the range of Johnson's seagrass<sup>18</sup>, but outside of Johnson's seagrass critical habitat; and (3) outside of both the range and critical habitat for Johnson's seagrass. These scenarios consider whether a seagrass survey was conducted for projects within the range of Johnson's seagrass or located in Johnson's seagrass critical habitat. Surveys must be completed no earlier than 1 year before submitting the application to the action agency for project authorization. There is no seasonal restriction for Johnson's seagrass surveys; however, Johnson's seagrass is found within the range of other seagrass species that exhibit a seasonal pattern of growth and distribution. For comparison, NMFS Habitat Conservation Division's recommended sampling window for non-listed species is June 1 to September 30.

**Dock Construction Scenarios**

2020

	<b>Within Johnson's seagrass critical habitat</b>	<b>Within the Range of Johnson's seagrass (outside of critical habitat)</b>	<b>In the U.S. Caribbean and Florida (outside of the range and critical habitat of Johnson's seagrass)</b>
<b>Dock replacement in the exact footprint (i.e., same location/configuration/ size) as the previous dock with...</b>			
<b>No native seagrass under dock</b>	A	A	A
<b>Johnson's seagrass under dock</b>	B	B	N/A
<b>Native seagrass, other than Johnson's seagrass, under the dock</b>	B	A	A
<b>No current seagrass survey</b>	B	B	A
<b>New docks or dock expansions with...</b>			
<b>No native seagrasses within property limits</b>	B	A	A
<b>Johnson's seagrass within property limits</b>	B	B	N/A
<b>Native seagrass, other than Johnson's seagrass, within property limits</b>	B	A	A
<b>No current seagrass survey</b>	B	B	A

A= No additional PDCs; B= Dock must meet PDCs below; N/A = not applicable; Johnson's seagrass could not occur under the dock because the dock project is outside the range of Johnson's seagrass

## Project Design Criteria (PDCs) for In-Water Noise from Pile and Sheet Pile Installation

### Open Water

The letters A-E in the tables below specify the PDC category. Activities labeled A-D must follow the corresponding PDCs for labeled Category A-D below. Activities labeled E are excluded from this Opinion, as stated in Category E below.

	Trench and	Pilot hole (auger or	Jetting	Vibratory	Impact hammer
Wood piles 14-inch (in) diameter or less when installed via impact hammer and 36-in or less for all other installation methods	A	A	A	A	B
Concrete pile 24-in diameter/width or less in open	A	A	A	A	B
Metal pipe pile 36-in diameter or less	A	A	A	A	E
2 metal boatlift I-beams	A	A	A	A	B
Concrete slab wall- any size	A	A	A	A	B
Vinyl sheet pile- any size	A	A	A	A	B
Metal sheet pile- any size	A	A	A	A	E

### Confined Space

In Florida, we consider the confined space to be any area that has a solid object (e.g., shorelines or seawalls) within 150 ft of the pile installation site and in the U.S. Caribbean we consider confined space to be any area that has a solid object within 260 ft of the pile installation site.

	Trench and	Pilot hole (auger or	Jetting	Vibratory	Impact hammer
Wood pile 14-in diameter or less when installed via impact hammer and 36-in or less for all other installation methods	A	A	A	A	B
Concrete pile 24-in diameter/width or less (5 piles	A	A	A	A	C
Concrete pile 24-in diameter/width or less (6-10	A	A	A	A	D
Metal pipe pile 36-in diameter or less	A	A	A	A	E
2 metal boatlift I-beams	A	A	A	A	B
Vinyl sheet pile – any size	A	A	A	A	B
Concrete slab wall- any size (5 slabs or less	A	A	A	A	C
Concrete slab wall- any size (6-10 slabs installed/day)	A	A	A	A	D
Metal sheet pile- any size	A	A	A	A	E

8

- A. The Projects identified as A above must comply with PDCs identified for all projects in this Opinion. Specific PDCs related to noise include:**
1. All work must occur during daylight hours only (PDC AP.6).
  2. All construction personnel are responsible for observing water-related activities to detect the presence of these species and avoid them (PDC AP.7).
- B. The projects identified as B above must follow all of the conditions under A, above, AND also must limit the maximum number of piles installed per day to no more than 10 piles per day.**
- C. The projects identified as C above must follow all of the conditions under A, above, AND also must limit the maximum number of piles installed per day to no more than 5 piles per day.**
- D. The projects identified as D above must follow all of the conditions under A and B, above, AND also must abide by one of the noise abatement measures below, as chosen by the applicant:**
1. Bubble curtain: The bubble curtain design must adhere to the guidelines for unconfined and confined bubble curtains described in Appendix B.
  2. Temporary noise attenuation pile (TNAP) also known as a pile isolation casing: The TNAP design must be constructed of a double-walled tubular casing (a casing within a larger casing), with at least a 5-in-wide area between the casings that is dewatered to create a hollow space or 5-in wide area between the casings completely filled with closed-cell foam or other noise dampening material between the walls. The TNAP must be long enough to be seated firmly on the sea bottom, fit over the pile being driven, and extend at least 3 ft above the surface of the water.
  3. The use of any other alternative noise control method must receive prior approval by NMFS and the USACE, as described in Section 2.3.
- E. The projects identified as E are not covered under this Opinion.**





# CITY OF KEY WEST TARPON PIER - FINGER PIER MODIFICATIONS CITY MARINA AT GARRISON BIGHT, ITB# 00-000

MONROE COUNTY, FLORIDA  
STANTEC PROJECT NO. 215615888

SECTION : 32  
TOWNSHIP: 67S  
RANGE: 25E  
LATITUDE: 24°33'36"  
LONGITUDE: 81°47'01"



**MAYOR & COMMISSION:**  
Teri Johnston, Mayor  
Jimmy Weekey, Commissioner  
Samuel Kaufman, Commissioner  
Billy Wardlow, Commissioner  
Gregory Davila, Commissioner  
Mary Lou Hoover, Commissioner  
Clayton Lopez, Commissioner  
City Manager: Greg Veliz

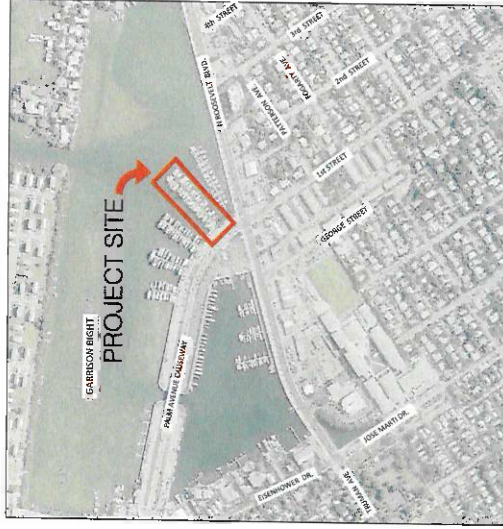

**LOCATION MAP**  
Scale: N.T.S.

SHEET NO.	SHEET DESCRIPTION
C-01	COVER
C-02	OVERALL PLAN
C-03	#####
C-04	#####
C-05	#####
C-06	CROSS SECTIONS

901 Ponce de Leon Blvd., Suite 900  
Coral Gables, Florida, 33134  
Tel. 305-445-2800  
Fax. 305-445-3344  
www.stantec.com

PERMIT SET  
SEPTEMBER 2020

APPROVED BY

CARLOS M. HERDOLIA  
REGISTERED ENGINEER NO. 47660  
STATE OF FLORIDA

APPROVALS		
AGENCY	SUBMITTAL DATE	APPROVAL DATE



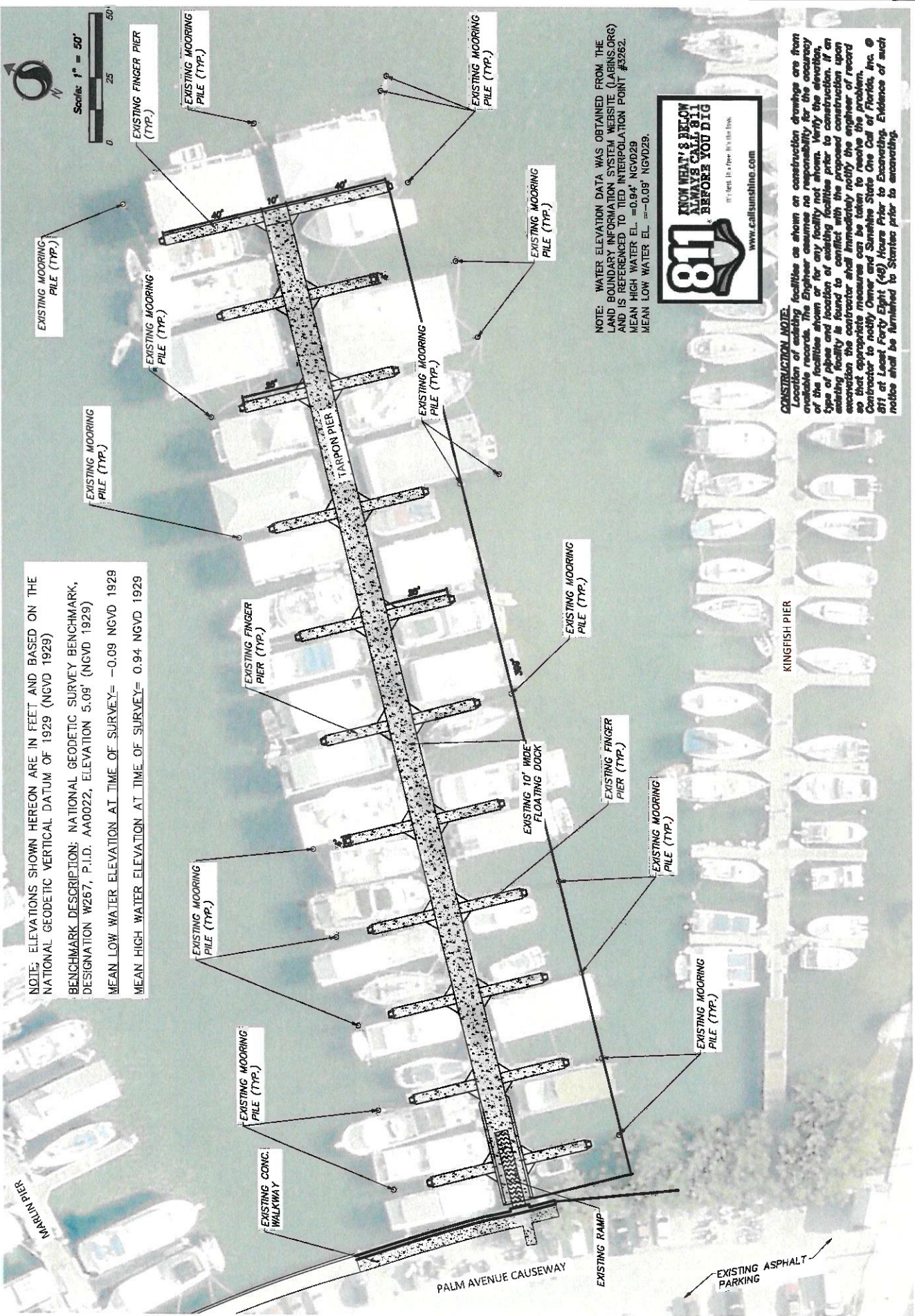

NOTE: ELEVATIONS SHOWN HEREON ARE IN FEET AND BASED ON THE NATIONAL GEODETIC VERTICAL DATUM OF 1929 (NGVD 1929)  
 BENCHMARK DESCRIPTION: NATIONAL GEODETIC SURVEY BENCHMARK, DESIGNATION W267, P.I.D. A40022, ELEVATION 5.09' (NGVD 1929)  
 MEAN LOW WATER ELEVATION AT TIME OF SURVEY = -0.09 NGVD 1929  
 MEAN HIGH WATER ELEVATION AT TIME OF SURVEY = 0.94 NGVD 1929

NOTE: WATER ELEVATION DATA WAS OBTAINED FROM THE LAND BOUNDARY INFORMATION SYSTEM WEBSITE (LAIMS.ORG) AND IS REFERENCED TO TIED INTERPOLATION POINT #3262.  
 MEAN HIGH WATER EL. = 0.94' NGVD29  
 MEAN LOW WATER EL. = -0.08' NGVD29.



**CONSTRUCTION NOTE:**  
 Location of existing facilities as shown on construction drawings are from available records. The Engineer assumes no responsibility for the accuracy of the facilities shown or for any facility not shown. Verify the elevation, type of piles and location of existing facilities prior to construction. If an existing facility is found to conflict with the proposed construction upon excavation the contractor shall immediately notify the engineer of record so that appropriate measures can be taken to resolve the problem. Contractor to notify Owner and Sunshine State One Call of Florida, Inc. @ 811 at Least Forty Eight (48) Hours Prior to Excavating. Evidence of such notice shall be furnished to Stantec prior to excavating.

<b>Stantec</b> <small>303 Ponce de Leon Ave. Suite 400        Coral Gables, Florida 33134        www.stantec.com</small>		<b>811</b> <small>KNOW WHAT'S BELOW        ALWAYS CALL 811        BEFORE YOU DIG        www.callsunshine.com</small>	
<b>SAJ 1999-05418 (LP-AMC)</b> <small>DESIGNED BY: [Redacted] ENGINEER        CHECKED BY: [Redacted] ENGINEER        DATE OF DESIGN: [Redacted]</small>		<b>Page 3 of 6, May 10, 2021</b>	
SHEET NO. 05418-03 DATE: 05/10/21	PROJECT NO. 1999-05418 DRAWING NO. C-04	CITY OF KEY WEST DOLPHIN PIER EXTENSION KEY WEST, FLORIDA	DEMOLITION PLAN Project No. 215015088 Drawing No. C-04 Scale: 1" = 50' Date: 05/10/21



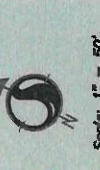

CONTRACTOR TO CAREFULLY REMOVE EXISTING PILE & ATTACH NEW 10' EXTENSION FINGER PER MANUFACTURER RECOMMENDATION & REUSE EXISTING PILE (TYP.)

EXISTING 40' LONG FINGER PIER TO REMAIN. NO EXTENSION PROPOSED FOR THIS FINGER

EXISTING 40' LONG FINGER PIER TO REMAIN. NO EXTENSION PROPOSED FOR THIS FINGER

EXISTING 25' LONG FINGER PIER TO REMAIN (TYP.)

PROPOSED FINGER PIER EXTENSION, 4' WIDE X 10' (TYP.)

PROPOSED FINGER PIER EXTENSION, 4' WIDE X 10' (TYP.)

TURBIDITY CURTAINS TO SURROUND WORKING AREAS TO CONTROL TURBIDITY

CONTRACTOR TO CAREFULLY REMOVE EXISTING PILE & ATTACH NEW 10' EXTENSION FINGER PER MANUFACTURER RECOMMENDATION & REUSE EXISTING PILE (TYP.)

NOTE: WATER ELEVATION DATA WAS OBTAINED FROM THE LAND BOUNDARY INFORMATION SYSTEM WEBSITE (LUBINS.ORG) AND IS REFERENCED TO TIED INTERPOLATION POINT #3262. MEAN HIGH WATER EL. = -0.94' NAD83 MEAN LOW WATER EL. = -0.09' NAD83.



**CONSTRUCTION NOTE:**  
Location of existing facilities as shown on construction drawings are from available records. The Engineer assumes no responsibility for the accuracy of the facilities shown or for any facility not shown. Verify the elevation, type of pipe and location of existing facilities prior to construction. If an existing facility is found to conflict with the proposed construction upon excavation the contractor shall immediately notify the engineer of record so that appropriate measures can be taken to resolve the problem. Contractor to notify Owner and Sunshine State One Call of Florida, Inc. @ 811 at Least Forty Eight (48) Hours Prior to Excavating. Evidence of such notice shall be furnished to Stantec prior to excavating.

EXISTING AREA	PROPOSED AREA
EXISTING DOCK 10' WIDE X 30' LONG = 300 SF	NO CHANGE
(20) FINGER PIER 4' WIDE X 25' LONG = 2,000 SF	(19) FINGER PIER EXTENSION 4' WIDE X 10' LONG = 760 SF
(2) FINGER PIER 4' WIDE X 40' LONG = 320 SF	NO CHANGE
TOTAL AREA = 3,320 SF	TOTAL AREA = 7,070 SF (INCLUDING EXIST. & PIER)

CONTRACTOR TO CAREFULLY REMOVE EXISTING PILE & ATTACH NEW 10' EXTENSION FINGER PER MANUFACTURER RECOMMENDATION & REUSE EXISTING PILE (TYP.)

EXISTING 10' WIDE FLOATING DOCK TO REMAIN

EXISTING 25' LONG FINGER PIER TO REMAIN (TYP.)

EXISTING FINGER PIER TO REMAIN. NO EXTENSION PROPOSED FOR THIS FINGER

**FINGER PIER EXTENSIONS**  
19 FINGER PIER EXTENSIONS = 10' LONG X 4' WIDE = 40 SF EACH  
19 EXTENSIONS = 760 SF TOTAL PIER AREA ADDED  
RELOCATE 19 MOORING PILES TO ACCOMMODATE FINGER PIER EXTENSION

EXISTING ASPHALT PARKING TO REMAIN

PALM AVENUE CAUSEWAY

**Stantec**  
901 Veterans Loop, Suite 100  
Coral Gables, FL 33134  
Phone: 305.442.2000  
Fax: 305.442.2001

**SAJ 1999-05418 (LP-AMC)**  
PROJECT NO. 1999-05418  
DATE OF ISSUE: 05/10/2021

**CITY OF KEY WEST**  
DOLPHIN PIER EXTENSION  
KEY WEST, FLORIDA

Project No. 21565888  
Drawing No. C-05  
Sheet 5 of 5

Scale: \_\_\_\_\_

By: \_\_\_\_\_

Checked: \_\_\_\_\_

Approved: \_\_\_\_\_



## PROJECT REFERENCES

- 1. Description and location of work.** City of Key West Half Shell Raw Bar - Repair/Replacement of seawall.
- 2. Contract amount.** \$431,000
- 3. Dates work was performed.** August - November 2017
- 4. Owner.** City of Key West
- 5. Name of Owner's contact person and phone number.** Karen Olsen 305.849.2348
- 6. Engineer.** Tetra Tech
- 7. Name of Engineer's contact person and phone number.** Stuart E. McGahee 772.781.3440

- 1. Description and location of work.** Monty's on the Grove - Post Hurricane Irma replacement of entire dock marina.
- 2. Contract amount.** \$6,500,000
- 3. Dates work was performed.** 2018-19
- 4. Owner.** Prime Marina (Marina is currently under new ownership, Suntex)
- 5. Name of Owner's contact person and phone number.** Jose Hevia 305.858.9895
- 6. Engineer.** Ocean Consulting (designer)
- 7. Name of Engineer's contact person and phone number.** Kirk Lofgren 305.457.5573

- 1. Description and location of work.** Stock Island Marina Village Phase 2 – Dock demolition and installation of new floating docks.
- 2. Contract amount.** \$500,000
- 3. Dates work was performed.** 2019-2020
- 4. Owner.** Longstock II, LLC dba Stock Island Marina Village
- 5. Name of Owner's contact person and phone number.** N/A
- 6. Engineer.** Florida Floats Inc. dba Bellingham Marine (prime contractor)
- 7. Name of Engineer's contact person and phone number.** Jeffrey Pratt 904.570.1452

- 1. Description and location of work.** City of Key West – Historic seawall repair from Turtle Kraals to Conch Republic.
- 2. Contract amount.** \$1,700,000
- 3. Dates work was performed.** September 2019 - January 2020
- 4. Owner.** City of Key West
- 5. Name of Owner's contact person and phone number.** Karen Olsen 305.849.2348
- 6. Engineer.** Tetra Tech
- 7. Name of Engineer's contact person and phone number.** Stuart E. McGahee 772.781.3440

- 1. Description and location of work.** Dinner Key Marina – Design-build services for marina repairs and restoration post hurricane Irma.
- 2. Contract amount.** \$22,488,038



3. **Dates work was performed.** Ongoing project, expected to be completed September 2021
4. **Owner.** City of Miami
5. **Name of Owner's contact person and phone number.** Robert Fenton 786.263.2133
6. **Engineer.** Cummins Cederberg (Design-Build Team)
7. **Name of Engineer's contact person and phone number.** Jason Taylor 305.741.6155







# CERTIFICATE OF LIABILITY INSURANCE

DATE (MM/DD/YYYY)  
03/31/2021

<b>PRODUCER</b> Trinity Inv. Inc b/d/a Trinity Insurance 4000 Hollywood Blvd Ste 555-S Hollywood, FL 33021 Phone: 305-TRINITY (874-6489), 954-829-5978, 954-613-3601 Fax: 954-206-5978, Email: bgloria@trinityinv.net	<b>THIS CERTIFICATE IS ISSUED AS A MATTER OF INFORMATION ONLY AND CONFERS NO RIGHTS UPON THE CERTIFICATE HOLDER. THIS CERTIFICATE DOES NOT AMEND, EXTEND OR ALTER THE COVERAGE AFFORDED BY THE POLICIES BELOW.</b>	
	<b>INSURERS AFFORDING COVERAGE</b>	<b>NAIC #</b>
<b>INSURED</b> Kearns Construction Company, Inc. 2550 South Bayshore Drive, Suite 206-B Coconut Grove, FL 33133 FLORIDA DBPR LICENSE #CGC060194	INSURER A: Continental Insurance Company	35289
	INSURER B: American Longshore Mutual Assn (ALMA) USLH/Great American Ins Co (FL State Act)	
	INSURER C: National Fire Insurance Co of Hartford	20478
	INSURER D: Liberty Mutual Insurance Company	
	INSURER E:	

### COVERAGES

THE POLICIES OF INSURANCE LISTED BELOW HAVE BEEN ISSUED TO THE INSURED NAMED ABOVE FOR THE POLICY PERIOD INDICATED. NOTWITHSTANDING ANY REQUIREMENT, TERM OR CONDITION OF ANY CONTRACT OR OTHER DOCUMENT WITH RESPECT TO WHICH THIS CERTIFICATE MAY BE ISSUED OR MAY PERTAIN, THE INSURANCE AFFORDED BY THE POLICIES DESCRIBED HEREIN IS SUBJECT TO ALL THE TERMS, EXCLUSIONS AND CONDITIONS OF SUCH POLICIES. AGGREGATE LIMITS SHOWN MAY HAVE BEEN REDUCED BY PAID CLAIMS.

INSR LTR	ADDL INSRD	TYPE OF INSURANCE	POLICY NUMBER	POLICY EFFECTIVE DATE (MM/DD/YY)	POLICY EXPIRATION DATE (MM/DD/YY)	LIMITS
A	Y	<b>GENERAL LIABILITY</b> <input checked="" type="checkbox"/> COMMERCIAL GENERAL LIABILITY <input type="checkbox"/> CLAIMS MADE <input checked="" type="checkbox"/> OCCUR <input checked="" type="checkbox"/> Blanket Additional Insureds <input checked="" type="checkbox"/> Includes XCU GEN'L AGGREGATE LIMIT APPLIES PER: <input type="checkbox"/> POLICY <input type="checkbox"/> PROJECT <input type="checkbox"/> LOC	ML 9780064* Blanket Additional Insured, Waiver of Subrogation, Primary Non-Contributory, Per Project Aggregate "When required by written contract"	03/29/2021	03/29/2022	EACH OCCURRENCE \$ 1,000,000 DAMAGE TO RENTED PREMISES (Ea occurrence) \$ 250,000 MED EXP (Any one person) \$ 10,000 PERSONAL & ADV INJURY \$ 1,000,000 GENERAL AGGREGATE \$ 2,000,000 PRODUCTS - COMP/OP AGG \$ 1,000,000 Deductible BIPD ea claim \$2,500
C	*Y *Y	<b>AUTOMOBILE LIABILITY</b> <input checked="" type="checkbox"/> ANY AUTO <input type="checkbox"/> ALL OWNED AUTOS <input type="checkbox"/> SCHEDULED AUTOS <input checked="" type="checkbox"/> HIRED AUTOS <input checked="" type="checkbox"/> NON-OWNED AUTOS <input checked="" type="checkbox"/> *Blkt Addl Insured, Waiver of Subrogation <input checked="" type="checkbox"/> Primary Non-Contributory	BUA6023678054 *Blanket Additional Insured, Waiver of Subrogation, Primary Non-Contributory "When required by written contract"	03/29/2021	03/29/2022	COMBINED SINGLE LIMIT (Ea accident) \$ 1,000,000 BODILY INJURY (Per person) \$ BODILY INJURY (Per accident) \$ PROPERTY DAMAGE (Per accident) \$
		<b>GARAGE LIABILITY</b> <input type="checkbox"/> ANY AUTO				AUTO ONLY - EA ACCIDENT \$ OTHER THAN AUTO ONLY: EA ACC \$ AGG \$
D		<b>EXCESS/UMBRELLA LIABILITY</b> <input checked="" type="checkbox"/> OCCUR <input type="checkbox"/> CLAIMS MADE <input type="checkbox"/> DEDUCTIBLE <input type="checkbox"/> RETENTION \$	ATAA1SP8007	03/29/2021	03/29/2022	EACH OCCURRENCE \$ 5,000,000 AGGREGATE \$ 5,000,000 Follow Form/Drop Down \$ INCL "Scheduled Vessels" \$ ONLY
B	**	<b>WORKERS COMPENSATION AND EMPLOYERS' LIABILITY</b> ANY PROPRIETOR/PARTNER/EXECUTIVE OFFICER/MEMBER EXCLUDED? NO If yes, describe under SPECIAL PROVISIONS below	FL: Great American Ins Co #WC308605101 AND USL&H: ALMA #ALAM02175-02 **Blanket Waiver of Subrogation "when required by written contract"	03/29/2021	03/29/2022	<input checked="" type="checkbox"/> WC STATUTORY LIMITS <input checked="" type="checkbox"/> OTH-ER USL&H E.L. EACH ACCIDENT \$ 1,000,000 E.L. DISEASE - EA EMPLOYEE \$ 1,000,000 E.L. DISEASE - POLICY LIMIT \$ 1,000,000
A		<b>OTHER</b> Protection & Indemnity Vessel Liability (P&I) FOR SCHEDULED VESSELS ONLY	H 0877068 *Blanket Additional Insured, Waiver of Subrogation, Primary Non Contributory when required by written contract	03/29/2021	03/29/2022	P&I \$1,000,000 each Occurrence incl Roving Crew (5 Crew) for Scheduled Vessels ONLY

DESCRIPTION OF OPERATIONS / LOCATIONS / VEHICLES / EXCLUSIONS ADDED BY ENDORSEMENT / SPECIAL PROVISIONS

RE:  
\* is included as indicated above PLEASE REFER TO SAMPLE MANUSCRIPT ENDORSEMENTS (NON-ISO) ATTACHED, WHICH APPLY WHEN REQUIRED BY WRITTEN CONTRACT SUBJECT TO COVERAGE FORM & EXCLUSIONARY UNDER AFOREMENTIONED POLICY (IES).

\*\*30 Days Advance Notice of Cancellation EXCEPT for Non-Payment of Premium 10 Days

<b>CERTIFICATE HOLDER</b> SAMPLE INSURANCE CERTIFICATE FOR MARINE CONTRACTORS - SHOULD BE ATTACHED TO CONTRACT AS APPROPRIATE INSURANCE REQUIREMENTS FOR JOBS THAT HAVE MARINE EXPOSURE.	<b>CANCELLATION</b> SHOULD ANY OF THE ABOVE DESCRIBED POLICIES BE CANCELLED BEFORE THE EXPIRATION DATE THEREOF, THE ISSUING INSURER WILL ENDEAVOR TO MAIL ** DAYS WRITTEN NOTICE TO THE CERTIFICATE HOLDER NAMED TO THE LEFT, BUT FAILURE TO DO SO SHALL IMPOSE NO OBLIGATION OR LIABILITY OF ANY KIND UPON THE INSURER, ITS AGENTS OR REPRESENTATIVES. AUTHORIZED REPRESENTATIVE Gloria J. Bravo, CIC <i>Gloria J. Bravo</i>
---	--



ENDORSEMENT NO. 8

Date of Issuance 04/02/2019

THIS ENDORSEMENT, EFFECTIVE 03/29/2019 FORMS A PART OF POLICY NO. ML 9780064 OF THE Continental Insurance Company ISSUED TO Kearns Construction Company, Inc.

**Blanket Additional Insured and Waiver of Subrogation Endorsement**

In consideration of an Additional Premium of \$250.00, it is hereby understood and agreed that this policy shall include as Additional Insureds any person or organization to whom the Named Insured has agreed by written contract to provide coverage, but only with respect to operations performed by or on behalf of the Named Insured and only with respect to an "occurrence".

The inclusion of Additional Insureds shall in no way increase the Limit of Liability provided under this policy.

In the event of cancellation or change in policy coverage, unless specifically endorsed in writing herein, we have no obligation to send notice of cancellation or change of coverage to the Additional Insured. Additionally, we shall not be required to notify the Additional Insured of any cancellation request from the Named Insured.

It is further understood and agreed to waive any rights of subrogation to which we may be entitled if prior to an "occurrence" the Named Insured has agreed to such waiver in writing, but only to the extent required by said written agreement.

ALL OTHER TERMS AND CONDITIONS OF THIS POLICY REMAIN UNCHANGED

AGENT OR BROKER NAME AND ADDRESS

International Special Risks, Inc.  
7130 Glen Forest Drive  
Richmond, VA 23226

E6C REV 5/74

745 Printed in U.S.A.



ENDORSEMENT NO. 9

Date of Issuance 04/02/2019

THIS ENDORSEMENT, EFFECTIVE 03/29/2019 FORMS A PART OF POLICY NO. ML 9780064 OF THE Continental Insurance Company ISSUED TO Kearns Construction Company, Inc.

Primary Insurance

In consideration of an Additional Premium of \$500.00, it is understood and agreed that this insurance is primary for the organization shown in the schedule, but only with respect to liability arising out of your work for that organization by or for you. Other insurance afforded to that organization will apply as excess and not contribute as primary to the insurance afforded by this endorsement.

We agree to provide the organization listed below with at least thirty (30) days notice (10) days notice for non-payment of premium of cancellation and (45) days non-renewal notice.

All other endorsements, provisions, conditions and exclusions of this insurance shall remain unchanged and apply to the organization described below.

ALL OTHER TERMS AND CONDITIONS OF THIS POLICY REMAIN UNCHANGED

AGENT OR BROKER NAME AND ADDRESS

International Special Risks, Inc.  
7130 Glen Forest Drive  
Richmond, VA 23226



ENDORSEMENT NO. 10

Date of Issuance 04/02/2019

THIS ENDORSEMENT, EFFECTIVE 03/29/2019 FORMS A PART OF POLICY NO. ML 9780064 OF THE Continental Insurance Company ISSUED TO Kearns Construction Company, Inc.

Per Project Aggregate Limits of Insurance

In consideration of an Additional Premium of \$500.00, it is understood and agreed that the General Aggregate Limit under Section A. Limits of Insurance shall be reinstated for each project where required:

1. With respects to "your work" which is away from premises owned by or rented to you;
2. If the policy General Aggregate has been exhausted;
3. If there is no other coverage or limits available to you under any other insurance carried by you or for your account that would apply if the General Aggregate Limit of Insurance of this policy was not reinstated.

ALL OTHER TERMS AND CONDITIONS OF THIS POLICY REMAIN UNCHANGED

AGENT OR BROKER NAME AND ADDRESS

International Special Risks, Inc.  
7130 Glen Forest Drive  
Richmond, VA 23226

E6C REV 5/74

745 Printed in U.S.A.



ENDORSEMENT NO. 13

Date of Issuance 04/02/2019

THIS ENDORSEMENT, EFFECTIVE 03/29/2019 FORMS A PART OF POLICY NO. ML 9780064 OF THE Continental Insurance Company ISSUED TO Kearns Construction Company, Inc.

**Additional Insured and Waiver of Transfer of Rights of Recovery**

**Against others to US Endorsement (Blanket)**

This endorsement modifies insurance provided under the **COMMERCIAL GENERAL LIABILITY COVERAGE FORM**.

- A. **WHO IS AN INSURED (Section II)** is amended to include any person or organization as an Insured under this policy to the extent you are obligated by an "insured contract" to include them as Additional Insureds, but only with respect to "your work".
- B. The **TRANSFER OF RIGHTS OF RECOVERY AGAINST OTHERS TO US Loss Condition** in the Common Conditions is amended by the addition of the following:

We waive any right of recovery we may have against any person or organization because of payments we make for "bodily injury" or "property damage" arising out of "your work" with that person or organization, but only to the extent that you are obligated by an "insured contract" to provide such waiver of rights of recovery and only with respect to "your work" or to your premises or the premises you use.

ALL OTHER TERMS AND CONDITIONS OF THIS POLICY REMAIN UNCHANGED

AGENT OR BROKER NAME AND ADDRESS

International Special Risks, Inc.  
7130 Glen Forest Drive  
Richmond, VA 23226



ENDORSEMENT NO. 8

Date of Issuance 04/02/2019

THIS ENDORSEMENT, EFFECTIVE 03/29/2019 FORMS A PART OF POLICY NO. H 0877068 OF THE Continental Insurance Company ISSUED TO Kearns Construction Company, Inc.

**ADDITIONAL INSURED(S) & WAIVER OF SUBROGATION - P&I SPECIFIC  
(BLANKET BASIS)**

In consideration of an Additional Premium of \$250.00 it is understood and agreed that this Policy will include, as an Additional Insured, any person or organization, but only to the extent that you are obligated by a "written contract" to include them as Additional Insured(s) and only with respect to work and/or operations performed by you or on your behalf.

The inclusion of an Additional Insured does not in any way extend the type of coverage afforded by the Policy, nor does it increase the limit of liability under the policy.

It is further agreed that we waive any right of recovery we may have against any person or organization because of payments we make for "bodily injury" or "property damage" arising out of "your work" with that person or organization, but only to the extent that you are obligated by "written contract" to provide such waiver of rights of recovery and only with respect to "your work" or to your premises or the premises you use.

"Written Contract" is defined as a contract that is a legally binding agreement between two or more parties which contain the elements of a valid legal agreement, and is enforceable by law or by binding arbitration.

ALL OTHER TERMS AND CONDITIONS OF THIS POLICY REMAIN UNCHANGED

AGENT OR BROKER NAME AND ADDRESS

International Special Risks, Inc.  
7130 Glen Forest Drive, Suite 405  
Richmond, VA. 23226



ENDORSEMENT NO. 16

Date of Issuance 04/02/2019

THIS ENDORSEMENT, EFFECTIVE 03/29/2019 FORMS A PART OF POLICY NO. H 0877068 OF THE Continental Insurance Company ISSUED TO Kearns Construction Company, Inc.

**Blanket Primary & Non-Contributory Endorsement**

**Premium: Included**

In consideration of the additional premium shown in the schedule to this endorsement and subject to all the terms, conditions, limits and exclusions of the policy to which this endorsement is attached, it is agreed that:

It is agreed that to the extent that the Named Insured is obligated by written contract to name any person or organization as an Additional Insured and/or Loss Payee, and/or waive subrogation, Underwriters agree that such person or organization shall be considered as such, and rights of subrogation are hereby waived, but only with respect to the work and/or operations actually performed by or on behalf of the named Assured(s) at the time of the loss and coverage under this policy afforded to the Additional Insured will apply as primary insurance where required by written contract, however, the inclusion of Additional Assured shall in no way increase the limit of liability hereunder, and any other insurance issued to such Additional Insured shall apply as excess non-contributory insurance.

ALL OTHER TERMS AND CONDITIONS OF THIS POLICY REMAIN UNCHANGED

AGENT OR BROKER NAME AND ADDRESS

International Special Risks, Inc.  
7130 Glen Forest Drive, Suite 405  
Richmond, VA. 23226

E6C REV 5/74

745 Printed in U.S.A.



ENDORSEMENT NO. 17

Date of Issuance 04/02/2019

THIS ENDORSEMENT, EFFECTIVE 03/29/2019 FORMS A PART OF POLICY NO. H 0877068 OF THE Continental Insurance Company ISSUED TO Kearns Construction Company, Inc.

**Additional Insured(s) & Waiver of Subrogation  
(Blanket Basis)**

It is agreed that this Policy will include, an Additional Insured, any person or organization, but only to the extent that you are obligated by a "written contract" to include them as an Additional Insured(s) and only with respect to work and/or operations performed by you or on your behalf.

The inclusion of an Additional Insured does not in any way extend the type of coverage afforded by the Policy, nor does it increase the limit of liability under the policy.

It is further agreed that we waive any right of recovery we may have against any person or organization because of payments we make for "bodily injury" or "property damage" arising out of "your work" with that person or organization, but only to the extent that you are obligated by "written contract" to provide such waiver of rights of recovery and only with respect to "your work" or to your premises or the premises you use.

"Written Contract" is defined as a contract that is a legally binding agreement between two or more parties which contain the elements of a valid legal agreement, and is enforceable by law or by binding arbitration.

ALL OTHER TERMS AND CONDITIONS OF THIS POLICY REMAIN UNCHANGED

AGENT OR BROKER NAME AND ADDRESS

International Special Risks, Inc.  
7130 Glen Forest Drive, Suite 405  
Richmond, VA. 23226





**WAIVER OF OUR RIGHT TO RECOVER FROM OTHERS ENDORSEMENT**

This endorsement changes the policy to which it is attached and is effective on the date issued unless otherwise stated.

(The information below is required only when this endorsement is issued subsequent to preparation of the policy.)

Insured		Policy No.	
Company	Effective Date	Premium \$	Endt. No.
Authorized Representative			

**WAIVER OF OUR RIGHT TO RECOVER FROM OTHERS ENDORSEMENT**

We have the right to recover our payments from anyone liable for an injury covered by this policy. We will not enforce our right against the person or organization named in the Schedule. (This agreement applies only to the extent that you perform work under a written contract that requires you to obtain this agreement from us.)

This agreement shall not operate directly or indirectly to benefit anyone not named in the Schedule.

SCHEDULE
ALL ENTITIES COVERED

Countersigned by \_\_\_\_\_  
Authorized Representative

**WAIVER OF SUBROGATION ENDORSEMENT**

This endorsement, effective 12:01 a.m. March 29, 2020, forms part of Certificate No. ALMA02175-02 issued to Kearns Construction Company, Inc., by the American Longshore Mutual Association, Ltd. ("Association").

The Association waives its rights of subrogation against other individuals, firms, organizations or corporations but only when required by written contract and only to the extent required by that contract. This waiver shall apply only in respect to the specific contract existing between the Member and such other individual, firm, organization or corporation and shall not be construed to be a waiver in respect of other operations of such individual, firm, organization or corporation in which the Member has no contractual interest.

Nothing herein contained shall be held to vary, alter, waive or change any of the terms, limits or conditions of this Coverage Agreement, except as hereinabove set forth.



This endorsement changes the policy to which it is attached and is effective on the date issued unless otherwise stated.

**(The information below is required only when this endorsement is issued subsequent to preparation of the policy.)**

Insured Kearns Construction Company, Inc.		Policy No. WC 3086051 01	
Company Great American Insurance Company of New York	Effective Date	Premium \$	Endorsement No.
Authorized Representative The American Equity Underwriters, Inc.			

**WAIVER OF OUR RIGHT TO RECOVER FROM OTHERS ENDORSEMENT**

We have the right to recover our payments from anyone liable for an injury covered by this policy. We will not enforce our right against the person or organization named in the Schedule. (This agreement applies only to the extent that you perform work under a written contract that requires you to obtain this agreement from us.)

This agreement shall not operate directly or indirectly to benefit anyone not named in the Schedule.

Schedule

Any party with whom the insured agrees to waive subrogation in a written contract for the state of Florida



# CERTIFICATE OF LIABILITY INSURANCE

DATE (MM/DD/YYYY)  
03/31/2021

<b>PRODUCER</b> Trinity Inv. Inc b/d/a Trinity Insurance 4000 Hollywood Blvd Ste 555-S Hollywood, FL 33021 Phone: 305-TRINITY (874-6489), 954-829-5978, 954-613-3601 Fax: 954-206-5978, Email: bgloria@trinityinv.net	<b>THIS CERTIFICATE IS ISSUED AS A MATTER OF INFORMATION ONLY AND CONFERS NO RIGHTS UPON THE CERTIFICATE HOLDER. THIS CERTIFICATE DOES NOT AMEND, EXTEND OR ALTER THE COVERAGE AFFORDED BY THE POLICIES BELOW.</b>	
	<b>INSURERS AFFORDING COVERAGE</b>	<b>NAIC #</b>
<b>INSURED</b> Kearns Construction Company, Inc. 2550 South Bayshore Drive, Suite 206-B Coconut Grove, FL 33133 FLORIDA DBPR LICENSE #CGC060194	INSURER A: Underwriters at Lloyds, London	
	INSURER B:	
	INSURER C:	
	INSURER D:	
	INSURER E:	

**COVERAGES**

THE POLICIES OF INSURANCE LISTED BELOW HAVE BEEN ISSUED TO THE INSURED NAMED ABOVE FOR THE POLICY PERIOD INDICATED. NOTWITHSTANDING ANY REQUIREMENT, TERM OR CONDITION OF ANY CONTRACT OR OTHER DOCUMENT WITH RESPECT TO WHICH THIS CERTIFICATE MAY BE ISSUED OR MAY PERTAIN, THE INSURANCE AFFORDED BY THE POLICIES DESCRIBED HEREIN IS SUBJECT TO ALL THE TERMS, EXCLUSIONS AND CONDITIONS OF SUCH POLICIES. AGGREGATE LIMITS SHOWN MAY HAVE BEEN REDUCED BY PAID CLAIMS.

INSR LTR	ADD'L INSRD	TYPE OF INSURANCE	POLICY NUMBER	POLICY EFFECTIVE DATE (MM/DD/YY)	POLICY EXPIRATION DATE (MM/DD/YY)	LIMITS
		<b>GENERAL LIABILITY</b> <input type="checkbox"/> COMMERCIAL GENERAL LIABILITY <input type="checkbox"/> CLAIMS MADE <input type="checkbox"/> OCCUR _____ GEN'L AGGREGATE LIMIT APPLIES PER: <input type="checkbox"/> POLICY <input type="checkbox"/> PROJECT <input type="checkbox"/> LOC				EACH OCCURRENCE \$ DAMAGE TO RENTED PREMISES (Ea occurrence) \$ MED EXP (Any one person) \$ PERSONAL & ADV INJURY \$ GENERAL AGGREGATE \$ PRODUCTS - COMP/OP AGG \$
		<b>AUTOMOBILE LIABILITY</b> <input type="checkbox"/> ANY AUTO <input type="checkbox"/> ALL OWNED AUTOS <input type="checkbox"/> SCHEDULED AUTOS <input type="checkbox"/> HIRED AUTOS <input type="checkbox"/> NON-OWNED AUTOS _____				COMBINED SINGLE LIMIT (Ea accident) \$ BODILY INJURY (Per person) \$ BODILY INJURY (Per accident) \$ PROPERTY DAMAGE (Per accident) \$
		<b>GARAGE LIABILITY</b> <input type="checkbox"/> ANY AUTO <input type="checkbox"/> _____				AUTO ONLY - EA ACCIDENT \$ OTHER THAN AUTO ONLY: EA ACC \$ AGG \$
		<b>EXCESS/UMBRELLA LIABILITY</b> <input type="checkbox"/> OCCUR <input type="checkbox"/> CLAIMS MADE <input type="checkbox"/> DEDUCTIBLE <input type="checkbox"/> RETENTION \$				EACH OCCURRENCE \$ AGGREGATE \$ \$ \$ \$
		<b>WORKERS COMPENSATION AND EMPLOYERS' LIABILITY</b> ANY PROPRIETOR/PARTNER/EXECUTIVE OFFICER/MEMBER EXCLUDED? if yes, describe under SPECIAL PROVISIONS below				<input type="checkbox"/> WC STATUTORY LIMITS <input type="checkbox"/> OTHER E.L. EACH ACCIDENT \$ E.L. DISEASE - EA EMPLOYEE \$ E.L. DISEASE - POLICY LIMIT \$
A		<b>Maritime Employers Liability SHALLOW DIVING</b>	ML900210o	11/13/2020	11/13/2021	Combined Single Limit for all expenses&indemnity, any 1 accident or illness: \$1,000,000

**DESCRIPTION OF OPERATIONS / LOCATIONS / VEHICLES / EXCLUSIONS ADDED BY ENDORSEMENT / SPECIAL PROVISIONS**

Waiver of Subrogation applies when required by written contract.  
 \*\*\*30 Day Advance Notice of Cancellation EXCEPT 10 Days for Non-Payment of Premium

<b>CERTIFICATE HOLDER</b> SAMPLE INSURANCE CERTIFICATE FOR MARINE CONTRACTORS - SHOULD BE ATTACHED TO CONTRACT AS APPROPRIATE INSURANCE REQUIREMENTS FOR JOBS THAT HAVE MARINE EXPOSURE.	<b>CANCELLATION</b> SHOULD ANY OF THE ABOVE DESCRIBED POLICIES BE CANCELLED BEFORE THE EXPIRATION DATE THEREOF, THE ISSUING INSURER WILL ENDEAVOR TO MAIL ___ DAYS WRITTEN NOTICE TO THE CERTIFICATE HOLDER NAMED TO THE LEFT, BUT FAILURE TO DO SO SHALL IMPOSE NO OBLIGATION OR LIABILITY OF ANY KIND UPON THE INSURER, ITS AGENTS OR REPRESENTATIVES. AUTHORIZED REPRESENTATIVE Gloria J. Bravo, CIC <i>Gloria J. Bravo</i>
---	---

**EXCLUSION G REPLACEMENT**  
**LSW 675a**

Any obligation for which You or any carrier as your insurer may be liable under the workers or workman's compensation law, occupational disease law, LONGSHORE AND HARBOUR WORKERS' COMPENSATION ACT, THE NON-APPROPRIATED FUND INSTRUMENTALITIES ACT, THE OUTER CONTINENTAL SHELF LANDS ACT, THE DEFENSE BASE ACT, THE FEDERAL COAL MINE HEALTH AND SAFETY ACT OF 1969, any other workers or workmen's compensation, unemployment compensation, disability benefits law of any state, nation or territory, or any similar law or any amendments to these laws.

**WAIVER OF SUBROGATION**

Underwriters hereon waive their rights of subrogation against any person or organisation to whom the Named Assured is obligated by written contract to provide such waiver, but only to the extent of such obligation and only in respect of operations by or on behalf of the Named Assured or the facility of or used by the Named Assured.

**ALTERNATE EMPLOYER ENDORSEMENT**

This endorsement applies only with respect to bodily injury to your employees while in the course of special or temporary employment by the alternate employer as required by written contract. The insurance afforded by this policy will apply as though the alternate employer is insured.

The insurance afforded by this endorsement is not intended to satisfy the alternate employer's duty to secure its obligations under the Workers' Compensation Law. Underwriters will not file evidence of this insurance on behalf of the alternate employer with any government agency.

Underwriters will not ask any other insurer of this alternate employer to share or participate in a loss covered by this endorsement.

The policy may be cancelled according to its terms without sending notice to the alternate employer.

The Insuring Agreements, Exclusions and Conditions of the policy shall apply to the alternate employer, except condition 13, "Cancellation" (LSW 675) and condition 12 "Cancellation" (LSW 676) which shall not apply to the alternate employer.

**TERRORISM & MALICIOUS ACTS EXCLUSION CLAUSE**

In no case shall this insurance cover any loss damage liability or expense caused by or relating to:-

1. The attempt to or actual detonation of any explosive or the operation of any munition or other similar harmful device, including but not limited to biological and/or chemical device.
2. The act or attempted acts of any terrorist or group of terrorists, irrespective of their motives be they political, religious or other, or any person or group acting with a malicious intent.



# CERTIFICATE OF LIABILITY INSURANCE

DATE (MM/DD/YYYY)  
03/31/2021

<b>PRODUCER</b> Trinity Inv. Inc b/d/a Trinity Insurance 4000 Hollywood Blvd Ste 555-S Hollywood, FL 33021 Phone: 305-TRINITY (874-6489), 954-829-5978, 954-613-3601 Fax: 954-206-5978, Email: bgloria@trinityinv.net		<b>THIS CERTIFICATE IS ISSUED AS A MATTER OF INFORMATION ONLY AND CONFERS NO RIGHTS UPON THE CERTIFICATE HOLDER. THIS CERTIFICATE DOES NOT AMEND, EXTEND OR ALTER THE COVERAGE AFFORDED BY THE POLICIES BELOW.</b>	
<b>INSURED</b> Kearns Construction Company, Inc. 2550 South Bayshore Drive, Suite 206-B Coconut Grove, FL 33133 FLORIDA DBPR LICENSE #CGC060194		<b>INSURERS AFFORDING COVERAGE</b>	<b>NAIC #</b>
		INSURER A: U-Ws@State National Ins Co (57.143%)	12831
		INSURER B: Star Indemnity & Liability Company (25.714%)	38318
		INSURER C: U-Ws@BerkshireHathaway SP Ins Co (17.143%)	
		INSURER D:	
		INSURER E:	

### COVERAGES

THE POLICIES OF INSURANCE LISTED BELOW HAVE BEEN ISSUED TO THE INSURED NAMED ABOVE FOR THE POLICY PERIOD INDICATED. NOTWITHSTANDING ANY REQUIREMENT, TERM OR CONDITION OF ANY CONTRACT OR OTHER DOCUMENT WITH RESPECT TO WHICH THIS CERTIFICATE MAY BE ISSUED OR MAY PERTAIN, THE INSURANCE AFFORDED BY THE POLICIES DESCRIBED HEREIN IS SUBJECT TO ALL THE TERMS, EXCLUSIONS AND CONDITIONS OF SUCH POLICIES. AGGREGATE LIMITS SHOWN MAY HAVE BEEN REDUCED BY PAID CLAIMS.

INSR LTR	ADD'L INSRD	TYPE OF INSURANCE	POLICY NUMBER	POLICY EFFECTIVE DATE (MM/DD/YY)	POLICY EXPIRATION DATE (MM/DD/YY)	LIMITS
		<b>GENERAL LIABILITY</b> <input type="checkbox"/> COMMERCIAL GENERAL LIABILITY <input type="checkbox"/> CLAIMS MADE <input type="checkbox"/> OCCUR  GEN'L AGGREGATE LIMIT APPLIES PER: <input type="checkbox"/> POLICY <input type="checkbox"/> PROJECT <input type="checkbox"/> LOC				EACH OCCURRENCE \$ DAMAGE TO RENTED PREMISES (Ea occurrence) \$ MED EXP (Any one person) \$ PERSONAL & ADV INJURY \$ GENERAL AGGREGATE \$ PRODUCTS - COMP/OP AGG \$
		<b>AUTOMOBILE LIABILITY</b> <input type="checkbox"/> ANY AUTO <input type="checkbox"/> ALL OWNED AUTOS <input type="checkbox"/> SCHEDULED AUTOS <input type="checkbox"/> HIRED AUTOS <input type="checkbox"/> NON-OWNED AUTOS				COMBINED SINGLE LIMIT (Ea accident) \$ BODILY INJURY (Per person) \$ BODILY INJURY (Per accident) \$ PROPERTY DAMAGE (Per accident) \$
		<b>GARAGE LIABILITY</b> <input type="checkbox"/> ANY AUTO				AUTO ONLY - EA ACCIDENT \$ OTHER THAN AUTO ONLY:    EA ACC \$ AGG \$
		<b>EXCESS/UMBRELLA LIABILITY</b> <input type="checkbox"/> OCCUR <input type="checkbox"/> CLAIMS MADE  <input type="checkbox"/> DEDUCTIBLE <input type="checkbox"/> RETENTION \$				EACH OCCURRENCE \$ AGGREGATE \$ \$ \$ \$
		<b>WORKERS COMPENSATION AND EMPLOYERS' LIABILITY</b> ANY PROPRIETOR/PARTNER/EXECUTIVE OFFICER/MEMBER EXCLUDED? If yes, describe under SPECIAL PROVISIONS below				<input type="checkbox"/> WC STATUTORY LIMITS <input type="checkbox"/> OTHER E.L. EACH ACCIDENT \$ E.L. DISEASE - EA EMPLOYEE \$ E.L. DISEASE - POLICY LIMIT \$
A B C		<b>OTHER</b> Vessel Pollution Liability for Scheduled Vessels ONLY	V-14994-20	09/20/2020	09/20/2021	Pollution Limit: \$5,000,000 per Occurrence & Policy Maximum Limit

DESCRIPTION OF OPERATIONS / LOCATIONS / VEHICLES / EXCLUSIONS ADDED BY ENDORSEMENT / SPECIAL PROVISIONS  
 RE:  
 Annual Aggregates  
 (a) US Criminal Defense (Section 8 of Chapter 2) \$100,000 per Occurrence/\$100,000 Annual Aggregate  
 (b) Fines & Penalties (Section 4 of Chapter 2) \$1,000,000 per Occurrence/\$1,000,000 Annual Aggregate  
 BLANKET ADDITIONAL INSURED ENDORSEMENT & SCHEDULE OF COVERED VESSELS ARE ATTACHED.

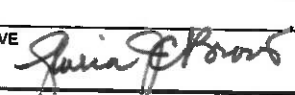
<b>CERTIFICATE HOLDER</b>	***30 Day Advance Notice of Cancellation EXCEPT 10 Days for Non-Payment of Premium
<b>SAMPLE INSURANCE CERTIFICATE FOR MARINE CONTRACTORS - SHOULD BE ATTACHED TO CONTRACT AS APPROPRIATE INSURANCE REQUIREMENTS FOR JOBS THAT HAVE MARINE EXPOSURE.</b>	<b>CANCELLATION</b> SHOULD ANY OF THE ABOVE DESCRIBED POLICIES BE CANCELLED BEFORE THE EXPIRATION DATE THEREOF, THE ISSUING INSURER WILL ENDEAVOR TO MAIL *** DAYS WRITTEN NOTICE TO THE CERTIFICATE HOLDER NAMED TO THE LEFT, BUT FAILURE TO DO SO SHALL IMPOSE NO OBLIGATION OR LIABILITY OF ANY KIND UPON THE INSURER, ITS AGENTS OR REPRESENTATIVES.
	AUTHORIZED REPRESENTATIVE Gloria J. Bravo, CIC 

**KEARNS CONSTRUCTION**  
**20-21 SCHEDULE OF VESSELS**

Edition date: 02/02/21

YEAR	MAKE	DIMENSIONS	NAME	SERIAL #	VALUE
<b>BARGES</b>					
1993		110' X 40' X 7'	KS346 BARGE	1292287	265,000
2019	CONRAD INDUSTRIES	139 X 45 6-11	JENNIE K ABS BARGE	PENDING	899,000
2017		55 X 22 X 5	RB SECTIONAL SPUD BARGE	N/A	25,624
1985	STEEL	120 X 45 X 7	DAVIS	1259918	330,000
2014		33 X 22 X 3	SECTIONAL SPUD BARGE "SELF PROPELLED"	N/A	30,813
2010	STEEL	90 X 35	RIO SOCCO II		58,000
2006	STEEL	100 X 36 X 8	HAIL MARY	N/A	125,000
<b>PUSHBOATS</b>					
2019	STEEL	30X14X6	MICHELLE	PENDING	265,000
2016	STEEL	16 X 14 X 6	KAREN	1267798	270,000
2012	STEEL	25.5 X 14 X 6	ELLY	1243114	220,000
2008	STEEL	25.5 X 14 X 6	FAT JACK	1210609	160,000
<b>CREW BOATS</b>					
2002	FIBERGLASS	18'-2"	BOSTON WHALER W/ MERCURY	BWCE3101E202	20,000
1990	FIBERGLASS	19'	BOSTON WHALER W/ 150 YAMAHA	BWC7218EA090	12,136
2000	FIBERGLASS	22'-3"	BOSTON WHALER W/ 225 HP YAMAHA	BWCJL247F000	16,658
1984		18'	BOSTON WHALER W/ 115 HP YAMAHA	BWC7228AM84	20,000
2002	FIBERGLASS	39.3 X 13.1 X 6.3	BENETEAU "CATHERINE" SAILBOAT	1133756	125,000
2016	FIBERGLASS	34'-8"	ISLAND RUNNER "OFFICIAL BUSINESS II"	INT350320516	248,000
2007	ALUMINUM	21'-0"	PONTOON PARTY BOAT	MAU30599A707	7,000
				Total Insd Value:	3,097,231

*Handwritten mark*



Safe Harbor Pollution  
66 Whitecap Drive  
North Kingstown, RI 02852  
United States  
Phone: 401.792.0144  
Fax: 516.795.8806  
Website: www.SafeHarborPollution.com

**Endorsement No. 3 attached to and forming part of Pollution Policy No. V-14994-20**

**ISSUED TO: Kearns Construction Company**

It is understood and agreed that the **BLANKET ADDITIONAL INSURED ENDORSEMENT** is hereto attached to this Pollution contract as follows:

**BLANKET ADDITIONAL INSURED ENDORSEMENT**

1. Where a vessel is identified in the Schedule of Vessels and is working or performing services pursuant to an oral or written contract between the Insured and an entity or person not insured under the Policy, and if required by the contract, the entity or person with whom the Insured has contracted to work or perform services is hereby named as an additional insured under the Policy, but only to the extent required by the contract.
2. As a condition precedent to the additional insured coverage provided by this Endorsement, the Insured shall at the inception of the Policy or within sixty (60) days of entering into such oral or written contract (if entered after the inception of the Policy), advise the Company in writing of the identity and address of each person or entity the Insured is required by the contract to name as an additional insured under the Policy.

**Effective on or after September 20, 2020.**

**ALL OTHER TERMS AND CONDITIONS REMAIN UNCHANGED.**

**Signed at North Kingstown, Rhode Island on the 5th day of October 2020.**

**By:**

  
Authorized Signature







# CERTIFICATE OF LIABILITY INSURANCE

DATE (MM/DD/YYYY)  
03/31/2021

<b>PRODUCER</b> Trinity Inv. Inc b/d/a Trinity Insurance 4000 Hollywood Blvd Ste 555-S Hollywood, FL 33021 Phone: 305-TRINITY (874-6489), 954-829-5978, 954-613-3601 Fax: 954-206-5978, Email: bgloria@trinityinv.net	<b>THIS CERTIFICATE IS ISSUED AS A MATTER OF INFORMATION ONLY AND CONFERS NO RIGHTS UPON THE CERTIFICATE HOLDER. THIS CERTIFICATE DOES NOT AMEND, EXTEND OR ALTER THE COVERAGE AFFORDED BY THE POLICIES BELOW.</b>	
	<b>INSURERS AFFORDING COVERAGE</b>	<b>NAIC #</b>
<b>INSURED</b> Kearns Construction Company, Inc. 2550 South Bayshore Drive, Suite 206-B Coconut Grove, FL 33133 FLORIDA DBPR LICENSE #CGC060194	INSURER A: NAUTILUS INS COMPANY	
	INSURER B:	
	INSURER C:	
	INSURER D:	
	INSURER E:	

### COVERAGES

THE POLICIES OF INSURANCE LISTED BELOW HAVE BEEN ISSUED TO THE INSURED NAMED ABOVE FOR THE POLICY PERIOD INDICATED. NOTWITHSTANDING ANY REQUIREMENT, TERM OR CONDITION OF ANY CONTRACT OR OTHER DOCUMENT WITH RESPECT TO WHICH THIS CERTIFICATE MAY BE ISSUED OR MAY PERTAIN, THE INSURANCE AFFORDED BY THE POLICIES DESCRIBED HEREIN IS SUBJECT TO ALL THE TERMS, EXCLUSIONS AND CONDITIONS OF SUCH POLICIES. AGGREGATE LIMITS SHOWN MAY HAVE BEEN REDUCED BY PAID CLAIMS.

INSR LTR	ADD'L INSRD	TYPE OF INSURANCE	POLICY NUMBER	POLICY EFFECTIVE DATE (MM/DD/YY)	POLICY EXPIRATION DATE (MM/DD/YY)	LIMITS
		<b>GENERAL LIABILITY</b> <input type="checkbox"/> COMMERCIAL GENERAL LIABILITY <input type="checkbox"/> CLAIMS MADE <input type="checkbox"/> OCCUR _____ _____ GEN'L AGGREGATE LIMIT APPLIES PER: <input type="checkbox"/> POLICY <input type="checkbox"/> PROJECT <input type="checkbox"/> LOC				EACH OCCURRENCE \$ DAMAGE TO RENTED PREMISES (Ea occurrence) \$ MED EXP (Any one person) \$ PERSONAL & ADV INJURY \$ GENERAL AGGREGATE \$ PRODUCTS - COMP/OP AGG \$
		<b>AUTOMOBILE LIABILITY</b> <input type="checkbox"/> ANY AUTO <input type="checkbox"/> ALL OWNED AUTOS <input type="checkbox"/> SCHEDULED AUTOS <input type="checkbox"/> HIRED AUTOS <input type="checkbox"/> NON-OWNED AUTOS _____				COMBINED SINGLE LIMIT (Ea accident) \$ BODILY INJURY (Per person) \$ BODILY INJURY (Per accident) \$ PROPERTY DAMAGE (Per accident) \$
		<b>GARAGE LIABILITY</b> <input type="checkbox"/> ANY AUTO				AUTO ONLY - EA ACCIDENT \$ OTHER THAN AUTO ONLY: EA ACC \$ AGG \$
		<b>EXCESS/UMBRELLA LIABILITY</b> <input type="checkbox"/> OCCUR <input type="checkbox"/> CLAIMS MADE  <input type="checkbox"/> DEDUCTIBLE <input type="checkbox"/> RETENTION \$				EACH OCCURRENCE \$ AGGREGATE \$ \$ \$ \$
		<b>WORKERS COMPENSATION AND EMPLOYERS' LIABILITY</b> ANY PROPRIETOR/PARTNER/EXECUTIVE OFFICER/MEMBER EXCLUDED? If yes, describe under SPECIAL PROVISIONS below OTHER				<input type="checkbox"/> WC STATUTORY LIMITS <input type="checkbox"/> OTHER E.L. EACH ACCIDENT \$ E.L. DISEASE - EA EMPLOYEE \$ E.L. DISEASE - POLICY LIMIT \$
A		<b>CONTRACTORS POLLUTION LIABILITY</b> \$5,000 RETENTION	CPL2026683-12	07/10/2020	07/10/2021	Pollution Limit: 2,000,000 per Occurrence 2,000,000 Aggregate

### DESCRIPTION OF OPERATIONS / LOCATIONS / VEHICLES / EXCLUSIONS ADDED BY ENDORSEMENT / SPECIAL PROVISIONS

\*Certificate Holder is included as indicated on the attached endorsements "WHEN REQUIRED BY WRITTEN CONTRACT." SAMPLE COPIES OF ENDORSEMENTS ARE ATTACHED.

\*\*\*30 Day Advance Notice of Cancellation EXCEPT 10 Days for Non-Payment of Premium

### CERTIFICATE HOLDER

SAMPLE INSURANCE CERTIFICATE FOR MARINE CONTRACTORS - SHOULD BE ATTACHED TO CONTRACT AS APPROPRIATE INSURANCE REQUIREMENTS FOR JOBS THAT HAVE MARINE EXPOSURE.

### CANCELLATION

SHOULD ANY OF THE ABOVE DESCRIBED POLICIES BE CANCELLED BEFORE THE EXPIRATION DATE THEREOF, THE ISSUING INSURER WILL ENDEAVOR TO MAIL \*\*\* DAYS WRITTEN NOTICE TO THE CERTIFICATE HOLDER NAMED TO THE LEFT, BUT FAILURE TO DO SO SHALL IMPOSE NO OBLIGATION OR LIABILITY OF ANY KIND UPON THE INSURER, ITS AGENTS OR REPRESENTATIVES.

AUTHORIZED REPRESENTATIVE  
 Gloria J. Bravo, CIC

## ENDORSEMENT

This endorsement forms a part of the policy to which it is attached. Please read it carefully.

### WAIVER OF SUBROGATION

It is agreed that the Company, in the event of any payment under this policy, waives its right of recovery against any Principal, but only at the specific written request of the Named Insured either before or after loss, wherein such waiver has been included before loss as part of a contractual undertaking by the Named Insured.

This waiver shall apply only with respect to losses occurring due to operations undertaken as per the specific contract existing between the Named Insured and such Principal and shall not be construed to be a waiver with respect to other operations of such Principal in which the Named Insured has no contractual interest.

No waiver of subrogation shall directly or indirectly apply to any employee, employees or agents of either the Named Insured or of the Principal, and the Company reserves its right or lien to be reimbursed from any recovery funds obtained by any injured employee.

This waiver does not apply in any jurisdiction or situation where such waiver is held to be illegal or against public policy or in any situation wherein the Principal against whom subrogation is to be waived is found to be solely negligent.



## ENDORSEMENT

This endorsement forms a part of the policy to which it is attached. Please read it carefully.

### ADDITIONAL INSURED – BLANKET

This endorsement modifies insurance provided under the following:

#### CONTRACTORS POLLUTION LIABILITY

**VI. DEFINITIONS, 5. Insured** is amended to include as an insured any person(s) or organization(s) when you and such person(s) or organization(s) have agreed in a written contract or written agreement that such person(s) or organization(s) be added as an additional insured on your policy. Such written contract or written agreement must be in effect prior to the performance of your work which is the subject of such written contract or written agreement, but only with respect to liability for **bodily injury or property damage** caused, in whole or in part, by **your work** for that additional insured.

With respect to damages caused by your work, as described above, the coverage provided hereunder shall be primary and not contributing with any other insurance available to those person(s) or organization(s) with which you have so agreed in a written contract or written agreement.

**ALL OTHER TERMS AND CONDITIONS OF THE POLICY SHALL APPLY AND REMAIN UNCHANGED.**

## IMPORTANT

If the certificate holder is an ADDITIONAL INSURED, the policy(ies) must be endorsed. A statement on this certificate does not confer rights to the certificate holder in lieu of such endorsement(s).

If SUBROGATION IS WAIVED, subject to the terms and conditions of the policy, certain policies may require an endorsement. A statement on this certificate does not confer rights to the certificate holder in lieu of such endorsement(s).

## DISCLAIMER

The Certificate of Insurance on the reverse side of this form does not constitute a contract between the issuing insurer(s), authorized representative or producer, and the certificate holder, nor does it affirmatively or negatively amend, extend or alter the coverage afforded by the policies listed thereon.





**PORT & MARINE SERVICES**  
201 William Street  
Key West, FL  
33040

**ADDENDUM NO. 1**

**TARPON FINGER PIER EXTENSIONS  
CITY MARINA at GARRISON BIGHT  
ITB #21-013**

The information contained in this Addendum adds information to be included in the Bid and is hereby made a part of the Contract Documents. The referenced bid package is hereby addended in accordance with the following items:

**GENERAL NOTES:**

1. Mandatory Pre-Bid sign-in sheet attached.

**QUESTIONS & CLARIFICATIONS:**

1. Would it be possible to obtain a copy of the drawings from the construction of the existing marina finger piers/ steel pipe pile?

**Original Bid Documents attached**

2. Please provide any relevant boring data from former geotechnical report(s) with which to assess the sub-strata material(s)?

**Geotechnical report included with original Bid Documents attached**

3. Please confirm that it is the City's request and intention to have the contractor to move and/or shift vessels and property of tenants. Please remove the scope to relocate or move any private vessels or property.

**As per the Scope of Services the contractor is required to temporarily shift or move existing vessels or floating structures to accommodate removals and installation.**

All other elements of the Contract and Bid documents, including the Bid Date shall remain unchanged. All Bidders shall acknowledge receipt and acceptance of this **Addendum No. 1** by submitting the addendum with their proposal. Proposals submitted without acknowledgement or without this Addendum may be considered non-responsive.

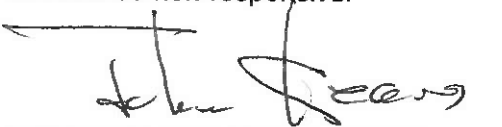
  
\_\_\_\_\_  
Signature

  
\_\_\_\_\_  
Name of Business





SECURITY FEATURES INCLUDE TRUE WATERMARK PAPER, HEAT SENSITIVE ICON AND FOIL HOLOGRAM

**GROVE BANK & TRUST**

www.grovebankandtrust.com 1305.558.6666

Aventura | Coconut Grove | Coral Gables | Palmateo Bay | South Miami

REMITTER

KEARNS CONSTRUCTION COMPANY

*Cashier's Check*

**107805**

Date: 7/27/21

Branch: 0001

VOID AFTER 180 DAYS

**PAY TO THE ORDER OF CITY OF KEY WEST**

EXACTLY \*\*16,500 AND 00/100 DOLLARS

••••• \$16,500.00

TARPON PIER EXTENSION

⑈0000107805⑈ ⑆066004600⑆ 0185703606⑈

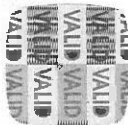

AUTHORIZED SIGNATURE

*Justin S. [Signature]*

MP

Grove Bank & Trust

*Cashier's Check*

**107805**

**NOTICE TO CUSTOMERS**

A DECLARATION OF LOST AND INDEMNITY AGREEMENT AND A 90 DAY WAITING PERIOD WILL BE REQUIRED BEFORE THIS CHECK WILL BE REPLACED OR REISSUED IN THE EVENT IT IS LOST, MISPLACED OR STOLEN.

DATE: 7/27/21

REMITTER: KEARNS CONSTRUCTION COMPANY

TO: CITY OF KEY WEST

BRANCH: 0001  
ORIGINATOR: U57MAJA  
TIME: 9:52:28  
CK AMT: \$16,500.00  
FEE AMT: \$.00  
TOTAL: \$16,500.00

**NON-NEGOTIABLE**

TARPON PIER EXTENSION

