

Staff Report

12b Partial demolition on the back and front porch -#919 Southard Street-
Robert M. Gurney (H11-01-1243)

This staff report is for the review of a Certificate of Appropriateness for a request for demolition of non historic attached additions on the back and demolition of a back historic portion of the house.

The house located on #919 Southard Street is listed as a contributing resource. The house had been altered through the years, attached non historic additions can be found on the back. The application includes the demolition of part of the back of the house that, although altered, is historic. There is no evidence that the historic part of the house is under extreme deterioration.

Staff understands that the request to remove the attached additions constitutes demolition. The criteria when reviewing a Certificate of Appropriateness that request demolition in under Sec. 102-218 of the LDR's;

(a) The historic architectural review commission shall issue a certificate of appropriateness for an application for demolition:

(1) If the subject of the application is a contributing or historic building or structure, then it should not be demolished unless its condition is irrevocably compromised by extreme deterioration or it does not meet any of the criteria of section 102-125(1) through (9).

The Code also establishes, under Sec. 102-1, Definitions, that a historic building or structure means;

any building or structure which, in whole or in any structural part, was built 50 or more years prior to the current date, and which is located in the historic zoning districts of the city or has been designated as a historic building and/or structure.

It is staff's belief that the proposed request can be considered by the Commission since the proposed structures to be demolish are not historic nor can they be consider as contributing parts to the historic house. However the back portion of the house that is historic should be retained and restored. This will be the first reading for this demolition request.

Application



**CITY OF KEY WEST
BUILDING DEPARTMENT
CERTIFICATE OF APPROPRIATENESS**

APPLICATION # HH-01-1243

OWNER'S NAME: PETER + SABRINA GLASS DATE: 09.16.2011

OWNER'S ADDRESS: 919 SOUTHARD AVE. Key West, FL PHONE #: 631 495 4103

APPLICANT'S NAME: ROBERT M. GURNEY, FAIA Architect PHONE #: 202 237 0925

APPLICANT'S ADDRESS: 5110 1/2 MACARTHUR BLVD NW Washington, DC 20016

ADDRESS OF CONSTRUCTION: 919 SOUTHARD AVE. Key West, FL # OF UNITS: 1

THERE WILL BE A FINAL INSPECTION REQUIRED UNDER THIS PERMIT

DETAILED DESCRIPTION OF WORK:
RENOVATION AND ADDITION TO AN EXISTING SINGLE FAMILY DWELLING - PARTIAL DEMOLITION OF EXISTING HOUSE. New front porch, wood posts and railing. New wood side stair. New 6'-0" high fence. New swimming pool. New deck. New trees. New mechanical. Remove existing AC window units. Replace existing shutters. Repair or replace existing board and batten and roofing as well as windows to match existing.

Chapter 837.06 F.S.-False Official Statements - Whoever knowingly makes a false statement in writing with the intent to mislead a public servant in the performance of his or her official duty shall be guilty of a misdemeanor of the second degree punishable as provided for in s. 775.082 or 775.083

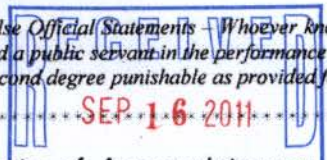

This application for Certificate of Appropriateness must precede applications for building permits, right of way permits, variances, and development review approvals. Applications must meet or exceed the requirements outlined by the Secretary of the Interior's Standards for Rehabilitation and Key West's Historic Architectural Guidelines.

Once completed, the application shall be reviewed by staff for completeness and either approved or scheduled for presentation to the Historic Architectural Review Commission at the next available meeting. The applicant must be present at this meeting. The filing of this application does not ensure approval as submitted.

Applications that do not possess the required Submittals will be considered incomplete and will not be reviewed for approval.

Date: 09.16.2011

Applicant's Signature: Robert M. Gurney

Required Submittals

TWO SETS OF SCALED DRAWINGS OF FLOOR PLAN, SITE PLAN AND EXTERIOR ELEVATIONS (for new buildings and additions)
TREE REMOVAL PERMIT (if applicable)
PHOTOGRAPHS OF EXISTING BUILDING (repairs, rehabs, or expansions)
PHOTOGRAPHS OF ADJACENT BUILDINGS (new buildings and additions)
ILLUSTRATIONS OF MANUFACTURED PRODUCTS TO BE USED SUCH AS SHUTTERS, DOORS, WINDOWS, PAINT COLOR CHIPS, AND AWNING FABRIC SAMPLES

Staff Use Only

Date: _____

Staff Approval: _____

Fee Due: \$ _____

HISTORIC ARCHITECTURAL REVIEW APPLICATION

HISTORIC ARCHITECTURAL REVIEW COMMISSION USE ONLY

Approved _____

Denied _____

Deferred _____

Reason for Deferral or Denial:

HARC Comments:

*listed as a contributing resource. frame vernacular
built c. 1889.*

Ordinance for demolitions

Guidelines for Additions / alterations

and new construction (pages 36-38)

Limit of Work Approved, Conditions of Approval and/or Suggested
Changes:

Date: _____

Signature: _____

Historic Architectural
Review Commission

Sanborn Maps

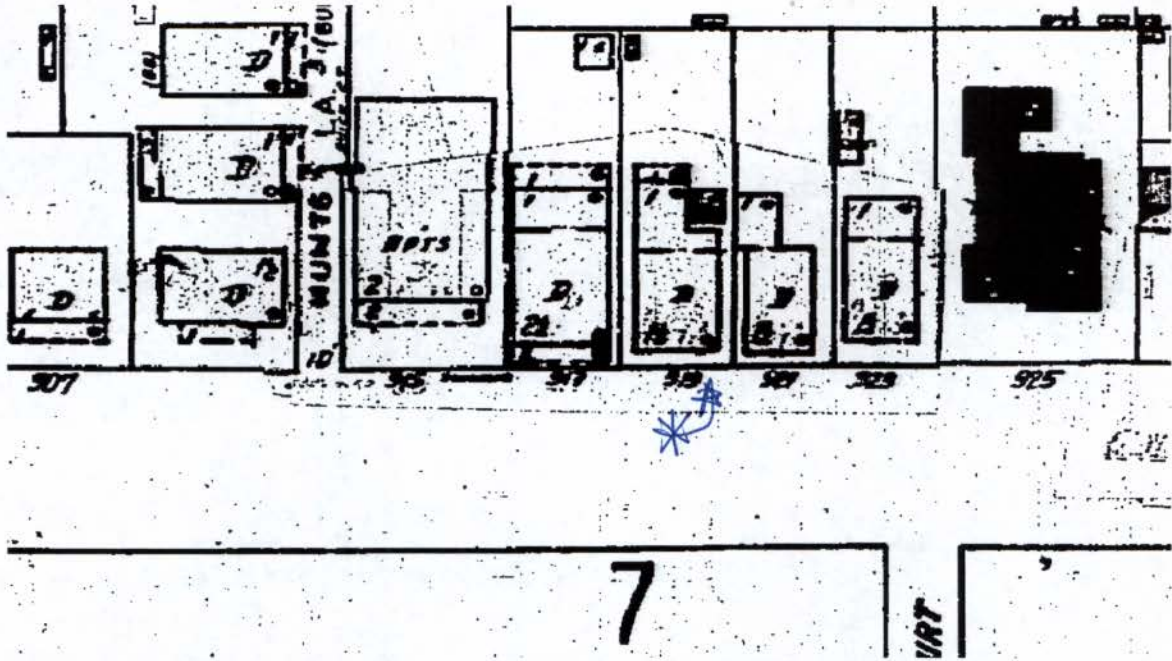

#919 Southard Street Sanborn map 1948

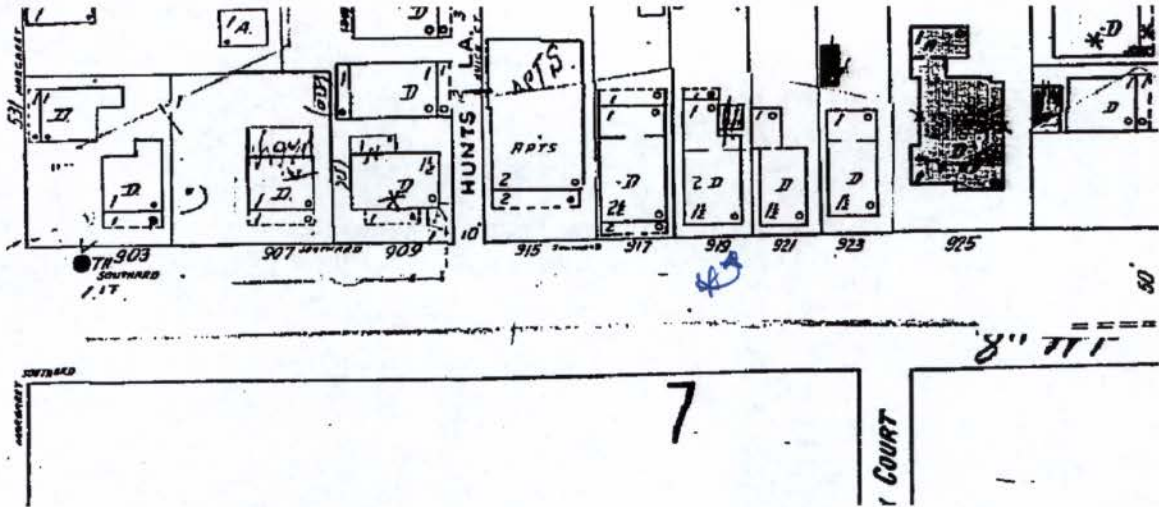

#919 Southard Street Sanborn map 1962 copy

Project Photos



Photo taken by Property Appraiser's office c1965; 919 Southard Street; built c1889;
Monroe County Library





















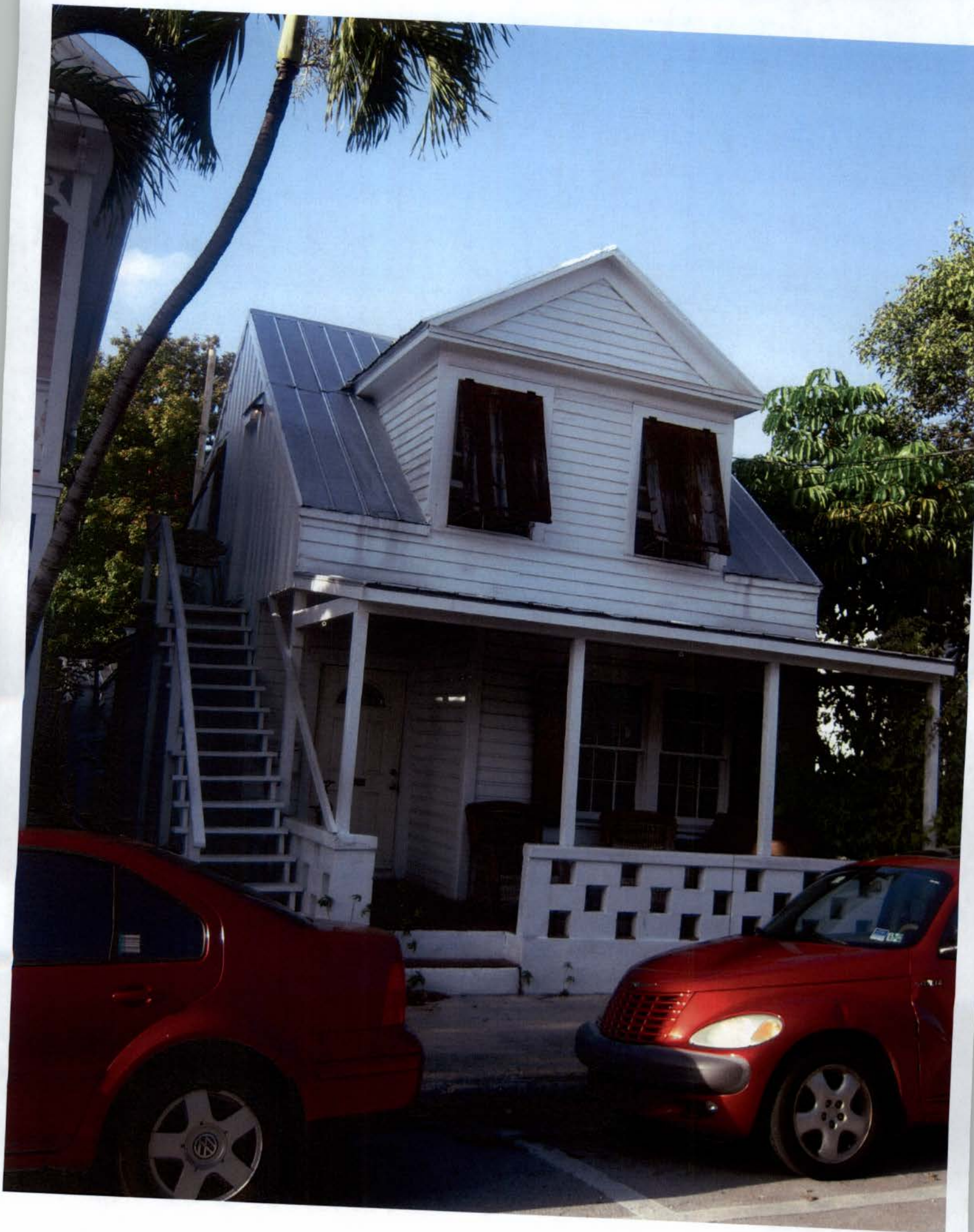









Correspondence

ROBERT M. GURNEY, FAIA
ARCHITECT



TRANSMITTAL

GLASS residence III 919 Southard Ave. Key West, FL
09/20/2011

to: Enid Torregrosa
Historic Preservation Planner
City of Key West

address: 3140 Flagler Avenue
Key West, Florida 33040

phone: 305.809.3973 Direct

contents: (2) sets of drawings date September 16th, 2011
existing photographs
HARC application
(2) renderings of proposed work
Bermuda and Board and Batten Shutter Specs

Hi Anid,

Thank you for all your help. I've enclosed 2 sets of drawings, the application, the existing photographs, 3d renderings of the proposed work and Shutter specifications. Please let me know if you need anything else from us for the September 27th meeting.

Thanks,
Sarah

Sarah Mailhot
Associate
Robert M. Gurney, FAIA
Architect

* The drawings AND other info will come
in 2 separate packages.



Enid Torregrosa <etorregr@keywestcity.com>

FW: Glass Drawings and Renderings

2 messages

Robert Gurney <RMG@robertgurneyarchitect.com>

Fri, Sep 9, 2011 at 4:45 PM

To: Enid Torregrosa <etorregr@keywestcity.com>

Dear Enid,

Attached, please find drawings for 9191 Southard Street, a project I hope to present to HARC on September 27th. Per our conversation, I am hoping you can take a look at the drawings and let me know thoughts on the direction the project is headed. Also, will I need additional info to submit on Tuesday?

Thanks for your help.

Regards, Robert Gurney

Glass drawings and renderings.pdf
4102K

Enid Torregrosa <etorregr@keywestcity.com>

Tue, Sep 13, 2011 at 12:12 PM

To: Robert Gurney <RMG@robertgurneyarchitect.com>

Cc: sarah@robertgurneyarchitect.com

Dear Robert:

Thank you for your e-mail. You need to submit a HARC application, which I am including a link;
http://www.keywestcity.com/egov/docs/1205951840_135986.pdf

I need two full size set of plans. Elevations and floor plans need to have dimensions. I also need existing conditions photos and existing site plan. Do you have existing elevations? Elevations need to have dimensions and specifications of materials, including windows and doors manufacturer. Second floor plans need to have first floor roof plans, many of the commissioners are not architects and the more complete set of drawings the better they will understand your project. Demolition plans are also needed as well as the survey map. Square footage of exterior deck and swimming pool is needed. Are you proposing any changes to the historic house, new doors and windows? If so please specify in the plans. If you are proposing fences or garden walls I need height dimensions and materials.

If windows a/c units will be removed and replaced with new a/c system you need to include the unit (s) in the site plan.

By reviewing the plans I am concern about the mass and scale of the new addition in relation to the existing historic house.

Please do no hesitate to contact me if you have any questions.

Enid Torregrosa
Historic Preservation Planner
City of Key West

3140 Flagler Avenue
Key West, Florida 33040
305.809.3973 Direct
305.808.3978 Fax

[Quoted text hidden]

Survey

Boundary Survey Map of part of Lot 1, Square 46, Island of Key West



LEGEND

- Found 2" Iron Pipe (Fence Post)
- Set 3/4" Iron Pipe w/cap (8298)
- Found 1/2" Iron Rod (2883)
- ▲ Found Nail & Disc (5234)
- ▲ Set Nail & Disc (8298)
- (M) Measured
- (R) Record
- (M/R) Measured & Record
- C.S.S. Concrete Block Structure
- R/W Right of Way
- CLF Chain Link Fence
- E Centerline
- Wood Utility Pole
- Concrete Utility Pole
- Overhead Utility Lines

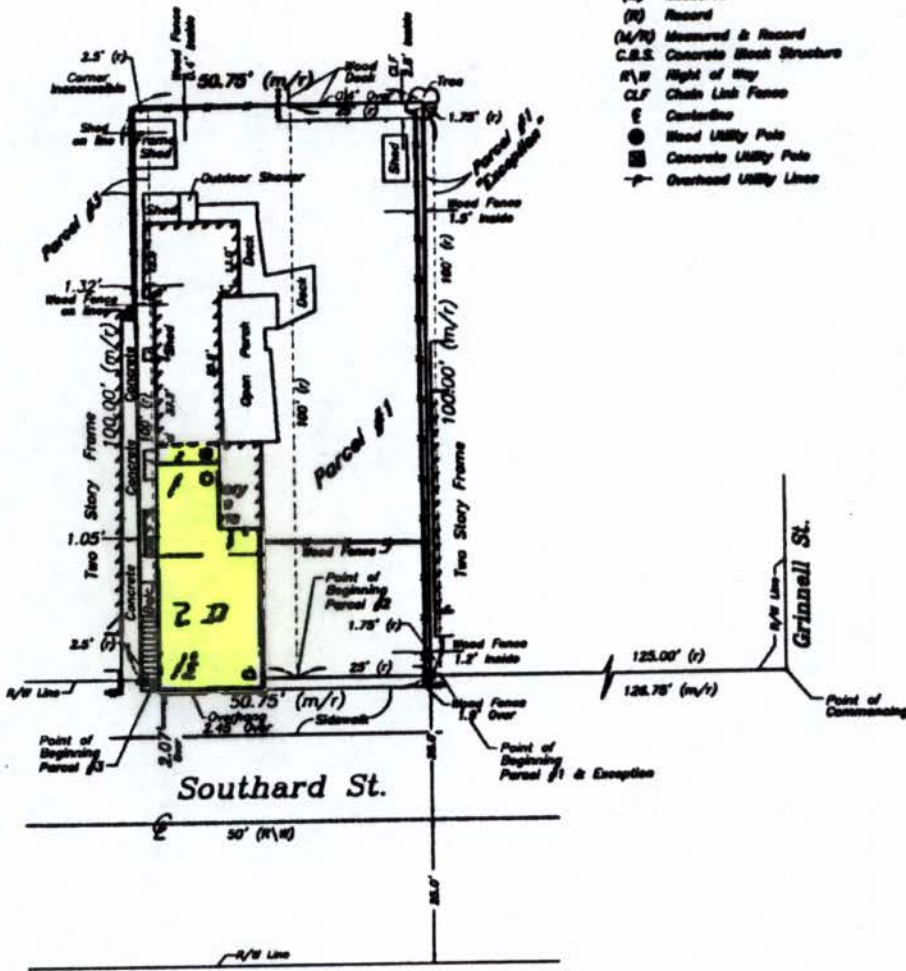

Footprint of 1962 Sanborn Map
over imposed on survey map.

Site Plans





GLASS residence

renovation / addition

919 southard street
key west florida 33040



DRAWING INDEX

- A1.1 COVER SHEET
- A2.0 EXISTING BOUNDARY SURVEY AND REPORT
- A2.1 EXISTING FLOOR PLANS
- A2.2 EXISTING ELEVATIONS
- A3.3 DEMOLITION FLOOR PLANS
- A3.4 DEMOLITION ELEVATIONS

- A3.0 PROPOSED SITE PLAN
- A3.1 PROPOSED FIRST FLOOR PLAN
- A3.2 PROPOSED SECOND FLOOR PLAN
- A3.3 PROPOSED ROOF PLAN

- A4.1 PROPOSED ELEVATIONS
- A4.2 PROPOSED ELEVATIONS
- A4.3 PROPOSED BUILDING SECTION

GLASS RESIDENCE
919 SOUTHARD STREET
KEY WEST, FLORIDA 33040

HARC SUBMISSION

COVER SHEET

ROBERT M. GURNEY, FAIA
ARCHITECT

5110 1/2 MacARTHUR BOULEVARD NW WASHINGTON DC 20016 L202.237.0925 L202.237.0927
www.robertgurneyarchitect.com

A1.1

SEPTEMBER 16, 2011

Boundary Survey Report of part of Lot 1, Square 46,
Island of Key West

NOTES:

1. The legal descriptions shown hereon were furnished by the client or their agent.
2. Underground foundations and utilities were not located.
3. All angles are 90° (Measured & Record) unless otherwise noted.
4. Street address: 919 Southard Street, Key West, FL.
5. This survey is not valid without the signature and the original raised seal of a Florida licensed surveyor and mapper.
6. Lands shown hereon were not abstracted for rights-of-way, easements, ownership, or other instruments of record.
7. North Arrow is assumed and based on the legal description.
8. This survey is not assignable.
9. Date of field work: April 19, 2010.
10. Ownership of fences is undeterminable, unless otherwise noted.
11. Adjoiners are not furnished.
12. The Survey Report is not full and complete without the attached Survey Map.

BOUNDARY SURVEY OF:

PARCEL #1: In the City of Key West and is Part of Lot 1, of Square 46 according to Whitehead's Map of Island of Key West delineated in February, 1829, more particularly described as follows: COMMENCING 125 feet from the corner of Grinnell and Southard Streets and running on the latter street in a Southwest direction 25 feet; thence at right angles in a Northwest direction 100 feet; thence in a Northeast direction 25 feet; thence at right angles in a Southeast direction 100 feet to the Point of Beginning.

PARCEL #1 - EXCEPTION: A parcel of land on the Island of Key West, Monroe County, Florida, and known as a Part of Lot 1, Square 46 according to William A. Whitehead's Map of the said Island, said parcel being further described by metes and bounds as follows: COMMENCE at the intersection of the SW'y right-of-way-line (ROWL) of Grinnell Street with the NW'y ROWL of Southard Street and run thence in a SW'y direction and along the NW'y ROWL of the said Southard Street for a distance of 125.00 feet to the POINT OF BEGINNING of the parcel of land being described herein; thence NW'y and at right angles for a distance of 100.00 feet; thence SW'y and at right angles for a distance of 1.75 feet; thence SE'y and at right angles for a distance of 100.00 feet to the NW'y ROWL of the said Southard Street; thence NE'y and along the NW'y ROWL of the said Southard Street for a distance of 1.75 feet back to the POINT OF BEGINNING.

PARCEL #2:

In the City of Key West and is Part of Lot 1, of Square 46 according to Whitehead's Map of Island of Key West delineated in February, 1829, more particularly described as follows: COMMENCING 150 feet from the corner of Grinnell and Southard Streets and running thence on said Southard Street in a Southwest direction 25 feet; thence at right angles in a Northwest direction 100 feet; thence at right angles in a Northeast direction 25 feet; thence at right angles in a Southeast direction 100 feet back to the Point of Beginning.

PARCEL #3:

A parcel of land on the Island of Key West, Monroe County, Florida, according to Whitehead's Map of said Island, delineated in February, 1829, and being more particularly described as follows: COMMENCE at the intersection of the SW'y right-of-way-line (ROWL) of Grinnell Street and the NW'y (ROWL) of Southard Street; thence run SW'y along the NW'y ROWL of said Southard Street, 175.00 feet to the POINT OF BEGINNING of said parcel of land; thence continue SW'y along the previously described course, 2.5 feet; thence run at right angles in a NW'y direction 100.00 feet; thence run at right angles in a NE'y direction 2.5 feet; thence run at right angles in a SE'y direction 100 feet back to the POINT OF BEGINNING.

BOUNDARY SURVEY FOR: Peter G. Glass & Sabrina U. Glass;
TIB Bank;
Feldman Koenig Highsmith & Van Loon, P.A.;
Old Republic National Title Insurance;

J. LYNN O'FLYNN, INC.

J. Lynn O'Flynn, PSM
Florida Reg. #6298

April 23, 2010

Sheet Two of Two Sheets

J. LYNN O'FLYNN, Inc.

Professional Surveyor & Mapper
PSM #6298

3430 Duck Ave., Key West, FL 33040
(305) 296-7422 FAX (305) 296-2244

Boundary Survey Map of part of Lot 1, Square 46,
Island of Key West

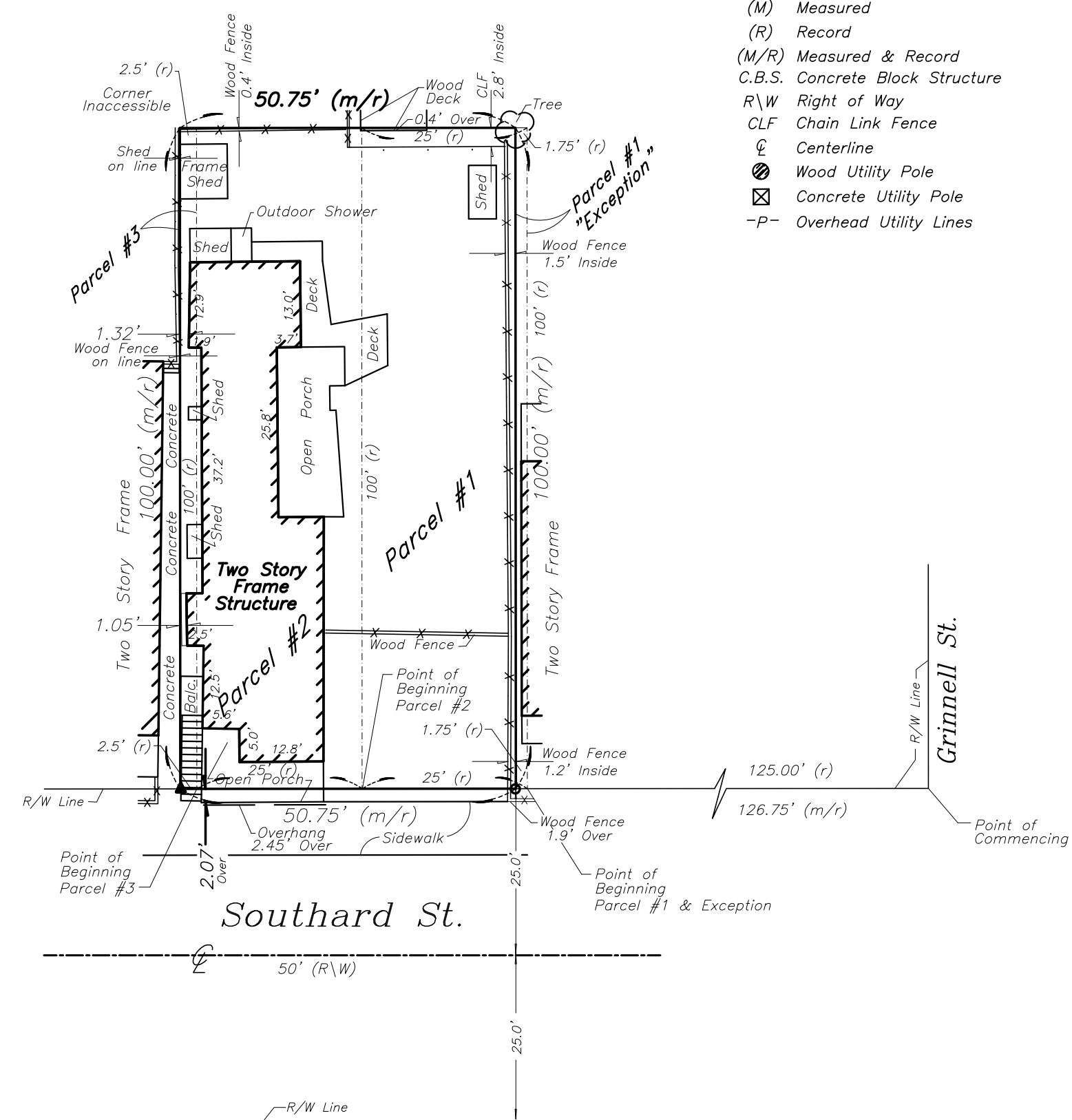
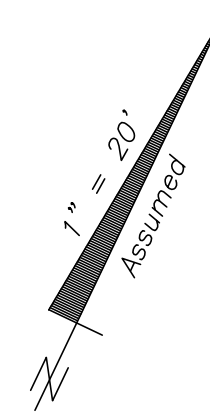

LEGEND

- Found 2" Iron Pipe (Fence Post)
- Set 3/4" Iron Pipe w/cap (6298)
- Found 1/2" Iron Rod (2863)
- ▲ Found Nail & Disc (5234)
- ▲ Set Nail & Disc (6298)
- (M) Measured
- (R) Record
- (M/R) Measured & Record
- C.B.S. Concrete Block Structure
- RLW Right of Way
- CLF Chain Link Fence
- ⊕ Centerline
- ⊕ Wood Utility Pole
- ⊕ Concrete Utility Pole
- P- Overhead Utility Lines

Sheet One of Two Sheets

J. LYNN O'FLYNN, Inc.

Professional Surveyor & Mapper
PSM #6298

3430 Duck Ave., Key West, FL 33040
(305) 296-7422 FAX (305) 296-2244

NOTE:
This Survey Map is not
full and complete without
the attached Survey Report.

2
A2.1 SCALE: 1/4" = 1'-0"

EXISTING SECOND FLOOR | ROOF PLAN

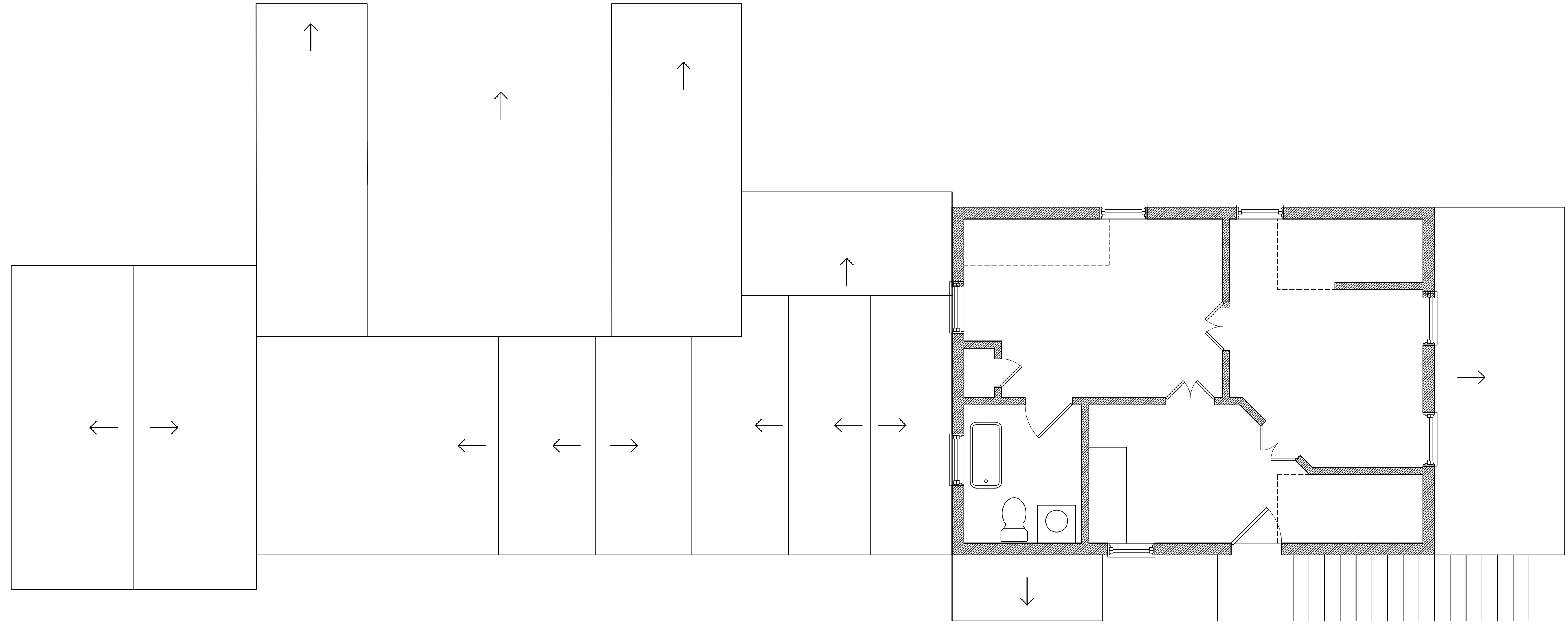

1
A2.1 SCALE: 1/4" = 1'-0"

EXISTING FIRST FLOOR PLAN

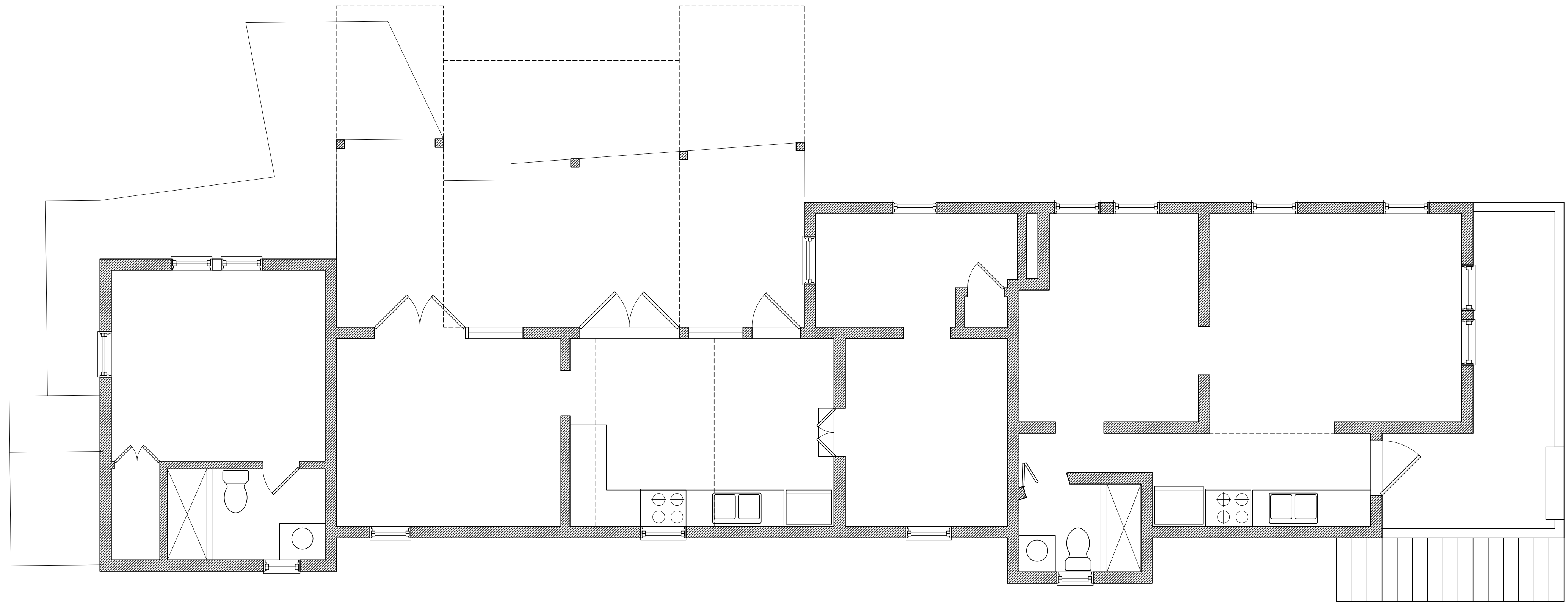

GLASS RESIDENCE
919 SOUTHARD STREET
KEY WEST, FLORIDA 33040

HARC SUBMISSION

EXISTING FLOOR PLANS

ROBERT M. GURNEY, FAIA
ARCHITECT

5110 1/2 MacARTHUR BOULEVARD NW WASHINGTON DC 20016 L202.237.0925 L202.237.0927
www.robertgurneyarchitect.com

A2.1

SEPTEMBER 16, 2011



3 EXISTING SOUTHEAST (FRONT) ELEVATION
A2.2 SCALE: 1/4" = 1'-0"

2 EXISTING NORTHEAST ELEVATION
A2.2 SCALE: 1/4" = 1'-0"



1 EXISTING SOUTHWEST ELEVATION
A2.2 SCALE: 1/4" = 1'-0"

2 DEMOLITION SECOND FLOOR | ROOF PLAN
A2.3 SCALE: 1/4" = 1'-0"

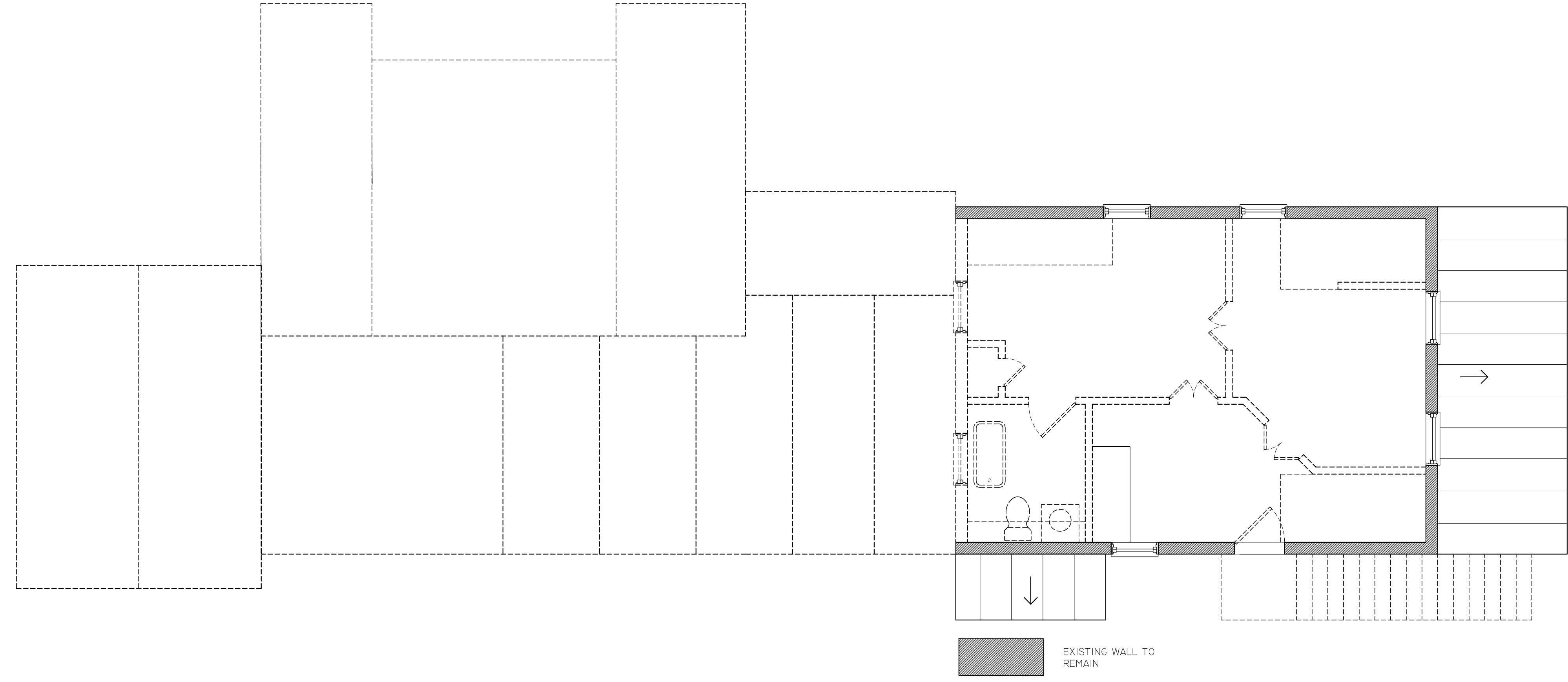

1 DEMOLITION FIRST FLOOR PLAN
A2.3 SCALE: 1/4" = 1'-0"

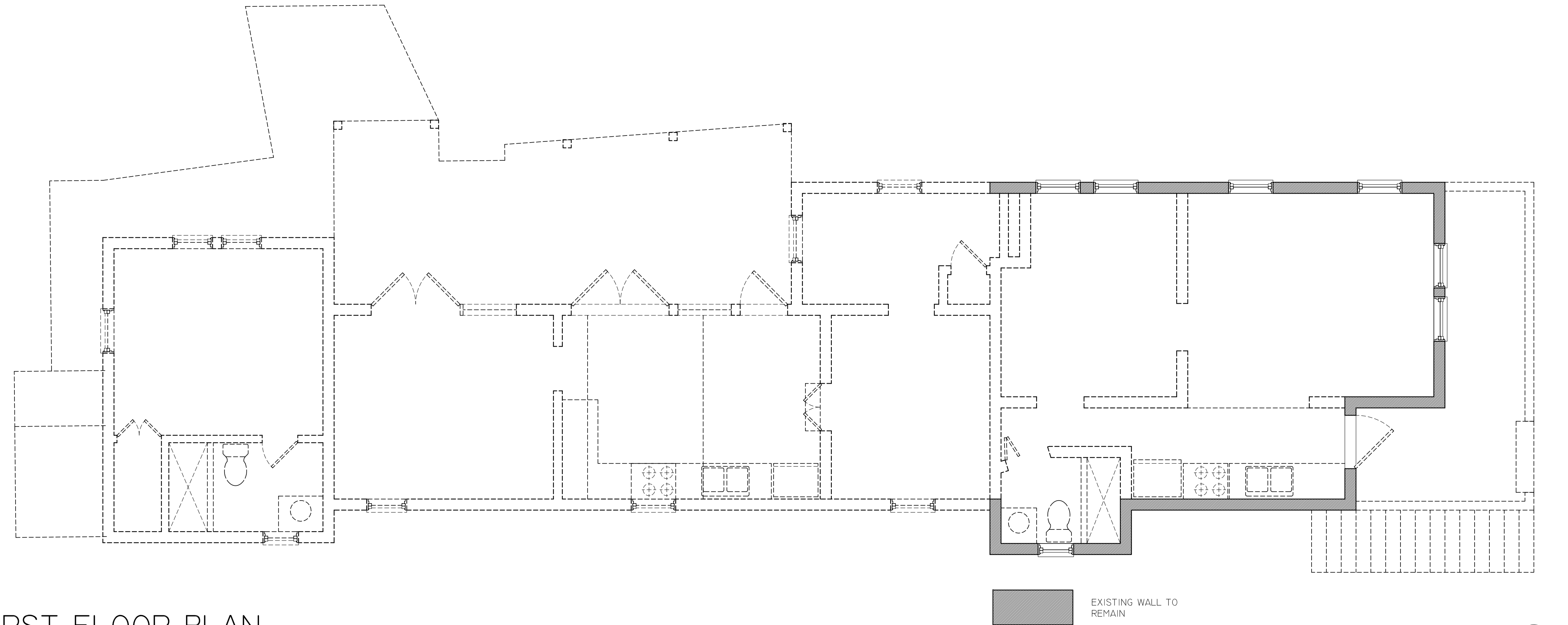

GLASS RESIDENCE
 919 SOUTHWARD STREET
 KEY WEST, FLORIDA 33040

HARC SUBMISSION

DEMOLITION FLOOR PLANS

ROBERT M. GURNEY, FAIA
 ARCHITECT

5110 1/2 MacARTHUR BOULEVARD NW WASHINGTON DC 20016 L202.237.0925 L202.237.0927
 www.robertgurneyarchitect.com

A2.3

SEPTEMBER 16, 2011



3 DEMOLITION SOUTHEAST ELEVATION
A2.4 SCALE: 1/4" = 1'-0"

2 DEMOLITION NORTHEAST ELEVATION
A2.4 SCALE: 1/4" = 1'-0"



1 DEMOLITION SOUTHWEST ELEVATION
A2.4 SCALE: 1/4" = 1'-0"

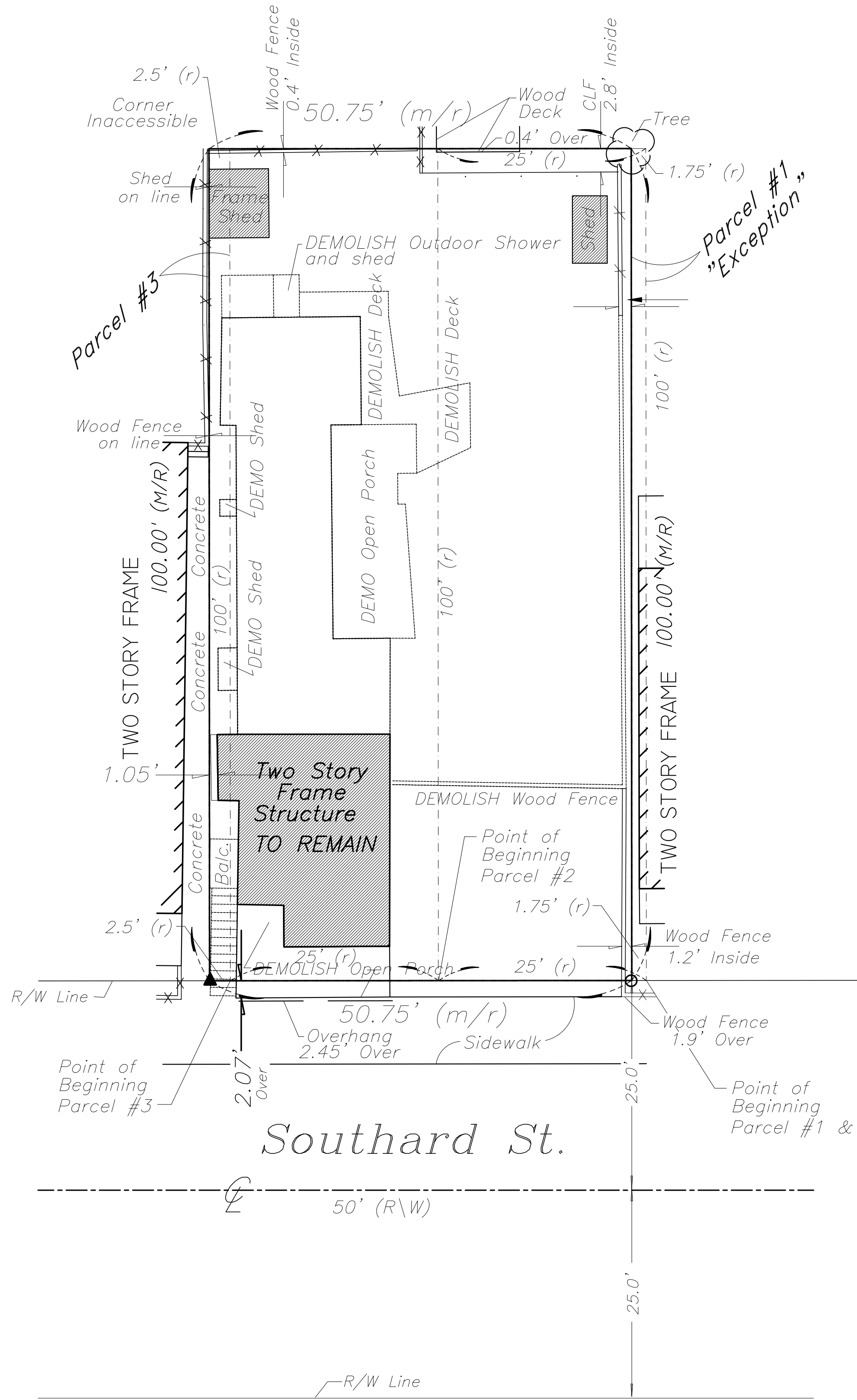

2 DEMOLITION SITE PLAN
A3.0 SCALE: 1"=10'

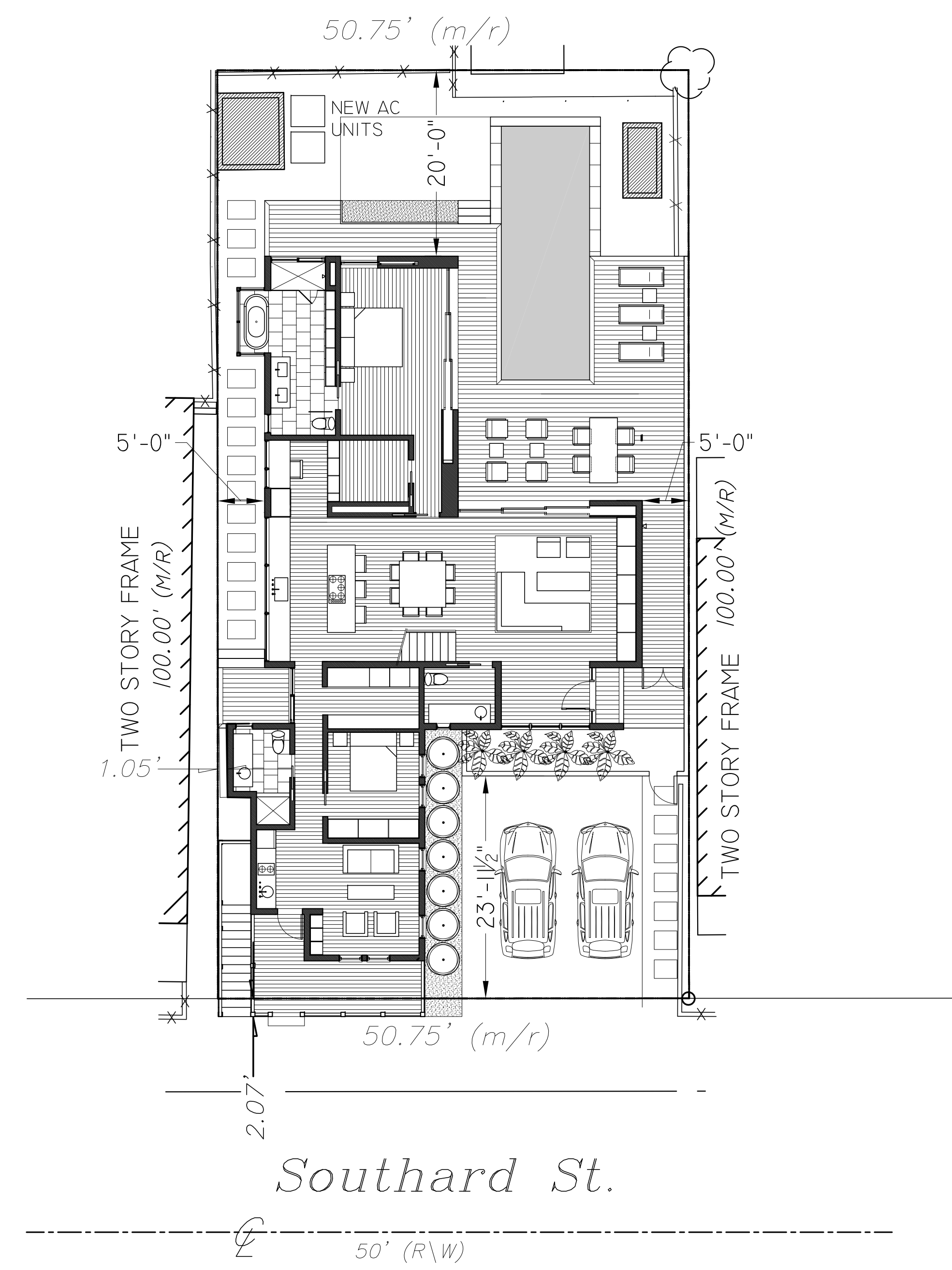

1 PROPOSED SITE PLAN
A3.0 SCALE: 1"=10'

GLASS RESIDENCE
919 SOUTHARD STREET
KEY WEST, FLORIDA 33040

HARC SUBMISSION

**DEMOLITION AND PROPOSED
SITE PLANS**

ROBERT M. GURNEY, FAIA
ARCHITECT

5110 MacARTHUR BOULEVARD NW WASHINGTON DC 20016 L202.237.0925 L202.237.0927
www.robertgurneyarchitect.com

A3.0

SEPTEMBER 16, 2011

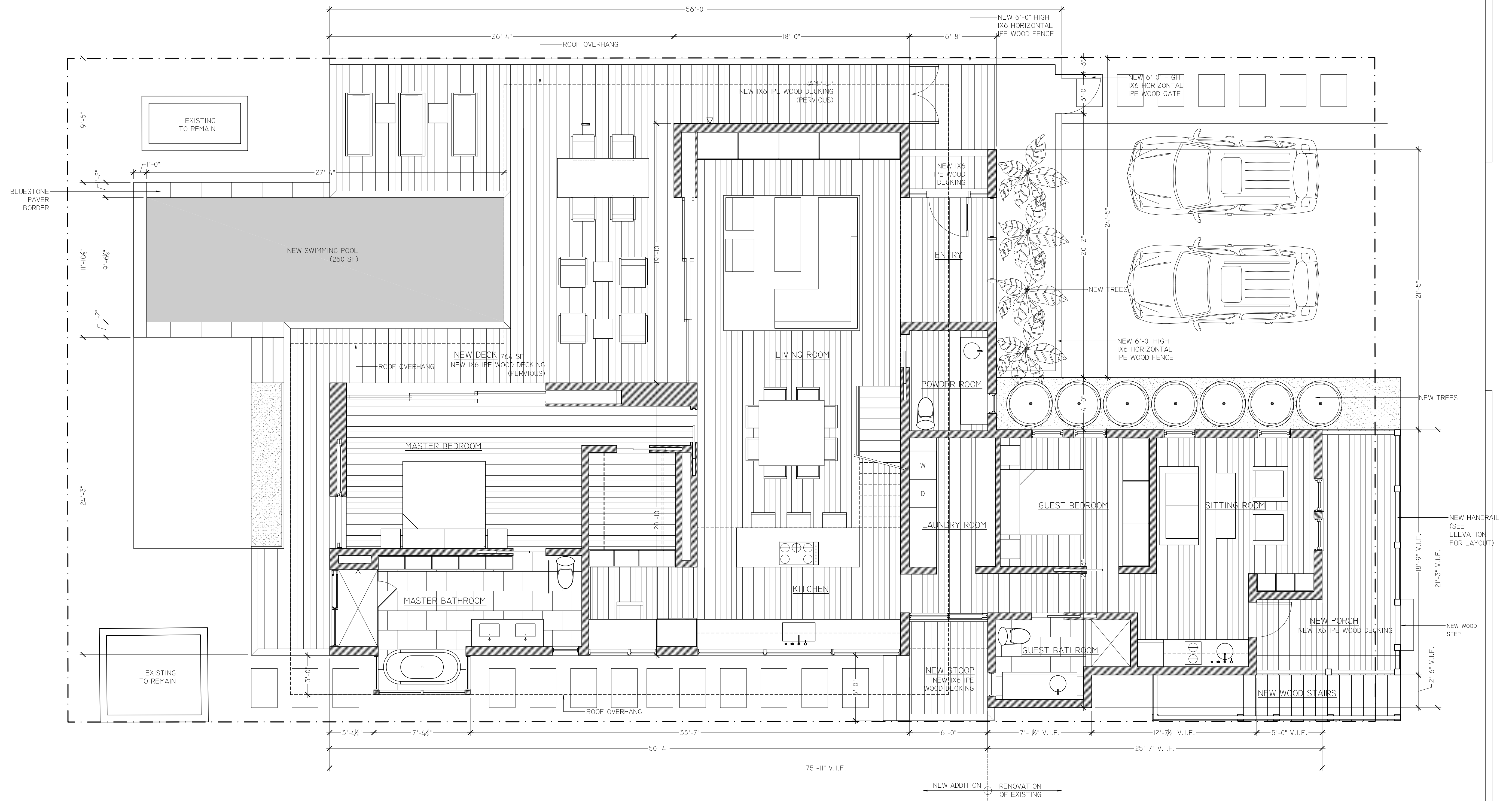

FIRST FLOOR PLAN
 SCALE: 1/4" = 1'-0"

GLASS RESIDENCE
 919 SOUTHDARD STREET
 KEY WEST, FLORIDA 33040

HARC SUBMISSION

FIRST FLOOR PLAN

ROBERT M. GURNEY, FAIA
 ARCHITECT

A3.1

5110 1/2 MacARTHUR BOULEVARD NW WASHINGTON DC 20016 L202.237.0925 L202.237.0927
 www.robertgurneyarchitect.com

SEPTEMBER 16, 2011

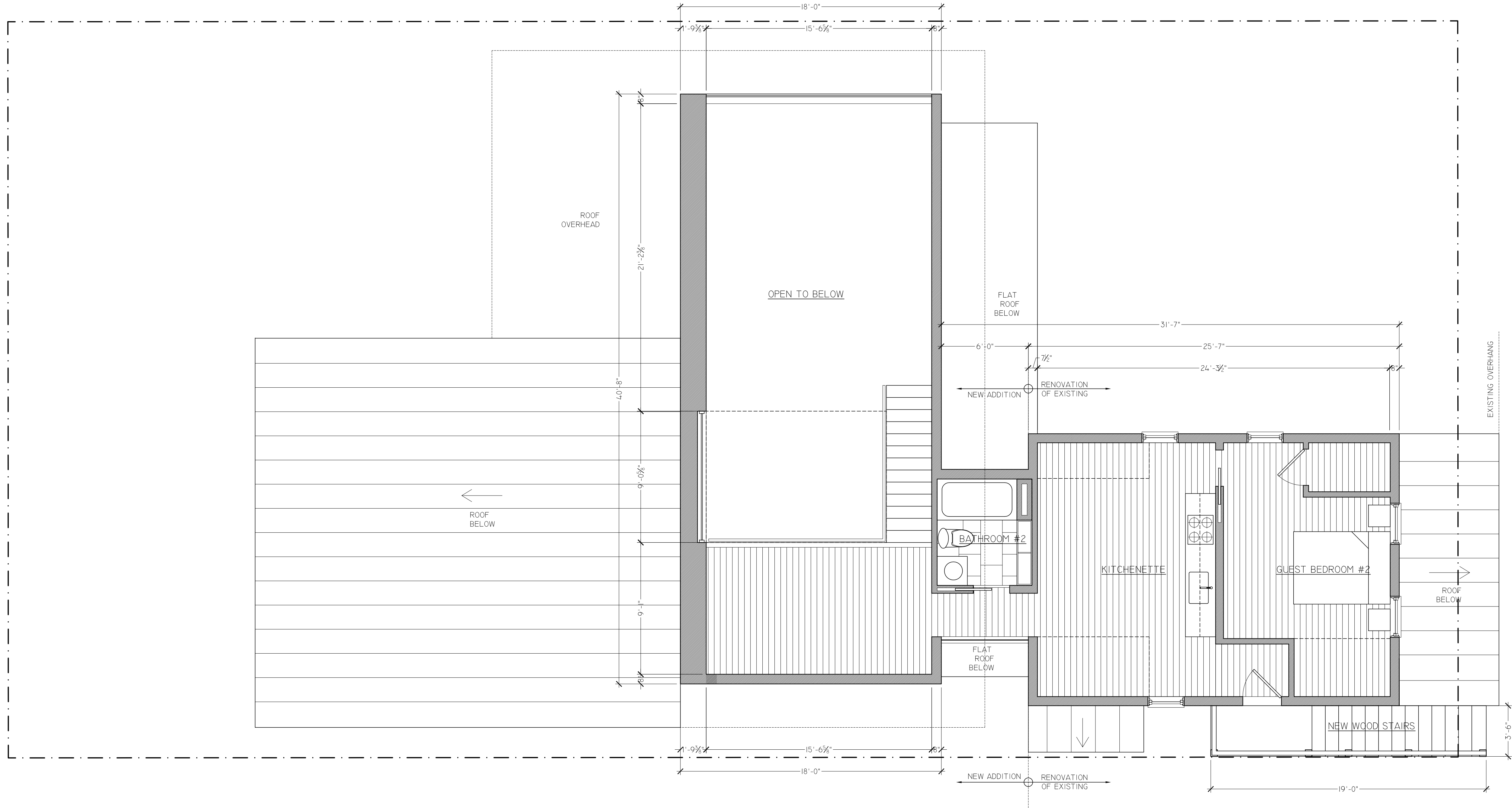

1 SECOND FLOOR PLAN
 A3.2 SCALE: 1/4" = 1'-0"

GLASS RESIDENCE
 919 SOUTHDARD STREET
 KEY WEST, FLORIDA 33040

HARC SUBMISSION

SECOND FLOOR PLAN

ROBERT M. GURNEY, FAIA
 ARCHITECT

5110 1/2 MacARTHUR BOULEVARD NW WASHINGTON DC 20016 L202.237.0925 L202.237.0927
 www.robertgurneyarchitect.com

A3.2

SEPTEMBER 16, 2011

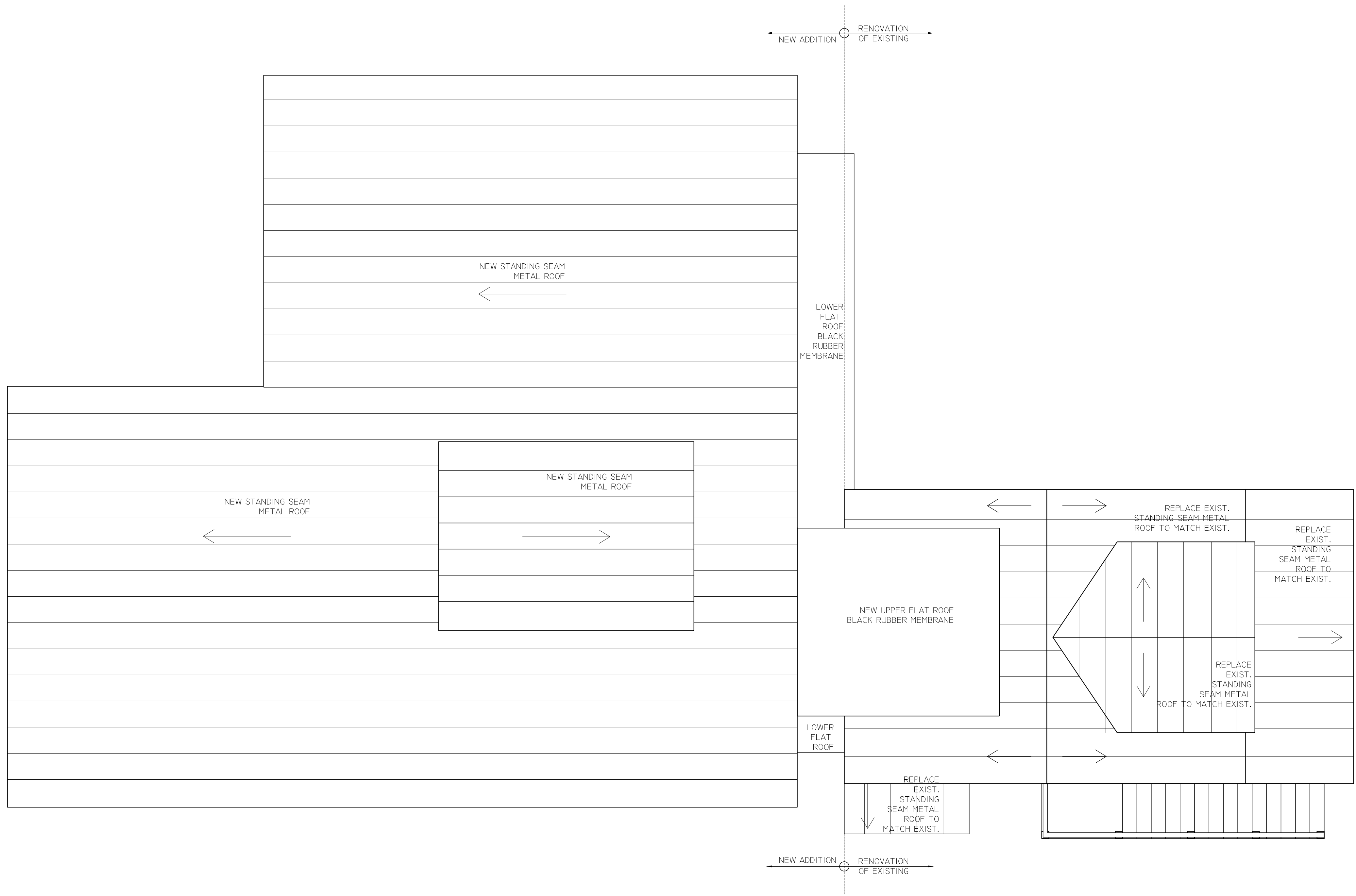

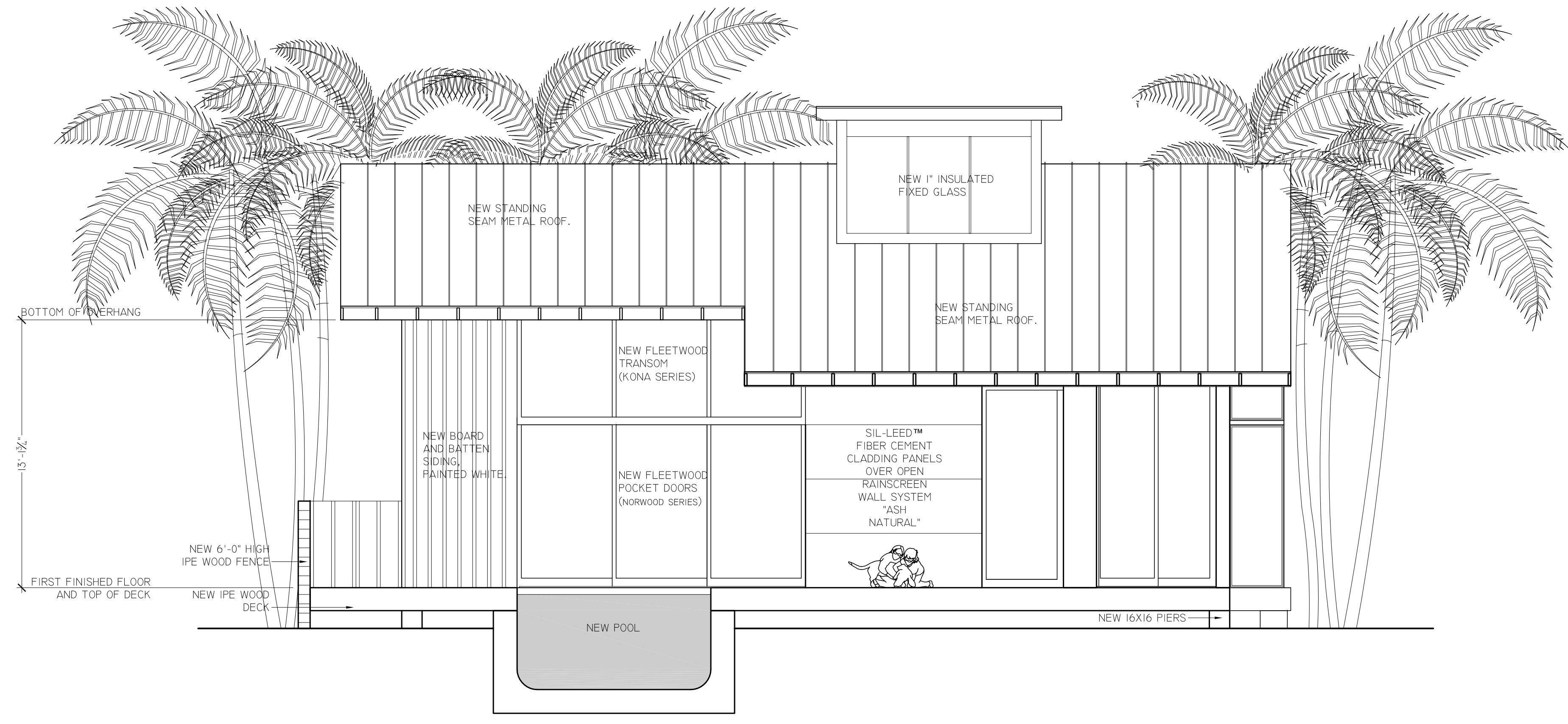

2 PROPOSED REAR ELEVATION
 A4.1 SCALE: 1/4" = 1'-0"



1 PROPOSED FRONT ELEVATION
 A4.1 SCALE: 1/4" = 1'-0"

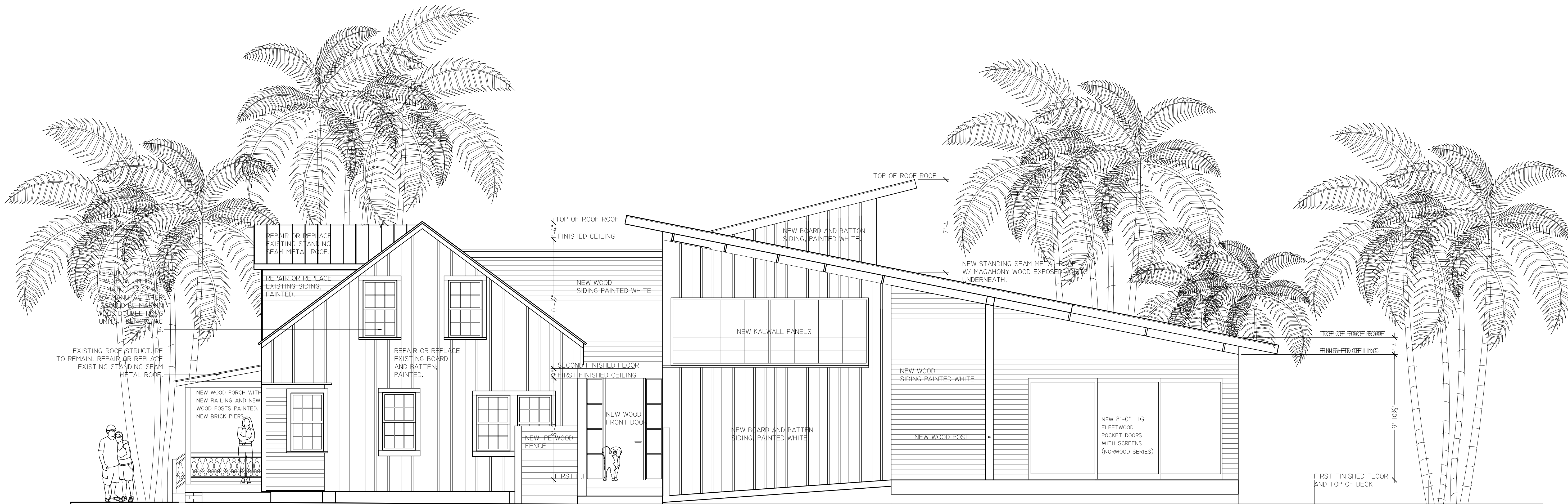

2 PROPOSED NORTHEAST ELEVATION
 A4.2 SCALE: 1/4" = 1'-0"

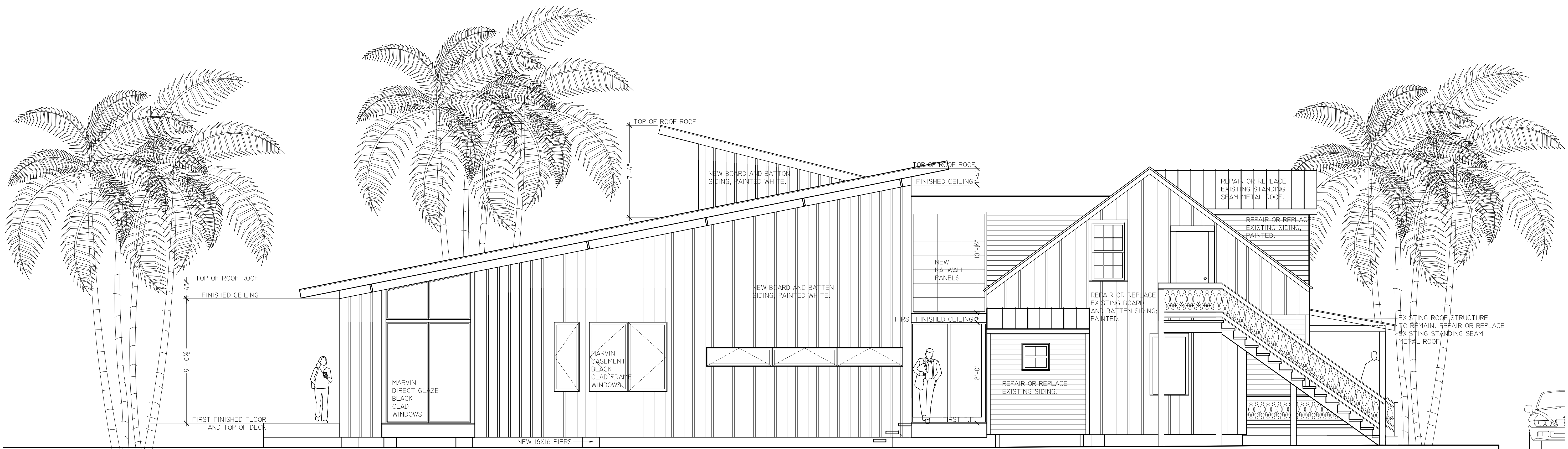

1 PROPOSED SOUTHWEST ELEVATION
 A4.2 SCALE: 1/4" = 1'-0"

ROBERT M. GURNEY, FAIA
 ARCHITECT

PROPOSED ELEVATIONS

HARC SUBMISSION

GLASS RESIDENCE
 919 SOUTHDARD STREET
 KEY WEST, FLORIDA 33040

A4.2

5110 MacARTHUR BOULEVARD NW WASHINGTON DC 20016 L202.237.0925 L202.237.0927
 www.robertgurneyarchitect.com

SEPTEMBER 16, 2011

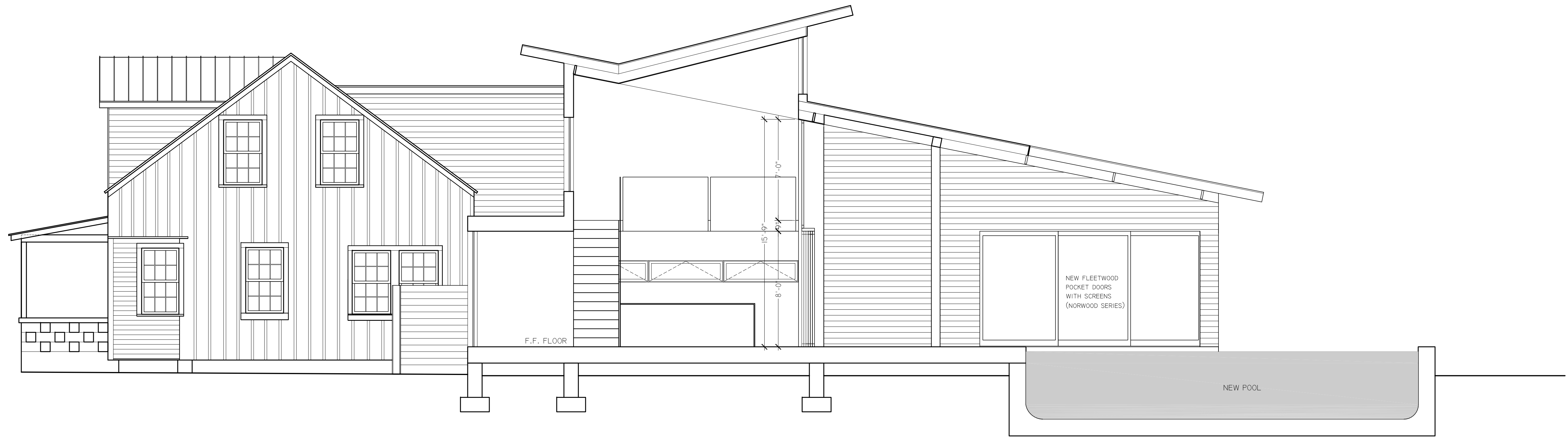

SECTION | ELEVATION
 SCALE: 1/4" = 1'-0"

GLASS RESIDENCE
 919 SOUTHDARD STREET
 KEY WEST, FLORIDA 33040

HARC SUBMISSION

SECTION | ELEVATION

ROBERT M. GURNEY, FAIA
 ARCHITECT

5110 1/2 MacARTHUR BOULEVARD NW WASHINGTON DC 20016 L202.237.0925 L202.237.0927
 www.robertgurneyarchitect.com

A4.3

SEPTEMBER 16, 2011

Architectural Collection - Combination

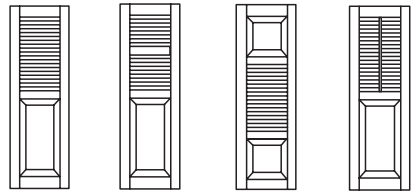

standard additional rails extra panel vertical mullion

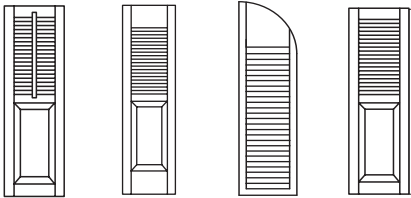

faux tilt rod custom top or bottom rail solid panel arch top rabbeted edge

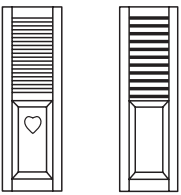

cutout bahama louver spacing

Rails: Structural PVC with smooth outer skin.
Panels: Structural PVC with smooth outer skin.
Louvers: Pultruded Structural Fiberglass
Stiles: Pultruded Structural Fiberglass
Paint Finish: Two-part Urethane
Thickness: 1 1/4"

Width: 12"-36" (in 1/8" increments)
 Rail widths, if specified, may vary slightly due to louver/slat positioning. Vertical mullion or faux tilt rod required at every 30".
Height: 24"-120" (in 1/8" increments)
Vertical Stile: 2 1/4"
Top Rail: 3"
Middle Rail: 3"
Bottom Rail: 4"

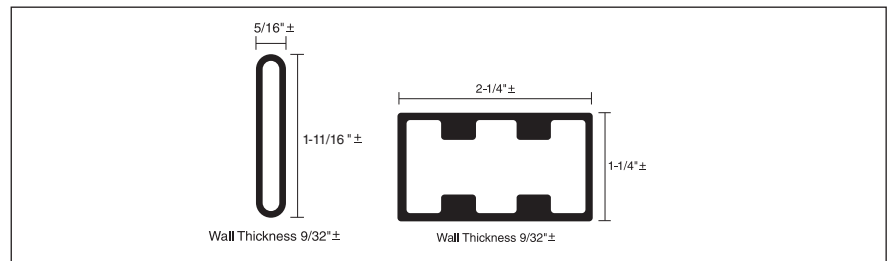

Architectural Collection - Bahama

less than 30"

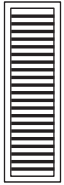

30" to less than 60"

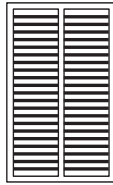

60" to less than 90"

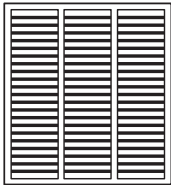

90" to less than 120"

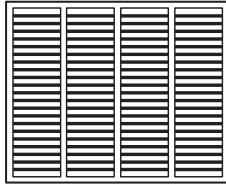

Rails: Pultruded Structural Fiberglass
Slats: Pultruded Structural Fiberglass
Stiles: Pultruded Structural Fiberglass
Paint Finish: Two-part Urethane
Width: 12"-119" (in 1/8" increments)
Thickness: 1 1/4"
Height: 18 1/2"-119" (in 1-1/2" increments)
Maximum Shutter Size: 120" w x 96" h or 96" w x 120" h
Vertical Stile: 2 1/4"
Top Rail: 2 1/4"
Middle Rail: 2 1/4"
Bottom Rail: 2 1/4"

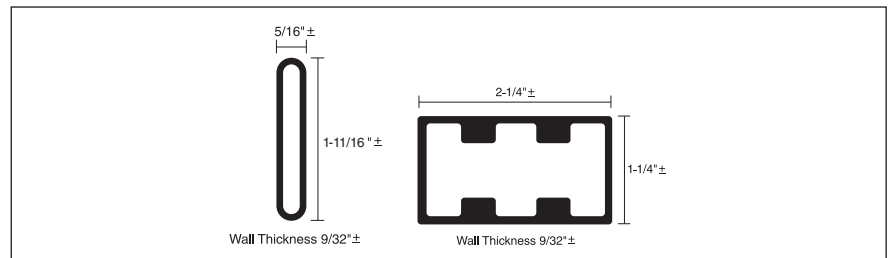

Widths from 30" – 59.875" require 1 vertical mullion which is automatically added.

Widths from 60" – 89.875" require 2 vertical mullions which are automatically added.

Widths from 90" – 119.875" require 3 vertical mullions which are automatically added.

Additional vertical mullions, rails and colonial louver spacing available upon request.

Classic Collection - Board and Batten

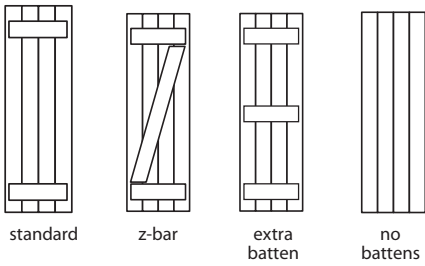

standard

z-bar

extra
batten

no
battens



arch or
radius
top

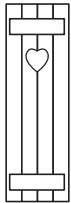

cutout

Rails: Proprietary Exterior Grade Composite Wood
Panels: Proprietary Exterior Grade Composite Wood
Stiles: Proprietary Exterior Grade Composite Wood
Primer: Marine Grade
Paint Finish: Two-part Urethane
Thickness: 1 1/2"
Width: 9"-30" (in 1/8" increments)
Height: 13 1/2"-96" (in 1/8" increments)
Batten Height: 4"
Batten Width: Panel width - less 1 1/2"
Board Width: Grooves are cut approximately every 4"

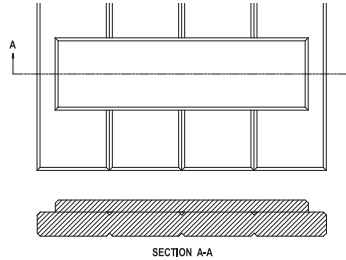

ProSeries

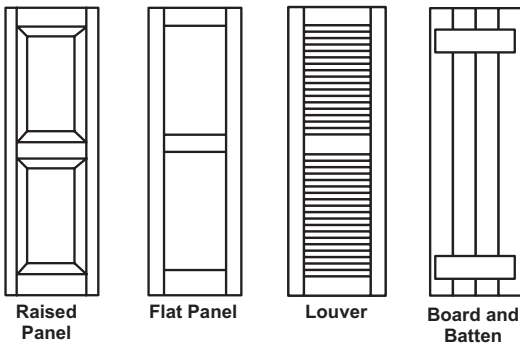

Raised
Panel

Flat Panel

Louver

Board and
Batten

ProSeries shutters are available in four different styles

- Louver, Raised Panel, Flat Panel, Board and Batten.
- Quarter Round Arch Tops are available on Raised Panel, Flat Panel, Louver, and Board and Batten Shutters.

ProSeries shutters are available in the following sizes.

- Widths 12" to 24" in half inch increments.
- Heights 30" to 96" in half inch increments.

ProSeries shutters are primed only and should receive a finish coat of paint.

- Any good quality exterior grade finish paint should be used.
- Each shutter should be scuffed with a fine 600 grit sand paper prior to application of the finish paint coat.

Hardware for ProSeries Shutters is provided separately.

ProSeries shutters are backed by a 3 year structural warranty.

Colors

Colors are representative only and vary from the actual product. For accurate color selection please see a paint color chart.



Black 632



Pewter 646



Cascade 647



Rookwood Med. Brown 658



Tricone Black 670



Roycraft Mist Gray 664



Canyon 648



Walnut 641



Charleston Green 653



Chelsea Gray 662



Redwood 636



Craftsman Brown 659



Rookwood Shutter Green 654



Plum Creek 643



Roycraft Copper Red 668



Hammered Silver 661



Roycraft Bottle Green 655



Midnight Sky 639



Board & Batten Red 650



Sand 642



Evergreen 638



Deep Sea Blue 637



Wineberry 634



Driftwood 649



Rookwood Dark Green 656



Tempest Blue 666



Garnet 669



Weathered Shingle 660



Forest Green 633



Stratford Blue 665



Bordeaux 640



Wicker 672



Pine 644



Hamilton Blue 667



Federal Brown 635

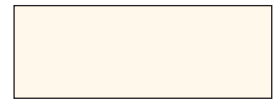

Classical White 671



Roycraft Pewter 663



Harbor 645



Polished Mahogany 657



White 631

Report No: 02-042

21 December 2002

Test Dates: 23 & 24 October, 1 & 2 November 2002

SUMMARY OF TESTING : LOUVERED BAHAMA SHUTTERS

Client:

Atlantic Shutter Systems

3239 HWY 301 NORTH
LATTA, SC 29565

Phone: 877-437-0608 Fax: 843-752-0111

ATLANTIC SHUTTER SYSTEMS : LOUVERED BAHAMA SHUTTER

Tested for ASTM E 330 & ASTM E 1886 Per ASTM E 1996

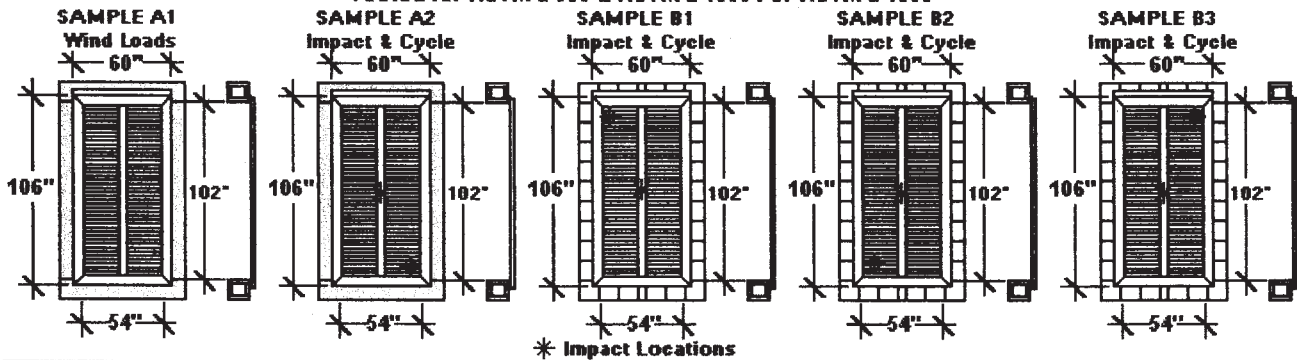

WIND LOADS : Specimen A1 was wind loaded in accordance with ASTM E 330-97. Positive wind loading verified a Design Load of 60.0 PSF and was discontinued to preserve the specimen for negative wind loads. Negative wind loading verified a Design Load of -60.0 PSF, loading was continued until the specimen's anchorages failed (DL +/- 62.4 PSF, proven but not taken advantage of during the required cyclic wind load testing).

IMPACTS : Specimen A2, B1, B2 & B3 were impacted in accordance with ASTM E 1886-97 per specification ASTM E 1996-02 at Missile Level D. None failed as a result of impacts.

CYCLIC WIND LOADS : Specimen A2, B1, B2 & B3 were subjected to cyclic wind loads in accordance with ASTM E 1886-97 per specification ASTM E 1996-02, Table 1. All specimen successfully completed the cyclic wind loads to verified a Design Load of +/- 60 PSF.

CONCLUSION: Following testing all specimen were disassembled. No failures were observed in the shutters, the fastenings or anchorages, except as noted in specimen deliberately tested to failure, descriptions of these follow the relevant data. The shutter product here in and in the accompanying drawings complies with Standard Specification for Performance of... Storm Shutters Impacted by Windborne Debris in Hurricanes for a Design Load of +/- 60 PSF at Missile Level D.

Respectfully submitted,

CONSTRUCTION TESTING CORPORATION
(Miami-Dade Certification # 91-0212.01)
(SBCCI Certification # TL-9741)

Report by George Dotzler:

Test witnessed & report reviewed
By Yamil G. Kuri, P.E.:

DEC 26 2002
Reports pertain to the samples tested only and
may not be reproduced without permission.

Miscellaneous Information

B a h a m a

Atlantic's Bahama shutters bring refreshingly clean, versatile design. Inspired by the elegant functionality of shutters found throughout the Caribbean, Bahama shutters block out intense UV rays that can damage interiors, while allowing soft ambient light and refreshing breezes to pass through. Their airy, relaxed design offers a sophisticated privacy solution. Bahama shutters can be paired with various shutter styles to deliver a dramatic look. These shutters are a longtime favorite in coastal and tropical locales.

Our Bahama Shutters are hand-assembled with historically correct mitered corners from marine fiberglass components. Built without any unsightly mechanical fasteners, they are designed to withstand fierce weather like the unrelenting sea-spray of coastal climates.



standard



additional rails



additional vertical mullion

Architect



ctural

Hurricane Storm-rated Shutters

With Atlantic Premium Shutters, you don't have to sacrifice design appeal, even in the heart of hurricane zones. When the wind whips fiercely, the rain hardens and debris becomes airborne, Atlantic's Hurricane Storm-rated shutters protect your coastal home. All while providing the same unmatched beauty for which all Atlantic shutters are known.

Our Inside Locking U-Shaped Storm Bar System features two U-shaped storm bars that lock from the interior when the shutters are closed. Each shutter leaf has a 1/8" thick clear polycarbonate panel fastened to its back, helping protect the shutter leaf, the window and your home's interior. The system meets the Large Missile Impact Test requirement as specified in the IRC and IBC 2006.

The system is available for Architectural and Classic Collection shutters in Louver, Raised Panel or Board and Batten styles (does not apply to arch and radius top shutters, cutouts, or combination styles).

When your shutters are in the open position, the polycarbonate backing remains hidden from view, so your home evokes a scenic, seamless charm. Only you will know how extremely tough your beautiful Atlantic shutters really are.

The Bahama Storm System offers the same high level of home protection, but with our unique Bahama style Architectural Collection Shutters that offer sleek, versatile aesthetics.

A 1/8" thick clear polycarbonate panel is permanently attached to the back of the shutter. A camelback locking system specifically designed for the Bahama style is installed along the sides of the shutter.

With the Bahama Storm System, you gain privacy, ambient light, fresh air, and home-protecting toughness independently tested to a design pressure of 60 PSF.

The Bahama Storm System meets the Large Missile Impact Test requirement as specified in the IRC and IBC 2006. This system also meets the State of Florida Building Code 2007.



Architectural Collection, Bahama and Raised Panel



Bahama Storm System
Locks from the outside.



"U" Locking Storm Bar System
Locks from the inside.



Horizontal Storm Bar System
Locks from outside.

Board and **B**atten

With bold dimension and solid, colorful character, Board and Batten shutters distinguish homes with Old-World charm and a flourish of rustic style. These shutters offer a classic aesthetic for a variety of homes. Board and Batten shutters are a favorite choice for picturesque forest and lake homes. Popular options include Z-bars, extra battens and arch or radius tops. To ensure historical accuracy vertical grooves are approximately every 4 inches.



standard



z-bar



extra batten



no battens



arch or radius top

Classic



*The choice for versatility, custom color,
and outstanding charm*

Atlantic's new ProSeries Shutters are hand-assembled from exterior-grade composite wood components that will not rot, bend, crack or split. These shutters are factory-primed only and ready to receive any bold color with a high-quality exterior paint of your choice.

Design details complete the front and back of each shutter, with four handsome styles available: Louver, Raised Panel, Flat Panel and Board and Batten. Corners and joints are true and square with tongue and groove construction that provides superior strength. Our specially-formulated adhesive allows clean construction with no unsightly fasteners.

Each ProSeries shutter is machine-sanded and finished with a single coat of marine-grade primer, significantly reducing your time in applying a finish coat of paint. Shutters need only be scuffed with fine 600 grit sandpaper prior to receiving the finish paint coat.

Versatile ProSeries shutters can be specified to correct window scale or sized as desired. Widths are available from 12" to 24" in half-inch increments; heights from 30" to 96" in half-inch increments. Quarter Round Arch Tops are also available. ProSeries shutters may be installed in fixed or operable applications. ProSeries Shutters are backed by a 3-year structural warranty.

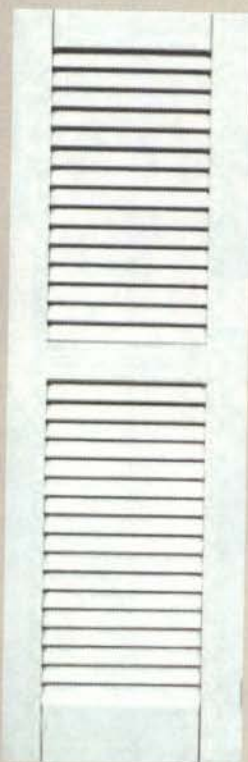

louver

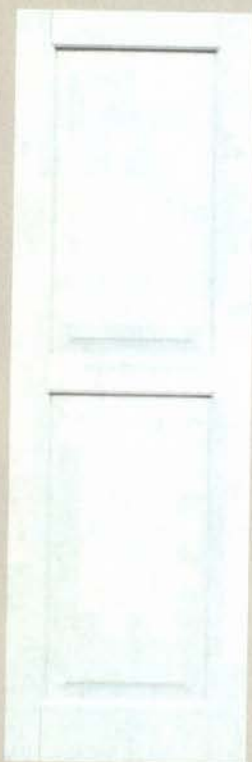

raised panel

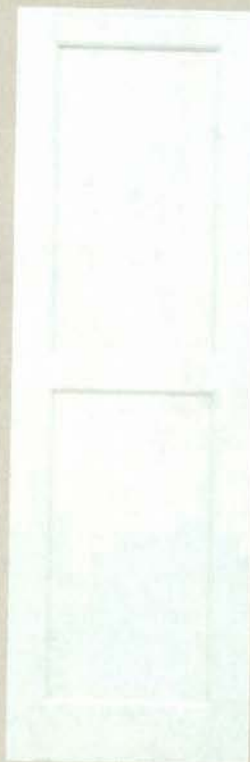

flat panel

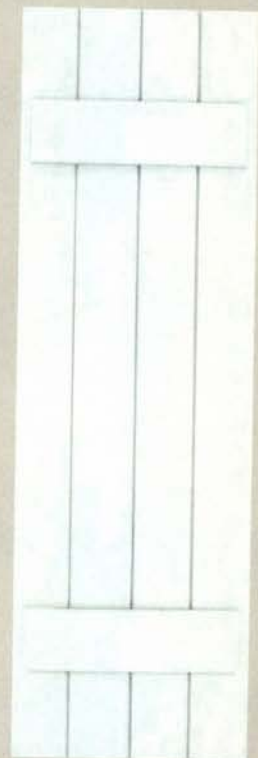

board and batten

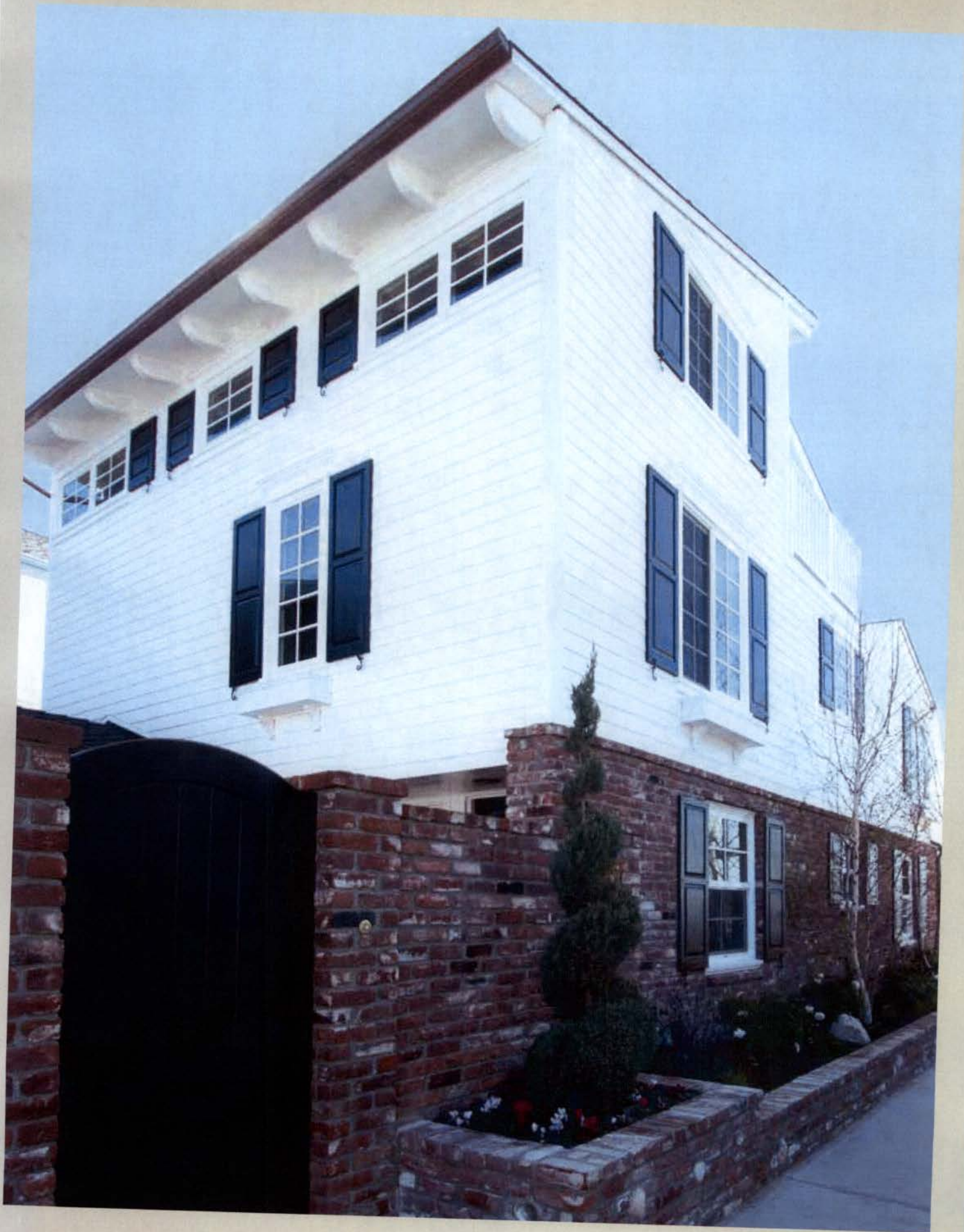

Architectural Collection - Combination

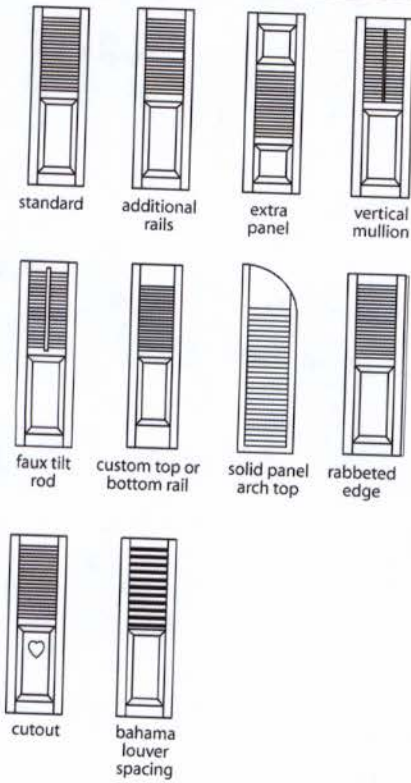

Rails: Structural PVC with smooth outer skin.
Panels: Structural PVC with smooth outer skin.
Louvers: Pultruded Structural Fiberglass
Stiles: Pultruded Structural Fiberglass
Paint Finish: Two-part Urethane

Thickness: 1 1/4"

Width: 12"-36" (in 1/8" increments)

Rail widths, if specified, may vary slightly due to louver/slat positioning. Vertical mullion or faux tilt rod required at every 30".

Height: 24"-120" (in 1/8" increments)

Vertical Stile: 2 1/4"

Top Rail: 3"

Middle Rail: 3"

Bottom Rail: 4"

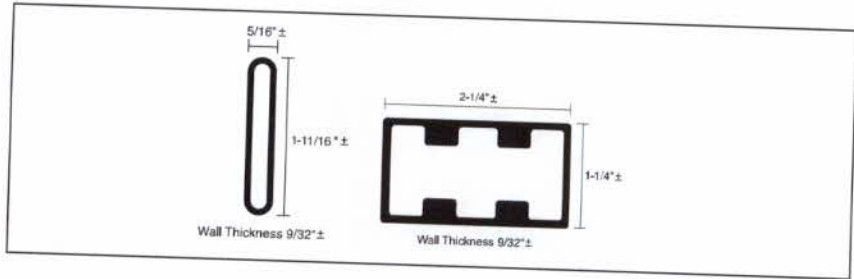

Architectural Collection - Bahama

→ *Awning Type shutters*

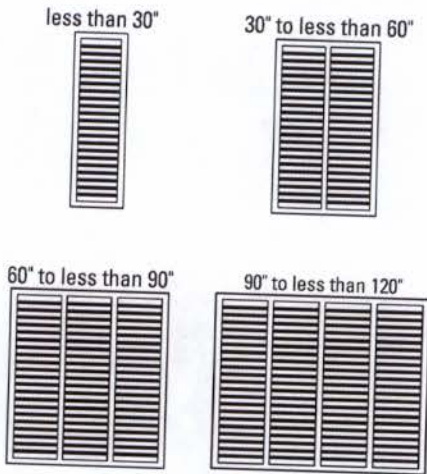

Rails: Pultruded Structural Fiberglass

Slats: Pultruded Structural Fiberglass

Stiles: Pultruded Structural Fiberglass

Paint Finish: Two-part Urethane

Width: 12"-119" (in 1/8" increments)

Thickness: 1 1/4"

Height: 18 1/2"-119" (in 1-1/2" increments)

Maximum Shutter Size: 120" w x 96" h or 96" w x 120" h

Vertical Stile: 2 1/4"

Top Rail: 2 1/4"

Middle Rail: 2 1/4"

Bottom Rail: 2 1/4"

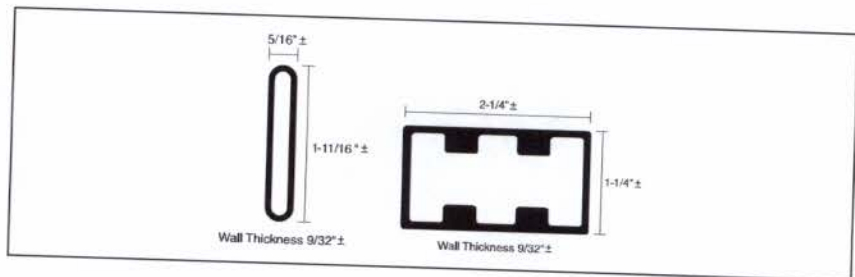

Widths from 30" - 59.875" require 1 vertical mullion which is automatically added.

Widths from 60" - 89.875" require 2 vertical mullions which are automatically added.

Widths from 90" - 119.875" require 3 vertical mullions which are automatically added.

Additional vertical mullions, rails and colonial louver spacing available upon request.

Report No: 02-042

21 December 2002

Test Dates: 23& 24 October, 1 & 2 November 2002

SUMMARY OF TESTING : LOUVERED BAHAMA SHUTTERS

Client:

Atlantic Shutter Systems

3239 HWY 301 NORTH
LATTA, SC 29565

Phone: 877-437-0608 Fax: 843-752-0111

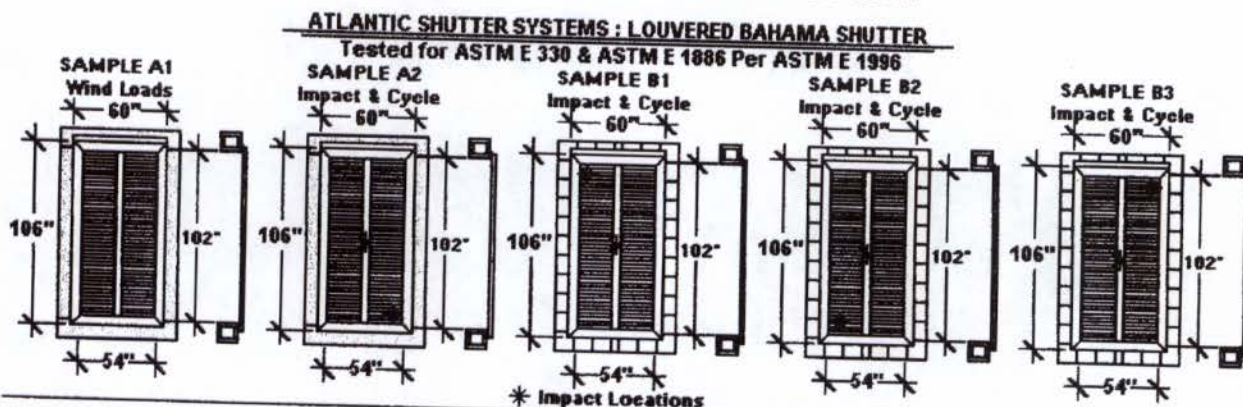

WIND LOADS : Specimen A1 was wind loaded in accordance with ASTM E 330-97. Positive wind loading verified a Design Load of 60.0 PSF and was discontinued to preserve the specimen for negative wind loads. Negative wind loading verified a Design Load of -60.0 PSF, loading was continued until the specimen's anchorages failed (DL +/- 62.4 PSF, proven but not taken advantage of during the required cyclic wind load testing).

IMPACTS : Specimen A2, B1, B2 & B3 were impacted in accordance with ASTM E 1886-97 per specification ASTM E 1996-02 at Missile Level D. None failed as a result of impacts.

CYCLIC WIND LOADS : Specimen A2, B1, B2 & B3 were subjected to cyclic wind loads in accordance with ASTM E 1886-97 per specification ASTM E 1996-02, Table 1. All specimen successfully completed the cyclic wind loads to verified a Design Load of +/- 60 PSF.

CONCLUSION: Following testing all specimen were disassembled. No failures were observed in the shutters, the fastenings or anchorages, except as noted in specimen deliberately tested to failure, descriptions of these follow the relevant data. The shutter product here in and in the accompanying drawings complies with Standard Specification for Performance of... Storm Shutters Impacted by Windborne Debris in Hurricanes for a Design Load of +/- 60 PSF at Missile Level D.

Respectfully submitted,

CONSTRUCTION TESTING CORPORATION
(Miami-Dade Certification # 01-0212.01)
(SBCCI Certification # TL-9741)

Report by George Dotzler:

Test witnessed & report reviewed

By Yamil G. Kuri, P.E. :

DEC 26 2002

Reports pertain to the samples tested only and
may not be reproduced without permission.

02-042 : 21 December 2002 : Page 7 of 7

Classic Collection - Board and Batten

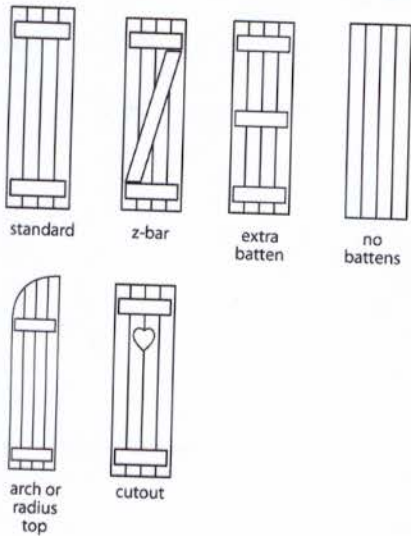

Rails: Proprietary Exterior Grade Composite Wood
Panels: Proprietary Exterior Grade Composite Wood
Stiles: Proprietary Exterior Grade Composite Wood
Primer: Marine Grade
Paint Finish: Two-part Urethane
Thickness: 1 1/2"
Width: 9"-30" (in 1/8" increments)
Height: 13 1/2"-96" (in 1/8" increments)
Batten Height: 4"
Batten Width: Panel width - less 1 1/2"
Board Width: Grooves are cut approximately every 4"

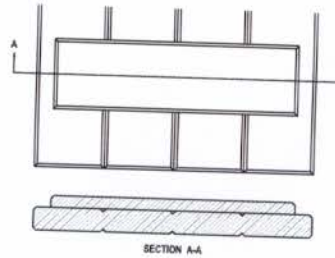

ProSeries

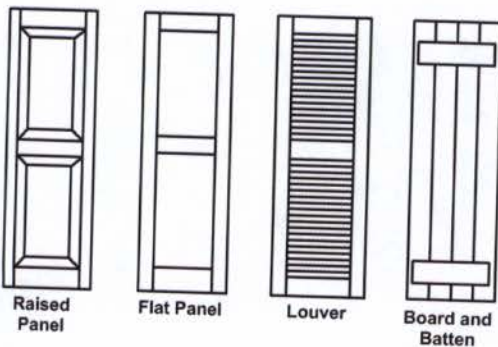

ProSeries shutters are available in four different styles

- Louver, Raised Panel, Flat Panel, Board and Batten.
- Quarter Round Arch Tops are available on Raised Panel, Flat Panel, Louver, and Board and Batten Shutters.

ProSeries shutters are available in the following sizes.

- Widths 12" to 24" in half inch increments.
- Heights 30" to 96" in half inch increments.

ProSeries shutters are primed only and should receive a finish coat of paint.

- Any good quality exterior grade finish paint should be used.
- Each shutter should be scuffed with a fine 600 grit sand paper prior to application of the finish paint coat.

Hardware for ProSeries Shutters is provided separately.

ProSeries shutters are backed by a 3 year structural warranty.

Colors

Colors are representative only and vary from the actual product. For accurate color selection please see a paint color chart.



Black 632



Pewter 646



Cascade 647



Rookwood Med. Brown 658



Tricone Black 670



Roycraft Mist Gray 664



Canyon 648



Walnut 641



Charleston Green 653



Chelsea Gray 662



Redwood 636



Craftsman Brown 659



Rookwood Shutter Green 654



Plum Creek 643



Roycraft Copper Red 668



Hammered Silver 661



Roycraft Bottle Green 655



Midnight Sky 639



Board & Batten Red 650



Sand 642



Evergreen 638



Deep Sea Blue 637



Wineberry 634



Driftwood 649



Rookwood Dark Green 656



Tempest Blue 666



Garnet 669



Weathered Shingle 660



Forest Green 633



Stratford Blue 665



Bordeaux 640



Wicker 672



Pine 644



Hamilton Blue 667



Federal Brown 635



Classical White 671



Roycraft Pewter 663



Harbor 645



Polished Mahogany 657

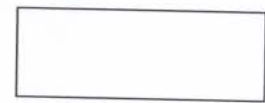

White 631

Noticing

Public Meeting Notice

The Historic Architectural Review Commission will hold a public hearing at 3:00 p.m., September 27, 2011 at Old City Hall, 510 Greene Street, Key West, Florida. The purpose of the hearing will be to consider a request for:

**PARTIAL DEMOLITION ON THE BACK AND FRONT PORCH
#919 SOUTHARD STREET**

Applicant: Robert M. Gurney- Application # H11-01-1243

If you wish to see the application or have any questions, you may visit the Planning Department during regular office hours at 3140 Flagler Avenue call 809-3973 or visit our website at www.keywestcity.com .

Property Appraiser Information

Karl D. Borglum
Property Appraiser
Monroe County, Florida

office (305) 292-3420
fax (305) 292-3501
Website tested on
Internet Explorer

GIS Mapping requires Adobe Flash 10.3 or higher.
(An Export Map widget is in the lower left corner.)

Property Record View

Alternate Key: 1008010 Parcel ID: 00007730-000000

Ownership Details

Mailing Address:
GLASS PETER S AND SABRINA U
919 SOUTHARD ST
KEY WEST, FL 33040-7175

Property Details

PC Code: 08 - MULTI FAMILY LESS THAN 10UNITS
Millage Group: 10KW
Affordable Housing: No
Section-Township-Range: 06-68-25
Property: 919 SOUTHARD ST KEY WEST
Location: 921 SOUTHARD ST KEY WEST
Legal Description: KW PT LT 1 SQR 46 G47-18/20/21/23/24/25/26 OR153310/11 OR552-599/601 G11-318 G46-140/41 OR571-1570/79AFFD OR1680-1766/68 OR1838-603/05 OR2272-2265ORD OR2358-1627ORD OR2461-206/10 OR2472-1533/34

Parcel Map (Click to open dynamic parcel map)

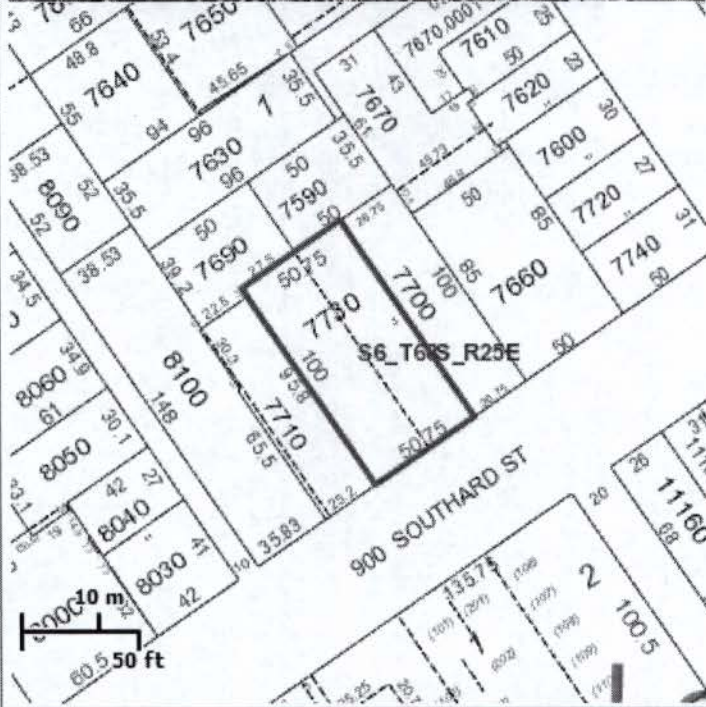

Land Details

Land Use Code	Frontage	Depth	Land Area
010D - RESIDENTIAL DRY	51	100	5,075.00 SF

Building Summary

Number of Buildings: 1
 Number of Commercial Buildings: 0

Total Living Area: 1637
Year Built: 1929

Building 1 Details

Building Type R3
Effective Age 18
Year Built 1929
Functional Obs 0

Condition A
Perimeter 294
Special Arch 0
Economic Obs 0

Quality Grade 550
Depreciation % 25
Grnd Floor Area 1,637

Inclusions: R3 includes 3 3-fixture baths and 3 kitchens.

Roof Type GABLE/HIP
Heat 1 NONE
Heat Src 1 NONE

Roof Cover METAL
Heat 2 NONE
Heat Src 2 NONE

Foundation WD CONC PADS
Bedrooms 4

Extra Features:

2 Fix Bath 0
3 Fix Bath 0
4 Fix Bath 0
5 Fix Bath 0
6 Fix Bath 0
7 Fix Bath 0
Extra Fix 0

Vacuum 0
Garbage Disposal 0
Compactor 0
Security 0
Intercom 0
Fireplaces 0
Dishwasher 0

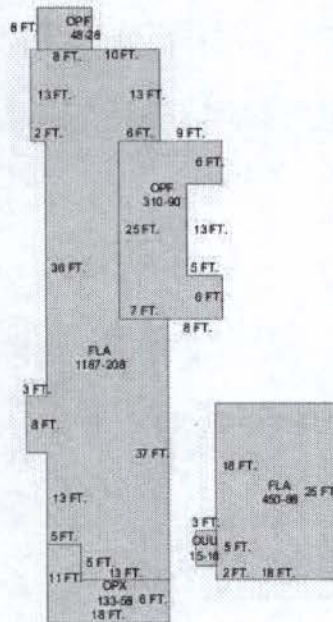

Sections:

Nbr	Type	Ext Wall	# Stories	Year Built	Attic	A/C	Basement %	Finished Basement %	Area
1	OPX		1	1991	N	N	0.00	0.00	133
2	FLA	2:B & B	1	1991	N	N	0.00	0.00	1,187
3	OPF		1	1991	N	N	0.00	0.00	310
4	OPF		1	1991	N	N	0.00	0.00	48
5	FLA	2:B & B	1	1991	N	N	0.00	0.00	450
6	OOU		1	1991	N	N	0.00	0.00	15

Misc Improvement Details

Nbr	Type	# Units	Length	Width	Year Built	Roll Year	Grade	Life
1	WD2:WOOD DECK	65 SF	0	0	1984	1985	1	40
2	FN2:FENCES	168 SF	0	0	1984	1985	2	30
3	AC2:WALL AIR COND	1 UT	0	0	1987	1988	2	20
4	FN2:FENCES	180 SF	6	30	1996	1997	2	30

Appraiser Notes

2003-05-05 - ASKING \$625,000 AS OF 050202 3 UNITS W/2 ELECTRIC METERS

Building Permits

Bldg	Number	Date Issued	Date Completed	Amount	Description	Notes
	B942634	08/01/1994	12/01/1994	2,700		HURRICANE PANELS
	A951477	05/01/1995	09/01/1995	5,875		5 SQS V CRIMP ROOFING
1	9801140	05/13/1998	01/01/1999	700	Residential	REPLACE PICKET FENCE
1	9801791	05/26/1999	08/13/1999	750	Residential	INTERIOR REPAIRS
	03-0935	03/18/2003	09/25/2003	1,150		REPLACE SEWER LINE
	03-1360	04/22/2003	09/25/2003	1,500		ELE. PANEL

Parcel Value History

Certified Roll Values.

[View Taxes for this Parcel.](#)

Roll Year	Total Bldg Value	Total Misc Improvement Value	Total Land Value	Total Just (Market) Value	Total Assessed Value	School Exempt Value	School Taxable Value
2011	184,639	945	196,951	382,535	382,535	0	382,535
2010	206,796	970	140,054	347,820	347,820	0	347,820
2009	232,658	989	385,736	619,383	619,383	0	619,383
2008	213,967	1,021	507,500	722,488	722,488	0	722,488
2007	243,591	1,054	837,375	1,082,020	1,082,020	0	1,082,020
2006	435,867	1,087	482,125	919,079	919,079	0	919,079
2005	435,867	1,114	380,625	817,606	817,606	0	817,606

2004	247,838	1,153	355,250	604,241	604,241	0	604,241
2003	337,154	1,180	177,625	515,959	515,959	0	515,959
2002	271,714	1,231	177,625	450,570	450,570	0	450,570
2001	156,654	1,287	177,625	335,566	335,566	0	335,566
2000	165,722	1,433	96,425	263,580	263,580	0	263,580
1999	134,116	1,456	96,425	231,997	213,704	25,000	188,704
1998	117,780	897	96,425	215,103	201,732	25,000	176,732
1997	108,231	884	86,275	195,390	187,884	25,000	162,884
1996	81,855	751	86,275	168,880	168,880	25,000	143,880
1995	78,823	771	86,275	165,869	165,869	25,000	140,869
1994	66,696	693	86,275	153,664	153,664	0	153,664
1993	66,696	730	86,275	153,702	153,702	0	153,702
1992	81,370	773	82,025	164,169	164,169	0	164,169
1991	94,494	0	85,850	180,344	180,344	0	180,344
1990	65,856	0	82,063	147,919	147,919	0	147,919
1989	58,400	0	80,800	139,200	139,200	0	139,200
1988	45,830	0	65,650	111,480	111,480	0	111,480
1987	45,381	0	37,706	83,087	83,087	0	83,087
1986	45,615	0	36,330	81,945	81,945	0	81,945
1985	44,534	0	20,350	64,884	64,884	0	64,884
1984	41,457	0	20,350	61,807	61,807	25,000	36,807
1983	41,457	0	20,350	61,807	61,807	25,000	36,807
1982	42,341	0	20,350	62,691	62,691	25,000	37,691

Parcel Sales History

NOTE: Sales do not generally show up in our computer system until about two to three months after the date of sale. If a recent sale does not show up in this list, please allow more time for the sale record to be processed. Thank you for your patience and understanding.

Sale Date	Official Records Book/Page	Price	Instrument	Qualification
5/18/2010	2472 / 1533	560,000	WD	02
3/10/2010	2461 / 206	100	WD	11
11/25/2002	1838 / 0603	600,000	WD	Q
7/1/1993	1267 / 1593	154,500	WD	Q
2/1/1976	684 / 843	39,500	00	Q

This page has been visited 117,416 times.

Monroe County Property Appraiser
 Karl D. Borglum
 P.O. Box 1176
 Key West, FL 33041-1176