



---

## Staff Report for Item 12a

**To:** Chairman Michael Miller and Historic Architectural Review Commission Members

**From:** Enid Torregrosa-Silva MSHP  
Historic Preservation Planner

**Meeting Date:** January 27, 2015

**Applicant:** Meridian Engineering/ Richard Milelli, Engineer

**Application Number:** H15-01-0006

**Address:** #1321 South Street

---

### Description of Work

New two story buildings.

### Site Facts

The principal one story structure in the site was built in 1943. The duplex building is not listed in the surveys. On July 24, 2007 the Historic Architectural Review Commission approved proposed plans to build "*Two new 2 story residences in the Conch Style*". No second reading for demolition was ever done and no building permits were never obtained for the proposed plans; therefore the 2007 approved plans expired. The majority of the houses in the urban block and surrounding structures are on story. The footprint of the building had change from its original configuration. The house is located on the boundary of the historic district; buildings located on the south of the street are not within the historic district.

### Guidelines Cited in Review

- Additions/ Alterations and New Construction (pages 36-38a), specifically guidelines for new construction, mass, scale, proportions.
- Fences (pages 41-42), specifically guideline 3.

## **Staff Analysis**

The Certificate of Appropriateness in review proposes the replacement of a one story duplex with two story frame structures. The new design is based on traditional forms and textures found in the historic district. Both houses will be twin structures and will raise 28'-6" from the crown of the road. The structures will be built over concrete piers, and roofs will be front gabled. Exterior materials include hardiboard siding, 6 over 6 impact resistant metal windows, impact resistant metal doors on the rear elevations, wood columns, wood railings wood front doors and metal v-crimp as the roofing system.

The proposed site plan includes new 4 feet wood picket fence along the front property line as well as a paved driveway for one car on each unit.

The structure was first plotted on the 1948 Sanborn maps. The urban block extending Seminary, South, Tropical and Leon Streets was developed with one story duplex units across the block. All the buildings were originally build as frame structures. Staff was not able to find photos of the property in the Monroe County Library.

## **Consistency with Guidelines**

1. Although the proposed structures are wider than many surrounding houses in the area they will exceed the height established by the majority of the buildings. The proposed design fails to comply with the guideline for height for new construction.
2. The proposed proportions and massing of the houses are not in keeping with the majority of surrounding structures. The width and height of both structures in relationship to their site and surroundings is not similar to proportions of buildings and sites found within the urban context.
3. The proposed building materials and textures are compatible with the historic character of the district.

It is staff's opinion that the design proposes two buildings that will exceed the established height in the area. Although the site is located in the boundaries of the historic district massing, height and proportions are still elements that need to be considered for any new proposed construction. Staff has expressed these concerns to the applicant. It is staff's opinion that the new proposed plan is not appropriate to the site due to the design's mass, scale, height and proportions.

# APPLICATION

# COMBINATION APPLICATION: FLOODPLAIN, CONSTRUCTION AND HARC

\$50.00 APPLICATION FEE NON-REFUNDABLE



## City of Key West

3140 FLAGLER AVENUE  
KEY WEST, FLORIDA 33040

Phone: 305.809.3956

www.keywestcity.com

HARC PERMIT NUMBER <b>15-01-06</b>		BUILDING PERMIT NUMBER <b>15-14</b>		INITIAL & DATE <b>1/2 W</b>
FLOODPLAIN PERMIT				REVISION #
FLOOD ZONE	PANEL #	ELEV. L. FL.	SUBSTANTIAL IMPROVEMENT ___ YES ___ NO ___ %	

ADDRESS OF PROPOSED PROJECT:

**1321 South Street**

# OF UNITS

**2**

RE # OR ALTERNATE KEY:

**00028690-000000**

NAME ON DEED:

**1321 LLC**

PHONE NUMBER

OWNER'S MAILING ADDRESS:

**1010 Kennedy Drive Ste 406  
Key West Florida**

EMAIL

CONTRACTOR COMPANY NAME:

PHONE NUMBER

CONTRACTOR'S CONTACT PERSON:

EMAIL

ARCHITECT / ENGINEER'S NAME:

**Mendian Engineering / Rick Milelli**

PHONE NUMBER

**305-293-3263**

ARCHITECT / ENGINEER'S ADDRESS:

**201 Front St. Ste 203  
Key West FL**

EMAIL

**rmilelli@mendianengineeringflkeys.com**

HARC: PROJECT INVOLVES A CONTRIBUTING HISTORIC STRUCTURE: \_\_\_ YES  NO (SEE PART C FOR HARC APPLICATION.)

CONTRACT PRICE FOR PROJECT OR ESTIMATED TOTAL FOR MAT'L., LABOR & PROFIT:

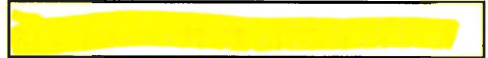

FLORIDA STATUTE 837.06: WHOEVER KNOWINGLY MAKES A FALSE STATEMENT IN WRITING AND WITH THE INTENT TO MISLEAD A PUBLIC SERVANT IN THE PERFORMANCE OF HIS OR HER OFFICIAL DUTY SHALL BE GUILTY OF A MISDEMEANOR OF THE SECOND DEGREE PUNISHABLE PER SECTION 775.082 OR 775.083.

PROJECT TYPE:  ONE OR TWO FAMILY \_\_\_ MULTI-FAMILY \_\_\_ COMMERCIAL  NEW \_\_\_ REMODEL  
 \_\_\_ CHANGE OF USE / OCCUPANCY \_\_\_ ADDITION \_\_\_ SIGNAGE \_\_\_ WITHIN FLOOD ZONE \_\_\_  
 DEMOLITION \_\_\_ SITE WORK \_\_\_ INTERIOR \_\_\_ EXTERIOR \_\_\_ AFTER-THE-FACT

DETAILED PROJECT DESCRIPTION INCLUDING QUANTITIES, SQUARE FOOTAGE ETC.,

**Demolish existing duplex. Construct two new single family residences and fencing**

I'VE OBTAINED ALL NECESSARY APPROVALS FROM ASSOCIATIONS, GOV'T AGENCIES AND OTHER PARTIES AS APPLICABLE TO COMPLETE THE DESCRIBED PROJECT:	
OWNER PRINT NAME: <b>Rick Milelli</b>	QUALIFIER PRINT NAME:
OWNER SIGNATURE: <b>APPLICANT</b>	QUALIFIER SIGNATURE:
Notary Signature as to owner:	Notary Signature as to qualifier:
STATE OF FLORIDA; COUNTY OF MONROE SWORN TO AND SCRIBED BEFORE ME THIS <b>2</b> DAY OF <b>Jan</b> 20 <b>15</b>	STATE OF FLORIDA; COUNTY OF MONROE SWORN TO AND SCRIBED BEFORE ME THIS ___ DAY OF ___ 20__
	Date: <b>KEYWFLD</b> Type: <b>OC</b> Drawer: <b>1</b> Date: <b>1/08/15 53</b> Receipt no: <b>10079</b> 2015 1000006 * BUILDING PERMITS NEW Trans number: <b>3035367</b> VM VISA/MASTERC <b>\$250.00</b> Trans date: <b>1/07/15</b> Time: <b>16:55:45</b>
Personally known or produced _____ as identification.	Personally known or produced _____ as identification.

**PART B: SUPPLEMENTARY PROJECT DETAILS TO AVOID DELAYS / CALL-BACKS**

PROPERTY STRUCTURES AFFECTED BY PROJECT:  MAIN STRUCTURE  ACCESSORY STRUCTURE

ACCESSORY STRUCTURES:  GARAGE / CARPORT  DECK  FENCE  OUTBUILDING / SHED

FENCE STRUCTURES:  4 FT.  6 FT. SOLID  6 FT. / TOP 2 FT. 50% OPEN

POOLS:  INGROUND  ABOVE GROUND  SPA / HOT TUB  PRIVATE  PUBLIC  
 PUBLIC POOLS REQUIRE BD. OF HEALTH LICENSE APPLICATION AT TIME OF CITY APPLICATION.  
 PUBLIC POOLS REQUIRE BD. OF HEALTH LICENSE PRIOR TO RECEIVING THE CITY CERTIFICATE OF OCCUPANCY.

ROOFING:  NEW  ROOF-OVER  TEAR-OFF  REPAIR  AWNING  
 5 V METAL  ASPLT. SHGLS.  METAL SHGLS.  BLT. UP  TPO  OTHER

FLORIDA ACCESSIBILITY CODE:  20% OF PROJECT FUNDS INVESTED IN ACCESSIBILITY FEATURES.

SIGNAGE:  # OF SINGLE FACE  # OF DOUBLE FACE  REPLACE SKIN ONLY  BOULEVARD ZONE  
 POLE  WALL  PROJECTING  AWNING  HANGING  WINDOW

SQ. FT. OF EACH SIGN FACE:

**SUBCONTRACTORS / SPECIALTY CONTRACTORS SUPPLEMENTARY INFORMATION:**

MECHANICAL:  DUCTWORK  COMMERCIAL EXH. HOOD  INTAKE / EXH. FANS  LPG TANKS  
 A / C:  COMPLETE SYSTEM  AIR HANDLER  CONDENSER  MINI-SPLIT

ELECTRICAL:  LIGHTING  RECEPTACLES  HOOK-UP EQUIPMENT  LOW VOLTAGE  
 SERVICE:  OVERHEAD  UNDERGROUND  1 PHASE  3 PHASE  AMPS

PLUMBING:  ONE SEWER LATERAL PER BLDG.  INGROUND GREASE INTCPTRS.  LPG TANKS

RESTROOMS:  MEN'S  WOMEN'S  UNISEX  ACCESSIBLE

**PART C: HARC APPLICATION FOR A CERTIFICATE OF APPROPRIATENESS**

PLEASE ATTACH APPROPRIATE VARIANCES / RESOLUTIONS FROM HARC, PLANNING OR CITY COMMISSIONERS; ALSO INCLUDE 2 SETS OF SCALED PLANS; PHOTOS OF EXISTING AND ADJACENT BLDGS.; ILLUSTRATIONS OF PROPOSED PRODUCTS, ETC...

INDICATE TYPE OF CERT. OF APPROPRIATENESS:  GENERAL  DEMOLITION  SIGN  OTHER:

GENERAL: DESCRIPTION FROM PART B: \_\_\_\_\_

PROJECT SPECIFICATIONS		
ARCHITECTURAL FEATURES TO BE ALTERED:	ORIGINAL MATERIAL:	PROPOSED MATERIAL:
Demolition	CBS	Wood frame

DEMOLITION:  ATTACHED IS HARC APPENDIX FOR PROPOSED DEMOLITION

DEMOLITION OF HISTORIC STRUCTURES IS NOT ENCOURAGED BY THE HISTORIC ARCHITECTURAL REVIEW COMMISSION.

SIGNAGE: (SEE PART B)  BUSINESS SIGN  BRAND SIGN  OTHER: \_\_\_\_\_

BUSINESS LICENSE # \_\_\_\_\_ IF FAÇADE MOUNTED, SQ. FT. OF FAÇADE \_\_\_\_\_

**SIGN SPECIFICATIONS**

SIGN COPY:	PROPOSED MATERIALS:	SIGNS WITH ILLUMINATION:
		TYPE OF LTG.:
		LTG. LINEAL FTG.:
MAX. HGT. OF FONTS:		COLOR AND TOTAL LUMENS:
IF USING LIGHT FIXTURES PLEASE INDICATE HOW MANY:                      INCLUDE SPEC. SHEET WITH LOCATIONS AND COLORS.		

OFFICIAL USE ONLY:		HARC STAFF OR COMMISSION REVIEW	
___ APPROVED    ___ NOT APPROVED    ___ DEFERRED FOR FUTURE CONSIDERATION    ___ TABLED FOR ADD'L. INFO.			
HARC MEETING DATE:	HARC MEETING DATE:	HARC MEETING DATE:	
REASONS OR CONDITIONS:			
STAFF REVIEW COMMENTS:			
HARC PLANNER SIGNATURE AND DATE:		HARC CHAIRPERSON SIGNATURE AND DATE:	

**PART D:                      STATE OF FLORIDA OFFICIAL NOTIFICATIONS AND WARNINGS**

FLORIDA STATUTE 713.135: WARNING TO OWNER: YOUR FAILURE TO RECORD A 'NOTICE OF COMMENCEMENT' MAY RESULT IN YOUR PAYING TWICE FOR IMPROVEMENTS TO YOUR PROPERTY. A NOTICE OF COMMENCEMENT MUST BE RECORDED WITH THE COUNTY RECORDER AND A COPY POSTED ON THE JOB SITE BEFORE THE FIRST INSPECTION. IF YOU INTEND TO OBTAIN FINANCING CONSULT WITH YOUR LENDER OR AN ATTORNEY BEFORE RECORDING A NOTICE.

FLORIDA STATUTE 469: ABESTOS ABATEMENT. AS OWNER / CONTRACTOR / AGENT OF RECORD FOR THE CONSTRUCTION APPLIED FOR IN THIS APPLICATION, I AGREE THAT I WILL COMPLY WITH THE PROVISIONS F. S. 469.003 AND TO NOTIFY THE FLORIDA D. E. P. OF MY INTENT TO DEMOLISH / REMOVE ASBESTOS. IN ADDITION TO THE REQUIREMENTS OF THIS PERMIT APPLICATION, THERE MAY BE DEED RESTRICTIONS AND / OR ADDITIONAL RESTRICTIONS APPLICABLE TO THIS PROPERTY THAT MAY BE FOUND IN THE PUBLIC RECORDS OF MONROE COUNTY AND THERE MAY BE ADDITIONAL PERMITS REQUIRED FROM OTHER GOVERNMENT ENTITIES SUCH AS AQUADUCT ATHORITY, FLORIDA DEP OR OTHER STATE AGENCIES; ARMY CORPS OF ENGINEERS OR OTHER FEDERAL AGENCIES.

FEDERAL LAW REQUIRES LEAD PAINT ABATEMENT PER THE STANDARDS OF THE USDEP ON STRUCTURES BUILT PRIOR TO 1978.

OFFICIAL USE ONLY BY PLANS EXAMINER OR CHIEF BUILDING OFFICIAL:				CBO OR PL. EXAM. APPROVAL:	
HARC FEES:	BLDG. FEES:	FIRE MARSHAL FEE:	IMPACT FEES:		
				DATE:	

# SANBORN MAPS

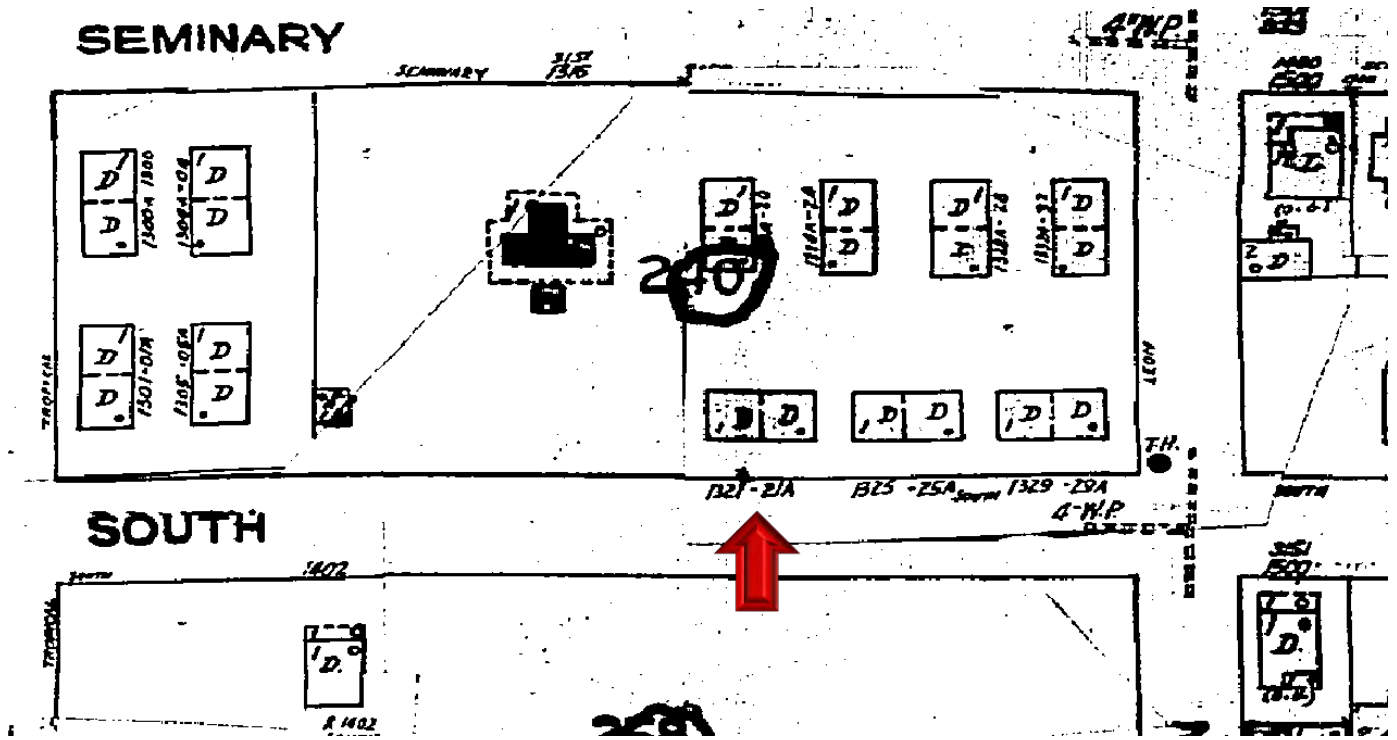

#1321 South Street Sanborn map 1948



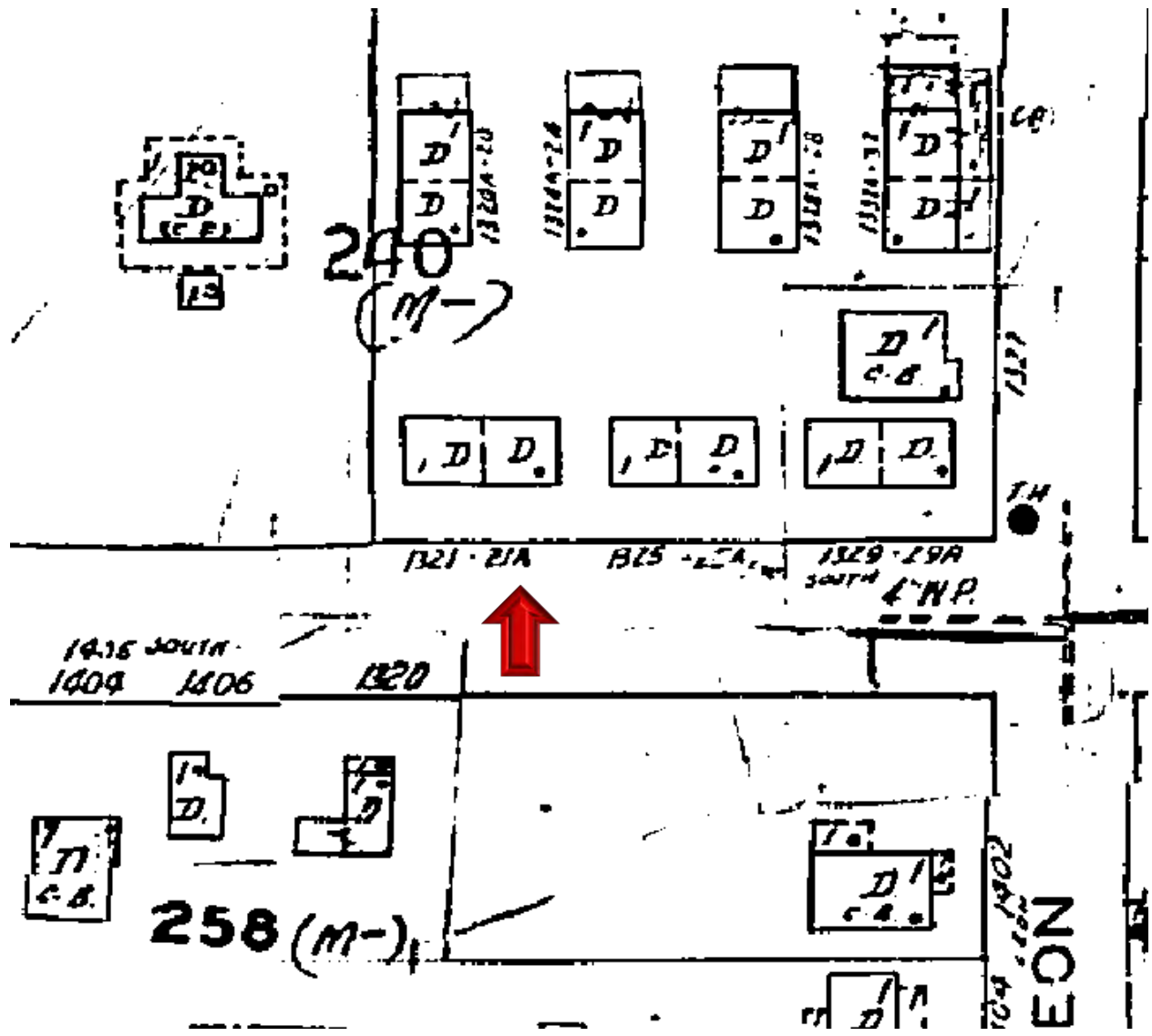

#1321 South Street Sanborn map 1962

# PROJECT PHOTOS



1. Photograph of the front of the subject property at 1321 South Street



2. Photograph of the side east side of the structure.



3. Photograph of the west side of the structure.



4. Another photograph of the front of the subject property.



5. Photograph of the adjacent property to the west.



6. Photograph of the adjacent property to the east.





7. Photograph of property across the street from 1321 South Street.



8. Photograph of property across the street from the 1321 South Street.



8. Photograph of South Street looking to the west.



9. Photograph of South Street looking to the east.

# SURVEY

# Boundary Survey Map of Part of Block 7, Tract 19 City of Key West

## LEGEND

- ⊙ Found 2" Iron Pipe (Fence Post)
- Set #5 rebar w/cap (6298)
- Found 1/2" Iron Rod (PTS)
- ▲ Found Nail & Disc (PTS) (FHH)
- △ Set Nail & Disc (6298)
- (M) Measured
- (R) Record
- (M/R) Measured & Record
- C.B.S. Concrete Block Structure
- R/W Right of Way
- CLF Chain Link Fence
- ⊕ Centerline
- ⊙ Wood Utility Pole
- ⊠ Concrete Utility Pole
- P- Overhead Utility Lines

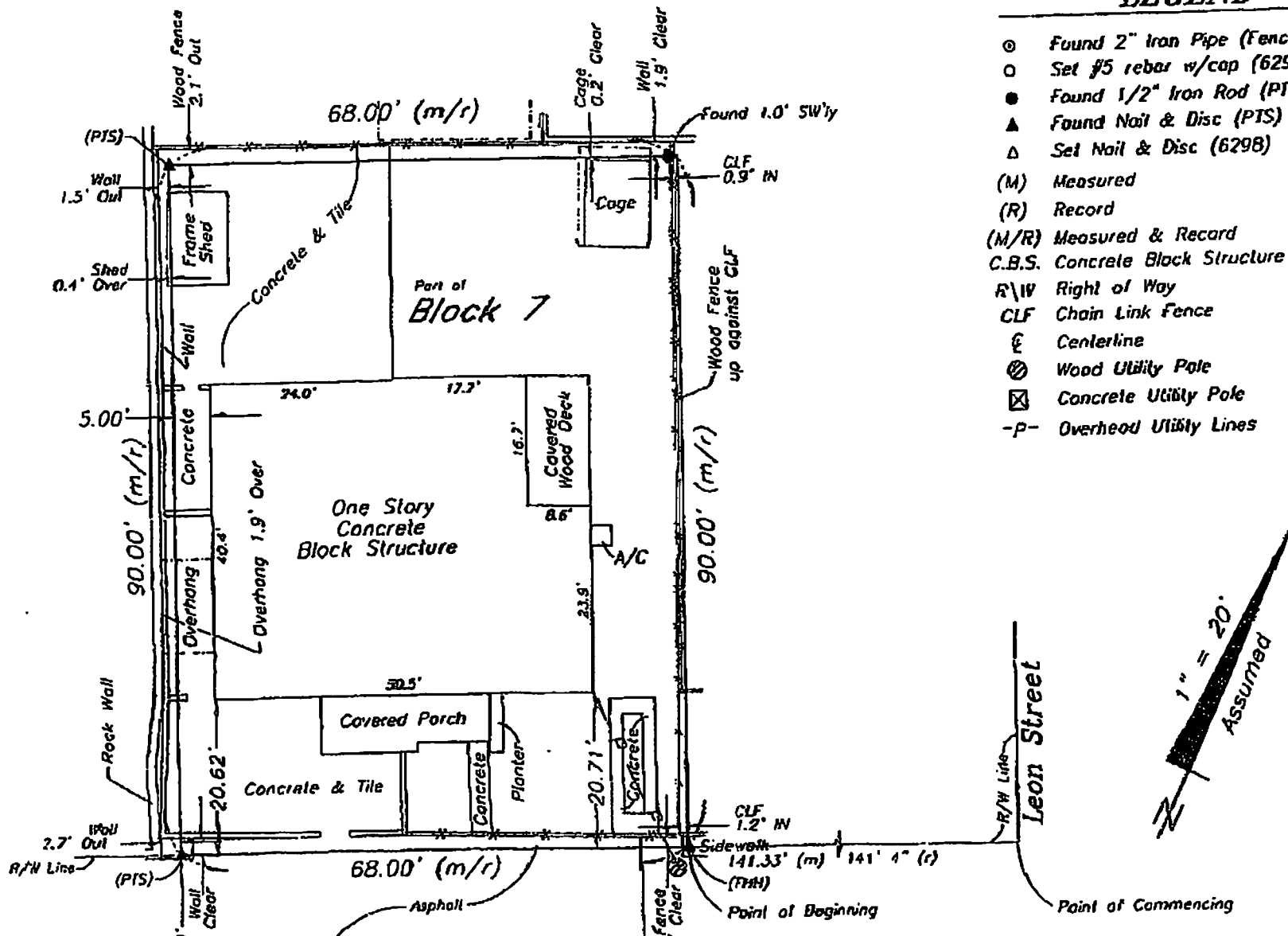

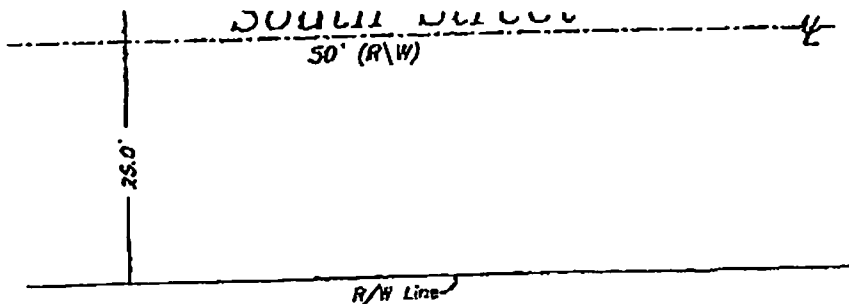

**NOTES:**

1. The legal description shown hereon was furnished by the client or their agent.
2. Underground foundations and utilities were not located.
3. All angles are 90° (Measured & Record) unless otherwise noted.
4. Street address: 1321 South Street, Key West, FL.
5. This survey is not valid without the signature and the original raised seal of a Florida licensed surveyor and mapper.
6. Lands shown hereon were not abstracted for rights-of-way, easements, ownership, or other instruments of record.
7. North Arrow is assumed and based on the legal description.
8. This survey is not assignable.
9. Date of field work: February 8, 2007.
10. Ownership of fences is undeterminable, unless otherwise noted.

**BOUNDARY SURVEY OF:** From the Southeasterly corner of Block 7, (sometimes referred to as Square 7), of Tract 19, in the City of Key West, according to the plat thereof, recorded in Plat Book 1, Page 34, of the records of Monroe County, Florida, run Southwesterly along the Southeasterly side of Block 7, a distance of 141 feet and 4 inches for a point of beginning. From the point of beginning continue Southwesterly along the Southeasterly side of Block 7, a distance of 68 feet to a point; thence Northwesterly along a line parallel to the Northeasterly side of Block 7, a distance of 90 feet to a point; thence Northeasterly and parallel to the Southeasterly side of Block 7, a distance of 68 feet to a point, thence Southeasterly and parallel to the Southwesterly side of Block 7, 90 feet to the point of beginning.

**BOUNDARY SURVEY FOR:** Doug Wasson;

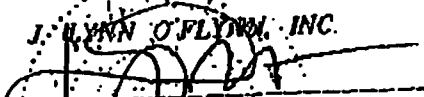
J. LYNN O'FLYNN, INC.  
  
 J. Lynn O'Flynn; PSM  
 Florida Reg. #6298  
 February 13, 2007

**J. LYNN O'FLYNN, Inc.**

Professional Surveyor & Mapper  
PSM #6298



3430 Duck Ave., Key West, FL 33040  
 (305) 296-7427 FAX (305) 296-2744

04-02-2007 11:10am From-RESIDENTIAL LOANS 2962067 T-975 P.009/011 F-219

# PROPOSED DESIGN



### SITE DATA

SITE ADDRESS: 1321 SOUTH ST., KEY WEST, FL 33040  
 RE: 00041790-000000  
 ZONING: HMDR (HISTORIC MEDIUM DENSITY RESIDENTIAL)  
 FLOOD ZONE: AEG  
 F.I.R.M.- COMMUNITY#12087C; MAP & PANEL #1516 SUFFIX K; DATE:02-18-05  
 SECTION/TOWNSHIP/RANGE: 6-68-25  
 LEGAL DESCRIPTION: KW TROPICAL BLDG AND INVESTMENT CO SUB PT LOT 6-7-8 SQR 7 TRTR 19 PB 1-34 G12-183/184  
 SETBACKS: FRONT 10 FT, SIDE 5 FT, REAR 15 FT, STREET SIDE 7.5 FT  
 OCCUPANCY: R-3 RESIDENTIAL SINGLE FAMILY  
 TYPE OF CONSTRUCTION: VB

### INDEX OF DRAWINGS

SHEET CS-1 - COVER SURVEY, PROJECT DATA AND SITE PLAN  
 SHEET A-1 - UNIT A AND UNIT B PROPOSED FLOOR PLANS  
 SHEET A-2 - UNIT A ELEVATIONS  
 SHEET A-3 - UNIT B ELEVATIONS

### LEGEND

SYMBOLS		MATERIAL INDICATIONS		LIST OF ABBREVIATIONS	
	ELEVATION MARK		CONCRETE	&	AND
	WALL TYPE SYMBOL		COMPACTED EARTH FILL	@	AT
	WINDOW TYPE SYMBOL		STUCCO OR GYPSUM WALL BOARD	FT.	FOOT/FEET
	DOOR NUMBER SYMBOL		CONCRETE MASONRY UNIT	FFL	FINISH FLOOR LEVEL
	GARAGE		BRICK	IN.	INCH
	DETAIL OR SECTION AREA		BATT INSULATION	MAX.	MAXIMUM
	DETAIL OR SECTION NUMBER		RIDGE INSULATION	MIN.	MINIMUM
	SHEET# WHERE DETAIL IS SHOWN		SAND	#	NUMBER
	DETAIL OR SECTION NUMBER		GRAVEL	O.C.	ON CENTER
	SHEET# WHERE DETAIL IS SHOWN		CONTINUOUS WOOD FRAMING	LS.	POUND PER SQUARE INCH
	SHEET# WHERE DETAIL IS TAKEN		WOOD BLOCKING	PT	PRESSURE TREATED
			PLYWOOD	SF	SQUARE FOOT/FEET
			FINISH WOOD	T & G	TONGUE AND GROOVE
				WWM	WELDED WIRE MESH

# RESIDENTIAL NEW CONSTRUCTION

1321 SOUTH STREET  
 KEY WEST, FLORIDA 33040

PROJECT DATA	PROPOSED	EXISTING	REQUIRED	VARIANCE REQUESTED
RE NO.	00041790-000000			
SETBACKS:				
FRONT	11'	13.2'	10'	NONE
STREET SIDE	N/A	N/A	7.5'	NONE
SIDE	5.5'	7.4'	5'	NONE
REAR	18'	29.05'	15'	NONE
LOT SIZE	NO CHANGE		6,120 SQ. FT.	4000 SQ.FT.
BUILDING COVERAGE	2,464 SQ.FT. 40%	2,395 SQ. FT. 39%	4000 SQ.FT.	NONE
FLOOR AREA	3,684 SQ.FT. .63	1,896 SQ. FT. 0.31	0.8	NONE
BUILDING HEIGHT	28.7'		30' MAX	NONE
IMPERVIOUS AREA	2,824 SQ.FT. 46%	4,095 SQ. FT. 66%	60% MAX	NONE

SITE

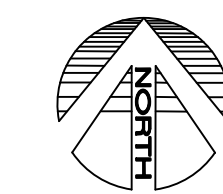

2 LOCATION MAP  
 CS-1 SCALE: NOT TO SCALE

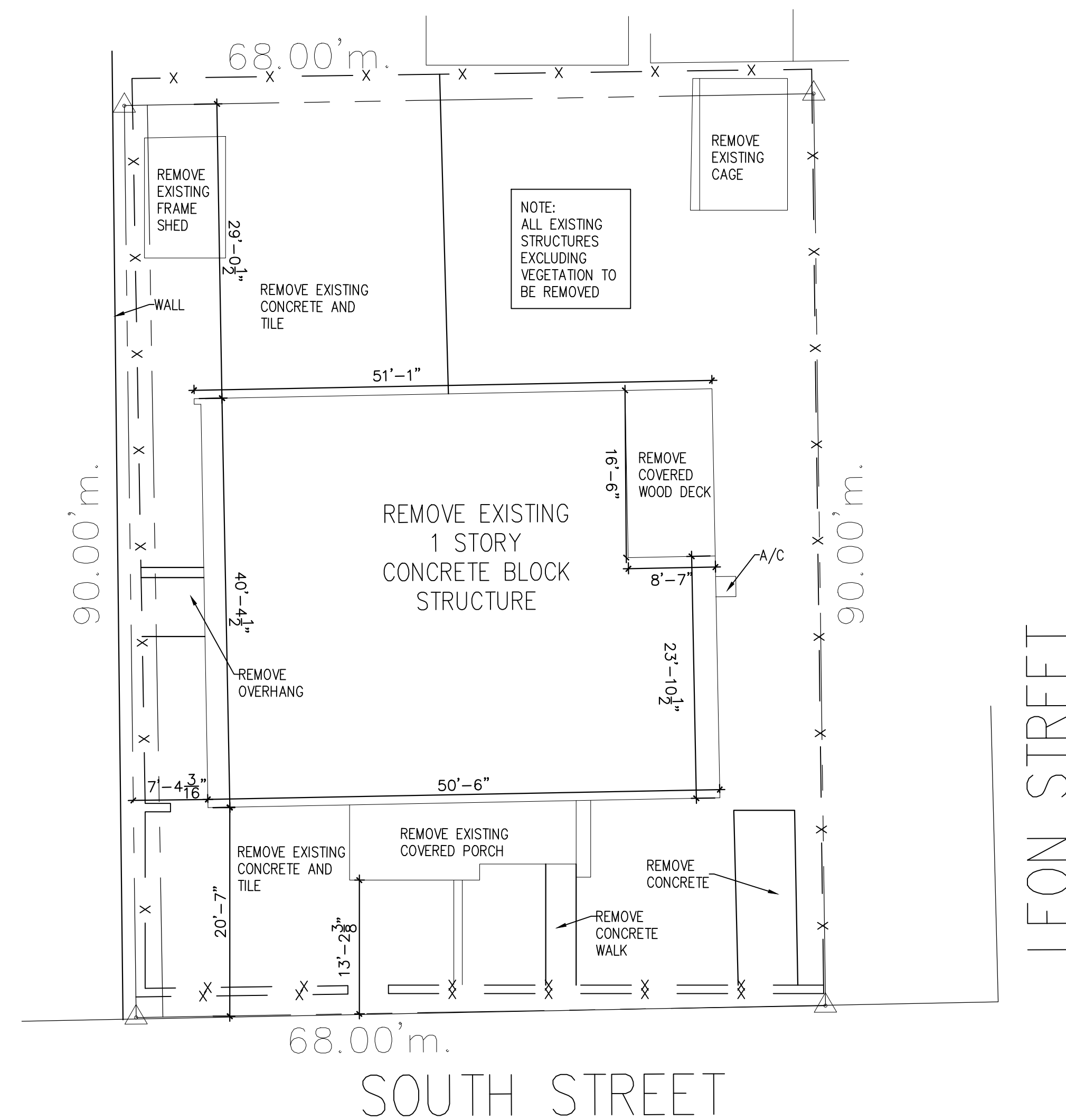

LEON STREET

SOUTH STREET

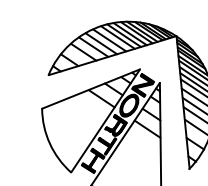

2 SURVEY/DEMOLITION PLAN  
 CS-1 SCALE: 1" = 10'-0"

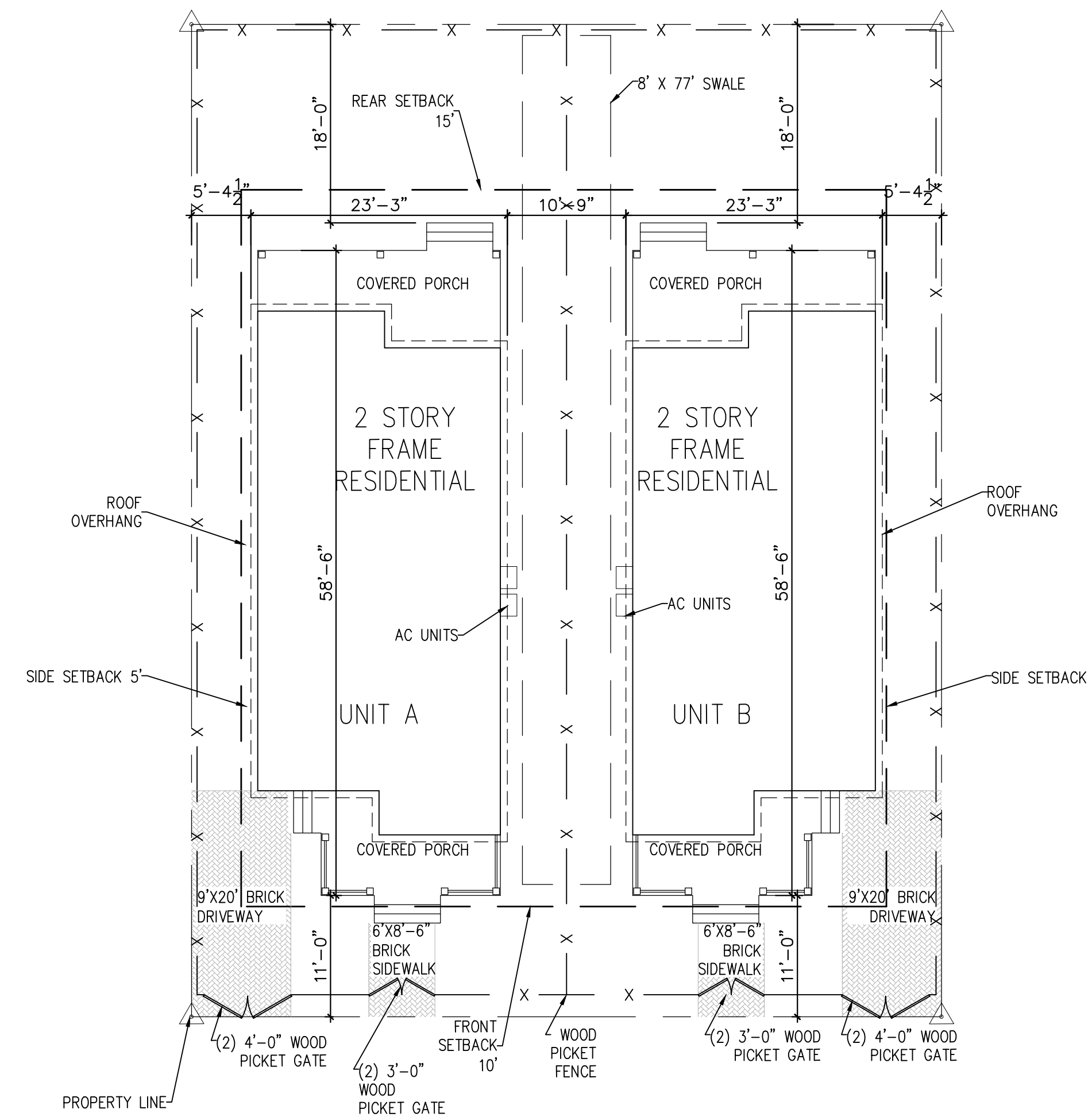

SOUTH STREET

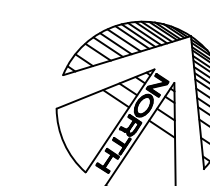

1 SITE PLAN  
 CS-1 SCALE: 1" = 10'-0"

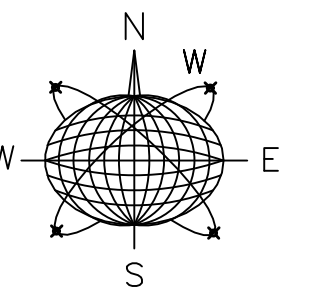

Meridian Engineering LLC  
 201 Front Street, Suite 210  
 Key West, Florida 33040  
 AUTHORIZATION #29401  
 ph:305-293-3263 fax:293-4899

Seal:

NOT VALID FOR CONSTRUCTION UNLESS  
 SIGNED AND SEALED BY THE BLOCK  
 RICHARD J. MILELLI  
 PE #58315

General Notes:

RESIDENTIAL  
 NEW CONSTRUCTION  
 1321 SOUTH STREET  
 KEY WEST, FLORIDA

Drawn By: JMT  
 Project No. AS NOTED  
 AutoCad File No.

Checked By: RJM  
 Scale: AS NOTED

Revisions:

Title:  
 COVER SHEET  
 AND SITE PLAN

Sheet Number:  
**CS-1**  
 Date: JANUARY 2, 2015

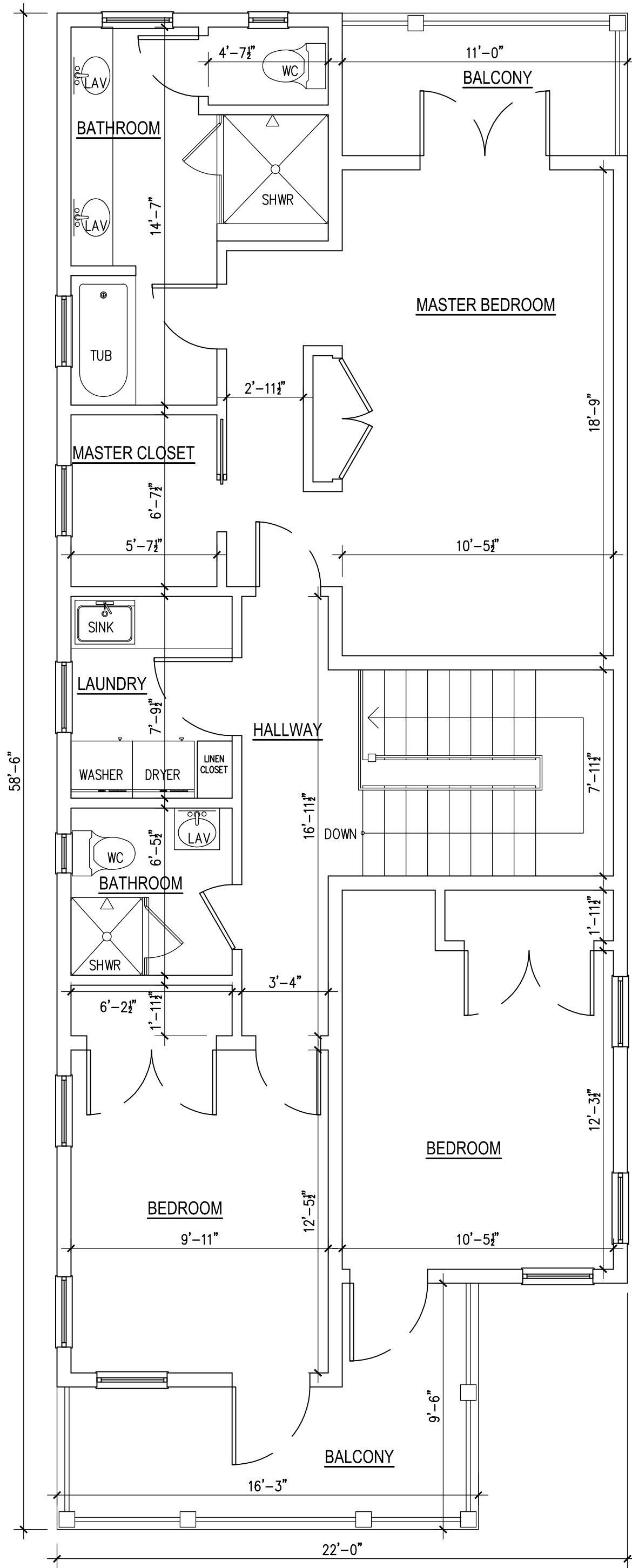

4 UNIT B SECOND FLOOR PLAN  
A-1 SCALE: 1/4" = 1'-0"

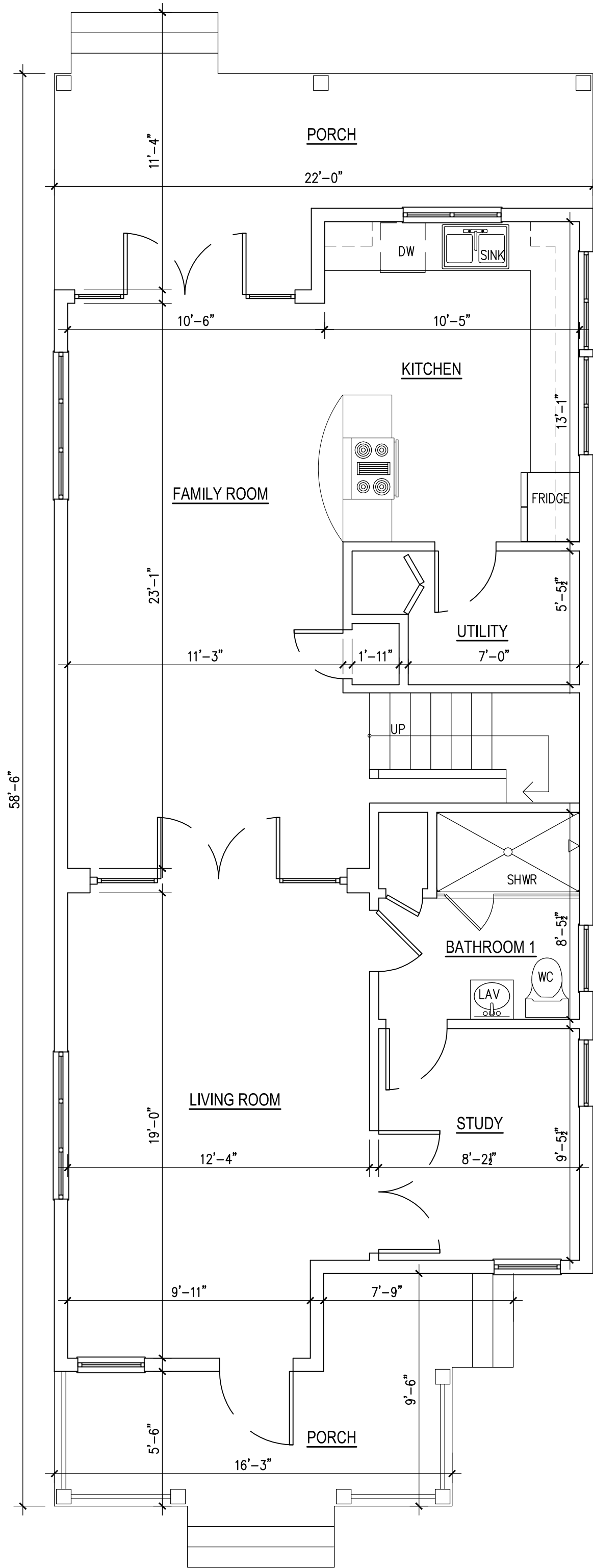

3 UNIT B FIRST FLOOR PLAN  
A-1 SCALE: 1/4" = 1'-0"

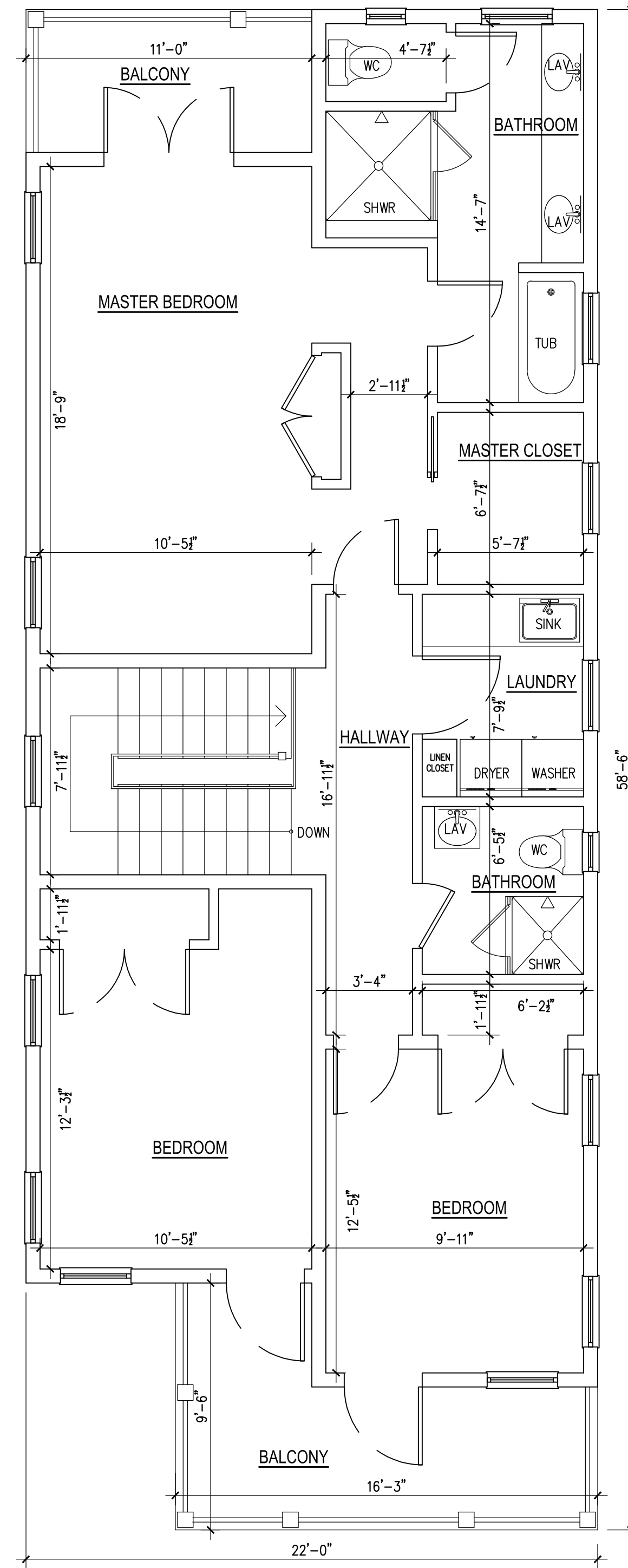

2 UNIT A SECOND FLOOR PLAN  
A-1 SCALE: 1/4" = 1'-0"

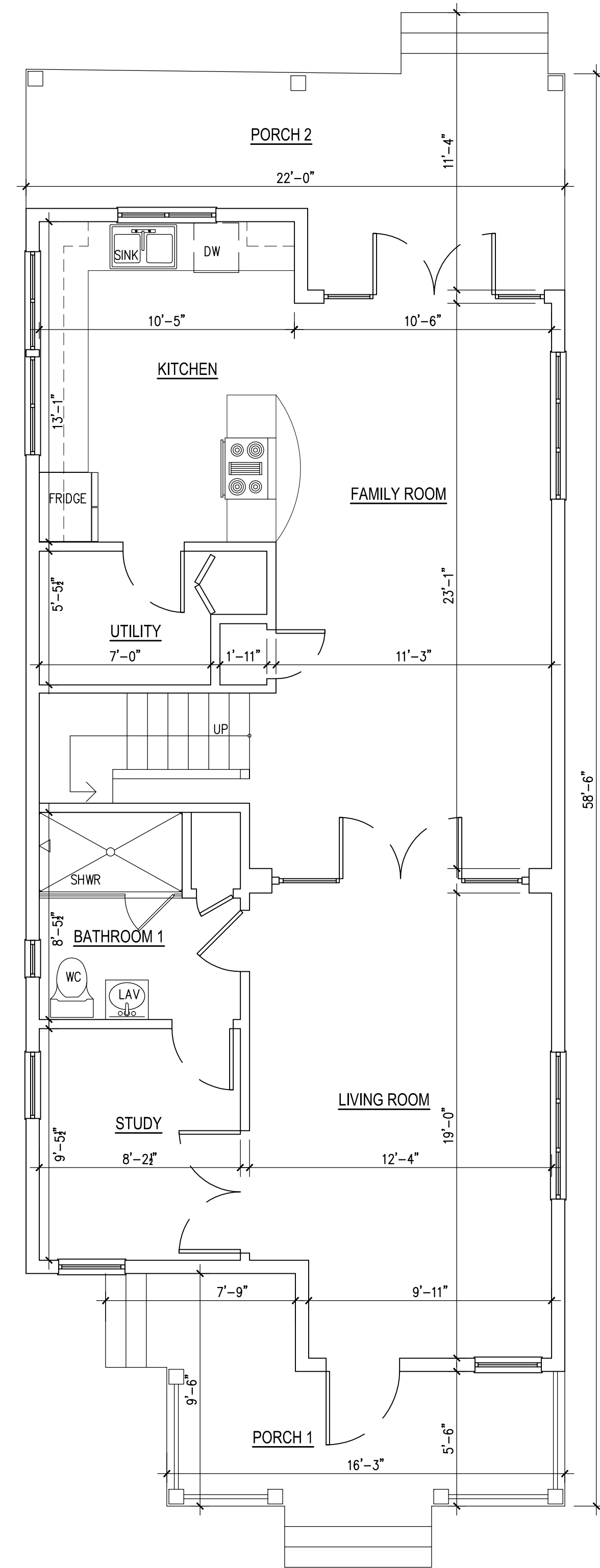

1 UNIT A FIRST FLOOR PLAN  
A-1 SCALE: 1/4" = 1'-0"

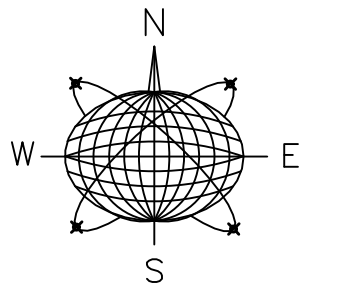

Meridian Engineering LLC  
201 Front Street, Suite 210  
Key West, Florida 33040  
AUTHORIZATION #29401  
ph.305-293-3263 fax.293-4899

Seal:

NOT VALID FOR CONSTRUCTION UNLESS  
SIGNED AND SEALED BY THE BLOCK  
RICHARD J. MILELLI  
PE #58315

General Notes:

RESIDENTIAL  
NEW CONSTRUCTION  
1321 SOUTH STREET  
KEY WEST, FLORIDA

Drawn By: JMT	Checked By: RJM
Project No.	Scale: AS NOTED
AutoCad File No.	

Revisions:

Title:  
UNITS A,B FIRST  
AND SECOND  
FLOOR PLAN

Sheet Number:  
**A-1**  
Date: JANUARY 2, 2015

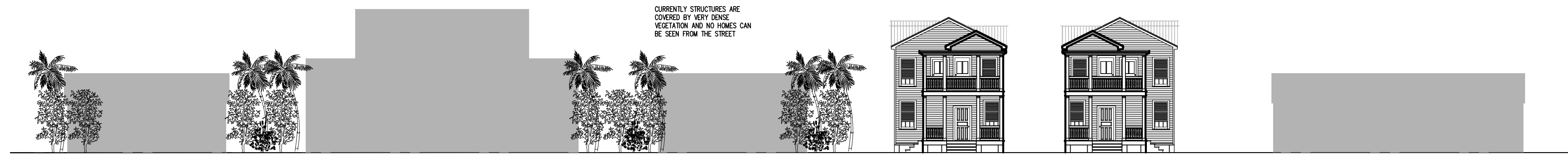

**5** PROPOSED FRONT ELEVATIONS W/ ADJACENT PROPERTIES  
 A-2 SCALE: NTS



**4** UNIT A EAST ELEVATION  
 A-2 SCALE: 1/4" = 1'-0"

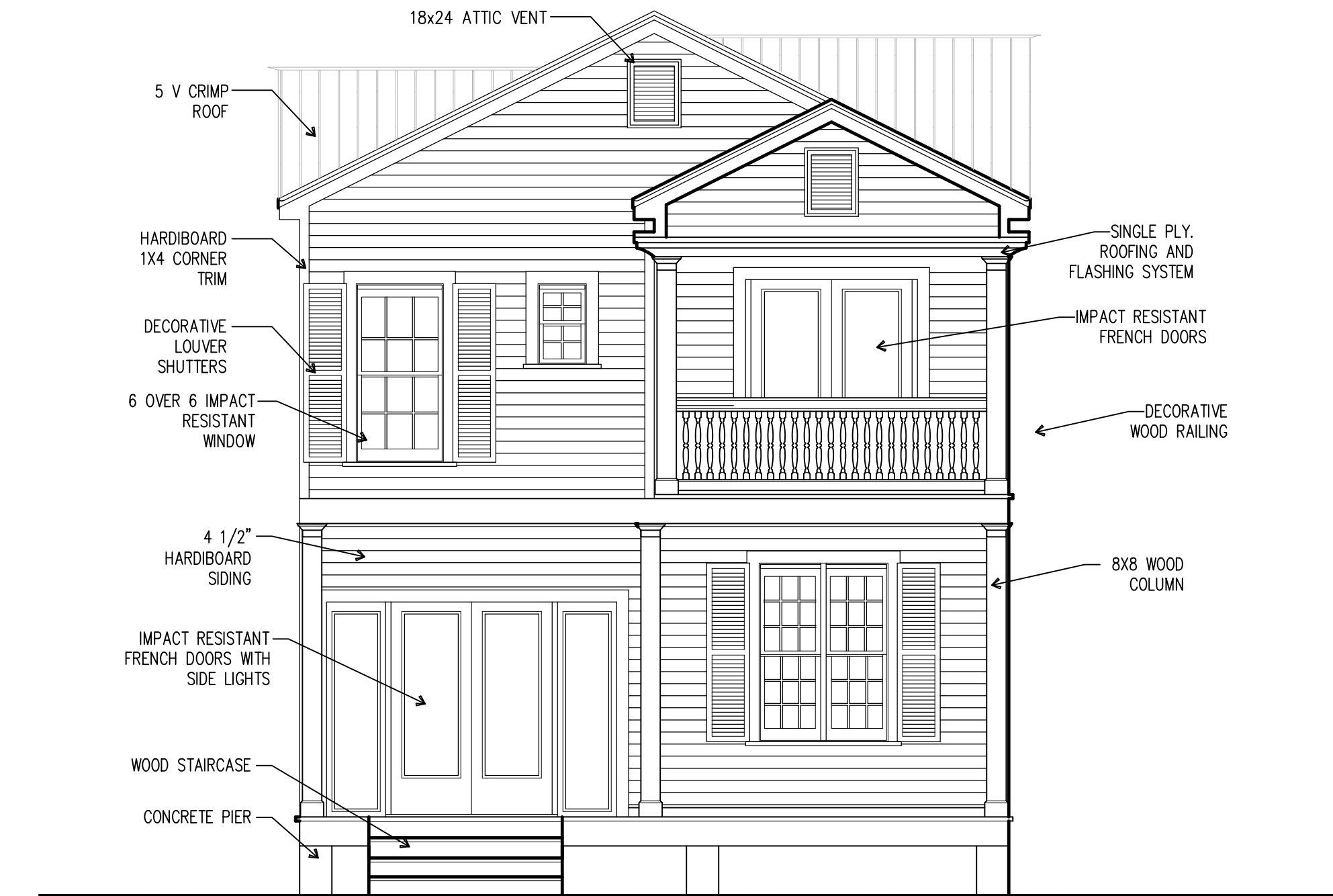

**3** UNIT A NORTH ELEVATION  
 A-2 SCALE: 1/4" = 1'-0"



**2** UNIT A WEST ELEVATION  
 A-2 SCALE: 1/4" = 1'-0"

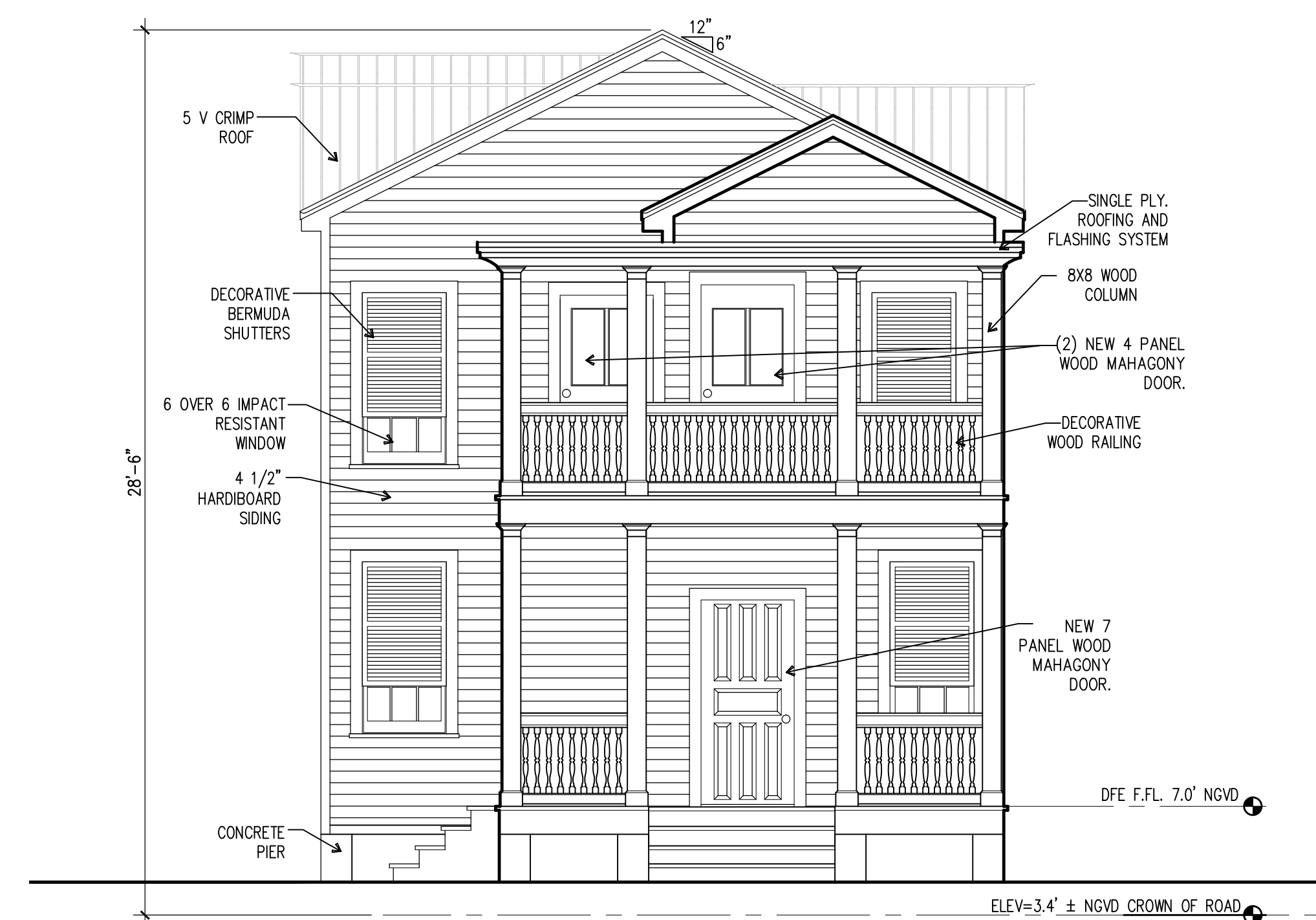

**1** UNIT A SOUTH ELEVATION  
 A-2 SCALE: 1/4" = 1'-0"

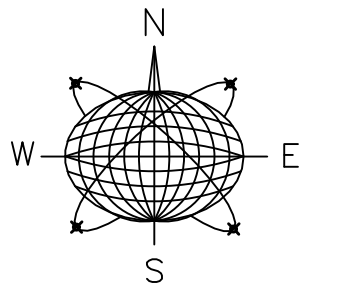

Meridian Engineering LLC  
 201 Front Street, Suite 210  
 Key West, Florida 33040  
 AUTHORIZATION #29401  
 ph:305-293-3263 fax:293-4899

Seal:

NOT VALID FOR CONSTRUCTION UNLESS  
 SIGNED AND SEALED BY THIS BLOCK  
 RICHARD J. MILELLI  
 PE #58315

General Notes:

RESIDENTIAL  
 NEW CONSTRUCTION  
 1321 SOUTH STREET  
 KEY WEST, FLORIDA

Drawn By: JMT	Checked By: RJM
Project No.	Scale: AS NOTED
AutoCad File No.	

Revisions:

Title:  
UNIT A  
ELEVATIONS

Sheet Number:  
**A-2**  
Date: JANUARY 2, 2015

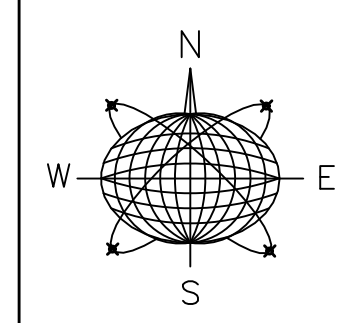

Meridian Engineering LLC  
 201 Front Street, Suite 210  
 Key West, Florida 33040  
 AUTHORIZATION #29401  
 ph:305-293-3263 fax:293-4899

Seal:

NOT VALID FOR CONSTRUCTION UNLESS  
 SIGNED AND SEALED BY THIS BLOCK  
 RICHARD J. MILELLI  
 PE #58315

General Notes:

RESIDENTIAL  
 NEW CONSTRUCTION  
 1321 SOUTH STREET  
 KEY WEST, FLORIDA

Drawn By: JMT	Checked By: RJM
Project No.	Scale: AS NOTED
AutoCad File No.	

Revisions:

Title:  
UNIT B  
ELEVATIONS

Sheet Number:  
**A-3**

Date: JANUARY 2, 2015



**4** UNIT B EAST ELEVATION  
 A-2 SCALE: 1/4" = 1'-0"

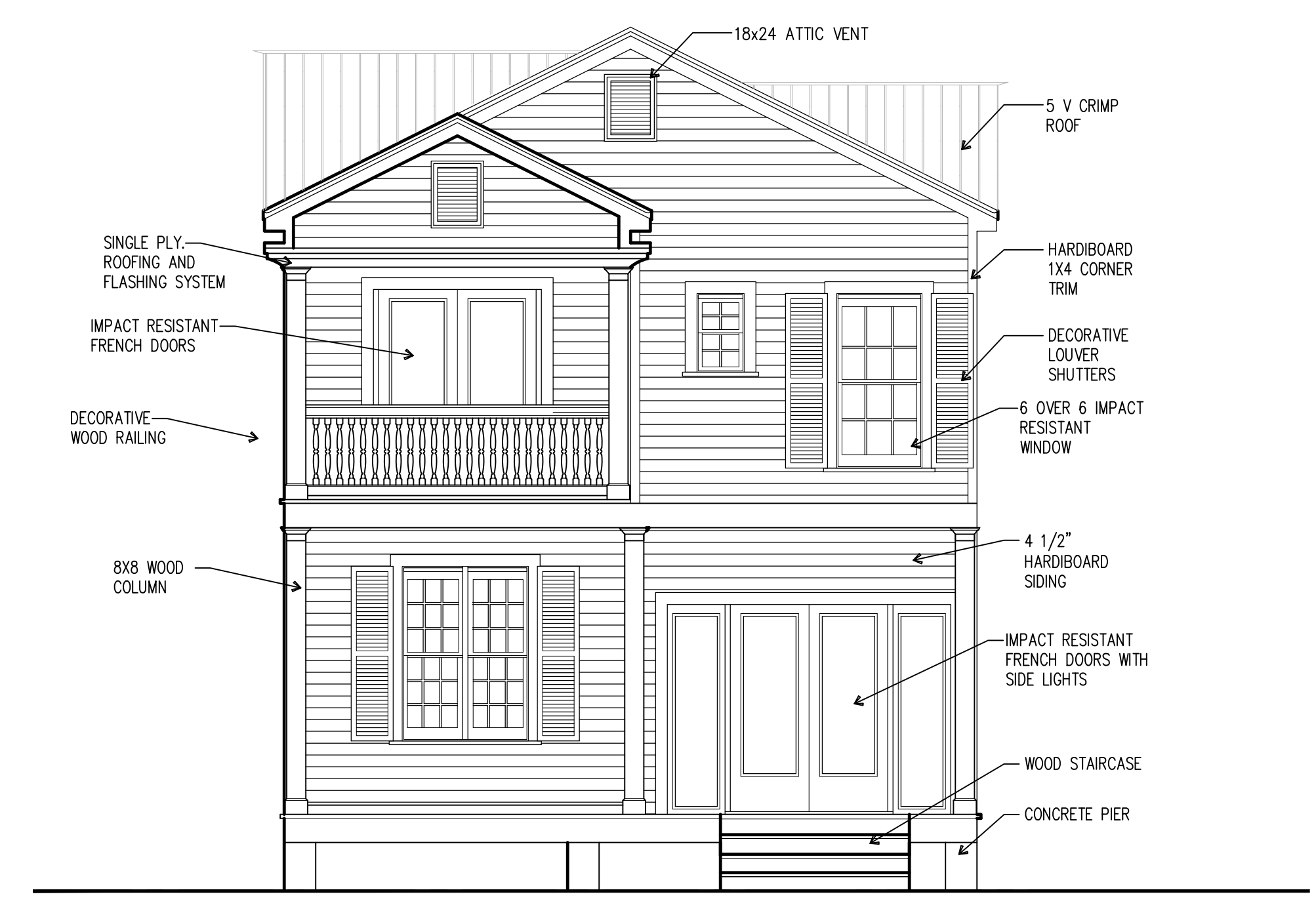

**3** UNIT B NORTH ELEVATION  
 A-2 SCALE: 1/4" = 1'-0"



**2** UNIT B WEST ELEVATION  
 A-2 SCALE: 1/4" = 1'-0"

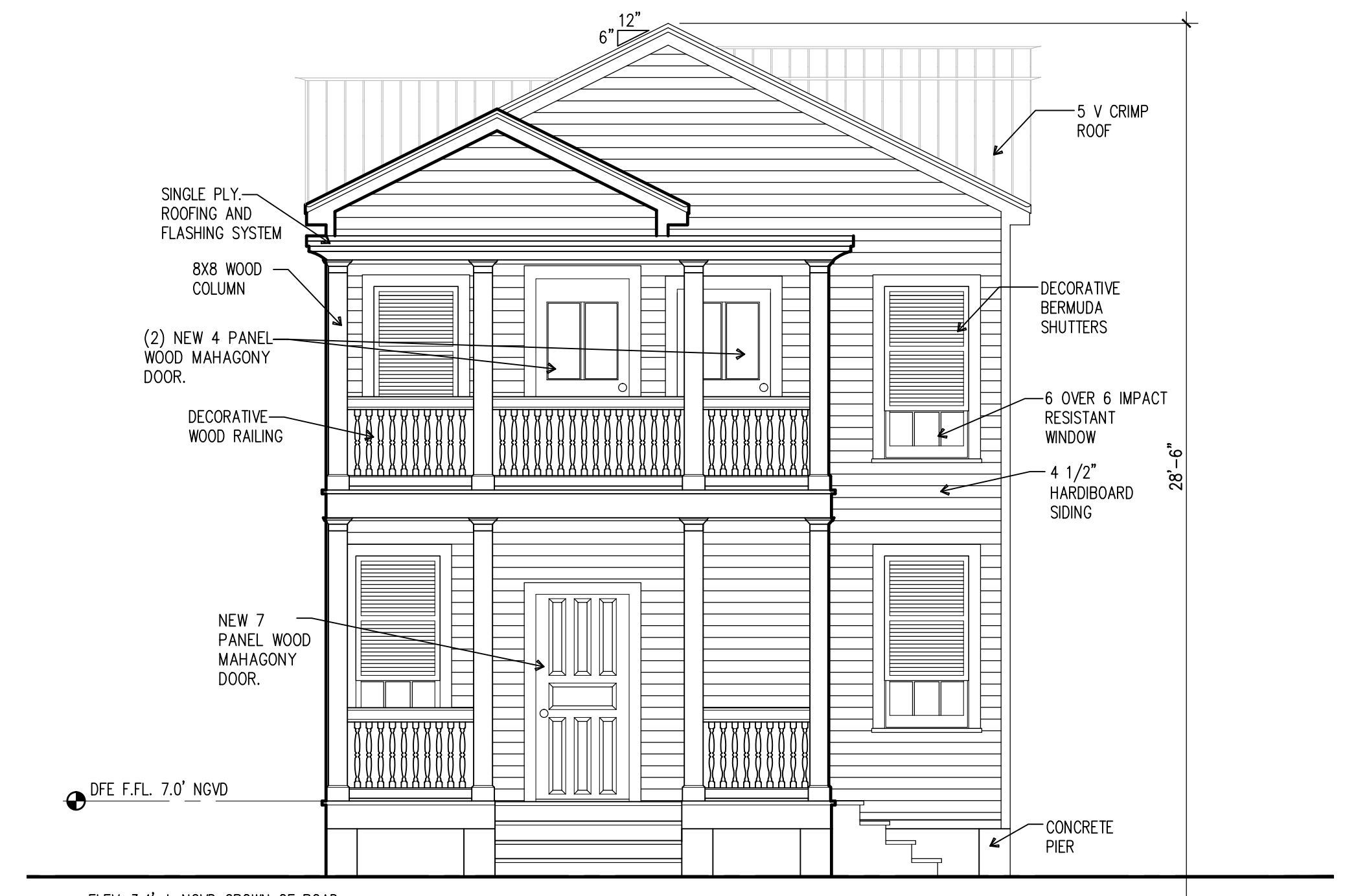

**1** UNIT B SOUTH ELEVATION  
 A-2 SCALE: 1/4" = 1'-0"

# MISCELLANEOUS INFORMATION

Mr. Muench asked how a month got into the question.

Mr. Jones explained that it takes about a month to create the 3D images that Mr. Muench had requested.

There was no one from the public to speak.

Mr. Batty made a motion to approve with the condition that in two or three meetings they bring back a little more absorbent explanation of the site to show how it will look in the Historic District.

Mr. Erskine stated that it was a good idea for them to do it this way so it will not hold up the applicants and the Commission will get the answers that they need.

Mr. Mancini seconded the motion.

APPROVE  X with condition that applicants bring forth drawings and images requested by the Commission in two or three meetings.  
DISAPPROVE \_\_\_\_\_ TABLE \_\_\_\_\_

CL3. H07-07-12-879 **333 Simonton Street, Edward Saint Pe'**

Install satellite up-link dish on roof of building. About 5ft to 6ft in size. Possible need for more than one dish on roof.

No one was present to answer the Commission's questions. Ms. Bowers made a motion to table and Mr. Batty seconded.

APPROVE \_\_\_\_\_ DISAPPROVE \_\_\_\_\_ TABLE  X

CL4. H07-07-12-880 **1321 South Street, David Knoll, Architect.**

Two new 2 story residences in the Conch style.

Mr. Knoll was present representing the project. He passed out sheet 4 that was missing in their packets. He introduced the buyers of the property. He explained that they had bought an oversized lot that had a duplex on it. He stated that they were developing it into two separate structures that will be sold as condos. He stated that they were not building as large as they could have been. He noted changes to the site plan.

Mr. Batty asked if they were adjusting the side setbacks.

Mr. Knoll stated that they weren't. He stated that they developed a few different plans that were mirror images of each other. He stated that each unit has a 9 ft. by 30 ft. parking space. He stated that they each had wrap around porches on the front. He stated that they had an authentic conch feel but they do not look exactly the same. He stated that on the rear of the residences were observation decks with a metal spiral staircase leading to them. He explained that the site plan isn't exactly how the stairs will look because they will be designed by a manufacturer but the space is intended for the staircase.

Ms. Bowers stated that she was assuming this was 30 ft.

Mr. Knoll stated that it was a tad under

Ms. Bowers asked of the height of the observation deck.

Mr. Knoll stated that it was considerably lower than 30 ft.

Ms. Bowers asked what was behind the houses.

Mr. Knoll stated that there were private residences behind the houses.

Ms. Eables stated that they were replacing because of flooding.

Mr. Batty asked if there was any reason why they were going with a bigger fence rather than something smaller.

Mr. Knoll stated because it was traditional.

Mr. Batty stated that no it's not.

Mr. Mancini stated that it should be decorative. He stated that people do such a wonderful job and then cover up so you can't see it.

Mr. Knoll stated that he doesn't want to be argumentative. He stated that standing in front of 4 ft. fence you can see over.

Mr. Batty stated that was true but from the center of the street you can't see the porch. He stated that traditionally all fences remain at 36 in. or lower. He stated that he feels strongly about this because it is a part of the Historical District that it getting lost.

Mr. Knoll stated that his client was willing to comply with that.

Mr. Batty stated that they try to stay clear of the maximum and bring it to 36 in. would make them very happy.

Mr. Knoll stated they would do that.

Ms. Bowers stated that she had a problem with the back observation deck. She stated that it gave the capacity to look into the next door neighbors' back yard.

Mr. Mancini stated that there was nothing in the code that didn't allow it.

Ms. Bowers stated that it doesn't look like anyone was there to be concerned about it.

Mr. Batty asked if there were any variances they would be applying for.

Mr. Knoll stated that there weren't.

Mr. Muench read from the code that roof decks may not be appropriate off a 2 story structure depending on individual characteristics. He asked if this would be a problem.

Ms. Eables stated that there were no neighbors there to say it would.

Ms. Bowers asked if there would be a swimming pool.

Mr. Knoll stated that there may be.

Mr. Mancini stated that he appreciated what has been done here. He stated that the project seems fit. He stated that in reference to balconies and porches that there was nothing in the code that says you can't have things that look into your neighbor's yard. He stated that if they follow the rules, the regulations and the code and gets passed they have done everything correct and you have to respect that.

There was no one from the public to speak.

Mr. Batty made a motion to approve with changes of fence reduced to a height of 36 in.

Mr. Mancini asked about proper spacing between the pickets.

Mr. Mancini seconded the motion.

APPROVE  X  with changed of fence to a reduced height of 36  
inches DISAPPROVE \_\_\_\_\_ TABLE \_\_\_\_\_

**CL5. H07-07-13-886 421 Caroline Street, William Horn, Architect**

Renovation of building to a restaurant use, exterior spalling repair,  
new front façade windows and doors.

Mr. Horn was present representing the project. He stated that this was the Old Conch Masonary Building and that they wanted to turn it into a restaurant, a Brazilian Steakhouse. He stated that they would be restoring the façade using what they can on the front. He presented the project further to the Commission.

Ms. Bowers asked where the coral was.

Mr. Horn stated the entire façade.

Ms. Bowers stated that it sounds great.

Ms. Eables stated that she was pleased to see someone doing something with this building.

Ms. Bowes stated that she has gone to Brazilian restaurants and that they are wonderful restaurants. She asked how many seats they were requesting.



# TWO NEW RESIDENCES FOR: 1321 SOUTH STREET KEY WEST, FLORIDA

## GENERAL NOTES

- THE CONTRACTOR SHALL SCHEDULE A PRECONSTRUCTION CONFERENCE WITH THE ARCHITECT PRIOR TO BEGINNING THE WORK TO PREVIEW THESE DRAWINGS AND TO CLARIFY ALL QUESTIONS AND CONCERNS REGARDING THE INFORMATION CONTAINED HEREIN.
- ALL WORK DEPICTED IN THESE DRAWINGS SHALL CONFORM TO THE REQUIREMENTS OF THE LATEST EDITIONS OF THE FLORIDA BUILDING CODE AND THE NATIONAL ELECTRICAL CODE. THE CONTRACTOR AND SUBCONTRACTORS ARE EXPECTED TO BE FAMILIAR WITH THESE CODES, AND ARE RESPONSIBLE FOR BUILDING ACCORDINGLY.
- THE CONTRACTOR SHALL REVIEW THE INFORMATION IN THESE DRAWINGS PRIOR TO THE COMMENCEMENT OF WORK AND SHALL BE RESPONSIBLE FOR REPORTING TO THE ARCHITECT IN A TIMELY MANNER ANY DISCREPANCIES WITH ALL APPLICABLE LAWS, ORDINANCES AND CODES OF THE CITY OF KEY WEST, FLORIDA.
- "V.I.F." MEANS THAT THE CONTRACTOR SHALL CONFIRM EXISTING CONDITIONS IN THE FIELD AND REPORT TO THE ARCHITECT ANY DISCREPANCIES IN THE INFORMATION GIVEN IN THESE DRAWINGS BEFORE PROCEEDING WITH THE AFFECTED WORK.
- "VERIFY" MEANS THAT THE CONTRACTOR SHALL INSPECT THE AREA OF WORK THAT IS NOTED IN THE DRAWINGS AND REPORT TO THE ARCHITECT THE FINDINGS OF THE INSPECTION BEFORE PROCEEDING.
- THE INFORMATION CONTAINED IN THESE DRAWINGS IS BINDING, AND NO CHANGES TO THE WORK ARE PERMITTED WITHOUT FIRST CONSULTING THE ARCHITECT AND FOLLOWING ESTABLISHED PROTOCOL AUTHORIZING SUCH CHANGES.
- SCALING THESE DRAWINGS IS NOT PERMITTED. WHERE DIMENSIONS HAVE BEEN OMITTED, CONTRACTOR SHALL CONSULT THE ARCHITECT.
- THE CONTRACTOR SHALL BE AWARE THAT WHERE THE WORK INVOLVES CHANGES TO EXISTING CONDITIONS, DIMENSIONS THAT APPEAR IN THE DRAWINGS ARE SOMETIMES BASED ON FIELD MEASUREMENTS AND ARE TO BE CONSIDERED "V.I.F."
- DIMENSIONS SHOWN ARE TAKEN TO FACE OF STUD, TIMBER, BLOCK, OR CONCRETE AND TO CENTERLINE OF FOUNDATION PIERS AND WINDOWS AND DOORS.
- NEW FRAME WALL CONSTRUCTION SHALL CONSIST OF 2X6 16" O.C. AT EXTERIOR WALLS AND 2X4 16" O.C. AT INTERIOR WALLS UNLESS SPECIFICALLY CALLED OUT OTHERWISE.

## PROJECT SCOPE

THE WORK DEPICTED IN THESE DRAWINGS IS FOR THE DEMOLITION OF A ONE STORY MASONRY BLOCK DUPLEX AND THE CONSTRUCTION OF TWO NEW TWO STORY FRAME RESIDENCES AT 1321 SOUTH STREET IN KEY WEST, FL.

## SITE DATA

- LAND USE DISTRICT: HMDR - HISTORIC MEDIUM DENSITY RESIDENTIAL
- LOT AREA: 6120 SQ. FT.
- SETBACKS:
 

	ALLOWED	PROPOSED
FRONT	10.0'	11.0'
SIDE	5.0'	5.5'
REAR	15.0'	20.5'
- LOT COVERAGE:
 

	ALLOWED	PROPOSED
BUILDING	40%	40%
IMP. SURFACE	60%	48%
- STORMWATER RETENTION CALCULATIONS:  
6120 S.F. X 104" X .48 = 306 C.F. / 5 = 612 S.F.  
PROVIDE 8" X 77" SWALE 6" DEEP

## DESIGN WIND PRESSURES

BASIC WIND SPEED: 150 M.P.H. / WIND IMPORTANCE FACTOR: 1.0 / RESIDENCE / WIND EXPOSURE: B / INTERNAL PRESSURE COEFFICIENT: +0.18 / SEE ENGINEER'S CALCULATIONS FOR CLADDING AND COMPONENTS DESIGN PRESSURES

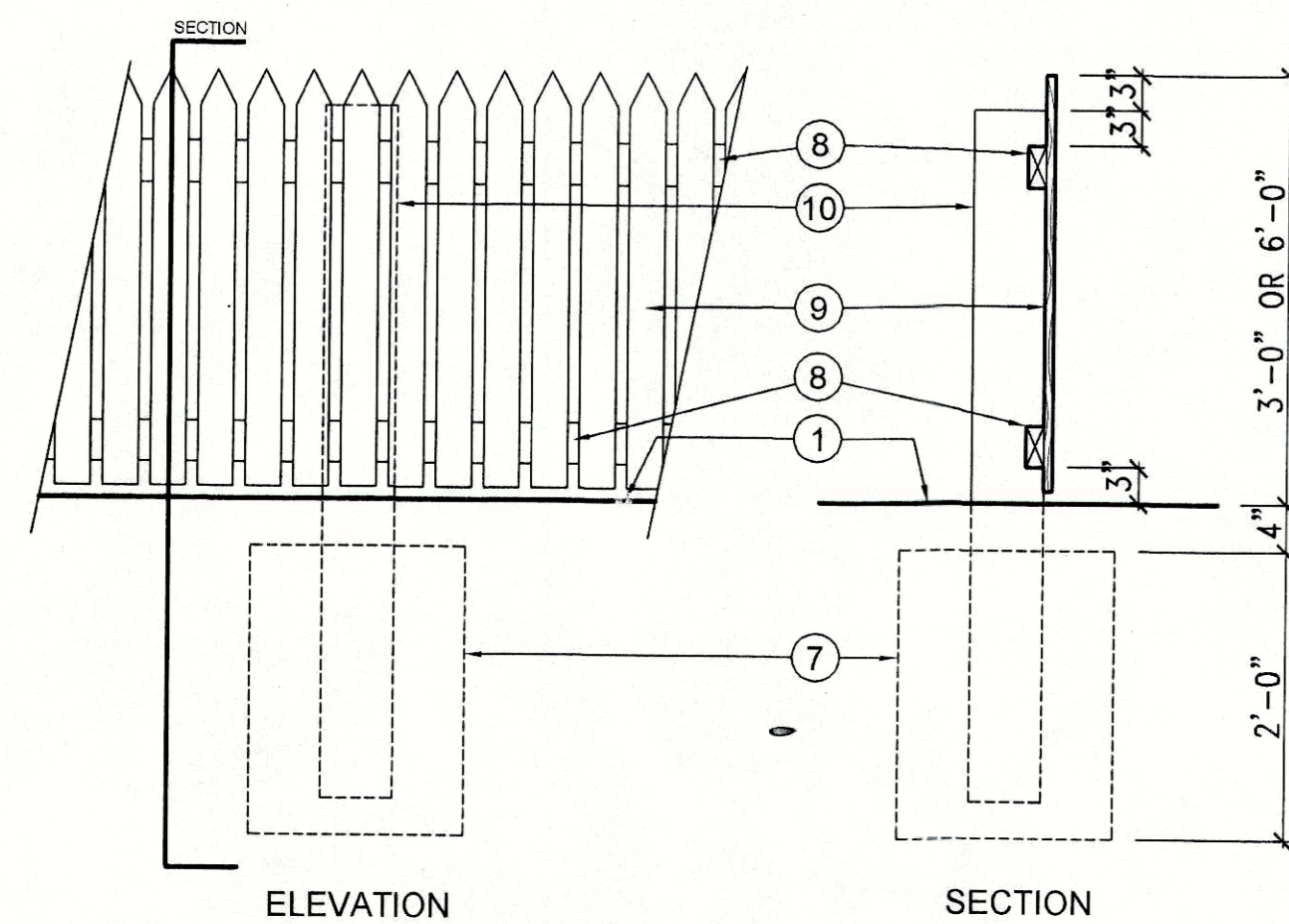

**1** FENCE  
SP 3/4" = 1'-0"

## INDEX TO THE DRAWINGS

SHEET	CONTENT
SP	SITE PLAN, INDEX TO DRAWINGS, GENERAL NOTES, SITE DATA, DESIGN PRESSURES, DETAIL AND NOTES
<b>UNIT A SHEETS</b>	
A1	LOWER LEVEL PLAN AND NOTES
A2	UPPER LEVEL PLAN AND NOTES
A3	ATTIC PLAN, ROOF AND DECK PLAN, DETAILS AND NOTES
A4	BUILDING ELEVATIONS, DETAILS AND NOTES
A5	BUILDING ELEVATIONS AND NOTES
A6	BUILDING SECTION, DETAILS AND NOTES
A7	BUILDING SECTIONS AND NOTES
A8	ENLARGED PLANS, INTERIOR ELEVATIONS AND NOTES
A9	ENLARGED PLANS, INTERIOR ELEVATIONS AND NOTES
A10	INTERIOR ELEVATIONS AND NOTES
A11	DOOR AND WINDOW SCHEDULE, DETAILS AND NOTES
S1	FOUNDATION PLAN, LOWER LEVEL FLOOR FRAMING PLAN AND NOTES
S2	UPPER LEVEL AND ATTIC FLOOR & LOWER ROOF FRAMING PLANS AND NOTES
S3	DECK AND UPPER ROOF FRAMING PLANS, CONNECTOR SCHEDULE, DETAILS AND NOTES
E1	LOWER AND UPPER LEVEL POWER AND LIGHTING PLANS AND ELECTRICAL DEVICES LEGEND
E2	ATTIC AND DECK LEVEL POWER AND LIGHTING PLANS AND ELECTRICAL LOADS CALCULATIONS
P1	LOWER AND UPPER LEVEL PLUMBING PLANS AND PLUMBING RISER DIAGRAM
M1	LOWER AND UPPER LEVEL H.V.A.C. PLANS
<b>UNIT B SHEETS</b>	
A12	LOWER LEVEL PLAN AND NOTES
A13	UPPER LEVEL PLAN AND NOTES
A14	ROOF PLAN, ATTIC PLAN, ROOF AND DECK PLAN AND NOTES
A15	BUILDING ELEVATIONS AND NOTES
A16	BUILDING ELEVATIONS AND NOTES
A17	BUILDING SECTION, DETAILS AND NOTES
A18	BUILDING SECTIONS, DETAILS AND NOTES
A19	ENLARGED PLANS, INTERIOR ELEVATIONS AND NOTES
A20	ENLARGED PLANS, INTERIOR ELEVATIONS AND NOTES
A21	INTERIOR ELEVATIONS AND NOTES
A22	DOOR AND WINDOW SCHEDULE, DETAILS AND NOTES
S4	FOUNDATION PLAN, FIRST FLOOR FRAMING PLAN AND NOTES
S5	UPPER LEVEL, ATTIC FLOOR & LOWER ROOF FRAMING PLANS AND NOTES
S6	DECK AND UPPER ROOF FRAMING PLANS, DETAILS, NOTES AND CONNECTOR SCHEDULE
E3	LOWER AND UPPER LEVEL POWER AND LIGHTING PLANS AND ELECTRICAL DEVICES LEGEND
E4	ATTIC AND DECK LEVEL POWER AND LIGHTING PLANS AND ELECTRICAL LOADS CALCULATIONS
P2	LOWER AND UPPER LEVEL PLUMBING PLANS AND PLUMBING RISER DIAGRAM
M2	LOWER LEVEL AND UPPER LEVEL H.V.A.C. PLANS

## DETAILS NOTES

- GRADE
- 6" REINFORCED CONCRETE SLAB
- 4" X 4" X 3/8" STEEL EMBED PLATE
- 3" DIAMETER PIPE COLUMN WELDED TO EMBED PLATE - 6 REQUIRED
- 3" X 6" X 3/8" STEEL CHANNEL AT 4 SIDES AND CENTER
- 1" X 1" STEEL GRATE WELDED TO STEEL CHANNEL
- 18" DIAMETER FOOTING
- P.T. 2X4 TOP AND BOTTOM RAIL LET INTO POST
- P.T. 1X3 WOOD PICKETS SPACED 1"
- P.T. 6X6 POST 6'-0" O.C. MAXIMUM

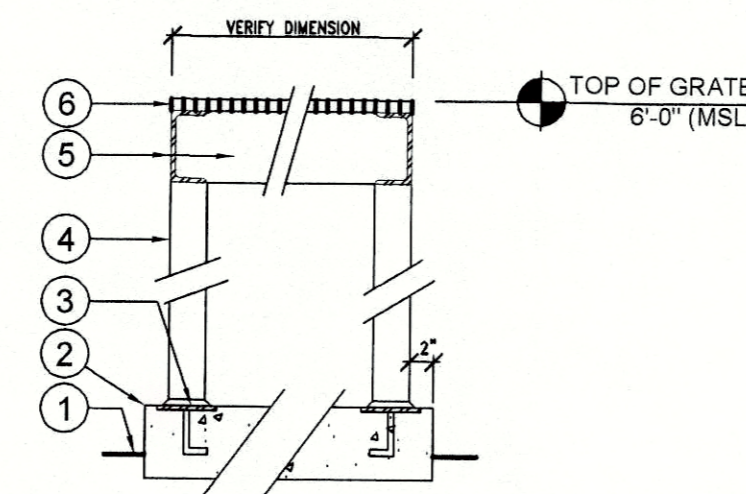

**2** A.C. PLATFORM  
SP 3/4" = 1'-0"

## SITE PLAN NOTES

- BUILDING SETBACK LINE
- 8'-0" X 77'-0" STORMWATER RETENTION SWALE - SEE SITE DATA
- PROPERTY LINE
- 5'-0" DIAMETER METAL SPIRAL STAIR BY OTHERS
- 6'-0" HIGH WOOD PICKET FENCE - SEE DETAIL 1 / SP
- 3'-0" HIGH WOOD PICKET FENCE - SEE DETAIL 1 / SP
- 9'-0" X 20'-0" BRICK ON SAND PARKING SPACE
- 6'-0" WIDE BRICK ON SAND SIDEWALK
- 9'-0" WIDE DOUBLE LEAF WOOD PICKET AUTO GATE, 3'-0" HIGH - SEE DETAIL 1 / SP FOR SIMILAR CONSTRUCTION
- 6'-0" WIDE DOUBLE LEAF WOOD PICKET PERSON GATE, 3'-0" HIGH - SEE DETAIL 1 / SP FOR SIMILAR CONSTRUCTION
- 3'-0" WOOD PICKET FENCE OFFSET 2'-0" FROM FRONT PROPERTY LINE
- EXISTING ASPHALT
- STEEL AIR CONDITIONER PLATFORM WITH TOP OF PLATFORM AT 6'-0" MSL. - SIZE OF PLATFORM TO BE DETERMINED BY MECHANICAL CONTRACTOR - SEE DETAIL 2 / SP

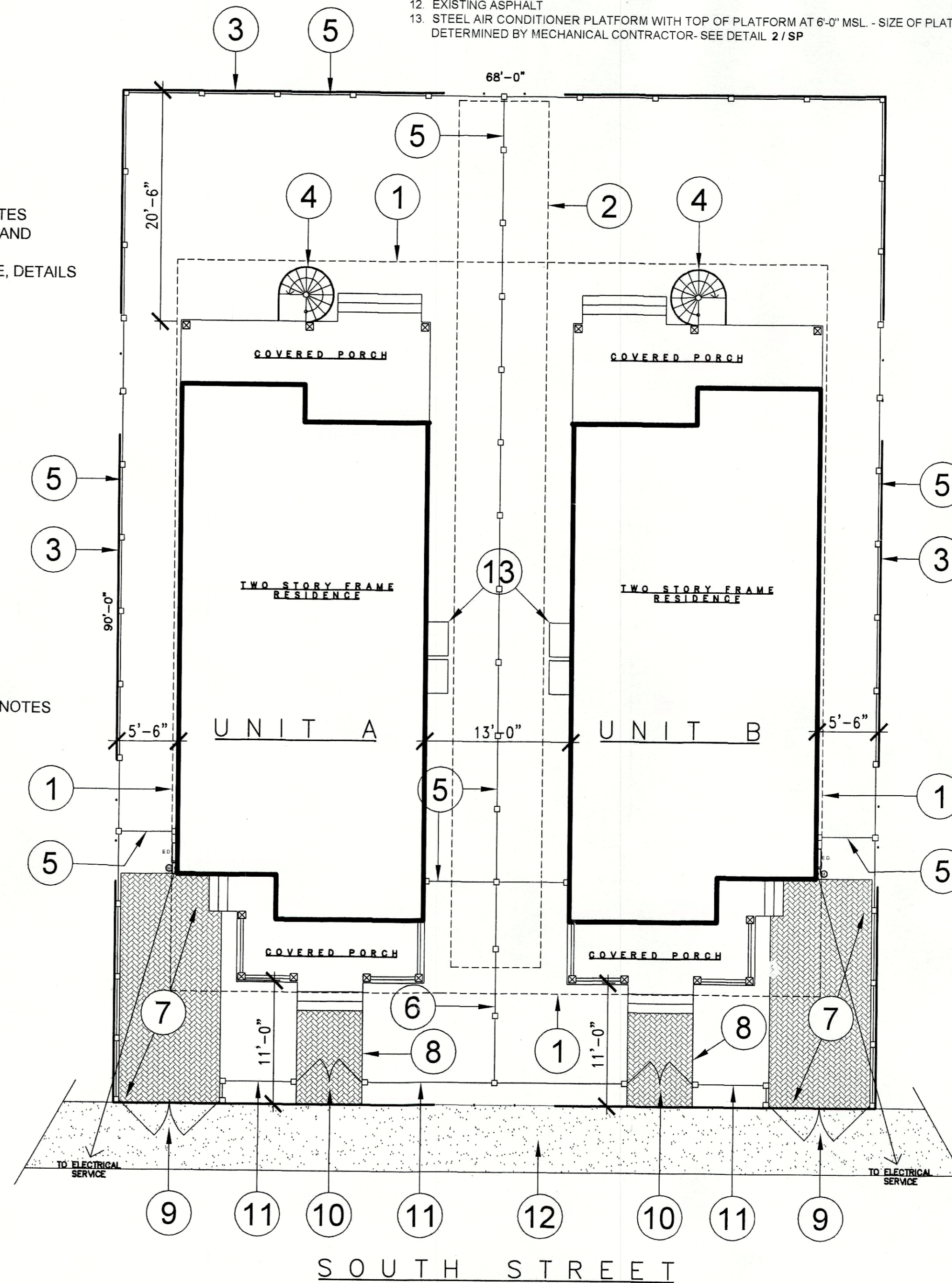

SOUTH STREET

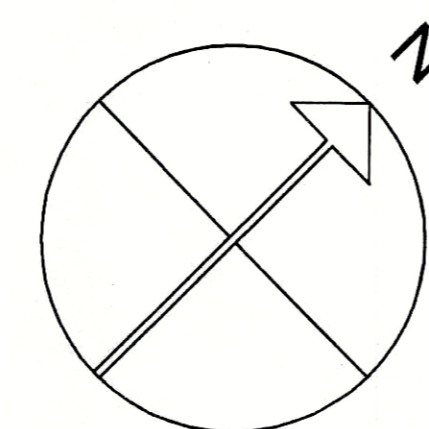

**SITE PLAN**  
1/8" = 1'-0"

REVISIONS	
NO.	DATE

DATE OF ISSUE:

TWO NEW RESIDENCES FOR:  
**1321 SOUTH STREET**  
KEY WEST, FLORIDA

DAVID KNOWLTON  
ARCHITECT  
KEY WEST, FL. (305) 715-8617

SHEET

**SP**

OF 37 SHEETS

**LOWER LEVEL PLAN NOTES**

1. 1X6 T&G HARDWOOD FLOORING ON P.T. 3/4" CDX T&G PLYWOOD SUBFLOOR GLUED AND SCREWED TO JOISTS
2. TILE FLOOR FINISH ON 1/2" TILE BACKER BOARD ON P.T. 3/4" CDX PLYWOOD SUBFLOOR GLUED AND SCREWED TO JOISTS
3. HARDWOOD SADDLE AT FLOOR FINISH TRANSITION
4. 1X6 COMPOSITE PORCH FLOORING
5. MINIMUM 36" HIGH WOOD RAILING - SEE DETAIL 1/A4
6. P.T. 8X8 COLUMN WITH 1/2" CHAMFERED EDGES, TYPICAL OF 5 LOCATIONS AT PORCH 1 - SEE DETAIL 1/A4
7. P.T. 8X8 COLUMN WITH 1/2" CHAMFERED EDGES, TYPICAL OF 3 LOCATIONS AT PORCH 2 - SEE DETAIL 1/A4
8. STEPS WITH 1X6 COMPOSITE PORCH FLOORING ON (4) P.T. 2X12 STRINGERS
9. STEPS WITH 1X6 COMPOSITE PORCH FLOORING ON (3) P.T. 2X12 STRINGERS
10. STEPS WITH 1X6 COMPOSITE PORCH FLOORING ON (5) P.T. 2X12 STRINGERS
11. 5'-0" DIAMETER POWDER COATED ALUMINUM SPIRAL STAIR BY OTHERS
12. STAIR TO HAVE HARDWOOD TREADS, RISERS AND HANDRAIL WITH (3) P.T. 2X12 STRINGERS
13. BULKHEAD ABOVE - SEE 2/A11
14. CLOTHES ROD AND 14" SHELF AT 5'-6" A.F.F.
15. (6) 12" ADJUSTABLE SHELVES WITH BRACKETS AND (4) STANDARDS
16. METAL THRESHOLD
17. WOOD THRESHOLD
18. AIR HANDLER

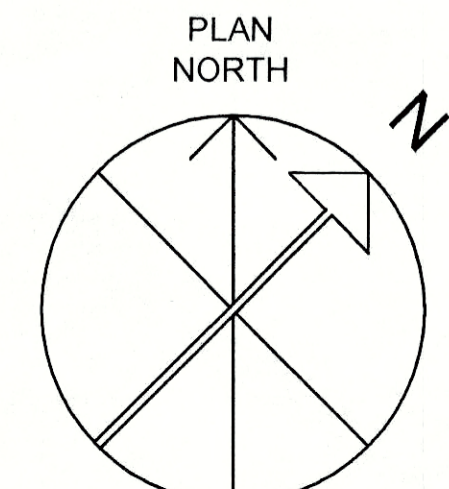
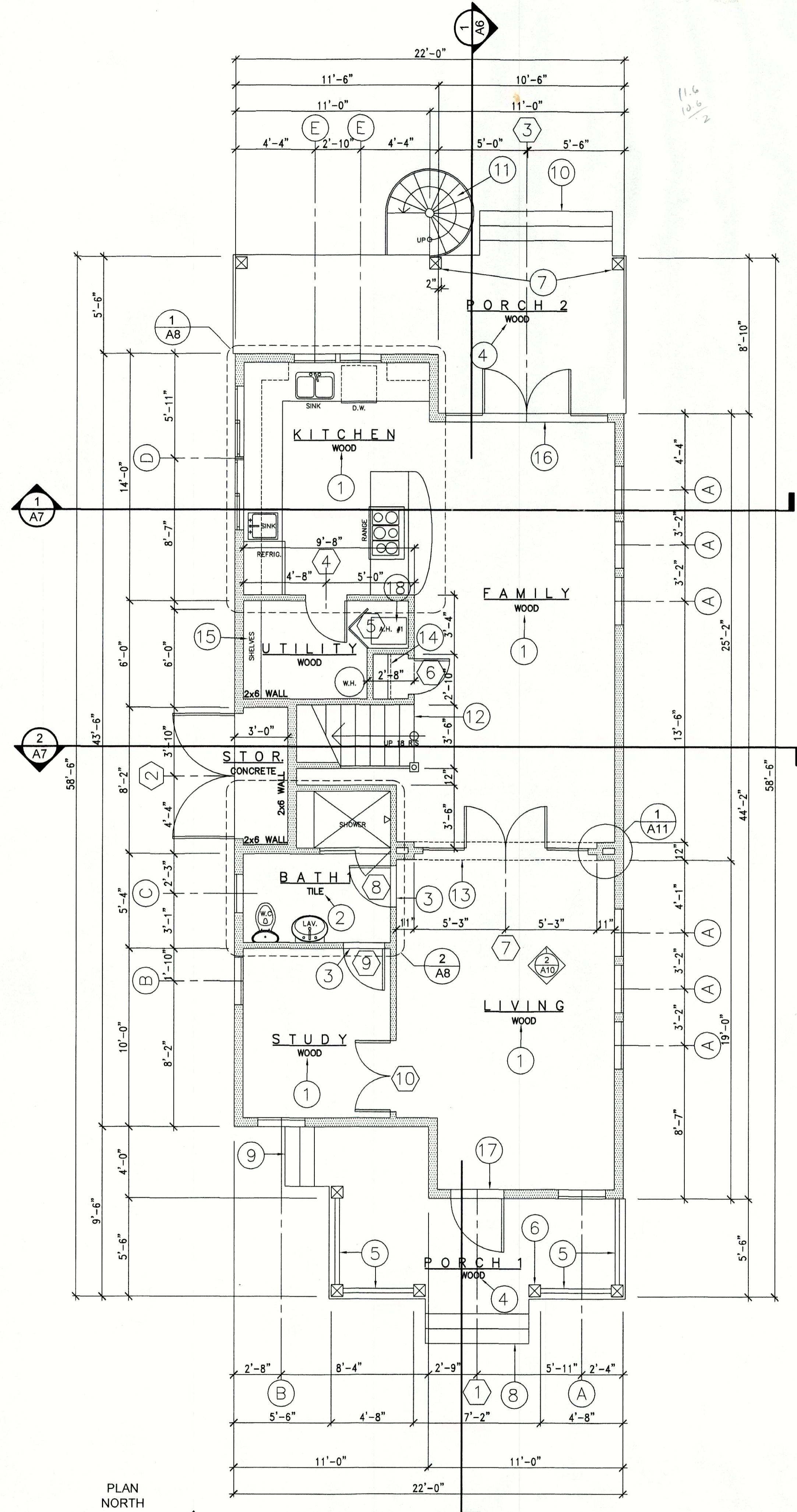

**LOWER LEVEL PLAN**  
1/4" = 1'-0"

REVISIONS	
NO.	DATE

**UNIT A**

DATE OF ISSUE:

**LOWER LEVEL PLAN AND NOTES**

TWO NEW RESIDENCES FOR:

**1321 SOUTH STREET**

KEY WEST, FLORIDA

DAVID KNOWLTON ARCHITECT

KEY WEST, FL. (305) 715-8617

SHEET

**A1**

OF 37 SHEETS

**UPPER LEVEL PLAN NOTES**

1. 1X6 T&G HARDWOOD FLOORING ON P.T. 3/4" CDX T&G PLYWOOD SUBFLOOR GLUED AND SCREWED TO JOISTS
2. TILE FLOOR FINISH ON 1/2" TILE BACKER BOARD ON P.T. 3/4" CDX PLYWOOD SUBFLOOR GLUED AND SCREWED TO JOISTS
3. HARDWOOD SADDLE AT FLOOR FINISH TRANSITION
4. 1X6 COMPOSITE BALCONY FLOORING
5. MINIMUM 36" HIGH WOOD RAILING - SEE DETAIL 1/A4
6. P.T. 8X8 COLUMN WITH 1/2" CHAMFERED EDGES, TYPICAL OF 5 LOCATIONS AT BALCONY 1 - SEE DETAIL 1/A4
7. P.T. 8X8 COLUMN WITH 1/2" CHAMFERED EDGES, TYPICAL OF 2 LOCATIONS AT BALCONY 2 - SEE DETAIL 1/A4
8. P.T. 2X4 FRAMED PARTITION BETWEEN COUNTERTOP AND TUB PLATFORM - FINISHED TILE TOP OF PARTITION 42" A.F.F.
9. CLOTHES ROD AND 14" SHELF AT 5'-6" A.F.F.
10. STAIR TO HAVE HARDWOOD TREADS, RISERS AND HANDRAIL WITH (3) P.T. 2X12 STRINGERS
11. DASHED LINE INDICATES GABLE ROOFLINES ABOVE
12. 36" HIGH GUARD RAIL PER CODE TO MATCH STAIR HANDRAIL
13. DASHED LINE INDICATES LINE OF DROPPED CEILING AT 8'-0" A.F.F.
14. DASHED AREA INDICATES CEILING AT 8'-0" A.F.F. WITH ATTIC FLOOR ABOVE
15. DASHED AREA INDICATES CEILING AT 9'-0" A.F.F. WITH ROOF AND DECK ABOVE
16. MEDICINE CABINET
17. ATTIC STAIR
18. 5'-0" DIAMETER POWDER COATED ALUMINUM SPIRAL STAIR BY OTHERS
19. METAL THRESHOLD

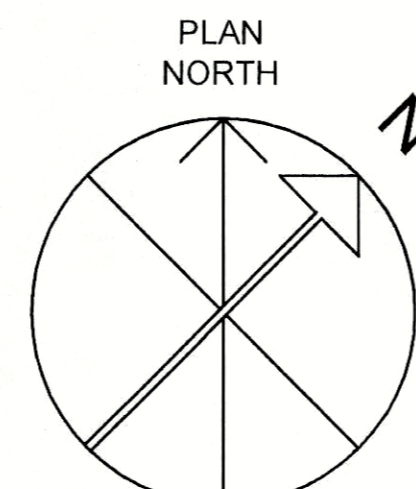
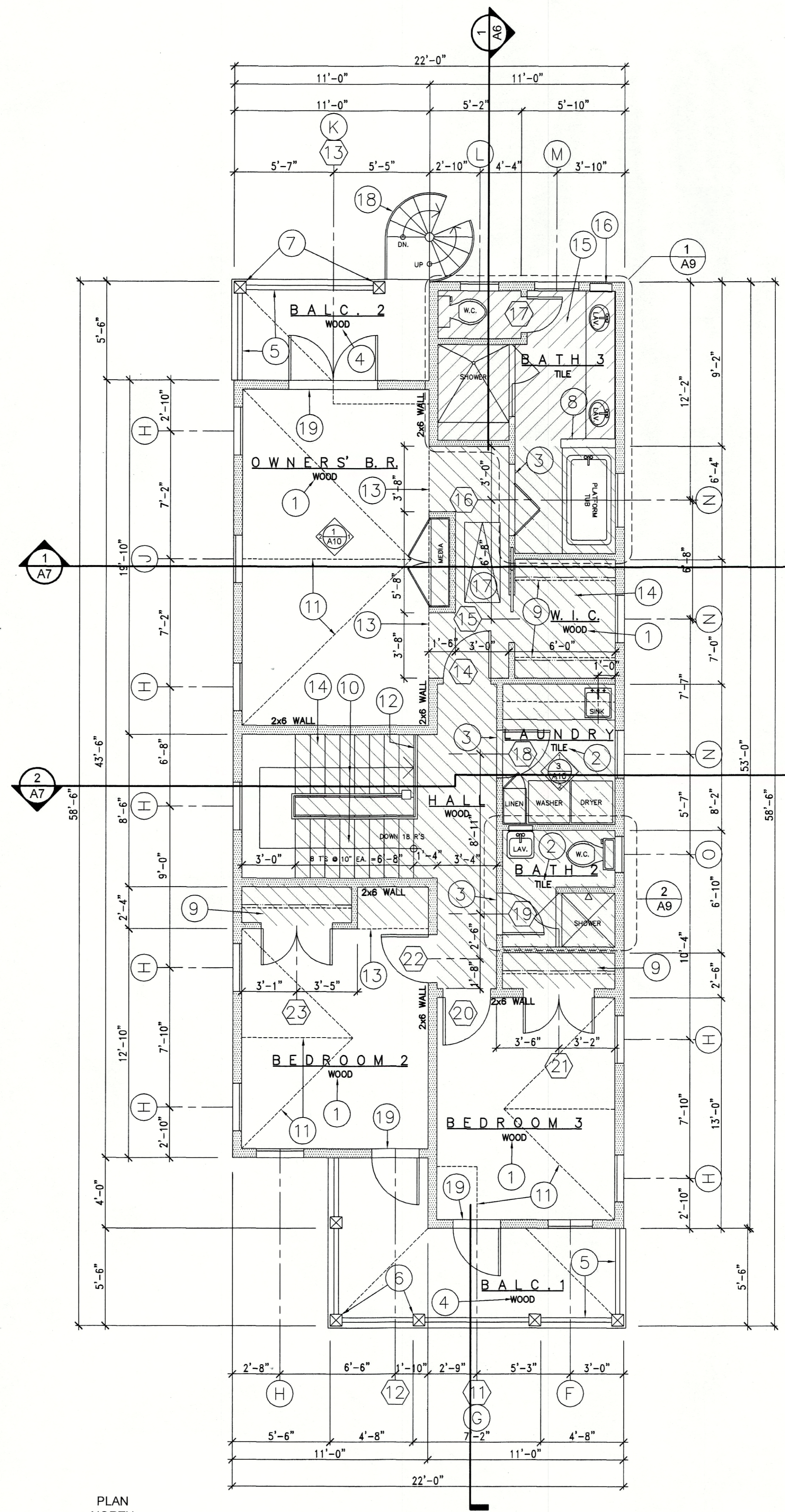

**UPPER LEVEL PLAN**

1/4" = 1'-0"

REVISIONS	
NO.	DATE

**UNIT A**

UPPER LEVEL PLAN AND NOTES

DATE OF ISSUE:

TWO NEW RESIDENCES FOR:

# 1321 SOUTH STREET

KEY WEST, FLORIDA

---

DAVID KNOWLTON ARCHITECT

KEY WEST, FL. (305) 715-8617

SHEET

A2

OF 37 SHEETS



REVISIONS	
NO.	DATE

TWO NEW RESIDENCES FOR:  
**1321 SOUTH STREET**  
 KEY WEST, FLORIDA

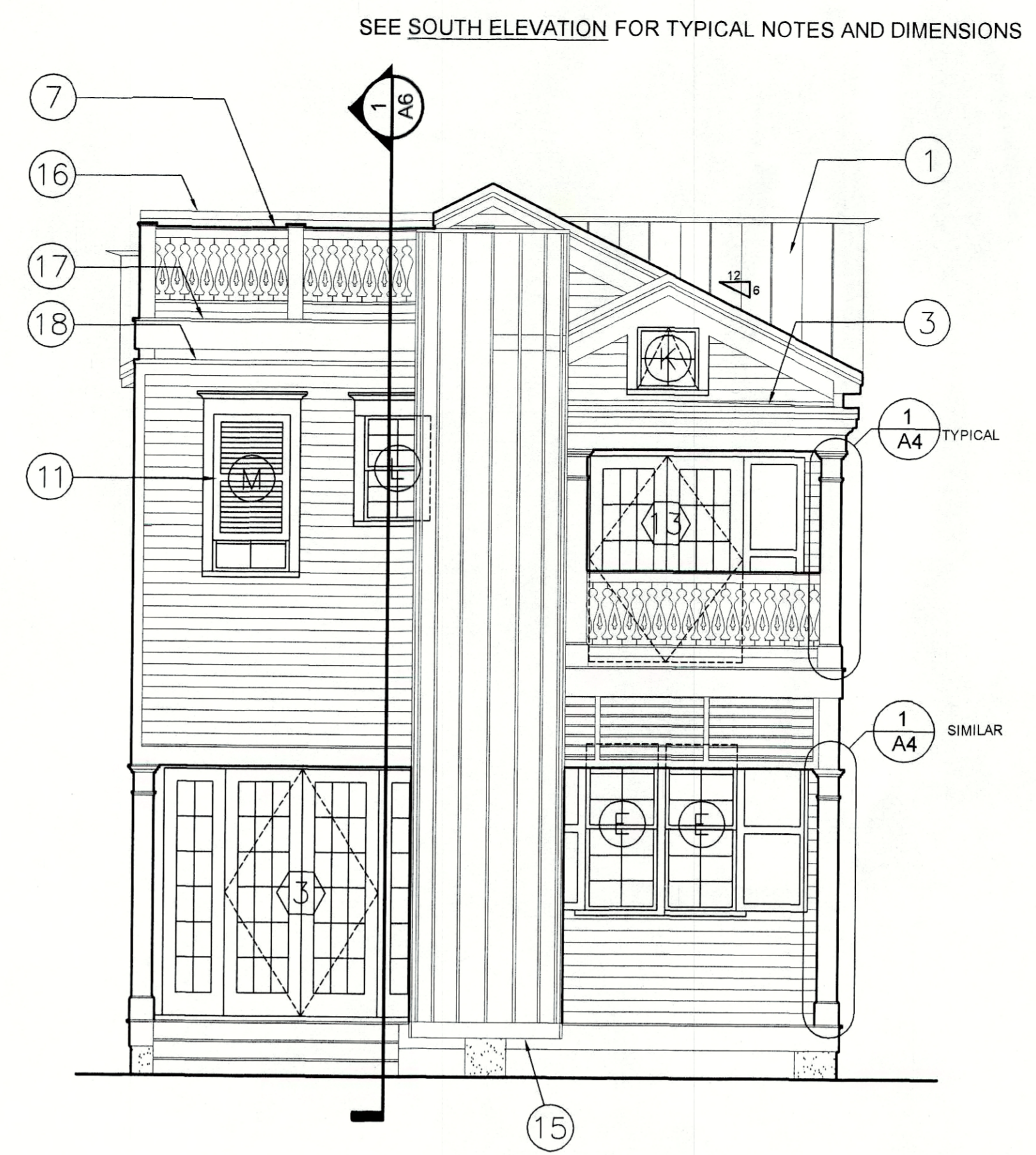

NORTH ELEVATION

**BUILDING ELEVATIONS NOTES**

1. V-CRIMP METAL ROOFING AT UPPER ROOF
2. GALVANIZED METAL DRIP FLASHING, FLASHING TRIM, FASCIA AND GABLE RAKE TRIM - SEE DETAIL 1 / A3
3. SINGLE-PLY ROOFING AND FLASHING SYSTEM AT LOWER ROOF
4. 1/2" X 5/8" HARDBOARD LAPPED SIDING WITH 4/8" EXPOSURE
5. DECORATIVE LOUVER SHUTTER
6. HARDBOARD 1X4 CORNER TRIM WITH P.T. 1/2" CDX PLYWOOD BLOCK BEHIND
7. 36" HIGH RAILING - SEE DETAIL 1 / A4
8. CONTINUOUS P.T. 8 X 8 WOOD COLUMN - SEE DETAIL 1 / A4
9. BALCONY BEAM WITH HARDBOARD 1X WRAP - SEE DETAIL 1 / A6
10. LOUVERED SUN SCREEN - SEE DETAIL 1 / A6
11. DECORATIVE BERMUDA SHUTTER
12. REINFORCED CONCRETE PIER
13. STEPS WITH P.T. 5/4 WOOD RISERS AND TREADS, P.T. 1X12 STRINGERS AND P.T. 1X12 FINISHED SKIRT
14. PORCH BEAM WITH HARDBOARD 4X12 SKIRT
15. 5'-0" DIAMETER POWDER COATED ALUMINUM SPIRAL STAIR AND LANDING BY OTHERS
16. PARAPET WALL WITH GALVANIZED METAL CAP FLASHING AND HARDBOARD 1X FINISH TRIM - TOP OF WALL 14'-6" ABOVE UPPER LEVEL SUBFLOOR
17. 6/4 X 6 TROPICAL HARDWOOD DECKING GAPPED 1/4" - SEE DETAIL 3 / A6
18. SINGLE-PLY ROOFING AND FLASHING SYSTEM AT ROOF BELOW DECK FRAMING

COMPOSITE

SEE SOUTH ELEVATION FOR TYPICAL NOTES AND DIMENSIONS



EAST ELEVATION

**BUILDING ELEVATIONS**  
 1/4" = 1' - 0"

**UNIT A**  
 BUILDING ELEVATIONS AND NOTES

DAVID KNOWLTON  
 ARCHITECT  
 KEY WEST, FL. (305) 715-8617

SHEET  
**A5**  
 OF 37 SHEETS

DATE OF ISSUE:

**LOWER LEVEL PLAN NOTES**

1. 1X6 T&G HARDWOOD FLOORING ON P.T. 3/4" CDX T&G PLYWOOD SUBFLOOR GLUED AND SCREWED TO JOISTS
2. TILE FLOOR FINISH ON 1/2" TILE BACKER BOARD ON P.T. 3/4" CDX T&G PLYWOOD SUBFLOOR GLUED AND SCREWED TO JOISTS
3. HARDWOOD SADDLE AT FLOOR FINISH TRANSITION
4. 1X6 COMPOSITE PORCH FLOORING
5. MINIMUM 36" HIGH WOOD RAILING - SEE DETAIL 1/A15
6. P.T. 8X8 COLUMN WITH 1/2" CHAMFERED EDGES, TYPICAL OF 5 LOCATIONS AT PORCH 1 - SEE DETAIL 1/A15
7. P.T. 8X8 COLUMN WITH 1/2" CHAMFERED EDGES, TYPICAL OF 3 LOCATIONS AT PORCH 2 - SEE DETAIL 1/A15
8. STEPS WITH 1X6 COMPOSITE PORCH FLOORING ON (4) P.T. 2X12 STRINGERS
9. STEPS WITH 1X6 COMPOSITE PORCH FLOORING ON (3) P.T. 2X12 STRINGERS
10. STEPS WITH 1X6 COMPOSITE PORCH FLOORING ON (5) P.T. 2X12 STRINGERS
11. 5'-0" DIAMETER POWDER COATED ALUMINUM SPIRAL STAIR BY OTHERS
12. STAIR TO HAVE HARDWOOD TREADS, RISERS AND HANDRAIL WITH (3) P.T. 2X12 STRINGERS
13. BULKHEAD ABOVE - SEE 2/A22
14. CLOTHES ROD AND 14" SHELF AT 5'-6" A.F.F.
15. (6) 12" ADJUSTABLE SHELVES WITH BRACKETS AND (4) STANDARDS
16. METAL THRESHOLD
17. WOOD THRESHOLD
18. AIR HANDLER

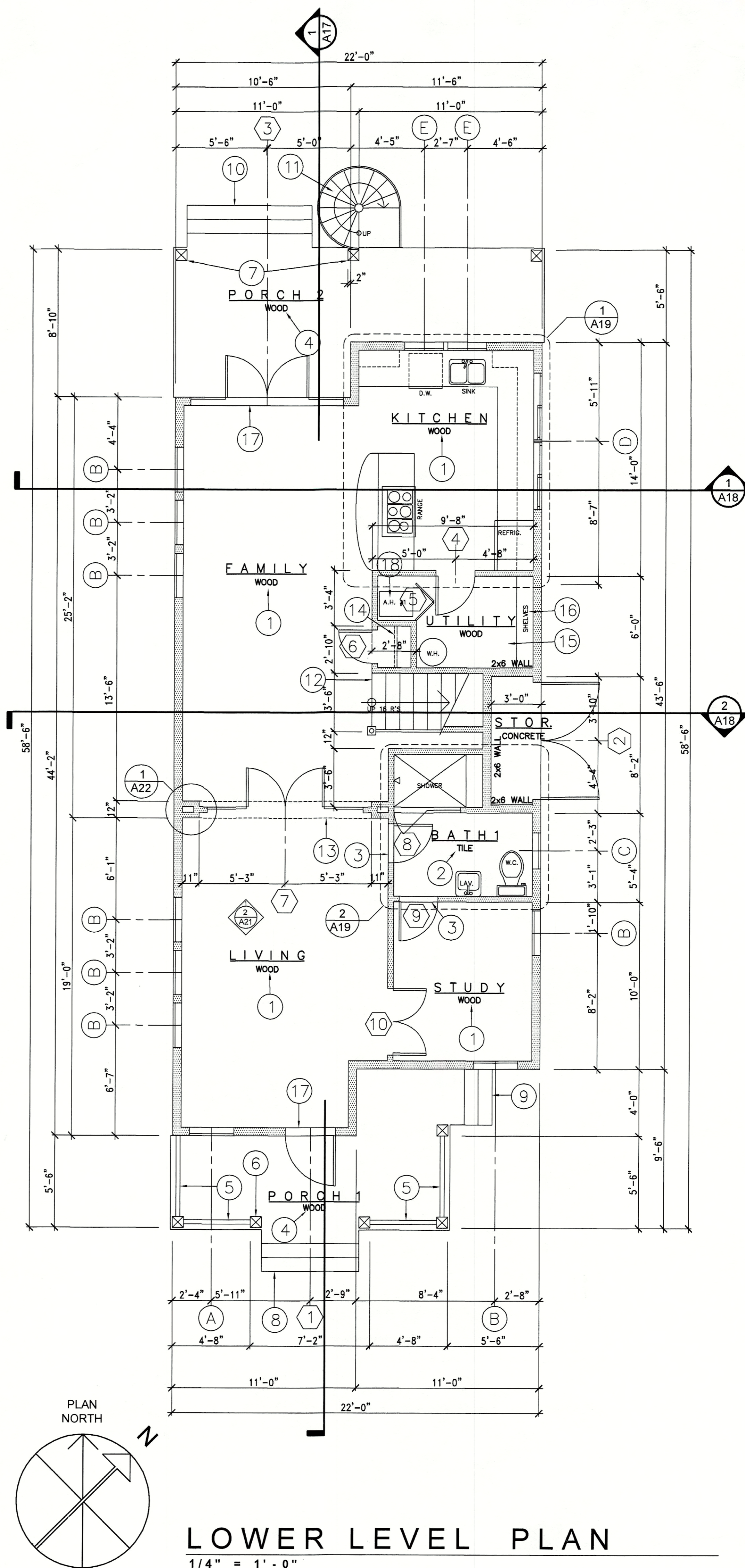

**LOWER LEVEL PLAN**

1/4" = 1'-0"

REVISIONS	
NO.	DATE

**UNIT B**

DATE OF ISSUE:

**LOWER LEVEL PLAN AND NOTES**

TWO NEW RESIDENCES FOR:  
**1321 SOUTH STREET**  
 KEY WEST, FLORIDA

DAVID KNOLL  
 ARCHITECT  
 KEY WEST, FL. (305) 715-8617

**A12**

SHEET

OF 37 SHEETS

UPPER LEVEL PLAN NOTES

1. 1X6 T&G HARDWOOD FLOORING ON P.T. 3/4" CDX T&G PLYWOOD SUBFLOOR GLUED AND SCREWED TO JOISTS
2. TILE FLOOR FINISH ON 1/2" TILE BACKER BOARD ON P.T. 3/4" CDX PLYWOOD SUBFLOOR GLUED AND SCREWED TO JOISTS
3. HARDWOOD SADDLE AT FLOOR FINISH TRANSITION
4. 1X6 COMPOSITE BALCONY FLOORING
5. MINIMUM 36" HIGH WOOD RAILING - SEE DETAIL 1 / A15
6. P.T. 8X8 COLUMN WITH 1/2" CHAMFERED EDGES, TYPICAL OF 5 LOCATIONS AT BALCONY 1 - SEE DETAIL 1 / A15
7. P.T. 8X8 COLUMN WITH 1/2" CHAMFERED EDGES, TYPICAL OF 2 LOCATIONS AT BALCONY 2 - SEE DETAIL 1 / A15
8. P.T. 2X4 FRAMED PARTITION BETWEEN COUNTERTOP AND TUB PLATFORM - FINISHED TILE TOP OF PARTITION 42" A.F.F.
9. CLOTHES ROD AND 14" SHELF AT 9'-6" A.F.F.
10. STAIR TO HAVE HARDWOOD TREADS, RISERS AND HANDRAIL WITH (3) P.T. 2X12 STRINGERS
11. DASHED LINE INDICATES GABLE ROOFLINES ABOVE
12. 36" HIGH GUARD RAIL PER CODE TO MATCH STAIR HANDRAIL
13. DASHED LINE INDICATES LINE OF DROPPED CEILING AT 8'-0" A.F.F.
14. DASHED AREA INDICATES CEILING AT 8'-0" A.F.F. WITH ATTIC FLOOR ABOVE
15. DASHED AREA INDICATES CEILING AT 9'-0" A.F.F. WITH ROOF AND DECK ABOVE
16. MEDICINE CABINET
17. ATTIC STAIR
18. 5'-0" DIAMETER POWDER COATED ALUMINUM SPIRAL STAIR BY OTHERS
19. METAL THRESHOLD

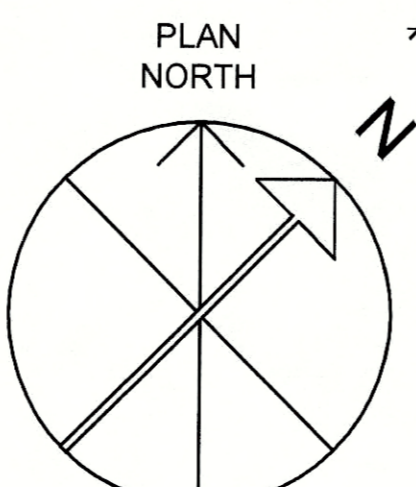
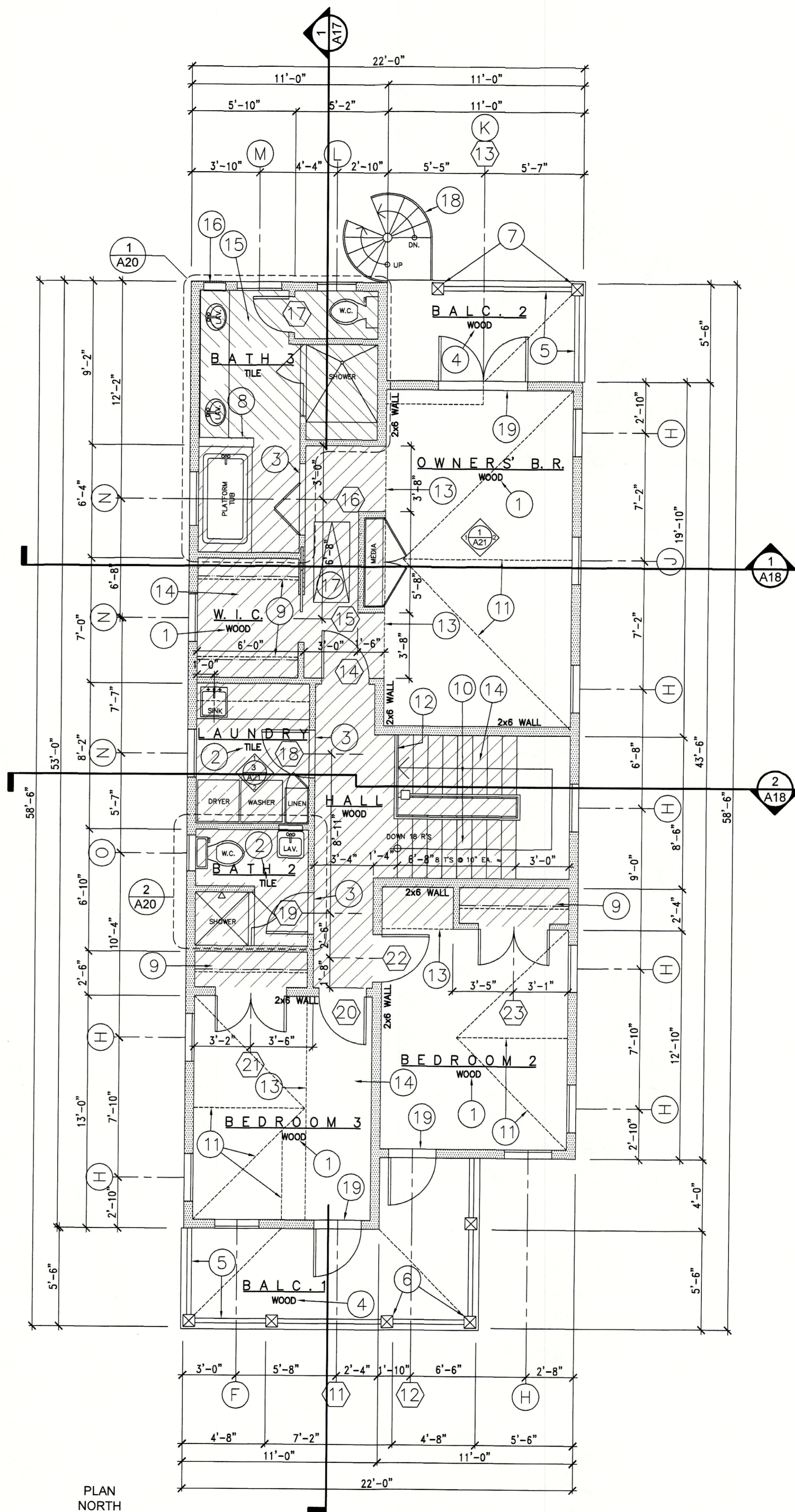

UPPER LEVEL PLAN  
1/4" = 1'-0"

REVISIONS	
NO.	DATE

UNIT B

UPPER LEVEL PLAN AND NOTES

DATE OF ISSUE:

TWO NEW RESIDENCES FOR:

# 1321 SOUTH STREET

KEY WEST, FLORIDA

---

DAVID KNOLL  
ARCHITECT  
KEY WEST, FL (305) 715-8611

A13

SHEET  
OF 37 SHEETS

**DETAILS NOTES**

1. CAPITAL MOULDING
2. TRIM MOULDING
3. P.T. 8X8 COLUMN WITH 1/2" CHAMFERED EDGES
4. BASE TRIM MOULDING
5. P.T. 1X BASE TRIM
6. RAILING TOP RAIL FROM P.T. 2X4
7. P.T. 1X4 RAIL SKIRT
8. P.T. 2X2 BALUSTER
9. P.T. NAILER FROM 1X4 RIPPED TO 2" WIDE
10. P.T. 2X4 BOTTOM RAIL

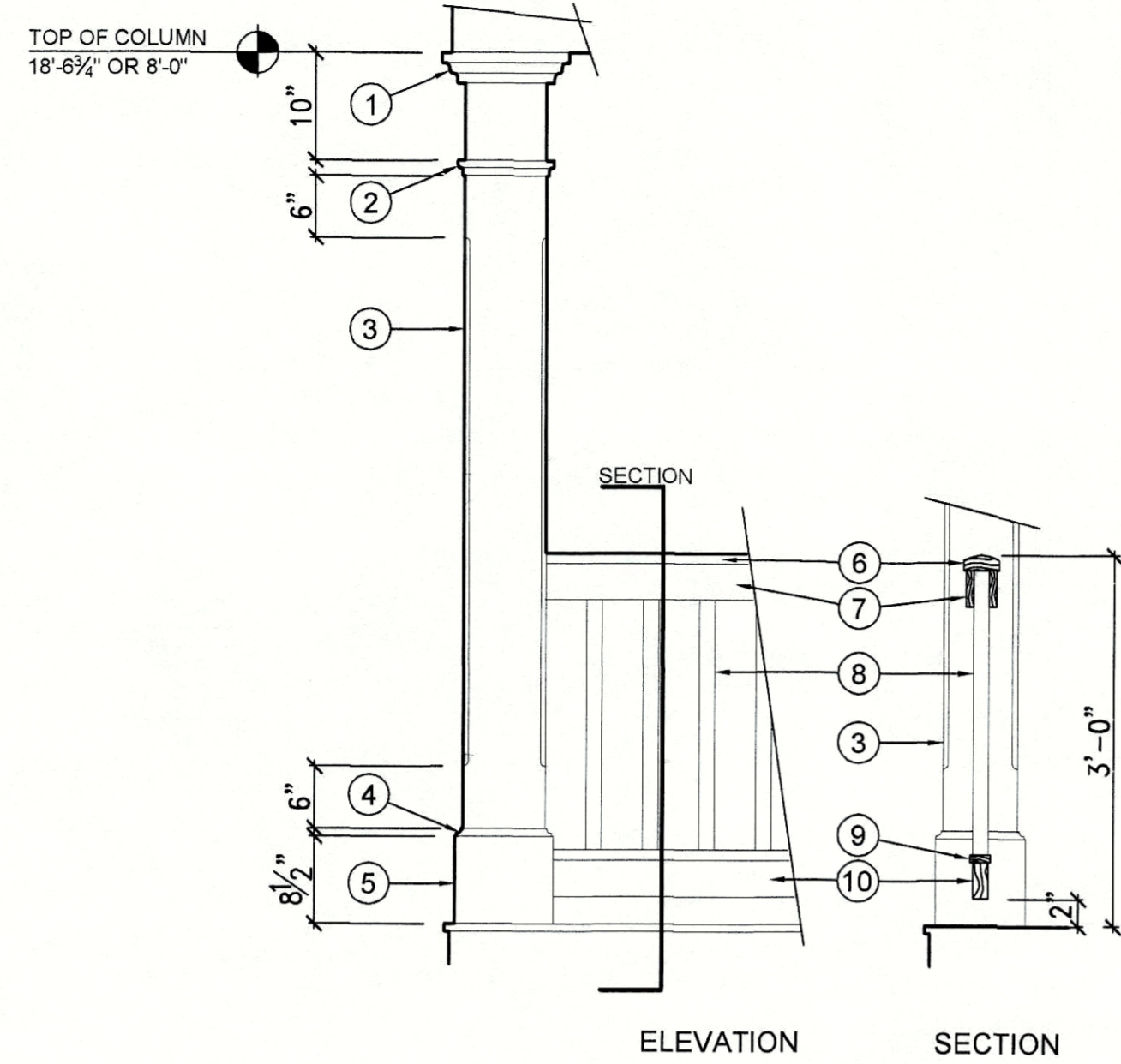

**1**  
**A15** 3/4" = 1' - 0"

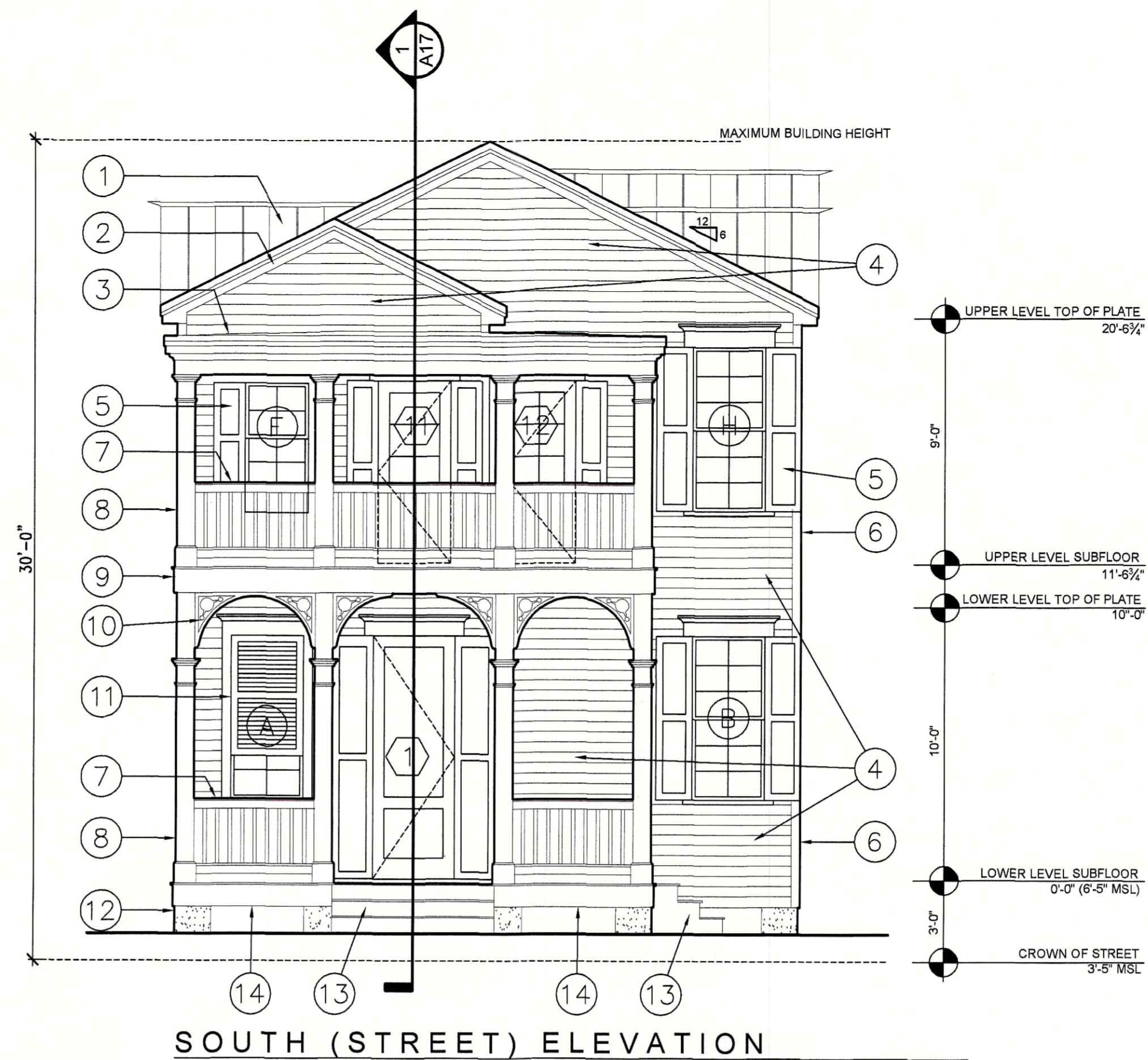

**1**  
**A17** SOUTH (STREET) ELEVATION

**BUILDING ELEVATIONS NOTES**

1. V-CRIMP METAL ROOFING AT UPPER ROOF
2. GALVANIZED METAL DRIP FLASHING, FLASHING TRIM, FASCIA AND GABLE RAKE TRIM - SEE DETAIL 1/A14
3. SINGLE-PLY ROOFING AND FLASHING SYSTEM AT LOWER ROOF
4. 1/2" X 5/2" HARDIBOARD LAPPED SIDING WITH 4 1/2" EXPOSURE
5. DECORATIVE LOUVER SHUTTER
6. HARDIBOARD 1X4 CORNER TRIM WITH P.T. 1/2" CDX PLYWOOD BLOCK BEHIND
7. 36" HIGH RAILING - SEE DETAIL 1/A15
8. CONTINUOUS P.T. 8 X 8 WOOD COLUMN - SEE DETAIL 1/A15
9. BALCONY BEAM WITH HARDIBOARD 1X WRAP - SEE DETAIL 1/A17
10. ARCH GRILLE - SEE SPECIFICATIONS
11. DECORATIVE BERMUDA SHUTTER
12. REINFORCED CONCRETE PIER
13. STEPS WITH P.T. 5/4 WOOD RISERS AND TREADS, P.T. 1X12 STRINGERS AND P.T. 1X12 FINISHED SKIRT
14. PORCH BEAM WITH HARDIBOARD 1X12 SKIRT
15. 5'-0" DIAMETER POWDER COATED ALUMINUM SPIRAL STAIR AND LANDING BY OTHERS
16. PARAPET WALL WITH GALVANIZED METAL CAP FLASHING AND HARDIBOARD 1X FINISH TRIM - TOP OF WALL 14'-6" ABOVE UPPER LEVEL SUBFLOOR
17. 5/4 X 6 TROPICAL HARDWOOD DECKING GAPPED 1/2" - SEE DETAIL 3/A17
18. SINGLE-PLY ROOFING AND FLASHING SYSTEM AT ROOF BELOW DECK FRAMING



**1**  
**A18** WEST ELEVATION

**BUILDING ELEVATIONS**

1/4" = 1' - 0"

REVISIONS	
NO.	DATE

**UNIT B**

**BUILDING ELEVATIONS, DETAILS AND NOTES**

DATE OF ISSUE:

TWO NEW RESIDENCES FOR:  
**1321 SOUTH STREET**  
KEY WEST, FLORIDA

DAVID KNOWLTON  
ARCHITECT  
KEY WEST, FL (305) 715-8617

SHEET  
**A15**  
OF 37 SHEETS





# NOTICING

# Public Meeting Notice

The Historic Architectural Review Commission will hold a public hearing at 5:30 p.m., January 27, 2015 at Old City Hall, 510 Greene Street, Key West, Florida. The purpose of the hearing will be to consider a request for:

## **TWO NEW TWO STORY BUILDINGS. DEMOLITION OF HISTORIC DUPLEX.**

**FOR- # 1321 SOUTH STREET**

**Applicant- Meridian Engineering**

**Application # H15-01-0006**

If you wish to see the application or have any questions, you may visit the Planning Department during regular office hours at 3140 Flagler Avenue, call 809-3973 or visit our website at [www.cityofkeywest-fl.gov](http://www.cityofkeywest-fl.gov).

**THIS NOTICE CAN NOT BE REMOVED FROM THE SITE UNTIL HARC FINAL DETERMINATION**

# HARC POSTING AFFIDAVIT

STATE OF FLORIDA:  
COUNTY OF MONROE:

**BEFORE ME**, the undersigned authority, personally appeared Richard J. Milelli, who, first being duly sworn, on oath, depose and says that the following statements are true and correct to the best of his/her knowledge and belief:

1. That a legal notice for Public Notice of Hearing of the Historic Architectural Review Commission (HARC) was placed on the following address: 1321 South St on the 22 day of January, 2015.

This legal notice(s) contained an area of at least 8.5"x11".

The property was posted to notice a public hearing before the Key West Historic Architectural Review Commission to be held on January 27, 2015.

The legal notice(s) is/are clearly visible from the public street adjacent to the property.

The Certificate of Appropriateness number for this legal notice is H-15-01-0006.

2. A photograph of that legal notice posted in the property is attached hereto.

## Signed Name of Affiant:

[Signature]  
Date: 1/23/15  
Address: 201 Front St. Ste 203  
City: Key West  
State, Zip: FL 33040

The forgoing instrument was acknowledged before me on this 23<sup>rd</sup> day of January, 2015.

By (Print name of Affiant) Richard Milelli who is personally known to me or has produced \_\_\_\_\_ as identification and who did take an oath.

## NOTARY PUBLIC

Sign Name: [Signature]  
Print Name: Nancy Aspinwall  
Notary Public - State of Florida (seal)  
My Commission Expires: \_\_\_\_\_



# PROPERTY APPRAISER INFORMATION

PC Code: 08 - MULTI FAMILY LESS THAN 10UNITS

Millage Group: 10KW

Affordable Housing: No

Section-Township-Range: 05-68-25

Property Location: 1321 SOUTH ST KEY WEST

Subdivision: Tropical Building and Investment Co

Legal Description: KW TROPICAL BLDG AND INVESTMENT CO SUB PT LOT 6-7-8 SQR 7 TRTR 19 PB 1-34 G12-183/184 OR406-309/310 OR1018-1840D/C OR776-1912 OR1013-698 OR1024-1820/1821-C OR1024-1823 OR1203-72/73 OR2289-1417

**Click Map Image to open interactive viewer**

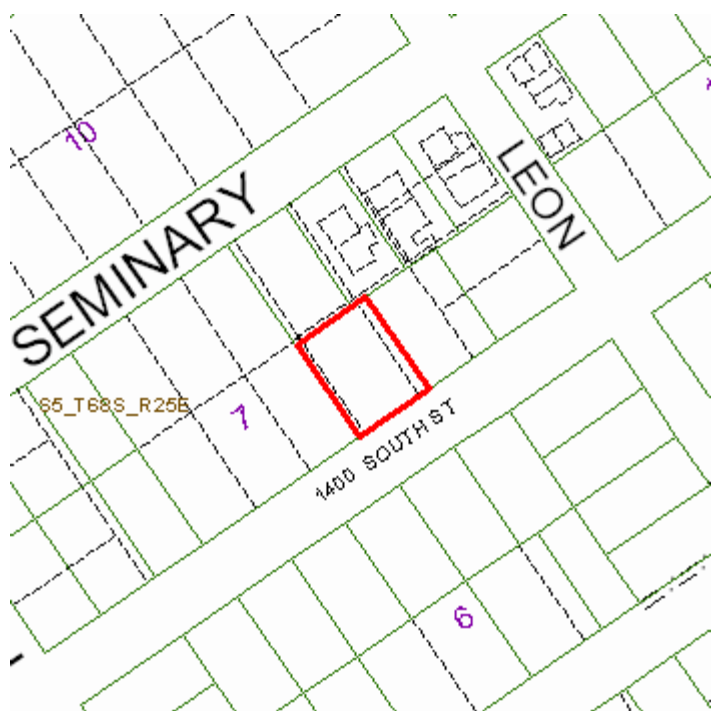

**Land Details**

Land Use Code	Frontage	Depth	Land Area
010D - RESIDENTIAL DRY	68	90	6,120.00 SF

**Building Summary**

Number of Buildings: 1  
 Number of Commercial Buildings: 0  
 Total Living Area: 1912  
 Year Built: 1943

### Building 1 Details

Building Type	R2	Condition	A	Quality Grade	450
Effective Age	22	Perimeter	264	Depreciation %	30
Year Built	1943	Special Arch	0	Grnd Floor Area	1,912
Functional Obs	0	Economic Obs	0		

Inclusions: R2 includes 2 3-fixture baths and 2 kitchens.

Roof Type	GABLE/HIP	Roof Cover	ASPHALT SHINGL	Foundation	CONCR FTR
Heat 1	FCD/AIR DUCTED	Heat 2	NONE	Bedrooms	4
Heat Src 1	ELECTRIC	Heat Src 2	NONE		

Extra Features:

2 Fix Bath	2	Vacuum	0
3 Fix Bath	0	Garbage Disposal	0
4 Fix Bath	0	Compactor	0
5 Fix Bath	0	Security	0
6 Fix Bath	0	Intercom	0
7 Fix Bath	0	Fireplaces	0
Extra Fix	0	Dishwasher	0

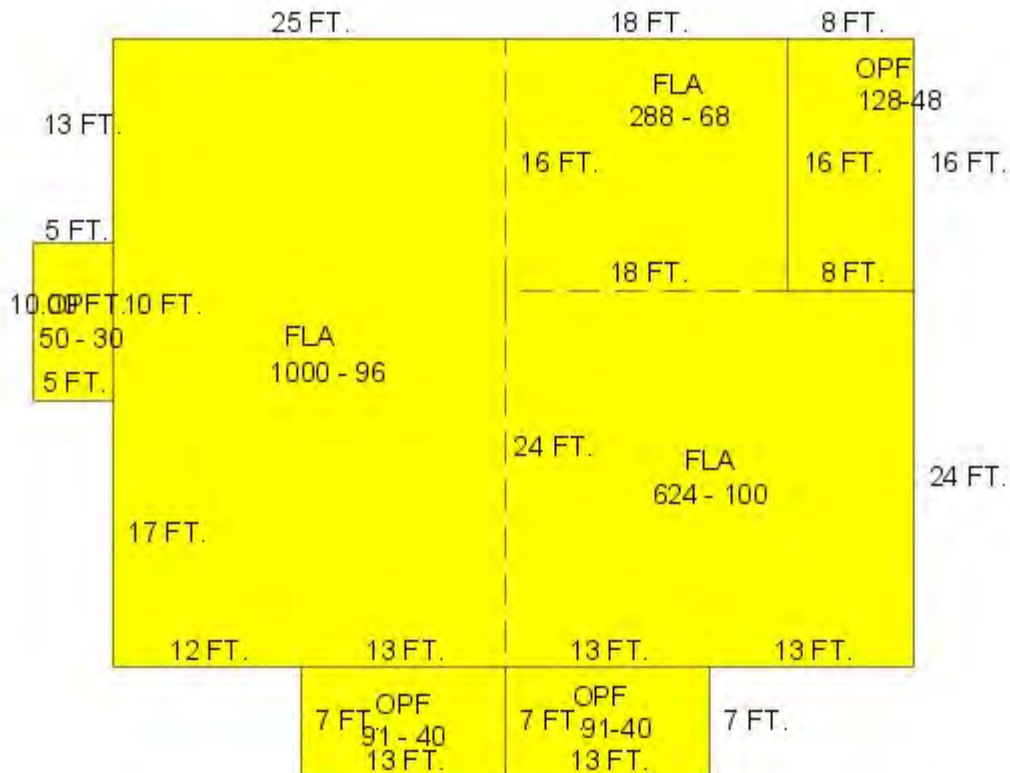

## Sections:

Nbr	Type	Ext Wall	# Stories	Year Built	Attic	A/C	Basement %	Finished Basement %	Area
0	OPF		1	2000					91
0	FLA	3:WD FR STUCCO	1	2000		Y			288
1	FLA	3:WD FR STUCCO	1	1992	N	Y	0.00	0.00	1,000
4	OPF		1	1968			0.00	0.00	91
7	OPF		1	2000			0.00	0.00	128
9	OPF		1	2000					50
11	FLA	3:WD FR STUCCO	1	1992	N	Y	0.00	0.00	624

## Misc Improvement Details

Nbr	Type	# Units	Length	Width	Year Built	Roll Year	Grade	Life
4	FN2:FENCES	136 SF	34	4	1995	1996	2	30
5	UB3:LC UTIL BLDG	96 SF	8	12	2000	2001	2	30
6	FN2:FENCES	176 SF	4	44	1968	1969	5	30
7	FN2:FENCES	300 SF	6	50	2000	2001	2	30
8	PT5:TILE PATIO	677 SF	0	0	1968	1969	3	50
9	PT4:PATIO	143 SF	13	11	1968	1969	4	50
10	PT3:PATIO	892 SF	0	0	1968	1969	2	50
11	PT3:PATIO	50 SF	0	0	2000	2001	2	50
12	PT3:PATIO	534 SF	0	0	1968	1969	2	50

## Appraiser Notes

2005 JUNE 06: THIS PARCEL IS BEYOND #1409 AND HAS 2 UNITS - BKC
---

## Building Permits

Bldg Number	Date Issued	Date Completed	Amount	Description	Notes	
09-1352	05/11/2009	06/19/2009	2,350	Residential	PATCH 3. TAB SHINGLES, WHITE COAT	
11-0478	02/16/2011	06/22/2011	3,450	Residential	INSTALL 600 SQ FT OF 3 TAB ASPHALT SHINGLE ROOFING AS PER HARC	
13-4791	11/07/2013	03/24/2014	2,435	Residential	INSTALL 400 SQ FT OF WHITE 3 TAG ASPHALT SHINGLES	
1	96-1295	03/01/1996	08/01/1996	100	Residential	FENCE
2	99-0901	08/12/1999	12/29/2000	1	Residential	ADDITION 16X16 ON REAR
3	04-0701	03/23/2004	10/25/2004	1,800	Residential	R&R 4-TON A/C
4	07-2340	05/15/2007	02/18/2008	75	Residential	ELECTRICAL DEMOLITION
5	07-2341	05/15/2007	02/18/2008	450	Residential	INSTALL TEMPORARY SERVICE
6	07-2388	05/16/2007	02/18/2008	500	Residential	DEMO PLUMBING
7	08-0170	02/01/2008	02/18/2008	1,800	Residential	REPLACE 4 DOORS & PAINT INTERIOR
8	08-0171	02/01/2008	02/18/2008	8,000	Residential	RENTAL UNIT, PAINT EXT., & INTERIOR OF UNIT, REPLACE KITCHEN CABINETS



**Parcel Value History**

Certified Roll Values.

[View Taxes for this Parcel.](#)

<b>Roll Year</b>	<b>Total Bldg Value</b>	<b>Total Misc Improvement Value</b>	<b>Total Land Value</b>	<b>Total Just (Market) Value</b>	<b>Total Assessed Value</b>	<b>School Exempt Value</b>	<b>School Taxable Value</b>
2014	164,432	9,784	117,056	291,272	291,272	0	291,272
2013	166,549	9,853	117,056	293,458	293,458	0	293,458
2012	169,000	9,928	117,056	295,984	295,984	0	295,984
2011	171,283	10,012	100,334	281,629	281,629	0	281,629
2010	175,851	10,080	89,186	275,117	275,117	0	275,117
2009	198,405	10,154	211,816	420,375	420,375	0	420,375
2008	186,670	10,239	244,800	441,709	441,709	0	441,709
2007	253,784	6,484	428,400	688,668	688,668	0	688,668
2006	312,885	6,550	459,000	653,281	653,281	0	653,281
2005	312,885	6,626	336,600	656,111	656,111	0	656,111
2004	208,619	6,687	286,110	501,416	501,416	0	501,416
2003	209,580	6,754	140,760	357,094	357,094	0	357,094
2002	148,842	6,830	140,760	296,432	296,432	0	296,432
2001	168,093	6,890	93,636	268,619	268,619	0	268,619
2000	152,355	3,532	84,150	240,038	240,038	0	240,038
1999	128,769	3,322	84,150	216,241	216,241	0	216,241
1998	86,957	2,847	84,150	173,955	173,955	0	173,955
1997	75,206	2,552	71,910	149,668	149,668	0	149,668
1996	60,433	1,989	71,910	134,331	134,331	0	134,331
1995	55,061	1,873	71,910	128,844	128,844	0	128,844
1994	49,241	1,730	71,910	122,882	122,882	0	122,882
1993	49,241	1,784	71,910	122,936	122,936	0	122,936
1992	62,504	0	71,910	134,414	134,414	0	134,414
1991	62,504	0	71,910	134,414	134,414	0	134,414
1990	62,504	0	58,140	120,644	120,644	0	120,644
1989	56,822	0	56,610	113,432	113,432	0	113,432
1988	34,713	0	52,020	86,733	86,733	0	86,733
1987	27,929	0	30,429	58,358	58,358	0	58,358
1986	28,056	0	29,082	57,138	57,138	0	57,138
1985	27,351	0	22,950	50,301	50,301	0	50,301
1984	25,445	0	22,950	48,395	48,395	0	48,395
1983	25,462	0	22,950	48,412	48,412	0	48,412
1982	26,020	0	17,962	43,982	43,982	21,991	21,991

**Parcel Sales History**

NOTE: Sales do not generally show up in our computer system until about two to three months after the date of sale. If a recent sale does not show up in this list, please allow more time for the sale record to be processed. Thank you for your patience and understanding.

<b>Sale Date</b>	<b>Official Records Book/Page</b>	<b>Price</b>	<b>Instrument</b>	<b>Qualification</b>
<b>4/16/2007</b>	2289 / 1417	535,000	WD	Q
<b>2/1/1992</b>	1203 / 72	132,000	WD	Q
<b>8/1/1987</b>	1024 / 1823	95,000	WD	Q

This page has been visited 393,753 times.

Monroe County Monroe County Property Appraiser  
Scott P. Russell, CFA  
P.O. Box 1176 Key West, FL 33041-1176