



Historic Architectural Review Commission Staff Report for Item 3

To: Chairman Bryan Green and Historic Architectural Review Commission Members

From: Kathleen McDonald, MHP
Historic Preservation Planner II

Meeting Date: September 28, 2021 – **Second Reading**
August 24, 2021 – **First Reading**

Applicant: Erica Poole

Address: #643 William Street

Description of Work:

Demolition of non-historic wood frame shed. Removal of wall of historic rear addition.

Site Facts:

The site under review is located at 643 William Street. According to our survey, the eyebrow house on site is historic and contributing, with a year built circa 1880. There are several additions at the rear of the historic structure, some of which are also historic. The historic one-story gable addition in the middle appears on Sanborn maps as far back as 1892. A large, shed roof addition on the South side of the house appears on the 1948 and 1962 Sanborn maps. The other additions at the rear are all non-historic, including a small frame shed, which this project proposes for demolition.

Ordinances Cited on Review:

- Section 102-217 (4), demolition for historic or contributing structures of the Land Development Regulations.
- Section 102-218, Criteria for demolitions.

Staff Analysis:

The Certificate of Appropriateness under review proposes the demolition of an existing non-historic wood frame shed at the rear of the house at 643 William Street. The demolition would also include the removal of a wall of a historic addition, which extends from the rear center of the house. The proposed demolition would allow for the construction of a new one-story shed roof addition. The design of the shed roof addition was approved at the HARC meeting on August 24th, along with the first reading of demolition.

It is staff's opinion that the request for the demolition of the wall of the historic rear addition shall be based on the demolition criteria of Chapter 102 Section 218(a) of the LDR's. The criteria state the following;

a) *The historic architectural review commission shall issue a certificate of appropriateness for an application for demolition:*

- (1) *If the subject of the application is a contributing or historic building or structure, then it should not be demolished unless its condition is irrevocably compromised by extreme deterioration or it does not meet any of the criteria of section 102-125(1) through (9).*

The wall of the historic rear addition in question does not meet the criteria in section 102-125.

The following is the criteria of section 102-125:

- (1) *Embodies no distinctive characteristics of a type, period, or method of construction of aesthetic or historic significance in the city and is not a significant and distinguishable building entity whose components may lack individual distinction;*

Staff finds that the wall embodies no distinctive characteristics of aesthetic or historic significance. The historic rear addition has already been obscured by previous additions and the wall in question has no individual distinction.

- (2) *Is not specifically associated with events that have made a significant contribution to local, state, or national history;*

Staff has not found the wall to be associated with any significant events that have contributed to local, state, or national history.

- (3) *Has no significant character, interest, or value as part of the development, heritage, or cultural characteristics of the city, state or nation, and is not associated with the life of a person significant in the past;*

The wall has no significant character defining features. Staff has not found the wall of the historic rear addition to be associated with the life of a person significant in the past.

- (4) *Is not the site of a historic event with a significant effect upon society;*

Staff has not found the wall to be associated with any historic events that have had a significant effect upon society.

- (5) *Does not exemplify the cultural, political, economic, social, or historic heritage of the city;*

The wall proposed for demolition is not an example of cultural, political, economic, social, or historic heritage of the city.

- (6) *Does not portray the environment in an era of history characterized by a distinctive architectural style;*

The wall of the historic rear addition does not portray a distinctive architectural style.

- (7) *If a part of or related to a square, park, or other distinctive area, nevertheless should not be developed or preserved according to a plan based on the area's historic, cultural, natural, or architectural motif;*

The wall in question is not part of a square, park or other distinctive area.

- (8) *Does not have a unique location or singular physical characteristic which represents an established and familiar visual feature of its neighborhood or of the city, and does not exemplify the best remaining architectural type in a neighborhood; and*

The wall of the historic rear addition proposed for demolition does not have a unique location or physical characteristic. Because the historic rear addition has been obscured and altered over time, it does not exemplify the best remaining architectural type.

- (9) *Has not yielded, and is not likely to yield, information important in history.*

The wall in question is not likely to yield important historical information.

It is staff's opinion that the Commission can review the request for demolition. If approved, this will be the final required reading for demolition.

APPLICATION

HARC MAJOR PROJECTS CERTIFICATE OF APPROPRIATENESS

\$420 NON-REFUNDABLE BASE APPLICATION FEE - OTHER FEES MAY BE APPLICABLE Rev 12/14/2020 ET



City of Key West
1300 White Street
Key West, Florida 33040

HARC COA # <i>2021-0041</i>	REVISION #	INITIAL & DATE
FLOOD ZONE	ZONING DISTRICT	BLDG PERMIT #

A PRE-APPLICATION MEETING WITH HARC STAFF IS REQUIRED PRIOR TO SUBMITTAL

ADDRESS OF PROPOSED PROJECT:	643 WILLIAM STREET	
NAME ON DEED:	ROBERT T & MARY C HESSE	PHONE NUMBER 716-310-9899
OWNER'S MAILING ADDRESS:	643 WILLIAM STREET	EMAIL RTHESSE53@GMAIL.COM
	KEY WEST, FL 33040	
APPLICANT NAME:	<i>Robert T. Hesse</i>	PHONE NUMBER <i>716-310-9899</i>
APPLICANT'S ADDRESS:	<i>643 William St.</i>	EMAIL <i>rthesse53@gmail.com</i>
	<i>Key West, FL 33040</i>	
APPLICANT'S SIGNATURE:	<i>x Robert Hesse</i>	DATE <i>x 7-14-2021</i>

ANY PERSON THAT MAKES CHANGES TO AN APPROVED CERTIFICATE OF APPROPRIATENESS MUST SUBMIT A NEW APPLICATION.

FLORIDA STATUTE 837.06: WHOEVER KNOWINGLY MAKES A FALSE STATEMENT IN WRITING AND WITH THE INTENT TO MISLEAD A PUBLIC SERVANT IN THE PERFORMANCE OF HIS OR HER OFFICIAL DUTY SHALL BE GUILTY OF A MISDEMEANOR OF THE SECOND-DEGREE PUNISHABLE PER SECTION 775.082 OR 775.083. THE APPLICANT FURTHER HEREBY ACKNOWLEDGES THAT THE SCOPE OF WORK AS DESCRIBED IN THE APPLICATION SHALL BE THE SCOPE OF WORK THAT IS CONTEMPLATED BY THE APPLICANT AND THE CITY. THE APPLICANT FURTHER STIPULATES THAT SHOULD FURTHER ACTION BE TAKEN BY THE CITY FOR EXCEEDING THE SCOPE OF THE DESCRIPTION OF WORK, AS DESCRIBED HEREIN, AND IF THERE IS CONFLICTING INFORMATION BETWEEN THE DESCRIPTION OF WORK AND THE SUBMITTED PLANS, THE AFOREMENTIONED DESCRIPTION OF WORK SHALL BE CONTROLLING.

PROJECT INCLUDES: REPLACEMENT OF WINDOWS ___ RELOCATION OF A STRUCTURE ___ ELEVATION OF A STRUCTURE ___
 PROJECT INVOLVES A CONTRIBUTING STRUCTURE: YES NO ___ INVOLVES A HISTORIC STRUCTURE: YES NO ___
 PROJECT INVOLVES A STRUCTURE THAT IS INDIVIDUALLY LISTED ON THE NATIONAL REGISTER: YES ___ NO

DETAILED PROJECT DESCRIPTION INCLUDING MATERIALS, HEIGHT, DIMENSIONS, SQUARE FOOTAGE, LOCATION, ETC.	
GENERAL:	DEMO OF EXISTING SHED AT HOUSE, ADDITION OF 141.75 SF FOR LIVING ROOM W/ NEW SHED ROOF TO TIE IN UNDER EXISTING GABLE ROOF OF EXISTING LIVING ROOM. WALLS TO RECEIVE SAME PAINT COLOR AS EXISTING HOUSE. ROOF TO BE MEMBRANE TO MATCH OTHER SIDE OF HOUSE. GUTTER TO MATCH EXISTING GALVANIZED GUTTERS.
MAIN BUILDING:	
DEMOLITION (PLEASE FILL OUT AND ATTACH DEMOLITION APPENDIX):	SEE DEMO APPENDIX

RECEIVED
JUL 21 2021
BY: *mfi*

APPLICATIONS MUST BE SUBMITTED IN PERSON WITH HARD COPIES BY 3PM ON THE SCHEDULED DEADLINE
 PLEASE SEND AN ELECTRONIC COPY OF ALL DOCUMENTS CITY_HARC@CITYOFKEYWEST-FL.GOV

ACCESSORY STRUCTURE(S):	
PAVERS: RELOCATION OF PAVERS PER PLAN	FENCES:
DECKS:	PAINTING: ADDITION TO MATCH EXISTING HOUSE PAINT COLORS
SITE (INCLUDING GRADING, FILL, TREES, ETC):	POOLS (INCLUDING EQUIPMENT): EQUIPMENT RELOCATION PER PLAN
ACCESSORY EQUIPMENT (GAS, A/C, VENTS, ETC):	OTHER:

OFFICIAL USE ONLY:	HARC COMMISSION REVIEW	EXPIRES ON:
MEETING DATE:	<input type="checkbox"/> APPROVED <input type="checkbox"/> NOT APPROVED <input type="checkbox"/> DEFERRED FOR FUTURE CONSIDERATION	INITIAL:
MEETING DATE:	<input type="checkbox"/> APPROVED <input type="checkbox"/> NOT APPROVED <input type="checkbox"/> DEFERRED FOR FUTURE CONSIDERATION	INITIAL:
MEETING DATE:	<input type="checkbox"/> APPROVED <input type="checkbox"/> NOT APPROVED <input type="checkbox"/> DEFERRED FOR FUTURE CONSIDERATION	INITIAL:
REASONS OR CONDITIONS:		
STAFF REVIEW COMMENTS:		
FIRST READING FOR DEMO:	SECOND READING FOR DEMO:	
HARC STAFF SIGNATURE AND DATE:	HARC CHAIRPERSON SIGNATURE AND DATE:	

THIS APPLICATION MAY BE REVIEWED BY PLANNING DEPARTMENT STAFF.

HARC CERTIFICATE OF APPROPRIATENESS: DEMOLITION APPENDIX



City of Key West

1300 White Street
Key West, Florida 33040

HARC COA # <i>2021-0041</i>	INITIAL & DATE
ZONING DISTRICT	BLDG PERMIT #

ADDRESS OF PROPOSED PROJECT:	643 WILLIAM STREET; KEY WEST, FL 33040
PROPERTY OWNER'S NAME:	ROBERT T AND CATHY MARY C HESSE
APPLICANT NAME:	ERICA POOLE

I hereby certify I am the owner of record and that the work shall conform to all applicable laws of this jurisdiction. By receiving a Certificate of Appropriateness, I realize that this project will require a Building Permit approval PRIOR to proceeding with the work outlined above and that a final inspection is required under this application. I also understand that any changes to an approved Certificate of Appropriateness must be submitted for review.

x Robert Hesse *Robert Hesse 7-14-21* x *7/14/21*
 PROPERTY OWNER'S SIGNATURE *Mary C. Hesse* *Mary C. Hesse* DATE AND PRINT NAME

DETAILED PROJECT DESCRIPTION OF DEMOLITION
DEMO OF EXISTING 6'9" X 4'4" WOOD FRAME SHED.

CRITERIA FOR DEMOLITION OF CONTRIBUTING OR HISTORIC STRUCTURES:
Before any Certificate of Appropriateness may be issued for a demolition request, the Historic Architectural Review Commission must find that the following requirements are met (please review and comment on each criterion that applies):
(1) If the subject of the application is a contributing or historic building or structure, then it should not be demolished unless its condition is irrevocably compromised by extreme deterioration or it does not meet any of the following criteria:
(a) The existing condition of the building or structure is irrevocably compromised by extreme deterioration.
THE SHED ITSELF IS NOT CONTRIBUTING OR HISTORIC.
(2) Or explain how the building or structure meets the criteria below:
(a) Embodies no distinctive characteristics of a type, period, or method of construction of aesthetic or historic significance in the city and is not a significant and distinguishable building entity whose components may lack individual distinction.
THE SHED EMBODIES NO DISTICTIVE CHARACTERISTICS OF A TYPE, PERIOD, OR METHOD OF CONSTRUCTION THAT IS SIGNIFICANT. IT WAS ADDED ON AFTER THE ORIGINAL STRUCTURE WAS BUILT.

Nothing in this application is intended to alter the authority of the Building Official to condemn for demolition dangerous buildings, as provided in Section 102-218 of the Land Development Regulations and Chapter 14 of the Code of Ordinances.

(b) Is not specifically associated with events that have made a significant contribution to local, state, or national history.
THE SHED HAS NOT BEEN ASSOCIATED WITH SIGNIFICANT EVENTS.
(c) Has no significant character, interest, or value as part of the development, heritage, or cultural characteristics of the city, state or nation, and is not associated with the life of a person significant in the past.
THE SHED HAS NO SIGNIFICANT CHARACTER OR OTHERWISE AND IS NOT ASSOCIATED WITH THE LIFE OF A HISTORIC FIGURE.
(d) Is not the site of a historic event with significant effect upon society.
THE SUBJECT PROPERTY IS NOT THE SITE OF A HISTORIC EVENT.
(e) Does not exemplify the cultural, political, economic, social, or historic heritage of the city.
THE SHED DOES NOT EXEMPLIFY ANY OF THE MENTIONED CRITERIA.
(f) Does not portray the environment in an era of history characterized by a distinctive architectural style.
THE SHED IS NOT CHARACTERIZED BY A DISTINCTIVE ARCHITECTURAL STYLE.
(g) If a part of or related to a square, park, or other distinctive area, nevertheless should not be developed or preserved according to a plan based on the area's historic, cultural, natural, or architectural motif.
IT IS NOT RELATED TO A DISTINCTIVE AREA.
(h) Does not have a unique location or singular physical characteristic which represents an established and familiar visual feature of its neighborhood or of the city, and does not exemplify the best remaining architectural type in a neighborhood.
THE SHED DOES NOT HAVE ANY ARCHITECTURAL CHARACTERISTICS THAT EXEMPLIFY THE NEIGHBORHOOD FABRIC.

Nothing in this application is intended to alter the authority of the Building Official to condemn for demolition dangerous buildings, as provided in Section 102-218 of the Land Development Regulations and Chapter 14 of the Code of Ordinances.

(i) Has not yielded, and is not likely to yield, information important in history, THE SHED HAS NOT AND IS NOT LIKELY TO YIELD INFORMATION HISTORICALLY IMPORTANT IN HISTORY.

CRITERIA FOR DEMOLITION OF NON-CONTRIBUTING OR NON-HISTORIC STRUCTURES:
The following criteria will also be reviewed by the Historic Architectural Review Commission for proposed demolitions. The Commission shall not issue a Certificate of Appropriateness that would result in the following conditions (please review and comment on each criterion that applies):
(1) Removing buildings or structure that are important in defining the overall historic character of a district or neighborhood so that the character is diminished.
THE SHED IS NOT DEFINING TO THE OVERALL HISTORIC CHARACTER OF THE DISTRICT OR NEIGHBORHOOD.
(2) Removing historic buildings or structures and thus destroying the historic relationship between buildings or structures and open space.
REMOVING THE SHED DOES NOT DESTROY ANY HISTORIC RELATIONSHIPS WITH THE BUILDINGS ON OR AROUND THE SITE.
(3) Removing an historic building or structure in a complex; or removing a building façade; or removing a significant later addition that is important in defining the historic character of a site or the surrounding district or neighborhood.
THE SHED IS NOT VISIBLE FROM THE STREET NOR IS THE PROPOSED DESIGN. IT IS NOT A SIGNIFICANT ADDITION.
(4) Removing buildings or structures that would otherwise qualify as contributing.
THE SHED IS NOT CONTRIBUTING.

SANBORN MAPS

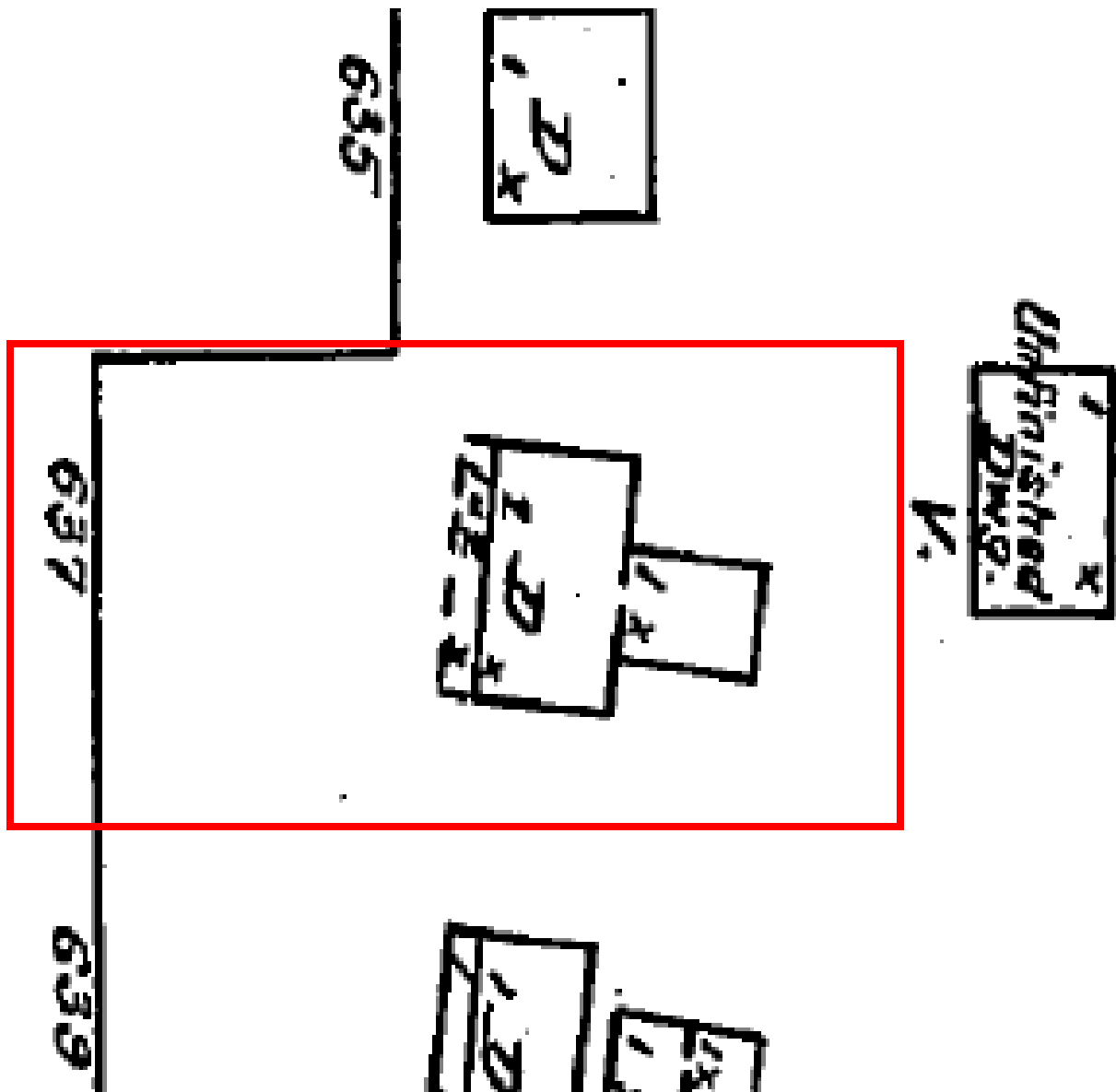

1892 Sanborn with the property at 643 (637) William Street indicated in red.

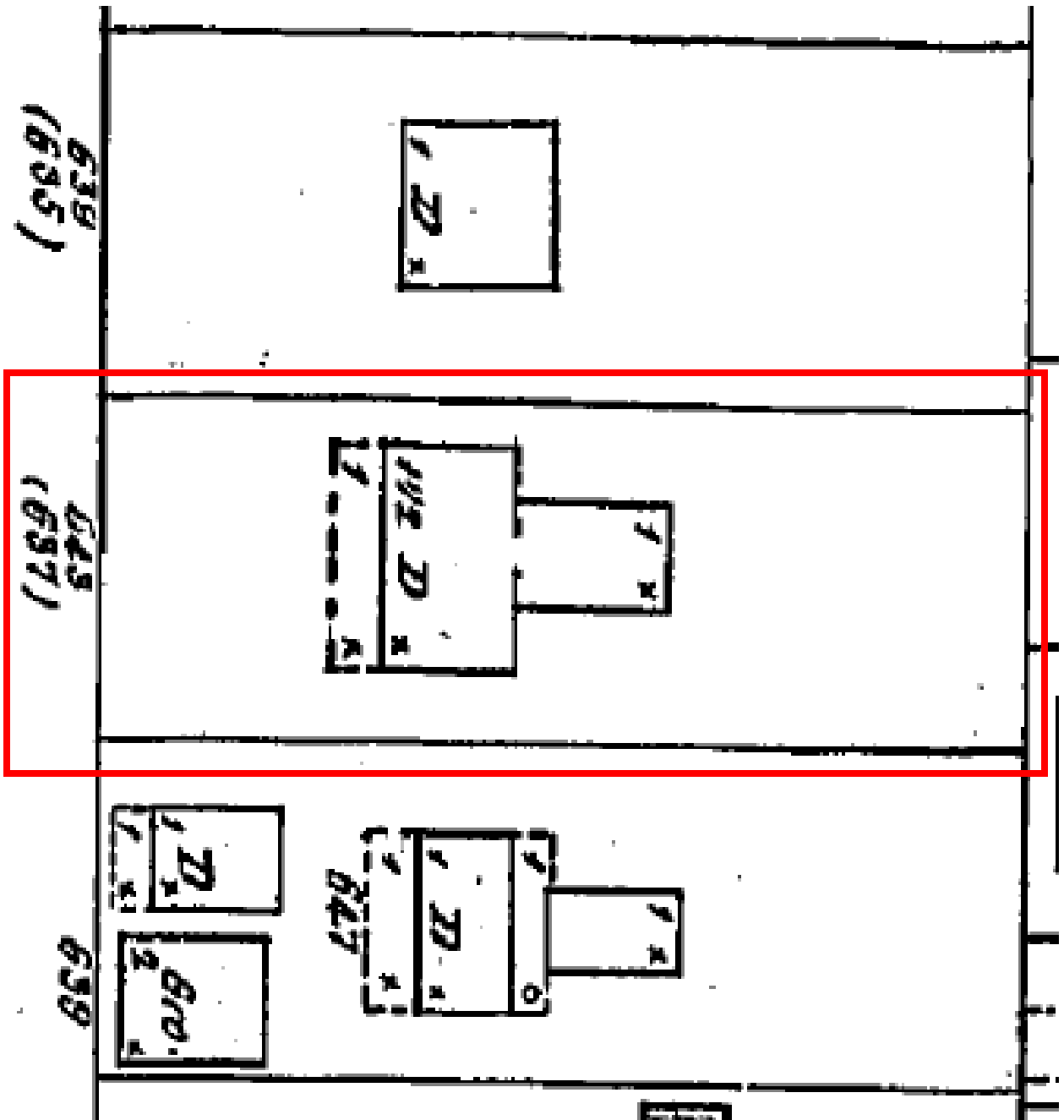

1899 Sanborn with the property at 643 (637) William Street indicated in red.

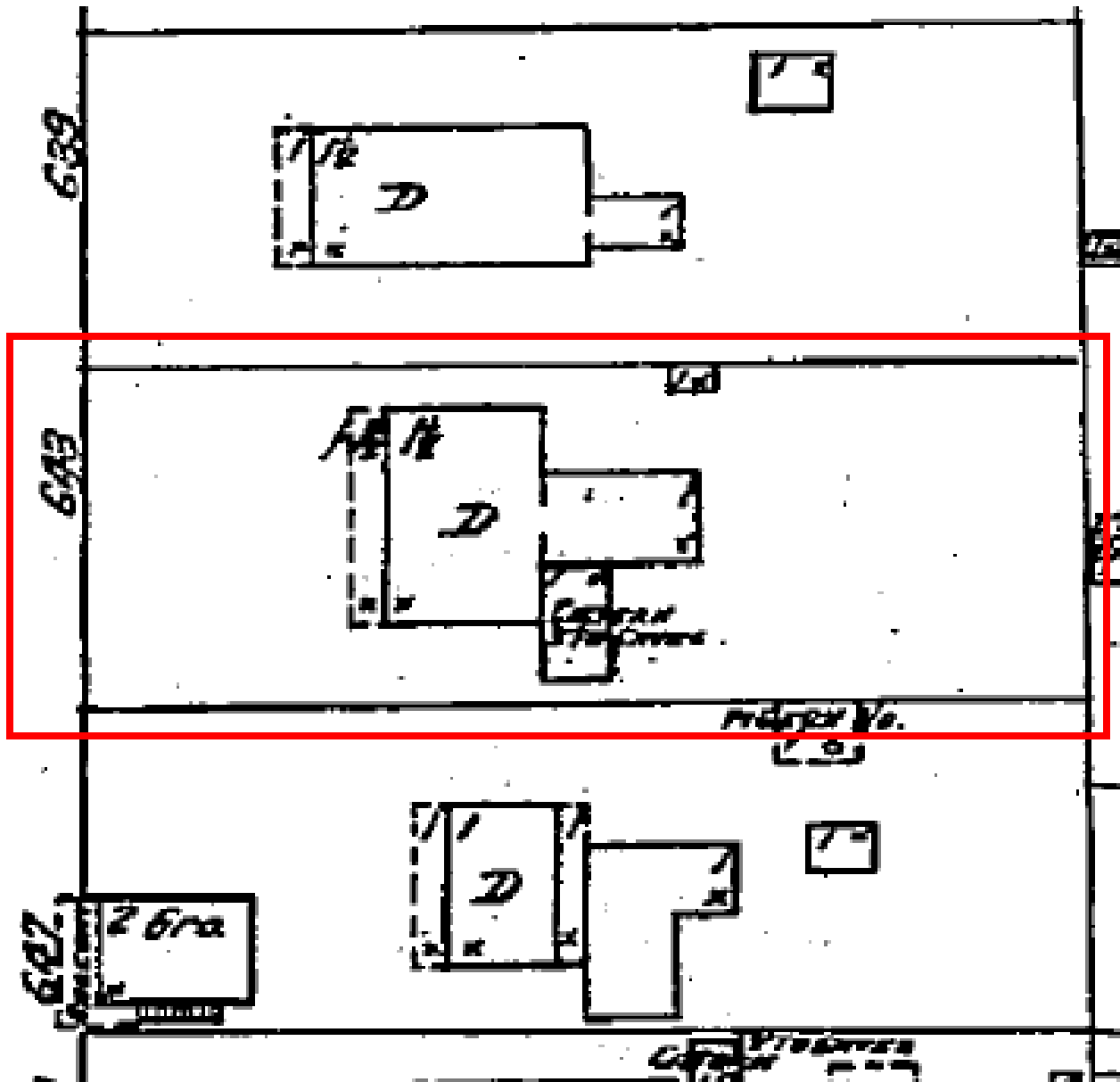

1912 Sanborn with the property at 643 William Street indicated in red.

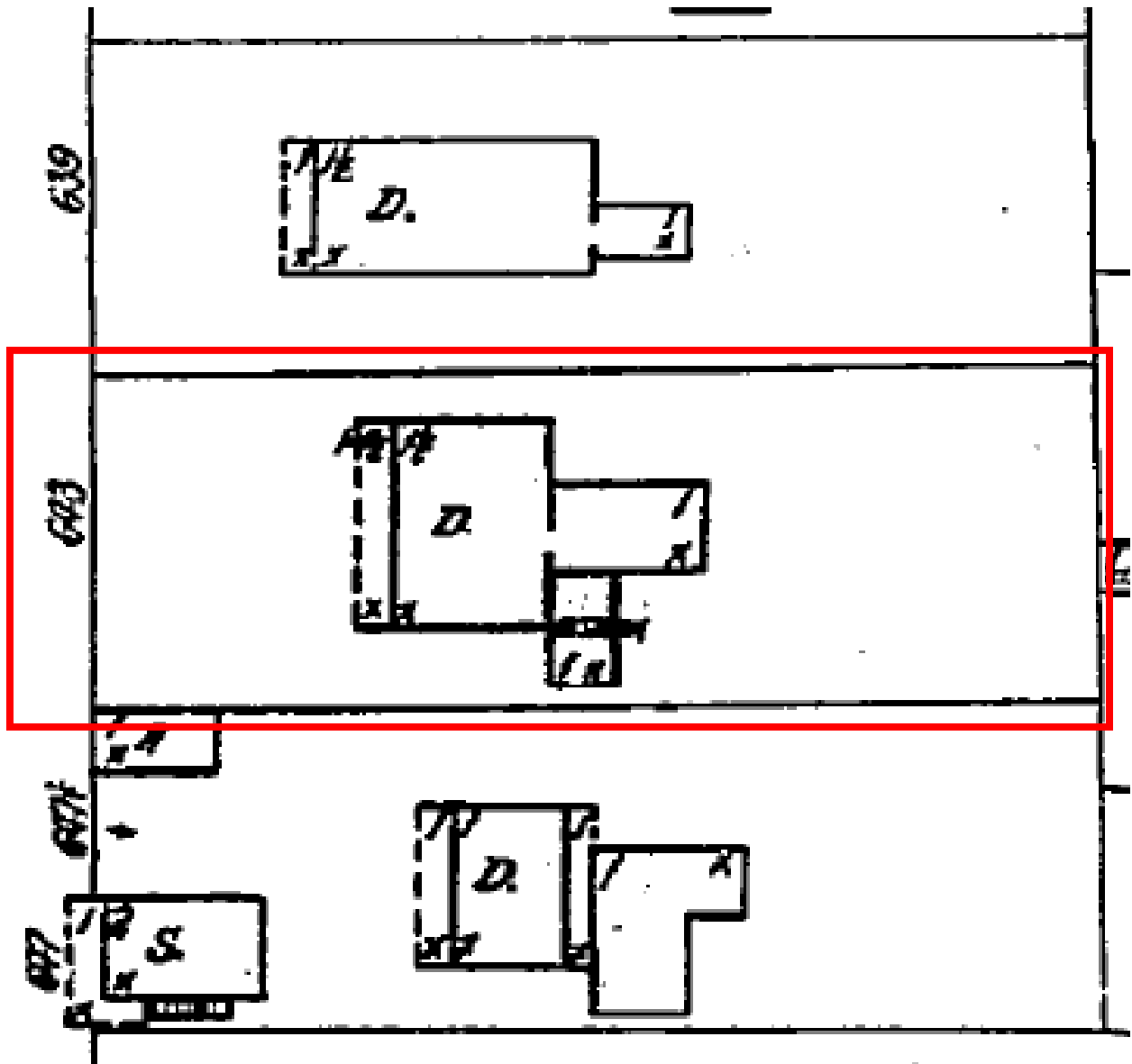

1926 Sanborn with the property at 643 William Street indicated in red.

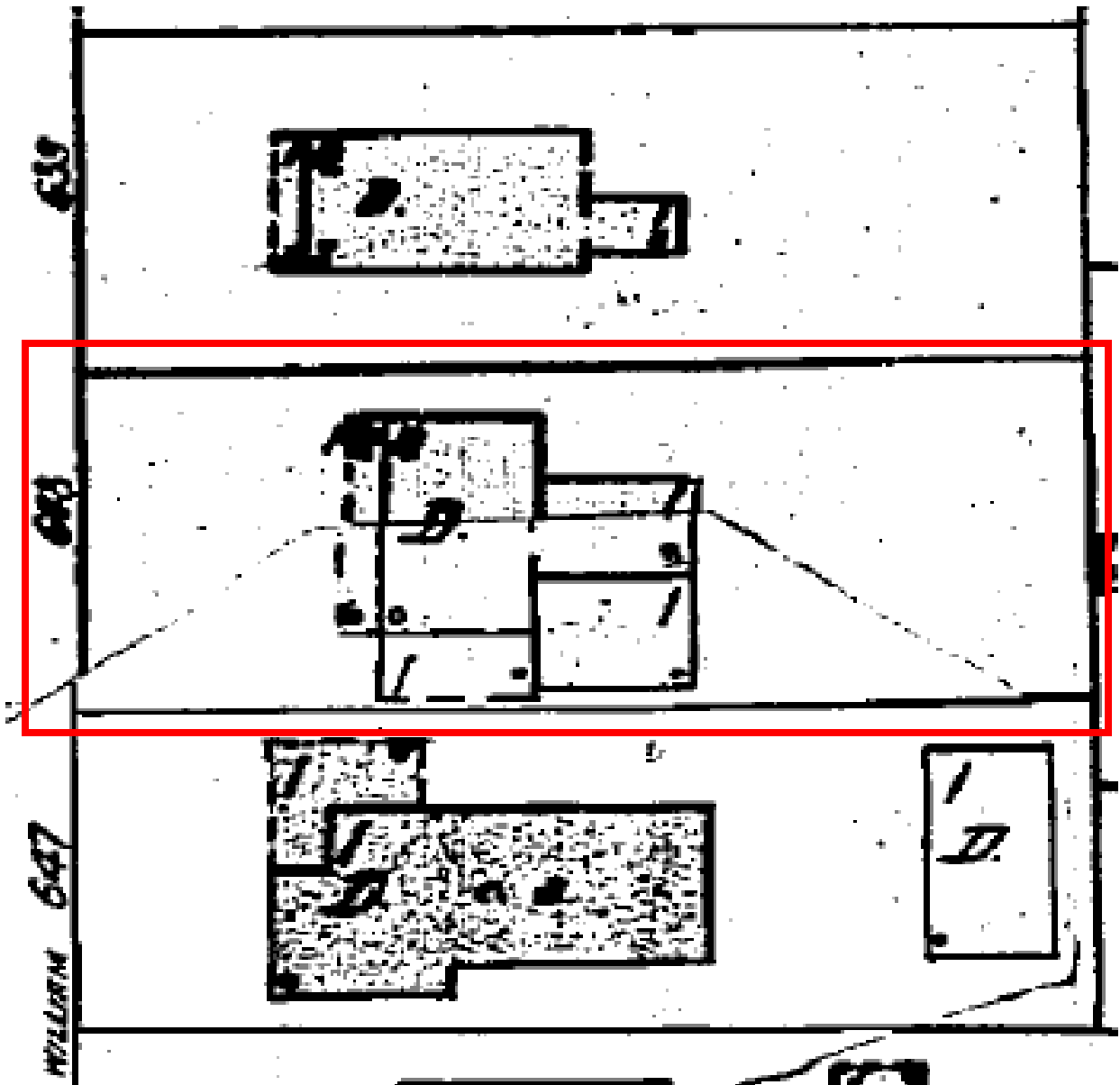

1948 Sanborn with the property at 643 William Street indicated in red.

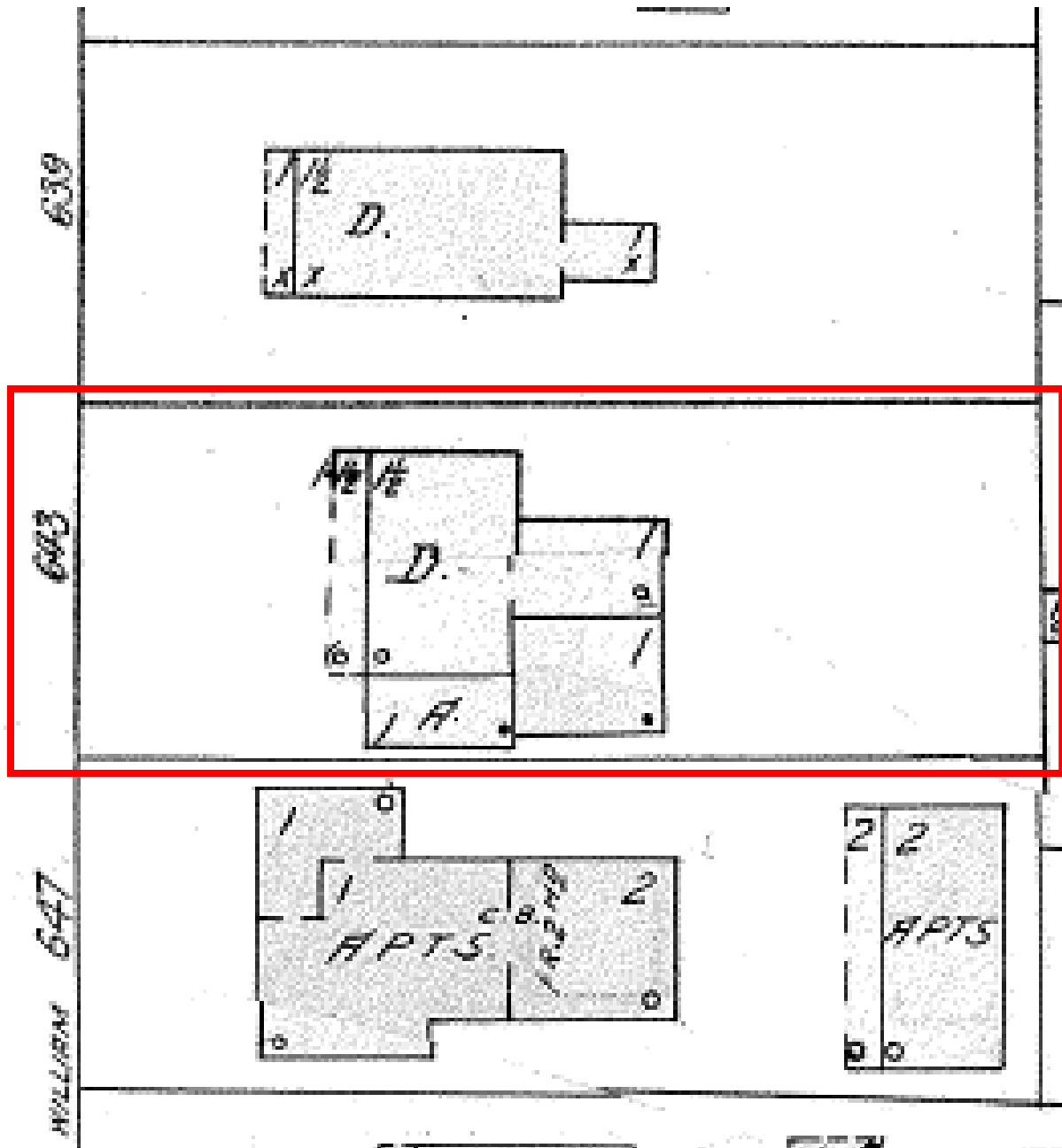

1962 Sanborn with the property at 643 William Street indicated in red.

PROJECT PHOTOS



1930s photo of the house at 643 William Street.



1965 photo of the house at 643 William Street.

























SURVEY

Boundary Survey Map of part of Tract 5, according to Wm Whitehead's Map of the Island of Key West

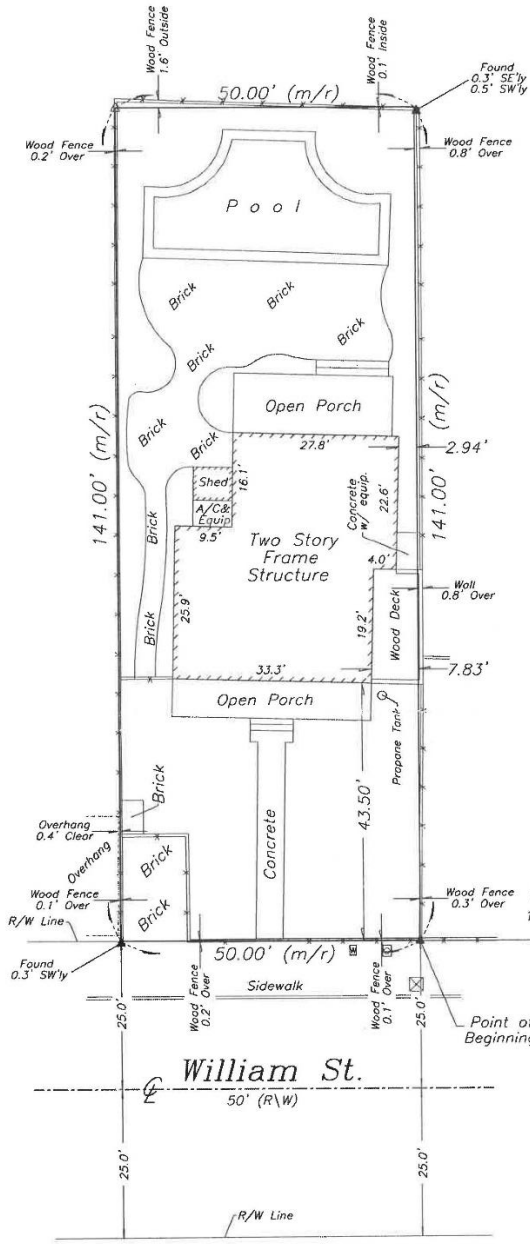
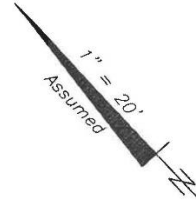

- LEGEND**
- ⊙ Found 2" Iron Pipe (Fence Post)
 - Set #5 rebor w/cap (6298)
 - Found 1/2" Iron Rod (2863)
 - ▲ Found Nail & Disc (Norby)
 - △ Set Nail & Disc (6298)
 - (M) Measured
 - (R) Record
 - (M/R) Measured & Record
 - C.B.S. Concrete Block Structure
 - R\W Right of Way
 - CLF Chain Link Fence
 - ⊕ Centerline
 - ⊙ Wood Utility Pole
 - ⊗ Concrete Utility Pole
 - P- Overhead Utility Lines
 - ⊠ Sewer Cleanout
 - ⊠ Water Meter

NOTE:
This Survey Map is not full and complete without the attached Survey Report.

Sheet One of Two Sheets

J. LYNN O'FLYNN, Inc.

Professional Surveyor & Mapper
PSM #6298

3430 Duck Ave., Key West, FL 33040
(305) 296-7422 FAX (305) 296-2244

Boundary Survey Report of part of Tract 5, according to Wm
Whitehead's Map of the Island of Key West

NOTES:

1. The legal description shown hereon was furnished by the client or their agent.
2. Underground foundations and utilities were not located.
3. All angles are 90° (Measured & Record) unless otherwise noted.
4. Street address: 643 William Street, Key West, FL.
5. This survey is not valid without the signature and the original raised seal of a Florida licensed surveyor and mapper.
6. Lands shown hereon were not abstracted for rights-of-way, easements, ownership, or other instruments of record.
7. North Arrow is assumed and based on the legal description.
8. This survey is not assignable.
9. Date of field work: May 4, 2007
10. Ownership of fences is undeterminable, unless otherwise noted.
11. Adjoiners are not furnished.
12. The Survey Report is not full and complete without the attached Survey Map.

BOUNDARY SURVEY OF: On the Island and of Key West and known on the map of William A. Whitehead delineated in February, A.D., 1829, and on the map of L. Windsor Smith recorded in Deed Book "D", Page 449, of Monroe County, Florida, records, as a part of Tract 5, and more particularly described as follows:
COMMENCING at a point on the Northeast side of William Street 160 feet, 3 inches from the corner of Windsor Lane and William Street and running thence in a Northwesterly direction 50 feet; thence at right angles in a Northeasterly direction 141 feet; thence at right angles in a Southeasterly direction 50 feet; thence at right angles in a Southwesterly direction 141 feet to the Point of Beginning.

BOUNDARY SURVEY FOR: Robert T. Hesse & Mary C. Hesse;
Merrill Lynch Credit Corporation;
Marci L. Rose, Esq.;
Attorney's Title Insurance Fund, Inc.;

J. LYNN O'FLYNN, INC.



J. Lynn O'Flynn, PSM
Florida Reg. #6298

May 7, 2007
Revised Rear Fence 5-15-07

Sheet One of Two Sheets

NOTE:
This Survey Map is not
full and complete without
the attached Survey Report.

J. LYNN O'FLYNN, Inc.

Professional Surveyor & Mapper
PSM #6298
3430 Duck Ave., Key West, FL 33040
(305) 296-7422 FAX (305) 296-2244

PROPOSED DESIGN

SITE DATA:
 FLOOD ZONE AE6
 ZONING HHDR

LEGAL DESCRIPTION:
 KW PT OF TR 5 H3-70 OR522-740 OR641-167/68 OR709-78/79 OR790-288
 OR1170-169 OR1342-289/91 OR1573-171 OR1681-1527/29 OR2294-90 (PER
 PROPERTY RECORD CARD)

RE #: 00018550-000000

ADDRESS: 643 WILLIAM STREET; KEY WEST, FL 33040

OWNER:
 ROBERT T & MARY C HESSE
 643 WILLIAM STREET
 KEY WEST, FL 33040

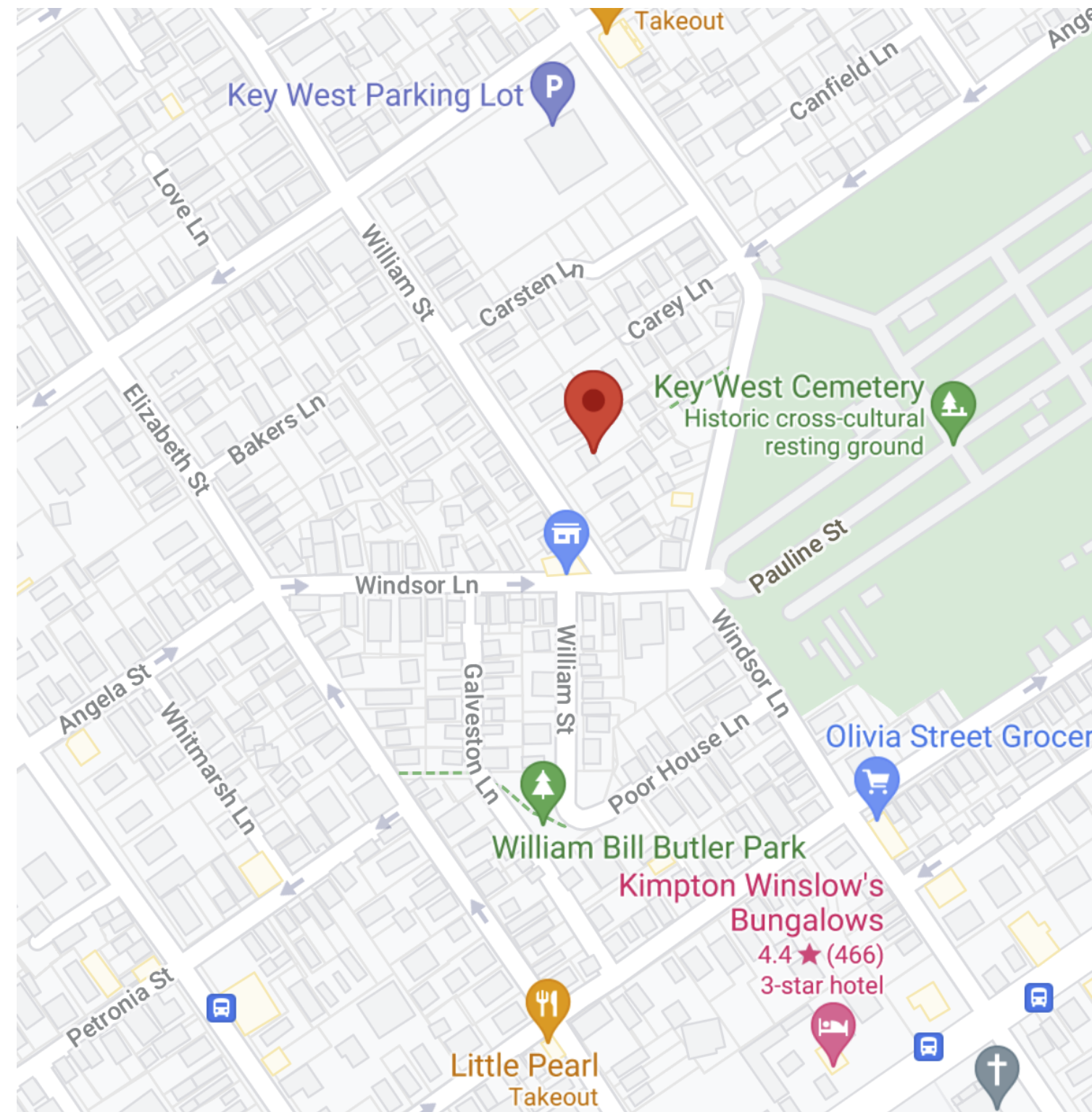

LOCATION MAP

SCOPE OF WORK:

DEMO OF EXISTING SHED, MODIFICATION OF EXISTING PAVER LAYOUT PER A1.0 UTILIZING EXISTING PAVERS ON SITE. ADDITION TO HAVE IMPACT RATED WINDOWS, WOOD SIDING TO MATCH EXISTING HOUSE, GUTTER PER PLAN TO MATCH EXISTING HOUSE, MEMBRANE ROOF, SPRAY FOAM INSULATION PER PLAN.

APPLICABLE CODES:
 CITY OF KEY WEST CODES & ORDINANCES
 FLORIDA BUILDING CODE 2020 7TH EDITION
 NEC 2020
 ALL ADOPTED CODES WITHIN THE AHJ

A 0.0	INDEX & NOTES
A 1.0	SITE PLAN
A 2.0	ARCH/STRUCT PLANS
A 3.0	ELEVATIONS & SCHEDULES
A 3.1	ELEVATIONS
MEP 2.0	MECH/ELECT NOTES & DETAILS
S 1.0	STRUCTURAL NOTES/DETAILS

ABBREVIATIONS

AFF	ABOVE FINISHED FLOOR
AHU	AIR HANDLING UNIT
A/V	AUDIO VISUAL
BO	BOTTOM OF
CL	CENTERLINE
CLG	CEILING
CMU	CONCRETE MASONRY UNIT
CO	CLEAN OUT
CONC	CONCRETE
D	DRYER
DIA	DIAMETER
DTLS	DETAILS
DW	DISHWASHER
E	ELECTRICAL METER
FBC	FLORIDA BUILDING CODE
FEC	FIRE EXTINGUISHER CABINET
GA	GAUGE
GAL	GALLON
GFI	GROUND FLOOR IMPACT
GWB	GYPSUM WALL BOARD
HB	HOSE BIB
HVAC	HEATING, VENTILATION, & AIR
CONDITIONING	
LHM	LOWEST HORIZONTAL MEMBER
MAX	MAXIMUM
MEP	MECHANICAL, ELECTRICAL, PLUMBING
MIN	MINIMUM
NIC	NOT IN CONTRACT
NTS	NOT TO SCALE
O.C.	ON CENTER
PSI	POUNDS PER SQUARE INCH
PT	PRESSURE TREATED
RCP	REFLECTED CEILING PLAN
RE	REFERENCE
REF	REFRIGERATOR
REQ'D	REQUIRED
RO	ROUGH OPENING
STL	STEEL
THK	THICK
TO	TOP OF
TOP	TOP OF PILE
TOW	TOP OF WALL
TYP	TYPICAL
U.N.O.	UNLESS OTHERWISE NOTES
VTR	VENT TO ROOF
W	WASHER
WC	WATER CLOSET
WD	WOOD
W/D	WASHER/DRYER
WP	WATERPROOF
WH	WATER HEATER

GENERAL NOTES

- THESE PLANS ARE FOR THE CONSTRUCTION OF THE BUILDING AT THE LOCATION SO DESIGNATED HERE IN.
- NO CHANGES IN THE PLANS SHALL BE MADE WITHOUT PRIOR APPROVAL OF THE DESIGN PROFESSIONAL.
- THE CONTRACTOR SHALL CHECK AND VERIFY ALL DIMENSIONS AND CONDITIONS OF THE JOB SITE AND REPORT ANY DISCREPANCIES OR UNSATISFACTORY CONDITIONS TO THE ARCHITECT BEFORE PROCEEDING WITH THE WORK.
- THE CONTRACTOR SHALL PROVIDE FOR THE SAFETY, PREVENTION OF INJURY, OR LOSS AT THE JOB SITE TO ALL PERSONS EMPLOYED TO DO WORK, PERSONS VISITING THE SITE AND THE GENERAL PUBLIC. CONTRACTOR SHALL ALSO BE RESPONSIBLE FOR THE PREVENTION OF DAMAGE TO MATERIALS OR EQUIPMENT AND OTHER PROPERTY AT THE SITE OR ADJACENT THERETO.
- THE CONTRACTOR SHALL DO ALL THE WORK IN STRICT CONFORMANCE TO THE PLAN, 2017 FLORIDA BUILDING CODE (8TH EDITION), LOCAL CODES AND ORDINANCES, MANUFACTURING'S RECOMMENDATIONS AND ACCEPTABLE TRADE PRACTICES. THE MOST STRINGENT REQUIREMENTS SHALL GOVERN WHEN CONDITIONS CONFLICT, HOWEVER THE ARCHITECT SHALL BE NOTIFIED OF ALL CONFLICTS.
- SHOP DRAWINGS OF ALL PREFABRICATED STRUCTURAL SYSTEMS SHALL HAVE THE SEAL OF A REGISTERED FLORIDA ENGINEER AS REQUIRED BY BUILDING CODE AND SHALL BE SUBMITTED TO THE ARCHITECT/ENGINEER BY THE CONTRACTOR FOR REVIEW PRIOR TO CONSTRUCTION.
- CONTRACTOR SHALL NOT SCALE DRAWINGS. ANY INFORMATION THAT HE CANNOT OBTAIN FROM DIMENSIONS, DETAILS, OR SCHEDULES, HE SHALL NOTIFY THE ARCHITECT.
- CONTRACTOR SHALL CHECK AND COORDINATE WORK OF VARIOUS TRADES TO PREVENT CONFLICTS.
- CONTRACTOR SHALL FURNISH SUBCONTRACTORS WITH A COMPLETE SET OF PLANS.
- PLUMBING AND A/C SHALL CONFORM TO THE STATE OF FLORIDA ENERGY CODE.
- ALL ELECTRICAL WORK SHALL CONFORM TO THE NATIONAL ELECTRIC CODE AND FLORIDA BUILDING CODE.
- PORTABLE REST ROOM FACILITIES SHALL BE PROVIDED AT SITE BY CONTRACTOR.
- COMPLETE HOT AND COLD WATER SYSTEMS, VENTS, WASTE AND DRAIN SYSTEMS TO SEPTIC TO CODE, SHALL BE FURNISHED.
- PROVIDE PLASTIC SLEEVES IN MASONRY, PARTITIONS, FOUNDATIONS, ETC., AS REQUIRED FOR UTILITY SERVICE.
- ALL BOLTS, CLIPS, HANGERS, ETC., SHALL BE GALVANIZED OR STAINLESS.
- NO PIPES, CONDUITS OR JUNCTION BOXES ARE TO BE PLACED IN SLABS OR COLUMNS, UNLESS SPECIFICALLY SHOWN ON STRUCTURAL DRAWINGS.
- CONTRACTOR IS RESPONSIBLE FOR THE PROPER REMOVAL OF ALL DEBRIS.
- ALL ELEVATIONS ARE MEASURED FROM NGVD 1929.

PHASE 09 - ROOF 09 - ROOFING 1. METAL STANDING SEAM ROOF OVER PLYWOOD DECK. INSTALL PER MANUFACTURER SPEC/NOA 2. POLYGLASS PEEL & STICK UNDERLAYMENT. INSTALL PER MANUFACTURER SPEC/NOA 09 - FASCIA WRAP FASCIA WITH ALUMINUM TO MATCH ROOFING 09 - SOFFITS SOFFITS TO BE HARDI BOARD, VENTED. 09 - GUTTERS GUTTERS TO BE WHITE ALUMINUM, ROUND PROFILE W/ ROUND DOWNSPOUTS AS INDICATED ON ROOF PLAN.	PHASE 13 - MECHANICAL, ELECTRICAL, AND PLUMBING 13 - CONDUIT 1. ALL ELECTRICAL WIRE TO BE INSULATED ELECTRICAL GRADE ANNEALED COPPER. 2. ALL WIRE TO BE INSIDE ELECTRICAL NONMETALLIC TUBING (AKA: SMURF TUBE) 3. ALL WEATHER LOCATIONS TO HAVE GRAY RIGID PVC ELECTRICAL CONDUIT. 4. ALL #12 & #10 WIRE TO BE SOLID. WIRES LARGER THAN #10 TO BE STRANDED, IN ACCORDANCE WITH ASTM. 5. MAKE CONNECTIONS SPLICES, TAPS AND JOINTS WITH MECHANICALLY AND ELECTRICALLY SECURE SOLDERED DEVICES. 13 - HVAC A/C UNIT SPECS: CARRIER COASTAL SERVICE COMPRESSOR, AIR HANDLER AND SYSTEM CONTROLS OR EQUAL. 1. A/C CONDENSER TO HAVE 120 VOLT GFCI OUTLET SUPPLIED ON UNIT. 2. A/C GRILLS TO BE PAINTED TO MATCH ADJACENT WALL OR CEILING. 3. INSTALLER TO TEST AND BALANCE ALL OUTLETS. 4. SEE SHEET "M-3.0" FOR FURTHER DETAILS. 5. ALL BATH VENT DUCTS TO BE 4" DIAMETER FLEXIBLE DUCT. 6. ALL HVAC DUCTS SHALL BE RIGID BOARD COMPLIANT W/ UL 151
PHASE 10 - WINDOWS & DOORS 10 - WINDOWS 1. WINDOWS TO BE: <u>ANDERSEN WINDOWS & DOORS</u> DEALER - VARIES	13 - PLUMBING <u>DOMESTIC WATER:</u> CHLORINATED POLYVINYL CHLORIDE (CPVC) PLASTIC PIPE ASTM D 2846 +/- ASTM F 441 +/- ASTM F 442 CROSS-LINKED POLYETHYLENE/ALUMINUM/CROSS-LINKED POLYETHYLENE (PEX-AL-PEX) PRESSURE PIPE ASTM F 1281 +/- CSA CAN/CSA-B-137.10 ALL SUPPLY PIPING TO BE 1" DIA. MIN. <u>WASTE, VENT, & STORM:</u> BUILDING SEWER, BELOW GRADE - SCHEDULE 40 PVC SOLVENT WELD BUILDING SEWER, IN BUILDING - SCHEDULE 4" 40 PVC SOLVENT WELD. <u>CONDENSATE DRAIN:</u> 3/4" SCHEDULE 40 PVC <u>REFRIGERANT PIPING:</u> TYPE L HARD DRAWN COPPER TUBING
PHASE 11 - EXTERIOR FINISHES 11 - EXTERIOR PAINT 1. EXTERIOR PAINT PRODUCTS SHALL BE SHERWIN WILLIAMS OR APPROVED EQUAL. 2. EXTERIOR MASONRY WALLS TO RECEIVE: (1) COAT SHERWIN WILLIAMS MASONRY SEALER, (2) COATS ACRYLIC LATEX EXTERIOR PAINT.	PHASE 14 - INSULATION & DRYWALL 14 - DRYWALL 1. IN WET LOCATIONS, WALL BOARD SHALL BE: 5/8" DUROCK CEMENT WALL BOARD OR APPROVED EQUAL. 2. TYPICAL INTERIOR DRYWALL SHALL BE 5/8" THK. 3. 5/8" TYPE X DRYWALL IN ALL WALLS AT GARAGE & ELEVATOR SHAFTS <u>GEORGIA-PACIFIC CORPORATION</u> 55 PARK PLACE ATLANTA, GEORGIA 30303 404-652-4000 14 - INSULATION 1. ATTIC SPACES TO HAVE MIN R-38 BATT INSULATION WITH FIRE BARRIER IN ACCESSIBLE ATTIC SPACE PER FBC 2017 6TH EDITION. 2. EXTERIOR WALLS R-19 BATT INSULATION. 3. INTERIOR WALLS THAT REQUIRE INSULATION FOR SOUND DAMPENING SHALL BE AS FOLLOWS: 3 5/8" STUD WALLS: R-11 BATT INSULATION 6" STUD WALLS: R-19 BATT INSULATION
11 - EXTERIOR TILE/STONE PAVERS 1. MATERIAL AS INDICATED ON PLANS	PHASE 15 - INTERIOR TRIM 15 - INTERIOR TRIM 1. INTERIOR TRIM <u>ARCHITECTURAL MOULDING & MILLWORKS, INC.</u> 305-638-8900 2. WINDOW SILLS WOOD - PAINTED
11 - EXTERIOR WATERPROOFING 1. ALL EXTERIOR CONCRETE DECKS OVER CONDITIONED SPACE AND AS OTHERWISE INDICATED ON PLANS SHALL BE SEALED WITH PRO-SPEC B-6000 WATERPROOF/CRACK ISOLATION MEMBRANE PRO-SPEC, A DIVISION OF SAKRETE OF NA WWW.PROSPEC.COM 1. ALL WOOD DECKS OVER AIR CONDITIONED SPACE SHALL RECEIVE "TILEDEK" UNDERLAYMENT BY DURADECK. DURADECK 1722 IRON ST N. KANSAS, MO 64116 800-338-3568 1. AT ALL DOOR AND WINDOW WOOD BUCKS AND DOOR AND WINDOW FLANGES APPLY BEI PM-7000 WET FLASH SYSTEM BUILDING ENVELOPE INNOVATIONS LLC WWW.WET-FLASH.COM 1. WHERE INDICATED ON PLANS EXTERIOR DECKS SHALL BE SEALED USING LATICRETE 9235 WATERPROOFING MEMBRANE. LATICRETE INTERNATIONAL INC. www.laticrete.com	PHASE 16 - INTERIOR FINISHES 16 - INTERIOR PAINT 1. INTERIOR PAINT PRODUCTS SHALL BE SHERWIN WILLIAMS OR APPROVED EQUAL. 16 - HARDWOOD FLOORING 1. INTERIOR WOOD FLOORING TO MATCH EXISTING - DADE COUNTY PINE, POLY FINISH.

DATE: 2020.06.21
 REV. SET DESCRIPTION
 ISSUED PERMIT SET

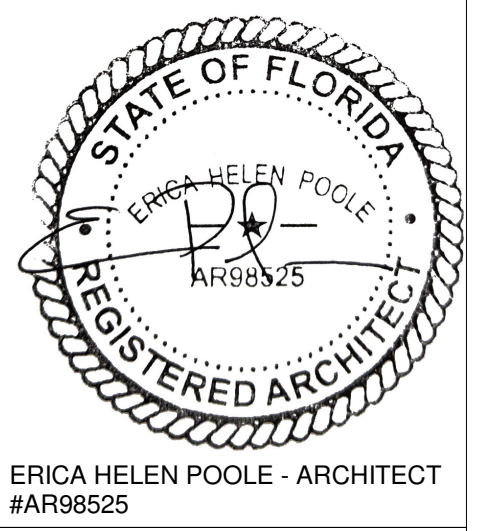

HESSE ADDITION
 643 William Street
 Key West, FL 33040

SHEET
 INDEX & NOTES

 PROJECT: HES2021
 DRAWN BY: EHP
 APPROVED BY: EHP

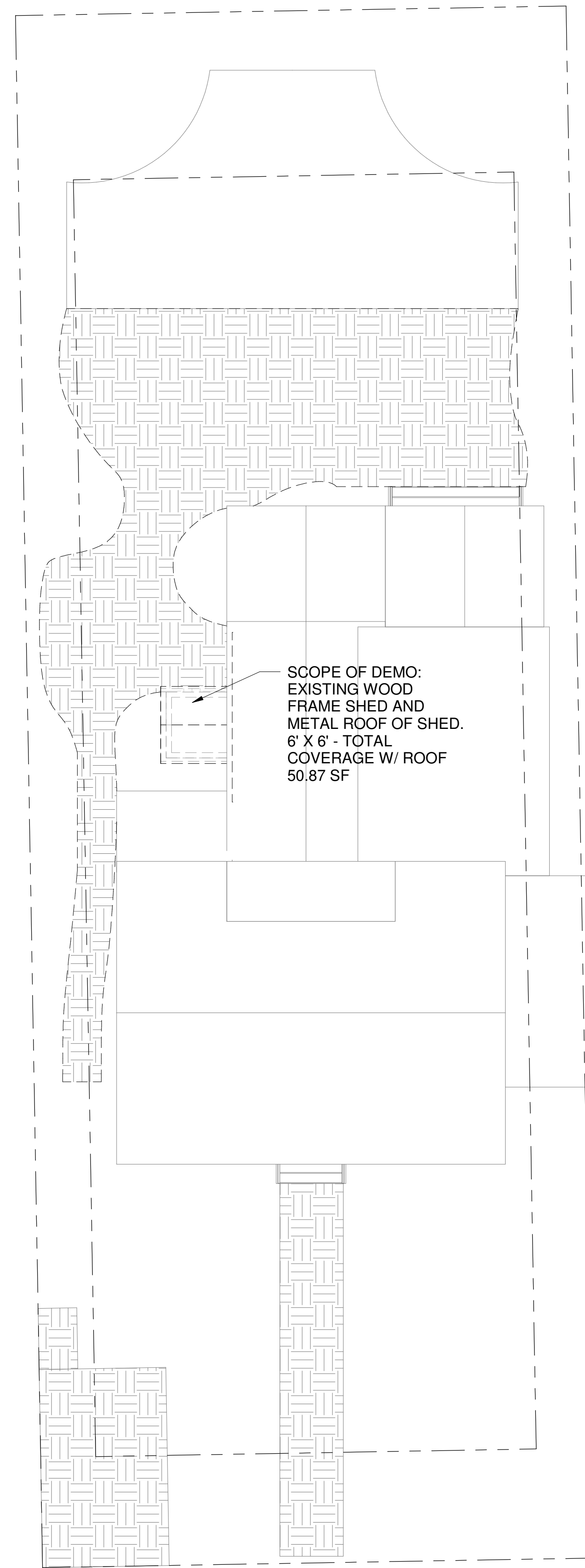

SCOPE OF DEMO:
EXISTING WOOD
FRAME SHED AND
METAL ROOF OF SHED.
6' X 6' - TOTAL
COVERAGE W/ ROOF
50.87 SF

2 SITE PLAN - DEMO
A 1.0 1/8" = 1'-0"

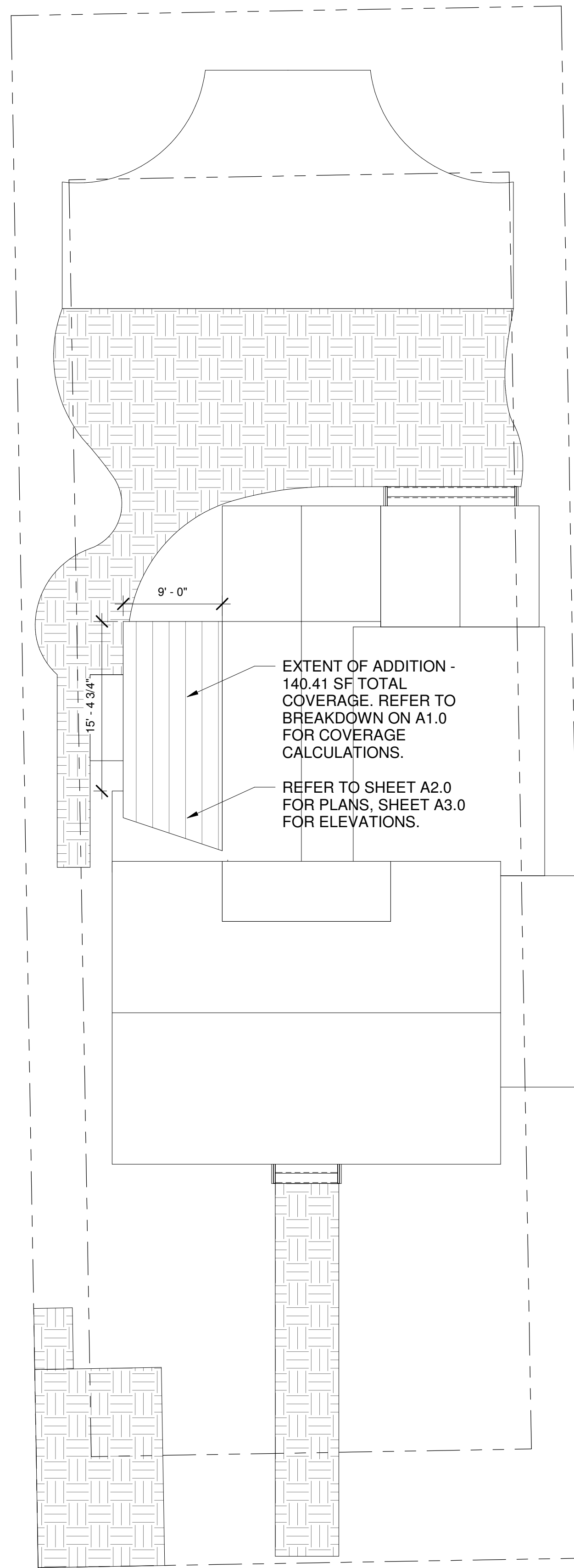

EXTENT OF ADDITION -
140.41 SF TOTAL
COVERAGE. REFER TO
BREAKDOWN ON A1.0
FOR COVERAGE
CALCULATIONS.
REFER TO SHEET A2.0
FOR PLANS, SHEET A3.0
FOR ELEVATIONS.

1 SITE PLAN - PROPOSED
A 1.0 1/8" = 1'-0"

ZONING DISTRICT REGULATIONS:
HHDR DISTRICT

SETBACKS:
FRONT: 10 FT
REAR: 20 FT
SIDE: 5 FT OR 10% OF LOT WIDTH TO A MAXIMUM OF 15 FT,
WHICHEVER IS GREATER.
STREET SITE: 5 FT

MAXIMUM BUILDING COVERAGE = 40%
MAXIMUM IMPERVIOUS SURFACE = 60%
MAXIMUM FAR = 1.0
MAXIMUM HEIGHT = 30 FT

LOT AREA = 7050 SF
EXISTING IMPERVIOUS = 4287 SF = 60.8%
EXISTING BUILDING COVERAGE = 2164 SF = 30.6%
PROPOSED IMPERVIOUS = 4223 SF = 59.9%
PROPOSED BUILDING COVERAGE = 2264 SF = 32%

*NO ADDITIONAL LOT COVERAGE PER THIS PERMIT

DATE: 2020/06/21
REV. SET DESCRIPTION: ISSUED PERMIT SET

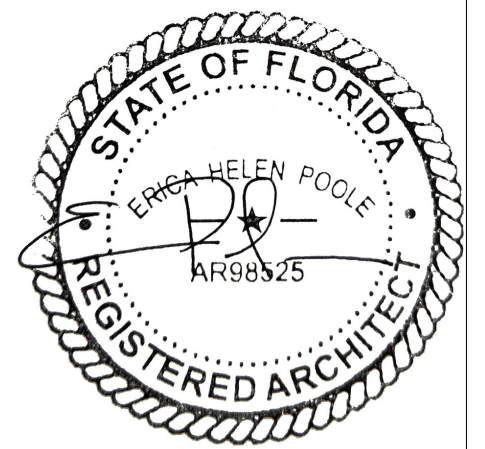

ERICA HELEN POOLE - ARCHITECT
#AR98525



SANDBAR DESIGN STUDIO
29785 CAMELLIA LANE
BIG PINE KEY, FL 33945
WWW.SANDBARDESIGNSTUDIO.COM
6479035554

HESSE ADDITION
643 William Street
Key West, FL 33040

SHEET
SITE PLAN

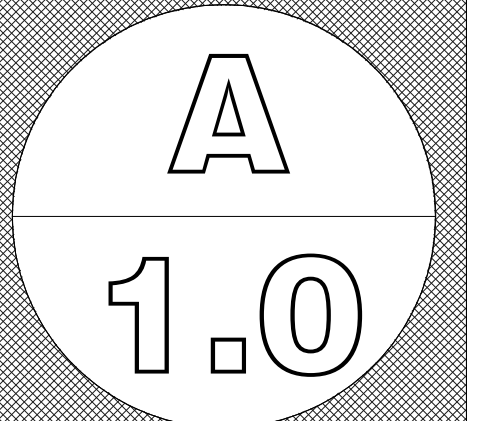

PROJECT: HES2021
DRAWN BY: EHP
APPROVED BY: EHP

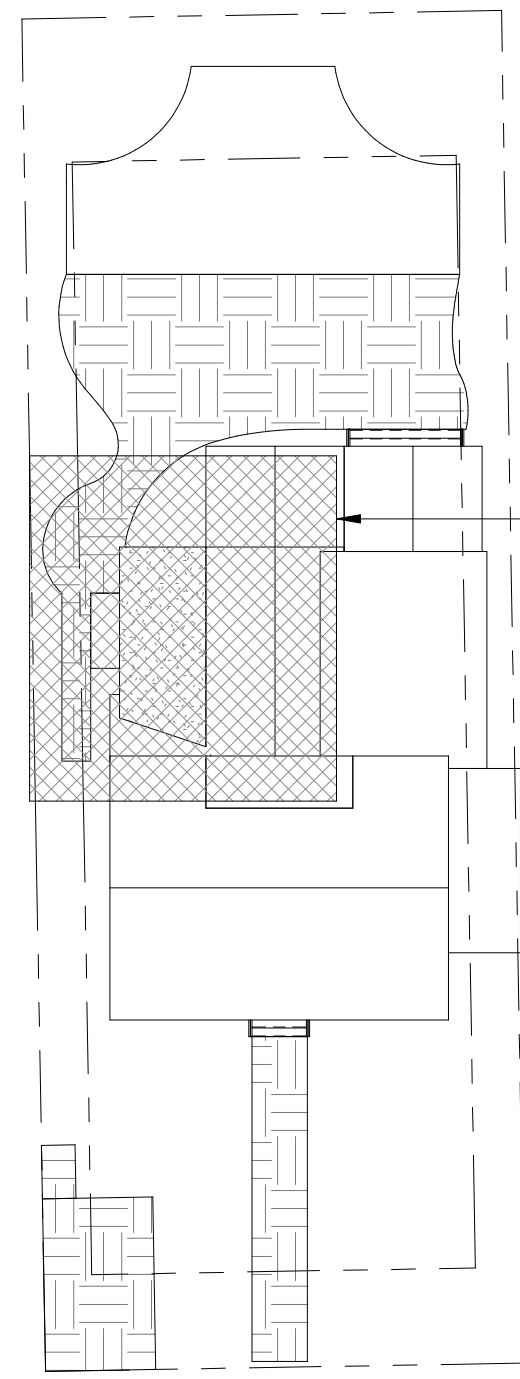

SCOPE OF WORK

3 LOCATION PLAN
A 2.0 1" = 20'-0"

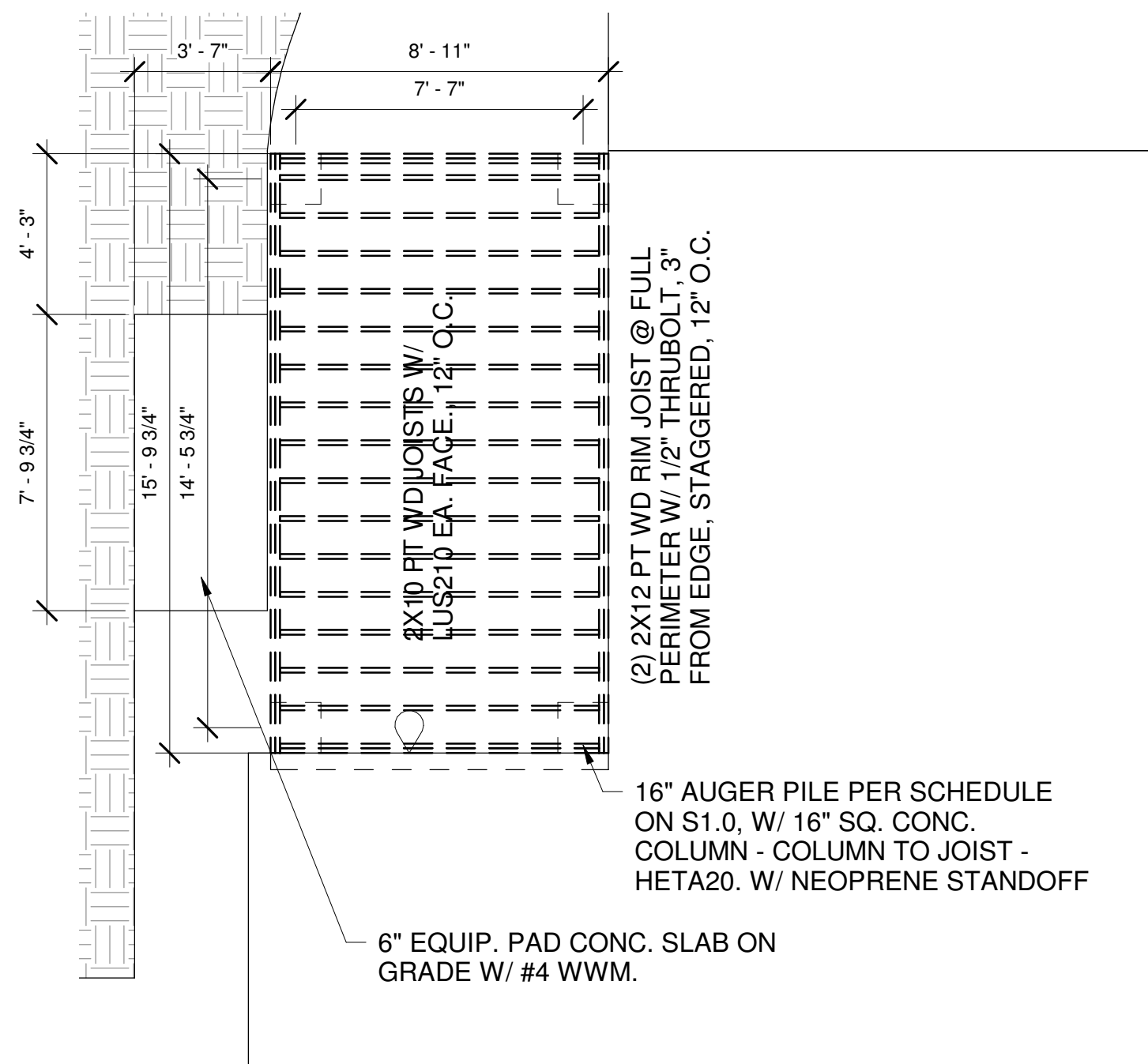

4 FOUNDATION PLAN
A 2.0 1/4" = 1'-0"

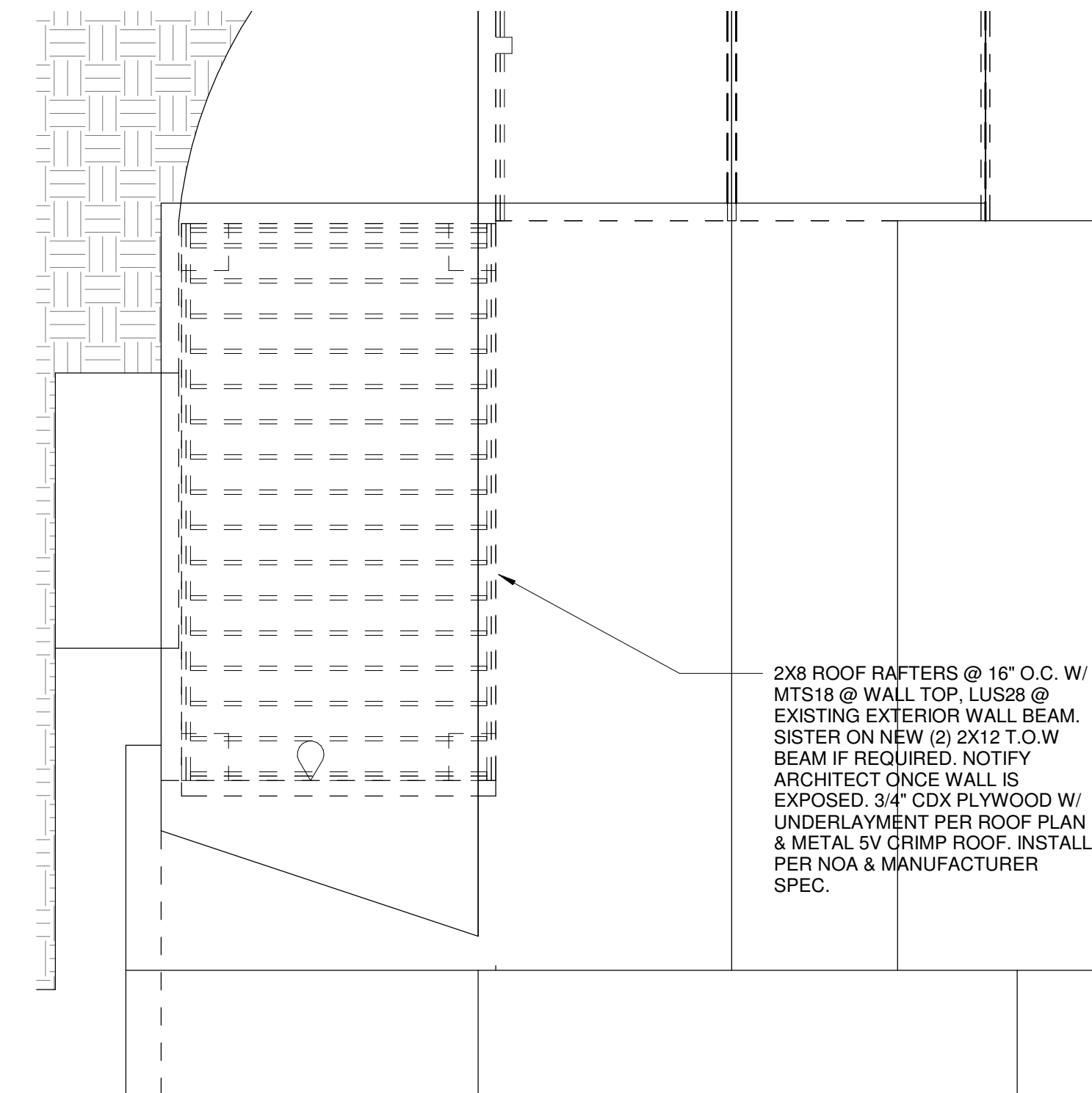

5 ROOF FRAMING PLAN
A 2.0 1/4" = 1'-0"

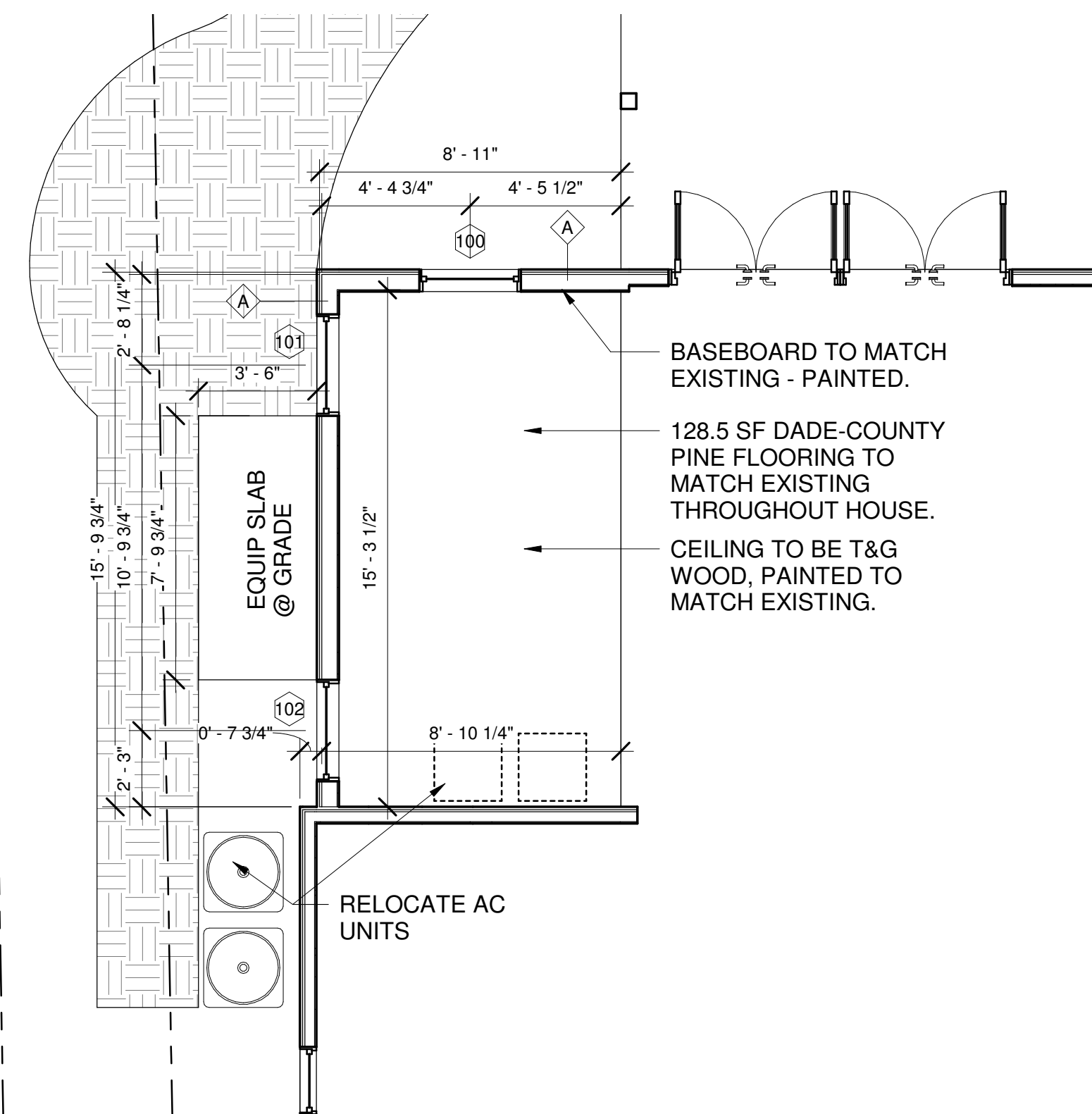

1 FIRST FLOOR
A 2.0 1/4" = 1'-0"

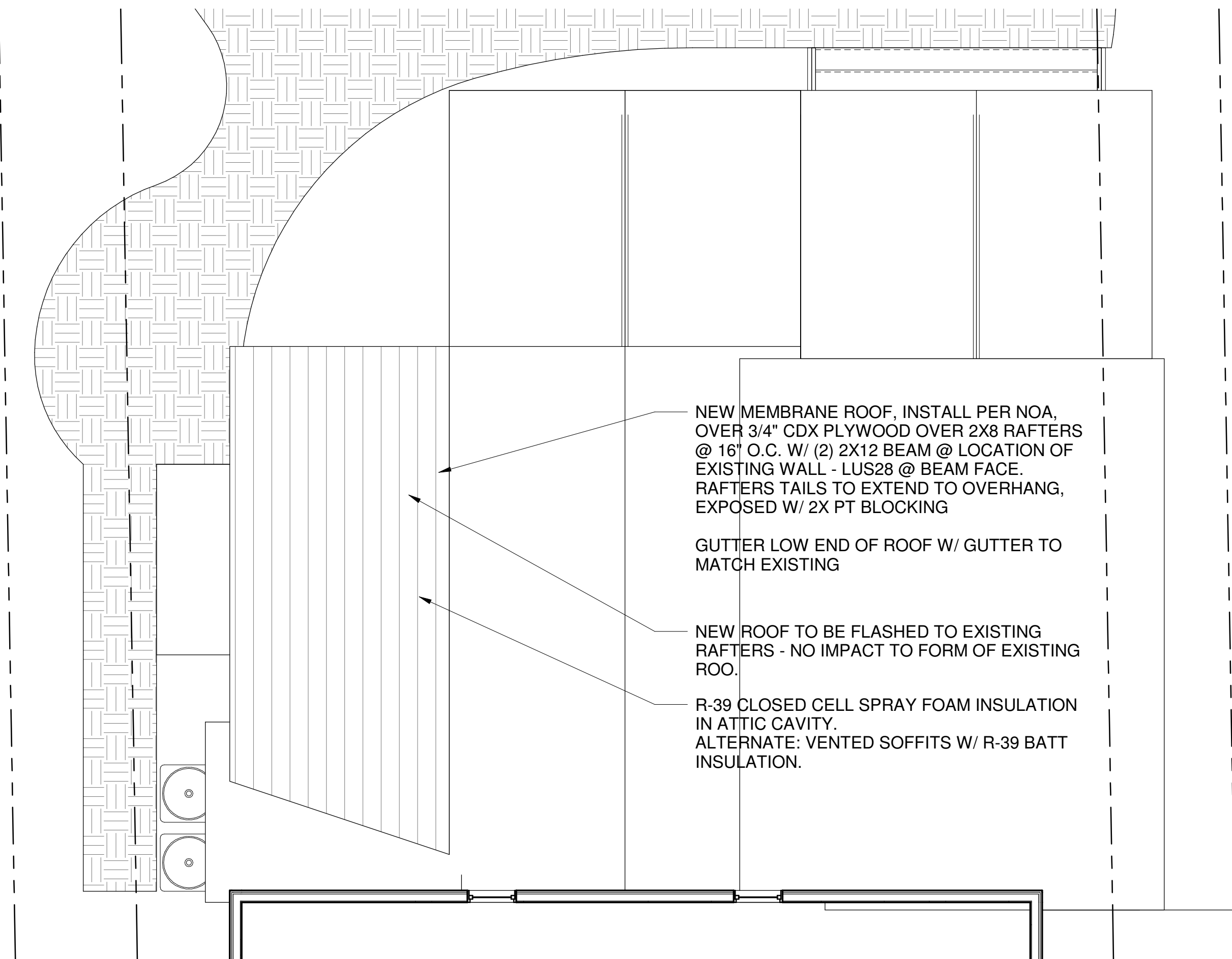

2 SECOND FLOOR
A 2.0 1/4" = 1'-0"

WALL SCHEDULE			
Mark	Type	Description	Thickness
	6" EXISTING EXTERIOR WALL	6" WD STUD WALL W/ 5/8" GWB INTERIOR; 3/4" PLYWOOD, WOOD SIDING	0' - 5 7/8"
A	6" WOOD STUD W/ SIDING EXTERIOR, GWB INTERIOR	6" WD STUD WALL W/ 5/8" GWB INTERIOR; 3/4" PLYWOOD, HARDI SIDING EXTERIOR (PAINT TO MATCH EXISTING) R-19 BATT INSULATION	0' - 7 7/8"

DATE: 2020/06/21
REV. SET DESCRIPTION: ISSUED PERMIT SET

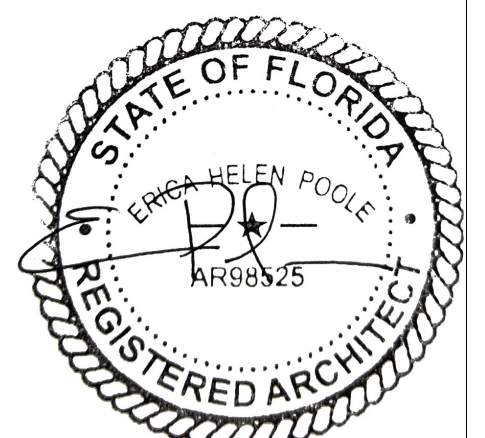

ERICA HELEN POOLE - ARCHITECT
#AR98525



HESSE ADDITION
643 William Street
Key West, FL 33040

SHEET ARCH/STRUCT PLANS

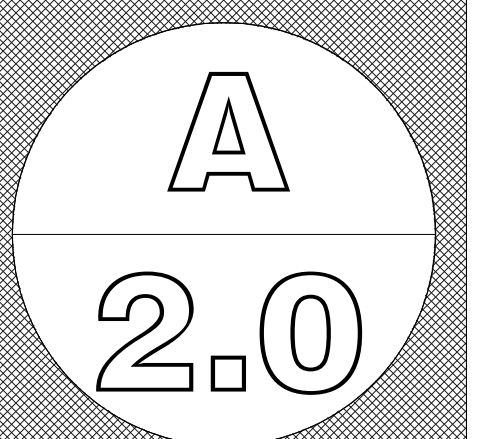

PROJECT: HES2021
DRAWN BY: EHP
APPROVED BY: EHP

WINDOW SCHEDULE

Mark	Manufacturer	Model	Assembly Description	Type	Individual Unit Width	Individual Unit Height	DP'S	Comments
100	ANDERSEN WINDOWS & DOORS	A-SERIES	IMPACT RATED SINGLE HUNG WINDOW	A	3'-0"	4'-0"	+58, -63	WHITE, TO MATCH EXISTING
101	ANDERSEN WINDOWS & DOORS	A-SERIES	IMPACT RATED SINGLE HUNG WINDOW	A	3'-0"	4'-0"	+58, -63	WHITE, TO MATCH EXISTING
102	ANDERSEN WINDOWS & DOORS	A-SERIES	IMPACT RATED SINGLE HUNG WINDOW	A	3'-0"	4'-0"	+58, -63	WHITE, TO MATCH EXISTING

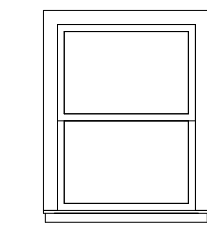

TYPE "A"
IMPACT RATED
SINGLE HUNG WINDOW

3 SIDE ELEVATION A - PROPOSED
A 3.0 1/4" = 1'-0"

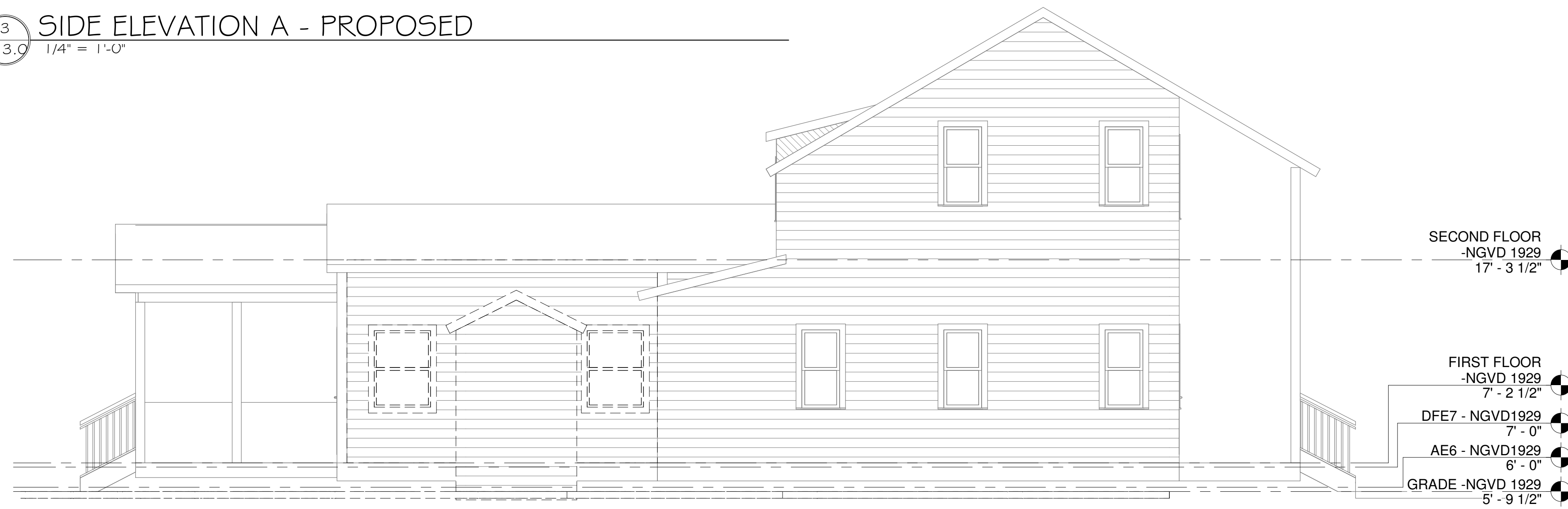

4 SIDE ELEVATION A - EXISTING
A 3.0 1/4" = 1'-0"

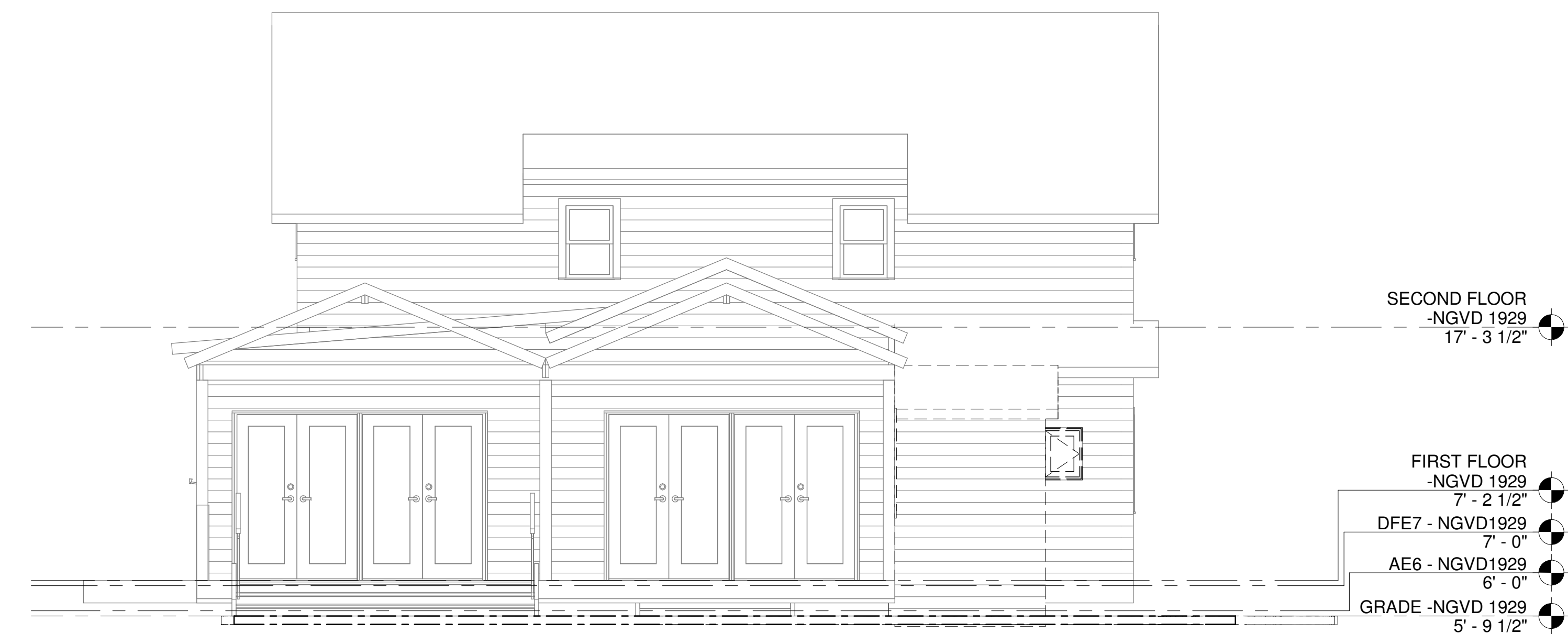

1 REAR ELEVATION - EXISTING
A 3.0 1/4" = 1'-0"



2 REAR ELEVATION - PROPOSED
A 3.0 1/4" = 1'-0"

DATE: 2020.06.21
REV. SET DESCRIPTION
ISSUED PERMIT SET

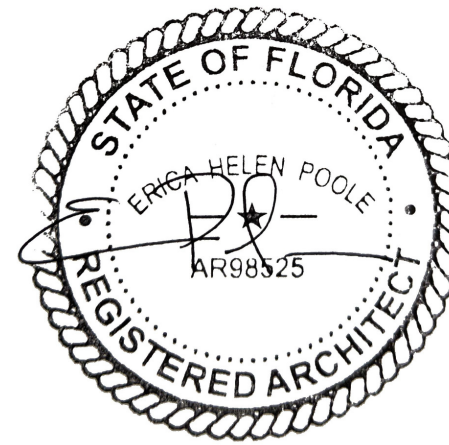

ERICA HELEN POOLE - ARCHITECT
#AR98525



SANDBAR DESIGN STUDIO
29185 CAMELLIA LANE
BIG PINE KEY, FL 33943
WWW.SANDBARDESIGNSTUDIO.COM
8479035854

HESSE ADDITION
643 William Street
Key West, FL 33040

SHEET ELEVATIONS & SCHEDULES

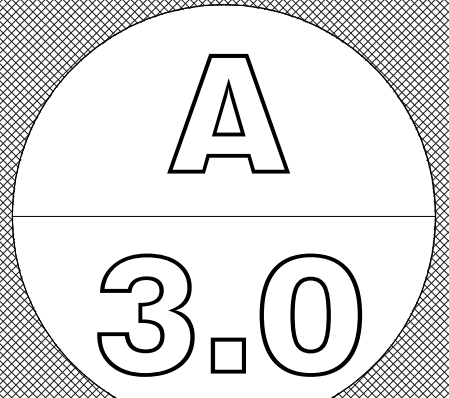

PROJECT: HES2021
DRAWN BY: EHP
APPROVED BY: EHP

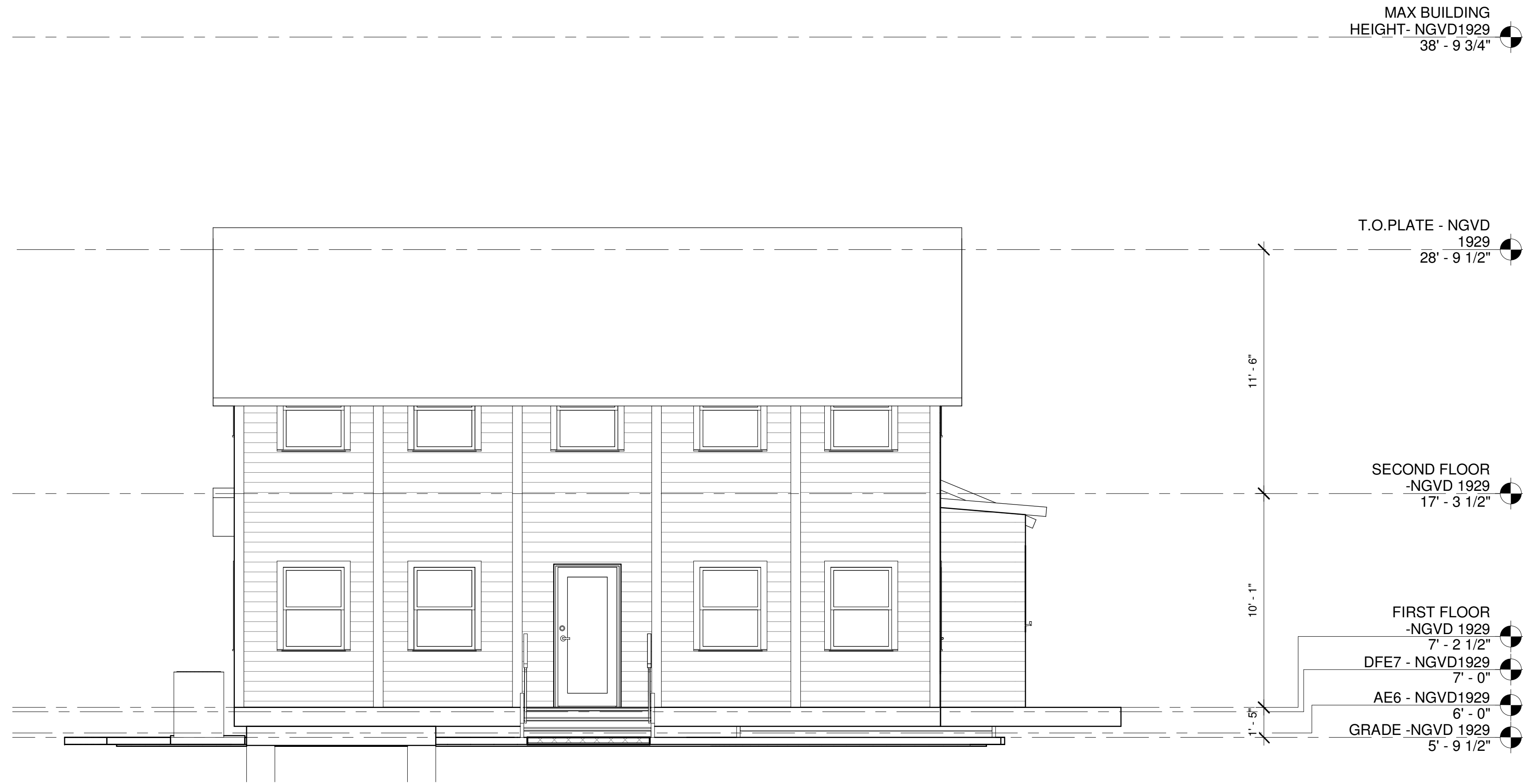

1 FRONT ELEVATION
A 3.1 1/4" = 1'-0"



2 SIDE ELEVATION B
A 3.1 1/4" = 1'-0"

DATE: 2020/06/21
REV. SET DESCRIPTION: ISSUED PERMIT SET

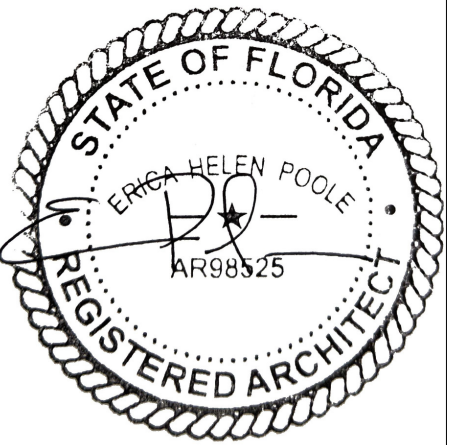

ERICA HELEN POOLE - ARCHITECT
#AR98525



SANDBAR DESIGN STUDIO
29185 CAMELLIA LANE
BIG PINE KEY, FL 33945
WWW.SANDBARDESIGNSTUDIO.COM 8479035854

HESSE ADDITION
643 William Street
Key West, FL 33040

SHEET ELEVATIONS

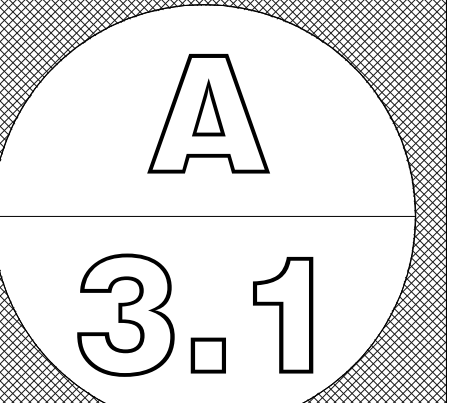

PROJECT: HES2021
DRAWN BY: Author
APPROVED BY: Checker

GENERAL AIR CONDITION NOTES:

- SCOPE OF WORK: PROVIDE HEATING, VENTILATION, AND AIR CONDITIONING SYSTEMS WHERE SHOWN ON THE DRAWINGS, AS SPECIFIED HEREIN, AND AS NEEDED FOR A COMPLETE AND PROPER INSTALLATION; INCLUDING BUT NOT LIMITED TO:
 - AIR CONDITIONING SUPPLY AND RETURN DUCTWORK SYSTEMS WITH GRILLES, DIFFUSERS, AND REGISTERS.
 - AIR CONDITIONING UNITS, PIPING AND COMPONENTS, OPERATING AND SAFETY CONTROLS, BLOWERS, MOTORS, FILTERS, AND RELATED ITEMS.
 - EXHAUST SYSTEMS INCLUDING BATHROOM FANS, MOTORS, DUCTWORK, GRILLES, REGISTERS, AND CONTROLS.
 - TEMPERATURE CONTROL SYSTEMS TO INCLUDE LOW VOLTAGE WIRING.
 - THERMAL INSULATION, DUCTS AND PIPING.
- DUCTWORK IN ATTIC SPACES LESS WITH THAN R-12 INSULATION SHALL BE INSULATED WITH 1-1/2" THICK R-6.5 KNAUF AIR DUCT TYPE E1-475 F/G WITH VAPOR BARRIER. DUCTWORK BETWEEN FLOORS, ENCLOSED ATTACHED GARAGES, UNCONDITIONED INTERIOR SPACES, AND ROOF WITH MIN R-12 INSULATION SHALL BE R-4.3 KNAUF AIR DUCT FIG TYPE E1800 WITH VAPOR BARRIER, UNLESS SPECIFIED OTHERWISE. DUCTWORK SHALL BE FABRICATED IN ACCORDANCE WITH THE MANUF SPECS AND IN ACCORDANCE TO ASHRAE AND SMACNA STANDARDS. ALL DUCTWORK AND INSULATION SHALL ALSO COMPLY WITH THE FLORIDA ENERGY CONSERVATION CODE SECTION R403.
- DUCT DIMENSIONS ARE IN INCHES AND CORRESPOND TO INSIDE DIMENSIONS. (WIDTH X HEIGHT OR DIAMETER). DUCT SYSTEMS SHALL COMPLY WITH NFPA STANDARD NO. 90A AND NFPA 90B. DUCTWORK AND COMPONENTS SHALL BE CLASS 1 MATERIALS IN ACCORDANCE WITH U.L. 181 TESTS. FIG DUCT SYSTEM STRAIGHT SECTIONS AND FITTINGS SHALL BE REINFORCED BY EITHER OR BOTH OF THE FOLLOWING METHODS: A) TIE ROD REINFORCEMENT AND OR B) CHANNEL REINFORCEMENT. REFER TO THE FIBROUS GLASS DUCT CONSTRUCTION STANDARDS AND MANUFACTURERS RECOMMENDATIONS. LONGITUDINAL SEAMS AND TRANSVERSE JOINT CLOSURES SHALL COMPLY WITH U.L. 181 A/P (PRESSURE SENSITIVE AL FOIL TAPE) OR U.L. 181 A/H (HEAT SELLABLE AL FOIL TAPE) OR MANUFACTURERS RECOMMENDATIONS FOR THE USE OF GLASS FABRIC MASTIC. DUCT SUPPORTS SHALL BE PLACES SO AS TO PROPERLY SUPPORT ALL FITTINGS AND ACCESSORIES WITHOUT PLACING THE TAPED JOINTS UNDER STRESS.
- THE AIR CONDITIONER (A/C) CONTRACTOR SHALL COORDINATE LOCATION, SIZES, AND OPENINGS WITH OTHER TRADES ON THE JOB. THE A/C CONTRACTOR SHALL PROVIDE THE COMPLETE DUCT SYSTEM WITH TURNING VALVES AT ALL ELBOW, AND INSTALL SPLITTERS AND DAMPERS AS REQUIRED OR AS SHOWN ON THE DRAWINGS.
- DIFFUSERS SHALL BE SELECTED, LOCATED AND BALANCED IN ORDER THAT THEY DELIVER THE REQUIRED CFM TO THE ENTIRE ROOM EVENLY AND DRAFT FREE TO THE FOLLOWING CONDITIONS:
 - INSIDE: COOLING 78 dB, HEATING 72 dB
 - OUTSIDE: 91 dB @ 79w49
 - RELATIVE HUMIDITY: 50% TO 60%
- ALL FAN MOTORS, COMPRESSORS, ETC. SHALL BE ISOLATED, AS REQUIRED TO OPERATE QUIETLY SO THAT NO OBJECTIONABLE SOUND WILL BE HEARD IN THE HABITABLE SPACES DUE TO AIR VELOCITY, MOTOR HUM, VIBRATION OR MECHANICAL MOVEMENT.
- THE A/C SYSTEM SHALL HAVE 1" AIR FILTERS AT SPECIFIED LOCATIONS AND AS REQUIRED FOR EASY ACCESS WITH A MINIMUM MERV RATING OF 8.
- THE A/C SYSTEM(S) SHALL BE CONTROLLED BY A THERMOSTAT MOUNTED 5'-0" ABOVE THE FINISH FLOOR.
- ALL GRILLES AND DIFFUSERS SHALL BE CONSTRUCTED OF ALUMINUM. ALL DIFFUSERS SHALL HAVE HIDDEN OPPOSE BLADE DAMPERS. PROVIDE GASKETS ON ALL GRILLES AND DIFFUSERS.
- ALL REFRIGERANT PIPING SHALL BE COPPER HARD DRAWN TYPE-ACR, DEHYDRATED, THEN SEALED. ALL FITTINGS SHALL BE WROUGHT COPPER. ALL JOINTS SHALL BE MADE WITH HIGH TEMPERATURE BRAZING ALLOY OF NOT LESS THAN 5% SILVER. PIPING INSULATION NOT LESS THAN 3/4" THICK 'AR AFLEX' LIQUID AND SUCTION LINES SHALL BE SIZED IN ACCORDANCE WITH EQUIPMENT MANUFACTURERS RECOMMENDATIONS FOR EQUIVALENT LENGTH OF PIPING RUN FOR CONNECTED TONNAGE. ALL PIPING ACCESSORIES SHALL BE CONSTRUCTED AS SUGGESTED BY EQUIPMENT MANUFACTURER. PROVIDE FILTER/DRYER AND SIGHT GLASS ON LIQUID LINES. REFRIGERANT PIPING SYSTEM SHALL BE COMPLETELY EVACUATED TO 26" OF MERCURY VACUUM (GAGE PRESSURE) USING A VACUUM PUMP AND HELD FOR A MINIMUM OF 24 HRS. COMPRESSORS SHALL NOT BE USED TO EVACUATE SYSTEMS. CHANGE THE OIL IN THE VACUUM PUMP BEFORE VACUUM IS PULLED. VACUUM SHALL BE BROKEN WITH THE OPENING OF REFRIGERANT.
- ALL VENTILATION DUCTWORK SHALL BE SHEET METAL INSTALLED ACCORDING TO THE LATEST EDITION OF 'SMACNA' AND 'ASHRAE' FOR LOW PRESSURE DUCT SYSTEM. FLEXIBLE DUCT SHALL BE CLASS 1 U.L. LISTED, PROVIDE FOSTER 32-50 AT ALL SHEET METAL DUCT CONNECTIONS.
- THE A/C CONTRACTOR SHALL THOROUGHLY EXAMINE THE SITE AND SHALL BE RESPONSIBLE FOR ANY AND ALL FIELD CONDITIONS AFFECTING A/C WORK. CONTRACTOR SHALL COORDINATE WORK WITH THE OTHER TRADES.
- ALL WORK AND MATERIALS SHALL BE IN ACCORDANCE WITH THE FLORIDA RESIDENTIAL CODE, ALL OTHER APPLICABLE STATE, COUNTY AND LOCAL CODES AND ORDINANCES (LATEST EDITIONS).
- TESTING AND BALANCE SHALL BE PERFORMED BY AN INDEPENDENT TEST AND BALANCE CONTRACTOR WHO IS A MEMBER OF THE ASSOCIATED AIR BALANCE COUNCIL. TEST AND BALANCE REPORT SHALL BE APPROVED BY THE ARCHITECT OF RECORD BEFORE CERTIFICATION OF OCCUPANCY.
- A CONDENSATE DRAIN SHALL BE PROVIDED FOR EACH AHU AND IT SHALL BE RUN TO AN APPROPRIATE DRAIN. THE CONDENSATE DRAIN SYSTEM SHALL MEET ALL APPLICABLE PLUMBING CODES. UPSIZE CONDENSATE LINES FOR SMALL CAPACITY SPLIT SYSTEM FROM 3/4" TO 1-1/4".
- ELECTRICAL CONTRACTOR TO PROVIDE DISCONNECTS FOR INDOOR AIR HANDLING UNIT AND OUTDOOR CONDENSING UNIT.
- PROPER OPERATIONS AND MAINTENANCE MANUALS SHALL BE PROVIDED TO THE OWNER FOR EACH SYSTEM AND MAJOR COMPONENT.
- MECHANICAL COOLING EQUIPMENT SHALL BE SPLIT COOLING ONLY SYSTEMS WITH ELECTRIC HEAT STRIPS. WHERE LOCATED LESS THAN 5 MILES FROM THE COAST LINE AND ANY OTHER SALT WATER BODY THE OUTSIDE CONDENSING UNIT SHALL BE PROVIDED WITH CONDENSER COATINGS FOR COASTAL APPLICATIONS. NO ELECTRICAL HEAT IS REQUIRED.
- PROVIDE EXHAUST FANS AND DRYER VENTS WITH GRAVITY BACKDRAFT DAMPERS ON DISCHARGE AIR STREAM.

NOTES:

- OUTSIDE AIR IS PROVIDED BY NATURAL VENTILLATION IN ACCORDANCE WITH FMC 402.1.
- EXISTING AIR HANDLERS AND CONDENSING UNITS TO REMAIN.
- MECHANICAL CONTRACTOR TO ADD IN FLOOR REGISTERS, TO MATCH EXISTING, AS LOCATED ON MEP 2.0.
- ALL EXTERIOR DUCTWORK TO BE PROPERLY HUNG FROM STRUCTURE BELOW.

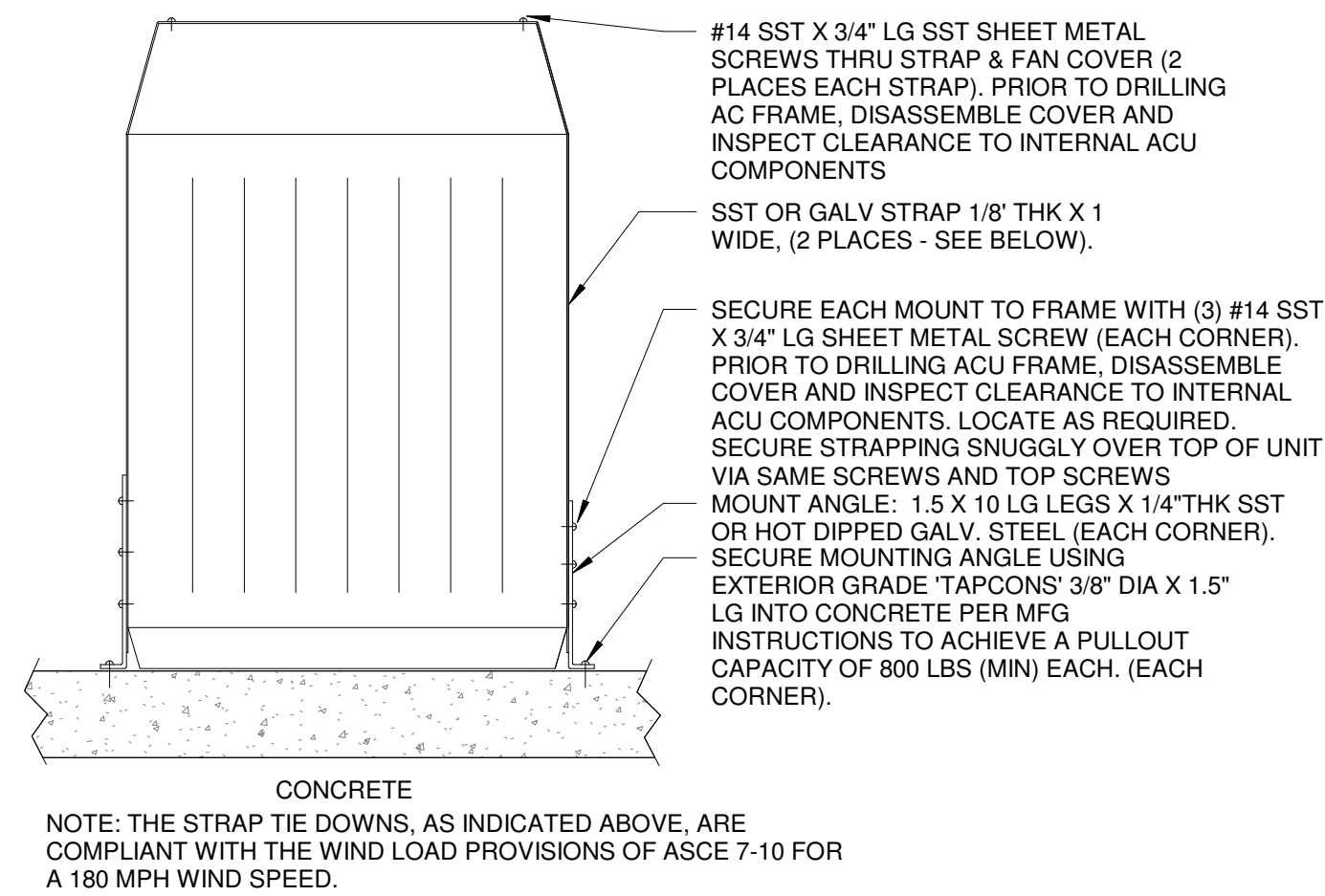

5 EXTERNAL ACU MOUNTING DETAIL
MEP 2.0 3/4" = 1'-0"

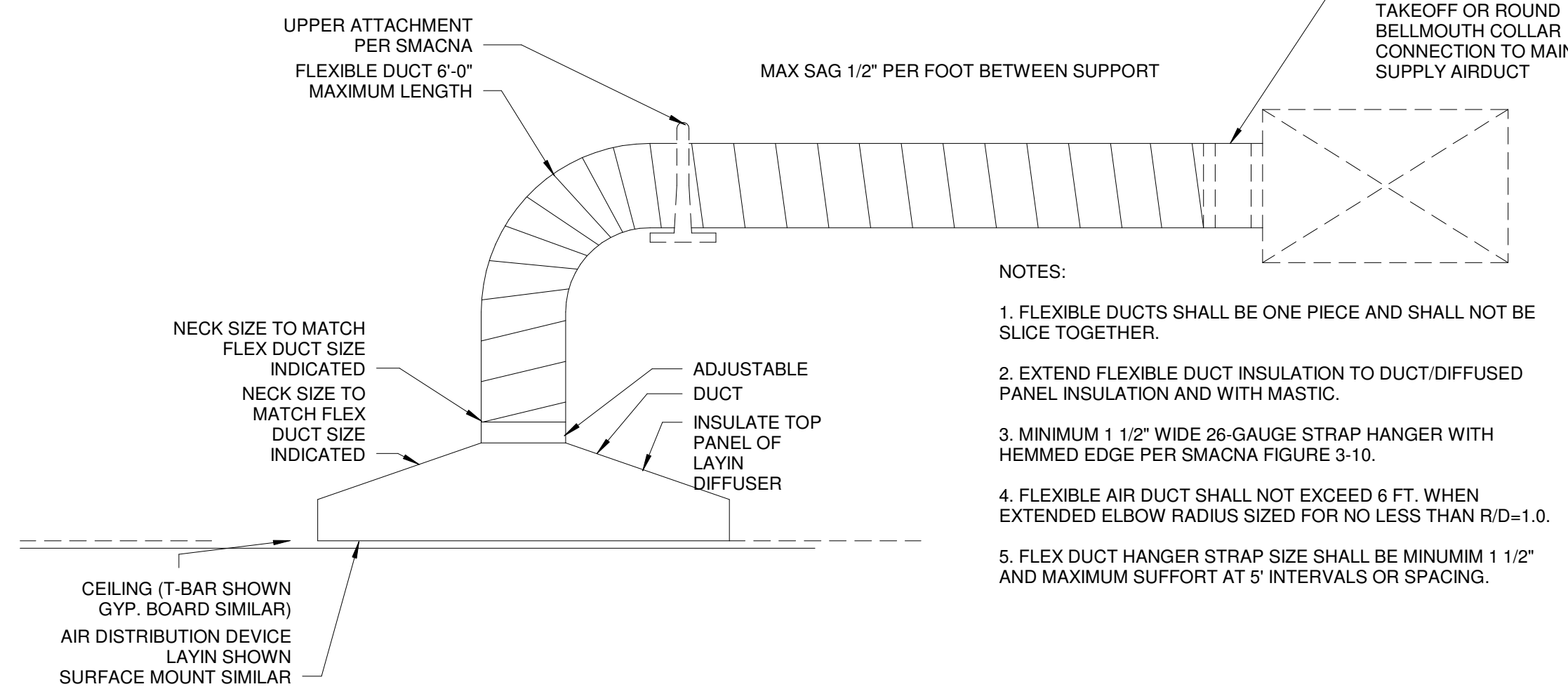

4 FLEXIBLE DUCT TAKEOFF DETAIL
MEP 2.0 3/4" = 1'-0"

ELECTRICAL NOTES

- ALL ELECTRICAL WORK SHALL CONFORM TO THE LATEST EDITION OF THE LOCAL BUILDING CODE HAVING JURISDICTION AND THE NATIONAL ELECTRICAL CODE. ALL MATERIALS SHALL BEAR AN UNDERWRITERS LABORATORIES LABEL OR BE U.L. LISTED. WORKMANSHIP SHALL BE IN ACCORDANCE WITH GOOD TRADE PRACTICES. ALL EXCAVATING AND BACKFILLING REQUIRED FOR ELECTRICAL WORK SHALL BE THE RESPONSIBILITY OF THE ELECTRICAL SUBCONTRACTOR.
- CONNECTIONS TO EQUIPMENT: ELECTRICAL SUBCONTRACTORS SHALL VERIFY NAMEPLATE DATA OF A/C EQUIPMENT, WATER HEATERS AND OTHER EQUIPMENT TO OBTAIN CORRECT WIRE SIZES AND OVER-CURRENT PROTECTION PRIOR TO INSTALLATION OF ROUGH ELECTRICAL WIRING. THE ELECTRICAL SUBCONTRACTOR SHALL MAKE THE ELECTRICAL CONNECTION TO ALL EQUIPMENT REQUIRING CURRENT. ALL CONTROL WIRING SHALL BE CARRIED OUT BY THE ELECTRICAL SUBCONTRACTOR AS DIRECTED BY MECHANICAL CONTRACTORS.
- OVERHEAD ELECTRICAL CONDUCTOR CLEARANCES, HORIZONTAL AND VERTICAL SHALL BE MAINTAINED.
- ALL WIRING CONDUCTORS SHALL BE INSULATED ELECTRICAL GRADE ANNEALED COPPER.
- ALL WIRE TO BE INSIDE ELECTRICAL NON-METALLIC TUBING (AKA SMURF). ALL EXTERIOR AND ALL-WEATHER LOCATIONS TO HAVE GRAY RIGID PVC ELECTRICAL CONDUIT.
- ALL #12 AND #10 WIRE TO BE SOLID, WIRES LARGER THAN #10 TO BE STRANDED IN ACCORDANCE WITH ASTM.
- BATHROOM, GARAGE, AND EXTERIOR RECEPTACLES SHALL BE EQUIPPED WITH GROUND FAULT CIRCUIT INTERRUPTERS.
- ELECTRICAL INSTALLATION DESIGN IS IN COMPLIANCE AS SET FORTH BY THE STATE OF FLORIDA STATUTES MODEL ENERGY EFFICIENCY CODES.
- SMOKE DETECTORS SHALL BE HARD WIRED (110 VOLT) TO A NON-SWITCHABLE KITCHEN OR BATHROOM LIGHTING CIRCUIT AND SHALL NOT BE CONNECTED ON TO THE LOAD SIDE OF A GROUND FAULT INTERRUPTER.
- FURNISH AND INSTALL UNDERGROUND RACEWAYS FOR POWER COMPANY SERVICE AND TELEPHONE COMPANY SERVICE AS PER UTILITY COMPANY SPECIFICATIONS AND COORDINATE THE EXACT ROUTING OF THESE RACEWAYS WITH THE UTILITY COMPANY.
- VERIFY EXACT LOCATION OF ELECTRICAL OUTLETS AND LIGHTS PRIOR TO EXECUTION OF ROUGH-IN WORK.
- ALL RACEWAYS AND NON-CURRENT CARRYING METAL ENCLOSURES SHALL BE MECHANICALLY AND ELECTRICALLY GROUNDING.
- ALL RACEWAYS IN FINISHED AREAS SHALL BE CONCEALED AND ALL OUTLETS IN FINISHED AREAS SHALL BE MOUNTED FLUSH WITH FINISHED WALLS.
- ALL WORK SHALL BE RIGIDLY MOUNTED AND SUPPORTED.
- SWIMMING POOL ELECTRICAL INSTALLATION SHALL BE IN STRICT ACCORDANCE WITH THE LATEST EDITION OF THE NATIONAL ELECTRICAL CODE.
- ELECTRICAL OUTLETS, RECEPTACLES AND LIGHTING BELOW BASE FLOOD ELEVATION SHALL BE INSTALLED AT HIGHEST PERMITTED ELEVATION AND SHALL BE INSTALLED ON A SEPARATE INDEPENDENT CIRCUIT FROM THOSE IN HABITABLE AREAS.
- NO APPLIANCE OUTLETS SHALL BE INSTALLED BELOW THE BASE FLOOD ELEVATIONS.
- A/C COMPRESSORS SHALL BE INSTALLED ABOVE THE BASE FLOOD ELEVATION.
- MAIN CIRCUIT BREAKER PANEL SHALL BE INSTALLED ABOVE THE BASE FLOOD ELEVATION.
- NO RECEPTACLES SHALL BE PERMITTED WITHIN 15 FEET OF A POOL.
- ALL WATER HEATERS SHALL BE MECHANICALLY GROUNDING.

NOTES:

- ALL NEW ELECTRICAL TO RUN TO EXISTING BREAKERS.
- ALL RELOCATION OF EQUIPMENT TO BE COORDINATED BY CONTRACTOR. NO INCREASE IN LOADING IS PROPOSED WITH THIS ADDITION.
-

ELECTRICAL

□ DUPLEX OUTLET	Ⓜ SINGLE POLE SWITCH	Ⓜ 4" RECESSED LED CAN		CEILING FAN W/ LIGHT
46" GFCI □ 46" GFCI OUTLET	3 □ THREE WAY SWITCH	Ⓜ 4" RECESSED WATERPROOF LED CAN		
A □ APPLIANCE OUTLET	4 □ FOUR WAY SWITCH	Ⓜ 6" RECESSED LED CAN		TWO TUBE FLUORESCENT
WP GFI □ WATERPROOF GROUND FAULT INTERRUPTER	5 □ FIVE WAY SWITCH	Ⓜ WALL MOUNTED LIGHT		
Ⓜ 220 OUTLET	DIM □ DIMMER SWITCH	Ⓜ SURFACE MOUNTED LIGHT		
Ⓜ CEILING OUTLET	Ⓜ GARAGE DOOR BUTTON	Ⓜ EXHAUST FAN W/ LIGHT		
D □ DATA OUTLET	Ⓜ DOOR BELL CHIME	Ⓜ EXHAUST FAN		
TV □ TV OUTLET	Ⓜ DOOR BELL BUTTON	Ⓜ EXTERIOR FLOOD LIGHT		
		Ⓜ SMOKE DETECTOR		

NOTES

- ALL ELECTRICAL OUTLETS AND EQUIPMENT TO BE ABOVE FLOOD
- ALL EXTERIOR OUTLETS TO BE WATERPROOF AND GFI
- ALL DATA & TV TO BE INDEPENDENT RUNGS
- ALL DATA OUTLETS TO BE WIRED W/ (1)-CAT6
- ALL TV OUTLETS TO BE WIRED W/ (1)-RG6 & (4)-CAT6
- ALL TV & DATA WIRES TO BE LABELED @ EACH TERMINATION POINT
- ALL EXTERIOR DATA RUNS TO BE DIRECT BURIAL CAT6 IN CONDUIT

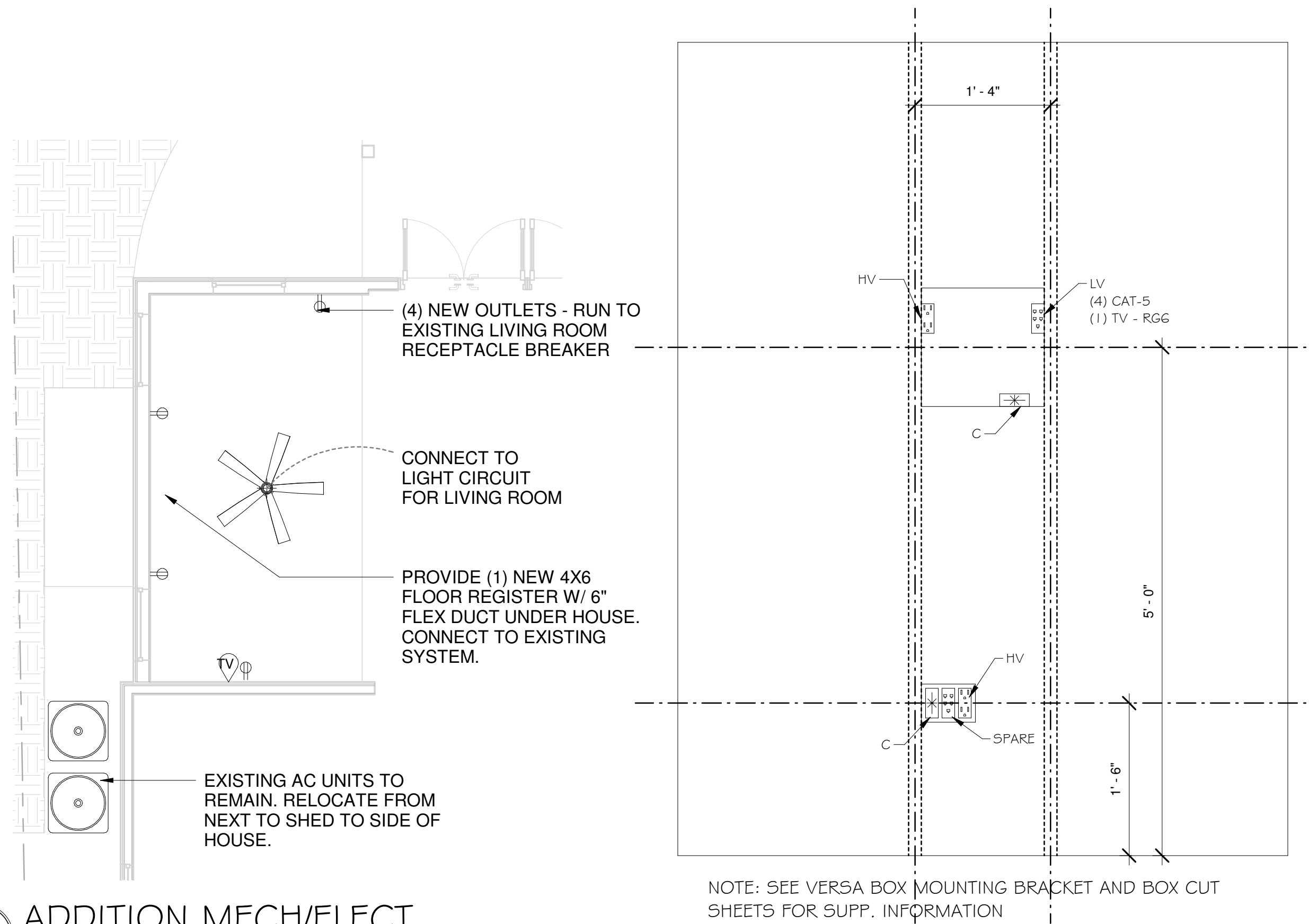

2 ADDITION MECH/ELECT
MEP 2.0 1/4" = 1'-0"

6 AV VERSA BOX
MEP 2.0 1" = 1'-0"

DATE: REV. SET/DESCRIPTION
2020/06/21 ISSUED PERMIT SET

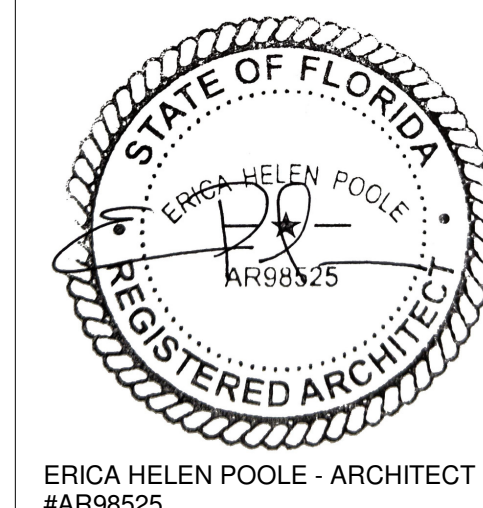

ERICA HELEN POOLE - ARCHITECT
#AR98525

SANDBAR
DESIGN STUDIO

SANDBAR DESIGN STUDIO
29185 CAMELLIA LANE
810 PINE KEY, FL 33945
WWW.SANDBARDESIGNSTUDIO.COM
8479035854

HESSE ADDITION
643 William Street
Key West, FL 33040

SHEET
MECH/ELECT NOTES & DETAILS

MEP
2.0

PROJECT: HES2021
DRAWN BY: EHP
APPROVED BY: EHP

STRUCTURAL

1010 GENERAL

Structural Drawings are to be used with Specifications, Architectural, Mechanical, Electrical, Plumbing, and Site Drawings as a part of the Contract Documents. Consult these drawings for features and details not shown on the Structural Drawings. Drawing discrepancies must be brought to the attention of the Engineer before proceeding. Dimensions and conditions must be verified in the field.

The structure is designed to be stable and self supporting when complete. It is the Contractor's responsibility to determine means and methods of construction to provide stability for the building and its components during erection. This includes any temporary bracing, shoring, guys, or tie-downs.

1050 DESIGN LOADS

The structural design for this building is in accordance with the Florida Building Code, 7th Edition (2020).

COMPONENT AND CLADDING LOADING DIAGRAM

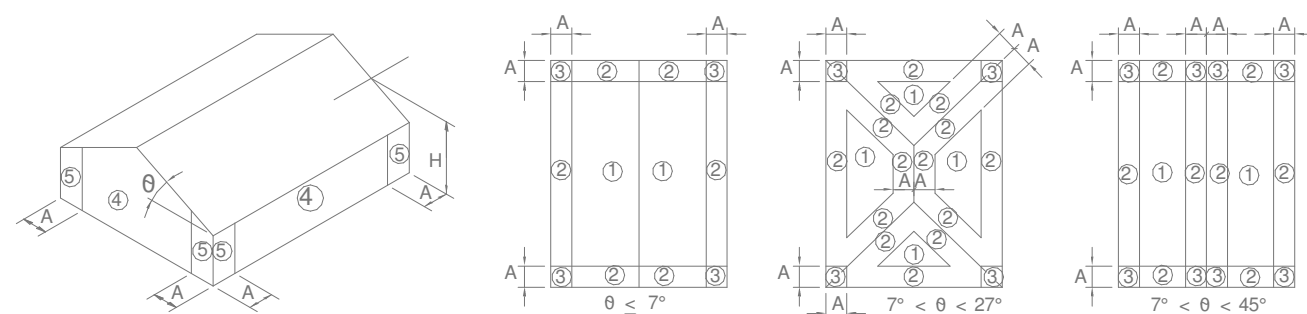

ALLOWABLE STRESS DESIGN PRESSURES (psf)

EFFECTIVE WIND AREA (FT ²)	WALL PRESSURES		ROOF PRESSURES				
	INTERIOR ZONE	END ZONE	INTERIOR ZONE	END ZONE	CORNER ZONE	OVERHANG ZONE	OVERHANG ZONE
10	+58 -63	+58 -78	+33 -53	+33 -92	+33 -136	-117	-190
20	+55 -62	+55 -73	+31 -52	+31 -85	+31 -127	-117	-171
50	+53 -57	+53 -65	+26 -50	+26 -75	+26 -114	-117	-151
100	+50 -53	+50 -60	+24 -48	+24 -68	+24 -107	-117	-132

End Zones = 3.2 Feet

2340 AUGERCAST CONCRETE PILES -

Piles shall be 16" round with 36" embedment into cap rock. Mortar shall be 4,000 psi at 28 days of a type designed for this purpose. Reinforcing steel shall conform to ASTM A615. The mortar shall be placed within 1-1/2 hours. Test shall be with one set of cubes for each 50 yards in accordance with ASTM 109. The design is based on a capacity of 25 tons compression and 12 tons tension. Reinforce with (4) #6's by vertical with #3 ties at 10" o/c plus (1) #7 centered held by centering devices spacing.

3120 SHORING

Shores are to remain in place until the concrete has reached 2/3 of the 28 design strength. Shoring and reshoring shall be in accordance with ACI 301 and 347.

3210 REINFORCING STEEL

Steel shall be clean deformed bar, ASTM A615 Grade 60. Fabricate and place steel in accordance with ACI Manual of Standard Practice and ACI 318-08 unless noted otherwise. Specified concrete cover unless noted otherwise for reinforcement shall be:

Cast against earth	3"
Exposed to weather	2"
Slabs, walls, joists	3/4"
Beams, columns	1-1/2"

CONCRETE NOT EXPOSED TO WEATHER AND CAST OVER 6 MIL VAPOR BARRIER

SLABS AND WALLS	3/4"
BEAMS AND GIRDER TIES	1-1/2"
COLUMN TIES	1-1/2"

3320 CONCRETE

Concrete shall be an approved mix design to achieve a compressive strength at 28 days, as scheduled below, placed in accordance with ACI standards and specifications. Mixes batched over 90 minutes before final placing shall not be used. Mix designs with coarse aggregate of 3/8" (#89) or smaller may not be used. Foundations & slabs on grade 5000 psi
All other structural concrete 5000 psi

Mix design; shall comply with ACI 318-08, Exposure categories FO, SO, PO, C1. Admixtures with calcium chlorides will not be accepted. The concrete shall comply with the requirements of ASTM C94 for measuring, mixing, and transporting.

All slabs are to be cured using a curing compound meeting the requirements of ASTM C309. The contractor must verify the curing compound is compatible with subsequent concrete covering products. The compound is to be placed as soon as the finishing is completed. Scuffed or exposed areas of the membrane are to be recoated.

3600 EPOXY ANCHORS

Epoxy anchors shall be an equal two part epoxy polymer cartridge injection system Powers PE 1000+ or Engineer approved substitution. Embedment shall be 9 bar diameters or 6" minimum unless noted otherwise, installed in accordance with the manufacturer's instructions. Installers shall be trained by the manufacturer's representative. Uphand installation is not approved for this product.

4200 MASONRY

Concrete masonry units shall be in accordance with ASTM C90, 1,900 psi on the net area, fm = 1,500 psi. Mortar shall be ASTM C270, Type M or S. Grout shall meet ASTM C476, 2,000 psi minimum compressive strength.

Masonry units shall be grout filled with vertical reinforcing at corners, intersections, each side of openings over 4 feet wide, and as shown on the plans. Provide hooked dowels in footings for vertical reinforcing above. Lap splices for reinforcing in masonry is 48 bar diameters. Provide 9 gage ladder type galvanized horizontal joint reinforcing at every other block course.

4210 TIE BEAMS

Beams prefixed with TB- shall have concrete placed after masonry below is in place. Vertical reinforcing shall be continuous through tie beams. Provide hooked vertical reinforcing in tie beams for roof tie beams less than 16" deep. Tie beam reinforcing shall be continuous, 20" lap minimum, and includes corner bars. Use metal lath or non-aluminum screening to confine the concrete in the tie beams.

4220 LINTELS

Masonry openings up to 8 feet wide may be spanned with precast lintels unless noted otherwise as manufactured by Cast Crete Corp. Type 8FB-1B/IT or engineer approved substitution. Openings up to 16 feet wide may be spanned with a cast in place 8" by 16" concrete beam with (2) #5 reinforcing bars top and bottom unless noted otherwise. Lintels shall bear 8" minimum on each end.

5720 RAILINGS

The railing system and its connections to the building shall be designed for a 200lb. load at the top of the rail and in accordance with the Florida Building Code, 2014, Section 1607.8.1.

STANDARD DESIGN CRITERIA

- WINDSPEED = 180 MPH/ASCE 7-10
- FLOOR LIVE LOAD = 40 LB/SQ FT
- ROOF LIVE LOAD = 20 LB/SQ FT
- FLOOR DEAD LOAD = 20 LB/SQ FT
- ROOF DEAD LOAD = 20 LB/SQ FT
- EXPOSURE = "D"
- BUILDING RISK CATAGORY 2
- INTERNAL PRESSURE COEFFICIENT = 0.18

WIND LOAD CERTIFICATION

2021 CERTIFICATE OF COMPLIANCE

THIS IS TO CERTIFY THAT I AM A DULY QUALIFIED, PROFESSIONAL ARCHITECT LICENSED TO PRACTICE IN THE STATE OF FLORIDA.

THE PILINGS, COLUMNS, AND STRUCTURAL SUPPORTS ARE DESIGNED AND ANCHORED SO AS TO WITHSTAND ALL APPLIED LOADS OF THE BASE FLOOD FLOW.

THE BUILDING AND EVERY PART THEREOF HAS BEEN DESIGNED TO WITHSTAND (WITHOUT ALLOWANCE FOR THE EFFECTS OF SHIELDING BY OTHER STRUCTURES), THE WIND LOADS GENERATED BY A 180 MPH BASIC WIND SPEED, IN ACCORDANCE WITH

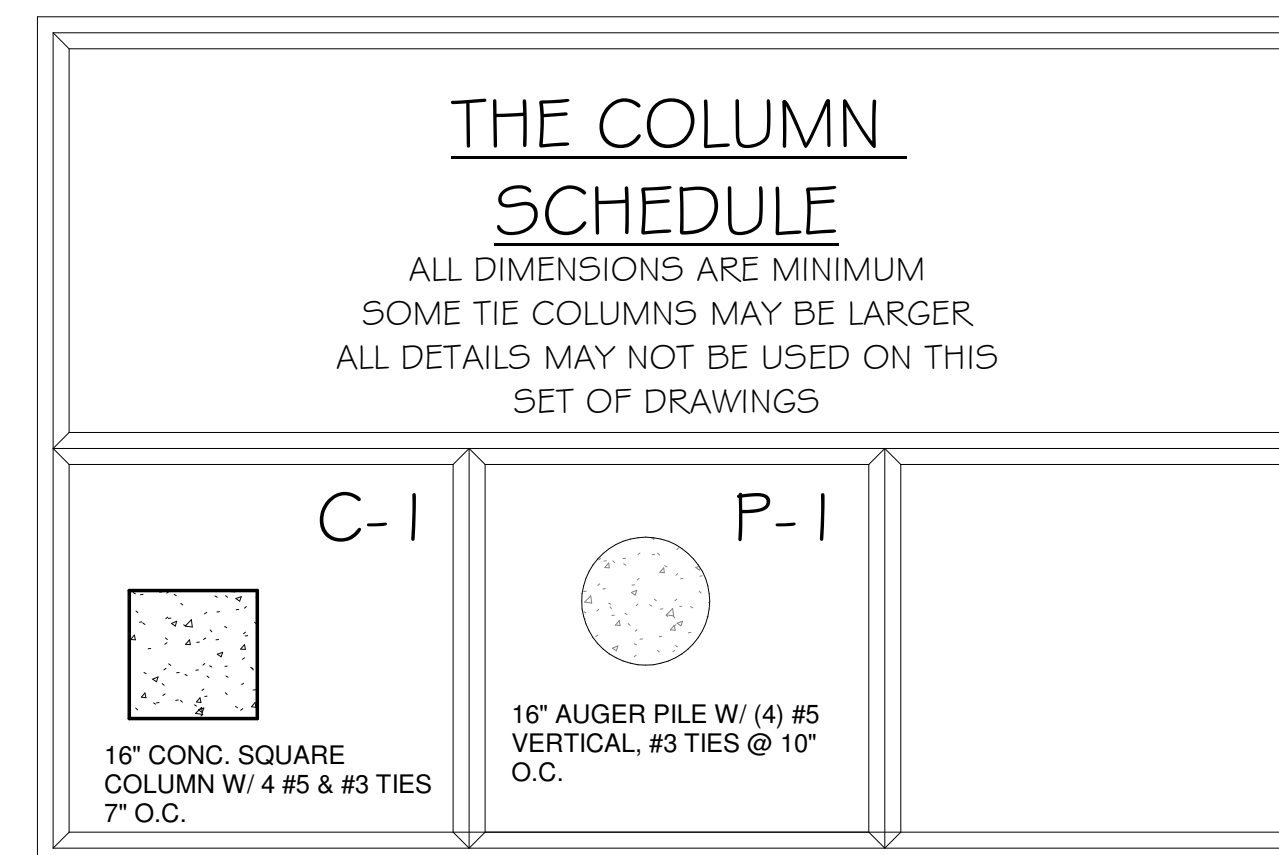

LUMBER & FRAMING NOTES

1. FRAMING LUMBER +/- SHALL CONFORM WITH THE PROVISIONS OF THE AMERICAN SOFTWOOD LUMBER STANDARD PS-20 (LATEST EDITION) AND EACH PIECE SHALL BEAR THE GRADE STAMP OF AN APPROVED AGENCY.
 2. FRAMING LUMBER GRADES +/- THE FOLLOWING GRADES SHALL BE THE MINIMUM ACCEPTABLE GRADES, UNLESS OTHERWISE NOTED ON THE DRAWINGS.
- | | |
|---|---|
| ITEM | MINIMUM GRADE |
| STUD ONLY:
2" TO 4" THICK +/- 2" TO 4" WIDE | NO. 2 SOUTHERN PINE |
| STRUCTURAL LIGHT FRAMING:
2" TO 4" THICK +/- 2" TO 4" WIDE | NO. 2 SOUTHERN PINE |
| STRUCTURAL JOISTS & HEADERS:
2" TO 4" THICK +/- 6" AND WIDER | NO. 2 SOUTHERN PINE |
| POST:
4" X 4" AND LARGER | NO. 2 SOUTHERN PINE OR
NO. 2 DOUGLAS FIR |
3. BOLT HOLES SHALL BE 1/16" LARGER THAN THE BOLT SIZE. RETIGHTEN ALL NUTS PRIOR TO CLOSING IN.
 4. STANDARD CUT WASHERS SHALL BE USED UNDER BOLT HEADS AND NUTS AGAINST WOOD.
 5. ALL LUMBER IN CONTRACT WITH MASONRY OR CONCRETE SHALL BE PRESSURE TREATED OR OTHERWISE BE PROTECTED BY AN APPROVED SEPARATING MATERIAL. BOLTS SHALL BE PLACED 9" FROM ANY NOTCH GREATER THAN 1/2 THE WIDTH OF A MEMBER.
 6. DO NOT NOTCH JOISTS, RAFTERS, OR BEAMS. OBTAIN ENGINEER'S OR ARCHITECT'S APPROVAL FOR ANY HOLES OR NOTCHES NOT DETAILED. HOLES THROUGH SILLS, PLATES, STUDS AND DOUBLE PLATED IN INTERIOR, BEARING AND SHEAR WALLS SHALL NOT EXCEED 1/3 THE PLATE WIDTH. USE BORED HOLES LOCATED IN THE CENTER OF THE STUD OR PLATE.
 7. 2" SOLID BLOCKING SHALL BE PLACED BETWEEN JOISTS OR RAFTERS AT ALL SUPPORTS.
 8. ALL NAILING SHALL CONFORM TO THE MINIMUM STANDARDS OF THE 2010 FLORIDA BUILDING CODE. NAILS SHALL BE COMMON WIRE NAILS.
 9. ALL INTERIOR FRAMING SHALL BE MINIMUM 2" X 4" WOOD STUDS @ 16" O.C.

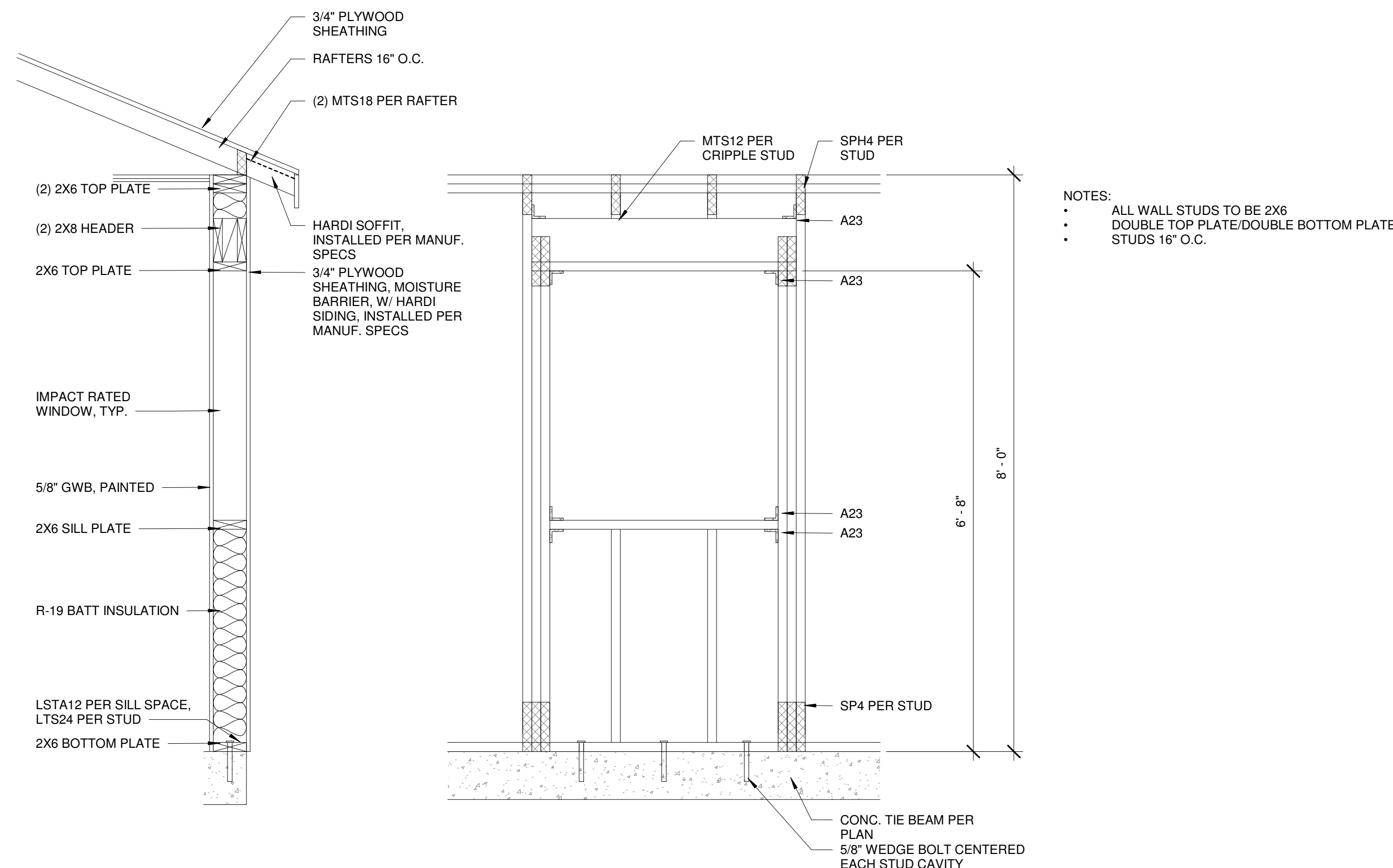

- NOTES:
- ALL WALL STUDS TO BE 2X6
 - DOUBLE TOP PLATE/DOUBLE BOTTOM PLATE
 - STUDS 16" O.C.

8 5 1.0 3/4" = 1'-0" TYPICAL FRAMING DETAILS

DATE:	2020.06.21
REV. SET/DESCRIPTION	ISSUED PERMIT SET

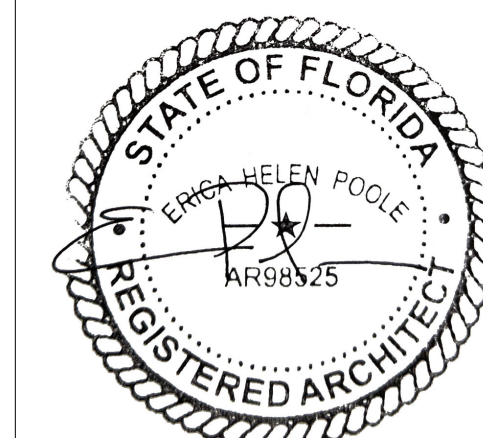

ERICA HELEN POOLE - ARCHITECT
#AR98525



SANDBAR DESIGN STUDIO
29185 CAMELLIA LANE
810 PINE KEY, FL 33945
WWW.SANDBARDESIGNSTUDIO.COM
8479035854

HESSE ADDITION
643 William Street
Key West, FL 33040

SHEET STRUCTURAL NOTES/DETAILS

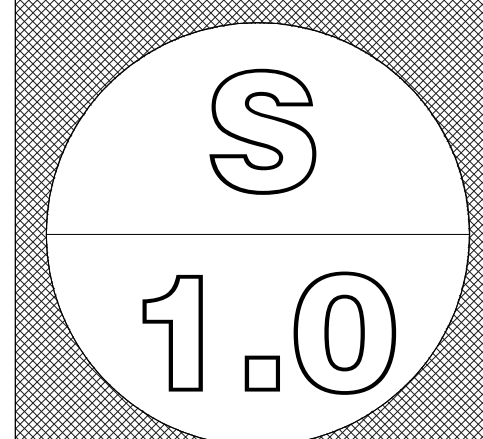

PROJECT: HES2021
DRAWN BY: EHP
APPROVED BY: EHP

NOTICING

Public Meeting Notice

The Historic Architectural Review Commission will hold a public meeting at **5:00 p.m., August 24, 2021 at City Hall, 1300 White Street**, Key West, Florida. In order to view the live feed of the meeting, you can tune in to Comcast channel 77, AT&T Uverse channel 99, or type this link into your browser:

http://keywestcity.granicus.com/MediaPlayer.php?publish_id=1&embed=1 If you wish to participate virtually, please contact HARC staff at 305-809-3975. The purpose of the hearing will be to consider a request for:

**NEW SHED ROOF ADDITION AT REAR OF HISTORIC HOUSE.
DEMOLITION OF NON-HISTORIC WOOD FRAME SHED. REMOVAL OF
WALL OF HISTORIC REAR ADDITION.**

#643 WILLIAM STREET

Applicant – Erica Poole Application #H2021-0041

If you wish to see the application or have any questions, you may visit the Planning Department during regular office hours at 1300 White Street, call 305-809-3975 or visit our website at www.cityofkeywest-fl.gov.

THIS NOTICE CAN NOT BE REMOVED FROM THE SITE UNTIL HARC FINAL DETERMINATION

ADA ASSISTANCE: It is the policy of the City of Key West to comply with all requirements of the Americans with Disabilities Act (ADA). Please call the TTY number at 800-955-8771 or 800-955-8770 (Voice) or the ADA Coordinator at 305-809-3811 at least five business days in advance for sign language interpreters, assistive listening devices, or materials in accessible format.

HARC POSTING AFFIDAVIT

STATE OF FLORIDA:
COUNTY OF MONROE:

BEFORE ME, the undersigned authority, personally appeared Erica Poole, who, first being duly sworn, on oath, depose and says that the following statements are true and correct to the best of his/her knowledge and belief:

1. That a legal notice for Public Notice of Hearing of the Historic Architectural Review Commission (HARC) was placed on the following address:
643 William Street on the 18 day of August, 2021.

This legal notice(s) contained an area of at least 8.5"x11".

The property was posted to notice a public hearing before the Key West Historic Architectural Review Commission to be held on August 24, 2021.

The legal notice(s) is/are clearly visible from the public street adjacent to the property.

The Certificate of Appropriateness number for this legal notice is H2021-0041.

2. A photograph of that legal notice posted in the property is attached hereto.

Signed Name of Affiant:

[Signature]
Date: 8/18/21
Address: 2183 Camellia Ln
City: Big Pine Key
State, Zip: FL 33043

The forgoing instrument was acknowledged before me on this 18th day of Aug, 2021.

By (Print name of Affiant) Erica Poole who is personally known to me or has produced FL drivers license as identification and who did take an oath.

NOTARY PUBLIC

Sign Name: [Signature]
Print Name: Sandra Tuttle

Notary Public - State of Florida (seal)
My Commission Expires: 5-24-22

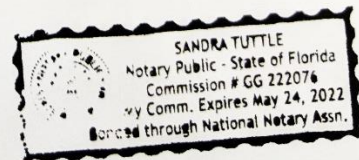





Public Meeting Notice
The following information is being provided to the public in accordance with the provisions of the Freedom of Information Act (5 U.S.C. 552) and the Privacy Act (5 U.S.C. 552a). This information is being provided to the public for informational purposes only and does not constitute an offer of insurance or any other financial product. For more information, please contact the undersigned at the address below.

PROPERTY APPRAISER INFORMATION

**Disclaimer**

The Monroe County Property Appraiser's office maintains data on property within the County solely for the purpose of fulfilling its responsibility to secure a just valuation for ad valorem tax purposes of all property within the County. The Monroe County Property Appraiser's office cannot guarantee its accuracy for any other purpose. Likewise, data provided regarding one tax year may not be applicable in prior or subsequent years. By requesting such data, you hereby understand and agree that the data is intended for ad valorem tax purposes only and should not be relied on for any other purpose.

By continuing into this site you assert that you have read and agree to the above statement.

Summary

Parcel ID 00018550-000000
 Account# 1019101
 Property ID 1019101
 Millage Group 10KW
 Location 643 WILLIAM ST, KEY WEST
 Address
 Legal KW PT OF TR 5 H3-70 OR522-740 OR641-167/68 OR709-78/79 OR790-288 OR1170-169 OR1342-289/91 OR1573-171 OR1681-1527/29 OR2294-90
 Description
 (Note: Not to be used on legal documents.)
 Neighborhood 6103
 Property SINGLE FAMILY RESID (0100)
 Class
 Subdivision
 Sec/Twp/Rng 06/68/25
 Affordable No
 Housing

**Owner**

HESSE ROBERT T
 643 William St
 Key West FL 33040

[HESSE MARY C](#)
 643 William St
 Key West FL 33040

Valuation

	2020	2019	2018	2017
+ Market Improvement Value	\$253,408	\$260,648	\$264,268	\$267,888
+ Market Misc Value	\$28,421	\$29,796	\$31,172	\$32,548
+ Market Land Value	\$625,053	\$590,085	\$542,004	\$542,004
= Just Market Value	\$906,882	\$880,529	\$837,444	\$842,440
= Total Assessed Value	\$906,882	\$880,529	\$837,444	\$842,440
- School Exempt Value	\$0	\$0	\$0	\$0
= School Taxable Value	\$906,882	\$880,529	\$837,444	\$842,440

Land

Land Use	Number of Units	Unit Type	Frontage	Depth
RESIDENTIAL DRY (010D)	7,050.00	Square Foot	50	151

Buildings

Building ID 1379
 Style 2 STORY ELEV FOUNDATION
 Building Type S.F.R. - R1/ R1
 Gross Sq Ft 2653
 Finished Sq Ft 1978
 Stories 2 Floor
 Condition AVERAGE
 Perimeter 264
 Functional Obs 0
 Economic Obs 0
 Depreciation % 8
 Interior Walls WALL BD/WD WAL
 Exterior Walls ABOVE AVERAGE WOOD
 Year Built 1938
 Effective Year Built 2011
 Foundation WD CONC PADS
 Roof Type GABLE/HIP
 Roof Coverage METAL
 Flooring Type SFT/HD WD
 Heating Type FCD/AIR DUCTED
 Bedrooms 3
 Full Bathrooms 3
 Half Bathrooms 0
 Grade 550
 Number of Fire Pl 0

Code	Description	Sketch Area	Finished Area	Perimeter
OPX	EXC OPEN PORCH	468	0	0
FLA	FLOOR LIV AREA	1,978	1,978	0
OPU	OP PRUNFIN LL	171	0	0
SBF	UTILFIN BLK	36	0	0
TOTAL		2,653	1,978	0

Yard Items

Description	Year Built	Roll Year	Quantity	Units	Grade
BRICK PATIO	1990	1991	1	1181 SF	2
RES POOL	1990	1991	1	435 SF	3
FENCES	1990	1991	1	54 SF	2
FENCES	1990	1991	1	552 SF	2
FENCES	2007	2008	1	1692 SF	2
BRICK PATIO	2007	2008	1	180 SF	2

Sales

Sale Date	Sale Price	Instrument	Instrument Number	Deed Book	Deed Page	Sale Qualification	Vacant or Improved
5/14/2007	\$1,170,000	Warranty Deed		2294	90	Q - Qualified	Improved
2/1/1995	\$650,000	Warranty Deed		1342	0289	U - Unqualified	Improved
5/1/1991	\$300,000	Warranty Deed		1170	169	Q - Qualified	Improved
4/1/1979	\$112,000	Conversion Code		790	288	Q - Qualified	Improved

Permits

Number	Date Issued	Date Completed	Amount	Permit Type	Notes
09-1355	5/12/2009	10/20/2010	\$18,500		R & R 1200sf OF HARDWOOD FLOOR, KITCHEN CABINETS AND TOPS
07-3394	7/11/2007	1/6/2009	\$8,000		INSTALL HURRICANE PANELS ON ALL 30 OPENINGS
07-2915	6/18/2007	1/6/2009	\$8,000		REPLACE ONE 2 TON AND ONE 3 TON AC UNITS
07-2598	5/30/2007	1/6/2009	\$22,000	Residential	INSTALL 14N SQS V-CRIMP ROOFING
96-4051	10/1/1996	12/1/1996	\$1,000	Residential	ROOF
E95-0611	2/1/1995	10/1/1995	\$500	Residential	UPDATE 200 AMP SERVICE

View Tax Info

[View Taxes for this Parcel](#)

Sketches (click to enlarge)

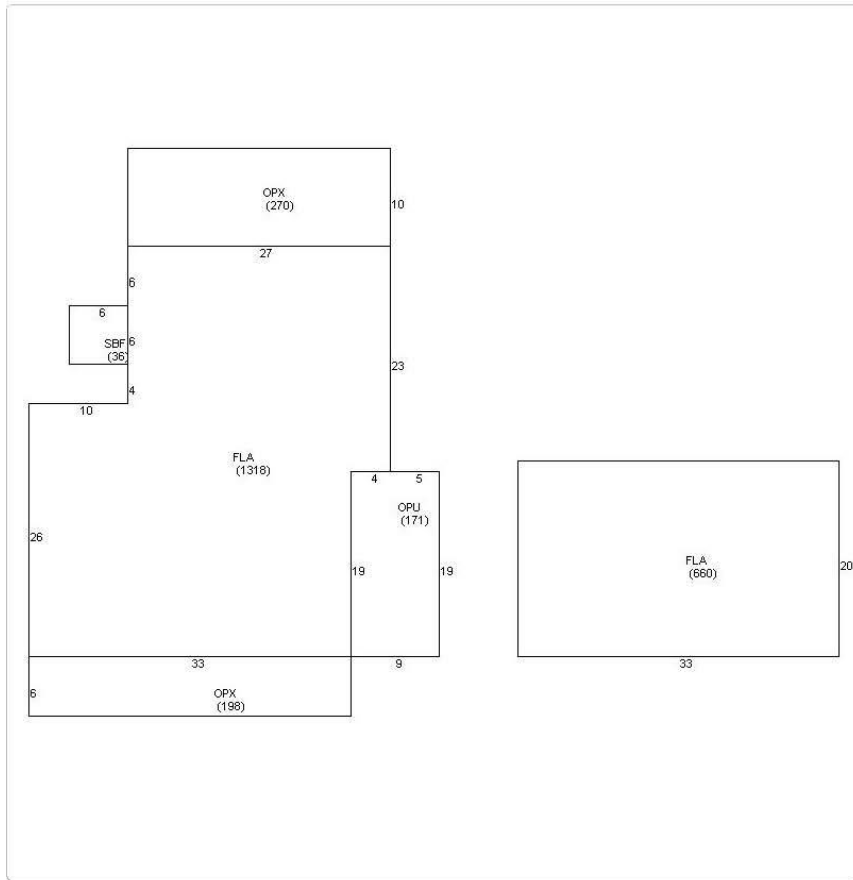

Photos



Map



TRIM Notice

[2020 TRIM Notice \(PDF\)](#)

2020 Notices Only

No data available for the following modules: Commercial Buildings, Mobile Home Buildings, Exemptions.

The Monroe County Property Appraiser's office maintains data on property within the County solely for the purpose of fulfilling its responsibility to secure a just valuation for ad valorem tax purposes of all property within the County. The Monroe County Property Appraiser's office cannot guarantee its accuracy for any other purpose. Likewise, data provided regarding one tax year may not be applicable in prior or subsequent years. By requesting such data, you hereby understand and agree that the [User Privacy Policy](#) and [GDPR Privacy Notice](#)



Last Data Upload: 7/20/2021, 2:48:50 AM

Version 2.3.133