

Historic Architectural Review Commission

Staff Report Item 6a

Meeting Date:	November 25, 2014
Applicant:	Meridian Engineering
Application Number:	H14-01-1744
Address:	#614 Frances Street
Description of Work:	Add new “sawtooth” roof to rear portion of contributing house, extension of existing shed roof, and new pool. Other changes include reducing the side main entrance by approximately two feet, adding new doors, removing and infilling wall A/C units, removal and relocation of windows, new decorative wood railing on porch.
Building Facts:	This site has a one story frame vernacular house listed as a contributing resource in the survey and was constructed c. 1920. The 1926 Sanborn map shows a house with a similar footprint to what exists today, giving credence that the multitude of roof forms have existed in that sort of fashion for 88 years. Aerial photographs show that the roof forms have existed since at least 1964 and are therefore historic.
Guidelines Cited in Review:	Secretary of the Interior Standards (pages 16-23), specifically Standards 2, 3, 4, 5, 9, and 10. Additions, Alterations and New Construction (pages 36-38a), specifically guidelines for additions 1 through 8 of page 37. Entrances, Porches, and Doors (pages 32-33), specifically guideline 11.

Staff Analysis

The Certificate of Appropriateness in review proposes the removal of four rear historic roofs to create a new “sawtooth” addition and a new rear shed roof that

will extend across the house to create a covered patio. This historic house has an unusual array of roof forms, which appear to have existed since 1964 and possibly since 1926. It has a traditional side gable roof with a separate hip porch roof and a rear sawtooth roof. Behind that is a mixture of four different roofs – two shed, a gable, and gable/hip combination. The Sanborn maps do not delineate a “main house” from any additions as it traditionally does with other properties. Even though these roofs have been deemed historic, staff feels that they are not character-defining features of the house.



2000 Bird's Eye photo showing the different roof forms.

This new sawtooth addition will be about four inches shorter than the two historic sawtooth roofs at a height of 15 feet and 11 inches, but will retain the same slope. It will utilize v-crimp roofing material, which will distinguish it from the metal shingled historic roofs. The new rear shed roof, also with v-crimp, will replicate the same slope as the original, it will just extend over the entire width of the house, rather than only half as it does now.

The plans also will reduce the shed roof section on the north side of the house by approximately two feet, as it encroaches onto city right-of-way (Robert's Lane). The existing windows on that elevation will be relocated to the new wall. The new wall will match the existing siding and will have a v-crimp roof. The west end of that shed roof section will have new impact resistant French doors.

The applicant also intends to demolish a non-historic shed, remove inappropriate clerestory windows in the second sawtooth roof, remove wall A/C units and infill, remove the concrete porch wall and install of new wooden railings, and install a new 8 x 12 foot pool with no water features. On the south side of the main elevation, new impact resistant French doors will be installed and a window will be removed. Pavers in the driveway will be removed so that the property retains the same level of impervious percentage. The property was approved for a variance for side and rear yard setbacks and building coverage at the October Planning Board meeting.

Consistency with Guidelines

1. The proposed additions will not alter or destroy any character-defining features on the contributing structure.
2. The proposed plans will not alter the mass, scale, and height of the additions that is inappropriate to the original house, the streetscape of Roberts Lane, and the neighborhood.
3. The proposed plans will not alter the balance and the symmetry of the historic house and historic additions.

It is staff's opinion that the proposed design will not have an adverse effect on the historic house. The plans as submitted are consistent with the guidelines pertaining to mass, scale, and height. The historic roofs and rear shed roof wall are not considered to be character-defining features.

Staff recommends to the Commission that a final version of the porch railing be submitted to staff for approval.

Application



CITY OF KEY WEST
BUILDING DEPARTMENT

CERTIFICATE OF APPROPRIATENESS-03-2014 011744

APPLICATION #

OWNER'S NAME: Elizabeth Ross DATE: 11-01-14

OWNER'S ADDRESS: 1015 Fleming St., Key West PHONE #: 305-509-2670

APPLICANT'S NAME: Meridian Engineering, LLC PHONE #: 305-293-3263

APPLICANT'S ADDRESS: 201 Front St., Ste. 203, Key West, FL 33040

ADDRESS OF CONSTRUCTION: 614 Frances Street FR # OF UNITS 1

THERE WILL BE A FINAL INSPECTION REQUIRED UNDER THIS PERMIT

DETAILED DESCRIPTION OF WORK: Remove the northern portion of the house back to the property line. Add a new roof to the rear portion of home. The "sawtooth" style gables of the first two roofs will be copied in a third gable removing the existing shed roofs and hip. The existing shed roof on the very back portion of the home will be extended to the north to cover a portion of the deck. Finally a 12'x8' pool will be added to the rear of the property.

Chapter 837.06 F.S.-False Official Statements - Whoever knowingly makes a false statement in writing with the intent to mislead a public servant in the performance of his or her official duty shall be guilty of a misdemeanor of the second degree punishable as provided for in s. 775.082 or 775.083

This application for Certificate of Appropriateness must precede applications for building permits, right of way permits, variances, and development review approvals. Applications must meet or exceed the requirements outlined by the Secretary of the Interior's Standards for Rehabilitation and Key West's Historic Architectural Guidelines.

Once completed, the application shall be reviewed by staff for completeness and either approved or scheduled for presentation to the Historic Architectural Review Commission at the next available meeting. The applicant must be present at this meeting. The filing of this application does not ensure approval as submitted.

Applications that do not possess the required Submittals will be considered incomplete and will not be reviewed for approval.

Date: 11/3/14

Applicant's Signature: [Signature]

Required Submittals

Table with 2 columns: checkbox and description. Rows include: TWO SETS OF SCALED DRAWINGS OF FLOOR PLAN, TREE REMOVAL PERMIT, PHOTOGRAPHS OF EXISTING BUILDING, PHOTOGRAPHS OF ADJACENT BUILDINGS, ILLUSTRATIONS OF MANUFACTURED PRODUCTS TO BE USED SUCH AS SHUTTERS, DOORS, WINDOWS, PAINT COLOR CHIPS, AND AWNING FABRIC.

Oper: KEYJOB Date: 11/03/14 55 SAMMES CC Drawer: 1 Receipt no: 3666

PT * BUILDING PERMITS-NEW Staff Use Only Trans number: 3028511 VN VISA/NO STOPS Date: 11/03/14 Fee: \$100.00 Trans dates: 11/03/14 Time: 14:55:26 Staff Approval:

Fee Due:\$

HISTORIC ARCHITECTURAL REVIEW APPLICATION

HISTORIC ARCHITECTURAL REVIEW COMMISSION USE ONLY

Approved

Denied

Deferred

Reason for Deferral or Denial:

HARC Comments:

Limit of Work Approved, Conditions of Approval and/or Suggested
Changes:

Date: _____

Signature: _____

Historic Architectural
Review Commission

Sanborn Maps

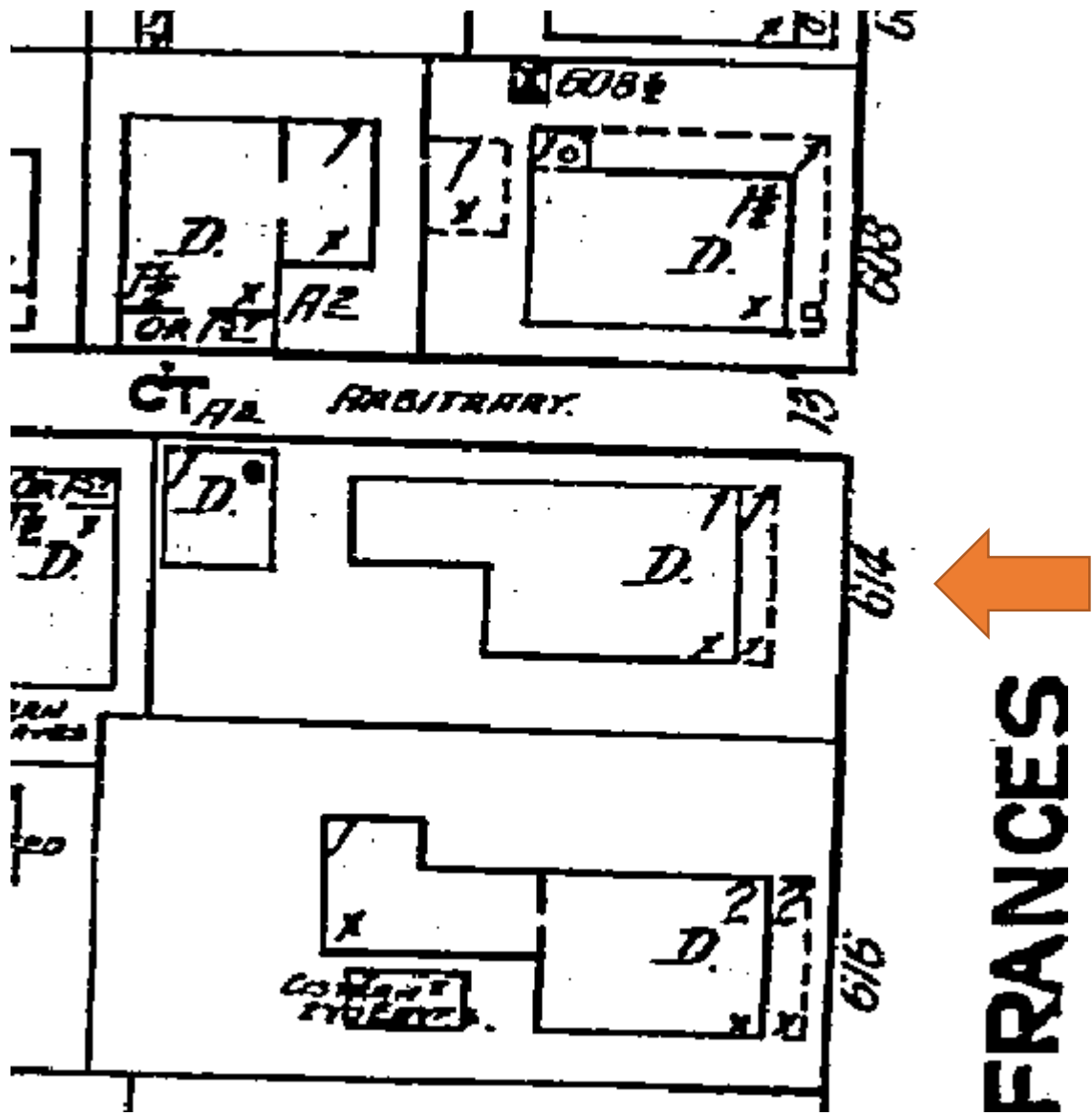

1912 Sanborn Map

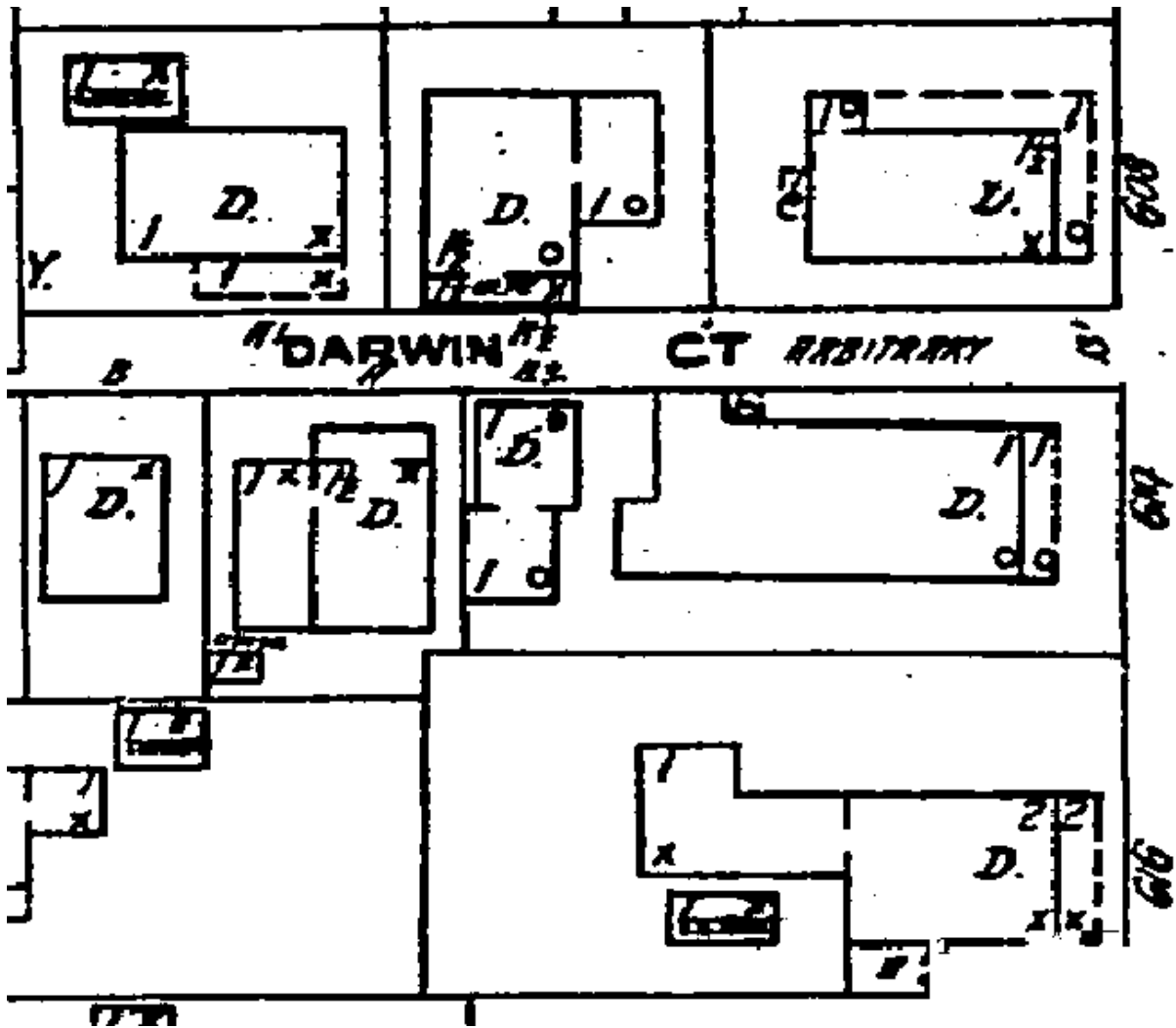

FRANCIS (FRANCE)

1926 Sanborn Map

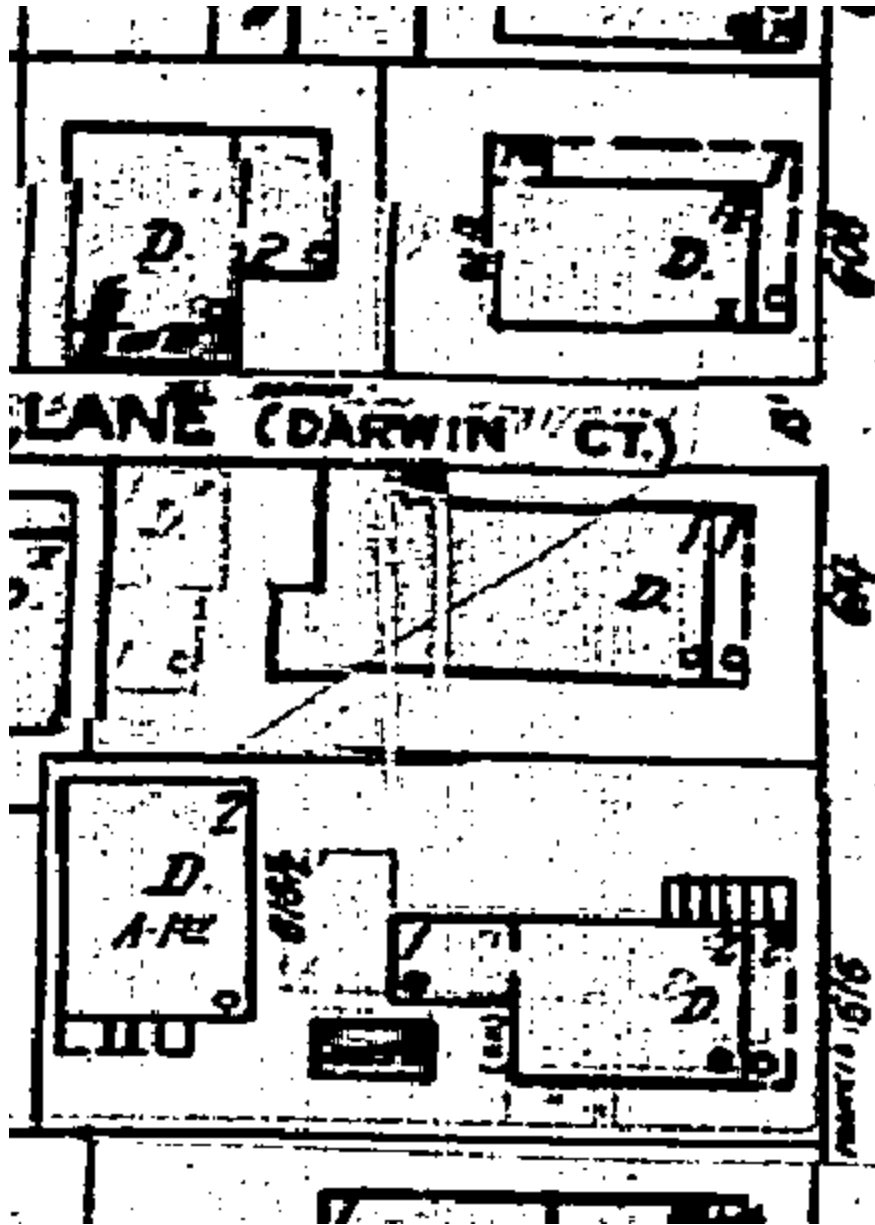

FRANCIS  **(FRANCES)**

1948 Sanborn Map

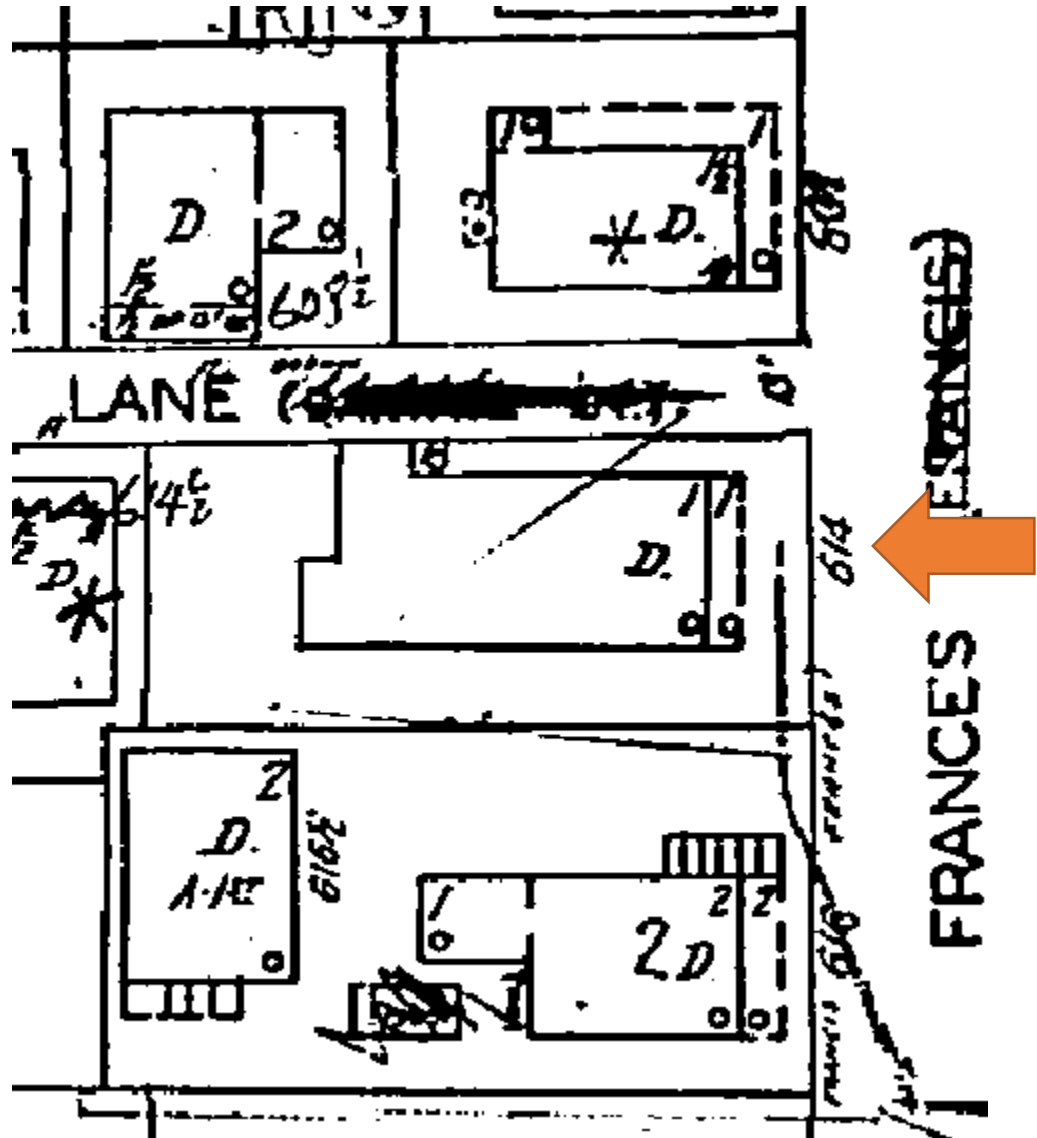

1962 Sanborn Map

Project Photos



1964 Aerial Photo



1968 Aerial Photo



1972 Aerial Photo



2000 Bird's Eye Photo



Property Appraiser's Photograph, c. 1965.
Monroe County Public Library.





Close up of concrete porch wall.



South side of house showing the two side gable roofs.
These brick pavers will be removed.



Rear south side of house.

The one door will be turned into two French doors, and the window will be removed.



Close up of the connection between the second sawtooth roof and rear gable roof on south side of house. Even though Sanborn maps do not show this as an addition, it looks like one.



Robert's Lane on the north side of the house.



Right/north side of the house and view of Robert's Lane.



Inappropriate clerestory windows to be removed.



2014/10/07 13:47

Main entrance to house with a shed roof.
The section of the building that is encroaching on Robert's Lane and will be removed.



2014/10/07 13:47



Another view of the south side of the house.
Rear of the shed roof section that will be moved off city right-of-way.



Roof that is hip in the front and gable in the rear. The V-Crimp roof is more recent.



Rear gable roof that has the hip front.



Rear elevation of house.



Rear of house where the new pool will be located.



Shed on the right to be demolished.

Planning Board Resolution

**PLANNING BOARD
RESOLUTION NO. 2014-64**

A RESOLUTION OF THE CITY OF KEY WEST PLANNING BOARD GRANTING WITH CONDITIONS VARIANCES TO MAXIMUM BUILDING COVERAGE AND MINIMUM STREET SIDE AND REAR YARD SETBACKS ON PROPERTY LOCATED AT 614 FRANCES STREET (RE # 00010650-000000, AK # 1010944) IN THE HISTORIC HIGH DENSITY RESIDENTIAL (HHDR) ZONING DISTRICT PURSUANT TO SECTIONS 90-395, 122-630(4)A AND 122-630(6)C. & D. OF THE LAND DEVELOPMENT REGULATIONS OF THE CODE OF ORDINANCES OF THE CITY OF KEY WEST, FLORIDA.

WHEREAS, the applicant proposes to renovate and convert a multi-family structure into a single family home on property located at 614 Frances Street (RE # 00010650-000000, AK # 1010944); and

WHEREAS, the existing structure is currently nonconforming to maximum building coverage and impervious surface ratio, minimum front, street side and rear yard setback requirements within the Historic High Density Residential (HHDR) Zoning District; and

WHEREAS, Section 122-630 of the Land Development Regulations (the "LDRs") of the Code of Ordinances (the "Code") of the City of Key West, Florida (the "City") provides that the maximum building coverage is 50%, minimum street side yard setback is five (5) feet and the rear yard setback is 20 feet; and

WHEREAS, the existing building coverage is 59%, street side setback is -2.3 feet (encroaching onto Cates Lane) and existing rear yard setback is 14'3"; and

WHEREAS, the proposed building coverage is 61%, street side setback is 0 feet and rear





Vice-Chairman
Planning Director

yard setback is 14'3"; and

WHEREAS, the applicant requests variances to the maximum building coverage and minimum street side and rear yard setbacks; and

WHEREAS, this matter came before the Planning Board at a duly noticed public hearing on October 16, 2014; and

WHEREAS, the Planning Board finds that special conditions and circumstances exist which are peculiar to the land, structure, or building involved and which are not applicable to other land, structures or buildings in the same district; and

WHEREAS, the Planning Board finds that the special conditions do not result from the action or negligence of the applicant; and

WHEREAS, the Planning Board finds that granting the variances requested will not confer upon the applicant any special privileges denied by the land development regulations to other lands, buildings or structures in the same zoning district; and

WHEREAS, the Planning Board finds that literal interpretation of the provisions of the land development regulations would deprive the applicant of rights commonly enjoyed by other properties in this same zoning district under the terms of this ordinance and would work unnecessary and undue hardship on the applicant; and

WHEREAS, the Planning Board finds that the variances granted are the minimum variances that would make possible the reasonable use of the land, building or structure; and

WHEREAS, the Planning Board finds that the granting of the variances will be in harmony with the general intent and purpose of the land development regulations and that such variances

WJA Vice-Chairman

WJC Planning Director

would not be injurious to the area involved or otherwise detrimental to the public interest or welfare;
and

WHEREAS, the Planning Board finds that no nonconforming use of neighboring lands, structures, or buildings in the same district, and no permitted use of lands, structures or buildings in other districts are grounds for the issuance of the requested variance; and

WHEREAS, the Planning Board finds that the applicant has demonstrated a “good neighbor policy” by contacting or attempting to contact all noticed property owners who have objected to the variance application, and by addressing the objections expressed by these neighbors.

NOW, THEREFORE, BE IT RESOLVED by the Planning Board of the City of Key West, Florida:

Section 1. That the above recitals are incorporated by reference as if fully set forth herein.

Section 2. A variance approval by Resolution of the Key West Planning Board for maximum building coverage and minimum street side and rear yard setbacks in order to renovate and convert a multi-family structure into a single family home per the attached plans signed and sealed July 1, 2014 by Rick Milelli, Professional Engineer, on property located at 614 Frances Street (RE # 00010650-000000, AK # 1010944) in the HHDR Zoning District pursuant to Sections 90-395, 122-630(4)a. and 122-630(6)c. & d. of the City of Key West Land Development Regulations with the following conditions:

General Conditions:

1. The proposed development shall be consistent with the plans signed and sealed July 1, 2014 by Rick Milelli, Professional Engineer. No approval granted for any other work or improvements shown on the plans other than the addition of a side

WJH Vice-Chairman
RC Planning Director

gable roof on the rear of the existing structure, a new covered patio over existing pavers and removal of the 2.3 foot encroachment (209.07 square feet) from Roberts Lane (aka Cates Lane).

2. The applicant shall obtain a Certificate of Appropriateness for the proposed development.
3. Trees near and within the project area will be protected during construction/demolition. Trees located within the work area that may need to be removed or trimmed may require permits from the Tree Commission.

Condition to be completed prior to the issuance of certificate of occupancy:

4. Roof gutter downspouts shall be directed back onto property.
5. The applicant shall acknowledge in writing on forms provided by the Planning Department that the two non-transient units removed from active occupied status on this property will be held in "unassigned" status for this property, with the stipulation that they cannot be transferred until such time as the City adopts by Ordinance to allow the transfer of such units. In the interim, if the applicant wishes to re-establish the units as non-transient units on this property, they may, with appropriate building permits.

Section 3. It is a condition of this variance that full, complete and final application for all conditions of this approval for any use and occupancy for which this variance is wholly or partly necessary, shall be submitted in their entirety within two years after the date hereof; and further, that no application shall be made after expiration of the two-year period without the applicant obtaining an extension from the Planning Board and demonstrating that no change of circumstances to the property or its underlying zoning has occurred.

Section 4. The failure to fully and completely apply the conditions of approval for permits for use and occupancy pursuant to this variance in accordance with the terms of the approval as described in Section 3 hereof, shall immediately operate to terminate this variance, which variance shall be of no force or effect.

Section 5. This variance does not constitute a finding as to ownership or right to possession of the property, and assumes, without finding, the correctness of applicant's assertion of

 Vice-Chairman

 Planning Director

legal authority respecting the property.

Section 6. This Resolution shall go into effect immediately upon its passage and adoption and authentication by the signatures of the presiding officer and the Clerk of the Commission.

Section 7. This Resolution is subject to appeal periods as provided by the City of Key West Code of Ordinances (including the Land Development Regulations). After the City appeal period has expired, this permit or development order will be rendered to the Florida Department of Economic Opportunity. Pursuant to Chapter 73C-44, F.A.C., this permit or development order is not effective for forty five (45) days after it has been properly rendered to the DEO with all exhibits and applications attached to or incorporated by reference in this approval; that within the forty five (45) day review period, the DEO can appeal the permit or development order to the Florida Land and Water Adjudicatory Commission; and that such an appeal stays the effectiveness of the permit until the appeal is resolved by agreement or order.

Read and passed on first reading at a regularly scheduled meeting held this 16th day of October 2014.

Authenticated by the Vice-Chairman of the Planning Board and the Planning Director;



Sam Holland, Jr., Planning Board Vice-Chairman

10.22.14

Date

 Vice-Chairman
 Planning Director

Attest:



10/21/14

Donald Leland Craig, AICP, Planning Director

Date

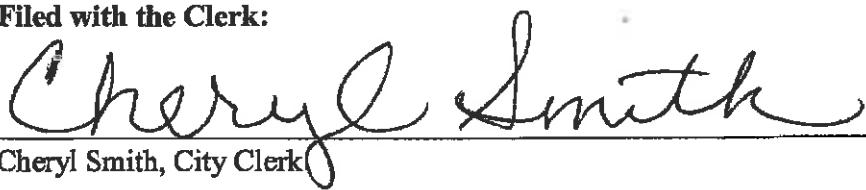

Filed with the Clerk:



10-23-14

Cheryl Smith, City Clerk

Date

 Vice-Chairman
 Planning Director

Survey

Boundary Survey Map of part of Lot 2, Square 56 Island of Key West, Florida

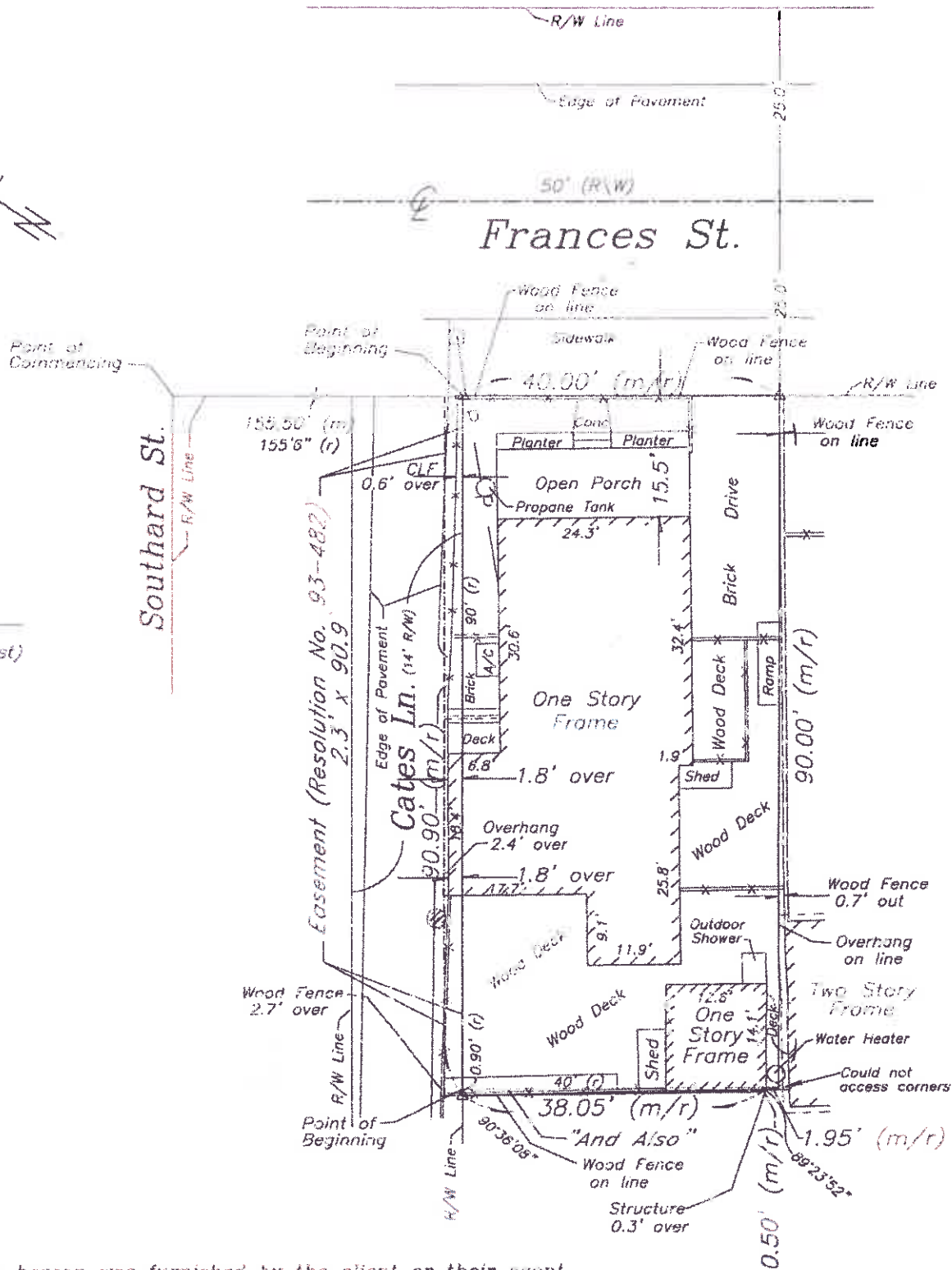
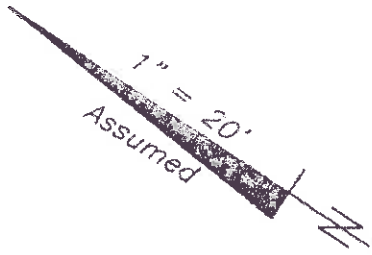

LEGEND

- ⊙ Found 2" Iron Pipe (Fence Post)
- Set #5 rebar w/cap (6298)
- Found 1/2" Iron Rod (2863)
- ▲ Found Nail & Disc (PTS)
- △ Set Nail & Disc (6298)
- (M) Measured
- (R) Record
- (M/R) Measured & Record
- C.B.S. Concrete Block Structure
- R\W Right of Way
- CLF Chain Link Fence
- ⊕ Centerline
- ⊗ Wood Utility Pole
- ⊠ Concrete Utility Pole
- P- Overhead Power Lines

NOTES:

1. The legal description shown hereon was furnished by the client or their agent.
2. Underground foundations and utilities were not located.
3. All angles are 90° (Measured & Record) unless otherwise noted.
4. Street address: 614 Frances Street, Key West, FL.
5. This survey is not valid without the signature and the original raised seal of a Florida licensed surveyor and mapper.
6. Lands shown hereon were not abstracted for rights-of-way, easements, ownership, or other instruments of record.
7. North Arrow is assumed and based on the legal description.
8. Adjoiners are not furnished.
9. Date of field work: August 21, 2013.
10. Ownership of fences is undeterminable, unless otherwise noted.

BOUNDARY SURVEY OF: On the Island of Key West, and known on the map or plan of said Island delineated by W.A. Whitehead in February, A.D. 1829, as a part of Lots Two (2) and Three (3) in Square Fifty-six (56). Commencing at a point distant from the corner of Southard and Frances Streets One Hundred and Fifty-five (155) feet and Six (6) inches, and running thence along Frances Street in a SE'y direction Forty (40) feet; thence at right angles in a SW'y direction Ninety (90) feet; thence at right angles in a NW'y direction Forty (40) feet; thence at right angles in a NE'y direction Ninety (90) feet to the place of beginning.

AND ALSO

On the Island of Key West, Monroe County, Florida, and known on the map of said Island delineated by W.A. Whitehead in February, 1829 as part of Lots 2 and 3, Square 56, and being more particularly described by the following metes and bounds description: **COMMENCE** at the intersection of the SE'y right-of-way line (ROWL) of Southard Street and the SW'y ROWL of Frances Street; thence run SE'y along said SW'y ROWL 155.5 feet; thence run SW'y at right angles 90.0 feet to the Point of Beginning; thence continue SW'y along the previously described course 0.9 feet to an existing wood fence; thence run SE'y along a line deflected 90 degrees 36' 08" to the left, 38.05 feet; thence run NE'y along a line deflected 90 degrees 23' 52" to the left 0.5 feet; thence run NW'y and at right angles 38.05 feet to the Point of Beginning.

BOUNDARY SURVEY FOR: Elizabeth Ann Ross;
Capital Bank, N.A.;
Stones & Cardenas;
Chicago Title Insurance Company;

J. LYNN O'FLYNN, INC.

J. Lynn O'Flynn, PSM
Florida Reg. #6298

August 22, 2013

THIS SURVEY
IS NOT
ASSIGNABLE

J. LYNN O'FLYNN, Inc.



Professional Surveyor & Mapper
PSM #6298

3430 Duck Ave., Key West, FL 33040
(305) 296-7422 FAX (305) 296-2244

Proposed Design

RESIDENTIAL RENOVATION

614 FRANCES STREET
KEY WEST, FLORIDA 33040

SITE DATA

SITE ADDRESS: 614 FRANCES ST. KEY WEST, FL 33040
RE: 00010650-000000
ZONING: HHDR (HISTORIC HIGH DENSITY RESIDENTIAL)
FLOOD ZONE: X
F.I.R.M. - COMMUNITY#12087C; MAP & PANEL #1516 SUFFIX K; DATE:02-18-05
SECTION/TOWNSHIP/RANGE: 6-68-25
LEGAL DESCRIPTION: KW PT LOT 2 SQR 56 G22-335/38
SETBACKS: FRONT 10 FT; SIDE 5 FT; REAR 20 FT; STREET SIDE 5 FT
OCCUPANCY: R-3 RESIDENTIAL SINGLE FAMILY
TYPE OF CONSTRUCTION: VB

DESIGN DATA

THE WORK DEPICTED HEREIN WAS DESIGNED TO MEET THE REQUIREMENTS OF THE 2010 FLORIDA BUILDING CODE AND THE LATEST EDITIONS OF THE FLORIDA MODEL ENERGY CODE, FIRE CODE, LIFE SAFETY CODE AND THE NATIONAL ELECTRIC CODE.
THE FOLLOWING LOADINGS WERE USED:
DESIGN LOADS: ASCE 7-10
WIND LOAD: 180 mph; 3 sec gust; EXPOSURE C; ROOF LIVE LOAD 20 PSF; DEAD LOAD 15 PSF; FLOOR LL 40 PSF
SOIL BEARING CAPACITY ASSUMED 2000LBS PER SQ. FT.

INDEX OF DRAWINGS

SHEET CS-1 - COVER, SITE PLAN, PROJECT DATA AND LOCATION MAP
SHEET A-1 - EXISTING ELEVATIONS AND DEMO PLAN
SHEET A-2 - PROPOSED ELEVATIONS AND DOOR AND WINDOW SCHEDULE
SHEET A-3 - FLOOR PLAN, ROOF FRAMING PLAN, FOUNDATION PLAN, SECTIONS AND NOTES
SHEET MEP-1 - ELECTRICAL/MECHANICAL AND PLUMBING PLAN

GENERAL NOTES

- THESE PLANS ARE FOR THE CONSTRUCTION AT THE LOCATION SO DESIGNATED HEREIN.
- THE CONTRACTOR SHALL PROVIDE ALL MATERIAL, LABOR, EQUIPMENT AND SUPERVISION NECESSARY TO PROVIDE THE WORK COMPLETE AND READY FOR USE.
- THERE SHALL BE NO DEVIATION FROM THESE PLANS WITHOUT PRIOR APPROVAL FROM THE ENGINEER OF RECORD.
- THE CONTRACTOR SHALL VISIT THE SITE AND BECOME FAMILIAR WITH EXISTING CONDITIONS BEFORE BID. CHECK AND VERIFY ALL DIMENSIONS AND CONDITIONS OF THE WORK SITE AND REPORT ANY DISCREPANCIES, DIFFERENCES OR CONDITIONS THAT ARE UNSATISFACTORY OR UNSAFE.
- NOTIFY THE ENGINEER OF RECORD IMMEDIATELY OF ANY DISCREPANCIES, DIFFERENCES, UNSATISFACTORY OR UNSAFE CONDITIONS. ANY MODIFICATIONS OR CHANGES MADE WITHOUT PRIOR WRITTEN APPROVAL FROM THE OWNER AND ENGINEER OF RECORD SHALL NOT BE ALLOWED. ANY REWORK, RESTORATION OR OTHER IMPACT AS A RESULT OF NOT OBTAINING SUCH PRIOR APPROVAL WILL BE MADE BY THE CONTRACTOR WITHOUT ADDITIONAL COST OR COMPENSATION FROM THE OWNER.
- THE CONTRACTOR SHALL PROVIDE FOR THE SAFETY, PREVENTION OF INJURY OR OTHER LOSS AT THE JOB TO ALL PERSONS EMPLOYED IN THE WORK, PERSONS VISITING THE WORK AND THE GENERAL PUBLIC. THE CONTRACTOR SHALL ALSO BE RESPONSIBLE FOR THE PREVENTION OF DAMAGE, DUE TO THE WORK, TO MATERIALS OR EQUIPMENT AND OTHER PROPERTY AT THE SITE OR ADJACENT THERETO.
- NO RESEARCH AS TO THE PRESENCE OF UNDERGROUND UTILITIES HAS BEEN INCLUDED ON OR PERFORMED FOR THIS PROJECT. CONTRACTOR SHALL BE RESPONSIBLE FOR CALLING SUNSHINE UTILITY LOCATE SERVICE PRIOR TO ANY CONSTRUCTION WITHIN ANY PUBLIC RIGHT-OF-WAY OR OTHER AREAS WHERE UNDERGROUND UTILITIES MAY BE PRESENT (I.E. IN AND AROUND UTILITY EASEMENTS, ETC.).
- THE GENERAL CONTRACTOR SHALL PROVIDE AN ON-SITE DUMPSTER IN A LOCATION COORDINATED WITH THE OWNER FOR THE DISPOSAL OF REMOVED MATERIAL AND CONSTRUCTION DEBRIS. THE DUMPSTER SHALL BE EMPTIED AT APPROPRIATE INTERVALS TO PREVENT OVERFLOW AND UNSIGHTLY CONDITIONS.
- THE CONTRACTOR SHALL PERFORM ALL WORK IN STRICT CONFORMANCE WITH THE PLANS, 2010 FLORIDA BUILDING CODE, LOCAL CODES AND ORDINANCES, MANUFACTURER RECOMMENDATIONS AND ACCEPTABLE TRADE PRACTICES. ANY CONFLICT BETWEEN THESE REQUIREMENTS AND THE MOST STRINGENT REQUIREMENTS SHALL GOVERN THE WORK.
- SHOP DRAWINGS OF ALL PREFABRICATED STRUCTURAL FLOOR AND ROOF SYSTEMS AND MECHANICAL SYSTEMS SHALL BEAR THE SEAL OF A FLORIDA PROFESSIONAL ENGINEER AS REQUIRED BY THE 2010 FLORIDA BUILDING CODE AND SHALL BE SUBMITTED TO THE ENGINEER OF RECORD BY THE CONTRACTOR FOR APPROVAL PRIOR TO FABRICATION AND INSTALLATION.
- THE CONTRACTOR SHALL NOT SCALE DRAWINGS. ANY INFORMATION THAT THE CONTRACTOR CANNOT OBTAIN FROM DIMENSIONS, DETAIL OR SCHEDULE SHALL BE OBTAINED FROM THE ENGINEER OF RECORD.
- THE CONTRACTOR SHALL COORDINATE THE WORK OF ALL TRADES TO PREVENT ANY CONFLICTS.
- THE CONTRACTOR SHALL FURNISH ALL SUBCONTRACTORS WITH A COMPLETE SET OF PLANS. ALL CHANGES SHALL BE NOTED ON THE DRAWINGS AND (2) COMPLETE AS-BUILT SETS SHALL BE DELIVERED TO THE OWNER AFTER COMPLETION OF WORK.
- THESE PLANS, AS DRAWN AND NOTED, COMPLY WITH THE BUILDING ENVELOPE ENERGY REQUIREMENTS OF THE FLORIDA MODEL ENERGY CODE. THE CONTRACTOR SHALL FAMILIARIZE HIMSELF WITH THE GOVERNING CODE IN ITS ENTIRETY AND BUILD IN ACCORDANCE WITH ALL PROVISIONS OF THIS CODE.
- PORTABLE RESTROOM FACILITIES TO BE PROVIDED AT THE SITE BY THE CONTRACTOR.
- ALL STORM WATER SHALL BE RETAINED ON THE PROPERTY.

LEGEND

SYMBOLS		MATERIAL INDICATIONS		LIST OF ABBREVIATIONS	
	ELEVATION MARK		CONCRETE	&	AND
	WALL TYPE SYMBOL		COMPACTED EARTH FILL	@	AT
	WINDOW TYPE SYMBOL		STUCCO OR GYPSUM WALL BOARD	APPROX.	APPROXIMATE(LY)
	DOOR NUMBER SYMBOL		CONCRETE MASONRY UNIT	FT.	FOOT/FEET
	ROOM NAME AND NUMBER		BRICK	F.F.L.	FINISH FLOOR LEVEL
	DETAIL OR SECTION AREA		BATT INSULATION	IN.	INCH
	DETAIL OR SECTION NUMBER		RIDGE INSULATION	MAX.	MAXIMUM
	SHEET# WHERE DETAIL IS SHOWN		SAND	MIN.	MINIMUM
	DETAIL OR SECTION NUMBER		GRAVEL	#	NUMBER
	SHEET# WHERE DETAIL IS SHOWN		CONTINUOUS WOOD FRAMING	O.C.	ON CENTER
	SHEET# WHERE DETAIL IS TAKEN		WOOD BLOCKING	LB.	POUND
			PLYWOOD	PSI	POUND PER SQUARE INCH
			FINISH WOOD	PT	PRESSURE TREATED
				SF	SQUARE FOOT/FEET
				T & G	TONGUE AND GROOVE
				WWM	WELDED WIRE MESH

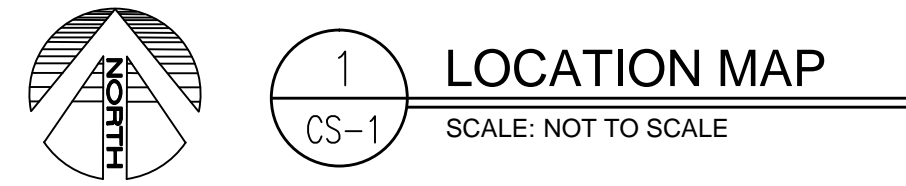

PROJECT DATA

	PROPOSED	EXISTING	REQUIRED	VARIANCE REQUESTED	
RE NO.					
SETBACKS:					
FRONT	NO CHANGE	6'-7"	10'-0"	NONE	
STREET SIDE	0'-0"	-1'-11"	5'-0"	YES	APPROVED AT SEPT. 18, 2014 MEETING- PB RES 2014-64
SIDE	NO CHANGE	6'-0"	5'-0"	NONE	
REAR	SAME	14'-3"	20'-0"	YES	APPROVED AT SEPT. 18, 2014 MEETING- PB RES 2014-64
LOT SIZE	NO CHANGE	3,561 SQ. FT.	4000 SQ. FT.	NONE	
BUILDING COVERAGE	2,199 SQ. FT. 61%	2,100 SQ. FT. 59%	50% MAX	YES	APPROVED AT SEPT. 18, 2014 MEETING- PB RES 2014-64
FLOOR AREA	NO CHANGE	N/A	1,740 SQ. FT. 0.48	NONE	
BUILDING HEIGHT	NO CHANGE	16.8'	30' MAX	NONE	
IMPERVIOUS AREA	NO CHANGE	N/A	2,360 SQ. FT. 66%	NONE	

NOTE: IMPERVIOUS AREA WILL HAVE A SLIGHT REDUCTION FROM THE REMOVAL OF EXISTING PAVERS TO OFFSET THE INCREASE FROM THE PROPOSED POOL. THE AREA WHERE PAVERS ARE BEING REMOVED IS NOTED ON THE SITE PLAN.

SITE NOTES

- REMOVE EXISTING TOPSOIL AND ORGANIC MATERIAL WITHIN THE BUILDING AREA. STRUCTURAL FILL SHALL BE SELECT STRUCTURAL FILL AND SHALL BE COMPACTED TO 98% STANDARD PROCTOR DENSITY. SITE FILL SHALL BE CLEAN SAND OR CRUSHED LIMESTONE (LESS THAN 3"). GRADE AS SHOWN AND/OR TO DRAIN AWAY FROM THE PROPOSED BUILDING.
- TREES REQUIRED TO BE REMOVED SHALL BE CUT AND THE STUMP AND ROOT SYSTEM SHALL BE REMOVED COMPLETELY. THE HOLES SHALL BE FILLED COMPACTED AND LEVELED. CARE SHALL BE TAKEN TO AVOID DAMAGE TO ADJACENT TREES AND OTHER FEATURES. PROVIDE CONSTRUCTION BARRIERS FOR TREES TO REMAIN.
- THE CONTRACTOR SHALL REMOVE ALL DEBRIS FROM THE SITE DAILY.
- THE CONTRACTOR SHALL REMOVE ALL ITEMS INDICATED AND ALL OTHER ITEMS REQUIRED FOR THE INSTALLATION OF NEW WORK. FINISH SURFACES SHALL BE REPAIRED TO MATCH ADJACENT SURFACES. ALL WORK SHALL BE DONE IN A WORKMANLIKE MANNER.

FRANCES ST.

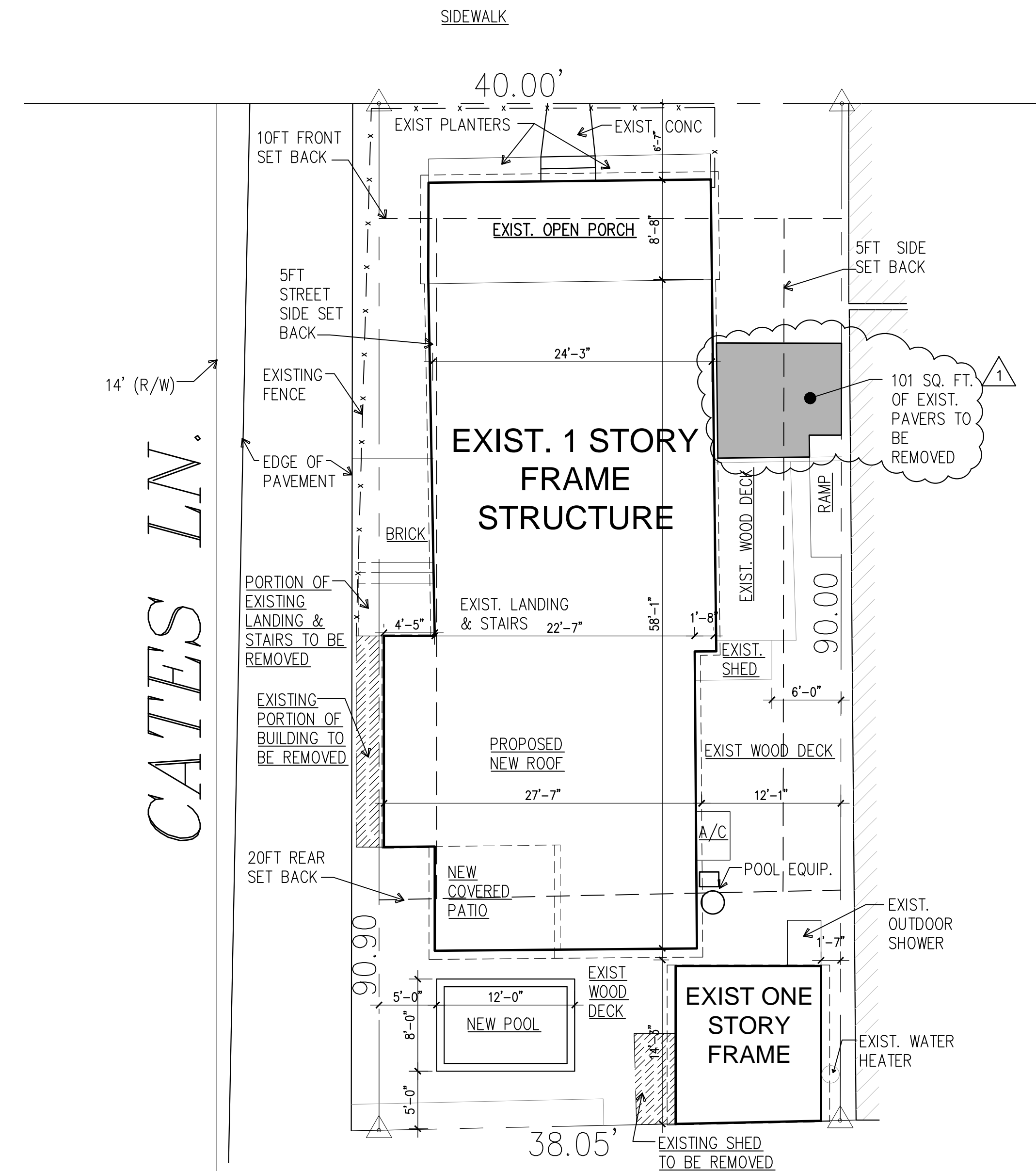

LOT SIZE: 3561 SQ. FT.
IMPERVIOUS COVERAGE 2360 SQ. FT. EXISTING (66%) MAX (60%)
BUILDING COVERAGE 2100 SQ. FT. EXISTING (59%) MAX (50%)
FLOOR AREA 1473 SQ. FT.

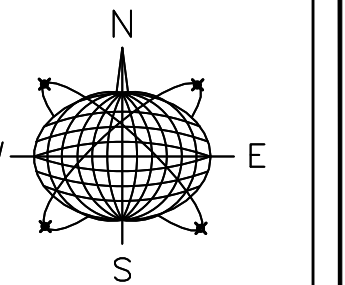

Meridian Engineering LLC
201 Front Street, Suite 210
Key West, Florida 33040
AUTHORIZATION #29401
PR-305-293-3293 FAX-203-4899

Seal:

NOT VALID FOR CONSTRUCTION UNLESS
SIGNED AND SEALED IN THE BLOCK
RICHARD J. MILELLI
PE #58315

General Notes:

RESIDENTIAL RENOVATION
HARC SUBMITTAL

Drawn By: JMT
Checked By: RJM
Project No.:
Scale:

AutoCad File No.

Revisions:
REVISIONS FOR RE-SUBMITTAL TO HARC 11-12-14

Title:
COVER SHEET
SITE PLAN AND
PROJECT DATA

Sheet Number:

CS-1

Date: NOVEMBER 3, 2014

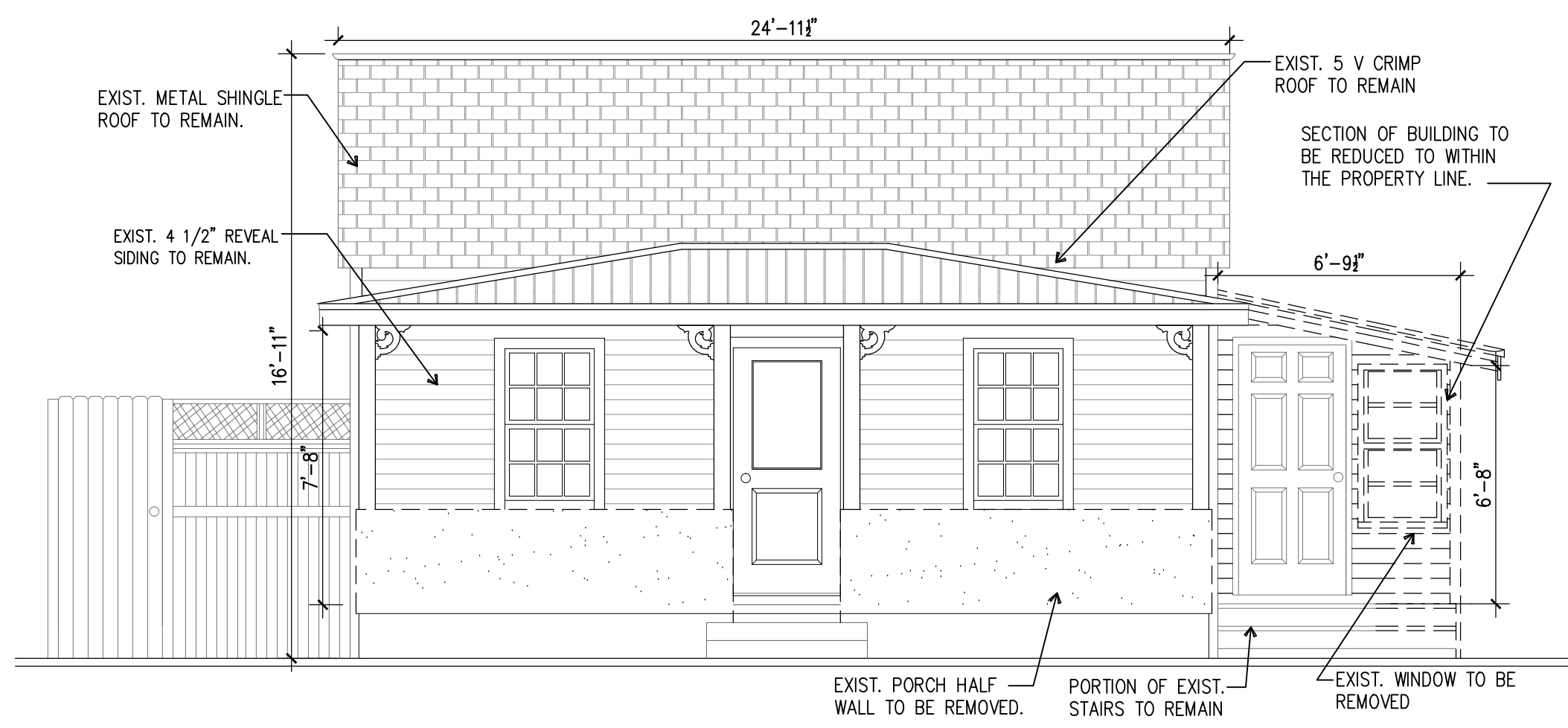

5 EXISTING FRONT ELEVATION
A-1 SCALE: 1/4"=1'-0"

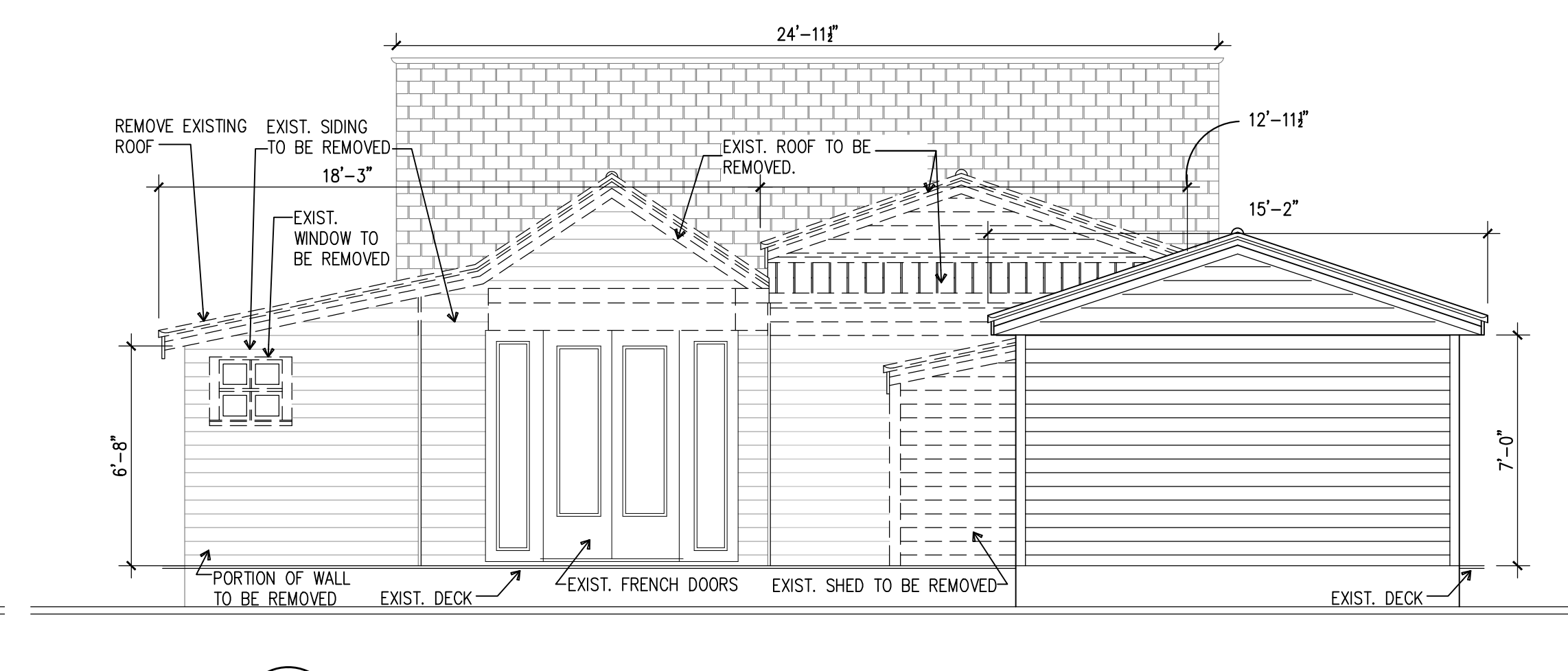

4 EXISTING REAR ELEVATION
A-1 SCALE: 1/4"=1'-0"

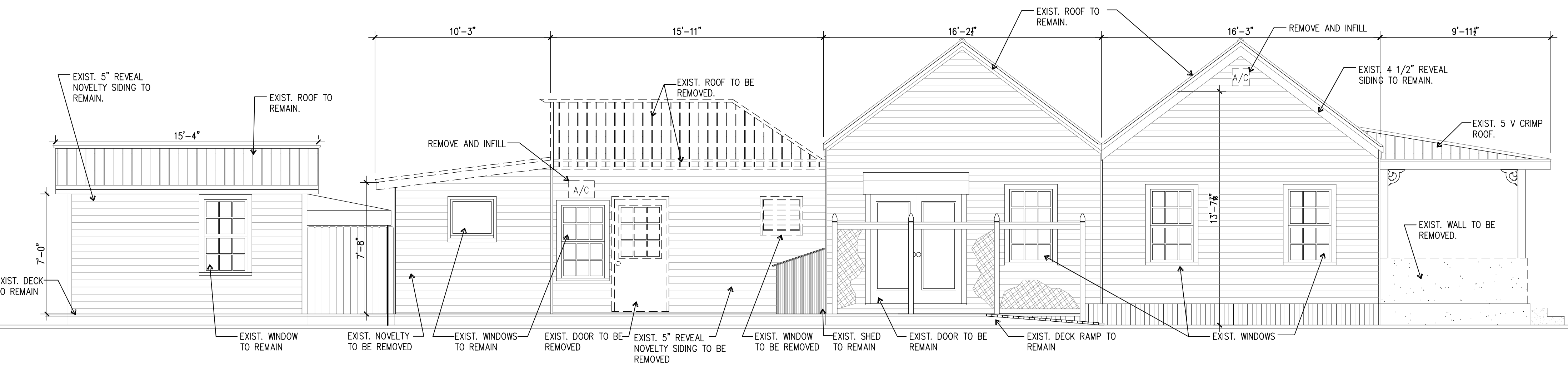

3 EXISTING (SOUTH) SIDE ELEVATION
A-1 SCALE: 1/4"=1'-0"

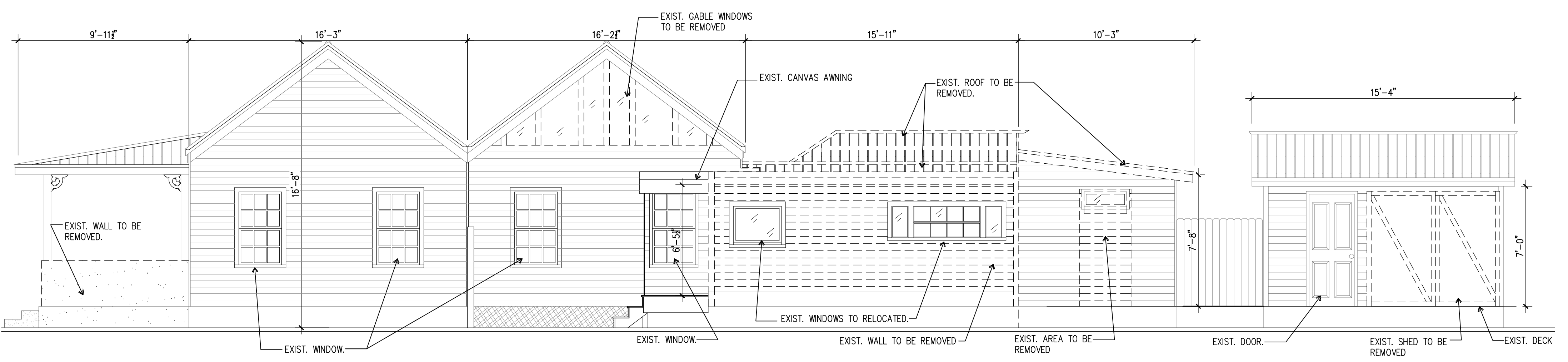

2 EXISTING (NORTH) SIDE ELEVATION
A-1 SCALE: 1/4"=1'-0"

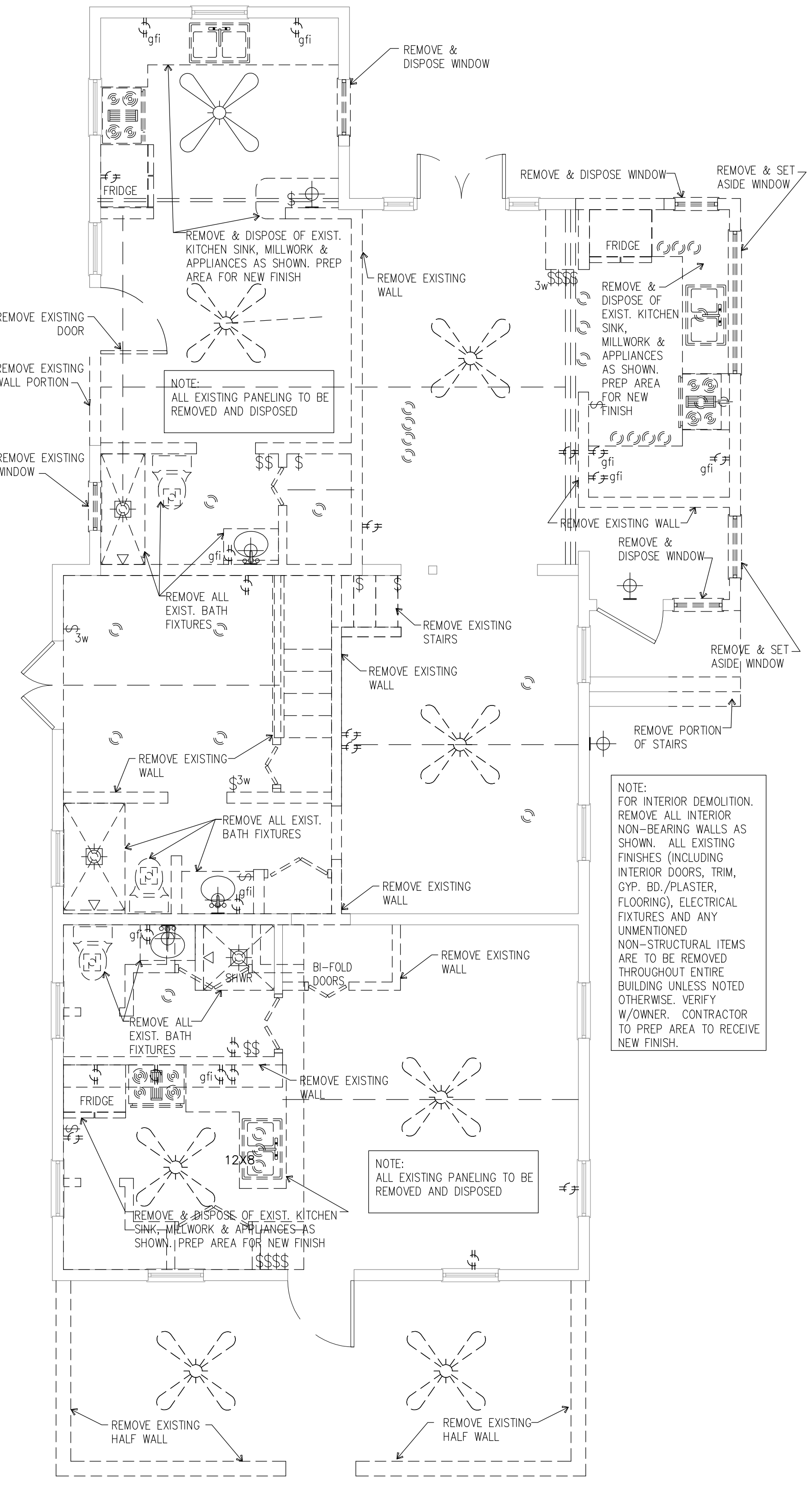

1 DEMOLITION PLAN
A-1 SCALE: 1/4"=1'-0"

DEMOLITION NOTES:
 PROTECT ALL EXISTING CONSTRUCTION, NOT SCHEDULED FOR REMOVAL, AT ALL TIMES. PROVIDE ADEQUATE SHORING AND/OR BRACING TO PREVENT DAMAGE. PROMPTLY REPAIR DAMAGE CAUSED TO ADJACENT FACILITIES BY DEMOLITION WORK AT NO COST TO THE OWNER.
 PROVIDE TEMPORARY BARRICADES AND OTHER FORMS OF PROTECTION AS REQUIRED TO PROTECT INDIVIDUALS FROM INJURY. PROVIDE SECURITY LOCKS OR OTHER MEANS TO PREVENT INADVERTENT ENTRY INTO WORK ZONE.
 CONSTRUCT DUST PROOF PARTITIONS TO SEPARATE WORK AREA WHERE NOISY OR DUSTY OPERATIONS ARE PERFORMED. KEEP WORK AREAS CLEAN TO LIMIT DUST AND DIRT TRACKING TO NON-CONSTRUCTION ZONES.
 MAINTAIN EXISTING UTILITIES FOR USE BY OWNER AND PROTECT FROM DAMAGE WHEN SERVICE INTERRUPTION IS UNAVOIDABLE. COORDINATE WITH OWNER AND UTILITY COMPANIES. PROVIDE TEMPORARY UTILITY SERVICE AS REQUIRED BY OWNER.
SHORING AND BRACING:
 PROVIDE ADEQUATE SHORING AND BRACING AT ALL LOCATIONS WHERE NEW OPENINGS ARE SHOWN TO BE CUT INTO EXISTING LOAD BEARING WALLS.
 SHORING SHALL BE PERFORMED BY AN EXPERIENCED SHORING CONTRACTOR.
 SHORING SHALL BE CONTINUOUS TO THE LOWEST LEVEL AND BE ADEQUATELY DISTRIBUTED TO PREVENT DAMAGE TO EXISTING GRADE SLABS.

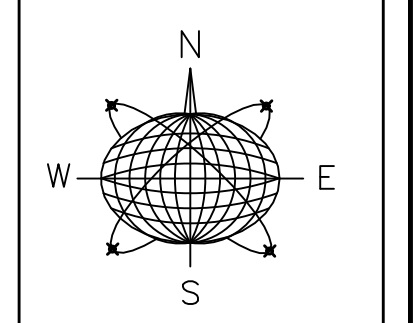

Meridian Engineering LLC
 201 Front Street, Suite 210
 Key West, Florida 33040
 AUTHORIZATION #29401
 ph:305-293-3263 fax:293-4899

Seal:
 NOT VALID FOR CONSTRUCTION UNLESS
 SIGNED AND SEALED BY THIS BLOCK
 RICHARD J. MILELLI
 PE #58315

General Notes:

**RESIDENTIAL RENOVATION
 HARC SUBMITTAL**

614 FRANCES STREET
 KEY WEST, FLORIDA

Drawn By:	Checked By:
JMT	RJM
Project No.	Scale:
AutoCad File No.	
Revisions:	
REVISIONS FOR RE-SUBMITTAL TO HARC 11-12-14	
Title:	
EXISTING ELEVATIONS & DEMOLITION PLAN	
Sheet Number:	
A-1	
Date: NOVEMBER 3, 2014	

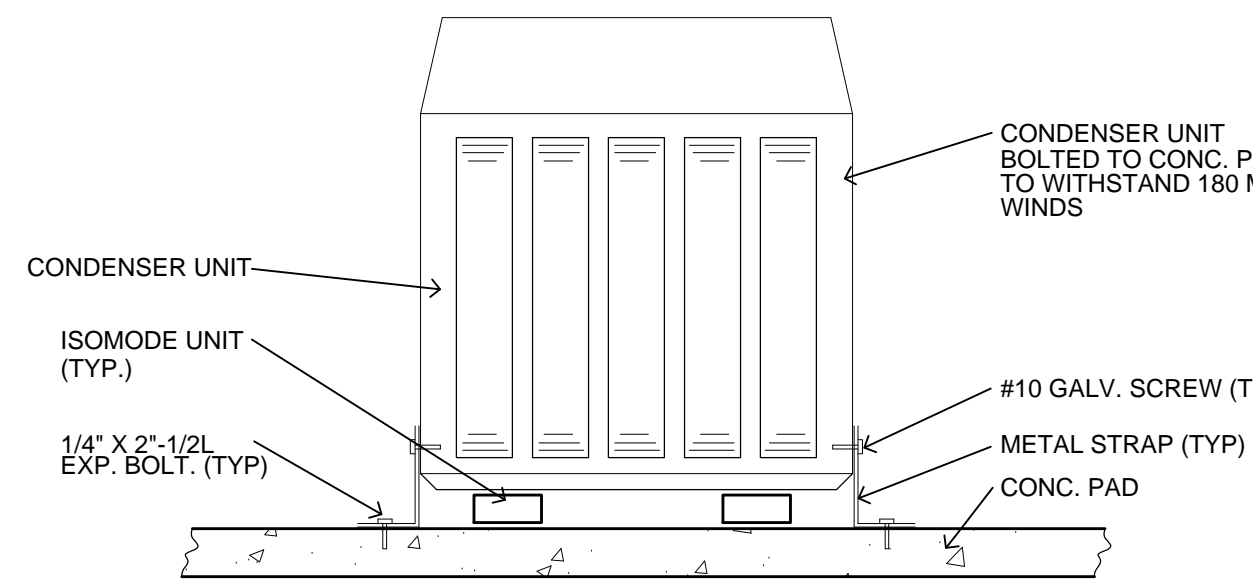

4 CONDENSER MTG DETAIL
SCALE: NTS

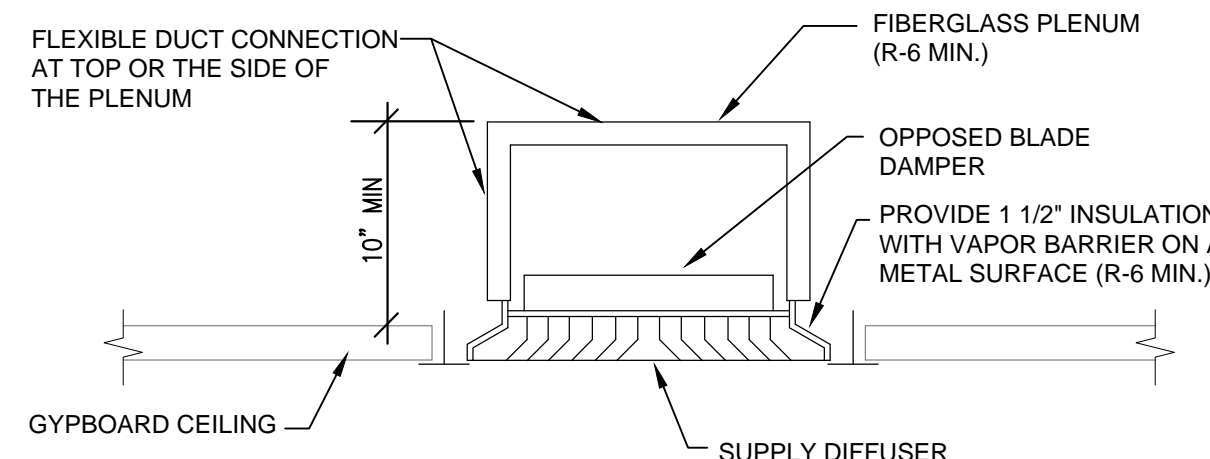

3 DIFFUSER DETAIL
SCALE: NTS

MECHANICAL NOTES

1. ALL WORK SHALL BE PERFORMED IN ACCORDANCE WITH THE 2007 MECHANICAL CODE, FLORIDA ENERGY EFFICIENCY CODE AND ALL LOCAL ORDINANCES.
2. THE CONTRACTOR SHALL FURNISH ALL LABOR, MATERIALS, EQUIPMENT, SUPERVISION, PERMITS, FEES AND INSPECTIONS NECESSARY TO PROVIDE THE WORK COMPLETE AND READY FOR USE.
3. CONTRACTOR SHALL VERIFY SPACE CONDITIONS AND DIMENSIONS AND SHALL COORDINATE WORK WITH ALL OTHER TRADES PRIOR TO FABRICATING DUCTWORK OR INSTALLING EQUIPMENT OR PIPING.
4. PRIMARY DUCTWORK SHALL BE CONSTRUCTION OF ONE AND HALF-INCH THICK (R-6 MINIMUM) FIBERGLASS DUCTBOARD WITH REINFORCED ALUMINUM FOIL FACED COVERING FABRICATED AND INSTALLED PER SMACNA RECOMMENDATIONS.
5. ALL VENTILATION AND EXHAUST DUCTWORK SHALL BE OF GALVANIZED SHEET METAL CONSTRUCTION PER SMACNA RECOMMENDATIONS.
6. REFRIGERANT PIPING SHALL BE TYPE "L" COPPER TUBING SIZED AND INSTALLED PER MANUFACTURER'S RECOMMENDATIONS. INSULATED SUCTION AND CONDENSATE PIPING WITH 1/4" THICK FOAM PLASTIC OF FIRE RETARDANT TYPE 25/30 MAXIMUM SMOKE DEVELOPED AND FLAME SPREAD RATING RESPECTIVELY PER TESTS IN MFPA-255. FINISH WHERE EXPOSED WITH TWO COATS OF ACRYLIC LACQUER IN ACCORDANCE WITH MANUFACTURER'S INSTRUCTIONS.
7. ALL EQUIPMENT, MATERIALS AND WORKMANSHIP SHALL BE GUARANTEED FOR A PERIOD OF ONE YEAR FROM THE DATE OF ACCEPTANCE. COMPRESSORS SHALL CARRY A FIVE-YEAR FACTORY GUARANTEE.
8. AIR CONDITION SYSTEM SHALL BE BALANCED TO OBTAIN COMFORT CONDITIONS IN ALL AREAS WITHOUT DRAFTING.
9. THERMOSTATS SHALL BE HEAT/COOL TYPE WITH FAN AND SYSTEM SELECTOR SWITCH ON SUB BASE. MOUNT FIVE FEET ABOVE FINISHED FLOOR WHERE SHOWN.
10. ALL DUCT ELBOWS GREATER THAN FORTY FIVE (45) DEGREES SHALL BE FITTED WITH TURNING VANES.
11. PROVIDE READY ACCESSIBILITY TO DAMPERS AND OTHER PARTS OF THE SYSTEM REQUIRED TO BE REACHED FOR MAINTENANCE AND OPERATIONS.
12. VERIFY ALL VOLTAGES WITH ELECTRICAL CONTRACTOR BEFORE ORDERING EQUIPMENT.
13. VIBRATION ISOLATION SHALL BE PROVIDED FOR ALL EQUIPMENT PER MANUFACTURER'S RECOMMENDATIONS.
14. ALL OUTSIDE EQUIPMENT SHALL BE SECURED TO WITHSTAND FORCES GENERATED BY 150 MPH WINDS.
15. FLEXIBLE DUCT SHALL BE FACTORY FABRICATED ROUND DUCTWORK COMPOSED OF CORROSION-RESISTANT REINFORCING WITH HELIX PERMANENTLY BONDED AND ENCLOSED IN POLYESTER FILM THEN COVERED WITH 1-1/2 INCH THICK 1/4 PCF (R-6 MINIMUM) DENSITY FIBERGLASS INSULATION BLANKET SHEATHED IN A VAPOR BARRIER OF ALUMINUM METALIZED POLYESTER FILM LAMINATED TO GLASS MESH, ELASTOMER BACK COATED. THE DUCT SHALL COMPLY WITH MFPA BULLETIN 90-A AND BE LISTED A CLASS 1 AIR DUCT. UL 181 DUCT SHALL BE "WIRE HOLD" TYPE WG OR EQUAL.

PLUMBING NOTES

1. THE CONTRACTOR SHALL FURNISH ALL LABOR, MATERIAL, EQUIPMENT AND SUPERVISION NECESSARY TO PROVIDE THE WORK COMPLETE AND READY FOR USE. THE NEW WORK SHALL INCLUDE COMPLETE HOT AND COLD WATER SYSTEMS AND VENT, WASTE AND DRAIN SYSTEMS IN ACCORDANCE WITH ALL APPLICABLE CODES.
2. ALL PLUMBING WORK SHALL BE INSTALLED IN ACCORDANCE WITH THE 2010 PLUMBING CODE, THE ENERGY CONSERVATION CODE AND ALL APPLICABLE LOCAL ORDINANCES.
3. CONTRACTOR SHALL PAY FOR ALL PERMITS, FEES, INSPECTIONS AND TESTING.
4. CONTRACTOR SHALL GUARANTEE ALL MATERIALS AND WORKMANSHIP FOR ONE YEAR.
5. PLUMBING DRAWINGS (PLANS, DIAGRAMS, ETC.) ARE DIAGRAMMATIC AND SHOULD NOT BE SCALED. THE DRAWINGS DO NOT SHOW EVERY BEND, OFFSET, ELBOW AND OTHER FITTINGS WHICH MAY BE REQUIRED FOR PROPER INSTALLATION IN THE SPACE ALLOCATED NOR AS REQUIRED TO COORDINATE WORK WITH THAT OF OTHER TRADES. ANY WORK NOT SHOWN ON THE DRAWINGS BUT CONSIDERED NECESSARY FOR THE PROPER COMPLETION OF THE WORK SHALL BE PROVIDED WITHOUT ADDITIONAL CHARGE TO THE OWNER.
6. THE CONTRACTOR SHALL COORDINATE HIS WORK WITH ALL OTHER WORK UNDER THIS CONTRACT.
7. THE OWNER WILL NOT BE HELD LIABLE FOR ANY CHANGES THAT ARE NOT BROUGHT TO THE ATTENTION OF THE OWNER OR FIELD CHANGES THAT ARISE FROM CONTRACTOR ERROR OR OMISSION OF MATERIAL OR POOR WORKMANSHIP.
8. THE CONTRACTOR SHALL VERIFY EXISTING SITE CONDITIONS AND THE LOCATION, SIZE AND ELEVATION OF ALL EXISTING MAIN, WATER AND SEWER CONNECTIONS PRIOR TO COMMENCING WORK. THE CONTRACTOR SHALL NOTIFY AND RECEIVE CLEARANCE FROM THE APPROPRIATE UTILITY COMPANIES PRIOR TO EXCAVATING.
9. VERIFY ALL DIMENSIONS AND CLEARANCES AT THE SITE AND IN THE BUILDING PRIOR TO FABRICATION AND INSTALLATION.
10. THE CONTRACTOR SHALL SATISFACTORILY REPAIR AND/OR REPLACE EXISTING WORK, FEATURES AND EQUIPMENT DAMAGED AS A RESULT OF HIS WORK. SURFACES AND FINISHES SHALL BE RESTORED TO MATCH ADJACENT SURFACES AND FINISHES.
11. THE CONTRACTOR SHALL INSPECT EXISTING CONDITIONS PRIOR TO BID AND BECOME FAMILIAR WITH THE SCOPE OF WORK. NO EXTRAS WILL BE ALLOWED FOR THE CONTRACTOR'S FAILURE TO COMPLY WITH THIS REQUIREMENT.
12. PLUMBING FIXTURES SHALL BE SELECTED BY THE OWNER AND INSTALLED BY THE CONTRACTOR. (PLUMBING FIXTURES INDICATED ON DRAWING ARE FOR REFERENCE ONLY, FIXTURES OR EQUAL QUALITY AND CRAFTSMANSHIP MAY BE USED AS DIRECTED).
13. ALL FIXTURES SHALL BE PROTECTED FROM WATER HAMMER WITH AIR CHAMBER SIZED IN ACCORDANCE WITH P.D.I. STANDARDS. (JOSAN OR EQUAL)
14. PROVIDE CONTROL VALVES TO ALL RISERS, BRANCHES, GROUPS OF FIXTURES AND EACH PIECE OF EQUIPMENT. CONTROL VALVES SHALL BE CAST BRASS OR BRONZE GATE VALVES.
15. PROVIDE FULLY ACCESSIBLE CLEANOUTS ON SANITARY PIPING AT THE BASE OF EACH SOIL AND WASTE PIPE AND AT EVERY CHANGE OF DIRECTION.
16. PROVIDE MINIMUM PITCH OF 1/4" PER FOOT FOR ALL HORIZONTAL BRANCHES AND SEWER TRADES.
17. ALL WATER PIPING SHALL BE TYPE M COPPER WITH WROUGHT COPPER SOLDERED JOINT FITTINGS.
18. PROVIDE DIELECTRIC FITTINGS FOR JOINING DISSIMILAR METALS.
19. SANITARY DRAIN PIPING WITHIN THE BUILDING AND BELOW THE GROUND SHALL BE SCHEDULE 40 PVC.
20. WATER HEATER SHALL BEAR LABEL INDICATING COMPLIANCE WITH ASHRAE STD. 90. WATER HEATER SHALL BE EQUIPPED WITH A DRAIN PAN WITH 2" MIN. SIDES AND 2" CLEARANCE ON ALL SIDES. PROVIDE 3/4" DRAIN OUTLET LOCATED 1/2" ABOVE BOTTOM OF PAN. P&T RELIEF VALVE AND DRAIN PAN PIPING SHALL BE TYPE M COPPER.
21. UNDERGROUND PIPING SHALL BE PROTECTED WITH A COAT OF BITUMINOUS COMPOUND.
22. ALL FLOOR DRAINS SHALL HAVE TRAP PRIMERS TO PROTECT TRAP SEAL.
23. ALL VENTS THROUGH ROOF SHALL MAINTAIN MINIMUM 10' HORIZONTAL CLEARANCE FROM ANY MECHANICAL AIR INTAKE.
24. ALL PIPING SHALL BE SUPPORTED RIGIDLY.
25. ALL CUTTING AND NOTCHING REQUIRED FOR THE INSTALLATION OF PLUMBING WORK SHALL BE ACCOMPLISHED IN AN APPROVED MANNER. APPROVAL SHALL BE OBTAINED FROM THE ENGINEER OF RECORD PRIOR TO CUTTING OR DRILLING STRUCTURAL MEMBERS UNLESS SPECIFICALLY ADDRESSED HEREIN.
26. WATER USAGE FOR PLUMBING FIXTURES SHALL NOT EXCEED THE FOLLOWING:
WATER CLOSERS: 1.6 GALLONS PER FLUSH
SHOWERS: 2.5 GALLONS PER MINUTE
FAUCETS: 2.0 GALLONS PER MINUTE
27. HOSE BIBS SHALL BE PROTECTED BY APPROVED BACK-SIPHONAGE BACKFLOW PREVENTERS.
28. TEST ALL WATER PIPING AT 100 PSI HYDROSTATIC PRESSURE A MINIMUM OF 2 HOURS.
29. TEST ALL SOIL, WASTE AND VENT PIPING WITH A 10' HEAD OF WATER. WATER LEVEL TO REMAIN UNCHANGED FOR 2 HOURS MINIMUM.
30. THE CONTRACTOR SHALL MAINTAIN ONE COMPLETE SET OF DRAWINGS TO INDICATE ALL CHANGES MADE TO THE PLUMBING DESIGN. THE AS-BUILT DRAWINGS SHALL BE DELIVERED TO THE OWNER AFTER COMPLETION OF WORK.

ELECTRICAL SYMBOL LIST

⊕ DUPLEX RECEPTACLE OUTLET	⊙ RECESSED INCANDESCENT FIXTURE
⊕ SWITCHED DUPLEX RECEPTACLE OUTLET	⊙ RECESSED ADJUSTABLE EYEBALL FIXTURE
⊕ GROUND FAULT INTERRUPT OUTLET	⊕ WATERPROOF EXTERIOR FIXTURE
⊕ WATERPROOF GROUND FAULT INTERRUPT OUTLET	⊕ VAPORPROOF FIXTURE
⊕ TOGGLE SWITCH	⊕ EXHAUST FAN/LIGHT FIXTURE COMBINATION
⊕ DIMMER SWITCH	⊕ JUNCTION BOX
⊕ 3-WAY TOGGLE SWITCH	⊕ CABLE TV OUTLET
⊕ 4-WAY TOGGLE SWITCH	⊕ EXHAUST FAN
⊕ CEILING MOUNTED FIXTURE	⊕ TELEPHONE OUTLET
⊕ PULL-CHAIN FIXTURE	⊕ DATA OUTLET
⊕ WALL MOUNTED FIXTURE	⊕ COMBO SMOKE/CO DETECTOR
⊕ FLUSH RECESSED FIXTURE	⊕ OVERHEAD GARAGE DOOR OPERATOR
⊕ CEILING MOUNTED DECORATIVE FIXTURE	⊕ PADDLE FAN
⊕ CLOSET LIGHT FIXTURE WITH COVERED LENS	⊕ PADDLE FAN WITH LIGHT
⊕ EMERGENCY LIGHT FIXTURE	⊕ OPTIONAL REINFORCED CLG. JUNCTION BOX W/ COVERPLATE

ELECTRICAL NOTE:

- ELECTRICAL CONTRACTOR TO VERIFY ALL WORK WITH OWNER.
- ALL WORK TO FOLLOW THE MOST CURRENT NATIONAL ELECTRICAL CODE.
- CONTRACTOR TO VERIFY ALL EXISTING WIRING, CONDUIT AND JUNCTION BOXES MEET CURRENT ELECTRICAL AND LOCAL CODES. REPAIR OR REPLACE AS REQUIRED.

MECHANICAL NOTE:

- CONTRACTOR TO VERIFY EXISTING DUCTING AND VENTING ARE ADEQUATE WITH THE NEW FLOOR PLAN CONFIGURATIONS AND NEW MASTER BATH. ADD NEW SUPPLY AND RETURN VENTS AND DUCTING TO NEW BATHROOM. FOLLOW ALL APPLICABLE CODES, INCLUDING THE CITY OF KEY WEST AND FLORIDA MECHANICAL CODES.

ELECTRICAL NOTES

1. THE CONTRACTOR SHALL PROVIDE ALL MATERIAL, LABOR, EQUIPMENT AND SUPERVISION NECESSARY TO PROVIDE THE WORK COMPLETE AND READY TO USE.
2. ALL WORK SHALL BE INSTALLED IN ACCORDANCE WITH THE LATEST EDITION OF THE NATIONAL ELECTRICAL CODE (NEC) AND ALL OTHER APPLICABLE CODES AND STANDARDS.
3. NO PIPE, CONDUIT OR JUNCTION BOX SHALL BE INSTALLED IN STRUCTURAL SLABS, COLUMNS OR BEAMS UNLESS SPECIFICALLY SHOWN ON STRUCTURAL DRAWINGS.
4. THE CONTRACTOR IS RESPONSIBLE FOR EVALUATING EXISTING CONDITIONS AT THE SITE AND WITHIN THE BUILDING PRIOR TO BID.
5. THE CONTRACTOR SHALL COORDINATE WITH THE LOCAL UTILITY COMPANY FOR NEW SERVICE AND ANY SPECIAL REQUIREMENTS.
6. ELECTRICAL DRAWINGS (PLANS, DIAGRAMS, ETC.) ARE DIAGRAMMATIC AND SHOULD NOT BE SCALED. THE DRAWINGS DO NOT SHOW EVERY BEND, OFFSET, ELBOW AND OTHER FITTINGS WHICH MAY BE REQUIRED FOR PROPER INSTALLATION IN THE SPACE ALLOCATED OR AS REQUIRED TO COORDINATE WORK WITH THAT OF OTHER TRADES. ANY WORK NOT SHOWN BUT CONSIDERED NECESSARY FOR THE PROPER COMPLETION OF THE WORK SHALL BE PROVIDED WITHOUT ADDITIONAL CHARGE TO THE OWNER.
7. ALL WORK SHALL BE INSTALLED IN A NEAT AND WORKMANLIKE MANNER.
8. THE CONTRACTOR SHALL SATISFACTORILY REPAIR AND/OR REPLACE EXISTING WORK, FEATURES AND EQUIPMENT DAMAGED AS A RESULT OF HIS WORK. SURFACES AND FINISHES SHALL BE RESTORED TO MATCH ADJACENT AREAS.
9. ALL CUTTING AND NOTCHING REQUIRED FOR THE INSTALLATION OF ELECTRICAL WORK SHALL BE ACCOMPLISHED IN AN APPROVED MANNER. APPROVAL SHALL BE OBTAINED FROM THE ENGINEER PRIOR TO CUTTING OR DRILLING STRUCTURAL MEMBERS UNLESS SPECIFICALLY ADDRESSED HEREIN.
10. EXISTING ELECTRICAL WORK, FEATURES AND EQUIPMENT INDICATED AND/OR REQUIRED TO BE REMOVED SHALL BE PROPERLY DISPOSED BY THE CONTRACTOR INCLUDING ABANDONED RACEWAYS, WIRING, BOXES, SWITCHES AND OTHER ELECTRICAL ITEMS NOT PLANNED TO REMAIN IN USE.
11. ALL DEVICE BOXES SHALL BE INSTALLED FLUSH AND CONDUITS RUN CONCEALED IN FINISHED AREAS EXCEPT AS SPECIFICALLY SHOWN OR NOTED OTHERWISE.
12. ALL WIRE SIZE SHALL BE #12 THIN/THIN UNLESS OTHERWISE NOTED ON DRAWINGS.
13. ALL CONDUCTORS SHALL BE COPPER.
14. ALL MATERIAL SHALL BE UL APPROVED.
15. A TYPEWRITTEN PANEL TALLY SHALL BE AFFIXED TO THE PANEL DOOR AFTER COMPLETION OF WORK THAT REFLECTS ALL CHANGES AND ADDITIONS.
16. ALL BRANCH CIRCUITS SHALL BE PROPERLY PHASE BALANCED.
17. ALL FLOOR PENETRATIONS SHALL BE SEALED WITH A FIRE SEAL SIMILAR TO "OZ" FLAMESEAL.
18. ALL NON-POWER RELATED WIRING IN CEILING A/C PLENUM RUNNING WITHOUT CONDUIT SHALL BE TEFLO COATED CLASSIFIED FOR USE IN PLENUMS.
19. ALL OUTLETS, SWITCHES AND COVER PLATES SHALL HAVE WHITE FINISH OR OTHER COLOR SELECTED BY OWNER AND LEVITON 5350/5252 SERIES OR EQUAL.
20. ALL BRANCH CIRCUITS SHALL BE EQUIPPED WITH A GREEN EQUIPMENT GROUNDING CONDUCTOR SIZED IN ACCORDANCE WITH NEC 250.55.
21. ALL EMPTY CONDUITS SHALL BE PROVIDED WITH NYLON PULL STRINGS.
22. FUSES SHALL BE DUAL ELEMENT, TIME DELAY UNLESS OTHERWISE NOTED.
23. ALL LUMINAIRES SHALL BE PROPERLY SUPPORTED IN ACCORDANCE WITH CEILING MANUFACTURER RECOMMENDATIONS IF APPLICABLE AND LOCAL REQUIREMENTS. MOUNTING DEVICES MUST BE CAPABLE OF SUPPORTING CEILING FAN FIXTURES.
24. ALL RECESS CANS SHALL BE 10' RATED, AND CONTROLLED BY DIMMER SWITCHES.
25. ALL CABLES SHALL BE RUN WITHOUT SPLICES UNLESS OTHERWISE NOTED.
26. PROVIDE REQUIRED CONNECTION FOR GARAGE DOOR OPENER(S), KITCHEN APPLIANCES, AND MECHANICAL EQUIPMENT.
27. ALL BATHROOM, GARAGE AND EXTERIOR RECEPTACLE OUTLETS AND KITCHEN RECEPTACLE OUTLETS WITHIN 6' OF WATER SOURCE SHALL BE GFI PROTECTED. ALL EXTERIOR RECEPTACLE OUTLETS SHALL BE WATER-PROOF PROTECTED. ALL BEDROOM RECEPTACLE OUTLETS SHALL BE ARC FAULT PROTECTED IN ACCORDANCE WITH NEC 210-12.
28. THE CONTRACTOR SHALL MAINTAIN ONE COMPLETE SET OF DRAWINGS TO INDICATE ALL CHANGES MADE TO THE ELECTRICAL DESIGN. THE AS-BUILT DRAWINGS SHALL BE DELIVERED TO THE OWNER AFTER COMPLETION OF THE WORK.
29. ALL SMOKE DETECTORS SHALL BE WIRED IN TANDEM.

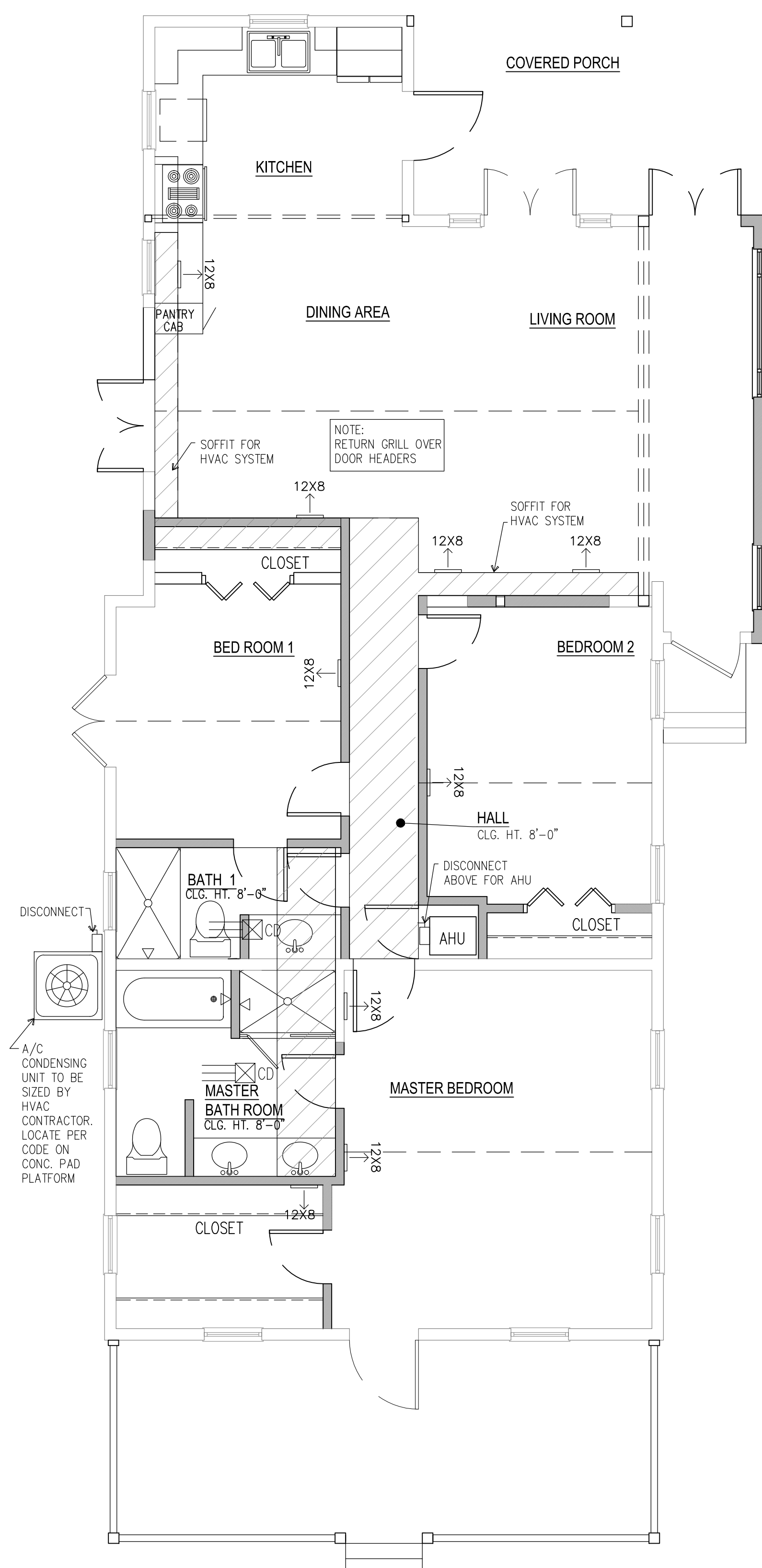

2 MECHANICAL PLAN
SCALE: 1/4" = 1'-0"

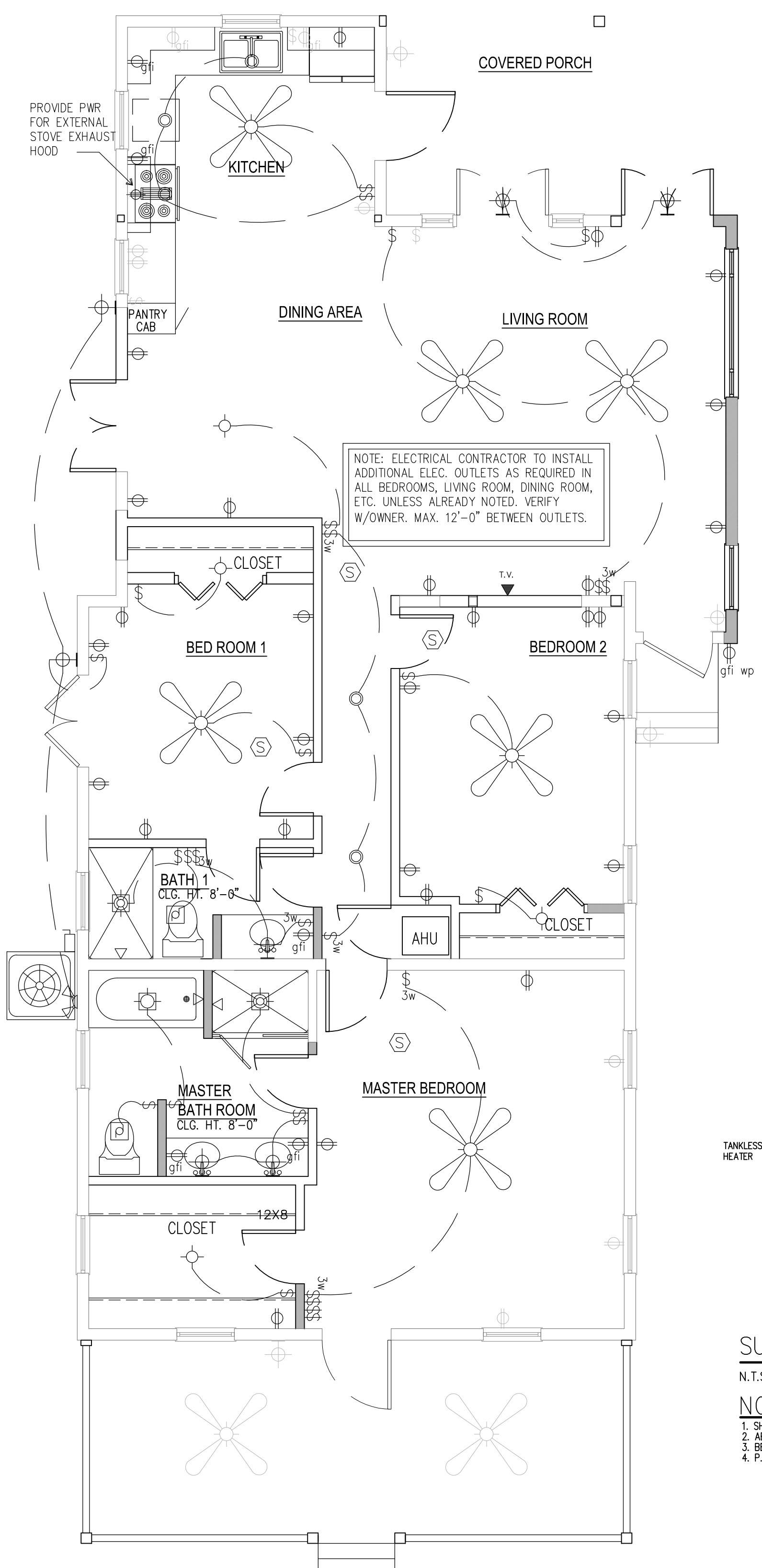

1 ELECTRICAL PLAN
SCALE: 1/4" = 1'-0"

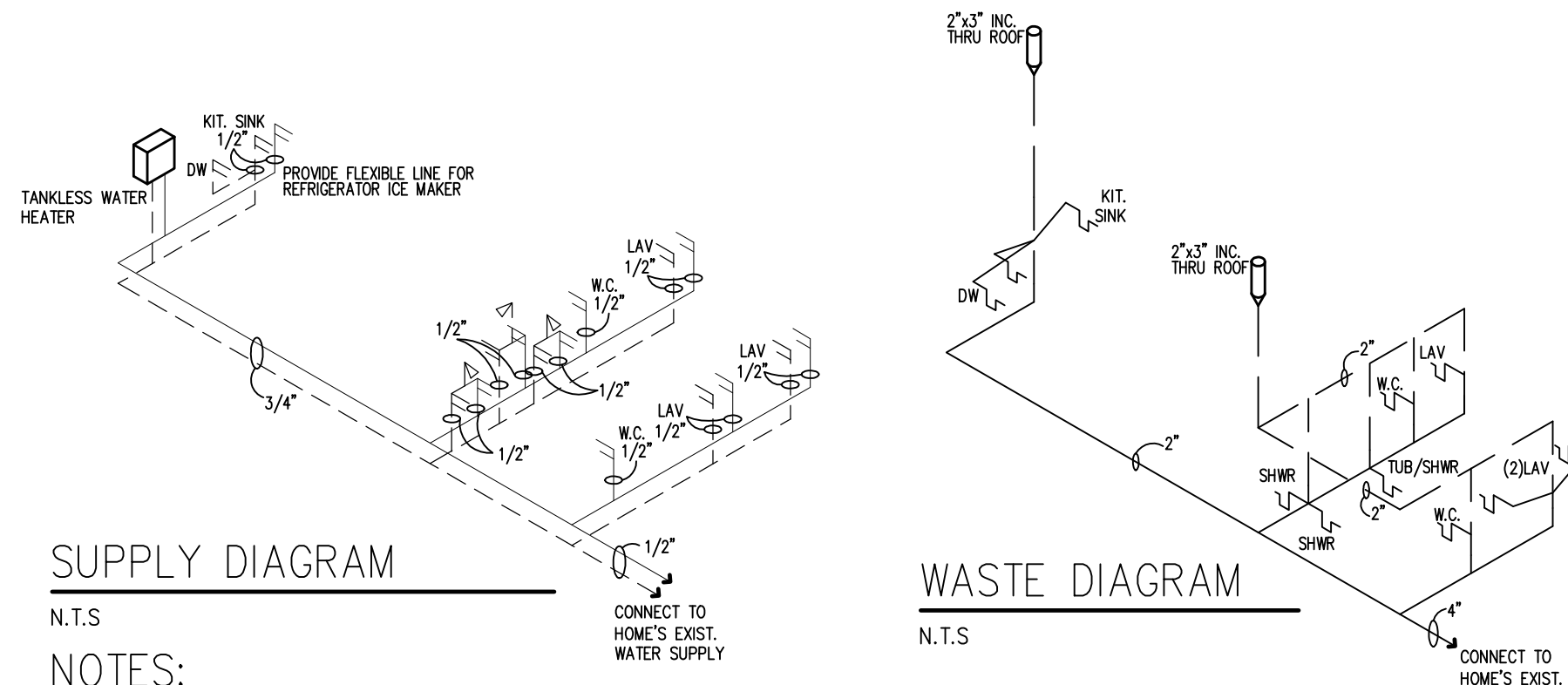

SUPPLY DIAGRAM
N.T.S.

NOTES:

1. SHUT-OFFS AT ALL FIXTURES AND BRANCHES
2. ABOVE GRADE WATER PIPING, COPPER
3. BELOW GRADE WATER PIPING, COPPER
4. P.V.C. WASTE LINES ABOVE GRADE.
5. P.V.C. WASTE LINES BELOW GRADE.
6. PROVIDE 1/2" COLD WATER SUPPLIES TO TOILET
7. PROVIDE 1/2" HOT & COLD WATER SUPPLIES TO ALL OTHER FIXTURES UNLESS NOTED

WASTE DIAGRAM
N.T.S.

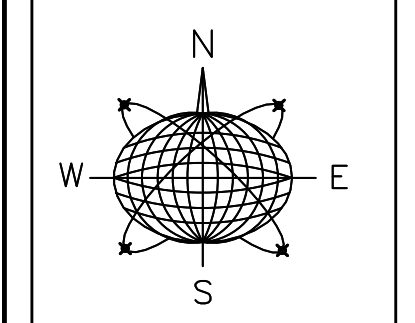

Meridian Engineering LLC
201 Front Street, Suite 210
Key West, Florida 33040
AUTHORIZATION # 330401
ph:305-293-3263 fax:293-4899

Seal:

NOT VALID FOR CONSTRUCTION UNLESS SIGNED AND SEALED IN THIS BLOCK
RICHARD J. MILELLI
PE #58315

General Notes:

- 1.
- 2.
- 3.
- 4.
- 5.
- 6.
- 7.
- 8.
- 9.
- 10.
- 11.
- 12.
- 13.
- 14.
- 15.
- 16.
- 17.
- 18.
- 19.
- 20.
- 21.
- 22.
- 23.
- 24.
- 25.
- 26.
- 27.
- 28.
- 29.
- 30.

RESIDENTIAL RENOVATION
HARC SUBMITTAL
614 FRANCES STREET
KEY WEST, FLORIDA

Drawn By: JMT
Checked By: RJM
Project No.:
Scale:

AutoCad File No.

Revisions:

NO.	DESCRIPTION
1	REVISIONS FOR RE-SUBMITTAL TO HARC 11-12-14

Title:
ELECTRICAL MECHANICAL AND PLUMBING PLAN

Sheet Number:
MEP-1
Date: NOVEMBER 3, 2014

Noticing

Public Meeting Notice

The Historic Architectural Review Commission will hold a public hearing at 5:30 p.m., November 25, 2014 at Old City Hall, 510 Greene Street, Key West, Florida. The purpose of the hearing will be to consider a request for:

ADD NEW “SAWTOOTH” ROOF TO REAR PORTION OF CONTRIBUTING HOUSE, EXTENSION OF EXISTING SHED ROOF, AND NEW POOL. DEMOLITION OF HISTORIC HIP AND SHED ROOFS ON A CONTRIBUTING HOUSE.

FOR- #614 FRANCES STREET

Applicant – Meridian Engineering

Application # H14-01-1744

If you wish to see the application or have any questions, you may visit the Planning Department during regular office hours at 3140 Flagler Avenue, call 809-3973 or visit our website at www.keywestcity.com.

THIS NOTICE CAN NOT BE REMOVED FROM THE SITE UNTIL HARC FINAL DETERMINATION



Public Meeting Notice

DATE: 10/15/2013 10:00 AM TO 12:00 PM
LOCATION: [illegible]
[illegible]

FOR MORE INFORMATION, CONTACT [illegible] AT [illegible] OR VISIT [illegible]

**Property Appraiser
Information**



Scott P. Russell, CFA
Property Appraiser
Monroe County, Florida

Key West (305) 292-3420
Marathon (305) 289-2550
Plantation Key (305) 852-7130

Property Record Card -

Maps are now launching the new map application version.

Alternate Key: 1010944 Parcel ID: 00010650-000000

Ownership Details

Mailing Address:

ROSS ELIZABETH
1015 FLEMING ST
KEY WEST, FL 33040-6962

Property Details

PC Code: 08 - MULTI FAMILY LESS THAN 10UNITS

Millage Group: 10KW

Affordable Housing: No

Section-Township-Range: 06-68-25

Property Location: 614 FRANCES ST KEY WEST

Legal Description: KW PT LOT 2 SQR 56 G22-335/38 OR722-656 OR859-959/1708 OR1279-634/635 OR1279-638/43-RESO 93-482
OR1279-634/35Q/C OR1279-636/637Q/C OR1279-644/48AFF OR1284-1804/05C OR1286-2179/85-E OR2185-2036
OR2399-104/107 OR2423-2104/06

Click Map Image to open interactive viewer



Land Details

Land Use Code	Frontage	Depth	Land Area
010D - RESIDENTIAL DRY	40	90	3,627.00 SF

Building Summary

Number of Buildings: 1
Number of Commercial Buildings: 0
Total Living Area: 1390
Year Built: 1933

Building 1 Details

Building Type R3
Effective Age 23
Year Built 1933
Functional Obs 0

Condition G
Perimeter 216
Special Arch 0
Economic Obs 0

Quality Grade 450
Depreciation % 30
Grnd Floor Area 1,390

Inclusions: R3 includes 3 3-fixture baths and 3 kitchens.

Roof Type GABLE/HIP
Heat 1 FCD/AIR DUCTED
Heat Src 1 ELECTRIC

Roof Cover METAL
Heat 2 NONE
Heat Src 2 NONE

Foundation WD CONC PADS
Bedrooms 3

Extra Features:

2 Fix Bath 0
 3 Fix Bath 0
 4 Fix Bath 0
 5 Fix Bath 0
 6 Fix Bath 0
 7 Fix Bath 0
 Extra Fix 2

Vacuum 0
 Garbage Disposal 0
 Compactor 0
 Security 0
 Intercom 0
 Fireplaces 0
 Dishwasher 0

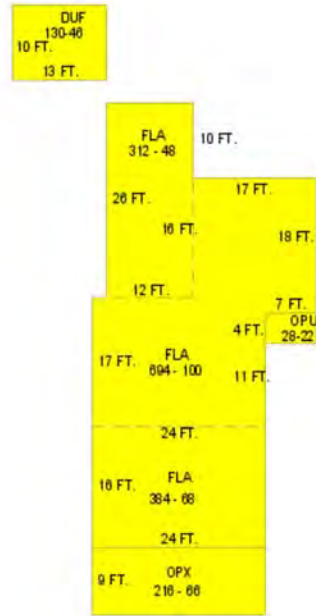

Sections:

Nbr	Type	Ext Wall	# Stories	Year Built	Attic A/C	Basement %	Finished Basement %	Area
1	FLA	12:ABOVE AVERAGE WOOD	1	1933	N Y	0.00	0.00	384
2	OPU		1	1992	N Y	0.00	0.00	28
4	DUF	1:WD FRAME/COMPOSITE	1	1992	N Y	0.00	0.00	130
5	OPX		1	1933				216
6	FLA	12:ABOVE AVERAGE WOOD	1	1933	Y			694

7	<u>FLA</u>	12:ABOVE AVERAGE WOOD	1	1933	Y	312
---	------------	--------------------------	---	------	---	-----

Misc Improvement Details

Nbr	Type	# Units	Length	Width	Year Built	Roll Year	Grade	Life
2	FN2:FENCES	156 SF	26	6	1982	1983	2	30
3	WD2:WOOD DECK	1,111 SF	0	0	1982	1983	2	40
5	FN2:FENCES	140 SF	35	4	2000	2001	2	30
6	PT2:BRICK PATIO	275 SF	11	25	2000	2001	2	50

Building Permits

Bldg	Number	Date Issued	Date Completed	Amount	Description	Notes
	12-1219	04/11/2012	10/11/2012	5,500		1200sf OF MAINT & PAINT 5SQRS VCRIMP
	M953348	10/01/1995	12/01/1995	3,200		3.5 TON AC
	E953776	11/01/1995	12/01/1995	2,000		ELECTRICAL
	P953981	11/01/1995	12/01/1995	800		FIXTURES
	0004322	12/21/2000	11/02/2001	500		REPAIRS TO PORCH
	03-0924	03/18/2003	08/08/2003	1,500		REPAIR SEWER

Parcel Value History

Certified Roll Values.

[View Taxes for this Parcel.](#)

Roll Year	Total Bldg Value	Total Misc Improvement Value	Total Land Value	Total Just (Market) Value	Total Assessed Value	School Exempt Value	School Taxable Value
2014	149,189	7,800	237,568	394,557	394,557	0	394,557
2013	153,452	7,857	220,993	382,302	299,767	25,000	310,158
2012	155,583	7,913	119,705	283,201	283,200	25,000	258,201
2011	155,583	7,973	165,745	329,301	321,876	25,000	304,301
2010	159,846	8,158	117,863	285,867	285,867	0	285,867
2009	201,417	8,215	316,249	525,881	525,881	0	525,881
2008	185,236	8,275	362,700	556,211	556,211	0	556,211
2007	218,051	8,317	598,455	824,823	824,823	0	824,823
2006	373,864	5,577	344,565	724,006	724,006	0	724,006
2005	373,864	5,773	272,025	651,662	494,610	25,000	469,610
2004	204,813	6,030	253,890	464,733	360,482	25,000	335,482
2003	197,227	6,220	126,945	330,392	272,071	25,000	247,071
2002	221,360	6,482	97,929	325,771	267,724	25,000	242,724
2001	177,657	6,672	97,929	282,258	238,559	25,000	213,559
2000	185,427	7,261	68,913	261,601	221,048	25,000	196,048
1999	148,921	6,034	68,913	223,869	195,181	25,000	170,181

1998	126,508	5,139	68,913	200,560	179,248	25,000	154,248
1997	117,472	4,922	61,659	184,053	167,701	25,000	142,701
1996	77,454	3,542	61,659	142,655	139,393	25,000	114,393
1995	69,374	3,192	61,659	134,225	132,775	25,000	107,775
1994	62,042	2,962	61,659	126,664	126,664	25,000	101,664
1993	62,042	3,050	61,200	126,293	126,293	25,000	101,293
1992	74,892	2,633	61,200	138,726	138,726	25,000	113,726
1991	74,892	2,701	61,200	138,793	138,793	25,000	113,793
1990	68,542	2,796	54,900	126,238	126,238	25,000	101,238
1989	89,198	2,602	54,000	145,800	145,800	25,000	120,800
1988	39,064	2,289	41,400	82,753	82,753	25,000	57,753
1987	38,570	2,343	24,660	65,573	65,573	25,000	40,573
1986	38,780	2,410	23,760	64,950	64,950	25,000	39,950
1985	37,565	2,459	17,949	57,973	57,973	25,000	32,973
1984	35,000	2,530	17,949	55,479	55,479	25,000	30,479
1983	35,000	359	17,949	53,308	53,308	25,000	28,308
1982	26,243	359	17,949	44,551	44,551	25,000	19,551

Parcel Sales History

NOTE: Sales do not generally show up in our computer system until about two to three months after the date of sale. If a recent sale does not show up in this list, please allow more time for the sale record to be processed.

Thank you for your patience and understanding.

Sale Date	Official Records Book/Page	Price	Instrument	Qualification
6/30/2009	2423 / 2104	620,000	<u>WD</u>	<u>02</u>
1/30/2009	2399 / 104	948,000	<u>WD</u>	<u>12</u>
2/8/2006	2185 / 2036	1,185,000	<u>WD</u>	<u>Q</u>
7/1/1982	959 / 1708	70,000	<u>WD</u>	<u>Q</u>
2/1/1977	T) /	25,000	00	<u>Q</u>

This page has been visited 44,970 times.

Monroe County Monroe County Property Appraiser
 Scott P. Russell, CFA
 P.O. Box 1176 Key West, FL 33041-1176