

DEVELOPMENT PLAN AND CONDITIONAL USE APPLICATION  
City of Key West Planning Department  
3140 Flagler Avenue, Key West, FL 33040  
(305) 809-3720



**Development Plan & Conditional Use Application**

**Applications will not be accepted unless complete**

Development Plan

Major  \_\_\_\_\_

Minor \_\_\_\_\_

Conditional Use

\_\_\_\_\_

Historic District

Yes \_\_\_\_\_

No  \_\_\_\_\_

Please print or type:

- 1) Site Address 1515-1525 Bertha Street & 1512 Dennis Street
- 2) Name of Applicant Trepanier & Associates Inc.
- 3) Applicant is: Owner \_\_\_\_\_ Authorized Representative  \_\_\_\_\_  
(attached Authorization and Verification Forms must be completed)
- 4) Address of Applicant 402 Appelrouth Lane  
Key West FL 33040
- 5) Applicant's Phone # 305-293-8983 Email \_\_\_\_\_
- 6) **Email Address:** lori@owentrepanier.com
- 7) Name of Owner, if different than above A.H. of Monroe County Inc.
- 8) Address of Owner PO Box 4374 key West FL 33041-4374
- 9) Owner Phone # \_\_\_\_\_ Email \_\_\_\_\_
- 10) Zoning District of Parcel (CL) Commercial Limited RE# 00063400-000000,00063400-000100
- 11) Is Subject Property located within the Historic District? Yes \_\_\_\_\_ No  \_\_\_\_\_  
If Yes: Date of approval \_\_\_\_\_ HARC approval # \_\_\_\_\_  
OR: Date of meeting \_\_\_\_\_
- 12) Description of Proposed Development and Use. Please be specific, list existing and proposed buildings and uses, number of dwelling units, parking, restaurant seats, vehicles proposed, etc. If there is more than one use, describe in detail the nature of each use (Give concise description here and use a separate sheet if necessary).

AHI is a nonprofit Florida corporation that provides case-managed health care, housing assistance, and support services for HIV-infected residents of the Florida Keys.

AHI of Monroe County, Inc. is proposing the redevelopment of their existing rest home facility at Marty's Place. The property currently consists of 16 individual living units. The redevelopment will allow for a total of 47 individual deed-restricted affordable living units as well as a 1,916 sq. ft. administration building. The redevelopment will provide for increased capacity to meet current AHI housing demands.

DEVELOPMENT PLAN AND CONDITIONAL USE APPLICATION

City of Key West Planning Department  
3140 Flagler Avenue, Key West, FL 33040  
(305) 809-3720



13) Has subject Property received any variance(s)? Yes \_\_\_\_\_ No  X

If Yes: Date of approval \_\_\_\_\_ Resolution # \_\_\_\_\_

Attach resolution(s).

14) Are there any easements, deed restrictions or other encumbrances on the subject property?

Yes \_\_\_\_\_ No  X

If Yes, describe and attach relevant documents.

---

---

A. For both *Conditional Uses* and *Development Plans*, provide the information requested from the attached **Conditional Use and Development Plan** sheet.

B. For *Conditional Uses* only, also include the **Conditional Use Criteria** required under Chapter 122, Article III, Sections 122-61 and 122-62 of the Land Development Regulations (see attached copy of criteria).

C. For *Major Development Plans* only, also provide the **Development Plan Submission Materials** required under Chapter 108, Article II, Division 7, Sections 108-226 through 108-248 of the Land Development Regulations (see attached copy of criteria) and any additional information as determined by the Planning Staff.

D. For both *Conditional Uses* and *Development Plans*, one set of plans **MUST** be signed & sealed by an Engineer or Architect.

**Please note, development plan and conditional use approvals are quasi-judicial hearings and it is improper to speak to a Planning Board member or City Commissioner about the project outside of the hearing.**

# Conditional Use & Development Plan Approval Criteria Analysis

Pursuant to Sec. 122-61 to -65

## AHI - **Marty's Place**



The following is an analysis of the specific criteria for approval, pursuant to Sec. 122-61 to -65, for the proposed redevelopment of Marty's Place.

Existing development is depicted in attached surveys and plans, including:

- Size of site
- Buildings
- Structures
- Parking
- FEMA flood zones
- Topography
- Utility locations
- Existing vegetation
- Existing stormwater
- Adjacent land uses
- Adjacent buildings
- Adjacent driveways

Proposed development is depicted in attached plans prepared by licensed architects, including:

- Floor Plans
- Buildings
- Utility Locations
- Driveway Dimensions
- Building Elevations
- Parking
- Setbacks
- Garbage and recycling
- Project Statistics

Solutions Statement:

AHI is a nonprofit Florida corporation that provides case-managed health care, housing assistance, and support services for HIV-infected residents of the Florida Keys.

AHI of Monroe County, Inc. is proposing the redevelopment of their existing rest home facility at Marty's Place. The property currently consists of 16 individual living units. The redevelopment will allow for a total of 47 individual living units as well as a 1,916 sq. ft. administration building. The redevelopment will provide for increased capacity to meet current AHI housing demands.

Key persons and entities involved in this project are as follows:

Owner: AHI Real Estate Properties, Inc.  
 Authorized Agent: Trepanier & Associates, Inc.  
 Architect: MHK, Architecture & Planning  
 Engineer: Meridian Engineering, LLC  
 Legal and Equitable Owners: AHI Real Estate Properties, Inc.

Site Data:

Dimensional Aspect	Permitted/ Required	Existing	Proposed	Compliance
Zoning	CL	CL	No Change	Complies
Min Lot Size	10,000 sq. ft.	33,066 sq. ft.	No Change	Complies
Max Density (Units/ acre)	16 units	NA	NA	Complies
Commercial FAR	0.8	0.24 (7,909 sq. ft.)	0.05 (1,916 sq. ft.)	Complies
Max Height	40 ft.	22 ft.	40 ft.	Complies
Open Space: Commercial	20%	40%	30% (9,915 sq. ft.)	Complies
Max Building Coverage	40%	29.5% (9,744 sq. ft.)	79% (26,385 sq. ft.)	Variance
Landscaping	20%	Unk.	30% (9,915 sq. ft.)	Complies
Impervious Surface	60%	56.2% (18,585 sq. ft.)	70% ( 23,151 sq. ft.)	Variance
Setbacks: Front (Dennis)	25' 0"	10' 5"	17' 5"	Variance
Front (Venetia)	25' 0"	11' 11"	25' 0"	Complies
Front (Bertha)	25' 0"	8' 9"	10' 0"	Variance
Side 1	20' 0"	0' 0"	15' 0"	Variance
Rear	25' 0"	9' 7"	15' 0"	Variance

Other Project Information:

This is a single phase project with construction beginning after the demolition of the existing 16 structures and administration building. The redevelopment of this site into 47 units will be completed within a 12-14 month timeframe after the site has been cleared.

Intergovernmental Coordination:

Coordination will occur as part of the DRC hearing process.

Schedule and Process:

The review process for conditional use review will be pursuant to Sec. 122-63

05/14/18	Submission Deadline
06/26/18	Development Review Committee
07/09/18	Tree Commission Hearing
07/19/18	Planning Board
08/14/18	Tree Commission Hearing
09/02/18	City Commission
30 days	City Commission Appeal Period
45 days	Department of Economic Opportunity Appeal Period



## SPECIFIC CRITERIA FOR CONDITIONAL USE APPROVAL

### Land use compatibility:

The attached analysis and plans demonstrate that the proposed project, including its proposed scale and intensity are compatible and harmonious with adjacent land use and will not adversely impact land use activities in the immediate vicinity.

### Site Size:

The Marty's Place site is 33,066 sq. ft.

### Mitigative techniques:

The proposed use will not create negative impacts that require mitigation; however, the site will be brought into compliance with stormwater water management and will be dramatically improved with landscaping. Parking will be added to the site along with on-site management.

### Hazardous waste:

The proposed use shall not generate hazardous waste or require use of hazardous materials in its operation.

### Compliance with applicable laws and ordinances:

This use shall comply with all applicable federal, state, county, and city laws and ordinances. Where permits are required from governmental agencies other than the city, these permits shall be obtained.

### Additional criteria applicable to specific land uses:

- Land uses within a conservation area - the proposed project is not located in a conservation area.
- New residential development of 47 units and an administration building is proposed.

## ANALYSIS: EVALUATION FOR COMPLIANCE WITH THE LDRS

### Concurrency Facilities and Other Utilities or Services (Section 108-233)

#### The anticipated public facility impacts of the proposed development:

The following concurrency analysis demonstrates that all anticipated development impacts to public facilities can be accommodated within current capacities and adopted levels of service.

#### The ability of existing facilities to accommodate the proposed development at the adopted level of service standards:

The following concurrency analysis demonstrates that all anticipated development impacts to existing facilities can be accommodated within current capacities and adopted levels of service.

Any existing facility deficiencies that will need to be corrected prior to the completion of the proposed development:

**There are no existing facility deficiencies that will need to be corrected prior to completion of the proposed development.**

The facility improvements or additions necessary to accommodate the impact of the proposed development at the adopted level of service standards and the entities responsible for the design and installation of all required facility improvements or additions:

**There are no facility improvements or additions necessary to accommodate the impact of the proposed development at the adopted level of service standards.**

The date such facility improvements or additions will need to be completed to be:

**NA – No improvements required.**

Fire Protection (Section 108-233 (8))

**Key West Fire Department coordination shall be per DRC. No objections are known to exist at this time.**

Site Location and Character of Use (Section 108-235):

**The project site is located in the Commercial-Limited ("CL") zoning district. The CL zoning district is intended to serve limited commercial land uses such as neighborhood residential markets, specialized markets with customized market demands, and tourist-oriented markets. Based on the surrounding zoning and land uses, the proposed project is compatible with neighboring properties.**

Location and screening of mechanical equipment, utility hardware and waste storage areas (Section 108-279):

**Please see attached plans.**

Utility lines (Section 108-282):

**No changes proposed.**

Commercial and manufacturing activities conducted in enclosed buildings (Section 108-283):

**All commercial activities are proposed to occur within enclosed buildings.**

Exterior Lighting (Section 108-284):

**All lighting will be consistent with Sec. 108-284.**

Signs (Section 108-285):

**Signage shall be approved under Sec. 108-285**

Pedestrian sidewalks (Section 108-286):

**All pedestrian sidewalks will be designed consistent with Sec. 108-286.**

Loading docks (Section 108-287):  
No changes proposed.

Storage Areas (Section 108-288):  
No changes are proposed.

In-Site and Off-Site Parking and Vehicular, Bicycle, and Pedestrian Circulation (Section 108-244):

Pursuant to Sec. 108-572 the parking demands for AHI housing conform to Nursing/Convalescent Home (Sec. 108-572(12)).

Existing Parking: 12 spaces; Proposed Parking: 37 spaces

Use	Parking Requirement	Existing (16 Beds)	Required (47 Beds)	Proposed
Nursing/Convalescent homes (Sec. 108-572(12))	1 space for every 4 beds	12	11.75	40
	10% Bicycles	Unk.	1.17	17
Office (Sec. 108-572(15))	1 space per 300 sq. ft.	0	6.39	7
	25% Bicycles	0	1.59	3
Total	Auto	12	18.14	47
	Bicycle	Unk.	2.76	20

Housing (Section 108-245):

Thirty-one new individual rest home living units will be added as a result of this project.

Units	No.
Existing Rest Home Living Units	16
Number to be Redeveloped	0
New Rest Home Living Units to be added	47
Total Number of Units (Post Development)	47

Economic resources (Section 108-246):  
No significant changes are anticipated.

Special Conditions (Section 108-247):

The proposal complies with the goals, objectives and policies of the comprehensive plan and as demonstrated by the concurrency analysis there are no conflicts with the existing public facilities, such as wastewater treatment and transportation.

The project is located within the CL District and complies with the intent of the plan.

There is no impact on the unincorporated portion of the county.

Construction Management Plan and Inspection Schedule (Section 108-248):

Construction will be done in two phases. Phase I will commence as soon as possible following the approval, Phase II will commence within 5 years.

Open Space, Screening, Buffers and Landscaping (Article V and VI) of Chapter 108:

This application/request for modification to the standards of this ordinance is hereby filed with the city planning office and shall be considered by the planning board after reviewing recommendations of the city planner or designated staff. The planning board shall render the final action.

This request is to waive the following landscape requirements of Sec. 108 so as to:

1. Protect and preserve the integrity of this vital community service.
2. The waiver will not have a significant adverse impact on the public interest, or on adjacent property.
3. The waiver or modification is not discriminatory, considering similar situations in the general area.
4. The development will provide an alternative landscape solution which will achieve the purposes of the requirement through clearly superior design.
5. The waiver or modification is necessary to preserve or enhance significant existing cultural and public-like facilities related to the development site.
6. Strict application of the requirement will effectively deprive the owner and the community of reasonable use of the land for the intended purpose due to its unusual size, shape, and location.
7. The effect upon the owner is not outweighed by a valid public purpose in imposing the requirement in this case.
8. The unusual conditions involved, i.e. the need for case-managed health care, housing assistance, and support services for HIV-infected residents of the Florida Keys are not the result of actions of the developer or property owner which occurred after the effective date of the ordinance from which this section derives.
9. Strict application of the requirement would be technically impractical.

Specific Waivers/ Modifications:

Sec. 108-413. Requirements along street frontage.

To permit the street frontage landscaping as proposed on the attached plans.

Sec. 108-415. Perimeter landscape requirements.

To permit the perimeter landscaping as proposed on the attached plans.

Sec. 108-416. Other landscape requirements for nonvehicular use areas.

To permit the nonvehicular use area landscaping as proposed on the attached plans.

Sec. 108-450. Landscape screening.

To permit the landscape screening as proposed on the attached plans.

Stormwater and Surface Water Management (Article VIII):

No changes required or proposed.

Flood Hazard Areas (Division 4 - Sections 108-821 through 108-927):

No changes proposed.

Utilities (Article IX):

No changes proposed.

## CONCURRENCY ANALYSIS:

The City's Comprehensive Plan Objective 9-1.5 directs the City to ensure that facilities and services needed to support development are available concurrent with the impacts of new development.

The following specific issues are outlined:

1. Potable Water & Sanitary Sewer
2. Recreation (for residential development only)
3. Solid Waste
4. Drainage
5. Roads/Trip Generation

The following concurrency analysis reflects the anticipated impacts resulting from the proposed conversion of existing commercial floor area to retail use.

Potable Water & Sanitary Sewer "Planned improvements in potable water and/or wastewater systems required to establish and/or maintain adopted water and wastewater levels of service. System improvements and proposed funding resources required for implementing any improvements required to establish and/or maintain adopted potable water and wastewater system level of service standards<sup>1</sup>:"

Potable Water Policy 9-1.6.1 sets the level of service for residential potable water at 100 gal/capita/ day.

- i) The total residential capacity required for the existing 16 unit (16 people) parcel is:

$$100 \text{ gal/capita/day} \times 16 \text{ people} = 16,000 \text{ gal/day}$$

- ii) The total residential capacity required for the proposed 47 unit (47 people) parcel is:

$$100 \text{ gal/capita/day} \times 47 \text{ people} = 47,000 \text{ gal/day}$$

- iii) The total nonresidential capacity required for the existing is:

$$100 \text{ gal/capita/day} \times 1 \text{ people} = 100 \text{ gal/day}$$

- iv) The total nonresidential capacity required for the proposed 2 employees parcel is:

$$100 \text{ gal/capita/day} \times 2 \text{ people} = 200 \text{ gal/day}$$

---

<sup>1</sup> The City of Key West's Comprehensive Plan Policy 9-1.5.1: Resolving Concurrency Issues.

Based on the concurrency management calculation prescribed in the Comprehensive Plan, there is no or minimal increase in the proposed capacity required by Key West Comprehensive Plan LOS standards; the Florida Keys Aqueduct Authority has the capacity to supply adequate service to this property, as demonstrated below.

**FKAA Supply Capacity:**

The Florida Keys Aqueduct Authority ("FKAA") has adequate supply capacity to serve the potential development. FKAA has constructed facilities on the mainland in Florida City to expand water supply for the Florida Keys. This permitted and constructed improvement enables FKAA to provide over 23 MGD, which will provide sufficient capacity through 2022<sup>2</sup>. Operational in 2011, the recent expansion of the R.O. plant will provide 6.0 MGD, which combined with the 17.0 MGD permitted withdrawal from the Biscayne Aquifer, increased available water supply to 23 MGD for the Florida Keys.

*Expanded Florida City R.O. Plant.* The Department of Health issued Permit # 150092-007-wc/04 (Exhibit I) on November 14, 2006 to allow for the construction of an expanded reverse osmosis (R.O.) water plant in Florida City. The expanded water plant is designed to treat blended Floridian Aquifer water as an alternative water source to the Biscayne Aquifer. The permit design capacity of the expanded R.O. plant is 6 MGD.

*Revised Water Use Permit.* The SFWMD issued revised Water Use Permit (WUP) #13-00005-W (Exhibit II) on March 26, 2008, which recognizes the additional blended Floridian Aquifer capacity that will be provided by the expanded R.O. plant. Interim Water Use Allocations in the WUP permit provide FKAA with an allocation of 17.00 MGD (dry season) and 17.79 GPD (wet season) which may be withdrawn from the Biscayne Aquifer and allows FKAA to utilize the Stock Island and Marathon Reverse Osmosis plants for any demands exceeding the interim withdrawal limit, pending completion of the R.O. plant in Florida City. The Stock Island and Marathon R.O. plants have a combined capacity of 3.0 MGD providing an interim WUP water supply of 20.0 MGD during the dry season if needed. Once operational in 2010, the R.O. plant will provide an additional 6.0 MGD, which when combined with the 17.0 MGD permitted withdrawal from the Biscayne Aquifer, will increase available water supply to 23 MGD for the Florida Keys.

The interim allocation of 20 MGD (7,300 MG/year) through 2010 and 23 MGD after 2010 provides ample water supply to support the adopted amendment and allocated growth well beyond 10 years. The "Monroe County 2007 Annual Public Facilities Report" documents historic water use in the Florida Keys. Water demand has fluctuated significantly on an annual basis, however when evaluated over a ten-year period, the data shows an increase in water demand of more than 1 billion gallons over the last 10 years with an annual average increase of approximately 104 MG/year. This increase in demand can be shown in the following calculation:

$$1996 \text{ annual water demand} = 5,272 \text{ MG /year}$$

---

<sup>2</sup> Excerpt from Analysis by Kenneth B. Metcalf, AICP, (Greenberg Traurig, P.A.), August 22, 2008.



2006 annual water demand = 6,310 MG /year  
Average Annual Increase =  $(6,310 \text{ MG} - 5,272\text{MG}) / 10 = 103.8 \text{ MG /year}$

Based on the average annual increase of 103.8 MG per year, the interim allocation would be sufficient for an additional 9.5 years of growth beyond 2006 or through 2015 until demand reaches the interim permitted withdrawal of 20 MGD (7,300 MG/year). Since completion of the Florida City facilities, the 23 MGD allocation is available to support yet another 9.5 years of growth. Based on these findings, sufficient permitted water supply is available to meet the needs of the Florida Keys through 2024.

*Improvements Schedule/Status.* Condition 30 of the WUP provides the R.O. plant and the associated Floridian deep wells that will provide 23 MGD of capacity through 2024:

- DEP Underground Injection and Control permit was obtained on May 21, 2008.
- Construction contracts were required within 180 days or by November 21, 2008;
- Testing is required within one year and 30 days from issuance of the permit or by June 21, 2009.
- The R.O. plant construction was completed in January, 2010.

**Sanitary Sewer** Policy 9-1.6.1 sets the level of service for residential sanitary sewer at 100 gal/capita/day and nonresidential sanitary sewer at 660 gal/acre/day.

i) the total residential capacity required for the existing 16 unit parcel is:

$$100 \text{ gal/capita/day} \times 16 \text{ people} = 1,600 \text{ gal/day}$$

ii) the total residential capacity required for the proposed 47 unit parcel is:

$$100 \text{ g gal/capita/day} \times 47 \text{ people} = 4,700 \text{ gal/day}$$

iii) the total nonresidential capacity required for the existing 0.18 acre parcel is:

$$660 \text{ gal/acre/day} \times 0.18 \text{ acres} = 119.8 \text{ gal/day}$$

iv) the total nonresidential capacity required for the proposed 0.04 acre parcel is:

$$660 \text{ gal/acre/day} \times 0.04 \text{ acres} = 26.4 \text{ gal/day}$$

The current wastewater treatment plant has the potential treatment capacity of 10 million gallons per day. Only 4.8 million gallons per day of capacity are currently utilized<sup>3</sup>. The current plant has the capacity to service this project's projected needs.

Recreation "In cases where residential development is proposed, information shall be submitted describing plans for accommodating recreational demands generated by the development, including demonstrated evidence that the City's adopted level of service for recreation shall not be adversely impacted<sup>4</sup>:"

The City's adopted level of service for recreation will not be adversely impacted.

Solid Waste- "Projected demand generated by the development on the solid waste disposal system and assurances that the City's adopted level of service for solid waste disposal shall not be adversely impacted<sup>5</sup>:"

Sec. 94-71 sets the level of service for residential solid waste disposal (1994-2010) at 2.66 lb/capita/day and nonresidential solid waste disposal at 6.37 lb/capita/day<sup>6</sup>.

i) the total capacity required for the existing 1 employees is:

$$6.37 \text{ lb/capita/day} \times 1 \text{ employees} = 6.37 \text{ lb/day}$$

ii) the total capacity required for the proposed 2 employees<sup>7</sup> is:

$$6.37 \text{ lb/capita/day} \times 19.6 \text{ employees} = 12.74 \text{ lb/day}$$

Based on the City's LOS standards there will be a projected reduction in solid waste generation on the site. Waste Management has more than enough capacity to handle the projected load

Drainage - "Conceptual plan for accommodating storm water run-off and demonstrated evidence that the proposed drainage improvements shall accommodate storm water run-off without adversely impacting natural systems or the City's adopted level of service for storm drainage<sup>8</sup>"

This site currently meets the minimum requirements through best management practices.

Roads/Trip Generation - "Estimated trips for the peak hour generated by the proposed land use(s) together with anticipated on- and off-site improvements necessitated to accommodate the traffic impacts generated by the development including, additional R/W, roadway improvements, additional paved laneage, traffic signalization, proposed methods for controlling access and egress, and other similar improvements<sup>9</sup>:"

---

<sup>3</sup> Per September 3, 2010 memo from Greg Smith, project Manager for CH2M Hill OMI (Exhibit III)

<sup>4</sup> The City of Key West's Comprehensive Plan Policy 9-1.5.1: Resolving Concurrency Issues.

<sup>5</sup> The City of Key West's Comprehensive Plan Policy 9-1.5.1: Resolving Concurrency Issues.

<sup>6</sup> For these calculations, we chose to use the number of employees to represent the "capita."

<sup>7</sup> APA Planner's Estimating Guide (Table 4-2)

<sup>8</sup> The City of Key West's Comprehensive Plan Policy 9-1.5.1: Resolving Concurrency Issues

<sup>9</sup> Ibid

ITE Use	Peak PM Hour Trip Generation by Wkday			
	Existing		Proposed	
Assisted Living (ITE 254) 0.22 Trips per occ. bed	16 bed	3.5	47 bed	10.3
General Office (ITE 710) 1.49 trips/1k sq. ft.	7,909 sqft	11.7	1,916 sq.ft	2.8
Total		15.2		13.14

Exhibits

*Exhibit I* – Department of Health Permit #150092-007-wc/04

*Exhibit II* – Water Use Permit (WUP) #13-00005-W

*Exhibit III* – September 3, 2010 Wastewater Memo

*Exhibit IV* – Map of the City of Key West’s Existing Recreation Services

*Exhibit V* – January 25, 2010 Solid Waste Memo

City of Key West  
Planning Department



Verification Form

(Where Authorized Representative is an Entity)

I, Owen Trepanier, in my capacity as President  
*(print name)* *(print position; president, managing member)*  
of Trepanier & Associates, Inc.  
*(print name of entity serving as Authorized Representative)*

being duly sworn, depose and say that I am the Authorized Representative of the Owner (as appears on the deed), for the following property identified as the subject matter of this application:

1515-1525 Bertha Street & 1512 Dennis Street

*Street Address of subject property*

All of the answers to the above questions, drawings, plans and any other attached data which make up the application, are true and correct to the best of my knowledge and belief. In the event the City or the Planning Department relies on any representation herein which proves to be untrue or incorrect, any action or approval based on said representation shall be subject to revocation.

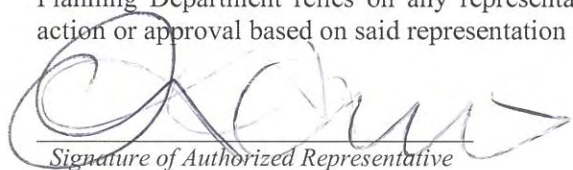
  
*Signature of Authorized Representative*

Subscribed and sworn to (or affirmed) before me on this 10<sup>th</sup> May 2018 by  
Owen Trepanier  
*Name of Authorized Representative* *date*

He is personally known to me or has presented \_\_\_\_\_ as identification.

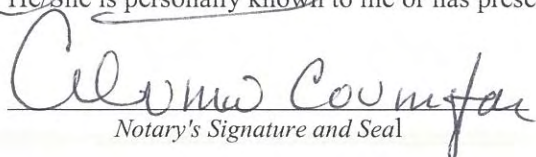
  
*Notary's Signature and Seal*

ALVINA COVINGTON  
*Name of Acknowledger typed, printed or stamped*



Alvin Covington  
COMMISSION #FF913801  
EXPIRES: August 27, 2019  
WWW.AARONNOTARY.COM

FF913801  
*Commission Number, if any*

City of Key West  
Planning Department



Authorization Form  
(Where Owner is a Business Entity)

Please complete this form if someone other than the owner is representing the property owner in this matter.

I, Eugene Scott Pridgen as  
*Please Print Name of person with authority to execute documents on behalf of entity*

Executive Director/CEO of A.H. of Monroe County Inc. d/b/a AIDS Help  
*Name of office (President, Managing Member)* *Name of owner from deed*

authorize Trepanier & Associates, INC.  
*Please Print Name of Representative*

to be the representative for this application and act on my/our behalf before the City of Key West.

*Eugene Scott Pridgen*  
*Signature of person with authority to execute documents on behalf on entity owner*

Subscribed and sworn to (or affirmed) before me on this May 10, 2018  
*Date*

by Eugene Scott Pridgen  
*Name of person with authority to execute documents on behalf on entity owner*

He She is personally known to me or has presented \_\_\_\_\_ as identification.

*Red*  
*Notary's Signature and Seal*

\_\_\_\_\_  
*Name of Acknowledger typed printed or stamped*

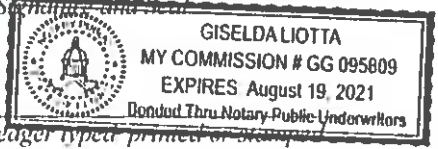

\_\_\_\_\_  
*Commission Number, if any*

# This Indenture,

Made this 16th day of July, A.D. 1990,

900  
150  
4372 30

Between, BRANCHIK ENTERPRISES, INC.,  
a corporation existing under the laws of the State of OHIO and State of Ohio, having its  
principal place of business in the County of party of the first part, and

AIDS HELP, INC.

of the County of MONROE and State of FLORIDA part  
of the second part,

Witnesseth, That the said party of the first part, for and in consideration of the sum of  
TEN DOLLARS (\$10.00) AND OTHER GOOD AND VALUABLE CONSIDERATION Dollars, to it in hand  
paid, the receipt whereof is hereby acknowledged, has granted, bargained, sold, aliened, remised,  
released, conveyed and confirmed, and by these presents doth grant, bargain, sell, alien, remise,  
release, convey and confirm unto the said party of the second part, and  
heirs and assigns forever, all that certain parcel of land lying and being in the County of  
MONROE and State of Florida, more particularly described as follows:

On the Island of Key West, known on William A. Whitehead's map delineated in  
February, A.D. 1829 as part of Tract Thirty but now particularly described as  
follows, to-wit:

Lots 1,2,3,4,11,12, and 14, in Square 6, according to W.D. Cash's Diagram of  
land in Tract Thirty, surveyed and drawn from map of William A. Whitehead's  
by T.J. Ashe, Deputy County Surveyor, dated March 8, 18887, said diagram being  
recorded in Plat Book 1, Page 13, Monroe County, Florida Public Records.

SUBJECT TO restrictions, easements, limitations, conditions of record if any,  
and taxes for the year 1990 and subsequent years.

THIS INSTRUMENT PREPARED BY:  
ROBERT T. FELDMAN, ESQUIRE  
ATTORNEY AT LAW  
FELDMAN & KOENIG, P.A.  
417 EATON STREET, KEY WEST, FLORIDA 33040

647990 REC-138 PAGE 1952

FILED FOR RECORD

90 JUL 19 P4:09

MONROE COUNTY

DS Paid 4372.50 Date 7-19-90  
MONROE COUNTY  
DANNY B. KOLHAGE, CLERK CIR. CT.  
By *[Signature]* D.C.

Together with all the tenements, hereditaments and appurtenances, with every privilege,  
right, title, interest and estate, reversion, remainder and easement thereto belonging or in any  
wise appertaining:

To Have and to Hold the same in fee simple forever.

And the said party of the first part doth covenant with the said party of the second part  
that it is lawfully seized of the said premises; that they are free of all incumbrances, and that  
it has good right and lawful authority to sell the same; and the said party of the first part does  
hereby fully warrant the title to said land, and will defend the same against the lawful claims  
of all persons whomsoever.

In Witness Whereof, the said party of the first part has caused  
these presents to be signed in its name by its President, and its corp-  
orate seal to be affixed, attested by its  
the day and year above written.

BRANCHIK ENTERPRISES, INC.

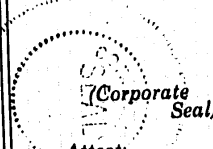

Attest:

Signed, Sealed and Delivered in Our Presence:

By *[Signature]*  
JONATHAN BRANCHIK President.

*[Signature]*



647990 REC 138 PAGE 1953

State of Florida  
County of Monroe

I Hereby Certify That on this 16th day of July A.D. 1990, before me personally appeared JONATHON BRANCHIK and respectively of BRANCHIK ENTERPRISES, INC. , a corporation under the laws of the State of Ohio , to me known to be the persons described in and who executed the foregoing conveyance to AIDS HELP, INC., a Florida Corporation

and severally acknowledged the execution thereof to be their free act and deed as such officers, for the uses and purposes therein mentioned; and that they affixed thereto the official seal of said corporation, and the said instrument is the act and deed of said corporation.

Witness my signature and official seal at Key West in the County of Monroe and State of Florida, the day and year last aforesaid.

My Commission Expires May 3, 1992

*[Signature]*  
Notary Public

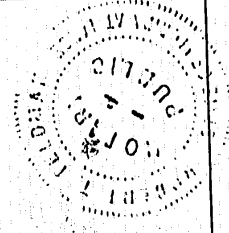

Recorded in Official Record Book  
In Monroe County, Florida  
Record Verifying  
DANNY L. ROBERTS JR.  
Clerk Circuit Court

Warranty Deed

FROM CORPORATION

TO

Date

ABSTRACT OF DESCRIPTION



Return to: (enclose self addressed stamped envelope)  
Name Robert T. Feldman, Esq.

Address: 417 Eaton Street  
Key West, Florida 33040 857010

OFF REC 1322 PAGE 1342

1300  
200  
70

This Instrument Prepared by: Robert T. Feldman

Address: Above

Grantee Name and S.S. -: 65-0363080  
Address: \_\_\_\_\_

Grantee Name and S.S. -: \_\_\_\_\_  
Address: \_\_\_\_\_

FILED FOR RECORD  
94 SEP 12 A9:44  
DANNY B. ROBERTS  
CLK. DIR. OF  
MONROE COUNTY, FLA.

SPACE ABOVE THIS LINE FOR PROCESSING DATA

SPACE ABOVE THIS LINE FOR PROCESSING DATA

# This Indenture,

Made this 8th day of September, A. D. 19 94,

Between, AIDS HELP, INC., a Florida not-for-profit corporation existing under the laws of the State of Florida, having its principal place of business in the County of Monroe and State of Florida, party of the first part, and

A.H.I. REAL ESTATE PROPERTIES, INC., a Florida not-for-profit corporation

of the County of Monroe and State of Florida party of the second part,

Witnesseth, that the said party of the first part, for and in consideration of the sum of TEN AND 00/100 (\$10.00) Dollars, to it in hand paid, the receipt whereof is hereby acknowledged, has granted, bargained, sold, aliened, remise, released, conveyed and confirmed, and by these presents doth grant, bargain, sell, alien, remise, release, convey and confirm unto the said party of the second part, and its heirs and assigns forever, all that certain parcel of land lying and being in the County of Monroe and State of Florida, more particularly described as follows:

SEE EXHIBIT "A" ATTACHED HERETO AND MADE A PART HEREOF BY REFERENCE.

Subject to conditions, restrictions, limitations and easements of record and to taxes for the current and subsequent years.

Property Appraiser's Parcel Identification Number: 0006340

Together with all the tenements, hereditaments and appurtenances, with every privilege, right, title, interest and estate, reversion, remainder and easement thereto belonging or in anywise appertaining:

To Have and to Hold the same in fee simple forever. And the said party of the first part doth covenant with the said party of the second part that it is lawfully seized of the said premises; that they are free of all incumbrances, and that it has good right and lawful authority to sell the same; and the said party of the first part does hereby fully warrant the title to said land, and will defend the same against the lawful claims of all persons whomsoever.

In Witness Whereof, the said party of the first part has caused these presents to be signed in its name by its President, and its corporate seal to be affixed, attested by its \_\_\_\_\_ the day and year above written.



AIDS HELP, INC., a Florida not-for-profit corporation

Signed, Sealed and Delivered in Our Presence:

Charles E. Larkin  
CHARLES E. LARKIN

By Carol L. Rogers  
CAROL L. ROGERS  
President.

Robert T. Feldman  
Robert T. Feldman

State of Florida

County of Monroe

I Hereby Certify that on this 8th day of September A.D. 1994 before me personally appeared Carol L. Rogers and

Presidents and respectively of AIDS HELP, INC., a Florida not-for-profit corporation under the laws of the State of Florida, and who are personally known to me or have produced as identification and did (did not) take an oath; they have severally acknowledged the execution thereof to be their free act and deed as such officers, for the uses and purposes therein mentioned; and that they affixed thereto the official seal of said corporation, and the said instrument is the act and deed of said corporation.



Ruth Smith  
Signature  
Ruth Smith  
Printed Name  
Notary Public  
Title  
CC236903  
Serial #, if Any

Warranty Deed

FORM 1123 REV. 11/91

FROM CORPORATION

TO

Date

ABSTRACT OF DESCRIPTION

TITLEBLANK REGISTERED U. S. PATENT OFFICE  
TUTTLE LAW PRINT. PUBLISHERS, WILMINGTON, VT 05702

ATTORNEY AT LAW  
FELDMAN & KOENIG, P.A.  
417 EATON STREET  
KEY WEST, FL 33040

857010

OFF  
REC | 322 PAGE | 344

On the island of Key West and known as Lot 1 and part of Lots 2 and 12, in Square 6 according to W. D. Cash's Diagram of Land in Tract Thirty, by T.J. Ashe, Deputy County Surveyor, dated March 8, 1887, as recorded in Plat Book 1 at Page 13 of the Public Records of Monroe County, Florida; said parcel being more particularly described by metes and bounds as follows:

Commence at the intersection of the NW'ly right of way line of Venetia Street with the NW'ly right of way line of Dennis Street and run thence in a SW'ly direction along the NW'ly right of way line of Venetia Street for a distance of 123.67 feet to the Point of Beginning; thence NW'ly and at right angles for a distance of 113.67 feet; thence SW'ly and at right angles for a distance of 61.33 feet to the NE'ly right of way line of Bertha Street; thence SE'ly and at right angles along the NE'ly right of way line of Bertha Street for a distance of 113.67 feet to the NW'ly right of way line of the said Venetia Street; thence NE'ly at right angles and along the NW'ly right of way line of the said Venetia Street for a distance of 61.33 feet back to the Point of Beginning.

Recorded in Official Records  
in Monroe County, Florida  
Record Verified  
DANNY L. KOYFACE  
Clerk Circuit Court

EXHIBIT A

 **qPublic.net™** Monroe County, FL

**Summary**

Parcel ID 00063400-000000  
 Account # 1063835  
 Property ID 1063835  
 Millage Group 10KW  
 Location 1512 DENNIS St., KEY WEST  
 Address  
 Legal KW DIAG PB1-13 PT LOT 2 & ALL LOTS 3 & 4 & 11 & PT LOT 12 & ALL LOT 14 SQR 6  
 Description TR 30 G26-184 G30-254/255 G33-408/409 OR629-174 OR654-569  
 OR1138-1952/1953 OR1198-1899/1900(LG) OR1235-1857/61(RES NO 92-493)(LG)  
 (Note: Not to be used on legal documents)  
 Neighborhood 31050  
 Property Class HOMES FOR THE AGED (7400)  
 Subdivision  
 Sec/Twp/Rng 05/68/25  
 Affordable No  
 Housing



**Owner**

A.H. OF MONROE COUNTY INC  
 PO BOX 4374  
 KEY WEST FL 33041

**Valuation**

	2017	2016	2015	2014
+ Market Improvement Value	\$881,141	\$779,802	\$817,765	\$813,619
+ Market Misc Value	\$32,535	\$32,753	\$27,923	\$26,157
+ Market Land Value	\$257,114	\$259,739	\$259,739	\$247,371
= Just Market Value	\$1,170,790	\$1,072,294	\$1,105,427	\$1,087,147
= Total Assessed Value	\$1,170,790	\$1,072,294	\$1,105,427	\$1,087,147
- School Exempt Value	(\$1,170,790)	(\$1,072,294)	(\$1,105,427)	(\$1,087,147)
= School Taxable Value	\$0	\$0	\$0	\$0

**Land**

Land Use	Number of Units	Unit Type	Frontage	Depth
COMMERCIAL DRY (100D)	26,050.00	Square Foot	0	0

**Commercial Buildings**

Style S.F.R. - R1 / R1  
 Gross Sq Ft 384  
 Finished Sq Ft 312  
 Perimeter 0  
 Stories 1  
 Interior Walls WALL BD/WD WAL  
 Exterior Walls ABOVE AVERAGE WOOD  
 Quality 500 ()  
 Roof Type GABLE/HIP  
 Roof Material METAL  
 Exterior Wall1 ABOVE AVERAGE WOOD  
 Exterior Wall2  
 Foundation CONC BLOCK  
 Interior Finish WALL BD/WD WAL  
 Ground Floor Area  
 Floor Cover CONC S/B GRND  
 Full Bathrooms 1  
 Half Bathrooms 0  
 Heating Type NONE with 0% NONE  
 Year Built 1943  
 Year Remodeled  
 Effective Year Built 1997

Code	Description	Sketch Area	Finished Area	Perimeter
FLA	FLOOR LIV AREA	312	312	0
SPF	SC PRCH FIN LL	72	0	0
<b>TOTAL</b>		<b>384</b>	<b>312</b>	<b>0</b>

Style S.F.R. - R1 / R1

Gross Sq Ft 618  
 Finished Sq Ft 312  
 Perimiter 0  
 Stories 1  
 Interior Walls WALL BD/WD WAL  
 Exterior Walls ABOVE AVERAGE WOOD  
 Quality 500 ()  
 Roof Type GABLE/HIP  
 Roof Material METAL  
 Exterior Wall1 ABOVE AVERAGE WOOD  
 Exterior Wall2  
 Foundation CONC BLOCK  
 Interior Finish WALL BD/WD WAL  
 Ground Floor Area  
 Floor Cover CONC S/B GRND  
 Full Bathrooms 1  
 Half Bathrooms 0  
 Heating Type NONE with 0% NONE  
 Year Built 1943  
 Year Remodeled  
 Effective Year Built 1997

Code	Description	Sketch Area	Finished Area	Perimeter
FLA	FLOOR LIV AREA	312	312	0
OPF	OP PRCH FIN LL	104	0	0
SPF	SC PRCH FIN LL	72	0	0
SBF	UTIL FIN BLK	130	0	0
<b>TOTAL</b>		<b>618</b>	<b>312</b>	<b>0</b>

Style S.F.R. - R1 / R1  
 Gross Sq Ft 464  
 Finished Sq Ft 384  
 Perimiter 0  
 Stories 1  
 Interior Walls WALL BD/WD WAL  
 Exterior Walls ABOVE AVERAGE WOOD  
 Quality 500 ()  
 Roof Type GABLE/HIP  
 Roof Material METAL  
 Exterior Wall1 ABOVE AVERAGE WOOD  
 Exterior Wall2  
 Foundation CONC BLOCK  
 Interior Finish WALL BD/WD WAL  
 Ground Floor Area  
 Floor Cover CONC S/B GRND  
 Full Bathrooms 1  
 Half Bathrooms 0  
 Heating Type NONE with 0% NONE  
 Year Built 1943  
 Year Remodeled  
 Effective Year Built 1997

Code	Description	Sketch Area	Finished Area	Perimeter
FLA	FLOOR LIV AREA	384	384	0
SPF	SC PRCH FIN LL	80	0	0
<b>TOTAL</b>		<b>464</b>	<b>384</b>	<b>0</b>

Style S.F.R. - R1 / R1  
 Gross Sq Ft 384  
 Finished Sq Ft 312  
 Perimiter 0  
 Stories 1  
 Interior Walls WALL BD/WD WAL  
 Exterior Walls ABOVE AVERAGE WOOD  
 Quality 500 ()  
 Roof Type GABLE/HIP  
 Roof Material METAL  
 Exterior Wall1 ABOVE AVERAGE WOOD  
 Exterior Wall2  
 Foundation CONC BLOCK  
 Interior Finish WALL BD/WD WAL  
 Ground Floor Area  
 Floor Cover CONC S/B GRND  
 Full Bathrooms 1  
 Half Bathrooms 0  
 Heating Type NONE with 0% NONE  
 Year Built 1943  
 Year Remodeled  
 Effective Year Built 1997



Condition				
Code	Description	Sketch Area	Finished Area	Perimeter
FLA	FLOOR LIV AREA	312	312	0
OPF	OP PRCH FIN LL	72	0	0
<b>TOTAL</b>		<b>384</b>	<b>312</b>	<b>0</b>

Style S.F.R. - R1 / R1  
 Gross Sq Ft 354  
 Finished Sq Ft 300  
 Perimeter 0  
 Stories 1  
 Interior Walls WALL BD/WD WAL  
 Exterior Walls ABOVE AVERAGE WOOD  
 Quality 500 ()  
 Roof Type GABLE/HIP  
 Roof Material METAL  
 Exterior Wall1 ABOVE AVERAGE WOOD  
 Exterior Wall2  
 Foundation CONC BLOCK  
 Interior Finish WALL BD/WD WAL  
 Ground Floor Area  
 Floor Cover CONC S/B GRND  
 Full Bathrooms 1  
 Half Bathrooms 0  
 Heating Type NONE with 0% NONE  
 Year Built 1943  
 Year Remodeled  
 Effective Year Built 1997

Condition				
Code	Description	Sketch Area	Finished Area	Perimeter
FLA	FLOOR LIV AREA	300	300	0
SPF	SC PRCH FIN LL	54	0	0
<b>TOTAL</b>		<b>354</b>	<b>300</b>	<b>0</b>

Style S.F.R. - R1 / R1  
 Gross Sq Ft 592  
 Finished Sq Ft 520  
 Perimeter 0  
 Stories 1  
 Interior Walls WALL BD/WD WAL  
 Exterior Walls ABOVE AVERAGE WOOD  
 Quality 500 ()  
 Roof Type GABLE/HIP  
 Roof Material METAL  
 Exterior Wall1 ABOVE AVERAGE WOOD  
 Exterior Wall2  
 Foundation CONC BLOCK  
 Interior Finish WALL BD/WD WAL  
 Ground Floor Area  
 Floor Cover CONC S/B GRND  
 Full Bathrooms 1  
 Half Bathrooms 0  
 Heating Type NONE with 0% NONE  
 Year Built 1943  
 Year Remodeled  
 Effective Year Built 1997

Condition				
Code	Description	Sketch Area	Finished Area	Perimeter
FLA	FLOOR LIV AREA	520	520	0
SPF	SC PRCH FIN LL	72	0	0
<b>TOTAL</b>		<b>592</b>	<b>520</b>	<b>0</b>

Style S.F.R. - R1 / R1  
 Gross Sq Ft 372  
 Finished Sq Ft 312  
 Perimeter 0  
 Stories 1  
 Interior Walls WALL BD/WD WAL  
 Exterior Walls ABOVE AVERAGE WOOD  
 Quality 500 ()  
 Roof Type GABLE/HIP  
 Roof Material METAL  
 Exterior Wall1 ABOVE AVERAGE WOOD  
 Exterior Wall2  
 Foundation CONC BLOCK  
 Interior Finish WALL BD/WD WAL  
 Ground Floor Area

Floor Cover CONC S/B GRND  
 Full Bathrooms 1  
 Half Bathrooms 0  
 Heating Type NONE with 0% NONE  
 Year Built 1943  
 Year Remodeled  
 Effective Year Built 1997

Condition				
Code	Description	Sketch Area	Finished Area	Perimeter
FLA	FLOOR LIV AREA	312	312	0
SPF	SC PRCH FIN LL	60	0	0
<b>TOTAL</b>		<b>372</b>	<b>312</b>	<b>0</b>

Style S.F.R. - R1 / R1  
 Gross Sq Ft 798  
 Finished Sq Ft 600  
 Perimeter 0  
 Stories 1  
 Interior Walls WALL BD/WD WAL  
 Exterior Walls ABOVE AVERAGE WOOD  
 Quality 500 ()  
 Roof Type GABLE/HIP  
 Roof Material METAL  
 Exterior Wall1 ABOVE AVERAGE WOOD  
 Exterior Wall2  
 Foundation WD CONC PADS  
 Interior Finish WALL BD/WD WAL  
 Ground Floor Area  
 Floor Cover CONC S/B GRND  
 Full Bathrooms 1  
 Half Bathrooms 0  
 Heating Type NONE with 0% NONE  
 Year Built 1943  
 Year Remodeled  
 Effective Year Built 1997

Condition				
Code	Description	Sketch Area	Finished Area	Perimeter
FLA	FLOOR LIV AREA	600	600	0
OPF	OP PRCH FIN LL	30	0	0
SPF	SC PRCH FIN LL	168	0	0
<b>TOTAL</b>		<b>798</b>	<b>600</b>	<b>0</b>

Style M.F. - R2 / R2  
 Gross Sq Ft 1,848  
 Finished Sq Ft 854  
 Perimeter 0  
 Stories 1  
 Interior Walls WALL BD/WD WAL  
 Exterior Walls ABOVE AVERAGE WOOD  
 Quality 500 ()  
 Roof Type GABLE/HIP  
 Roof Material METAL  
 Exterior Wall1 ABOVE AVERAGE WOOD  
 Exterior Wall2  
 Foundation CONC BLOCK  
 Interior Finish WALL BD/WD WAL  
 Ground Floor Area  
 Floor Cover CONC S/B GRND  
 Full Bathrooms 2  
 Half Bathrooms 0  
 Heating Type NONE with 0% NONE  
 Year Built 1992  
 Year Remodeled  
 Effective Year Built 2003

Condition				
Code	Description	Sketch Area	Finished Area	Perimeter
EFD	ELEVATED FOUND	924	0	0
FLA	FLOOR LIV AREA	854	854	0
OPF	OP PRCH FIN LL	70	0	0
<b>TOTAL</b>		<b>1,848</b>	<b>854</b>	<b>0</b>

Style M.F. - R3 / R3  
 Gross Sq Ft 3,444  
 Finished Sq Ft 1,554  
 Perimeter 0  
 Stories 1

**Interior Walls**  
**Exterior Walls** HARDIE BD  
**Quality** 500 ()  
**Roof Type**  
**Roof Material** METAL  
**Exterior Wall1** HARDIE BD  
**Exterior Wall2**  
**Foundation**  
**Interior Finish**  
**Ground Floor Area**  
**Floor Cover**  
**Full Bathrooms** 3  
**Half Bathrooms** 0  
**Heating Type** FCD/AIR DUCTED  
**Year Built** 2006  
**Year Remodeled**  
**Effective Year Built** 2006  
**Condition**

Code	Description	Sketch Area	Finished Area	Perimeter
EFD	ELEVATED FOUND	1,722	0	0
OPX	EXC OPEN PORCH	168	0	0
FLA	FLOOR LIV AREA	1,554	1,554	0
<b>TOTAL</b>		<b>3,444</b>	<b>1,554</b>	<b>0</b>

**Yard Items**

Description	Year Built	Roll Year	Quantity	Units	Grade
PATIO	1949	1950	1	804 SF	1
WALL AIR COND	1982	1983	1	5 UT	1
RES POOL	1984	1985	1	450 SF	3
WOOD DECK	1984	1985	1	687 SF	2
FENCES	1985	1986	1	462 SF	2
FENCES	1991	1992	1	300 SF	2
WALL AIR COND	1994	1995	1	6 UT	2
UTILITY BLDG	2006	2007	1	140 SF	3
FENCES	2012	2013	1	92 SF	5

**Sales**

Sale Date	Sale Price	Instrument	Instrument Number	Deed Book	Deed Page	Sale Qualification	Vacant or Improved
7/1/1990	\$795,000	Warranty Deed		1138	1952	Q - Qualified	Improved

**Permits**

Number	Date Issued	Date Completed	Amount	Permit Type	Notes
13-4233	10/3/2013		\$2,786	Residential	CHANGE OUT 1 AND 1/2 TON AC SYSTEM USING EXISTING ELECTRICAL, STAND AND DUCTING
12-1679	5/10/2012	5/10/2012	\$3,000	Commercial	INSTALL APPROX 92 LF OF VINYL FENCE W/ 6 X 6 POST IN BETWEEN
08-3765	10/13/2008	12/15/2008	\$3,500	Residential	CONSTRUCT 24' X 18' CONCRETE PARKING PAD
08-3766	10/13/2008	12/15/2008	\$1,200	Residential	BUILD 3' X 8' CLOSET IN BEDROOM
08-3556	9/24/2008	12/15/2008	\$4,500	Residential	CHANGE OUT TWO 1.5 TON A/C UNITS
08-3003	8/16/2008	12/15/2008	\$1,500	Residential	REPLACE CONDENSOR
08-3004	8/16/2008	12/15/2008	\$900	Residential	REMOVE AND RE-INSTALL CONDENSOR
08-3005	8/16/2008	12/15/2008	\$400	Residential	REMOVE AND RE-INSTALL CONDENSOR
08-3006	8/16/2008	12/15/2008	\$900	Residential	REPLACE CONDENSOR
08-3007	8/16/2008	12/15/2008	\$900	Residential	REMOVE AND RE-INSTALL CONDENSOR
08-3009	8/16/2008	12/15/2008	\$1,500	Residential	REPLACE CONDENSOR
08-2675	7/24/2008	12/15/2008	\$500	Residential	RAISE WATER AND SEWER LINES TO ACCOMODATE RAISING OF STRUCTURE
08-2676	7/24/2008	12/15/2008	\$500	Residential	RAISE WATER AND SEWER LINES TO ACCOMODATE RAISING OF STRUCTURE
08-2677	7/24/2008	12/15/2008	\$500	Residential	RAISE WATER AND SEWER LINES TO ACCOMODATE RAISING OF STRUCTURE
08-2678	7/24/2008	12/15/2008	\$500	Residential	RAISE WATER AND SEWER LINES TO ACCOMODATE RAISING OF STRUCTURE
08-2679	7/24/2008	12/15/2008	\$500	Residential	RAISE WATER AND SEWER LINES TO ACCOMODATE RAISING OF STRUCTURE
08-6727	7/9/2008	7/9/2008	\$0	Residential	ISSUED C/O
08-0058	1/23/2008	4/10/2008	\$45,000	Residential	RAISE STRUCTURE TO FEMA ELEVATION, 550SF REMOVE CONCH SHINGLES AND REPLACE WITH V-CRIMP, REPLACE APPROX. 100 SF ROTTEN ROOF SHEATHING
08-0059	1/23/2008	4/10/2008	\$45,000	Residential	RAISE STRUCTURE TO FEMA ELEVATION, 550SF REMOVE CONCH SHINGLES & REPLACE WITH V-CRIMP, REPLACE APPROX. 100 SF ROTTEN ROOF SHEATHING
08-0060	1/23/2008	4/10/2008	\$45,000	Residential	RAISE STRUCTURE TO FEMA ELEVATION, 550SF REMOVE CONCH SHINGLES & REPLACE WITH V-CRIMP, REPLACE APPROX. 100 SF ROTTEN ROOF SHEATHING
08-0139	1/23/2008	4/10/2008	\$45,000	Residential	, 550SF REMOVE CONCH SHINGLES & REPLACE WITH V-CRIMP, RAISE STRUCTURE TO FEMA ELEVATION, REPLACE APPROX. 100 SF ROTTEN ROOF SHEATHING
08-0140	1/23/2008	4/10/2008	\$45,000	Residential	, 550SF REMOVE CONCH SHINGLES & REPLACE WITH V-CRIMP, RAISE STRUCTURE TO FEMA ELEVATION, REPLACE APPROX. 100 SF ROTTEN ROOF SHEATHING

Number	Date Issued	Date Completed	Amount	Permit Type	Notes
08-0141	1/23/2008	4/10/2008	\$45,000	Residential	RAISE STRUCTURE TO FEMA ELEVATION, 1100 SF REMOVE & REPLACE V-CRIMP & MODIFIED RUBBER, REPLACE APPROX 100 SF ROTTEN ROOF SHEATHING
07-2511	5/22/2007	6/17/2007	\$150	Residential	ADD 3 MORE OPENINGS IN PERMIT #07-1856
07-2419	5/17/2007	6/17/2007	\$3,978	Residential	INSTALL 600 SF OF V-CRIMP ROOFING TO 1907 VENETIA ST
07-1852	4/16/2007	12/15/2007	\$6,250	Residential	REMOVE EXISTING FIXTURES & RE-PLUMB WATER SERVICE AND CONNECTIONS.
07-1855	4/16/2007	12/15/2007	\$4,200	Residential	REWIRE EXISTING 400 SF COTTAGE
07-1856	4/16/2007	12/15/2008	\$3,500	Residential	REMOVE WALL A/C AND ADD CENTRAL SYSTEM
07-168	4/12/2007	8/16/2007	\$48,000	Residential	RENOVATE EXISTING 400SF COTTAGE AND ENCLOSE EXISTING PORCH ADD CENTAL A/C
07-1687	4/12/2007	12/15/2007	\$48,000	Residential	RENOVATE 400 SF COTTAGE ENCLOSE 60 SF PORCH AND ADD 65 SF PORCH. REPLACE WALL A/C WITH CENTRAL SYSTEM
07-4217	4/10/2007		\$0	Residential	ISSUED C/O
06-6829	1/2/2007	6/17/2007	\$700	Residential	DISCONNECT PLUMBING TO RAISE THE HOME AND RECONNECT SEWER AND WATER SUPPLY
06-6830	1/2/2007	5/1/2007	\$700	Residential	DISCONNECT PLUMBING TO RAISE STRUCTURE AND RE-PLUMB TO MEET ELEVATION.
06-6306	12/28/2006	5/1/2007	\$20,000	Residential	RAISE BUILDING TO MEET 8' ELEVATION. ROTATE STRUCTURE 90 DEGREES. RECONNECT UTILITIES AND ADD STAIRS.
06-6531	12/28/2006	4/10/2007	\$20,000	Residential	RAISE EXISTING SFR TO FEMA FLOOD ELEV,8.0 NGVD
06-6823	12/28/2006	2/21/2007	\$500	Residential	RELOCATE EXISTING 100AMP SERVICE
06-6824	12/28/2006	2/21/2007	\$500	Residential	RELOCATE EXISTING 100 AMP SERVICE FOR 1907 VENETIA ST
06-4401	7/21/2006	7/7/2006	\$1,500	Residential	SEWER CONNECT
06-4402	7/21/2006	11/1/2006	\$1,500	Residential	HOOK UP SEWER LINE + WATER METER CAN
06-4201	7/11/2006	11/1/2006	\$2,300	Residential	1.5 TON A/C 5 DROPS
06-4210	7/11/2006	11/1/2006	\$2,300	Residential	INSTALL 1.5 TON A/C
97-0304	7/11/2006	11/1/2006	\$2,300	Residential	A/C INSTALL 5 DROPS
06-3184	5/25/2006	7/7/2006	\$1,700	Residential	INSTALL 200 AMP SVC
06-3185	5/25/2006	7/7/2006	\$1,700	Residential	INSTALL 200 AMP SVC CENTRAL A/C
06-3186	5/25/2006	7/7/2006	\$1,700	Residential	200 AMP SVC
06-2898	5/15/2006	7/7/2006	\$2,300	Residential	HOOK UP SEWER + WATER LINE
05-4332	12/6/2005	7/7/2006	\$10,000	Residential	INSTALL FOUNDATION & STEPS FOR MODULAR HOME 1521 BETHA ST
05-4334	12/6/2005	12/1/1997	\$10,000	Residential	INSTALL FOUNDATION STEPS FOR MODULAR HOUSERENOVATIONS
05-4335	12/6/2005	7/7/2006	\$10,000	Residential	INSTALL FOUNDATION & STEPS FOR MODULA HOUSR FOR 1525 BERTHA ST
05-4335	12/6/2005	7/7/2006	\$10,000	Residential	INSTALL FOUNDATION + STEPS
06-4334	12/6/2005	7/7/2006	\$10,000	Residential	INSTALL FOUNDATION + MODULAR STEPS
05-2252	6/8/2005	7/7/2006	\$750	Residential	RELOCATE ELECTRIC FOR 1907 VENETIA ST.
05-2253	6/8/2005	7/7/2006	\$750	Residential	RELOCATE ELECTRIC FOR 1911 VENETIA ST.
05-2254	6/8/2005	7/7/2006	\$750	Residential	RELOCATE ELECTRIC FOR 1913 VENETIA ST.
05-1161	4/12/2005	7/7/2006	\$7,000	Residential	install a 10'X14' teds shed
04-1127	4/8/2004	11/17/2004	\$8,368	Residential	INSTALL SHUTTERS FOR 1516
04-1128	4/8/2004	11/17/2004	\$9,432	Residential	SHUTTERS FOR 1512 DENNIS
04-1129	4/8/2004	11/17/2004	\$3,974	Residential	INSTALL SHUTTERS FOR 1911
04-1130	4/8/2004	11/17/2004	\$5,422	Residential	INSTALL SHUTTERS FOR 1913
04-1131	4/8/2004	11/17/2004	\$5,422	Residential	INSTALL SHUTTERS FOR 1909
04-1132	4/8/2004	11/17/2004	\$5,422	Residential	INSTALL SHUTTERS FOR 1901
04-1133	4/8/2004	11/17/2004	\$5,010	Residential	INSTALL SHUTTERS FOR 1903
04-1134	4/8/2004	11/17/2004	\$7,160	Residential	INSTALL SHUTTERS FOR 1907
04-1137	4/8/2004	11/17/2004	\$5,422		INSTALL SHUTTERS
03-2857	10/18/2003	11/17/2004	\$3,250	Residential	NEW 2-TON FOR 1903
03-3001	8/26/2003	11/17/2004	\$400	Residential	ELE FOR A/C 1909
03-3002	8/26/2003	11/17/2003	\$400	Residential	ELE. FOR A/C 1905
03-3003	8/26/2003	11/17/2004	\$400	Residential	ELE.FOR A/C.1903
03-3004	8/25/2003	11/17/2004	\$400	Residential	ELECTRICAL HEAT
03-2856	8/18/2003	11/17/2004	\$3,650	Residential	NEW A/C UNIT 1901
03-2858	8/18/2003	11/17/2004	\$3,250	Residential	NEW 2-TON FOR 1905
03-2859	8/18/2003	11/17/2004	\$3,250	Residential	NEW 2-TON FOR 1909
03-2860	8/18/2003	11/17/2004	\$3,650	Residential	NEW 2-TON FOR 1913
03-2630	7/28/2003	11/17/2004	\$950	Residential	REPLACE SEWER LINE
02-1969	8/14/2002	10/9/2002	\$2,000	Residential	2-SMOKE DEDECTORS
02-2151	8/12/2002	10/9/2002	\$8,000	Residential	PLUMBING
02-1548	6/14/2002	10/9/2002	\$5,000	Residential	INTERIOR WOOD WORK
01-2728	8/17/2001	11/6/2001	\$8,000	Residential	RENOVATIONS
01-2660	7/27/2001	11/6/2001	\$18,000	Residential	RENOVATIONS
01-2132	5/31/2001	11/6/2001	\$5,000	Residential	16 SQS BUILTUP
01-1040	3/12/2001	11/6/2001	\$12,000	Residential	RENOVATIONS
00-4547	1/8/2001	11/6/2001	\$20,000	Residential	RENOVATIONS
01-0105	1/8/2001	11/6/2001	\$20,000	Residential	RENOVATIONS
01-0106	1/8/2001	11/6/2001	\$20,000	Residential	RENOVATIONS

Number	Date Issued	Date Completed	Amount	Permit Type	Notes
01-0108	1/8/2001	11/6/2001	\$20,000	Residential	RENOVATIONS
98-3355	10/27/1998	12/31/1998	\$500	Residential	STORM DAMAGE LIGHTING
98-3017	10/2/1998	12/31/1998	\$1,000	Residential	STORM DAMAGE
98-2803	9/10/1998	12/31/1998	\$250	Residential	REPLACE REMEX WIRING
97-0304	2/1/1997	12/1/1997	\$1,200	Residential	ELECTRICAL
A951271	4/1/1995	11/1/1995	\$3,297		8 SQ V-CRIMP & 3 SQ S.RFG

Sketches (click to enlarge)

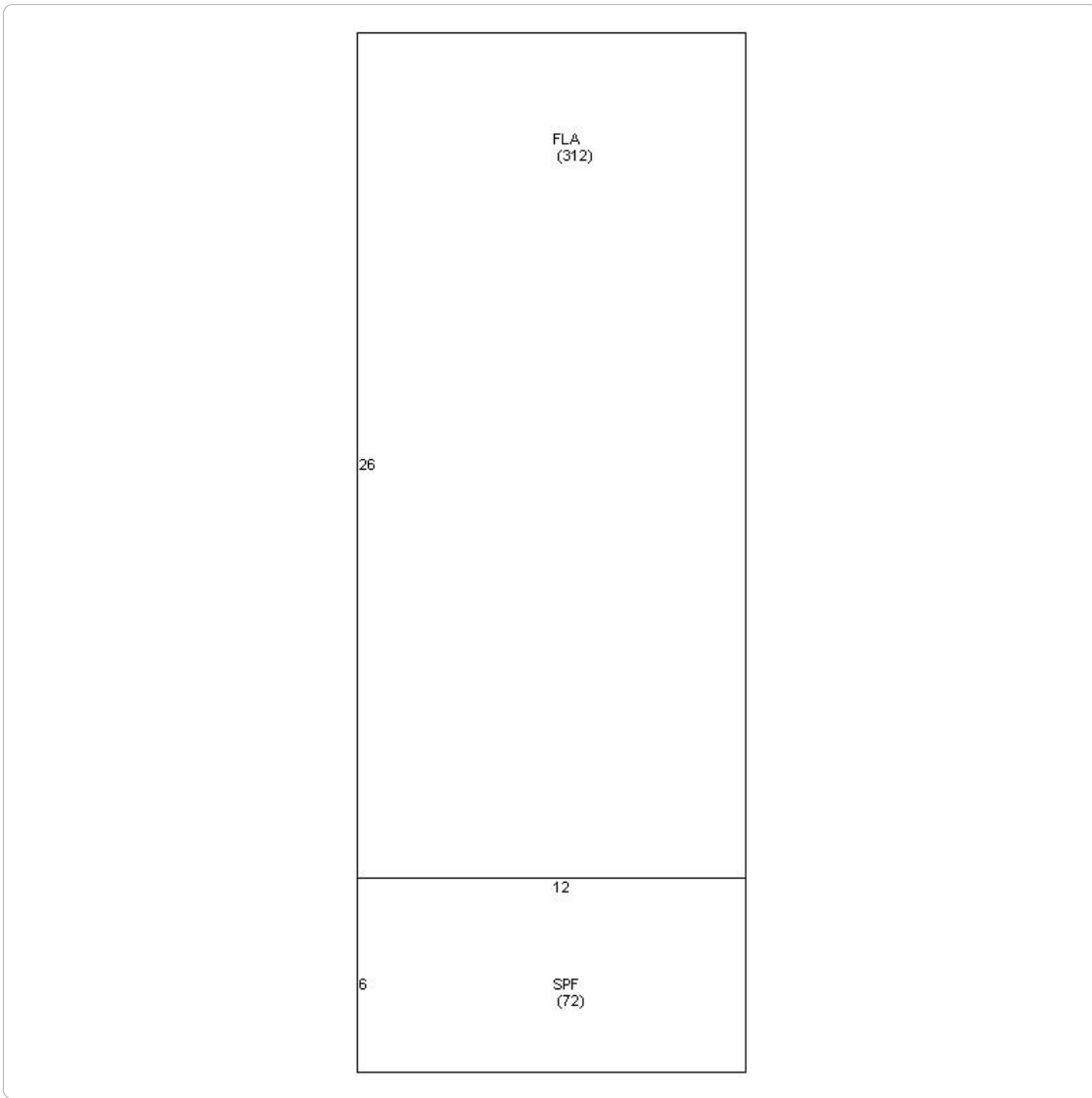



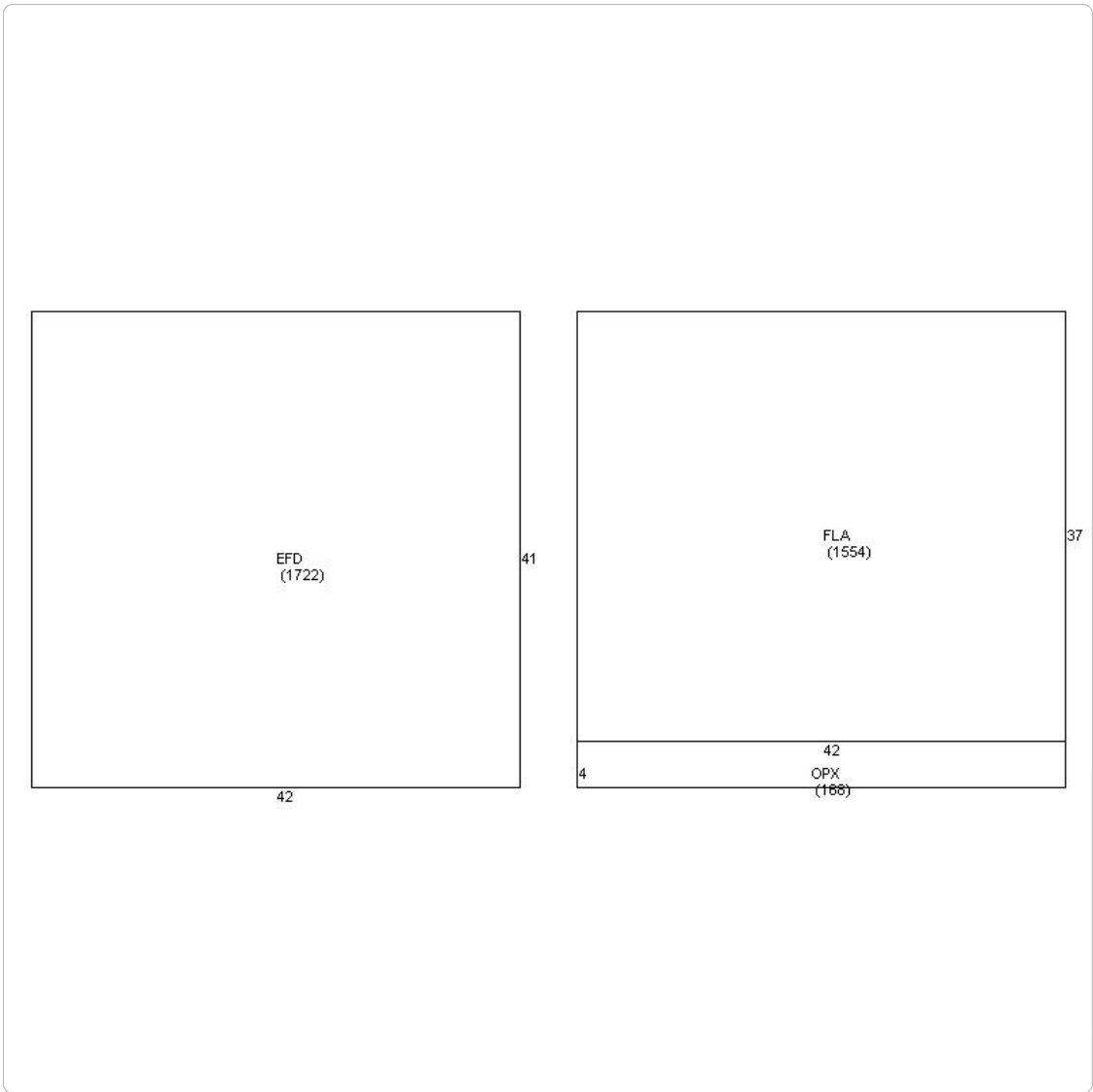

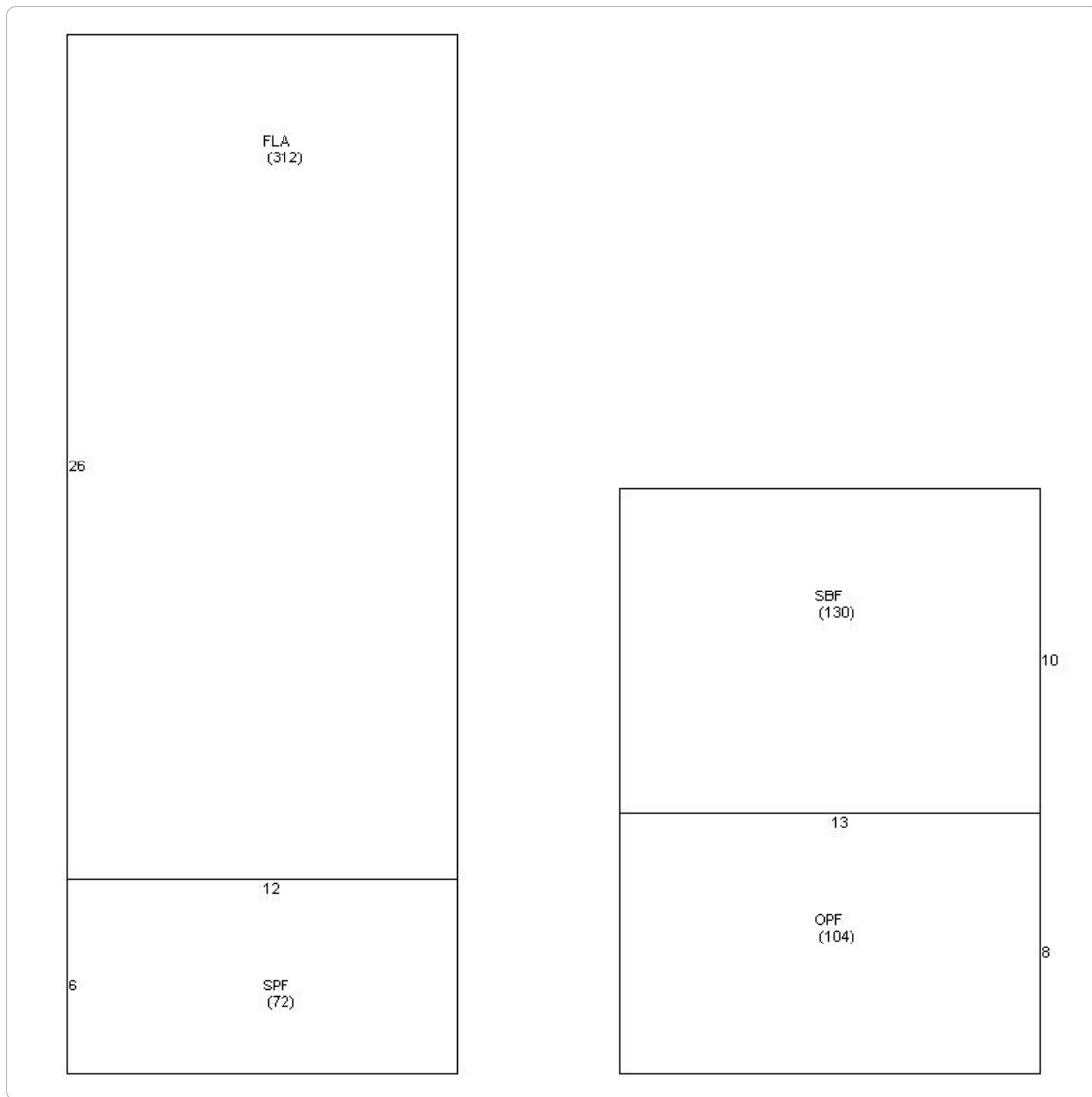

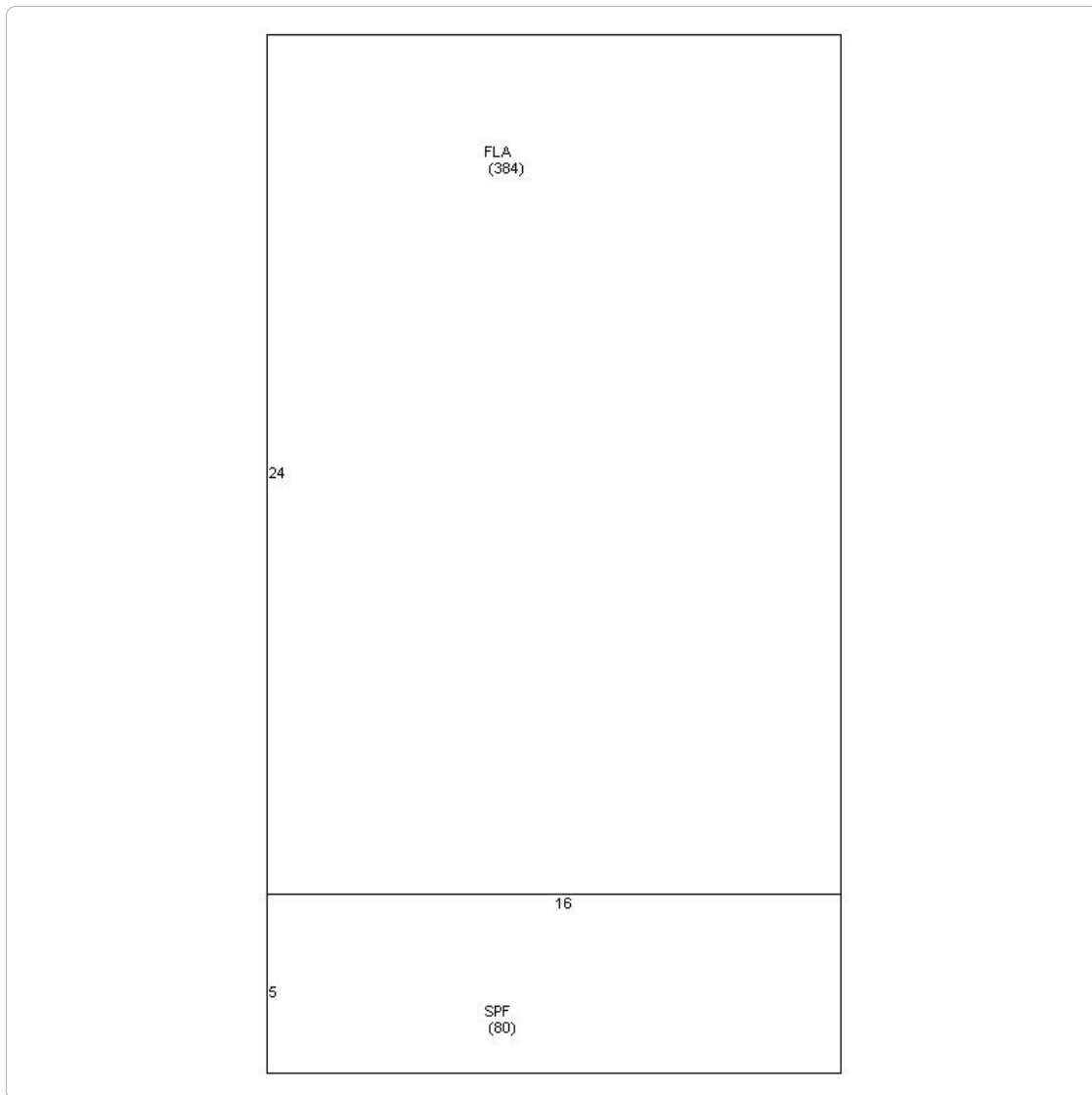

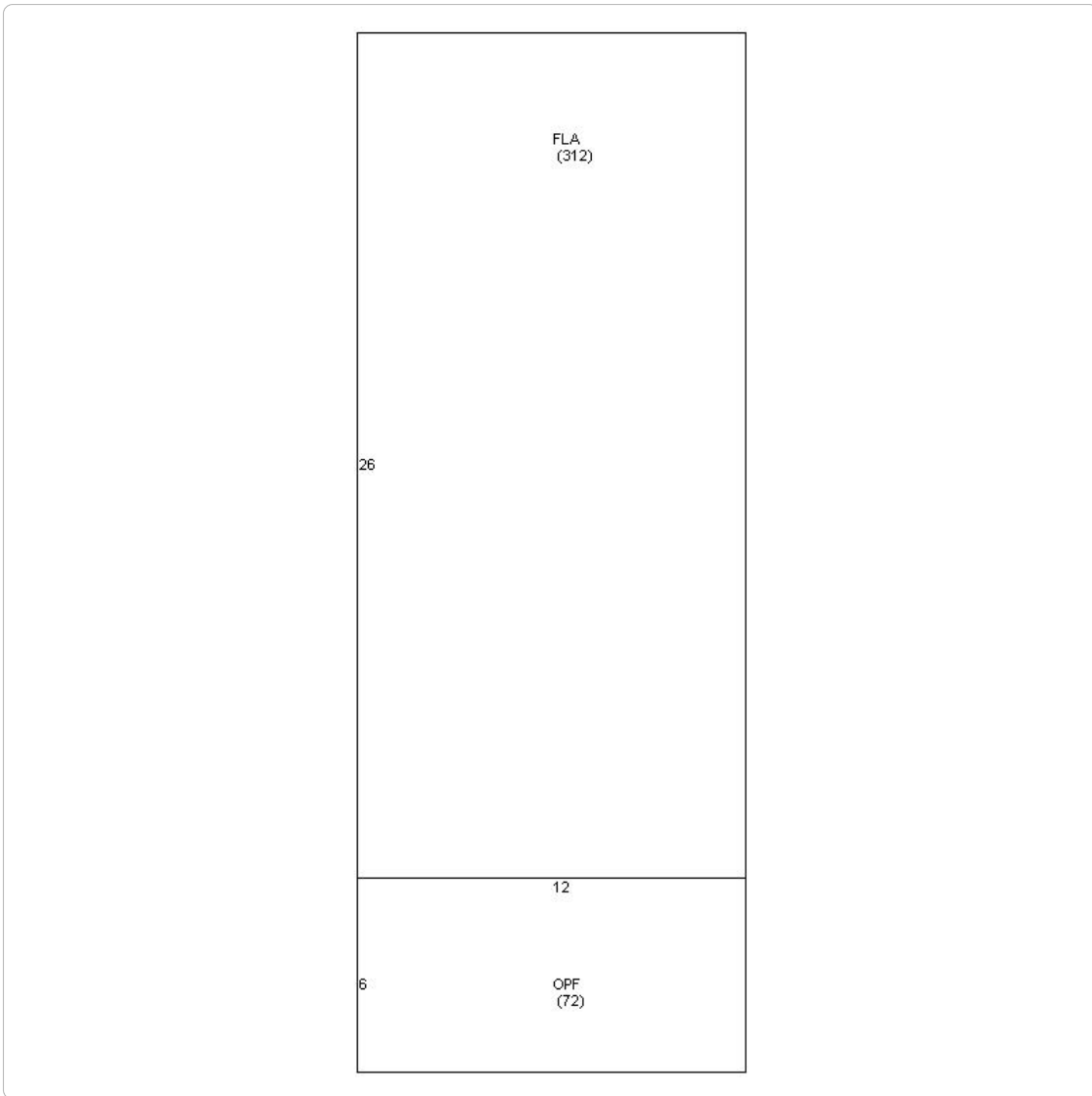

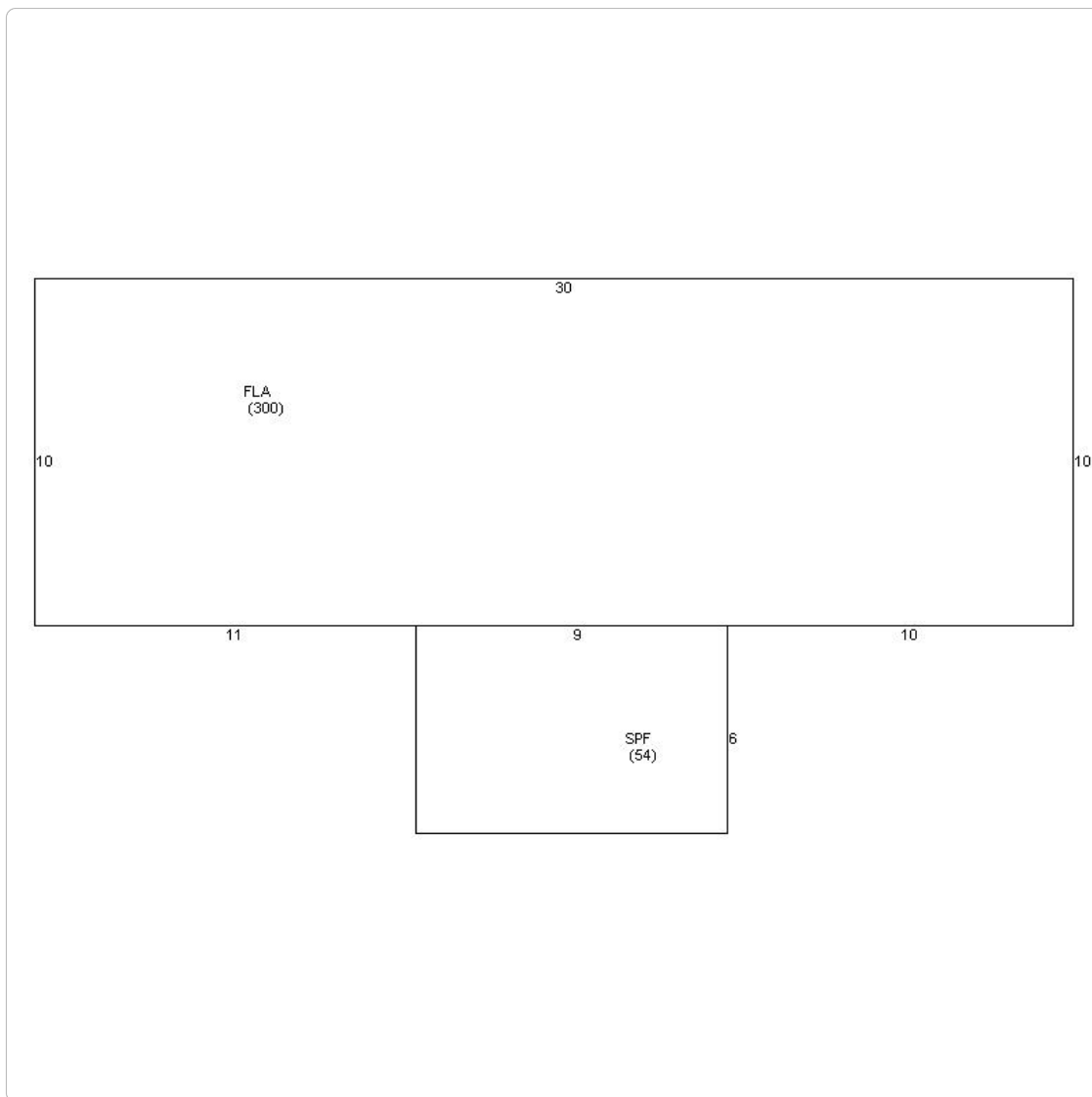

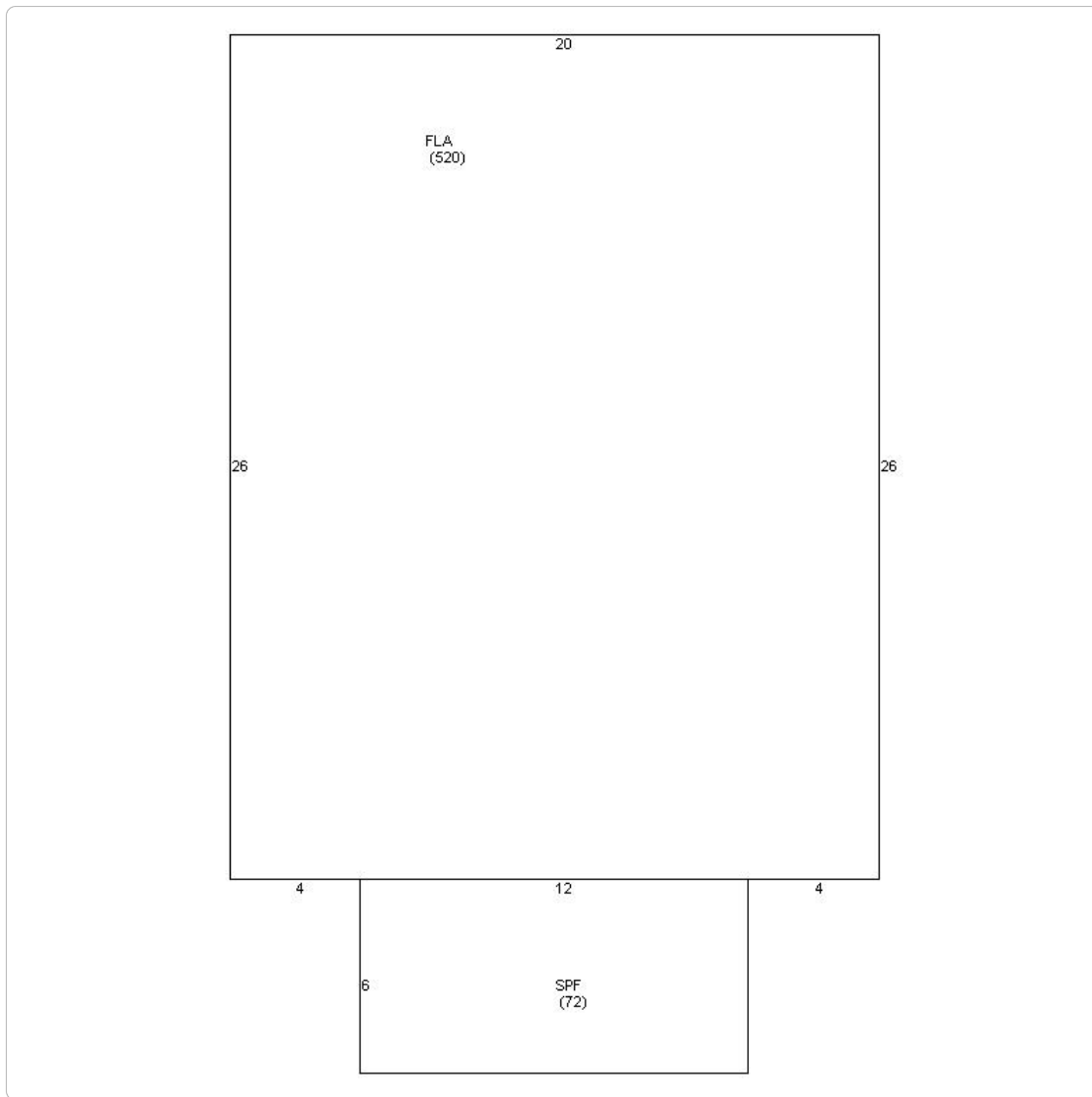

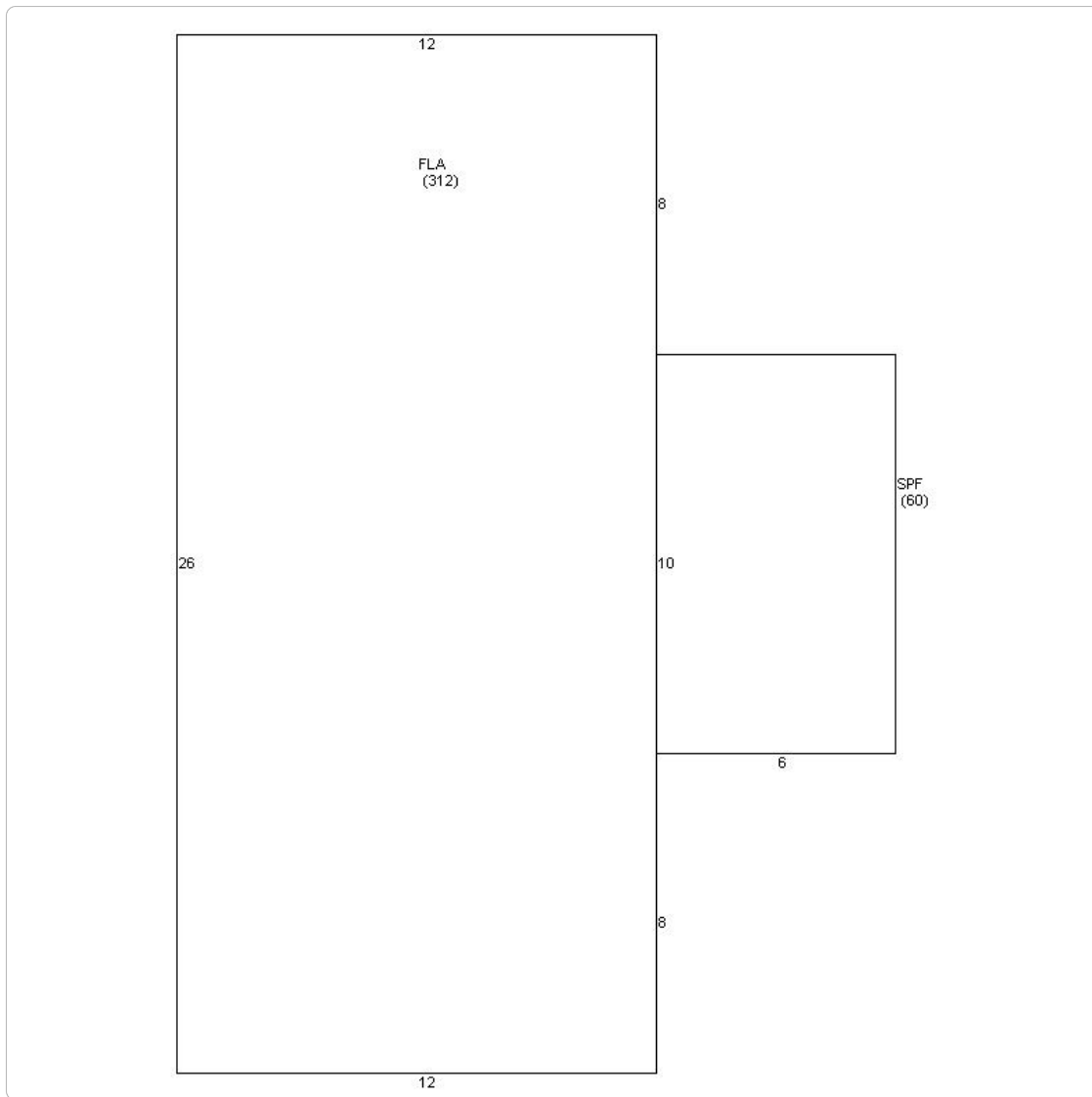

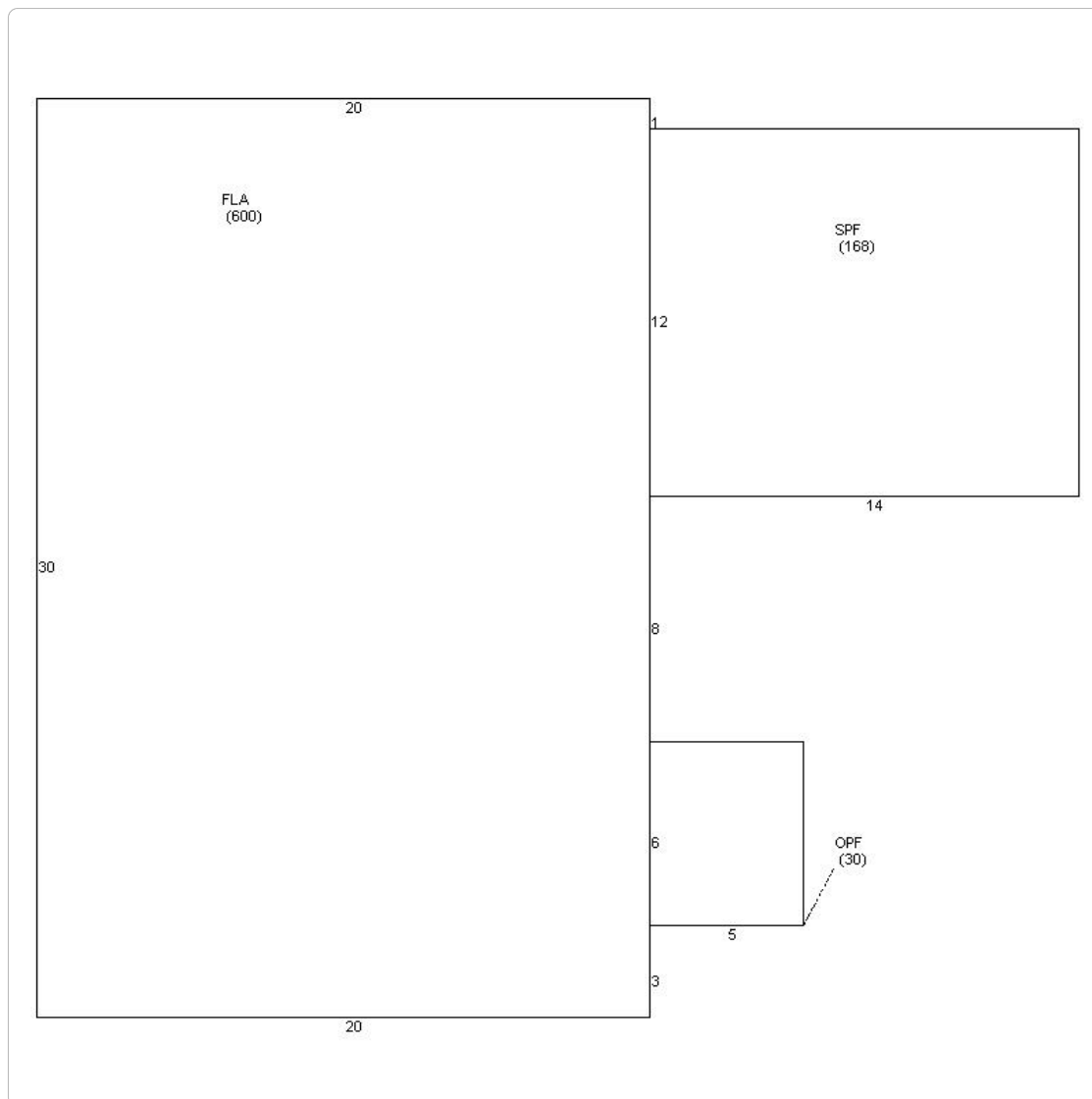



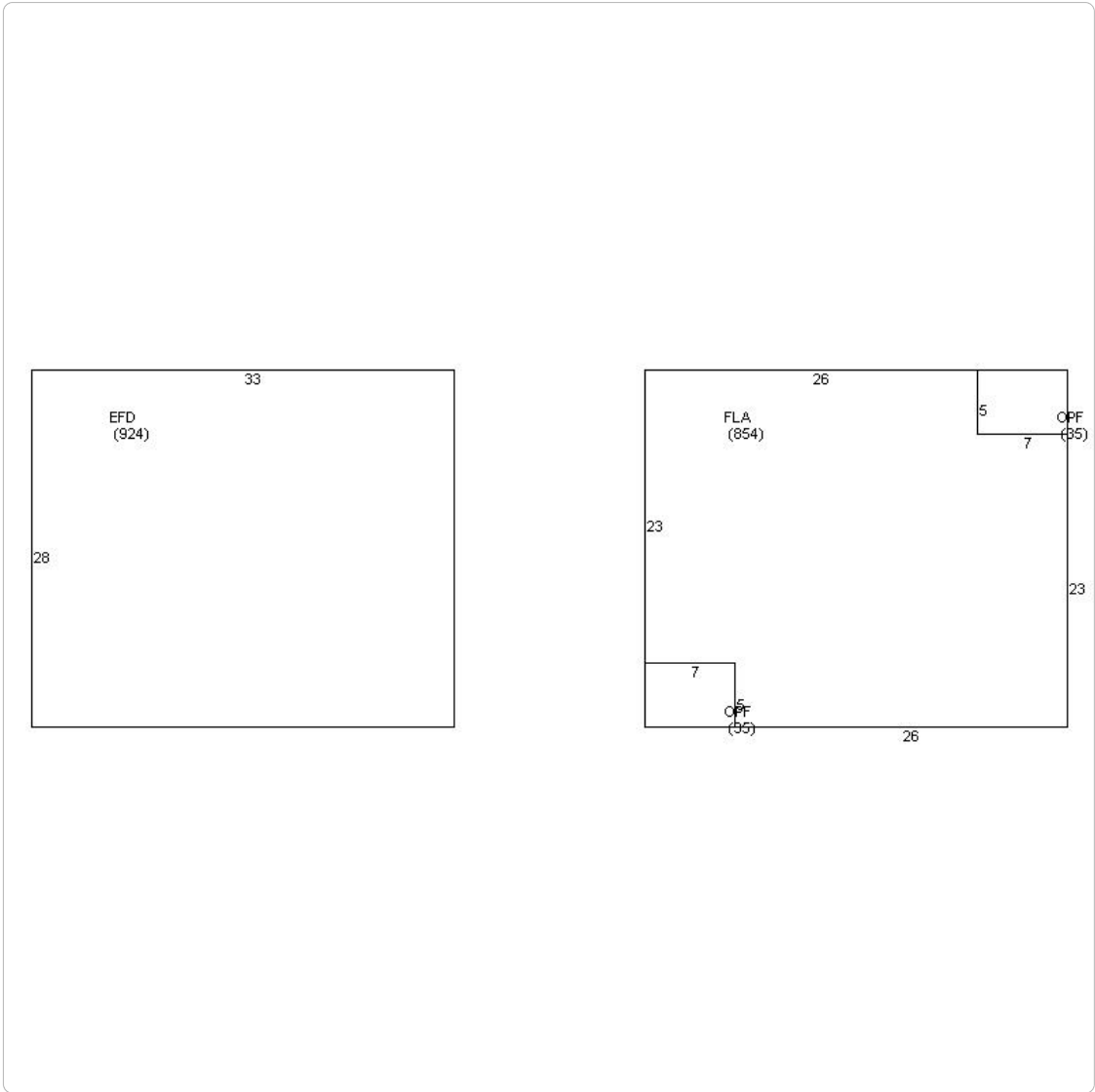

Photos



AK1063835 1512 Dennis Street, 1521-1525 Bertha Street 8/3/2011



Map



No data available for the following modules: Buildings, Mobile Home Buildings, Exemptions.

The Monroe County Property Appraiser's office maintains data on property within the County solely for the purpose of fulfilling its responsibility to secure a just valuation for ad valorem tax purposes of all property within the County. The Monroe County Property Appraiser's office cannot guarantee its accuracy for any other purpose. Likewise, data provided regarding one tax year may not be applicable in prior or subsequent years. By requesting such data, you hereby understand and agree that the

Last Data Upload: 5/9/2018, 1:46:24 AM



Developed by  
The Schneider  
Corporation

**Summary**

Parcel ID 00063400-000100  
 Account # 8850701  
 Property ID 8850701  
 Millage Group 10KW  
 Location Address 1515 BERTHA St, KEY WEST  
 Legal Description KW W D CASH DIAGRAM PB1-13 LOT 1 AND PT LOTS 2 AND 12 SQR 6 TR 30 OR1322-1342/44  
 (Note: Not to be used on legal documents)  
 Neighborhood 31050  
 Property Class HOMES FOR THE AGED (7400)  
 Subdivision  
 Sec/Twp/Rng 05/68/25  
 Affordable No  
 Housing



**Owner**

A H I REAL ESTATE PROPERTIES INC  
 PO BOX 4374  
 KEY WEST FL 33041

**Valuation**

	2017	2016	2015	2014
+ Market Improvement Value	\$192,419	\$168,605	\$177,656	\$189,407
+ Market Misc Value	\$3,789	\$3,928	\$3,480	\$3,218
+ Market Land Value	\$120,041	\$119,484	\$119,484	\$113,795
= Just Market Value	\$316,249	\$292,017	\$300,620	\$306,420
= Total Assessed Value	\$316,249	\$292,017	\$300,620	\$306,420
- School Exempt Value	(\$316,249)	(\$292,017)	(\$300,620)	(\$306,420)
= School Taxable Value	\$0	\$0	\$0	\$0

**Land**

Land Use	Number of Units	Unit Type	Frontage	Depth
COMMERCIAL DRY (100D)	6,971.00	Square Foot	114	61

**Commercial Buildings**

Style M.F. - R3 / R3  
 Gross Sq Ft 3,612  
 Finished Sq Ft 1,428  
 Perimeter 0  
 Stories 1  
 Interior Walls WALL BD/WD WAL  
 Exterior Walls HARDIE BD  
 Quality 500 ()  
 Roof Type IRR/CUSTOM  
 Roof Material METAL  
 Exterior Wall1 HARDIE BD  
 Exterior Wall2  
 Foundation CONC BLOCK  
 Interior Finish WALL BD/WD WAL  
 Ground Floor Area  
 Floor Cover CONC S/B GRND  
 Full Bathrooms 3  
 Half Bathrooms 0  
 Heating Type FCD/AIR DUCTED with 0% NONE  
 Year Built 1994  
 Year Remodeled  
 Effective Year Built 1997  
 Condition

Code	Description	Sketch Area	Finished Area	Perimeter
EFD	ELEVATED FOUND	1,764	0	0
OPX	EXC OPEN PORCH	168	0	0
FLA	FLOOR LIV AREA	1,428	1,428	0
OPU	OP PR UNFIN LL	252	0	0
<b>TOTAL</b>		<b>3,612</b>	<b>1,428</b>	<b>0</b>

**Yard Items**

Description	Year Built	Roll Year	Quantity	Units	Grade
FENCES	1989	1990	1	396 SF	2
PATIO	1993	1994	1	345 SF	2
FENCES	1994	2007	1	720 SF	2

**Permits**

Number	Date Issued	Date Completed	Amount	Permit Type	Notes
11-3029	8/23/2011	8/10/2012	\$3,800	Commercial	AREA OF 4 X 50 APPLY PRIMER COAT TO WALL SURFACE, INSTALL HYDRO-STOP WATER PROOFING SYSTEM, APPLY 2 COATS OF HYDRO FINISH COAT AND CLEAN JOB SITE
06-4760	9/15/2006	11/1/2006	\$1,500	Commercial	INSTALL WATER TO THREE WASHING MACHINES AND SINK
06-4761	9/15/2006	11/1/2006	\$1,500	Commercial	INSTALL BREAKER BOX FOR THREE DRYERS
06-2779	5/3/2006	7/6/2006	\$4,500	Commercial	INSTALL THREE 1.5TON AC W/15 DROPS
06-2784	5/3/2006	7/6/2006	\$7,000	Commercial	20 SQRS VCRIMP
06-0094	1/19/2006	7/6/2006	\$2,300	Commercial	HURICANE REPAIRS REPLACE 120'x6' FENCING & ONE GATE
04-1117	4/8/2004	6/22/2004	\$5,734	Commercial	STORM SHUTTERS
98-3018	10/1/1998	8/9/1999	\$500	Commercial	ELECTRICAL
M943972	12/1/1994	12/1/1994	\$6,000	Commercial	1.5 TON AC
P944042	12/1/1994	12/1/1994	\$9,500	Commercial	PLUMBING
B943088	9/1/1994	12/1/1994	\$170,000	Commercial	NEW 3 UNIT STRUCTURE

Sketches (click to enlarge)





## Detail by Entity Name

Florida Not For Profit Corporation  
A.H.I. REAL ESTATE PROPERTIES, INC.

### Filing Information

<b>Document Number</b>	N49935
<b>FEI/EIN Number</b>	65-0363080
<b>Date Filed</b>	07/17/1992
<b>State</b>	FL
<b>Status</b>	ACTIVE
<b>Last Event</b>	AMENDMENT
<b>Event Date Filed</b>	09/19/1994
<b>Event Effective Date</b>	NONE

### Principal Address

1434 KENNEDY DRIVE  
KEY WEST, FL 33040-7008

Changed: 08/08/2012

### Mailing Address

1434 KENNEDY DRIVE  
KEY WEST, FL 33040-7008

Changed: 08/08/2012

### Registered Agent Name & Address

PRIDGEN, EUGENE S  
1434 KENNEDY DRIVE  
KEY WEST, FL 33040-7008

Name Changed: 10/26/2012

Address Changed: 08/08/2012

### Officer/Director Detail

#### **Name & Address**

Title Treasurer

Varner, Marcus  
1434 KENNEDY DRIVE  
KEY WEST, FL 33040-7008

Title CEO

PRIDGEN, EUGENE S  
1434 KENNEDY DRIVE  
KEY WEST, FL 33040-7008

Title president

Elwell, Christopher  
.....

## Detail by Entity Name

Florida Not For Profit Corporation  
A.H. OF MONROE COUNTY, INC.

### Filing Information

<b>Document Number</b>	N13659
<b>FEI/EIN Number</b>	59-2678740
<b>Date Filed</b>	03/03/1986
<b>State</b>	FL
<b>Status</b>	ACTIVE
<b>Last Event</b>	NAME CHANGE AMENDMENT
<b>Event Date Filed</b>	01/05/2009
<b>Event Effective Date</b>	NONE

### Principal Address

1434 KENNEDY DRIVE  
KEY WEST, FL 33040

Changed: 06/12/2000

### Mailing Address

1434 KENNEDY DRIVE  
KEY WEST, FL 33040-7008

Changed: 02/11/2011

### Registered Agent Name & Address

PRIDGEN, EUGENE S  
1434 KENNEDY DRIVE  
KEY WEST, FL 33040-7008

Name Changed: 10/26/2012

Address Changed: 08/08/2012

### Officer/Director Detail

#### **Name & Address**

Title VP

McChesney, Lori  
1434 KENNEDY DRIVE  
KEY WEST, FL 33040-7008

Title President

Elwell, Christopher  
1434 KENNEDY DRIVE  
KEY WEST, FL 33040-7008

Title Treasurer

Varner, Marcus  
.....



THU 10 MAY 2016 09:43:49M ESTD VOLUMES\MHK DRIVE\DRP\BOX (MHK MAP)\18078\_1515\_BERTHA\_STREET\_MARTYS\_PLACE\_AH\_P\PROJENV\ARCHITECTURE

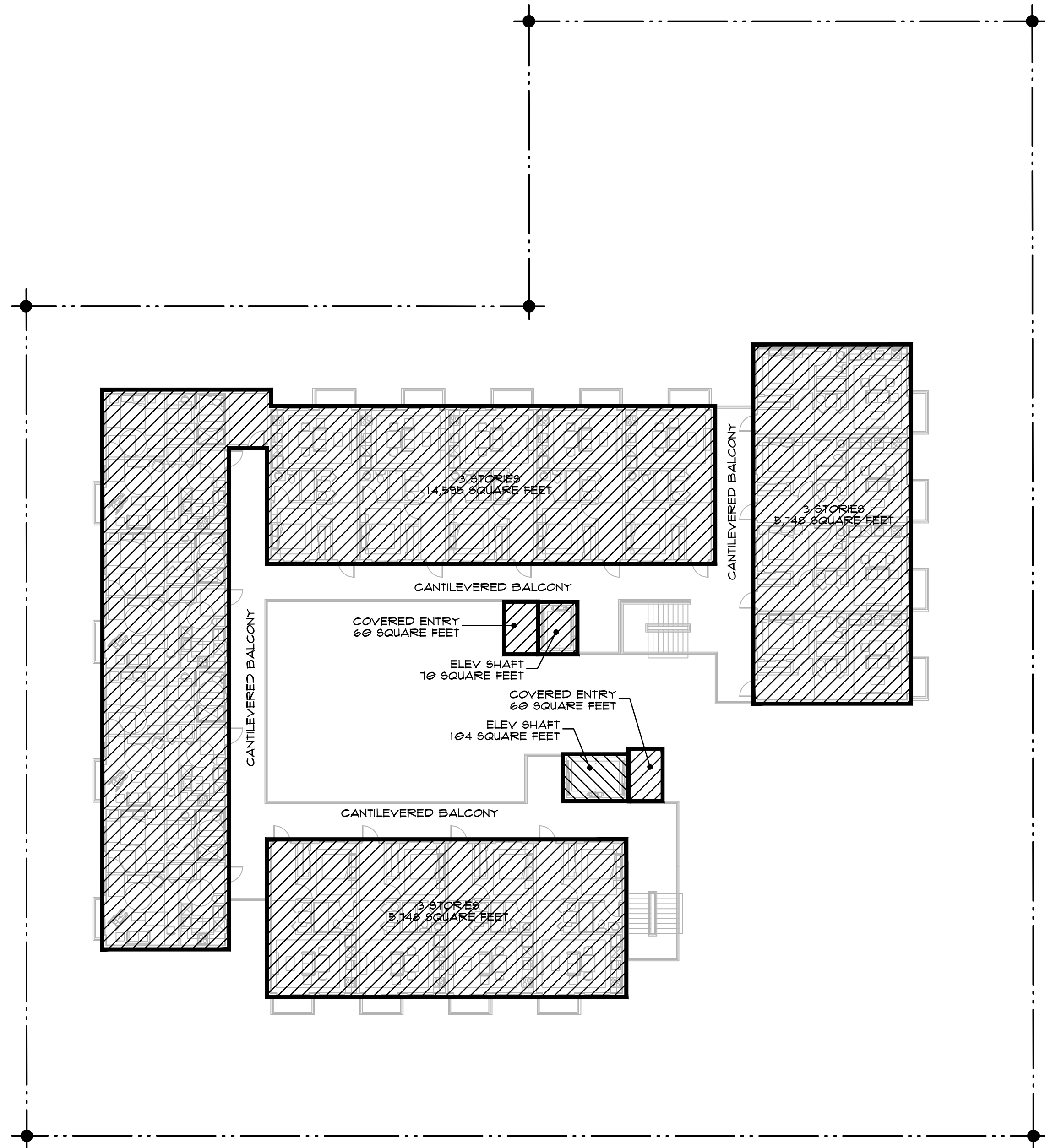

TOTAL SITE ..... 33,066 SQUARE FEET  
 MAXIMUM FAR ..... 0.8 = 26,452 SQUARE FEET  
 GROSS FLOOR AREA ..... 26,385 SQUARE FEET  
 FAR = (26,385) / 33,066 = 0.8  
 NOTE: THE EXTERIOR OPEN AIR BALCONIES FOR UNIT ACCESS AND UNIT BALCONIES ARE ALL NON-ROOFED AND CANTILEVERED. THEY ARE NOT A PART OF THE F.A.R.

**FLOOR AREA RATIO DIAGRAM**  
 SCALE: 1/16" = 1'-0"

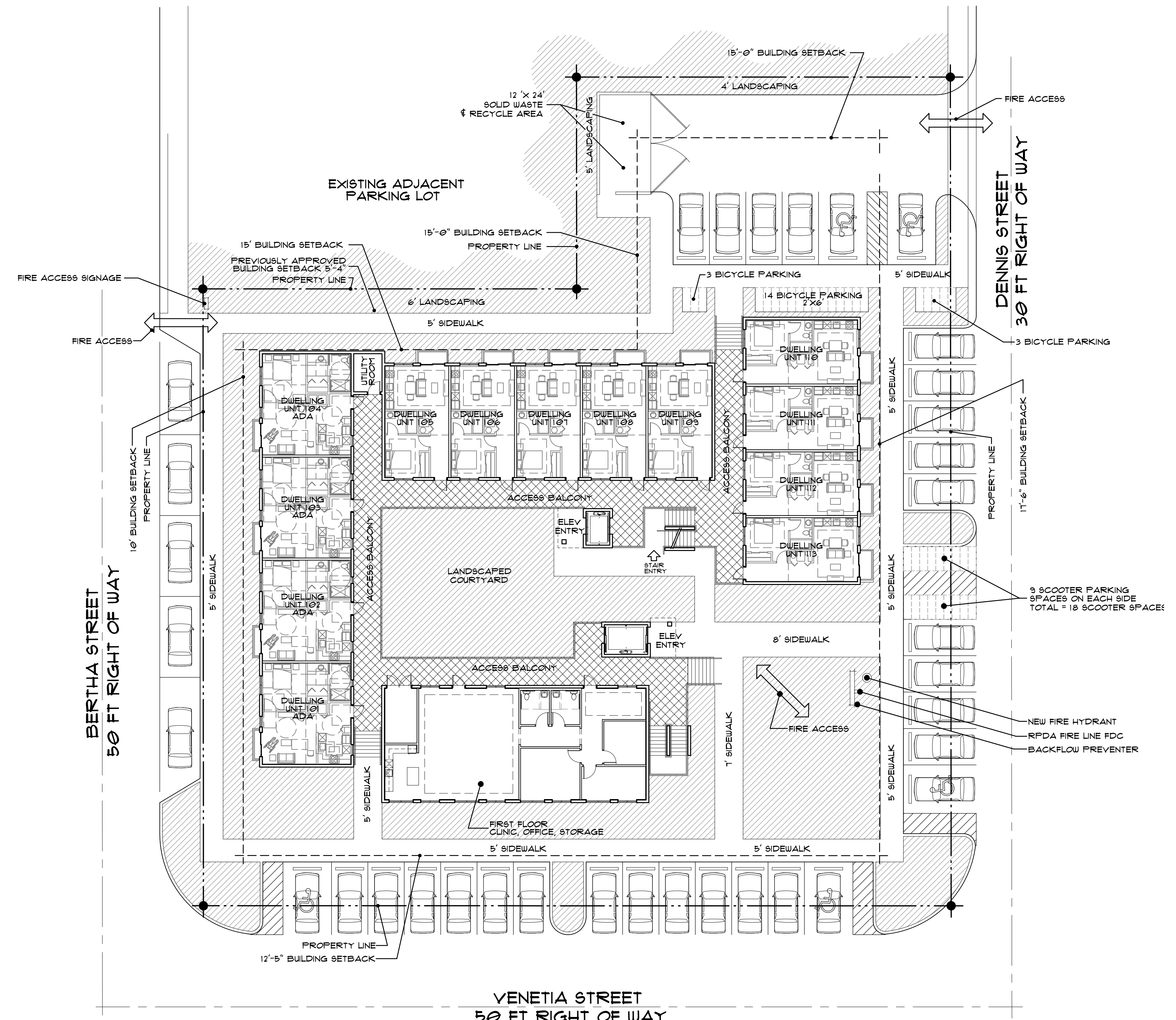

**RESIDENTIAL CARE FACILITY**

	CODE REQUIREMENT	EXISTING	PROPOSED	VARIANCE REQUEST
ZONING	CL			
FLOOD ZONE	AE 8 NAVD			
SIZE OF SITE	33,066 S.F. / 0.76 ACRES			
HEIGHT	40 FEET	LESS THAN 40	40' FROM C.R.	
FRONT SETBACK (DENNIS STREET)	25'-0"	10'-5"	11'-6"	VARIANCE
FRONT SETBACK (VENETIA STREET)	25'-0"	11'-11"	25'-0"	VARIANCE
FRONT SETBACK (BERTHA STREET)	25'-0"	8'-9"	10'-0"	VARIANCE
SIDE SETBACK	20'-0"	4'-0"	15'-0"	VARIANCE
REAR SETBACK	25'-0"	9'-7"	25'-0"	VARIANCE
F.A.R.	(0.8) 26,453	(0.24) 7,939 S.F.	(0.8) 26,385 S.F.	VARIANCE
BUILDING COVERAGE	13,266 S.F. (40%)	9,744 S.F. (29.5%)	12,042 (36%)	
IMPERVIOUS SURFACE	19,839 (60%)	18,585 S.F. (56.2%)	23,151 S.F. (70%)	
PARKING	1 SP/ACE PER 4 ROOMS	19 REQ / 35 PROP	35	
HANDICAP PARKING	2 SP/ACES	0	5	
BICYCLE PARKING	5 SP/ACES	0	20 BICYCLE / 10 SCOOTER	
OPEN SP/ACE / LANDSCAPING	20%	40%	9,915 S.F. (30%)	
NUMBER AND TYPE OF UNITS	16 DU/A	16	41	
CONSUMPTION AREA OR NUMBER OF SEATS	NA	NA	NA	

**SITE PLAN DIAGRAM**  
 SCALE: 1/16" = 1'-0"

Marty's Place Residential Care Facility  
 AIDS Help of Monroe County, 15-12 Dennis Street, Key West, Florida

975 6TH AVE S. SUITE 200  
 NAPLES FLORIDA 34102  
 PHONE: (239) 331-7182  
 WWW.MHKAP.COM

**MHK ARCHITECTURE & PLANNING**

**SKI**  
 MAY 10, 2018

FRI 11 MAY 2018 08:06:31AM EST \\VOLUME5\MK\DRIVE\PROJBOX (MKI\_ABP)\78078\_1515\_BERTHA\_STREET\_MARTYS\_PLACE\_AH\_PROJ\GEN\ARCHITECTURE

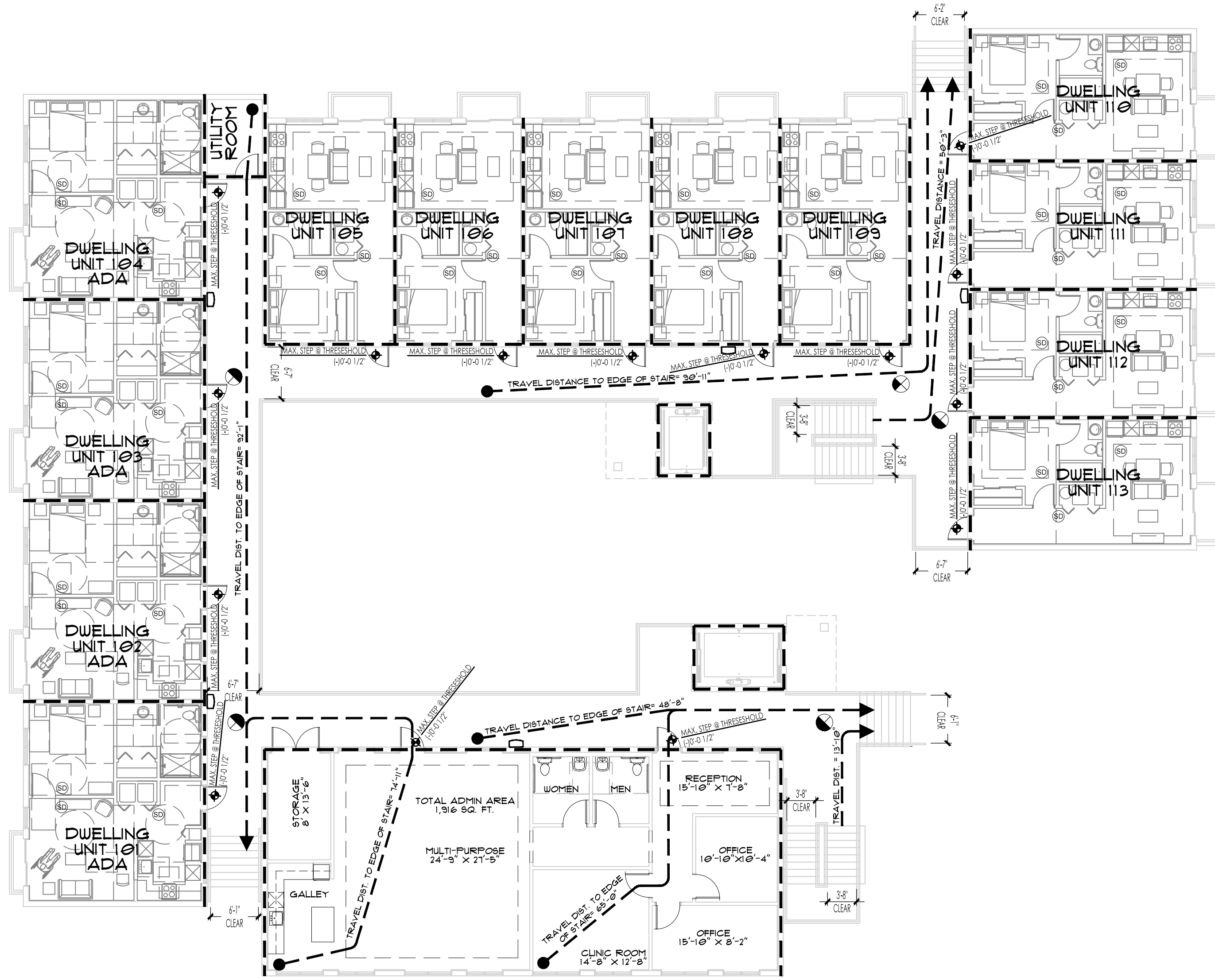

**1ST FLOOR LIFE SAFETY PLAN**  
SCALE: 1/16" = 1'-0"

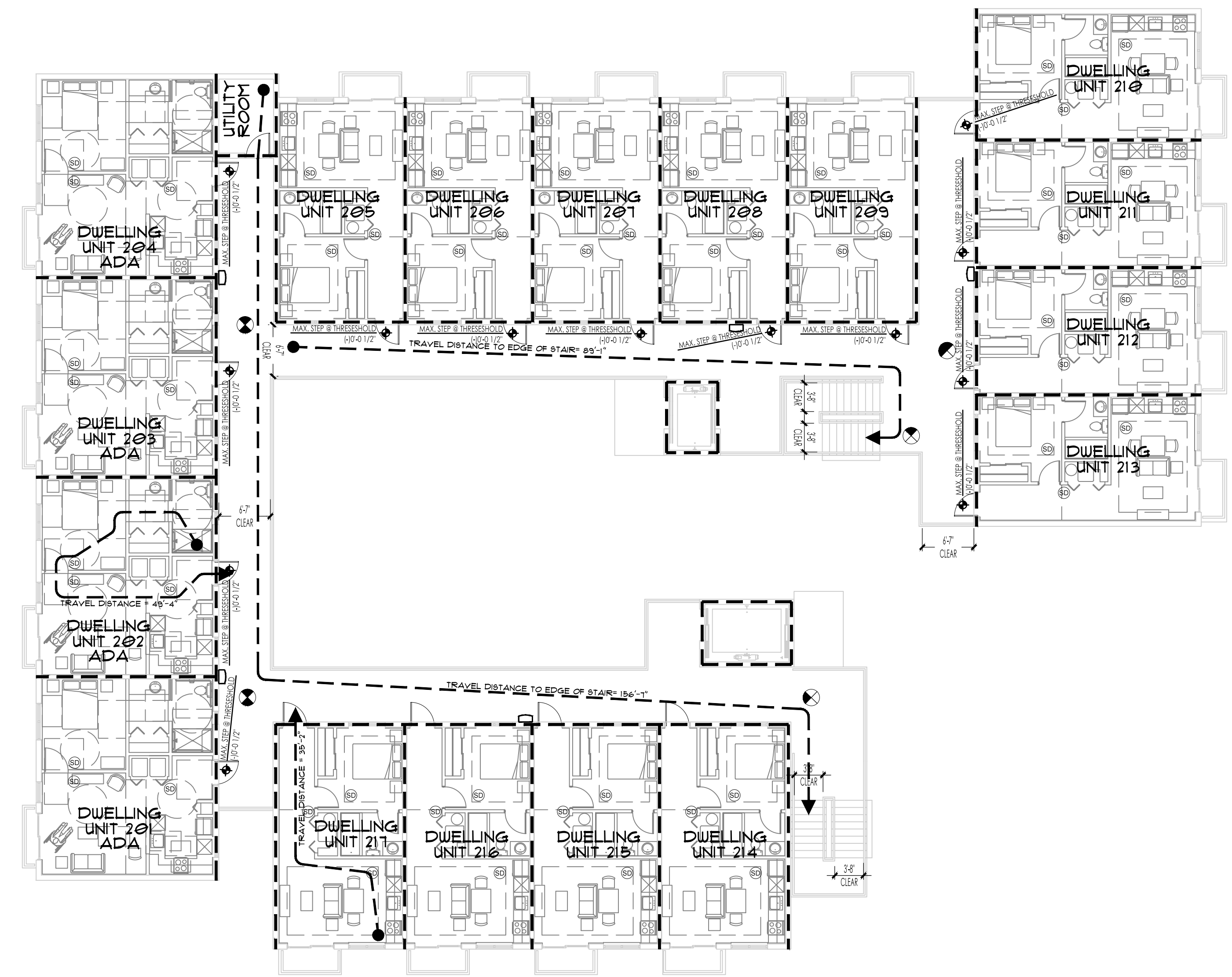

**2ND FLOOR LIFE SAFETY PLAN**  
SCALE: 1/16" = 1'-0"

EGRESS DISTANCE CALCULATIONS					LIFE SAFETY LEGEND		LIFE SAFETY NOTES	
FLOOR	DISTANCE TO EGRESS STAIRS	VERTICAL DISTANCE TO FIRST FLR	DISTANCE TO STAIR	VERTICAL X DISTANCE TO CLEAR	MAX TRAVEL DISTANCE	1-HOUR RATED WALL	2-HOUR RATED WALL	1. FIRE PROTECTION SYSTEM IS NFPA 13 FULL SPINKLER SYSTEM 2. PROVIDE AT EACH STAIR TOWER SIGNAGE ON EACH FLOOR LEVEL STATING THE FOLLOWING (STAIR LOCATION, YOUR CURRENT LEVEL YOU ARE ON, # OF LEVELS TO EXIT (W/ DIRECTIONAL ARROW INDICATE # STAIR EXTENDS TO THE ROOF, INDICATE LEVEL THE STAIR TOWER TERMINATES AT))  EXAMPLE: STAIR #1 YOU ARE ON LEVEL #4 EXIT (W/ DIRECTIONAL ARROW) OF FLOORS TO EXIT) THIS STAIR EXTENDS FROM GROUND FLOOR TO FOURTH FLOOR BRAILLE MARKING
THIRD FLOOR	92'-1"	N/A	N/A	9'-1"	101'-8"			
SECOND FLOOR	156'-1"	21'-1"	13'-10"	9'-1"	201'-1"			
FIRST FLOOR	156'-1"	64'-1"	13'-10"	9'-1"	243'-10"			
MAX TRAVEL DISTANCE ALLOWED W/SPRINKLER		150'	MAX TRAVEL DISTANCE PROVIDED (INCLUDING VERTICAL PATH)		243'-10"			

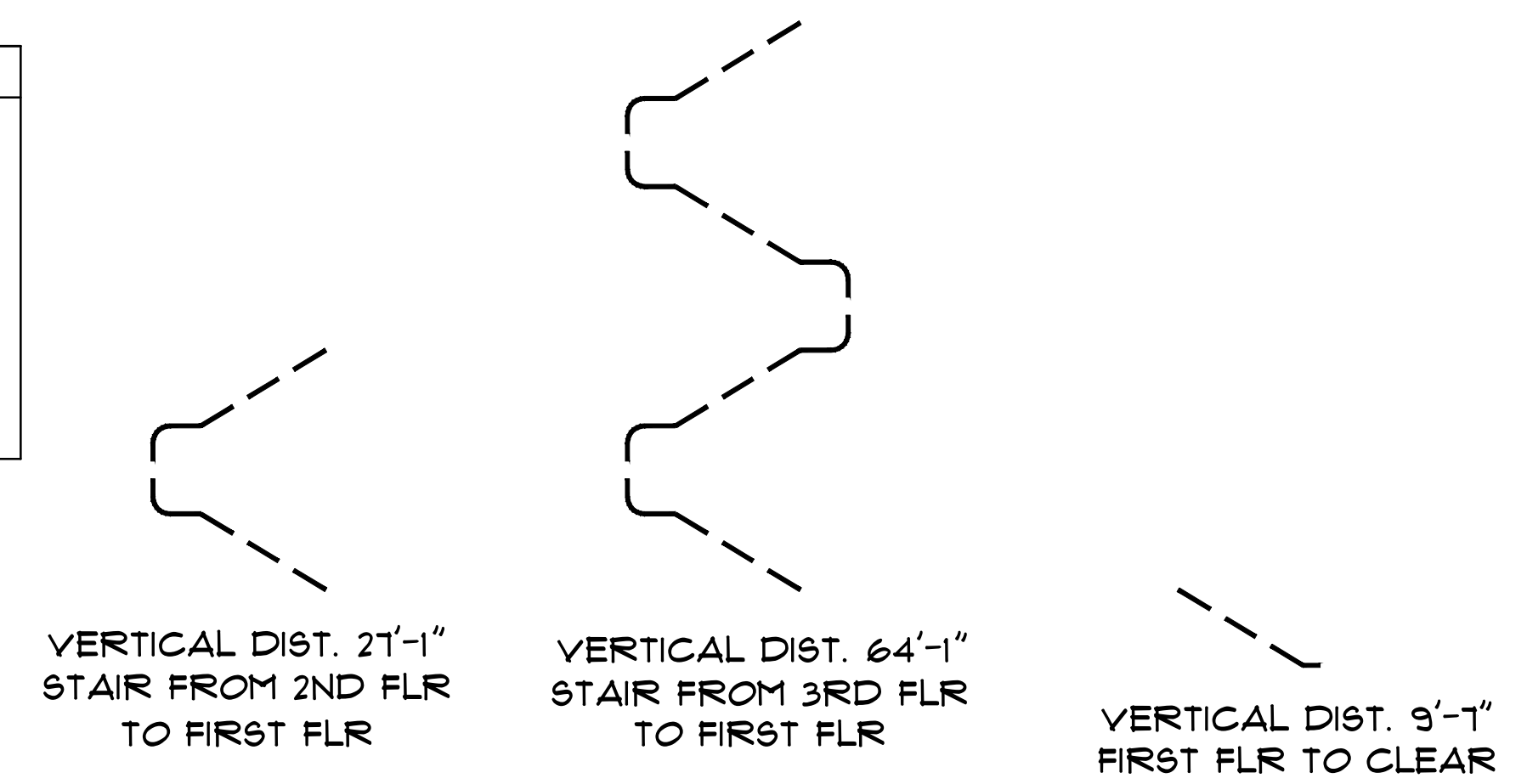

Marty's Place Residential Care Facility  
 AIDS Help of Monroe County, 1512 Dennis Street, Key West, Florida

9756 H.A.E. SUITE 200  
 NAPLES FLORIDA 34102  
 PHONE: (239) 331-7892  
 WWW.MHKAP.COM



**3RD FLOOR LIFE SAFETY PLAN**  
SCALE: 1/16" = 1'-0"

EGRESS DISTANCE CALCULATIONS					LIFE SAFETY LEGEND		LIFE SAFETY NOTES	
	DISTANCE TO EGRESS STAIRS	VERTICAL DISTANCE TO FIRST FLR	DISTANCE TO STAIR	VERTICAL X DISTANCE TO CLEAR	MAX TRAVEL DISTANCE	1-HOUR RATED WALL	2-HOUR RATED WALL	1. FIRE PROTECTION SYSTEM IS NFPA 13 FULL SPRINKLER SYSTEM 2. PROVIDE AT EACH STAIR TOWER SIGNAGE ON EACH FLOOR LEVEL STATING THE FOLLOWING (STAR LOCATION, YOUR CURRENT LEVEL YOU ARE ON, # OF LEVELS TO EXIT (W/ DIRECTIONAL ARROW INDICATE # STAIR EXTENDS TO THE ROOF, INDICATE LEVEL THE STAIR TOWER TERMINATES AT))  EXAMPLE: STAIR #1 YOU ARE ON LEVEL #4 EXIT (W/ DIRECTIONAL ARROW) OF FLOORS TO EXIT) THIS STAIR EXTENDS FROM GROUND FLOOR TO FOURTH FLOOR BRAILLE MARKING
THIRD FLOOR	92'-1"	N/A	N/A	9'-1"	108'-8"			
SECOND FLOOR	156'-1"	21'-1"	13'-10"	9'-1"	207'-1"			
FIRST FLOOR	156'-1"	64'-1"	13'-10"	9'-1"	243'-10"			
MAX TRAVEL DISTANCE ALLOWED w/SPRINKLER		150'	MAX TRAVEL DISTANCE PROVIDED (INCLUDING VERTICAL PATH)		243'-10"			

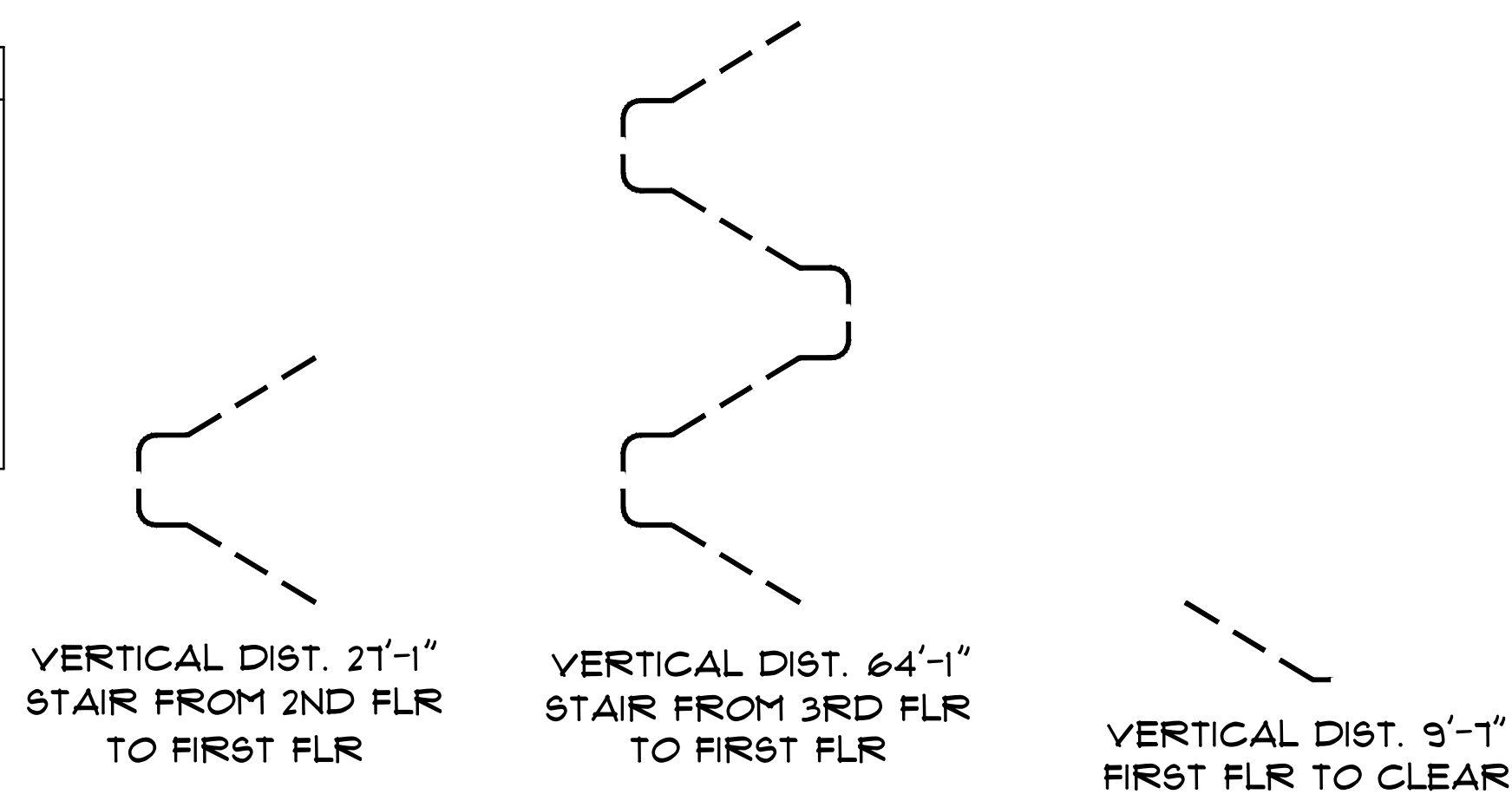

FRI 11 MAY 2018 08:05:02AM EST \\VOLUMES\MKH\DRIVE\DRG\BOX (MKH\_487)\3078\_1515\_BERTHA\_STREET\_MARTYS\_PLACE\_LAN\_PROD\GEN\ARCHITECTURE

Marty's Place Residential Care Facility  
 AIDS Help of Monroe County, 15-12 Dennis Street, Key West, Florida

975 6TH AVE S. SUITE 200  
 NAPLES FLORIDA 34102  
 PHONE: (239) 331-7882  
 WWW.MHKAP.COM



THU 10 MAY 2016 03:11:14 PM EST > \VOLUMES\MKH\DRIVE\PROJECTS\MKH\_A&P\15078\_1515\_BERTHA\_STREET\_MARTYS\_PLACE\_AH\_PRODGEN\ARCHITECTURE



FIRST FLOOR PLAN   
 SCALE: 1/8" = 1'-0"

Marty's Place Residential Care Facility  
 AIDS Help of Monroe County, 15-12 Dennis Street, Key West, Florida

975 6TH AVE S. SUITE 200  
 NAPLES FLORIDA 34102  
 PHONE: (239) 331-7182  
 WWW.MHKAP.COM

**MKH ARCHITECTURE & PLANNING**

**SK2**  
 MAY 10, 2018

THU 10 MAY 2016 4:03:01:0PM EST D:\VOLUMES\MHK\DRIVE\DRIVEBOX (M\K MAP)\18075\_1915\_BERTHA\_STREET\_MARTYS\_PLACE\_AH\_PROJGEN\ARCHITECTURE



2ND FLOOR PLAN   
 SCALE: 1/8" = 1'-0"

Marty's Place Residential Care Facility  
 AIDS Help of Monroe County, 15-12 Dennis Street, Key West, Florida

975 6TH AVE S. SUITE 200  
 NAPLES FLORIDA 34102  
 PHONE: (239) 331-7182  
 WWW.MHKAP.COM

**MHK ARCHITECTURE & PLANNING**

**SK3**  
 MAY 10, 2016

THU 10 MAY 2016 03:01:24PM EST - VOLUMES\MK DRIVE\DRP\BOX (MK AP)/18078\_1915\_BERTHA\_STREET\_MARTYS\_PLACE\_AH\_PROJGEN\ARCHITECTURE



3RD FLOOR PLAN   
 SCALE: 1/8" = 1'-0"

Marty's Place Residential Care Facility  
 AIDS Help of Monroe County, 15-12 Dennis Street, Key West, Florida

975 6TH AVE S. SUITE 200  
 NAPLES FLORIDA 34102  
 PHONE: (239) 331-7182  
 WWW.MHKAP.COM

**MHK ARCHITECTURE & PLANNING**

**SK4**  
 MAY 10, 2016



THU 10 MAY 2016 03:01:49PM EST - VOLUMES\MHK DRIVE\DR0PBOX (Mhk AP8)\18078\_1515\_BERRHA\_STREET\_MARTYS\_PLACE\_AH\_PROGEN\ARCHITECTURE

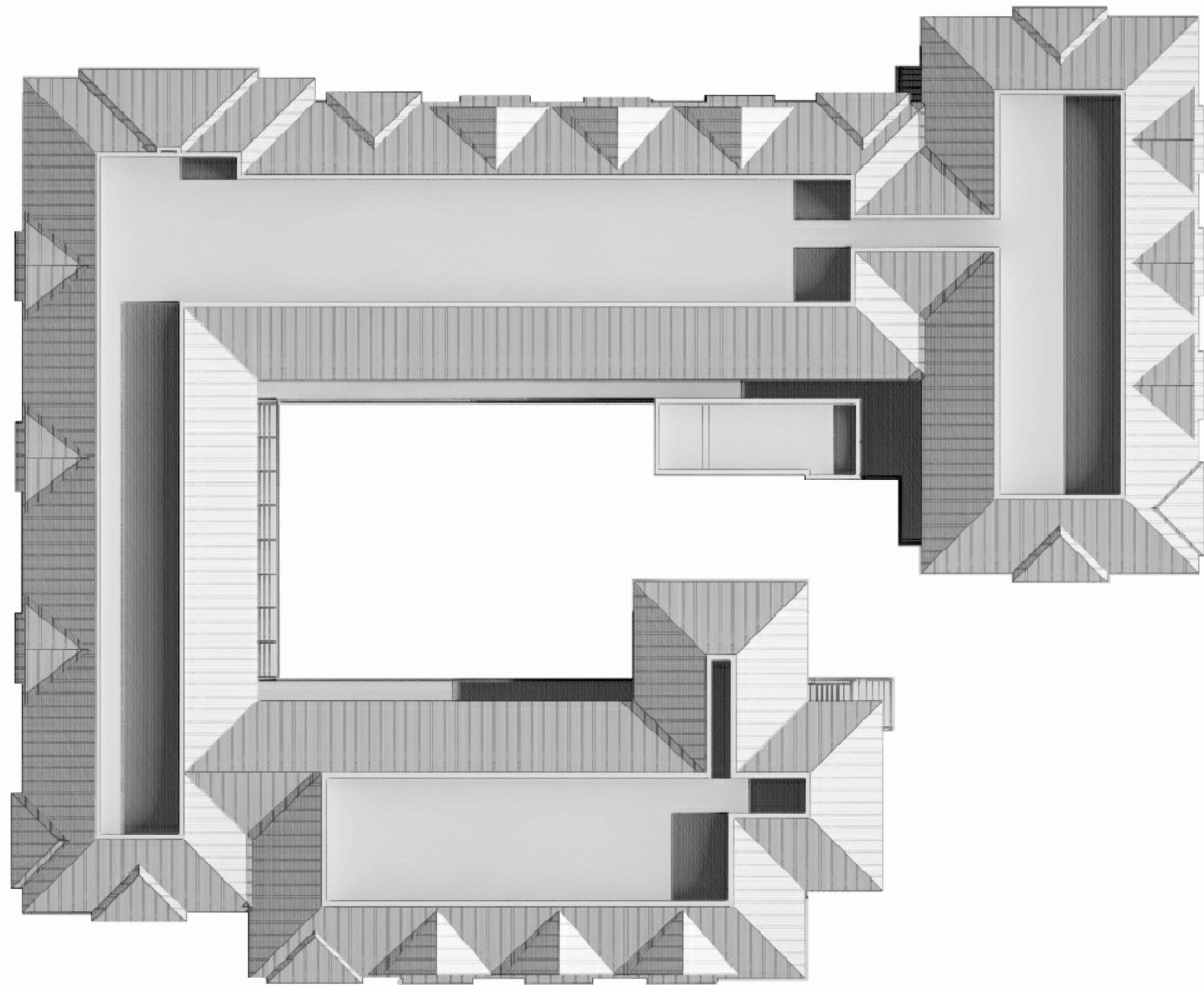

ROOF PLAN

SCALE: 1/8" = 1'-0"



Marty's Place Residential Care Facility  
AIDS Help of Monroe County, 15-12 Dennis Street, Key West, Florida

975 6TH AVE S. SUITE 200  
NAPLES FLORIDA 34102  
PHONE: (239) 331-7192  
WWW.MHKAP.COM

**MHK ARCHITECTURE & PLANNING**

**SK5**  
MAY 10, 2016

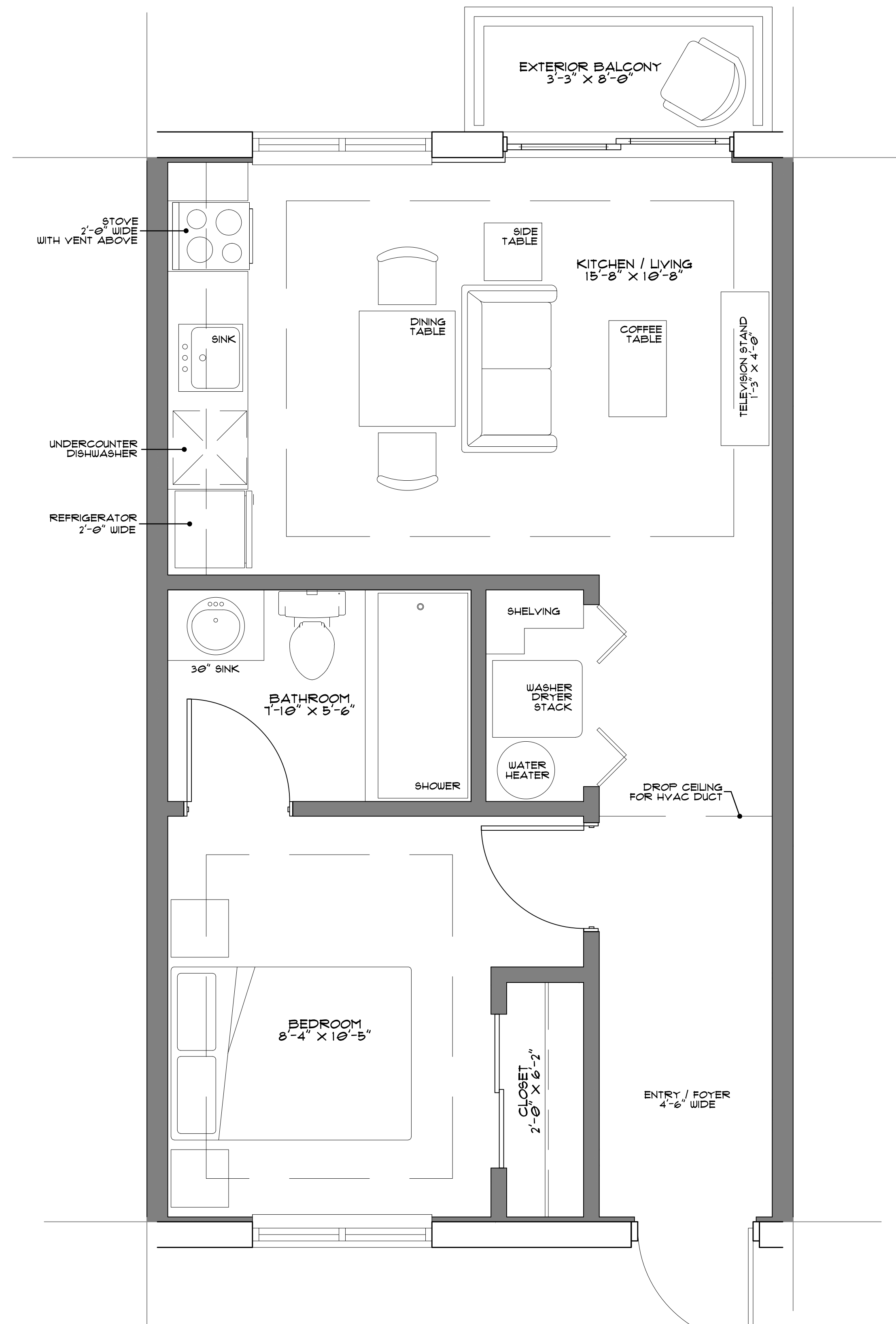

TYPICAL NON-ACCESSIBLE UNIT DIAGRAM  
 1-BEDROOM UNIT ——— 471 S.F.  
 1/2" = 1'-0"

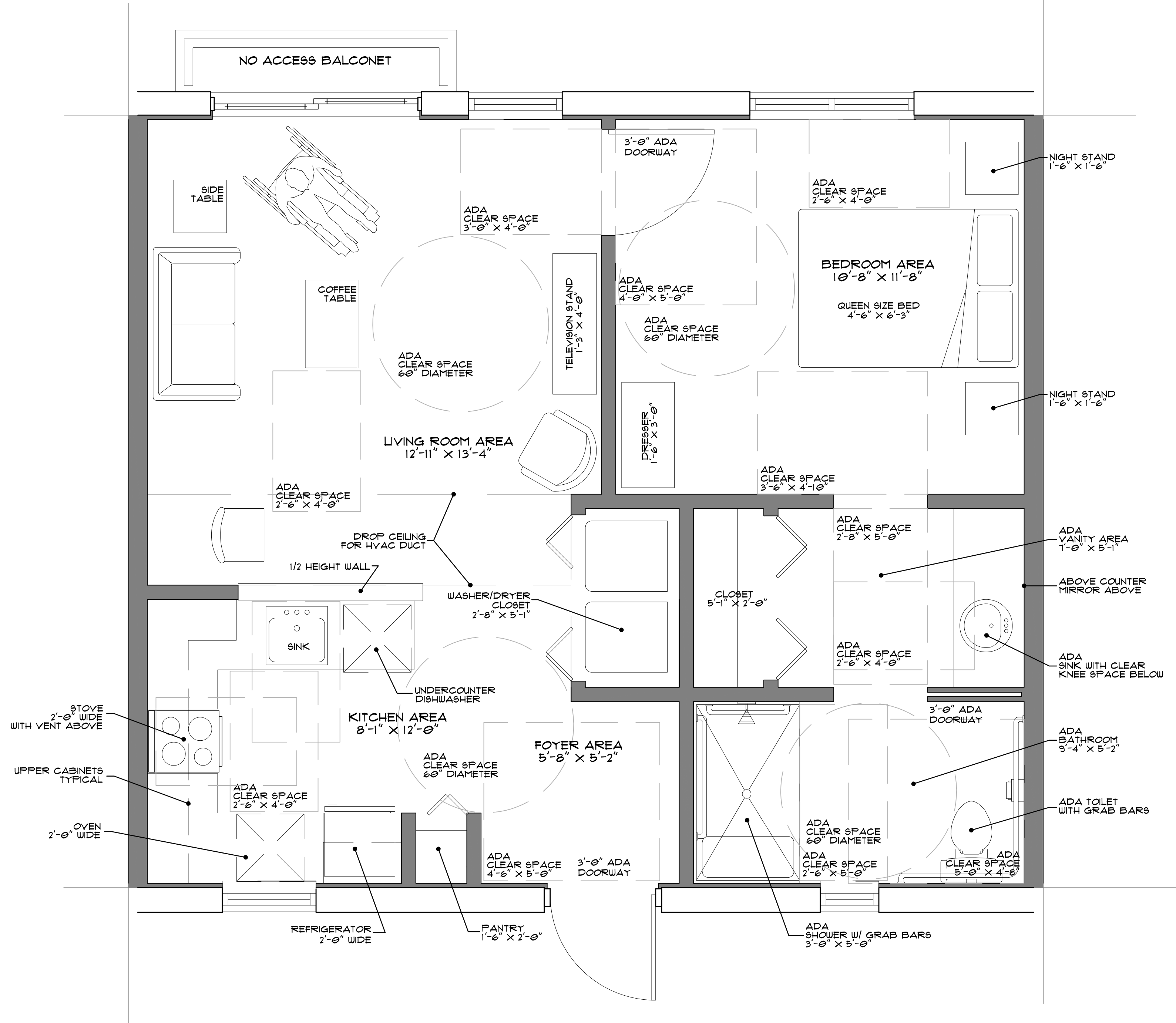

TYPICAL ACCESSIBLE UNIT DIAGRAM  
 1-BEDROOM UNIT ——— 594 S.F.  
 1/2" = 1'-0"

THU 10 MAY 2016 03:02:17PM EST - VOLUMES\MHK DRIVE\DRP\BOX (MJK ABP)\18074\_1515\_BERTHA\_STREET\_MARTYS\_PLACE\_AH\_PROJEN\ARCHITECTURE

Marty's Place Residential Care Facility  
 AIDS Help of Monroe County, 15-12 Dennis Street, Key West, Florida

975 6TH AVE S. SUITE 200  
 NAPLES FLORIDA 34102  
 PHONE: (239) 331-7182  
 WWW.MHKAP.COM

**MJK ARCHITECTURE & PLANNING**

**SK6**  
 MAY 10, 2018



- AVERAGE CROWN RD  
3.15' NAVD  
MEASURED FROM 3.15' NAVD
- ROOFTOP SLAB  
38.0' NAVD
- 3RD FLOOR  
28.0' NAVD
- 2ND FLOOR  
18.0' NAVD
- DESIGN FLOOD ELEVATION  
8.0' NAVD
- FEMA FLOOD ZONE  
7.0' NAVD
- AVERAGE CROWN RD  
3.15' NAVD
- BASEPOINT  
0.0' NAVD



**NORTH BUILDING ELEVATION** (A)  
SCALE: 1/8" = 1'-0"

- AVERAGE CROWN RD  
3.15' NAVD  
MEASURED FROM 3.15' NAVD
- ROOFTOP SLAB  
38.0' NAVD
- 3RD FLOOR  
28.0' NAVD
- 2ND FLOOR  
18.0' NAVD
- DESIGN FLOOD ELEVATION  
8.0' NAVD
- FEMA FLOOD ZONE  
7.0' NAVD
- AVERAGE CROWN RD  
3.15' NAVD
- BASEPOINT  
0.0' NAVD



**WEST BUILDING ELEVATION (BERTHA)** (B)  
SCALE: 1/8" = 1'-0"

- AVERAGE CROWN RD  
3.15' NAVD  
MEASURED FROM 3.15' NAVD
- ROOFTOP SLAB  
38.0' NAVD
- 3RD FLOOR  
28.0' NAVD
- 2ND FLOOR  
18.0' NAVD
- DESIGN FLOOD ELEVATION  
8.0' NAVD
- FEMA FLOOD ZONE  
7.0' NAVD
- AVERAGE CROWN RD  
3.15' NAVD
- BASEPOINT  
0.0' NAVD



**SOUTH BUILDING ELEVATION (VENETIA)** (C)  
SCALE: 1/8" = 1'-0"

THU 10 MAY 2016 03:02:49PM EST \\VOLUMES\MK\_DRIVE\DRP\BOX (MK AP)\18078\_1515\_BERTHA\_STREET\_MARTYS\_PLACE\_AH\_PROJGEN\ARCHITECTURE

Marty's Place Residential Care Facility  
AIDS Help of Monroe County, 15-12 Dennis Street, Key West, Florida

975 6TH AVE S. SUITE 200  
NAPLES FLORIDA 34102  
PHONE: (239) 331-7182  
WWW.MHKAP.COM

**MHK ARCHITECTURE & PLANNING**

**SK1**  
MAY 10, 2016



- AVERAGE CROWN RD  
3.75' NAVD  
MEASURED FROM 3.75' NAVD
- ROOFTOP SLAB  
38.0' NAVD
- 3RD FLOOR  
28.0' NAVD
- 2ND FLOOR  
18.0' NAVD
- DESIGN FLOOD ELEVATION  
8.0' NAVD
- FEMA FLOOD ZONE  
7.0' NAVD
- AVERAGE CROWN RD  
3.75' NAVD
- BASEPOINT  
0.0' NAVD



**EAST BUILDING ELEVATION (DENNIS)** (D)  
SCALE: 1/8" = 1'-0"

- AVERAGE CROWN RD  
3.75' NAVD  
MEASURED FROM 3.75' NAVD
- ROOFTOP SLAB  
38.0' NAVD
- 3RD FLOOR  
28.0' NAVD
- 2ND FLOOR  
18.0' NAVD
- DESIGN FLOOD ELEVATION  
8.0' NAVD
- FEMA FLOOD ZONE  
7.0' NAVD
- AVERAGE CROWN RD  
3.75' NAVD
- BASEPOINT  
0.0' NAVD



**INTERIOR SOUTH BUILDING ELEVATION** (E)  
SCALE: 1/8" = 1'-0"

- AVERAGE CROWN RD  
3.75' NAVD  
MEASURED FROM 3.75' NAVD
- ROOFTOP SLAB  
38.0' NAVD
- 3RD FLOOR  
28.0' NAVD
- 2ND FLOOR  
18.0' NAVD
- DESIGN FLOOD ELEVATION  
8.0' NAVD
- FEMA FLOOD ZONE  
7.0' NAVD
- AVERAGE CROWN RD  
3.75' NAVD
- BASEPOINT  
0.0' NAVD



**INTERIOR NORTH BUILDING ELEVATION** (F)  
SCALE: 1/8" = 1'-0"

THU 10 MAY 2018 03:03:10PM EST \\VOLUMES\MK DRIVE\DRP\BOX (MK AP)/18078\_1015\_BERTHA\_STREET\_MARTYS\_PLACE\_AH\_PROJGEN\ARCHITECTURE

Marty's Place Residential Care Facility  
 AIDS Help of Monroe County, 15-12 Dennis Street, Key West, Florida

975 6TH AVE S. SUITE 200  
 NAPLES FLORIDA 34102  
 PHONE: (239) 331-7182  
 WWW.MHKAP.COM

**MHK ARCHITECTURE & PLANNING**

**SK8**  
 MAY 10, 2018





VIEW FROM SOUTHEAST CORNER (VENETIA & DENNIS)



VIEW FROM SOUTH (VENETIA)



VIEW FROM NORTH

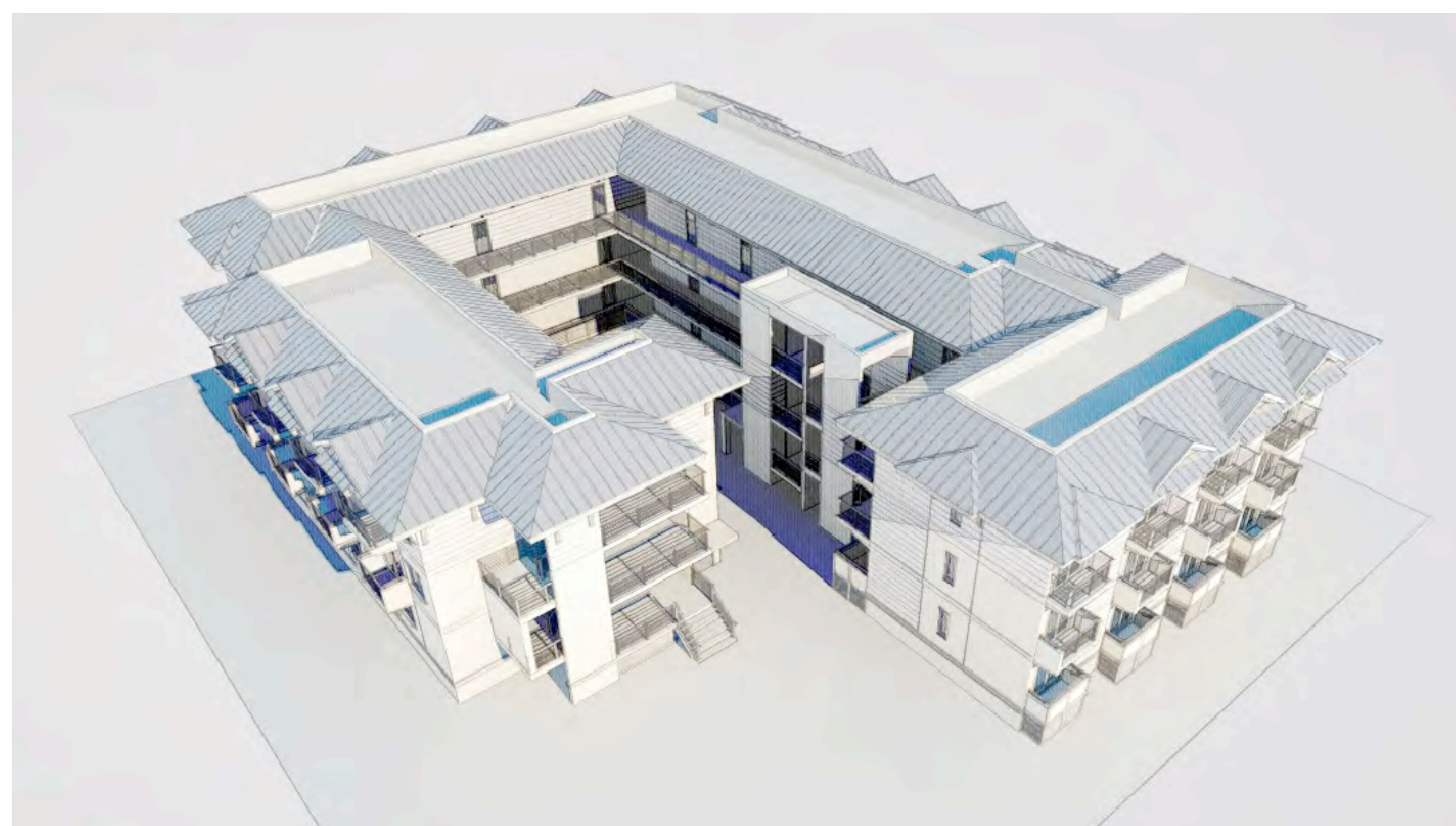

AERIAL VIEW FROM SOUTHWEST CORNER

THU 10 MAY 2016 03:08:49PM EST - V:\JAMES\MH\DRIVE\PROFEX (MHK MAP)/18078\_1515\_BERTHA\_STREET\_MARTYS\_PLACE\_AH\_PROFEX/ARCHITECTURE

Marty's Place Residential Care Facility  
 AIDS Help of Monroe County, 1512 Dennis Street, Key West, Florida

975 6TH AVE S. SUITE 200  
 NAPLES FLORIDA 34102  
 PHONE: (239) 331-7182  
 WWW.MHKAP.COM

**MHK ARCHITECTURE & PLANNING**

**SK9**  
 MAY 10, 2016



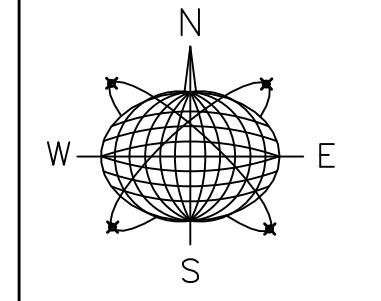
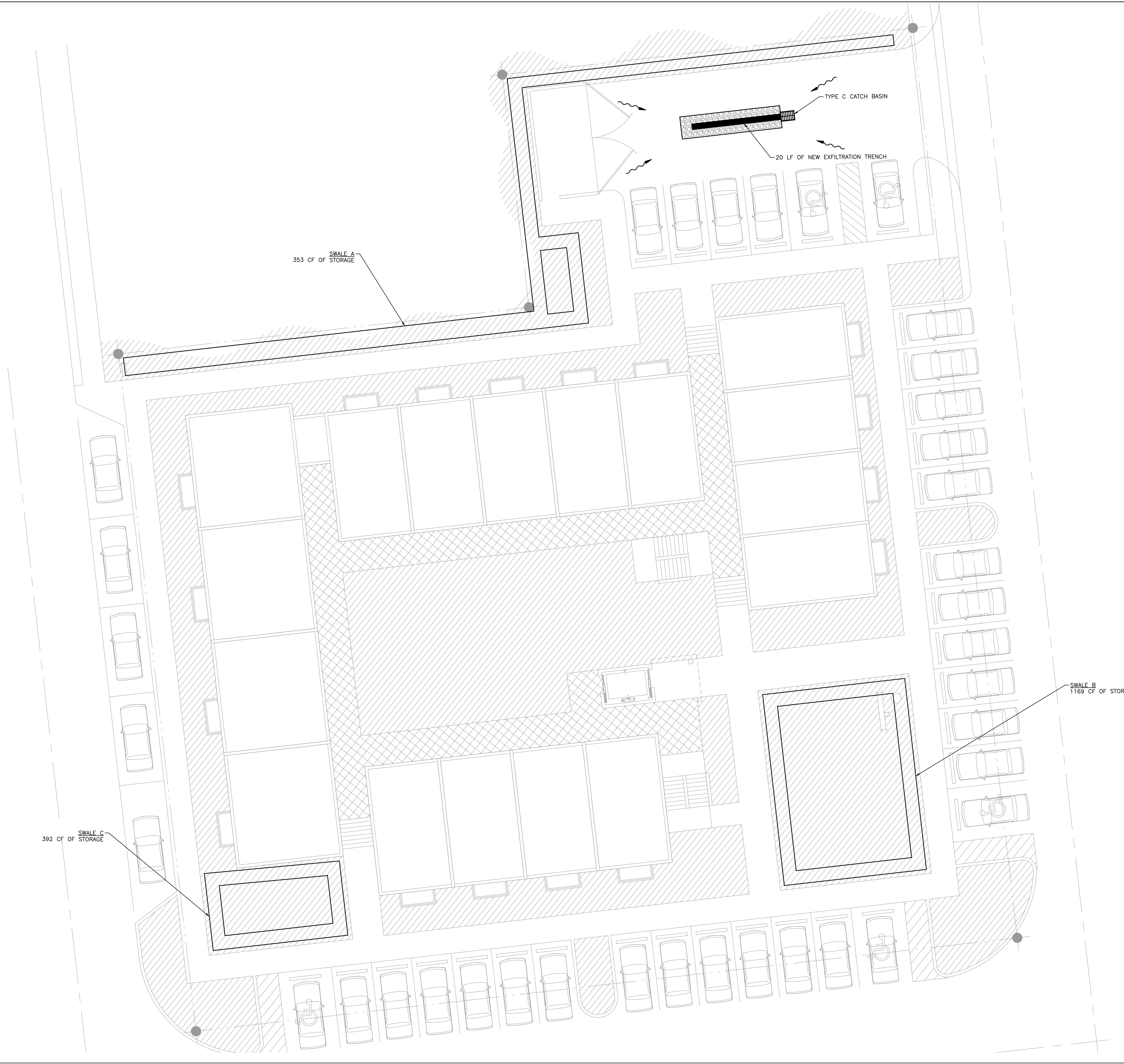

Meridian Engineering LLC  
201 Front Street, Suite 210  
Key West, Florida 33040  
AUTHORIZATION #29401  
ph: 305-293-3263 fax: 293-4899

Seal:

NOT VALID FOR CONSTRUCTION UNLESS  
SIGNED AND SEALED BY THIS BLOCK

RICHARD J. MILELLI  
PE #58315

General Notes:

**MARTY'S PLACE, AIDS HELP  
OF MONROE COUNTY, INC.**

1512 DENNIS STREET  
KEY WEST, FLORIDA

Drawn By: ANF	Checked By: RJM
Project No.	Scale:
AutoCad File No.	

Revisions:

Title:  
**DRAINAGE  
PLAN**

Sheet Number:  
**C-1.0**

Date: MAY 10, 2018

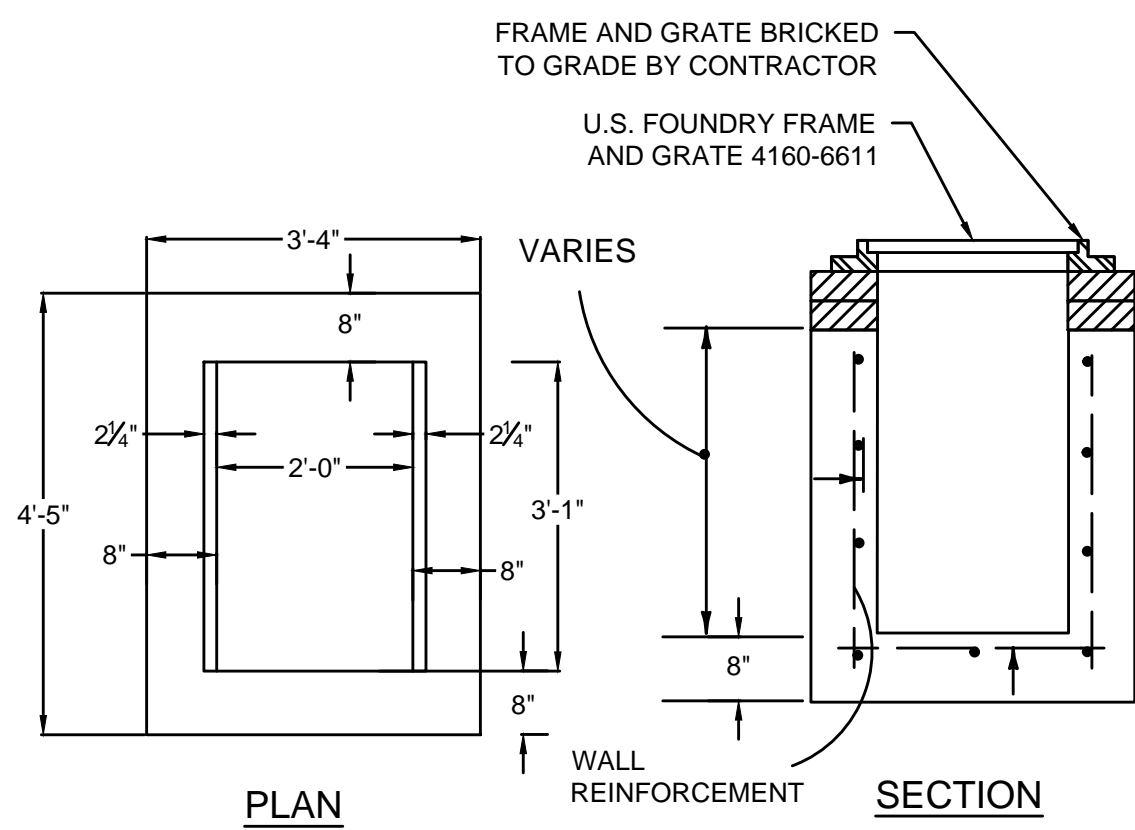

- NOTES:**
1. CONCRETE SHALL BE 4000 PSI AT 28 DAYS, TYPE II CEMENT
  2. ALL REINFORCEMENT MAY BE WELDED WIRE AS PER ASTM C-478, #4 @ 12" O.C.E.W.
  3. FRAME AND GRATE BRICKED TO GRADE BY CONTRACTOR.
  4. BOTTOM INLETS SHALL BE FDOT TYPE C CATCH BASIN OR EQUAL.
  5. STRUCTURES TO BE SET ON COARSE AGGREGTE BEDDING.

**1 CATCH BASIN DETAIL**  
C-1.1 SCALE: NTS

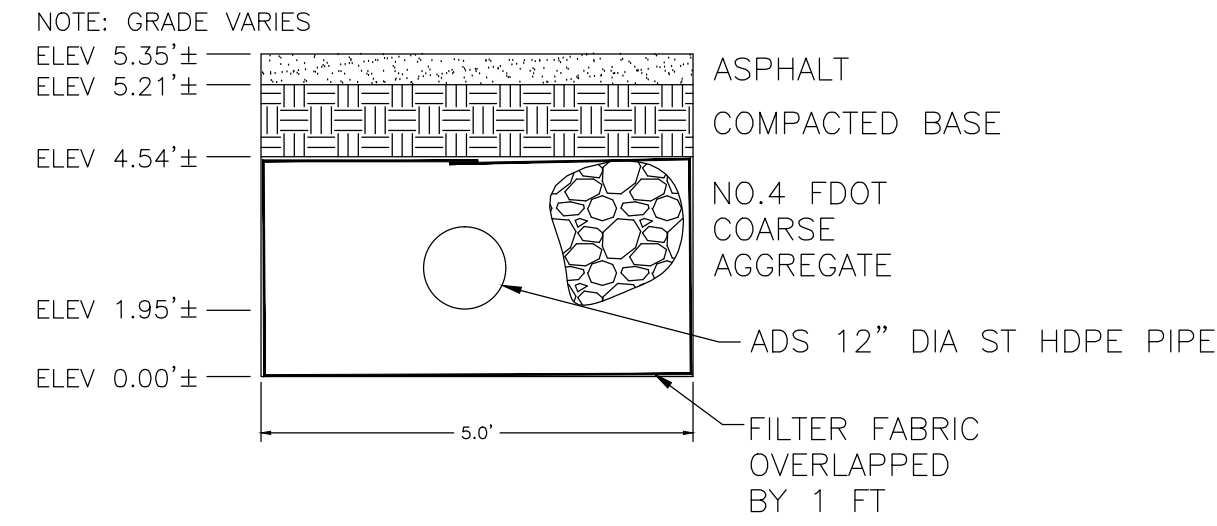

- NOTES:**
1. FILTER FABRIC SHALL BE MARAFI FILTERWEAVE 300 OR ENGINEER APPROVED EQUIVALENT. FILTER FABRIC SHALL BE INSTALLED PER MANUFACTURER'S INSTRUCTIONS.
  2. GRADES DEPICTED DO NOT REFERENCE ACTUAL ELEVATIONS. GRADES ARE CONCEPTUAL TO SHOW REQUIRED DEPTHS.

**2 TRENCH DETAIL**  
C-1.1 SCALE: NTS

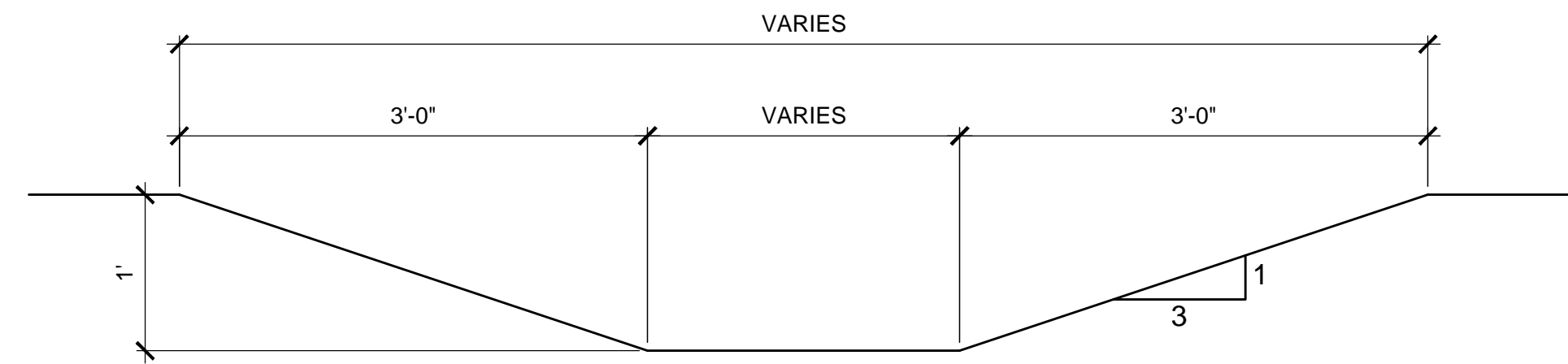

**3 TYPICAL SWALE DETAIL**  
C-1.1 SCALE: NTS

**WATER QUANTITY - PREDEVELOPMENT**

PROJECT AREA	0.76 AC
PERVIOUS AREA	0.33 AC
IMPERVIOUS AREA	0.43 AC
% IMPERVIOUS	56.20%

RAINFALL FOR 25YR/72HR EVENT (P)	12.00 IN
DEPTH TO WATER TABLE	3 FT
UNDEVELOPED AVAILABLE STORAGE	4.95 IN
SOIL STORAGE (S)	2.17 IN
QPRE = (P - 0.2S)^2 / (P + 0.8S) [25YR/72HR]	9.74 IN

**WATER QUANTITY - POSTDEVELOPMENT**

PROJECT AREA	0.76 AC
PERVIOUS AREA	0.23 AC
IMPERVIOUS AREA	0.53 AC
% IMPERVIOUS	70.01%

RAINFALL FOR 25YR/72HR EVENT (P)	12.00 IN
DEPTH TO WATER TABLE	3 FT
DEVELOPED AVAILABLE STORAGE	4.95 IN
SOIL STORAGE (S)	1.48 IN
QPOST = (P - 0.2S)^2 / (P + 0.8S) [25YR/72HR]	10.39 IN

**POSTDEVELOPMENT - PREDEVELOPMENT**

QPOST - QPRE [25YR/72HR]	0.65 IN	
VOLUME = QA [25YR/72HR]	0.49 AC-IN	0.041 AC-FT

**WATER QUALITY**

PROJECT AREA	0.76 AC
TOTAL ROOF AREA	0.27 AC
ADJUSTED PROJECT AREA	0.49 AC
IMPERVIOUS AREA	0.26 AC
% IMPERVIOUS	53.17%

A) ONE INCH OF RUNOFF FROM DRAINAGE BA	0.063 AC-FT
B) 2.5 INCHES * % IMPERVIOUS * TOT. PROJ.	0.084 AC-FT

**WATER QUANTITY Vs. WATER QUALITY**

QUANTITY	0.041 AC-FT	QUALITY	0.084 AC-FT
----------	-------------	---------	-------------

**SWALE VOLUME REQUIRED**

WATER QUALITY/QUANTITY * 50%	1831.49 CU. FT	0.04 AC-FT
------------------------------	----------------	------------

**NOTE:**  
50% CREDIT FOR DRY RETENTION

SWALE A =	0.01 AC-FT
SWALE B =	0.03 AC-FT
SWALE C =	0.01 AC-FT
<b>TOTAL =</b>	<b>0.05 AC-FT</b>

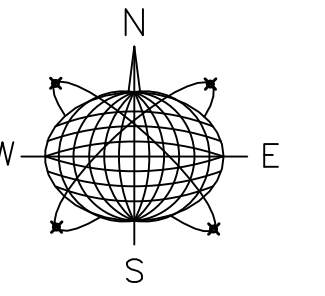

Meridian Engineering LLC  
201 Front Street, Suite 210  
Key West, Florida 33040  
AUTHORIZATION #29401  
ph:305-293-3263 fax:293-4899

Seal:

NOT VALID FOR CONSTRUCTION UNLESS SIGNED AND SEALED BY THIS BLOCK

RICHARD J. MILELLI  
PE #58315

General Notes:

MARTY'S PLACE, AIDS HELP  
OF MONROE COUNTY, INC.

1512 DENNIS STREET  
KEY WEST, FLORIDA

Drawn By:	ANF	Checked By:	RJM
Project No.		Scale:	

AutoCad File No.

Revisions:

Title:  
DRAINAGE  
DETAILS

Sheet Number:  
C-1.1

Date: MAY 10, 2018



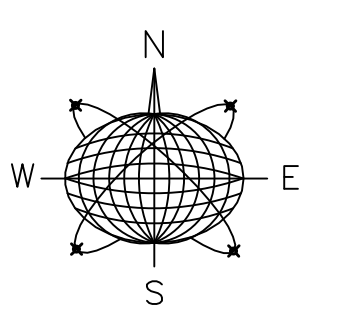
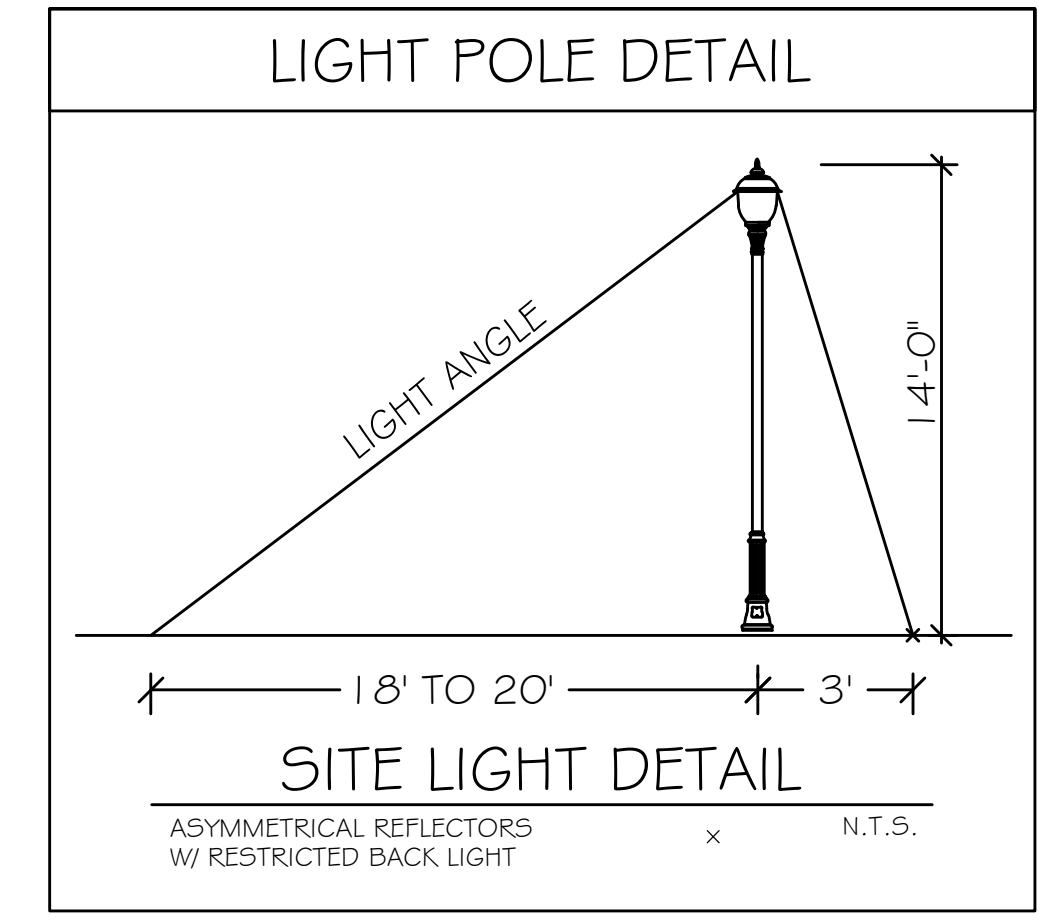

Meridian Engineering LLC  
 201 Front Street, Suite 210  
 Key West, Florida 33040  
 AUTHORIZATION #29401  
 ph: 305-293-3263 fax: 293-4899

Seal:

NOT VALID FOR CONSTRUCTION UNLESS  
SIGNED AND SEALED BY THIS BLOCK

RICHARD J. MILELLI  
 PE #58315

General Notes:

**MARTY'S PLACE, AIDS HELP  
 OF MONROE COUNTY, INC.**

1512 DENNIS STREET  
 KEY WEST, FLORIDA

Drawn By:	Checked By:
ANF	RJM
Project No.	Scale:

AutoCad File No.

Revisions:

Title:  
**LIGHTING  
 PLAN**

Sheet Number:  
**C-2.0**

Date: MAY 10, 2018