

# **Staff Report**

**THE CITY OF KEY WEST  
PLANNING BOARD  
Staff Report**



**To:** Chairman and Planning Board Members

**Through:** Thaddeus Cohen, Planning Director

**From:** Melissa Paul-Leto, Planner Analyst

**Meeting Date:** October 20, 2016

**Agenda Item:** **Variance – 3218 Riviera Drive (RE# 00069470-000000; AK# 1073351)**  
– a variance in order to construct a gate house on property located within the Single Family (SF) Zoning District pursuant to Sections 90-395 and 122-1181 of the Land Development Regulations of the Code of Ordinances of the City of Key West, Florida.

---

**Request:** A request to construct a 5 x 4 accessory structure in the front yard.

**Applicant:** George B. Wallace

**Owner:** George B. Wallace

**Location:** 3218 Riviera Drive (RE# 00069470-000000; AK# 1073351)

**Zoning:** Single-Family Residential (SF) Zoning District



**Background and Request:**

The property is comprised of a single family one story residence located within the Single Family zoning district. The owner applied for building permits to construct a wall and a gate house around the front of the subject property. At this time, planning staff contacted the owner regarding the proposed gate house. The gate house is considered an accessory structure. Under Section 122-1181, no accessory uses or structures shall be erected in any required front or side yard. The owner was granted a building permit for the concrete brick wall on August 4, 2016 and since then the wall has been constructed.

<b>Relevant SF Zoning District Dimensional Requirements: Code Section 122-238</b>				
<b>Dimensional Requirement</b>	<b>Required/ Allowed</b>	<b>Existing</b>	<b>Proposed</b>	<b>Change / Variance Required?</b>
Flood Zone	AE-8			
Size of Site	6,000	7,800	No change	In Compliance
Maximum height	25 feet + 5 feet non-habitable	0 feet (Accessory structure)	8 feet (Accessory structure)	In Compliance
Minimum front setback (Accessory Structure)	30 feet	30 feet	0 feet	<b>Variance Rqd Accessory Structure in the front yard</b>
Maximum building coverage	35% (2,730 sf)	32% (2,503sf)	32% (2,524 sf)	In compliance
Maximum impervious surface	50% (3,900)	% (3,698 sf)	(3,706)	In compliance
Minimum Open Space	35%	38% (2,955sf)	38% 2,955 sf	In compliance

**Process:**

**Planning Board Meeting:**

October 20, 2016

**Local Appeal Period:**

30 days

**DEO Review Period:**

up to 45 days

**Analysis – Evaluation for Compliance with the Land Development Regulations:**

The criteria for evaluating a variance are listed in Section 90-395 of the City Code. The Planning Board before granting a variance must find all of the following:

- 1. Existence of special conditions or circumstances. That special conditions and circumstances exist which are peculiar to the land, structure or building involved and which are not applicable to other land, structures or buildings in the same zoning district.*

No special conditions or circumstances exist peculiar to the land, structures or buildings involved.

NOT IN COMPLIANCE.

2. ***Conditions not created by applicant. That the special conditions and circumstances do not result from the action or negligence of the applicant.***

The conditions are created by the applicant. The applicant is proposing to construct an accessory structure in the front yard of the property.

NOT IN COMPLIANCE.

3. ***Special privileges not conferred. That granting the variance requested will not confer upon the applicant any special privileges denied by the land development regulations to other lands, buildings or structures in the same zoning district.***

Section 122-27 of the Land Development Regulations discourages the expansion of site nonconformities. Therefore, allowing an accessory structure in the front yard would confer special privileges upon the applicant.

NOT IN COMPLIANCE.

4. ***Hardship conditions exist. That literal interpretation of the provisions of the land development regulations would deprive the applicant of rights commonly enjoyed by other properties in this same zoning district under the terms of this ordinance and would work unnecessary and undue hardship on the applicant.***

The applicant currently has existing use of the site without constructing the accessory structure. Denial of the requested variance would not deprive the applicant of rights commonly enjoyed by other properties in the SF Zoning District. Therefore, hardship conditions do not exist.

NOT IN COMPLIANCE.

5. ***Only minimum variance granted. That the variance granted is the minimum variance that will make possible the reasonable use of the land, building, or structure.***

The variance requested is not the minimum required that will make possible the reasonable use of the land, building, or structure since the applicant currently has reasonable use of the site without the approval of the variance. However, it is the minimum necessary to accommodate the request.

NOT IN COMPLIANCE.

6. ***Not injurious to the public welfare. That the granting of the variance will be in harmony with the general intent and purpose of the land development regulations and that such variance will not be injurious to the area involved or otherwise detrimental to the public interest or welfare.***

The granting of the requested variance would not be injurious to the area involved and otherwise detrimental to the public interest.

IN COMPLIANCE.

7. *Existing nonconforming uses of other property not the basis for approval. No nonconforming use of neighboring lands, structures, or buildings in the same district, and no permitted use of lands, structures or buildings in other districts shall be considered grounds for the issuance of a variance.*

Existing non-conforming uses of other properties, use of neighboring lands, structures, or buildings in the same district, or other zoning districts, are not the basis for this request.

IN COMPLIANCE.

**Concurrency Facilities and Other Utilities or Service (Section 108-233):**

It does not appear that the requested variance will trigger any public facility capacity issues.

**The Planning Board shall make factual findings regarding the following:**

1. *That the standards established by Section 90-395 of the City Code have been met by the applicant for a variance.*

The standards established by Section 90-395 of the City Code have not been fully met by the applicant for the variance requested.

2. *That the applicant has demonstrated a "good neighbor policy" by contacting or attempting to contact all noticed property owners who have objected to the variance application, and by addressing the objections expressed by these neighbors.*

As of the date of this report the Planning Department has received three supportive public comments regarding the variance request.

**RECOMMENDATION:**

Based on the criteria established by the Comprehensive Plan and the Land Development Regulations, the Planning Department recommends the request for variance be **denied**.

# Application



# Application For Variance

City of Key West, Florida • Planning Department

3140 Flagler Avenue • Key West, Florida 33040-4602 • 305-809-3720 • www.keywestcity.com

**Application Fee: \$1,150.00 / After-the-Fact: \$2,150.00**  
(includes \$100.00 advertising/noticing fee and \$50.00 fire review fee)

Please complete this application and attach all required documents. This will help staff process your request quickly and obtain necessary information without delay. If you have any questions, please call 305-809-3720.

### PROPERTY DESCRIPTION:

Site Address: 3218 Riviera Dr., Key West

Zoning District: SF Real Estate (RE) #:

Property located within the Historic District?  Yes  No

APPLICANT:  Owner  Authorized Representative

Name: George B. Wallace

Mailing 3218 Riviera Dr. Address:

City: Key West State: FL Zip: 33040

Home/Mobile Phone: 407-416-8256 Office: 305-809-3774 Fax:

Email: gwallace@cityofkeywest-fl.gov

### PROPERTY OWNER: (if different than above)

Name: SAME

Mailing Address:

City: State: Zip:

Home/Mobile Phone: Office: Fax:

Email:

Description of Proposed Construction, Development, and Use: entry gate (covered)

### List and describe the specific variance(s) being requested:

allow entry gate to be constructed in wall facing street. (auxillary structure)

Are there any easements, deed restrictions or other encumbrances attached to the property?  Yes  No

If yes, please describe and attach relevant documents:

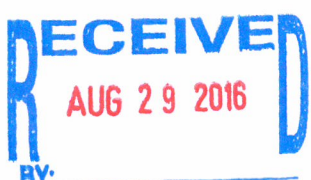

# Proposed Gate

City of Key West • Application for Variance

Will any work be within the dripline (canopy) of any tree on or off the property?  Yes  No  
 If yes, provide date of landscape approval, and attach a copy of such approval.

Is this variance request for habitable space pursuant to Section 122-1078?  Yes  No

Please fill out the relevant Site Data in the table below. For Building Coverage, Impervious Surface, Open Space and F.A.R. provide square footages and percentages.

Site Data Table				
	Code Requirement	Existing	Proposed	Variance Request
Zoning	SF-1			
Flood Zone	AE 8			
Size of Site	6600	7800		
Height	25	—	8	NONE
Front Setback	20	30'	26'	4'
Side Setback				NONE
Side Setback	5			NONE
Street Side Setback	10	—		NONE
Rear Setback	20		20	NONE
F.A.R.	A/A			
Building Coverage	<del>35%</del>	12'	21.6'	NONE
Impervious Surface	50%	(sidewalk)	45%	NONE
Parking				
Handicap Parking				
Bicycle Parking				
Open Space/ Landscaping				
Number and type of units				
Consumption Area or Number of seats				

This application is reviewed pursuant to Section 90-391 through 90-397 of the City of Key West Land Development Regulations (LDRs). The City's LDRs can be found in the Code of Ordinances online at [http://www.municode.com/Library/FL/Key\\_West](http://www.municode.com/Library/FL/Key_West) under Subpart B.

\*Please note, variances are reviewed as quasi-judicial hearings, and it is improper for the owner or applicant to speak to a Planning Board member or City Commissioner about the hearing.



# Existing Home

City of Key West • Application for Variance

Will any work be within the dripline (canopy) of any tree on or off the property?  
If yes, provide date of landscape approval, and attach a copy of such approval.

Yes  No

Is this variance request for habitable space pursuant to Section 122-1078?

Yes  No

Please fill out the relevant Site Data in the table below. For Building Coverage, Impervious Surface, Open Space and F.A.R. provide square footages and percentages.

Site Data Table				
	Code Requirement	Existing	Proposed	Variance Request
Zoning	SF-1			
Flood Zone	AE 8			
Size of Site	6000	7800		
Height	25			
Front Setback	30			
Side Setback		-		
Side Setback	5	-	5	
Street Side Setback	10	-	10	
Rear Setback	20		20	
F.A.R	N/A	12,503 SF		
Building Coverage	35%	<del>5,167 SF</del>		
Impervious Surface	50%	3,698	45%	
Parking	-	-		
Handicap Parking				
Bicycle Parking				
Open Space/ Landscaping	35%	38%		
Number and type of units				
Consumption Area or Number of seats				

This application is reviewed pursuant to Section 90-391 through 90-397 of the City of Key West Land Development Regulations (LDRs). The City's LDRs can be found in the Code of Ordinances online at [http://www.municode.com/Library/FL/Key\\_West](http://www.municode.com/Library/FL/Key_West) under Subpart B.

\*Please note, variances are reviewed as quasi-judicial hearings, and it is improper for the owner or applicant to speak to a Planning Board member or City Commissioner about the hearing.

Wallace  
3218 Riviera  
Dr

open space  
7800 66%  
~~7518~~ 34%  
~~2619~~

3698 Imp  
+ 1197 deck  
-----  
4895 covered  
2955 open  
-----  
38% open  
space

4845

Standards for Considering Variances

Before any variance may be granted, the Planning Board and/or Board of Adjustment must find all of the following requirements are met:

1. Existence of special conditions or circumstances. That special conditions and circumstances exist which are peculiar to the land, structure or building involved and which are not applicable to other land, structures or buildings in the same zoning district.

The 30' front setback for the main house prevents construction of the covered entryway per the planning department. Many of the neighboring homes have them.

2. Conditions not created by applicant. That the special conditions and circumstances do not result from the action or negligence of the applicant.

The covered entry way should not be a prohibited accessory structure for the front yard & does not seem to be the intent of Sec. 122-1181 in light of the ~~large~~ number of such structures throughout Key West.

3. Special privileges not conferred. That granting the variance(s) requested will not confer upon the applicant any special privileges denied by the land development regulations to other lands, buildings or structures in the same zoning district.

NO special privileges will be conferred as many similar or more extensive structures exist in this district, on this street, & on either side of the residence.

4. Hardship conditions exist. That literal interpretation of the provisions of the land development regulations would deprive the applicant of rights commonly enjoyed by other properties in this same zoning district under the terms of this ordinance and would work unnecessary and undue hardship on the applicant.

covered entry ways are common on Riviera Drive, & throughout Key West

5. Only minimum variance(s) granted. That the variance(s) granted is/are the minimum variance(s) that will make possible the reasonable use of the land, building or structure.

minimum is requested & is less than many of said structures throughout Key West.

City of Key West • Application for Variance

6. Not injurious to the public welfare. That granting of the variance(s) will be in harmony with the general intent and purpose of the land development regulations and that such variances will not be injurious to the area involved or otherwise detrimental to the public interest or welfare.

*The granting of the variance is in harmony with the intent & purpose of the L.D.R.'s*

7. Existing nonconforming uses of other property shall not be considered as the basis for approval. That no other nonconforming use of neighboring lands, structures, or buildings in the same district, and that no other permitted use of lands, structures or buildings in other districts shall be considered grounds for the issuance of a variance.

*NOT considered*

**The Planning Board and/or Board of Adjustment shall make factual findings regarding the following:**

- That the standards established in Section 90-395 have been met by the applicant for a variance.
- That the applicant has demonstrated a "good neighbor policy" by contacting or attempting to contact all noticed property owners who have objected to the variance application, and by addressing the objections expressed by these neighbors. Please describe how you have addressed the "good neighbor policy."

**REQUIRED SUBMITTALS: All of the following must be submitted in order to have a complete application. Please submit one paper copy and one electronic copy of all materials.**

- Correct application fee. Check may be payable to "City of Key West."
- Notarized verification form signed by property owner or the authorized representative.
- Notarized authorization form signed by property owner, if applicant is not the owner.
- Copy of recorded warranty deed
- Property record card
- Signed and sealed survey
- Site plan (plans MUST be signed and sealed by an Engineer or Architect)
- Floor plans
- Stormwater management plan

# Verification

**City of Key West  
Planning Department**



**Verification Form**  
*(Where Owner is the applicant)*

I George B. Wallace, being duly sworn, depose and say that I am the Owner (as appears on the deed), for the following property identified as the subject matter of this application:

3218 Riviera Dr., Key West

*Street address of subject property*

All of the answers to the above questions, drawings, plans and any other attached data which make up the application, are true and correct to the best of my knowledge and belief. In the event the City or the Planning Department relies on any representation herein which proves to be untrue or incorrect, any action or approval based on said representation shall be subject to revocation.

A handwritten signature in blue ink, appearing to read "George B. Wallace".

*Signature of Owner*

Subscribed and sworn to (or affirmed) before me on this August 29, 2016 by

*date*

George B. Wallace.

*Name of Owner*

He/She is personally known to me or has presented \_\_\_\_\_ as identification.

A handwritten signature in blue ink, appearing to read "Amanda Willett-Ramirez".

*Notary's Signature and Seal*



\_\_\_\_\_  
*Name of Acknowledger typed, printed or stamped*

\_\_\_\_\_  
*Commission Number, if any*

# Survey

# MAP OF BOUNDARY SURVEY LOTS 5 & 6, BLOCK 4 RIVIERA SHORES SUBDIVISION CANAL

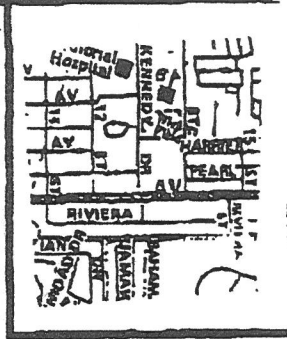

LOCATION MAP  
N.T.S.

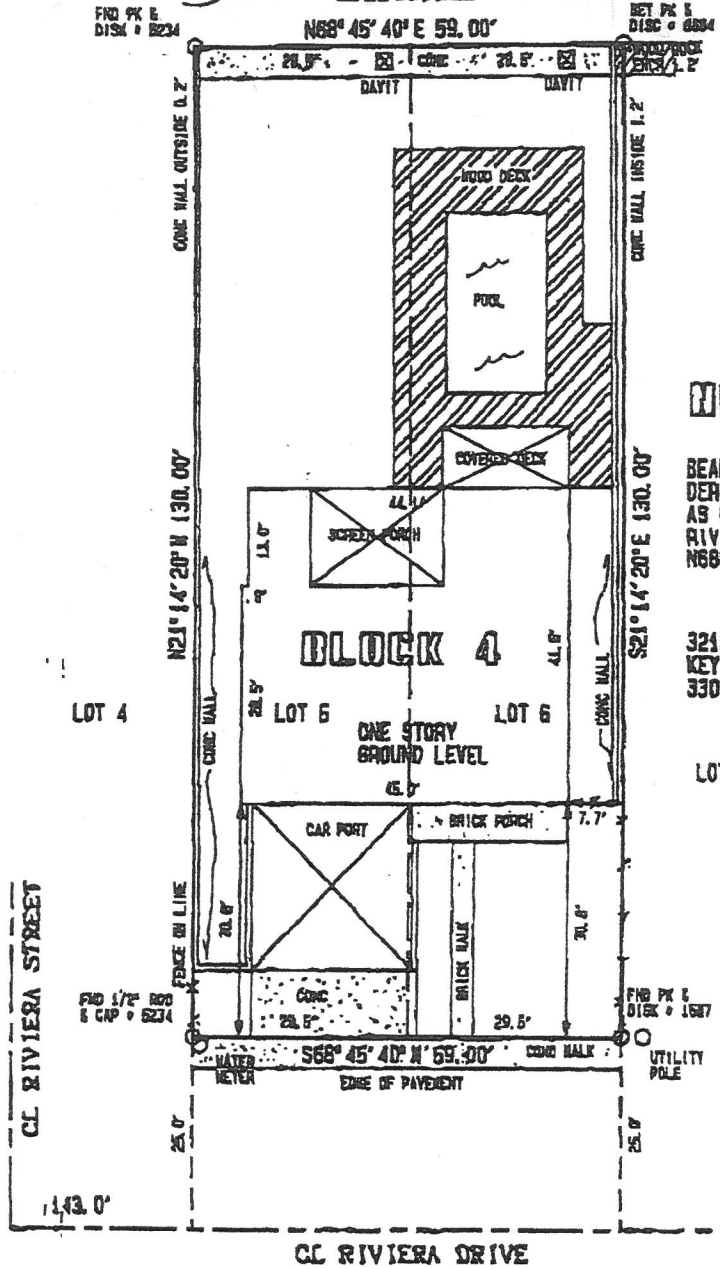

BEARING BASE:  
DERIVED FROM PLAT  
AS CENTERLINE OF  
RIVIERA DRIVE  
N68° 45' 40" E

3218 RIVIERA DRIVE  
KEY WEST, FL  
33040

LOT 7

NOTE: FOUNDATIONS BENEATH THE SURFACE ARE NOT SHOWN, MEASURED DIMENSIONS EQUAL PLATTED OR DESCRIBED DIMENSIONS UNLESS INDICATED OTHERWISE.

CONVEYED TO:  
**GEORGIA A. DELAIRE**  
NORTH AMERICAN MORTGAGE COMPANY, ITS SUCCESSORS  
AND/OR ASSIGNS  
**LYNNE HANKINS FIELDER, P.A.**  
ATTORNEYS TITLE INSURANCE FUND INC.

LEGAL DESCRIPTION  
Lots Five (5) and Six (6), Block Four (4), RIVIERA SHORES  
SUBDIVISION, a subdivision of a part of the City of Key West,  
Florida, between Eleventh Street and Seventeenth Street lying South  
of Flagler Street, Key West, Monroe County, Florida according to the  
plat thereof filed for record on the 18th day of April, 1936 and  
recorded in Plat Book 3, at Page 141 of the Public Records of Monroe  
County, Florida.

SCALE 1" = 20' DATE 10/10/98 BY 1/26/98	A - CENTER ANGLE ADM - ADMIT C - CENTER LINE CONC - CONCRETE CIRC - CURVED	DRAB - DRAPAGE EXHIBIT FL - FLAGLER FICR - FENCED FICR - FENCED FND - FOUND FV - FENCED	IP - IRON PIPE IS - IRON SIGN IS - IRON SIGN MS - METAL SIGN MS - METAL SIGN MS - METAL SIGN	PC - POINT OF CURVE PCC - POINT OF CURVE PCC - POINT OF CURVE PCC - POINT OF CURVE PCC - POINT OF CURVE PCC - POINT OF CURVE	POC - POINT OF COMMENCEMENT POC - POINT OF COMMENCEMENT POC - POINT OF COMMENCEMENT POC - POINT OF COMMENCEMENT POC - POINT OF COMMENCEMENT POC - POINT OF COMMENCEMENT	RI - RIVIERA RIV - RIVIERA RIV - RIVIERA RIV - RIVIERA RIV - RIVIERA RIV - RIVIERA
--	--	--	---	---	--	---

BOUNDARY SURVEY  
I HEREBY CERTIFY THAT THIS SURVEY WAS MADE UNDER MY RESPONSIBLE CHARGE AND MEETS  
THE MINIMUM TECHNICAL STANDARDS AS SET FORTH BY THE FLORIDA BOARD OF PROFESSIONAL  
SURVEYORS AND MAPPERS IN CHAPTER 61G17-4, FLORIDA ADMINISTRATIVE CODE, PURSUANT  
TO SECTION 472.027, FLORIDA STATUTES. THIS SURVEY, WHEN SCHEDULE 8 HAS BEEN PROVIDED  
MEETS THE PROVISIONS OF FLORIDA STATUTES, SECTION 61G17-4, SUBPARAGRAPH (1)(B), (RETRACTS).

**ROBERT E. REECE, P.A.**  
PROFESSIONAL SURVEYOR  
AND MAPPER

Site Plan  
See drawing

CL RIVIERA STREET

143.0'

FENCE ON LINE

25.0'

FIN 1/2" ROD  
CAP - 8234

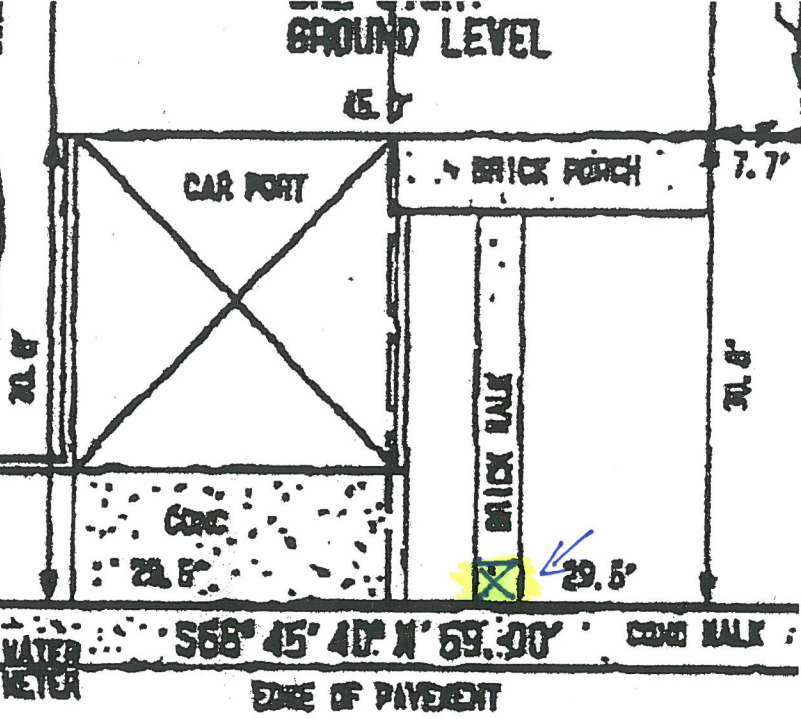

WATER METER  
568° 45' 40" N 69.00'  
EDGE OF PAVEMENT  
CONC WALK

CL RIVIERA DRIVE

NOTE: FOUNDATIONS BENEATH THE SURFACE ARE NOT SHOWN, MEASURED DIMENSIONS EQUAL PLATTED OR DESCRIBED

CONVEYED TO:  
**GEORGIA A. DELAIRE**  
**NORTH AMERICAN MORTGAGE COMPANY, ITS SUCCESSORS**  
**AND/OR ASSIGNS**  
**LYNNE HANKINS FIELDER, P.A.**  
**ATTORNEYS TITLE INSURANCE FUND INC.**

LEGAL DISC  
 Lot Five  
 SUBDIVIS  
 Florida, but  
 of Flagler S  
 plot thereo  
 recorded in  
 County, Fla

SCALE 1" = 20'	A - CENTER ANGLE ASPH - ASPHALT C - CENTER LINE CONC - CONCRETE CYCS - COYRTE	GRASS - DRAINAGE FACILITY IR - IRON ROD INCL - INCLINED INCS - INTERSECTION FND - FOUND FF - FINISHED FLOOR	Ø - HOLE PTH Ø - HOLE PDB I - ARC LENGTH M - M. ANGLE NVD - NATIONAL GRID/IC NUTCR - CURVE POINT	FC - POINT C FCC - POINT PC - POINT PT - POINT 1 P - POINT PDB - POINT
-------------------	---	--	---	---

DATE  
8/26/98  
DRAWN BY  
AS  
CHECKED BY

**BOUNDARY SURVEY**  
 I HEREBY CERTIFY THAT THIS SURVEY WAS MADE UNDER MY RESPONSIBLE CHARGE AND IN THE MINIMUM TECHNICAL STANDARDS AS SET FORTH BY THE FLORIDA BOARD OF PROFESSIONAL SURVEYORS AND MAPPERS IN CHAPTER 61G-4, FLORIDA ADMINISTRATIVE CODE, PURE TO SECTION 472.027, FLORIDA STATUTES, THIS SURVEY, WHEN SCHEDULE 9 HAS BEEN PROVIDED, MEETS THE PROVISIONS OF FLORIDA STATUTE, SECTION 6, SUBPARAGRAPH 1(B) (SETBACK



# Site Plan

R A D R.

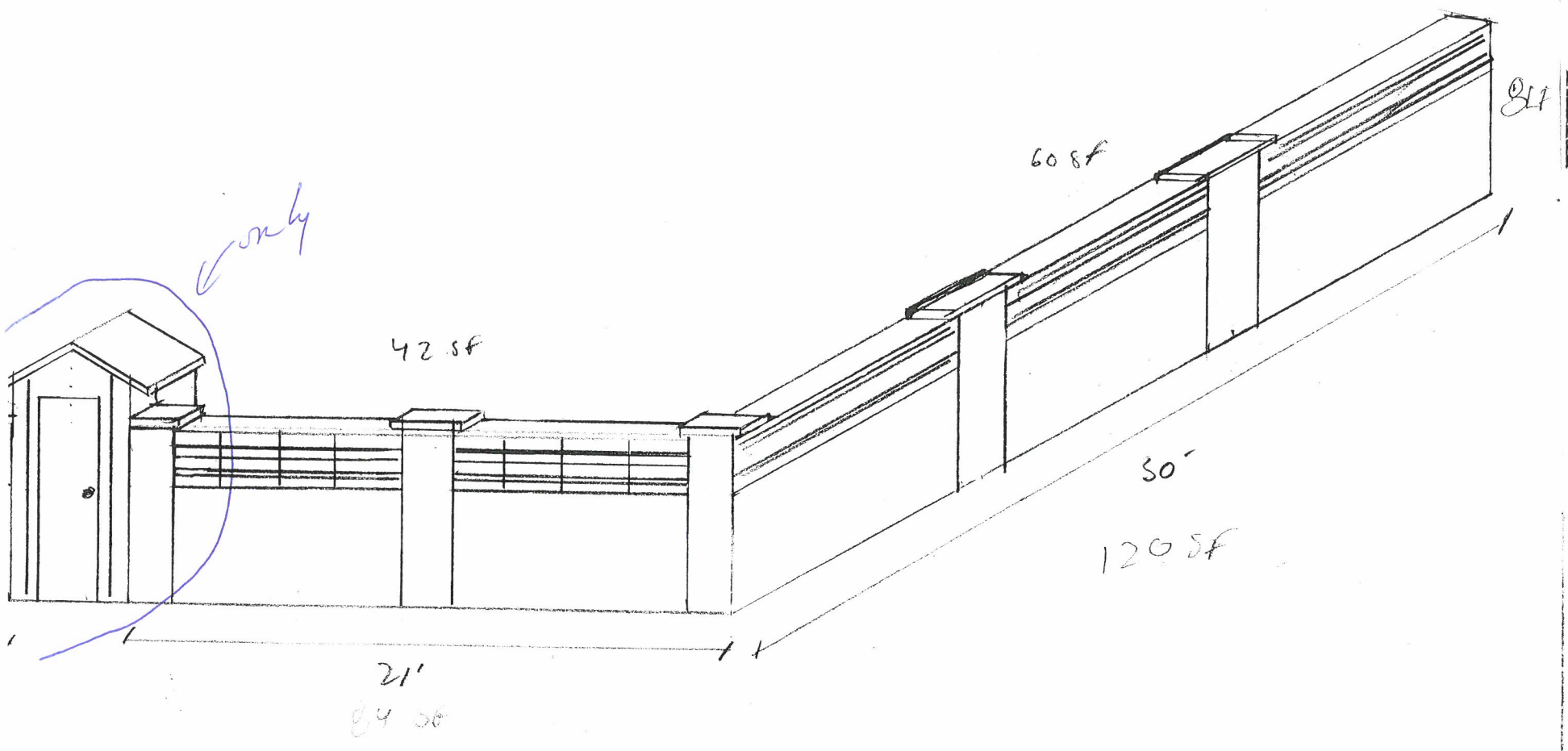

3218 RIVIE

3/16 scale

Regular Block SF 0.889 SF

Decorative block SF 1.78 SF

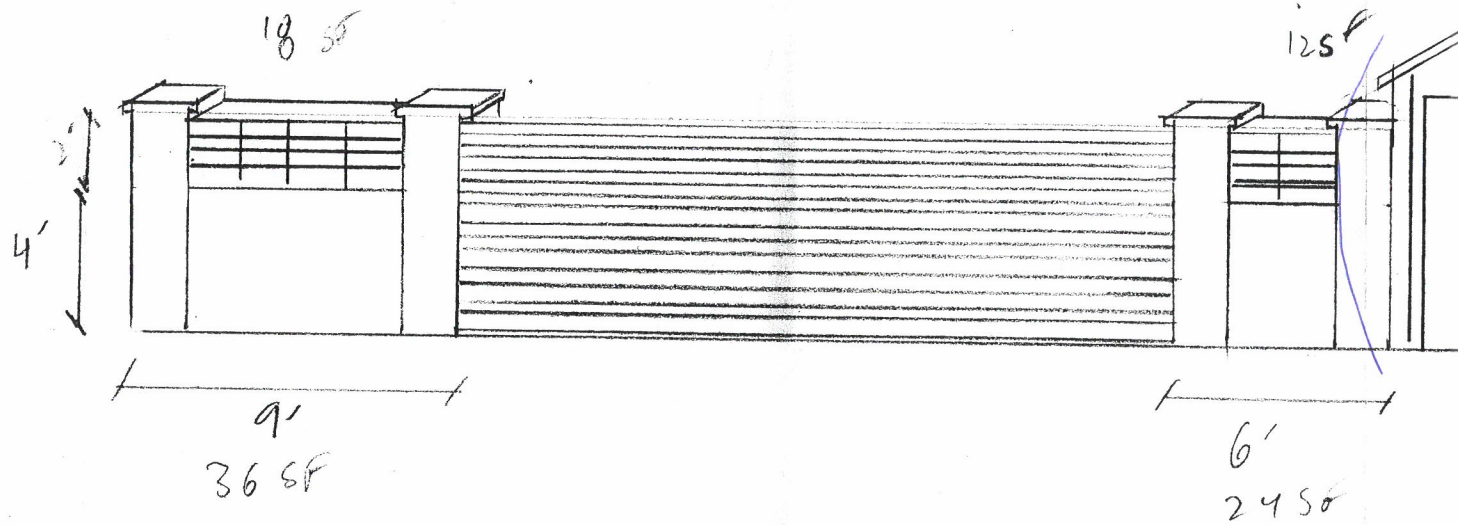

## **Site Photos**

3218 Riviera Drive, Key West, Florida  
SITE VISIT –OCTOBER 13, 2016



3218 Riviera Drive, Key West, Florida  
SITE VISIT –OCTOBER 13, 2016



3218 Riviera Drive, Key West, Florida  
SITE VISIT –OCTOBER 13, 2016



# **Property Appraiser**





**Scott P. Russell, CFA**  
**Property Appraiser**  
**Monroe County, Florida**

Key West (305) 292-3420  
Marathon (305) 289-2550  
Plantation Key (305) 852-7130

**Property Record Card -**

**Maps are now launching the new map application version.**

Website tested on IE8,  
IE9, & Firefox.  
Requires Adobe Flash  
10.3 or higher

Alternate Key: 1073351 Parcel ID: 00069470-000000

**Ownership Details**

**Mailing Address:**  
WALLACE GEORGE B AND JULIE A  
3218 RIVIERA DR  
KEY WEST, FL 33040-4662

**Property Details**

**PC Code:** 01 - SINGLE FAMILY  
**Millage Group:** 10KW  
**Affordable Housing:** No  
**Section-Township-Range:** 33-67-25  
**Property Location:** 3218 RIVIERA DR KEY WEST  
**Subdivision:** Riviera Shores Sub  
**Legal Description:** BK4 LTS 5 AND 6 RIVIERA SHORES SUBDIVISION PB3-148 OR591-46 OR860-559 OR1018-1128/29 OR1131-950 OR1198-1173/74 OR1536-682 OR1536-684 OR1712-1420 OR2546-1803/04 OR2652-179

Click Map Image to open interactive viewer

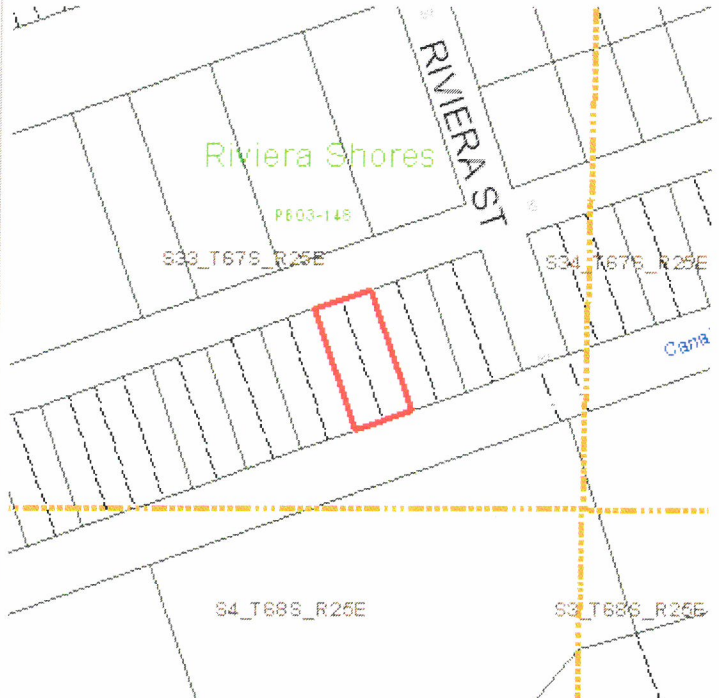

### Exemptions

Exemption	Amount
44 - ADDL HOMESTEAD	25,000.00
39 - 25000 HOMESTEAD	25,000.00

### Land Details

--

Land Use Code	Frontage	Depth	Land Area
010C - RESIDENTIAL CANAL	59	130	7,670.00 SF

## Building Summary

Number of Buildings: 1  
 Number of Commercial Buildings: 0  
 Total Living Area: 1598  
 Year Built: 1974

## Building 1 Details

Building Type R1  
 Effective Age 20  
 Year Built 1974  
 Functional Obs 0

Condition A  
 Perimeter 198  
 Special Arch 0  
 Economic Obs 0

Quality Grade 600  
 Depreciation % 27  
 Grnd Floor Area 1,598

Inclusions: R1 includes 1 3-fixture bath and 1 kitchen.

Roof Type GABLE/HIP

Roof Cover ASPHALT SHINGL

Foundation CONCR FTR

Heat 1 FCD/AIR DUCTED

Heat 2 NONE

Bedrooms 3

Heat Src 1 ELECTRIC

Heat Src 2 NONE

Extra Features:

2 Fix Bath 0  
 3 Fix Bath 1  
 4 Fix Bath 0  
 5 Fix Bath 0  
 6 Fix Bath 0  
 7 Fix Bath 0  
 Extra Fix 0

Vacuum 0  
 Garbage Disposal 0  
 Compactor 0  
 Security 0  
 Intercom 0  
 Fireplaces 0  
 Dishwasher 0

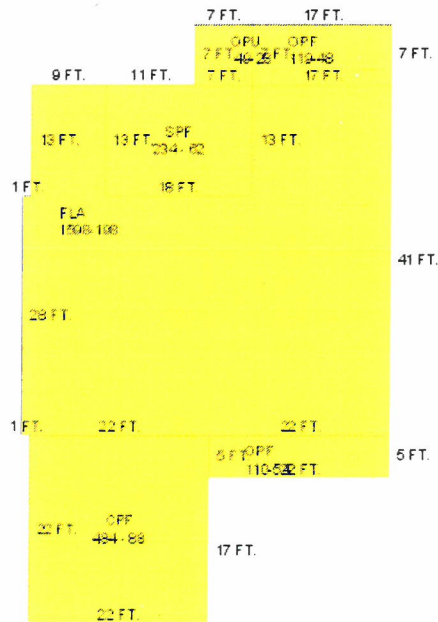

Sections:

Nbr	Type	Ext Wall	# Stories	Year Built	Attic	A/C	Basement %	Finished Basement %	Area
1	CPF	5:C.B.S.	1	1988	N	Y			484
2	OPF	5:C.B.S.	1	1988	N	Y	0.00	0.00	110
3	FLA	5:C.B.S.	1	1988	N	Y	0.00	0.00	1,598
4	SPF	5:C.B.S.	1	1988	N	Y			234
5	OPU	5:C.B.S.	1	1988	N	Y	0.00	0.00	49
6	OPF	5:C.B.S.	1	1988	N	Y	0.00	0.00	119

## Misc Improvement Details

Nbr	Type	# Units	Length	Width	Year Built	Roll Year	Grade	Life
1	WD2:WOOD DECK	690 SF	0	0	1987	1988	1	40
2	PO4:RES POOL	336 SF	24	14	1987	1988	3	50
3	PT3:PATIO	446 SF	0	0	1987	1988	2	50
4	DK3:CONCRETE DOCK	236 SF	59	4	1977	1978	4	60
5	SW2:SEAWALL	177 SF	59	3	1974	1975	2	60
6	FN2:FENCES	1,356 SF	226	6	1984	1985	4	30
7	DAV:CONC DAVITS	1 UT	0	0	2012	2013	1	60
8	BL2:BOAT LIFT	1 UT	0	0	2013	2014	3	20

## Appraiser Notes

--

## Building Permits

Bldg Number	Date Issued	Date Completed	Amount	Description	Notes
1	09-0350	02/12/2009	12/31/2012	17,379 Residential	AIRPORT PROJECT; INSTALL 12 WINDOWS 5 DOORS 16 HURRICANE SHUTTERS
1	09-0351	02/11/2009	12/31/2012	2,000 Residential	AIRPORT PROJECT; INSTALL NEW ELECTRIC
1	09-0380	02/13/2009	06/07/2013	5,800 Residential	REPLACE AC UNIT ADD 4 RETURNS
1	12-3832	10/23/2012	06/07/2013	1,500 Residential	REAR PORCH COVERED WITH WHITE CLASS A STORM SMART HURRICANE SCREEN
1	13-1235	04/03/2013	06/07/2013	2,300 Residential	FRAMING ONLY FOR TIKI HUT.
1	13-1980	05/06/2013	06/07/2013	2,000 Residential	REPAIR 3 POST (4 X 4) & REPLACE WITH 6 X 5 WOOD POST ON PORCH. FORM & POUR 10' X 20' CONCRETE SLAB UNDER EXISTING TIKI HUT.
1	13-2236	05/29/2013	01/02/2014	10,000 Residential	INSTALL 10 K BOAT LIFT
	14-1580	04/22/2014	07/18/2014	6,895	INSTALL 900 SF OF 60 MIL TPO SINGLE PLY ON THE TWO FLAT ROOFS.
	14-5086	11/05/2014	01/09/2015	14,000	REPLACE DAMAGED DRYWALL APPROX. 24" HIGH THROUGHOUT THE HOME, BASE BOARDS, 10 INTERIOR DOORS, PAINT WALLS 1000 SQ/FT
1	9701095	04/01/1997	07/01/1997	1,306 Residential	20 SQS ASP SHINGLE ROOF

## Parcel Value History

Certified Roll Values.

[View Taxes for this Parcel.](#)

Roll Year	Total Bldg Value	Total Misc Improvement Value	Total Land Value	Total Just (Market) Value	Total Assessed Value	School Exempt Value	School Taxable Value
2016	197,496	46,151	465,285	708,932	559,598	25,000	534,598
2015	196,901	41,823	385,063	623,787	555,708	25,000	530,708
2014	189,494	40,013	342,278	571,785	551,298	25,000	526,298
2013	194,481	30,802	189,726	415,009	415,009	0	415,009
2012	205,223	26,437	210,807	442,467	442,467	0	442,467
2011	151,562	27,267	195,438	374,267	247,370	25,000	222,370
2010	153,697	28,150	132,750	314,597	243,714	25,000	218,714
2009	171,243	28,973	354,000	554,216	237,307	25,000	212,307
2008	159,941	29,855	590,000	779,796	237,070	25,000	212,070
2007	212,335	25,669	590,000	828,004	183,604	25,000	158,604
2006	199,859	25,312	427,750	652,921	179,126	25,000	154,126
2005	240,023	26,026	331,875	597,924	218,011	25,000	193,011
2004	201,456	26,694	206,500	434,650	211,661	25,000	186,661
2003	185,340	27,347	184,375	397,062	207,715	25,000	182,715
2002	224,959	28,401	118,000	371,360	202,847	25,000	177,847
2001	187,444	29,631	118,000	335,075	199,653	25,000	174,653
2000	184,036	23,881	90,344	298,261	193,838	25,000	168,838
1999	161,032	21,586	90,344	272,961	188,742	25,000	163,742
1998	144,843	20,055	84,813	249,711	185,770	25,000	160,770
1997	136,323	19,422	70,063	225,809	182,665	25,000	157,665
1996	106,502	15,611	70,063	192,177	177,345	25,000	152,345
1995	95,426	14,427	70,063	179,916	173,020	25,000	148,020
1994	85,202	13,207	70,063	168,472	168,472	25,000	143,472
1993	83,611	13,574	70,063	167,248	167,248	25,000	142,248
1992	83,611	13,949	70,063	167,623	167,623	25,000	142,623
1991	83,611	14,291	70,063	167,965	167,965	25,000	142,965
1990	83,611	14,640	64,531	162,782	162,782	25,000	137,782
1989	83,611	15,033	64,531	163,175	163,175	25,000	138,175
1988	75,877	1,653	55,313	132,843	132,843	25,000	107,843
1987	74,998	1,653	37,244	113,895	113,895	25,000	88,895
1986	75,306	1,653	35,400	112,359	112,359	25,000	87,359
1985	72,688	1,653	29,721	104,062	104,062	25,000	79,062
1984	68,332	1,653	29,721	99,706	99,706	0	99,706
1983	68,332	1,653	29,721	99,706	99,706	0	99,706
1982	54,679	1,653	24,796	81,128	81,128	0	81,128

## Parcel Sales History

NOTE: Sales do not generally show up in our computer system until about two to three months after the date of sale. If a recent sale does not show up in this list, please allow more time for the sale record to be processed. Thank you for your patience and understanding.

Sale Date	Official Records Book/Page	Price	Instrument	Qualification
9/30/2013	2652 / 179	157,500	QC	11
12/14/2011	2546 / 1803	615,000	WD	01
1/1/1992	1198 / 1173	225,000	WD	Q
6/1/1987	1018 / 1128	170,000	WD	Q
7/1/1982	860 / 559	130,000	WD	Q
2/1/1974	591 / 46	53,700	00	Q

This page has been visited 254,306 times.

Monroe County Property Appraiser  
Scott P. Russell, CFA  
P.O. Box 1176 Key West, FL 33041-1176

## **Additional Information**

