

**CONTRACT DOCUMENTS FOR:**



---

**ITB #24-009  
FIRE PUMPS REPLACEMENT  
KEY WEST HISTORIC SEAPORT  
CITY MARINA @ GARRISON BIGHT**

**MARCH 2024**

---

**MAYOR: TERI JOHNSTON**

**COMMISSIONERS:**

**JIMMY WEEKLEY**

**SAMUEL KAUFMAN**

**BILLY WARDLOW**

**GREGORY DAVILA**

**MARY LOU HOOVER**

**CLAYTON LOPEZ**

**PREPARED BY:  
Port & Marine Services**

CITY OF KEY WEST  
&  
CAROLINE STREET AND BAHAMA VILLAGE COMMUNITY  
REDEVELOPMENT AGENCY (CRA)  
KEY WEST, FLORIDA

CONTRACT DOCUMENTS

for

FIRE PUMPS REPLACEMENT  
KEY WEST HISTORIC SEAPORT  
CIT MARINA @ GARRISON BIGHT

\*\*\*\*

CONSISTING OF:  
BID REQUIREMENTS  
CONTRACT FORMS  
CONDITIONS OF THE CONTRACT  
SCOPE OF WORK  
SPECIFICATIONS  
SUPPLEMENTAL INFORMATION

\*\*\*\*

KEY WEST, FLORIDA

March 2024

Table of Contents

	<u>Page No.</u>
<b>PART 1 - <u>BIDDING REQUIREMENTS</u></b>	
INVITATION TO BID .....	6
INSTRUCTIONS TO BIDDER .....	8
BID FORMS .....	15
FLORIDA BID BOND .....	27
ANTI – KICKBACK AFFIDAVIT.....	29
FLORIDA STATUTES, ON PUBLIC ENTITY CRIMES.....	30
INDEMNIFICATION FORM.....	32
DOMESTIC PARTNERSHIP AFFIDAVIT.....	33
CONE OF SILENCE AFFIDAVIT.....	34
NON-COLLUSION AFFIDAVIT.....	35
LOCAL VENDORS FORM .....	36
SCRUTINIZED COMPANIES LIST CERTIFICATION .....	37
BIDDER'S CHECKLIST .....	39
<b>PART 2 - <u>CONTRACT</u></b>	
DRAFT CONTRACT .....	40
FLORIDA PERFORMANCE BOND .....	42
FLORIDA PAYMENT BOND .....	44
<b>PART 3 - <u>CONDITIONS OF THE CONTRACT</u></b>	
GENERAL CONDITIONS OF THE CONTRACT.....	48
SUPPLEMENTARY CONDITIONS.....	66
<b>PART 4 - <u>GENERAL SPECIFICATIONS</u></b>	
01001 GENERAL REQUIREMENTS.....	77
01010 SCOPE OF WORK.....	85
01014 ENVIRONMENTAL PROTECTION.....	88
01050 FIELD ENGINEERING.....	90
01300 SUBMITTALS.....	92
01500 BARRIERS.....	95
01700 CONTRACT CLOSEOUT.....	97
<b>PART 5 - <u>SUPPLEMENTAL INFORMATION</u>.....</b>	<b>100</b>
LOCATION MAP	
PUMP #1 - KEY WEST BIGHT FERRY TERMINAL - REQUIREMENTS AND SPECIFICATIONS	
PUMP #2 – KEY WEST BIGHT – MARGARET STREET - REQUIREMENTS AND SPECIFICATIONS	
PUMP #3 – CITY MARINA @ GARRISON BIGHT – WEST - REQUIREMENTS AND SPECIFICATIONS	
PUMP #4 – CITY MARINA @ GARRISON BIGHT – EAST - REQUIREMENTS AND SPECIFICATIONS	

---

**PART 1**  
**BIDDING REQUIREMENTS**

---





## INVITATION TO BID

Sealed bids for the City of Key West & City of Key West Caroline Street and Bahama Village Community Redevelopment Agency (CRA) **ITB #24-009 FIRE PUMPS REPLACEMENT, KEY WEST HISTORIC SEAPORT & CITY MARINA @ GARRISON BIGHT**, addressed to the City of Key West, will be received at the Office of the City Clerk, 1300 White St., Key West Florida, 33040 until **3:30 pm on May 2, 2024** and then will be publicly opened and read. Any bids received after the time and date specified will not be considered.

**Please submit one (1) original bid package and two (2) electronic copies on USB drives with a single PDF file of the entire bid package.** Bid package is to be enclosed in a sealed envelope, clearly marked on the outside **“FIRE PUMPS REPLACEMENT, KEY WEST HISTORIC SEAPORT & CITY MARINA @ GARRISON BIGHT - ITB 24-009”** addressed and delivered to the City Clerk at the address noted above.

The project consists of the removal and replacement of four (4) fire pumps with controller, four (4) jockey pumps with controller in existing locations with existing backflows at Key West Historic Seaport (2 locations) and City Marina @ Garrison Bight (2 locations) as per the Scope of Work and Supplemental Information supplied in this document.

The full Invitation to Bid may be obtained from Demand Star by Onvia and The City of Key West website. Please contact Demand Star at [www.demandstar.com](http://www.demandstar.com) or call 1-800-711-1712 or [www.cityofkeywest-fl.gov](http://www.cityofkeywest-fl.gov)

**A Mandatory pre-bid meeting** will be held in the conference room at the KWHS Port and Marine Services Offices, 201 William Street, Key West, Florida on **April 18, 2024 at 2:30 p.m.**

**EACH BID MUST BE SUBMITTED ON THE PRESCRIBED FORM AND ACCOMPANIED BY BID SECURITY AS PRESCRIBED IN THE INSTRUCTIONS TO BIDDERS, PAYABLE TO THE CITY OF KEY WEST, FLORIDA, IN AN AMOUNT NOT LESS THAN FIVE (5) PERCENT OF THE AMOUNT BID.**

**THE BIDDER MUST BE A LICENSED CONTRACTOR BY THE STATE OF FLORIDA AND SUBMIT PROOF OF SUCH WITH THE BID.**

The Bidder shall furnish documentation showing that they are in compliance with the licensing requirements of the State and the provisions of Chapter 66 Section 87 of the Code of Ordinances of the City of Key West; within 10 days the following the Notice of Award and must demonstrate that he holds at a minimum, the following licenses & certificates;

- A. City of Key West License, as defined in Code of Ordinances, Chapter 66, enabling the Contractor to perform the work stated herein.
- B. City of Key West Business Tax License Receipt

All bid bonds, contract bonds, insurance contracts, and certificates of insurance shall be either executed by or countersigned by a licensed resident agent of the Surety or Insurance Company having his place of business in the State of Florida, and in all ways complying with the insurance laws of the State of Florida. Further, the said Surety or Insurance Company shall be duly licensed and qualified to do business in the State of Florida.

Before a Contract will be awarded for the work contemplated herein, the City of Key West & CRA will conduct such investigation as is necessary to determine the performance record and ability of the apparent low Bidder to perform the size and type of work specified under this Contract. Upon request, the Bidder shall submit such information as deemed necessary by the City of Key West & CRA to evaluate the Bidder's qualifications.

The City of Key West & CRA hereby notifies all Bidders that it will affirmatively ensure that in any contract entered into pursuant to this advertisement, Disadvantaged Business Enterprise will be afforded full opportunity to submit bids in response to this invitation and will not be discriminated against on the grounds of race, color, gender, religion, age, disability, marital status or national origin in consideration for an award.

For information concerning the proposed work please contact **Karen Olson, Deputy Director, Port and Marine Services by email at [kolson@cityofkeywest-fl.gov](mailto:kolson@cityofkeywest-fl.gov)**. Verbal communications, per the City's "Cone of Silence" ordinance are not allowed.

As stated above at the time of the BID submittal the Bidder must provide satisfactory documentation of State Licenses. The Bidder shall furnish documentation showing that he is in compliance with the licensing requirements of County, and City licenses as would be required within ten days of the award. The successful Bidder must also be able to satisfy the City Attorney as to such insurance coverage and legal requirements as may be demanded by the Proposal in question. The City of Key West & CRA may reject BID for any and/or all of the following reasons: (1) for budgetary reasons, (2) if the proposer misstates or conceals a material fact in its bid, (3) if the proposal does not strictly conform to the law or is non-responsive to the bid requirements, (4) if the proposal is conditional, or (5) if a change of circumstances occurs making the purpose of the proposal unnecessary to the CRA. (6) if such rejection is in the best interest of the City of Key West & CRA. The City of Key West & CRA may also waive any minor formalities or irregularities in any proposal.

The City of Key West & CRA retains the right to award bid to the bidder that best meets the needs of the City.

\* \* \* \* \*

## INSTRUCTIONS TO BIDDERS

### 1. CONTRACT DOCUMENTS

#### A. FORMAT

The Contract Documents are divided into parts, divisions, and sections for convenient organization and reference. Generally, there has been no attempt to divide the Specification sections into work performed by the various building trades, work by separate subcontractors, or work required for separate facilities in the Project.

#### B. DOCUMENT INTERPRETATION

Separate sections contained within these Contract Documents are intended to be mutually cooperative and provide all details reasonably required for the execution of proposed work.

Should there be any doubt as to the meaning or intent of said Contract Documents, the Bidder should request of the Deputy Port and Marine Services Director, in writing (at least 8 calendar days prior to Bid opening (no later than April 24, 2024)) an interpretation thereof. Any interpretation or change in said Contract Documents will be made only in writing in the form of Addenda to the Documents, which will be furnished to all registered holders of Contract Documents. Bidders shall submit with their Bids or indicate receipt of all Addenda. The Owner will not be responsible for any other explanation or interpretations of said Documents.

### 2. SCOPE OF SERVICES

A general description of the work to be done is contained in the Scope of Work section.

### 3. REQUIRED QUALIFICATIONS

The prospective Proposers must meet the statutorily prescribed requirements before award of Contract by the City of Key & CRA. Proposers must hold or obtain all licenses and/or certificates as required by the State and Local Statutes in order to bid and perform the work specified herein.

### 4. BIDDER'S UNDERSTANDING

Each Proposer must inform himself of the conditions relating to the execution of the work and make himself thoroughly familiar with all the Contract Documents. Failure to do so will not relieve the successful Proposer of his obligation to enter into a Contract and complete the contemplated work in strict accordance with the Contract Documents.

Each Proposer shall inform himself of, and the Proposer awarded a Contract shall comply with, federal, state, and local laws, statutes, and ordinances relative to the execution of the work. This requirement includes, but is not limited to, applicable regulations concerning minimum wage rates, nondiscrimination in the employment of labor, protection of public and employee safety and health, environmental protection, the protection of natural resources, fire protection, permits, fees, and similar subjects.

5. TYPE OF BID  
UNIT PRICE

The Proposal for the work is to be submitted on a unit price basis. All items required to complete the work specified ~~or shown on the Drawings~~ but not included in the Proposal shall be considered incidental to those set forth in the Proposal. Payment to the Contractor will be made on the measurement of the work actually performed by the Contractor, as specified in the Contract Documents.

The Bidder further proposes to accept as full payment for the Work proposed herein, the amounts computed under the provisions of the Contract Documents and based on the following unit price amounts. The Bidder agrees that the unit prices include all allowances for overhead and profit for each type and unit of work called for in these Contract Documents.

Total allowable cost for Mobilization, General/Supp Conditions and Demobilization (bid schedule line item 1) shall be **10% maximum of total construction costs (bid schedule line items 4 through 8)**.

6. PREPARATION OF BIDS

A. GENERAL

All blank spaces in the BID form must be filled in for all schedules and associated parts, as required, preferably in BLACK INK. All price information shall be clearly shown in both words and figures where required. No changes shall be made in the phraseology of the forms. Written amounts shall govern in case of discrepancy between the amounts stated in writing and the amounts stated in figures. In case of discrepancy between unit prices and extended totals, unit prices shall prevail.

Any BID shall be deemed informal which contains omissions, erasures, alterations, or additions of any kind, or prices uncalled for, or in which any of the prices are obviously unbalanced, or which in any manner shall fail to conform to the conditions of the published Invitation to BID.

Only one BID from any individual, firm, partnership, or corporation, under the same or different names, will be considered. Should it appear to the Owner that any Bidder is interested in more than one BID for work contemplated, all Bids in which such Bidder is interested will be rejected.

B. DESCRIPTION OF SUPPLIERS

Any manufacturer's name, trade name, brand name, or catalog number used in the specifications is for the purpose of describing and establishing general quality levels. SUCH REFERENCES ARE NOT INTENDED TO BE RESTRICTIVE. Bids will be considered for any brand which meets the quality of the specifications for any item.

C. SIGNATURE

The Bidder shall sign his BID in the blank space provided therefore. If Bidder is a corporation, the legal name of the corporation shall be set forth above together with the signature of the officer or officers authorized to sign Contracts on behalf of the corporation. If Bidder is a partnership, the true name of the firm shall be set forth above together with the signature of the partner or partners authorized to sign Contracts on behalf of the partnership. If signature is by an agent, other than an officer of a corporation or a member of a partnership, a notarized power-of-attorney must be on file with the Owner prior to opening of Bids or submitted with the Bid otherwise the Bid will be regarded as not properly authorized.

D. SPECIAL BIDDING REQUIREMENTS

The Bidder's attention is brought to the hiring practices and licenses and permits of the City of Key West. These are defined in addition to Article 39, ORDINANCES, PERMITS, AND LICENSES, as set forth in the Supplementary Conditions.

The Bidder shall submit with his Bid his experience record showing his experience and expertise in fire pump system installation. Such experience record shall provide at least five current or recent projects of similar work, not more than 5 years old within the State Florida and preferably Monroe County. For each project the following information shall be provided:

- i. Description and location of work.
- ii. Contract amount.
- iii. Dates work was performed.
- iv. Owner.
- v. Name of Owner's contact person and phone number.
- vi. Engineer.
- vii. Name of Engineer's contact person and phone number.

The bidder shall submit at least 3 references from the above work experience.

The bidder shall submit with his bid a list of items to be performed by his own labor and that performed by subcontractors or others.

E. ATTACHMENTS

Bidder shall complete and submit the following forms with his bid:

1. Anti-Kickback Affidavit
2. Public Entity Crimes Form
3. City of Key West Indemnification Form
4. Equal Benefits for Domestic Partners Affidavit
5. Cone of Silence
6. Non-Collusion Affidavit
7. Local Vendor Certification
8. Scrutinized Companies List Certification
9. Bidders Checklist
10. Proof of Required Insurance

F. CITY OF KEY WEST LICENSE REQUIRED

Contractors are required to have a Certified or Registered General Contractors City of Key West license. License fees not to exceed \$410.00. License shall be obtained within ten (10) days of Notice of Award.

7. STATE AND LOCAL SALES AND USE TAXES

Unless the Supplementary Conditions contains a statement that the CITY is exempt from state sales tax on materials incorporated into the work due to the qualification of the work under this Contract, all state and local sales and use taxes as required by the laws and statutes of the state and its political subdivisions shall be paid by the Contractor. Prices quoted in the Bid shall include all nonexempt sales and use taxes, unless provision is made in the Bid form to separately itemize the tax.

8. SUBMISSION OF BID

All BIDS must be submitted no later than the time prescribed, at the place, and in the manner set forth in the Invitation to Bid. Bids must be made on the Bid forms provided herewith **submit one (1) ORIGINAL bid package and two (2) FLASH DRIVES containing a single PDF file of the entire bid package.**

Each Bid must be submitted in a sealed envelope, so marked as to indicate the Bidder's name and its contents without being opened and addressed in conformance with the instructions in the Invitation to Bid.

9. MODIFICATION OR WITHDRAWAL OF BID

Prior to the time and date designated for receipt of Bids, any Bid submitted may be withdrawn by notice to the party receiving Bids at the place designated for receipt of Bids. Such notice shall be in writing over the signature of the Bidder or by telegram. If by telegram, written confirmation over the signature of the Bidder shall be mailed and postmarked on or before the date and time set for receipt of Bids. No Bid may be withdrawn after the time scheduled for opening of Bids unless the time specified in paragraph AWARD OF CONTRACT of these Instructions to Bidders shall have elapsed.

10. BID SECURITY

BIDS must be accompanied by cash, a certified check, or cashier's check drawn on a bank in good standing, or a bid bond issued by a Surety authorized to issue such bonds in the state where the work is located, in the amount of five (5) percent of the total amount of the Proposal submitted. This bid security shall be given as a guarantee that the Bidder will not withdraw his BID for a period of ninety (90) days after bid opening, and that if awarded the Contract, the successful Bidder will execute the attached Contract and furnish properly executed Performance and Payment Bonds, each in the full amount of the Contract price within the time specified. Agent and Surety phone numbers must be provided.

The Attorney-in-Fact who executes this bond in behalf of the Surety must attach a notarized copy of his power-of-attorney as evidence of his authority to bind the Surety on the date of execution of the bond. Where State Statute requires, certification by a resident agent shall also be provided.

If the Bidder elects to furnish a Bid Bond, he shall use the Bid Bond form bound herewith,

or one conforming substantially thereto in form and content.

11. RETURN OF BID SECURITY

Within 15 days after the award of the Contract, the CITY will return the bid securities to all Bidders whose BIDS are not to be further considered in awarding the Contract. Retained bid securities will be held until the Contract has been finally executed, after which all bid securities, other than Bidders' bonds and any guarantees, which have been forfeited, will be returned to the respective Bidders whose Proposals they accompanied.

12. AWARD OF CONTRACT

The Award will be made under one Contract by the Owner on the basis of the Bid from the lowest, responsive, responsible Bidder. The Owner may award entire Bid or selected line items based on the City of Key West & CRA's best interest and available funds at time of Award.

Within 90 calendar days after the opening of Bids, the Owner will accept one of the Bids or will act in accordance with the following paragraphs. The acceptance of the Bid will be by written notice of award, mailed to the office designated in the Bid, or delivered to the Bidder's representative. In the event of failure of the lowest responsive, responsible Bidder to sign the Contract and provide an acceptable Performance Bond, Payment Bond, insurance certificate(s) and evidence of holding required licenses and certificates, the Owner may award the Contract to the next lowest responsive, responsible Bidder. Such award, if made, will be made within 120 days after the opening of Bids. Bidders will guarantee their Bid price(s) for up to 120 calendar days after Bid opening.

The City of Key West & CRA reserves the right to accept or reject any or all Bids and to waive any formalities and irregularities in said Bids.

13. BASIS OF AWARD

The award will be made by the Owner on the basis of the BID from the lowest, responsive, responsible BIDDER which, in the Owner's sole and absolute judgment will best serve the interest of the Owner.

14. EXECUTION OF CONTRACT

The successful Bidder shall, within 10 working days after receiving Notice of Award, sign and deliver to the Owner a Contract in the form hereto attached together with the insurance certificate examples of the bonds as required in the Contract Documents and evidence of holding required licenses and certificates. Within 10 working days after receiving the signed Contract from the successful Bidder, the Owner's authorized agent will sign the Contract. Signature by both parties constitutes execution of the Contract.

15. CONTRACT BONDS

A. PERFORMANCE AND PAYMENT BONDS

The successful Bidder shall file with the CITY, at the time of delivery of the signed Contract, a Performance Bond and Payment Bond on the form bound herewith, each in the full amount of the Contract price in accordance with the requirements of



Florida Statutes Section 255.05 or 713.23, as applicable, as security for the faithful performance of the Contract and the payment of all persons supplying labor and materials for the construction of the work, and to cover all guarantees against defective workmanship or materials, or both, during the warranty period following the date of final acceptance of the work by the CITY. The Surety furnishing this bond shall have a sound financial standing and a record of service satisfactory to the CITY, shall be authorized to do business in the State of Florida, and shall be listed on the current U.S. Department of Treasury Circular Number 570, or amendments thereto in the Federal Register, of acceptable Sureties for federal projects. The CONTRACTOR shall supply the OWNER with phone numbers, addresses, and contacts for the Surety and their agents. Pursuant to Section 255.05(7), Florida Statutes, in lieu of the bond required by law, the contractor may file with the city an alternative form of security in the form of cash, a money order, a certified check, a cashier's check or an irrevocable letter of credit.

G. POWER-OF-ATTORNEY

The Attorney-in-Fact (Resident Agent) who executes this Performance and Payment Bond in behalf of the Surety must attach a notarized copy of his power-of-attorney as evidence of his authority to bind the Surety on the date of execution of the bond. All Contracts, Performance and Payment Bonds, and respective powers-of-attorney will have the same date.

16. FAILURE TO EXECUTE CONTRACT AND FURNISH BOND

The Bidder who has a Contract awarded to him and who fails to promptly and properly execute the Contract or furnish the required Bonds shall forfeit the bid security that accompanied his bid, and the bid security shall be retained as liquidated damages by the CITY, and it is agreed that this said sum is a fair estimate of the amount of damages the CITY will sustain in case the Bidder fails to enter into a Contract or furnish the required Bonds. Bid security deposited in the form of cash, a certified check, or cashier's check shall be subject to the same requirement as a Bid Bond.

17. TIME OF COMPLETION

The time of completion of the work to be performed under this Contract is the essence of the Contract. Delays and extensions of time may only be allowed in accordance with the provisions stated in the General Conditions. Time allowed for completion of the work authorized is stated in Bid.

When the Contractor receives a Notice to Proceed, he shall commence work as soon as possible and shall complete all work within the number of calendar days stipulated in the Contract.

The term of this contract will be one hundred-twenty (120) calendar days.

18. PUBLIC RECORDS REQUIREMENTS

In addition to other contract requirements provided by law, each public agency contract for services must include a provision that requires the contractor to comply with public records laws, specifically to (a) keep and maintain public records that ordinarily and necessarily would be required by the public agency in order to perform the service; (b) provide the public with access to public records on the same terms and conditions that the public agency would provide the records and at a cost that does not exceed the cost provided in this chapter or as otherwise provided by law; (c) ensure that public records that are exempt or confidential and exempt from public records disclosure requirements are not disclosed except as authorized by law; and (d) meet all requirements for retaining public records and transfer, at no cost, to the public agency all public records in possession of the contractor upon termination of the contract and destroy any duplicate public records that exempt or confidential and exempt from public records disclosure requirements. All records stored electronically must be provided to the public agency in a format that is compatible with the information technology systems of the public agency. If a contractor does not comply with a public records request, the public agency shall enforce the contract provisions in accordance with the contract.

19. PERMITS AND FEES

The Bidder awarded this project shall procure and pay all permits and licenses, charges, and fees, and give notices necessary and incidental to the due and lawful prosecution of the work, the cost of which shall be included in the fee received for the work, except where separately agreed.

20. BIDDER'S DECLARATION AND UNDERSTANDING

The undersigned, hereinafter called the Bidder, declares that the only persons or parties interested in this Bid are those named herein, that this Bid is, in all respects, fair and without fraud, that it is made without collusion with any official of the Owner, and that the Bid is made without any connection or collusion with any person submitting another Bid on this Contract.

The Bidder further declares that he has carefully examined the Contract Documents and that this Bid is made according to the provisions and under the terms of the Contract Documents, which Documents are hereby made a part of this Bid.

21. SALES AND USE TAXES

The Bidder agrees that all federal, state, and local sales and use taxes are included in the stated unit prices for the work.

\* \* \* \* \*



**BID FORM**

To: City of Key West, Florida  
Address: 1300 White Street, Key West, Florida 33040  
Project Title: **FIRE PUMPS REPLACEMENT  
KEY WEST HISTORIC SEAPORT  
CITY MARINA @ GARRISON BIGHT**  
Project No.: **ITB #24-009**

Bidder's person to contact for additional information on this Bid:

Company Name: FLORIDA KEYS FIRE PROTECTION INC  
Contact Name & Telephone #: JAMES BOGUEFF 305 509 2409  
Email Address: FLORIDA KEYS FIRE @ GMAIL.COM

**BIDDER'S DECLARATION AND UNDERSTANDING**

The undersigned, hereinafter called the Bidder, declares that the only persons or parties interested in this Bid are those named herein, that this Bid is, in all respects, fair and without fraud, that it is made without collusion with any official of the Owner, and that the Bid is made without any connection or collusion with any person submitting another Bid on this Contract.

The Bidder further declares that he has carefully examined the Contract Documents, that he has personally inspected the Project, that he has satisfied himself as to the quantities involved, including materials and equipment, and conditions of work involved, including the fact that the description of the quantities of work and materials, as included herein, is brief and is intended only to indicate the general nature of the work and to identify the said quantities with the detailed requirements of the Contract Documents, and that this Bid is made according to the provisions and under the terms of the Contract Documents, which Documents are hereby made a part of this Proposal.

The Bidder further agrees that the Owner may "non-perform" the work in the event that the low bid is in excess of available funding. Non-performance will be determined prior to Notice of Award.

The intent of the Bid Documents is to describe a functionally complete project (or part thereof) to be constructed in accordance with the Contract Documents. Any work, materials, or equipment that may reasonably be inferred from the Contract Documents, as being required to produce the intended result shall be supplied, whether or not specifically called for in the Contract Documents.

**1.0 GENERAL INSURANCE REQUIREMENTS:**

1.01 During the Term of the Agreement, the Contractor shall provide, pay for, and maintain with insurance companies satisfactory to the City of Key West, Florida ("City"), the types of insurance described herein.

- 1.02 All insurance shall be from responsible insurance companies eligible to do business in the State of Florida. The required policies of insurance shall be performable in Monroe County, Florida, and shall be construed in accordance with the laws of the State of Florida.
- 1.03 The City shall be specifically included as an additional insured on the Contractor's Liability policies with the exception of the Contractor's Professional Liability policies (if required) and shall also provide the "Severability of Interest" provision (a/k/a "Separation of Insured's" provision). The City's additional insured status should be extended to all Completed Operations coverages.
- 1.04 The Contractor shall deliver to the City, prior to commencing work/activities under the Agreement, properly executed "Certificate(s) of Insurance" setting forth the insurance coverage and limits required herein. The Certificates must be signed by the authorized representative of the insurance company(s) shown on the Certificate of Insurance. In addition, certified, true, and exact copies of the insurance policies required herein shall be provided to the City, on a timely basis, if requested by the City.
- 1.05 If the Contractor fails to provide or maintain the insurance coverages required in this Agreement at any time during the Term of the Agreement and if the Contractor refuses or otherwise neglects to deliver the required Certificate(s) of Insurance signed by the authorized representative of the insurance company(s) to the City, the City may, at the City's sole discretion, terminate or suspend this Agreement and seize the amount of Contractor's performance bond, letter of credit, or other security acceptable to the City).
- 1.06 The Contractor shall take immediate steps to make up any impairment to any Aggregate Policy Limit upon notification of the impairment. If at any time the City requests a written statement from the insurance company(s) as to any impairment to the Aggregate Limit, the Contractor shall promptly authorize and have delivered such statement to the City.
- 1.07 The Contractor authorizes the City and/or its insurance consultant to confirm all information furnished to the City, as to its compliance with its Bonds and Insurance Requirements, with the Contractor's insurance agents, brokers, surety, and insurance carriers.
- 1.08 All insurance coverage of the Contractor shall be primary to any insurance or self-insurance program carried by the City. The City's insurance or self-insurance programs or coverage shall not be contributory with any insurance required of the Contractor in this Agreement.
- 1.09 The acceptance of delivery to the City of any Certificate of Insurance evidencing the insurance coverage and limits required in the Agreement does not constitute approval or agreement by the City that the insurance requirements in the Agreement have been met or that the insurance policies shown in the Certificates of Insurance are in compliance with the Agreement requirements.
- 1.10 No work/activity under this Agreement shall commence or continue unless and until the required Certificate(s) of Insurance are in effect and the written Notice to Proceed is issued by the City.
- 1.11 The insurance coverage and limits required of the Contractor under this Agreement are designed to meet the minimum requirements of the City. They are not designed as a recommended insurance program for the Contractor. The Contractor alone shall be responsible for the sufficiency of its own insurance program. Should the Contractor have any question concerning its exposures to loss under this Agreement or the possible insurance coverage needed therefore,

it should seek professional assistance.

- 1.12 During the Term of this Agreement, the City and its agents and contractors may continue to engage in necessary business activities during the operations of the Contractor. No personal property owned by City used in connection with these business activities shall be considered by the Contractor's insurance company as being in the care, custody, or control of the Contractor.
- 1.13 Should any of the required insurances specified in this Agreement provide for a deductible, self-insured retention, self-insured amount, or any scheme other than a fully insured program, the Contractor shall be responsible for all deductibles and self-insured retentions.
- 1.14 All of the required insurance coverages shall be issued as required by law and shall be endorsed, where necessary, to comply with the minimum requirements contained herein.
- 1.15 The Contractor shall provide the City thirty (30) days advance written notice of any cancellation, intent not to renew any policy and/or any change that will reduce the insurance coverage required in this Agreement, except for the application of the Aggregate Limits Provisions.
- 1.16 Renewal Certificate(s) of Insurance shall be provided to the City at least twenty (20) days prior to expiration of current coverage so that there shall be no termination of the Agreement due to lack of proof of the insurance coverage required of the Contractor.
- 1.17 If the Contractor utilizes contractors or sub-contractors to perform any operations or activities governed by this Agreement, the Contractor will ensure all contractors and sub-contractors to maintain the same types and amounts of insurance required of the Contractor. In addition, the Contractor will ensure that the contractor and sub-contractor insurances comply with all of the Insurance Requirements specified for the Contractor contained within this Agreement. The Contractor shall obtain Certificates of Insurance comparable to those required of the Contractor from all contractors and sub-contractors. Such Certificates of Insurances shall be presented to the City upon request. Contractor's obligation to ensure that all contractor's and sub-contractor's insurance as provided herein shall not exculpate Contractor from the direct primary responsibility Contractor has to the City hereunder. The City will look directly to Contractor for any such liability hereunder and shall not be obligated to seek recovery from any contractor or subcontract or under such contractor's or sub-contractor's insurance coverages.

**2.0 SPECIFIC INSURANCE COVERAGES AND LIMITS:**

- 2.01 All requirements in this Insurance Section shall be complied with in full by the Contractor unless excused from compliance in writing by the City.
- 2.02 The amounts and types of insurance must conform to the following minimum requirements. Current Insurance Service Office (ISO) or National Council on Compensation Insurance (NCCI) policies, forms, and endorsements or broader shall be used where applicable. Notwithstanding the foregoing, the wording of all policies, forms, and endorsements must be acceptable to the City.

**Workers' Compensation and Employers' Liability Insurance** shall be maintained in force during the Term of this Agreement for all employees engaged in this work under this Agreement, in accordance with the laws of the State of Florida. The minimum acceptable limits shall be:

Workers' Compensation	Florida Statutory Requirements
Employer's Liability	\$100,000.00 Limit Each Accident

\$500,000.00 Limit Disease Aggregate  
\$100,000.00 Limit Disease Each  
Employee

If the Contractor has less than four (4) employees and has elected not to purchase Workers' Compensation/Employers Liability coverage as permitted by *Florida Statutes*, the Contractor will be required to issue a formal letter (on the Contractor's letterhead) stating that it has less than four (4) employees and has elected not to purchase Workers' Compensation/Employers Liability coverage as permitted by *Florida Statutes*. This exception does **not** apply to firms engaged in construction activities.

**Commercial General Liability Insurance** shall be maintained by the Contractor on a Full Occurrence Form. Coverage shall include, but not be limited to, Premises and Operations, Personal Injury, Contractual for this Agreement, Independent Contractors, and Products & Completed Operations Coverage. The limits of such coverage shall not be less than:

Bodily Injury & Property Damage Liability	\$1,000,000.00 Combined Single Limit each Occurrence and Aggregate
--	---

Completed Operations Liability Coverage shall be maintained by the Contractor for a period of not less than four (4) years following expiration or termination of this Agreement.

The use of an Excess, Umbrella and/or Bumbershoot policy shall be acceptable if the level of protection provided by the Excess, Umbrella and/or Bumbershoot policy is equal to or more comprehensive than the Primary Commercial General Liability policy.

**Business Automobile Liability Insurance** shall be maintained by the Contractor as to ownership, maintenance, use, loading and unloading of all owned, non-owned, leased, or hired vehicles with limits of such coverage of not less than:

\$200,000 per Person;  
\$300,000 per Occurrence  
\$200,000 Property Damage  
or  
\$300,000 Combined Single Limit

If the Contractor does not own any vehicles, this requirement can be satisfied by having the Contractor's Commercial General Liability policy endorsed with "Non-Owned and Hired Automobile" Liability coverage.

**Installation Floater Insurance** shall be maintained by the Contractor that will provide coverage for machinery and equipment while being transported, installed, and tested. The minimum acceptable limits of such coverage shall be not be less than the value of the machinery or equipment being installed. **City shall be designated as the "Loss Payee" on the policy.**

#### **SURETY AND INSURER QUALIFICATIONS**

All bonds, insurance contracts, and certificates of insurance shall be either executed by or countersigned by a licensed resident agent of the Surety or insurance company, having his place of business in the State of Florida, and in all ways complying with the insurance laws of the State of

Florida. Further, the said Surety or insurance company shall be duly licensed and qualified to do business in the State of Florida.

START OF CONSTRUCTION AND CONTRACT COMPLETION TIME

The Bidder agrees to begin work within fourteen (14) calendar days after the date of the Notice to Proceed and to fully complete all work under this contract within one hundred-twenty (120) calendar days, including construction of the foundation and assembly of the structure.

LIQUIDATED DAMAGES

In the event the Bidder is awarded the Contract and fails to complete the work within the time limit or extended time limit agreed upon, as more particularly set forth in the Contract Documents, liquidated damages shall be paid to the Owner at the rate of \$500.00 per day for all work awarded until the work has been satisfactorily completed as provided by the Contract Documents. Sundays and legal holidays shall be excluded in determining days in default.

Owner will recover such liquidated damages by deducting the amount owed from the final payment or any retainage held by Owner.

ADDENDA

The Bidder hereby acknowledges that he has received Addenda No's. \_\_\_\_\_, \_\_\_\_\_, \_\_\_\_\_, \_\_\_\_\_. (Bidder shall insert No. of each Addendum received) and agrees that all addenda issued are hereby made part of the Contract Documents, and the Bidder further agrees that his Bid(s) includes all impacts resulting from said addenda.

SALES AND USE TAXES

The Bidder agrees that all federal, state, and local sales and use taxes are included in the stated bid prices for the work.

UNIT PRICE WORK ITEMS

The Bidder further proposes to accept as full payment for the Work proposed herein the amounts computed under the provisions of the Contract Documents and based on the following unit price amounts.

The Bidder agrees that the unit price represent a true measure of labor and materials required to perform the Work, including all allowances for overhead and profit for each type of work called for in these Contract Documents. The amounts shall be shown in both words and figures. In case of discrepancy, the amount shown in words shall govern.

\* \* \* \* \*



**BID SCHEDULE  
ITB #24-009**

**FIRE PUMPS REPLACEMENT  
KEY WEST HISTORIC SEAPORT (KWB)  
CITY MARINA @ GARRISON BIGHT (GB)**

UNIT PRICE BID

Bid unit prices stated in this proposal include all costs and expenses for labor, equipment, materials, disposal and contractor's overhead and profit. Unit prices for the various work items are intended to establish a total price for completing the project in its entirety. All work and incidental costs shall be included for payment under the several scheduled items of the overall contract, and no separate payment will be made therefore.

1. Mobilization, General/Supp Conditions and Demobilization

a.	Mobilization	1	each	\$	<u>0</u>
b.	General/Supp. Conditions	1	each	\$	<u>0</u>
c.	Demobilization	1	each	\$	<u>0</u>
	1	LS (a, b, c combined) (10% of Const. Cost Max.)		\$	<u>0</u>

2. Payment and Performance Bonds

1 LS \$ 18,600.00

3. Permit Fees (to be paid at cost)

1 LS \$ 23,000.00

4. **Pump #1** KWB Ferry Terminal: Fire Pump, Jockey Pump, Controllers, Valves, FDC, Piping and Equipment as described in the Supplemental Information (Includes all labor, removal & disposal of existing, equipment, and materials for a complete product)

1 LS \$ 93,000.00

5. **Pump #2** KWB Margaret St.: Fire Pump, Jockey Pump, Controllers, Valves, FDC, Piping and Equipment as described in the Supplemental Information (Includes all labor, removal & disposal of existing, equipment, and materials for a complete product)

1 LS \$ 93,000.00

6. **Pump #3 GB West:** Fire Pump, Jockey Pump, Controllers, Valves, FDC, Piping and Equipment as described in the Supplemental Information (Includes all labor, removal & disposal of existing, equipment, and materials for a complete product)

1 LS \$ 93,000.00

7. **Pump #4 GB East:** Fire Pump, Jockey Pump, Controllers, Valves, FDC, Piping and Equipment as described in the Supplemental Information (Includes all labor, removal & disposal of existing, equipment, and materials for a complete product)

1 LS \$ 93,000.00

8. Allowance (only to be used with owner's written directive)

1 LS \$ 50,000

**TOTAL OF ALL EXTENDED LINE ITEMS LISTED ABOVE:**

Total of lump sum items 1 - 8 \$ 463,600.00

Four hundred Thirteen Thousand Dollars & 00 Cents  
(amount written in words)  
Six hundred Dollars

**NOTE:** THE TOTAL BID WILL BE THE BASIS OF EVALUATING LOW BIDDER AND BASIS OF AWARD

**The Bidder shall submit a Schedule of Values with the Bid. It shall be broken down by trade and type of work and it shall be used as a basis for payment. The Bidder will be considered non-responsive if Schedule of Values not included in Bid package.**

Payment for materials and equipment authorized by the ENGINEER in a written Change Order but not listed in the above Bid will be provided at the supplier's invoice plus 10 %.

Total allowable cost for Mobilization, General/Supp Conditions and Demobilization (bid schedule line item 1) shall be 10% maximum of total construction costs (bid schedule line items 4 through 8).



SUBCONTRACTORS

The Bidder further proposes that the following subcontracting firms or businesses will be awarded subcontracts for the following portions of the work in the event that the Bidder is awarded the Contract:

ED CAREY ELECTRIC LLC EC#0000609

\_\_\_\_\_  
Name

\_\_\_\_\_, \_\_\_\_\_, \_\_\_\_\_, \_\_\_\_\_  
Street City State Zip

\_\_\_\_\_  
Name

\_\_\_\_\_, \_\_\_\_\_, \_\_\_\_\_, \_\_\_\_\_  
Street City State Zip

\_\_\_\_\_  
Name

\_\_\_\_\_, \_\_\_\_\_, \_\_\_\_\_, \_\_\_\_\_  
Street City State Zip

\_\_\_\_\_  
Name

\_\_\_\_\_, \_\_\_\_\_, \_\_\_\_\_, \_\_\_\_\_  
Street City State Zip

SURETY

\_\_\_\_\_ whose address is

\_\_\_\_\_, \_\_\_\_\_, \_\_\_\_\_  
Street City State Zip

BIDDER

The name of the Bidder submitting this Proposal is

FLORIDA KEYS FIRE PROTECTION INC doing business at  
1107 KEY PLAZA SUITE 252 KEY WEST FL 33040  
Street City State Zip

which is the address to which all communications concerned with this Proposal and with the Contract shall be sent.

The names of the principal officers of the corporation submitting this Proposal, or of the partnership, or of all persons interested in this Proposal as principals are as follows:

Name	Title
<u>JAMES A. BOGOEFF</u>	<u>OPERATION MGR</u>
_____	_____
_____	_____
_____	_____



If Sole Proprietor or Partnership

IN WITNESS hereto the undersigned has set his (its) hand this \_\_\_\_\_ day of \_\_\_\_\_ 2024.

\_\_\_\_\_  
Signature of Bidder

\_\_\_\_\_  
Title

If Corporation

IN WITNESS WHEREOF the undersigned corporation has caused this instrument to be executed and its seal affixed by its duly authorized officers this 2<sup>nd</sup> day of May 2024.

(SEAL)

FLORIDA KEYS FIRE PROTECTION  
Name of Corporation

By [Signature]

Title OPERATIONS

Attest [Signature]  
Secretary



EXPERIENCE OF BIDDER

The Bidder states that he is an experienced CONTRACTOR and has completed similar projects within the last 5 years.

(List similar projects, with types, names of OWNERS, construction costs, ENGINEERS, and references with phone numbers. Use additional sheets if necessary.)

1. LA CONCHA HOTEL MARK 305 304 0414  
REPLACED FIRE PUMP

---

2. MARRIOTT BEACHSIDE LANE 305 304 5832

---

3. NAS KEY WEST - JET HANGER  
DIESEL PUMP REYNOLDS CONST  
Tosh 317 832 5987

---

4. NAS KEY WEST - JET & HELICOPTER HANGER  
ELECTRIC PUMP REYNOLDS CONST  
Tosh 317 832 5987

---

5. NAS KEY WEST - JET HANGER  
ELECTRIC PUMP REYNOLDS CONST  
Tosh 317 832 5987

\*\*\*\*\*

**FLORIDA BID BOND**

BOND NO. \_\_\_\_\_

AMOUNT: \$ \_\_\_\_\_

KNOW ALL MEN BY THESE PRESENTS, that \_\_\_\_\_

hereinafter called the PRINCIPAL, and \_\_\_\_\_

a corporation duly organized under the laws of the State of FLORIDA

having its principal place of business at 1107 KEY PLAZA #292

KEY WEST in the State of FLORIDA

and authorized to do business in the State of Florida, as SURETY, are held and firmly bound unto

hereinafter called the OBLIGEE, in the sum of \_\_\_\_\_

DOLLARS (\$ \_\_\_\_\_) for the payment for which we bind ourselves, our heirs, executors, administrators, successors, and assigns, jointly and severally, firmly by these present.

THE CONDITION OF THIS BOND IS SUCH THAT:

WHEREAS the PRINCIPAL is herewith submitting his or its Bid Proposal for **ITB #24-009 FIRE PUMPS REPLACEMENT - KEY WEST HISTORIC SEAPORT & CITY MARINA @ GARRISON BIGHT**, said Bid Proposal, by reference thereto, being hereby made a part hereof.



WHEREAS, the PRINCIPAL contemplates submitting or has submitted a bid to the OBLIGEE for the furnishing of all labor, materials (except those to be specifically furnished by the CITY), equipment, machinery, tools, apparatus, means of transportation for, and the performance of the work covered in the Proposal and the detailed Specifications, entitled:

**ITB #24-009**

**FIRE PUMPS REPLACEMENT**

**KEY WEST HISTORIC SEAPORT & CITY MARINA @ GARRISON BIGHT**

WHEREAS, it was a condition precedent to the submission of said bid that a cashier's check, certified check, or bid bond in the amount of 5 percent of the base bid be submitted with said bid as a guarantee that the Bidder would, if awarded the Contract, enter into a written Contract with the CITY for the performance of said Contract, within 10 working days after written notice having been given of the award of the Contract.

NOW, THEREFORE, the conditions of this obligation are such that if the PRINCIPAL within 10 consecutive calendar days after written notice of such acceptance, enters into a written Contract with the OBLIGEE and furnishes the Performance and Payment Bonds, each in an amount equal to 100 percent of the base bid, satisfactory to the CITY, then this obligation shall be void; otherwise the sum herein stated shall be due and payable to the OBLIGEE and the Surety herein agrees to pay said sum immediately upon demand of the OBLIGEE in good and lawful money of the United States of America, as liquidated damages for failure thereof of said PRINCIPAL.

Signed and sealed this 3<sup>rd</sup> day of MAY, 2024.

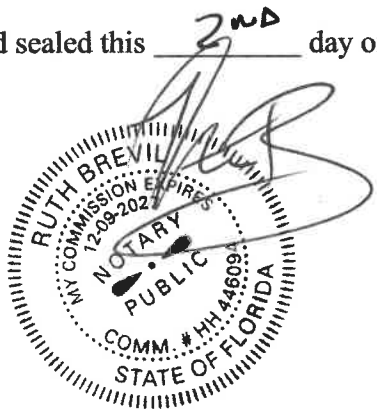

By [Signature]  
PRINCIPAL

\_\_\_\_\_  
SURETY

By \_\_\_\_\_  
Attorney-In-Fact

**SWORN STATEMENT UNDER SECTION 287.133(3)(A)  
FLORIDA STATUTES, ON PUBLIC ENTITY CRIMES**

THIS FORM MUST BE SIGNED IN THE PRESENCE OF A NOTARY PUBLIC OR OTHER OFFICER AUTHORIZED TO ADMINISTER OATHS.

1. This sworn statement is submitted with Bid or Proposal for Bid #24-009 Fire Pump REPLACEMENT

2. This sworn statement is submitted by FLORIDA KEYS FIRE PROTECTION  
(name of entity submitting sworn statement)

whose business address is 1107 KEY PLAZA SUITE 292  
KEY WEST FL 33040

and (if applicable) its Federal Employer Identification Number (FEIN) is 47-1704303

(If the entity has no FEIN, include the Social Security Number of the individual signing this sworn statement \_\_\_\_\_)

3. My name is JAMES A. BOGUEFF  
(please print name of individual signing)

and my relationship to the entity named above is \_\_\_\_\_

4. I understand that a "public entity crime" as defined in Paragraph 287.133(1)(g), Florida Statutes, means a violation of any state or federal law by a person with respect to and directly related to the transaction of business with any public entity or with an agency or political subdivision of any other state or with the United States, including but not limited to, any bid or contract for goods or services to be provided to any public or an agency or political subdivision of any other state or of the United States and involving antitrust, fraud, theft, bribery, collusion, racketeering, conspiracy, material misrepresentation.

5. I understand that "convicted" or "conviction" as defined in Paragraph 287.133(1)(b), Florida Statutes, means a finding of guilt or a conviction of a public entity crime, with or without an adjudication of guilt, in any federal or state trial court of record relating to charges brought by indictment information after July 1, 1989, as a result of a jury verdict, nonjury trial, or entry of a plea of guilty or nolo contendere.

6. I understand that an "affiliate" as defined in Paragraph 287.133(1)(a), Florida Statutes, means

a. A predecessor or successor of a person convicted of a public entity crime; or

b. An entity under the control of any natural person who is active in the management of the entity and who has been convicted of a public entity crime. The term "affiliate" includes those officers, directors, executives, partners, shareholders, employees, members, and agents who are active in the management of an affiliate. The ownership by one person of shares constituting controlling interest in another person, or a pooling of equipment or income among persons when not for fair market value under an arm's length agreement, shall be a prima facie case that one person controls another person. A person who knowingly enters into a joint venture with a person who has been convicted of a public entity crime in Florida during the preceding 36 months shall be considered an affiliate.

ANTI-KICKBACK AFFIDAVIT

STATE OF Florida

: SS

COUNTY OF Monroe

I, the undersigned hereby duly sworn, depose and say that no portion of the sum herein bid will be paid to any employees of the City of Key West as a commission, kickback, reward or gift, directly or indirectly by me or any member of my firm or by an officer of the corporation.

By: James A. Bogoeff Sr

Sworn and subscribed before me this 2<sup>nd</sup> day of May 2024.

NOTARY PUBLIC, State of Florida at Large

My Commission Expires: Dec. 09, 2027

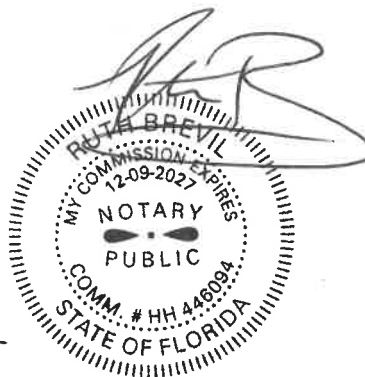

\* \* \* \* \*

7. I understand that a "person" as defined in Paragraph 287.133(1)(8), Florida Statutes, means any natural person or entity organized under the laws of any state or of the United States with the legal power to enter into a binding contract and which bids or applies to bid on contracts for the provision of goods or services let by a public entity, or which otherwise transacts or applies to transact business with public entity. The term "person" includes those officers, directors, executives, partners, shareholders, employees, members, and agents who are active in management of an entity.
8. Based on information and belief, the statement which I have marked below is true in relation to the entity submitting this sworn statement. (Please indicate which statement applies).

Neither the entity submitting this sworn statement, nor any officers, directors, executives, partners, shareholders, employees, members, or agents who are active in management of the entity, nor any affiliate of the entity have been charged with and convicted of a public entity crime subsequent to July 1, 1989, AND (Please indicate which additional statement applies.)

There has been a proceeding concerning the conviction before a hearing of the State of Florida, Division of Administrative Hearings. The final order entered by the hearing officer did not place the person or affiliate on the convicted vendor list. (Please attach a copy of the final order.)

The person or affiliate was placed on the convicted vendor list. There has been a subsequent proceeding before a hearing officer of the State of Florida, Division of Administrative Hearings. The final order entered by the hearing officer determined that it was in the public interest to remove the person or affiliate from the convicted vendor list. (Please attach a copy of the final order.)

The person or affiliate has not been put on the convicted vendor list. (Please describe any action taken by or pending with the Department of General Services.)

[Signature]  
(signature)

5/2/24  
(date)

STATE OF Florida

COUNTY OF Monroe

PERSONALLY APPEARED BEFORE ME, the undersigned authority,

[Signature] Who, after first being sworn by me, affixed his/her  
(name of individual signing)

signature in the space provided above on this 2<sup>nd</sup> day of May, 2024.

My commission expires: Dec. 09, 2027

[Signature]  
NOTARY PUBLIC

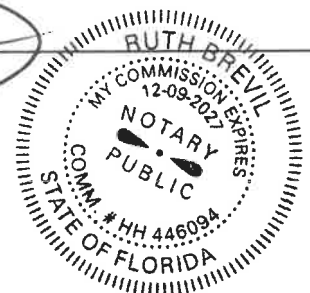

**CITY OF KEY WEST INDEMNIFICATION FORM**

To the fullest extent permitted by law, the CONTRACTOR expressly agrees to indemnify and hold harmless the City of Key West, their officers, directors, agents and employees \*(herein called the "indemnitees") from liabilities, damages, losses and costs, including but not limited to, reasonable attorney's fees and court costs, such legal expenses to include costs incurred in establishing the indemnification and other rights agreed to in this Paragraph, to persons or property, to the extent caused by the negligence, recklessness, or intentional wrongful misconduct of the CONTRACTOR, its Subcontractors or persons employed or utilized by them in the performance of the Contract. Claims by indemnitees for indemnification shall be limited to the amount of CONTRACTOR's insurance or \$1 million per occurrence, whichever is greater. The parties acknowledge that the amount of the indemnity required hereunder bears a reasonable commercial relationship to the Contract and it is part of the project specifications or the bid documents, if any.

The indemnification obligations under the Contract shall not be restricted in any way by any limitation on the amount or type of damages, compensation, or benefits payable by or for the CONTRACTOR under Workers' Compensation acts, disability benefits acts, or other employee benefits acts, and shall extend to and include any actions brought by or in the name of any employee of the CONTRACTOR or of any third party to whom CONTRACTOR may subcontract a part or all of the Work. This indemnification shall continue beyond the date of completion of the work.

CONTRACTOR: 1107 KEY PLAZA SUITE 252  
Address KEY WEST FL.

SEAL:

[Signature]  
Signature

JAMES A. SOGOEFF  
Print Name

\_\_\_\_\_  
Title

DATE: OPERATIONS

**EQUAL BENEFITS FOR DOMESTIC PARTNERS AFFIDAVIT**

STATE OF Florida

: SS

COUNTY OF Monroe

I, the undersigned hereby duly sworn, depose and say that the firm of Florida

KEYS FIRE PROTECTION  
provides benefits to domestic partners of its employees on the same basis as it provides benefits to employees' spouses, per City of Key West Code of Ordinances Sec. 2-799.

By: [Signature]

Sworn and subscribed before me this 2<sup>nd</sup> day of Apr. May <sup>(R13)</sup> 2024.

[Signature]  
NOTARY PUBLIC, State of Florida at Large

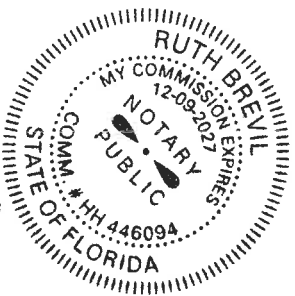

My Commission Expires: Dec. 09, 2027

\*\*\*\*\*

**CONE OF SILENCE AFFIDAVIT**

STATE OF FLORIDA )

: SS

COUNTY OF MONROE )

I, the undersigned hereby duly sworn, depose and say that all owner(s), partners, officers, directors, employees and agents representing the firm of FLORIDA KEYS FIRE PROTECTION have read and understand the limitations and procedures regarding communications concerning City of Key West Code of Ordinances Sec. 2-773 Cone of Silence.

By: [Signature]

Sworn and subscribed before me this 2nd day of May 2024.

[Signature]

NOTARY PUBLIC, State of Florida at Large

My Commission Expires: Dec. 09, 2027

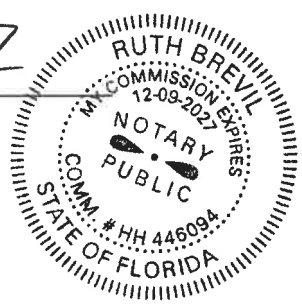

**NON-COLLUSION AFFIDAVIT**

STATE OF Florida )

: SS

COUNTY OF MONROE

I, the undersigned hereby declares that the only persons or parties interested in this Proposal are those named herein, that this Proposal is, in all respects, fair and without fraud, that it is made without collusion with any official of the Owner, and that the Proposal is made without any connection or collusion with any person submitting another Proposal on this Contract.

By: 

Sworn and subscribed before me this  
2nd day of May, 2024.  
RA (R.B.)

NOTARY PUBLIC, State of Florida at Large

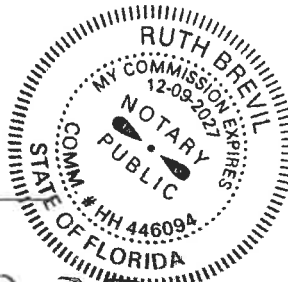

My Commission Expires: Dec. 09, 2027



**LOCAL VENDOR CERTIFICATION  
PURSUANT TO CITY OF KEY WEST CODE OF ORDINANCES SECTION 2-798**

The undersigned, as a duly authorized representative of the vendor listed herein, certifies to the best of his/her knowledge and belief, that the vendor meets the definition of a "Local Business." For purposes of this section, "local business" shall mean a business which:

- a. Principle address as registered with the FL Department of State located within 30 miles of the boundaries of the city, listed with the chief licensing official as having a business tax receipt with its principle address within 30 miles of the boundaries of the city for at least one year immediately prior to the issuance of the solicitation.
- b. Maintains a workforce of at least 50 percent of its employees from the city or within 30 miles of its boundaries.
- c. Having paid all current license taxes and any other fees due the city at least 24 hours prior to the publication of the call for bids or request for proposals.
  - Not a local vendor pursuant to Code of Ordinances Section 2-798
  - Qualifies as a local vendor pursuant to Code of Ordinances Section 2-798

If you qualify, please complete the following in support of the self-certification & submit copies of your County and City business licenses. Failure to provide the information requested will result in denial of certification as a local business.

Business Name FLORIDA KEYS FIRE Phone: 305 509 2409

Current Local Address: 1507 KEY PLAZA Fax:  
(P.O. Box numbers may not be used to establish status)

Length of time at this address

[Signature]  
Signature of Authorized Representative

5/2/24  
Date

STATE OF Florida  
COUNTY OF Monroe

The foregoing instrument was acknowledged before me this 2<sup>nd</sup> day of May, 2024.  
By James Bogoeff, of Florida Keys Fire  
(Name of officer or agent, title of officer or agent) Name of corporation acknowledging)  
or has produced Dr. Ver Li Cense as identification  
(type of identification)

[Signature]  
Signature of Notary  
RUTH BREVIL  
Print, Type or Stamp Name of Notary  
Manager  
Title or Rank

Return Completed form with  
Supporting documents to:  
City of Key West Purchasing

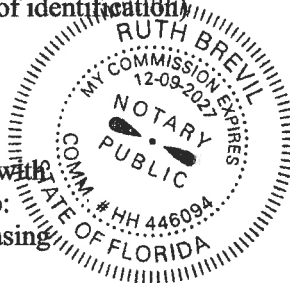

**VENDOR CERTIFICATION REGARDING SCRUTINIZED COMPANIES LISTS**

Respondent Vendor Name: FLORIDA KEYS FIRE PROTECTION  
Vendor FEIN: 47-1704303  
Vendor's Authorized Representative Name and Title: JAMES BOGOEFF OPERATIONS  
Address: 1107 KEY PLAZA SUITE 292  
City: KEY WEST State: FLORIDA Zip: 33040  
Phone Number: 305 509 2409  
Email Address: FLORIDA KEYS FIRE @ GMAIL.COM

Section 287.135(2)(a), Florida Statutes, prohibits a company from bidding on, submitting a proposal for, or entering into or renewing a contract for goods or services of any amount if, at the time of contracting or renewal, the company is on the Scrutinized Companies that Boycott Israel List, created pursuant to section 215.4725, Florida Statutes, or is engaged in a boycott of Israel. Section 287.135(2)(b), Florida Statutes, further prohibits a company from bidding on, submitting a proposal for, or entering into or renewing a contract for goods or services over one million dollars (\$1,000,000) if, at the time of contracting or renewal, the company is on either the Scrutinized Companies with Activities in Sudan List or the Scrutinized Companies with Activities in the Iran Petroleum Energy Sector List, both created pursuant to section 215.473, Florida Statutes, or the company is engaged in business operations in Cuba or Syria.

As the person authorized to sign on behalf of Respondent, I hereby certify that the company identified above in the section entitled "Respondent Vendor Name" is not listed on either the Scrutinized Companies that Boycott Israel List, Scrutinized Companies with Activities in Sudan List or the Scrutinized Companies with Activities in the Iran Petroleum Energy Sector List I understand that pursuant to section 287.135, Florida Statutes, the submission of a false certification may subject such company to civil penalties, attorney's fees, and/or costs and termination of the contract at the option of the awarding governmental entity.

Certified By: JAMES BOGOEFF OPERATIONS  
*Print Name* *Print Title*

who is authorized to sign on behalf of the above referenced company.

Authorized Signature: 

**BIDDER'S CHECKLIST**

(Note: The purpose of this checklist is to serve as a reminder of major items to be addressed in submitting a bid and is not intended to be all inclusive. It does not alleviate the Bidder from the responsibility of becoming familiar with all aspects of the Contract Documents and Proper completion and submission of his bid.)

- 1. All Contract Documents thoroughly read and understood
- 2. All blank spaces in Bid filled in black ink.
- 3. Total and unit Prices added correctly.
- 4. Addenda acknowledged.
- 5. Subcontractors are named as indicated in the Bid.
- 6. Experience record included.
- 7. Bid signed by authorized officer.
- 9. Bid Bond completed and executed, including power-of-attorney, dated the same date as Bid Bond.
- 10. Bidder familiar with federal, state, and local laws, ordinances, rules and regulations affecting performance of the work.
- 11. Bidder, if successful, able to obtain and/or demonstrate possession of required licenses and certificates within (10) ten days after receiving a Notice of Award.
- 12. Bid submitted intact with the volume containing the Bidding Requirements, Contract Forms and Conditions of the Contract, one (1) original, two (2) USB drives.
- 13. Bid Documents submitted in sealed envelope and addressed and labeled in conformance with the instructions in the Invitation to Bid.
- 14. Anti-kickback Affidavit; Public Entity Crime Form; City of Key West Indemnification Equal Benefits for Domestic Partners Affidavit; Local Vendor Certification; Non-Collusion Affidavit; Scrutinized Companies List Certification; Proof of Required Insurance

\* \* \* \* \*

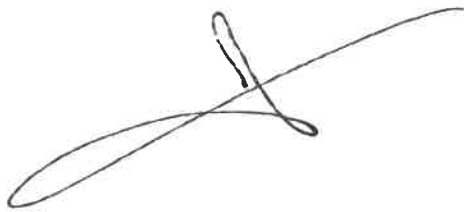

---

**PART 2**  
**CONTRACT FORMS**

---

**DRAFT CONTRACT AGREEMENT**

This Contract, made and entered into 2<sup>nd</sup> day of MAY 2024,  
by and between the City of Key West, hereinafter called the "Owner", and  
\_\_\_\_\_, hereinafter called the "Contractor";

WITNESSETH:

The Contractor, in consideration of the sum to be paid him by the Owner and of the covenants and agreements herein contained, hereby agrees at his own proper cost and expense to do all the work and furnish all the materials, tools, labor, and all appliances, machinery, and appurtenances for **ITB #24-009 FIRE PUMPS REPLACEMENT - KEY WEST HISTORIC SEAPORT & CITY MARINA @ GARRISON BIGHT**

Key West, Florida to the extent of the Bid made by the Contractor, dated the 2<sup>nd</sup> day of MAY, 2024, all in full compliance with the Contract Documents referred to herein.

The PROCUREMENT REQUIREMENTS, including the signed copy of the BID FORM, the CONTRACT FORMS, the CONDITIONS OF THE CONTRACT, and the SPECIFICATIONS, DRAWINGS and/or SUPPLEMENTAL INFORMATION (if any), are hereby referred to and by reference made part of this Contract as fully and completely as if the same were fully set forth herein and are mutually cooperative therewith.

In consideration of the performance of the work as set forth in these Contract Documents, the Owner agrees to pay to the Contractor the amount bid in the Bid as adjusted in accordance with the Contract Documents, or as otherwise herein provided, and to make such payments in the manner and at the times provided in the Contract Documents.

The Contractor agrees to complete the work within one hundred-twenty (120) calendar days and to accept as full payment hereunder the amounts computed as determined by the Contract Documents and based on the said Bid.

The Contractor agrees to remedy all defects appearing in the work or developing in the materials furnished and the workmanship performed under this Contract during the warranty period after the date of final acceptance of the work by the Owner, and further agrees to indemnify and save the Owner harmless from any costs encountered in remedying such defects.

Liquidated Damages: The Contractor recognizes that time is of the essence and that the Owner will suffer financial loss if the Work is not completed within the dates specified in the paragraphs above, plus any extensions thereof allowed, in accordance with Article 58 of the General Conditions.

In the event the Contractor fails to complete the work within the time limit or extended time limit agreed upon, as more particularly set forth in the Contract Documents, liquidated damages shall be paid at a rate of **\$500.00** per day. Sundays and legal holidays shall be included in determining days in default.

This contract will automatically expire upon completion of the project. Contractors warranty obligations remain in effect.

IN WITNESS WHEREOF, we, the parties hereto, each herewith subscribe the same this \_\_\_\_\_ day of \_\_\_\_\_, A.D., 2024.

**CITY OF KEY WEST**

By \_\_\_\_\_

Printed \_\_\_\_\_

Title \_\_\_\_\_

**CONTRACTOR**

By \_\_\_\_\_

Printed JAMES BOSEIFF

Title OPERATION



APPROVED AS TO FORM

\_\_\_\_\_  
Attorney for Owner

\* \* \* \* \*

**FLORIDA PERFORMANCE BOND**

BOND NO. \_\_\_\_\_

AMOUNT: \$ \_\_\_\_\_

**KNOW ALL MEN BY THESE PRESENTS**, that in accordance with Florida Statutes Section

255.05 JAMES A. BOGOEFF SR.

with offices at \_\_\_\_\_

hereinafter called the CONTRACTOR (Principal), and

with offices at \_\_\_\_\_

a corporation duly organized and existing under and by virtue of the laws of the State of Florida, hereinafter called the SURETY, and authorized to transact business within the State of Florida, as SURETY, are held and firmly bound unto the **CITY OF KEY WEST**, hereinafter called the CITY (Obligee), in the sum of:

\_\_\_\_\_ DOLLARS (\$ \_\_\_\_\_),  
lawful money of the United States of America, for the payment of which, well and truly be made to the CITY, the CONTRACTOR and the SURETY bind themselves and each of their heirs, executors, administrators, successors, and assigns, jointly and severally, firmly by these presents as follows:

**THE CONDITION OF THE ABOVE OBLIGATION IS SUCH THAT:**

**WHEREAS**, the CONTRACTOR has executed and entered into a certain Contract hereto attached, with the CITY, dated MAY 2, 204 to furnish at his own cost, charges, and expense all the necessary materials, equipment, and/or labor in strict and express accordance with said Contract and the Contract Documents as defined therein, all of which is made a part of said Contract by certain terms and conditions in said Contract more particularly mentioned, which Contract, consisting of the various Contract Documents is made a part of this Bond as fully and completely as if said Contract Documents were set forth herein;

**NOW THEREFORE**, the conditions of this obligation are such that if the above bounden CONTRACTOR:

1. Shall in all respects comply with the terms and conditions of said Contract and his obligation there under, including the Contract Documents (which include the scope of work and conditions as prepared by the CITY, invitation to bid, instructions to bidders, the CONTRACTOR'S bid as accepted by the above CITY, the bid and contract performance and payment bonds (Not required as part of this contract), and all addenda, if any, issued prior to the opening of bids), being made a part of this bond by reference, at the times and in the manner prescribed in the contract; and

2. Promptly makes payments to all claimants, as defined in Section 255.05(1), Florida Statutes, supplying PRINCIPAL with labor, materials, or supplies, used directly or indirectly by PRINCIPAL in the prosecution of the work provided for in the contract; and

3. Pays CITY all losses, costs, expenses, damages, attorney's fees, including appellate proceedings, injury or loss of whatever kind and however arising including, without limitation, delay damages to which said CITY may be subject by reason of any wrongdoing, misconduct, want of care or skill, negligence, failure of performance, breach, failure to petition within the prescribed time, or default, including patent infringements, on the part of said CONTRACTOR, his agents or employees, in the execution or performance of said Contract; and

4. Performs the guarantee of all work and materials furnished under the contract for the time specified in the contract, then this obligation shall be void; otherwise, to remain in full force and effect for the term of said Contract.

AND, the said Surety for value received, hereby stipulates and agrees that no change involving any extension of time, or addition to the terms of the Contract Documents, or to the work to be performed, or materials to be furnished there under shall affect said obligation of said Surety on this Bond, and the said Surety does hereby waive notice of any such changes, extension of time, alterations, or additions of the terms of the Contract Documents, or to the work.

Any action instituted by a claimant under this bond for payment must be in accordance with the notice and time limitation provisions in Section 255.05(2), Florida Statutes.

IN WITNESS WHEREOF, the above parties bonded together have executed this instrument

this \_\_\_\_\_ day of \_\_\_\_\_, 20\_\_, the name and corporate seal of each corporate party being hereto affixed and those presents duly signed by its undersigned representative, pursuant to authority of its governing body.

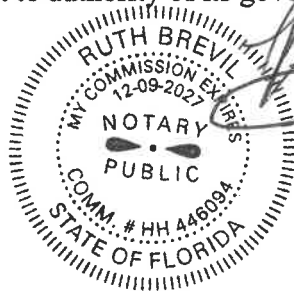

**CONTRACTOR**

By:

*[Handwritten signature]*

**SURETY**

By:

\_\_\_\_\_

(SEAL)

ATTEST

(SEAL)

ATTEST



**FLORIDA PAYMENT BOND**

BOND NO. \_\_\_\_\_

AMOUNT: \$ \_\_\_\_\_

**KNOW ALL MEN BY THESE PRESENTS**, that in accordance with Florida Statutes Section 255.05, \_\_\_\_\_

with offices at \_\_\_\_\_ hereinafter called the CONTRACTOR, (Principal), and

\_\_\_\_\_ with offices at \_\_\_\_\_

a corporation duly organized and existing under and by virtue of the laws of the State of \_\_\_\_\_

\_\_\_\_\_, hereinafter called the SURETY, and authorized to transact business within the State of Florida, as SURETY, are held and firmly bound unto CITY OF KEY WEST, hereinafter called the City (Obligee), in the sum of:

\_\_\_\_\_ DOLLARS( \_\_\_\_\_), lawful money of the United States of America, for the payment of which, well and truly be made to the CITY, and the CONTRACTOR and the SURETY bind themselves and each of their heirs, executors, administrators, successors, and assigns, jointly and severally, firmly by these presents as follows:

**THE CONDITION OF THE ABOVE OBLIGATION IS SUCH THAT:**

**WHEREAS**, the CONTRACTOR has executed and entered into a certain Contract for

**ITB #24-009 FIRE PUMPS REPLACEMENT - KEY WEST HISTORIC SEAPORT & CITY MARINA @ GARRISON BIGHT** attached hereto, with

the CITY, dated \_\_\_\_\_

\_\_\_\_\_, 20\_\_, to furnish at his own cost, charges, and expense the necessary materials, equipment, and/or labor in strict and express accordance with said Contract and the plans, drawings (if any), and specifications prepared by the CITY, all of which is made a part of said Contract by certain terms and conditions in said Contract more particularly mentioned, which Contract, consisting of the various Contract Documents specifically mentioned herein and relative hereto, is made a part of this Bond as fully and completely as if said Contract Documents were set forth herein.

**NOW THEREFORE**, the conditions of this obligation are such that if the above bounden CONTRACTOR shall in all respects comply with the terms and conditions of said Contract and his obligation thereunder, including the Contract Documents, which include Scope of work and conditions prepared by the CITY, invitation to bid, instructions to bidders, the

CONTRACTOR'S bid as accepted by the CITY, the bid and contract and payment bonds (Not required as part of this contract), and all addenda, if any, issued prior to the opening of bids), and further that if said CONTRACTOR shall promptly make payments to all persons supplying materials, equipment, and/or labor, used directly or indirectly by said CONTRACTOR or subcontractors in the prosecution of the work for said contract in accordance with Florida Statutes, Section 255.05 or Section 713.23, then this obligation shall be void; otherwise to remain in full force and effect for the term of said contract, including and all guarantee periods as specifically mentioned in said Contract Documents.

**AND**, the said SURETY for value received, hereby stipulates and agrees that no change involving any extension of time, or addition to the terms of the Contract or to the work to be performed, or materials to be furnished thereunder, or in the Contract Documents and specifications accompanying the said contract shall affect said obligation of said SURETY on this Bond, and the said SURETY does hereby waive notice of any such changes, extension of time, alternations, or additions of the terms of the Contract, or to the work, to the Contract Documents, or to the specifications.

Claimant shall give written notice to the CONTRACTOR and the SURETY as required by Section 255.05 or Section 713.23, Florida Statutes. Any action instituted against the CONTRACTOR or SURETY under this bond for payment must be in accordance with the notice and time limitation provisions in Section 255.05(2) or Section 713.23, Florida Statutes.

**IN WITNESS WHEREOF**, the above parties bounded together have executed this instrument

this \_\_\_\_\_ day of \_\_\_\_\_, 20\_\_, the name and corporate seal of each corporate party being hereto affixed and those presents duly signed by its undersigned representative, pursuant to authority of its governing body

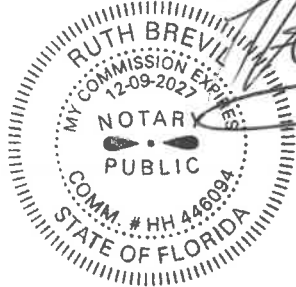

**CONTRACTOR**  
By: \_\_\_\_\_

(SEAL)

ATTEST

**SURETY**  
By: \_\_\_\_\_

(SEAL)

ATTEST

**CITY OF KEY WEST BUSINESS LICENSE TAX RECEIPT**

A City of Key West Business License Tax Receipt is required for this project. Contractor must be general contractor, building contractor or engineering contractor. Cost not to exceed \$410.00.

City of Key West Business License Tax Receipt may be found on the city website.

<http://www.keywestcity.com/egov/docs/1162843921181.htm>

---

**PART 3**

**CONDITIONS OF THE CONTRACT**

---

**GENERAL CONDITIONS**  
**CONTENTS**

**Article**

**DEFINITIONS**

1. AS APPROVED
2. AS SHOWN, AND AS INDICATED
3. BIDDER
4. CONTRACT DOCUMENTS
5. CONTRACTOR
6. CONTRACT COMPLETION
7. DAYS
8. DRAWINGS
9. ENGINEER
10. NOTICE
11. OR EQUAL
12. OWNER
13. PLANS
14. SPECIFICATIONS
15. NOTICE TO PROCEED
16. SUBSTANTIAL COMPLETION
17. WORK

**CONTRACT DOCUMENTS**

18. INTENT OF CONTRACT DOCUMENTS
19. DISCREPANCIES AND OMISSIONS
20. CHANGES IN THE WORK
21. EXAMINATION AND VERIFICATION  
OF CONTRACT DOCUMENTS
22. DOCUMENTS TO BE KEPT  
ON THE JOBSITE
23. ADDITIONAL CONTRACT  
DOCUMENTS
24. OWNERSHIP OF CONTRACT  
DOCUMENTS

**THE ENGINEER**

25. AUTHORITY OF THE ENGINEER
26. DUTIES AND RESPONSIBILITIES  
OF THE ENGINEER
27. LIMITATIONS ON ENGINEER'S  
RESPONSIBILITIES
28. REJECTED WORK
29. LINES AND GRADES
30. SUBMITTALS
31. DETAIL DRAWINGS AND INSTRUCTIONS

**THE CONTRACTOR AND HIS EMPLOYEES**

32. CONTRACTOR, AN INDEPENDENT AGENT
32. (a) ASSIGNMENT OF CONTRACT

33. SUBCONTRACTING
34. INSURANCE AND LIABILITY
  - A. GENERAL
  - B. CONTRACTOR AND SUB-  
CONTRACTOR INSURANCE
  - C. COMPENSATION AND EMPLOYER'S  
LIABILITY INSURANCE
  - D. GENERAL LIABILITY INSURANCE  
(INCLUDING AUTOMOBILE)
  - E. BUILDER'S RISK ALL RISK  
INSURANCE
  - F. NO PERSONAL LIABILITY OF PUBLIC  
OFFICIALS
35. INDEMNITY
36. EXCLUSION OF CONTRACTOR CLAIMS
37. TAXES AND CHARGES
38. REQUIREMENTS OF STATE LAW FOR  
PUBLIC WORKS PROJECTS
39. CODES, ORDINANCES, PERMITS,  
AND LICENSES
40. SUPERINTENDENCE
41. RECEPTION OF ENGINEER'S  
COMMUNICATIONS
42. SAFETY
43. PROTECTION OF WORK AND PROPERTY
44. RESPONSIBILITY OF CONTRACTOR TO ACT  
IN AN EMERGENCY
45. MATERIALS AND APPLIANCES
46. CONTRACTORS' AND MANUFACTURERS'  
COMPLIANCE WITH STATE SAFETY,  
OSHA AND OTHER CODE REQUIREMENTS
47. SUBSTITUTION OF MATERIALS
48. TESTS, SAMPLES, AND OBSERVATIONS
49. ROYALTIES AND PATENT
50. CONTRACTOR'S RIGHT TO  
TERMINATE CONTRACT
51. CORRECTION OF DEFECTIVE WORK  
DURING WARRANTY PERIOD

**PROGRESS OF THE WORK**

52. BEGINNING OF THE WORK
53. SCHEDULES AND PROGRESS REPORTS
54. PROSECUTION OF THE WORK
55. OWNER'S RIGHT TO RETAIN  
IMPERFECT WORK
56. OWNER'S RIGHT TO DO WORK
57. OWNER'S RIGHT TO TRANSFER  
EMPLOYMENT
58. DELAYS AND EXTENSION OF TIME
59. DIFFERING SITE CONDITION

**Article**

- 60. LIQUIDATED DAMAGES
- 61. OTHER CONTRACTS
- 62. USE OF PREMISES
- 63. SUBSTANTIAL COMPLETION DATE
- 64. PERFORMANCE TESTING
- 65. OWNER'S USE OF PORTION OF THE WORK
- 66. CUTTING AND PATCHING
- 67. CLEANING UP

**PAYMENT**

- 68. CHANGE ORDERS
  - A. UNIT PRICE
  - B. LUMP SUM
  - C. COST REIMBURSEMENT  
WORK
- 69. PARTIAL PAYMENTS
  - A. GENERAL
  - B. ESTIMATE
  - C. DEDUCTION FROM ESTIMATE
  - D. QUALIFICATIONS FOR  
PARTIAL PAYMENT FOR  
MATERIALS DELIVERED
  - E. PAYMENT
- 70. CLAIMS FOR EXTRA WORK
- 71. RELEASE OF LIENS OR CLAIMS
- 72. FINAL PAYMENT
- 73. NO WAIVER OF RIGHTS
- 74. ACCEPTANCE OF FINAL PAYMENT  
CONSTITUTES RELEASE

\*\*\*\*\*

## **DEFINITIONS**

Whenever in the Contract Documents the following terms are used, the intent and meaning shall be interpreted as follows:

### **1. AS APPROVED**

The words "as approved", unless otherwise qualified, shall be understood to be followed by the words "by the ENGINEER for conformance with the Contract Document".

### **2. AS SHOWN, AND AS INDICATED**

The words "as shown" and "as Indicated" shall be understood to be followed by the words "on the Drawings".

### **3. BIDDER**

The person or persons, partnership, firm, or corporation submitting a Proposal for the work contemplated.

### **4. CONTRACT DOCUMENTS**

The "Contract Documents" consist of the Bidding Requirements, Contract Forms, Conditions of the Contract, Specifications, Drawings, all modifications thereof incorporated into the Documents before their execution, Change Orders, and all other requirements incorporated by specific reference thereto. These form the Contract.

### **5. CONTRACTOR**

The person or persons, partnership, firm, or corporation who enters into the Contract awarded him by the OWNER.

### **6. CONTRACT COMPLETION**

The "Contract Completion" is the date the OWNER accepts the entire work as being in compliance with the Contract Documents, or formally waives nonconforming work to extent of nonconformity, and issues the final payment in accordance with the requirements set forth in Article, "Final Payment" of these General Conditions.

### **7. DAYS**

Unless otherwise specifically stated, the term "days" will be understood to mean calendar days. Business day or working day means any day other than Saturday, Sunday, or legal holiday.

### **8. DRAWINGS**

The term "Drawings" refers to the official Drawings, Profiles, cross sections, elevations, details, and other working drawings and supplementary drawings, or reproductions thereof, signed by the ENGINEER, which shows the location, character, dimensions, and details of the work to be performed. Drawings may either be bound in the same book as the balance of the Contract Documents, or bound in separate sets, and are a part of the Contract Documents, regardless of the method of binding.

### **9. ENGINEER**

The person or organization identified as such in the Contract Documents. The Term "ENGINEER" means ENGINEER or his authorized representative.

### **10. NOTICE**

The term "notice" or the requirement to notify, as used in the Contract Documents or applicable state or federal statutes, shall signify a written communication delivered in person or by registered mail to the individual, or to a member of the firm, or to an officer of the corporation for whom it is intended. Certified or registered mail shall be addressed to the last business address known to him who gives the notice.

### **11. OR EQUAL**

The term "or equal" shall be understood to indicate that the "equal" Product is equivalent to or better than the Product named in function, performance, reliability, quality, and general configuration. Determination of equality in reference to the Project design requirements will be made by the ENGINEER. Such equal Products shall not be purchased or installed by the CONTRACTOR without written authorization.

### **12. OWNER**

The person, organization, or public body identified as such in the Contract Documents.

### **13. PLANS (See Drawings)**

### **14. SPECIFICATIONS**

The term "Specifications" refers to those portions of the Contract Documents consisting of written technical descriptions of materials, equipment, construction systems, standards, and workmanship as applied to the work and certain

administrative details applicable thereto. Where standard specifications, such as those of ASTM, AASHTO, etc., have been referred to, the applicable portions of such standard specifications shall become a part of these Contract Documents. If referenced specifications conflict with specifications contained herein, the requirements contained herein shall prevail.

## **15. NOTICE TO PROCEED**

A written notice given by the OWNER to the CONTRACTOR (with a copy to the ENGINEER) fixing the date on which the Contract time will commence to run and on which the CONTRACTOR shall start to perform his obligation under the Contract Documents. The Notice to Proceed will be given within 30 days following the execution of the Contract by the OWNER.

## **16. SUBSTANTIAL COMPLETION**

“Substantial Completion” shall be that degree of completion of the Project or a defined portion of the Project, as evidenced by the ENGINEER’s written notice of Substantial Completion, sufficient to Provide the OWNER, at his discretion, the full-time use of the Project or defined portion of the Project for the purposes for which it was intended. “Substantial Completion” of an operating facility shall be that degree of completion that has Provided a minimum of 7 continuous days of successful, trouble-free, operation, which period shall begin after all performance and acceptance testing has been successfully demonstrated to the ENGINEER. All equipment contained in the work, plus all other components necessary to enable the OWNER to operate the facility in a manner that was intended, shall be complete on the substantial completion date.

## **17. WORK**

The word “work” within these Contract Documents shall include all material, labor, tools, and all appliances, machinery, transportation, and appurtenances necessary to perform and complete the Contract, and such additional items not specifically indicated or described which can be reasonably inferred as belonging to the item described or indicated and as required by good Practice to Provide a complete and satisfactory system or structure. As used herein, “Provide” shall be understood to mean “furnish and install, complete in-place “.

## **CONTRACT DOCUMENTS**

### **18. INTENT OF CONTRACT DOCUMENTS**

The Contract Documents are complementary, and what is called for by one shall be as binding as if called for by all. The intent of the Documents is to describe a functionally complete Project (or part thereof) to be constructed in accordance with

the Contract Documents. Any work, materials, or equipment that may reasonably be inferred from the Contract Documents as being required to produce the intended result shall be supplied whether or not specifically called for. When words which have a well-known technical or trade meaning are used to describe work, materials, or equipment, such words shall be interpreted in accordance with that meaning.

Reference to standard specifications, manuals, or codes of any technical society, organization or association, or to the laws or regulations of any governmental authority, whether such reference be specific or by implication, shall mean the latest standard specification, manual, code or laws or regulations in effect on the first published date of the Invitation to Bid, except as may be otherwise specifically stated. However, no Provision of any referenced standard specification, manual or code (whether or not specifically incorporated by reference in the Contract Documents) shall be effective to change the duties and responsibilities of OWNER, CONTRACTOR, or ENGINEER, or any of their consultants, agents, or employees from those set forth in the Contract Documents, nor shall it be effective to assign to ENGINEER, or any ENGINEER’s consultants, agents, or employees, any duty or authority to supervise or direct the furnishing or performance of the work or any duty or authority to undertake responsibility contrary to the Provisions of Article LIMITATIONS ON ENGINEER’S RESPONSIBILITIES.

### **19. DISCREPANCIES AND OMISSIONS**

Any discrepancies or omissions found in the Contract Documents shall be reported to the ENGINEER immediately. The ENGINEER will clarify discrepancies or omissions, in writing, within a reasonable time.

In resolving inconsistencies among two or more sections of the Contract Documents, Precedence shall be given in the following order:

- A. CONTRACT
- B. PROPOSAL
- C. SUPPLEMENTARY CONDITIONS
- D. INVITATION TO BID
- E. INSTRUCTIONS TO BIDDERS
- F. GENERAL CONDITIONS
- G. SPECIFICATIONS
- H. DRAWINGS

Addenda shall take Precedence over all sections referenced therein. Figure dimensions on Drawings shall take precedence over scale dimensions. Detailed Drawings shall take precedence over general Drawings.

### **20. CHANGES IN THE WORK**

The OWNER, without notice to the Sureties and without invalidating the Contract, may order changes in the work



within the general scope of the Contract by altering, adding to, or deducting from the work, the Contract being adjusted accordingly. All such work shall be executed under the conditions of the original Contract, except as specifically adjusted at the time of ordering such change.

In giving instructions, the ENGINEER may order minor changes in the work not involving extra cost and not inconsistent with the purposes of the Project, but otherwise, except in an emergency endangering life and Property, additions or deductions from the work shall be performed only in pursuance of an approved Change Order from the OWNER, countersigned by the ENGINEER.

If the work is reduced by alterations, such action shall not constitute a claim for damages based on loss of anticipated Profits.

#### **21. EXAMINATION AND VERIFICATION OF CONTRACT DOCUMENTS**

The CONTRACTOR shall thoroughly examine and become familiar with all of the various parts of these Contract Documents and determine the nature and location of the work, the general and local conditions, and all other matters, which can in any way affect the work under this Contract. Failure to make an examination necessary for this determination shall not release the CONTRACTOR from the obligations of this Contract. No verbal agreement or conversation with any officer, agent, or employee of the OWNER or with the ENGINEER either before or after the execution of this Contract shall affect or modify any of the terms or obligations herein contained.

#### **22. DOCUMENTS TO BE KEPT ON THE JOBSITE**

The CONTRACTOR shall keep one copy of the Contract Documents on the job- site, in good order, available to the ENGINEER and to his representatives.

The CONTRACTOR shall maintain on a daily basis at the jobsite, and make available to the ENGINEER on request, one current record set of the Drawings which have been accurately marked to indicate all modifications in the completed work that differ from the design information shown on the Drawings. Upon Substantial completion of the work, the CONTRACTOR shall give the ENGINEER one complete set of these marked up record Drawings.

#### **23. ADDITIONAL CONTRACT DOCUMENTS**

Copies of Contract Documents or Drawings may be obtained on request from the ENGINEER and by paying the actual cost of reproducing the Contract Documents or Drawings.

#### **24. OWNERSHIP OF CONTRACT DOCUMENTS**

All portions of the Contract Documents, and copies thereof furnished by the ENGINEER are instruments of service for this Project. They are not to be used on other work and are to be returned to the ENGINEER on request at the completion of the work. Any reuse of these materials without specific written verification or adaptation by the ENGINEER will be at the risk of the user and without liability or legal expense to the ENGINEER. Such user shall hold the ENGINEER harmless from any and all damages, including reasonable attorneys' fees, from any and all claims arising from any such reuse. Any such verification and adaptation shall entitle the ENGINEER to further compensation at rates to be agreed upon by the user and the ENGINEER.

#### **THE ENGINEER**

#### **25. AUTHORITY OF THE ENGINEER**

The ENGINEER will be the OWNER's representative during the construction period. His authority and responsibility will be limited to the Provisions set forth in these Contract Documents. The ENGINEER will have the Authority to reject work that does not conform to the Contract Documents. However, neither the ENGINEER's authority to act under this Provision, nor any decision made by him in good faith either to exercise or not to exercise such authority, shall give rise to any duty or responsibility of the ENGINEER to the CONTRACTOR, any SUBCONTRACTOR, their respective Sureties, any of their agents or employees, or any other person performing any of the work.

#### **26. DUTIES AND RESPONSIBILITIES OF THE ENGINEER**

The ENGINEER will make visits to the site at intervals appropriate to the various stages of construction to observe the Progress and quality of the work and to determine, in general, if the work is proceeding in accordance with the intent of the Contract Documents. He will not make comprehensive or continuous review or observation to check quality or quantity of the work, and he will not be responsible for construction means, methods, techniques, sequences, or Procedures, or for safety Precautions and Programs in connection with the work. Visits and observations made by the ENGINEER shall not relieve the CONTRACTOR of his obligation to conduct comprehensive inspections of the work and to furnish materials and perform acceptable work, and to provide adequate safety Precautions, in conformance with the intent of the Contract.

The ENGINEER will make recommendations to the OWNER, in writing, on all claims of the OWNER or the CONTRACTOR arising from interpretation or execution of

the Contract Documents. Such recommendations will be of factual and/or technical nature, and will not include the legal interpretation of the Contract Documents. Any necessary legal interpretation of the Contract Document will be made by the OWNER. Such recommendation shall be necessary before the CONTRACTOR can receive additional money under the terms of the Contract. Changes in work ordered by the ENGINEER shall be made in compliance with Article CHANGES IN THE WORK.

One or more Project representatives may be assigned to observe the work. It is understood that such Project representatives shall have the authority to issue notice of nonconformance and make decisions within the limitations of the authority of the ENGINEER. The CONTRACTOR shall furnish all reasonable assistance required by the ENGINEER or Project representatives for Proper observation of the work. The above-mentioned Project representatives shall not relieve the CONTRACTOR of his obligations to conduct comprehensive inspections of the work and to furnish materials and perform acceptable work, and to provide adequate safety Precautions, in conformance with the intent of the Contract.

#### **27. LIMITATIONS ON ENGINEER'S RESPONSIBILITIES**

ENGINEER will not be responsible for CONTRACTOR's means, methods, techniques, sequences, or Procedures of construction, or the safety Precautions and Programs incident thereto, and ENGINEER will not be responsible for CONTRACTOR's failure to perform or furnish the work in accordance with the Contract Documents.

ENGINEER will not be responsible for the acts or omissions of CONTRACTOR or of any SUBCONTRACTOR, any supplier, or of any other person or organization performing or furnishing any of the work.

Whenever in the Contract Documents the terms "as ordered", "as directed", "as required", "as allowed", "as approved", or terms of like effect or import are used, or the adjectives "reasonable", "suitable", "acceptable", "Proper", or "satisfactory", or adjectives of like effect or import are used to describe a requirement, direction, review or judgment of ENGINEER as to the work, it is intended that such requirement, direction, review or judgment will be solely to evaluate the work for compliance with the Contract Documents (unless there is a specific statement indicating otherwise). The use of any such term or adjective shall not be effective to assign to ENGINEER any duty or authority to supervise or direct the furnishing or performance of the work or any duty or authority to undertake responsibility contrary to the Provisions of this Article.

#### **28. REJECTED WORK**

Any defective work or nonconforming materials or equipment that may be discovered at any time prior to expiration of the warranty period shall be removed and replaced by work which shall conform to the Provisions of the Contract Documents. Any material condemned or rejected shall be removed at once from the Project site.

Failure on the part of the ENGINEER to condemn or reject bad or inferior work or to note nonconforming materials or equipment on CONTRACTOR submittals shall not be construed to imply acceptance of such work. The OWNER shall reserve and retain all of its rights and remedies at law against the CONTRACTOR and its Surety for correction of any and all latent defects discovered after the guarantee period.

#### **29. LINES AND GRADES**

Lines and grades shall be established as provided in the supplementary conditions. All stakes, marks, and other reference information shall be carefully preserved by the CONTRACTOR, and in case of their careless or unnecessary destruction or removal by him or his employees, such stakes, marks, and other information shall be replaced at the CONTRACTOR's expense.

#### **30. SUBMITTALS**

After checking and verifying all field measurements and after complying with applicable Procedures specified in Division I, GENERAL REQUIREMENTS, CONTRACTOR shall submit to ENGINEER, in accordance with the schedule for submittals for review, shop drawings, electrical diagrams, and catalog cuts for fabricated items and manufactured items (including mechanical and electrical equipment), which shall bear a stamp or specific written indication that CONTRACTOR has satisfied CONTRACTOR's responsibilities under the Contract Documents with respect to the review of the submittal. All submittals shall be identified as ENGINEER may require. The data shown shall be complete with respect to quantities, dimensions specified, performance and design criteria, materials, and similar data to enable ENGINEER to review the information. CONTRACTOR shall also submit to ENGINEER for review, with such Promptness as to cause no delay in work, all samples required by the Contract Documents. All samples shall have been checked by and accompanied by a specific written indication that CONTRACTOR has satisfied CONTRACTOR's responsibilities under the Contract Documents with respect to the review of the submission and shall be identified clearly as to material, supplier, pertinent data such as catalog numbers and the use for which intended.

Before submission of each submittal, CONTRACTOR shall have determined and verified all quantities, dimensions, specified performance criteria, installation requirements,

materials, catalog numbers, and similar data with respect thereto and reviewed or coordinated each submittal with other submittals and with the requirements of the work and the Contract Documents.

At the time of each submission, CONTRACTOR shall give ENGINEER specific written notice of each variation that the submittal may have from the requirements of the Contract Documents, and, in addition, shall cause a specific notation to be made on each shop drawing submitted to ENGINEER for review and approval of each variation.

ENGINEER will review submittals with reasonable Promptness, but ENGINEER's review will be only for conformance with the design concept of the Project and for compliance with the information given in the Contract Documents and shall not extend to means, methods, techniques, sequences, or Procedures of construction (except where a specific means, method, technique, sequence, or Procedure of construction is indicated in or required by the Contract Documents) or to safety Precautions or Programs incident thereto. The review of a separate item as such will not indicate review of the assembly in which the item functions. CONTRACTOR shall make corrections required by ENGINEER, and shall return the required number of corrected copies of shop drawings and submit as required new samples for review. CONTRACTOR shall direct specific attention in writing to revisions other than the corrections called for by ENGINEER on Previous submittals.

ENGINEER's review of submittals shall not relieve CONTRACTOR from the responsibility for any variation from the requirements of the Contract Documents unless CONTRACTOR has in writing called ENGINEER's attention to each such variation at the time of submission and ENGINEER has given written approval of each such variation by a specific written notation thereof incorporated therein or accompanying the shop drawing or sample approval; nor will any approval by ENGINEER relieve CONTRACTOR from responsibility for errors or omissions in the shop drawings or from responsibility for having complied with the Provisions herein.

Where a shop drawing or sample is required by the specifications, any related work performed Prior to ENGINEER's review and approval of the pertinent submission shall be at the sole expense and responsibility of the CONTRACTOR.

### **31. DETAIL DRAWINGS AND INSTRUCTIONS**

The ENGINEER will furnish, with reasonable Promptness, additional instructions by means of Drawings or otherwise, if, in the ENGINEER's opinion, such are required for the Proper execution of the work. All such Drawings and instructions will be consistent with the Contract Documents, true

developments thereof, and reasonably inferable there from.

## **THE CONTRACTOR AND HIS EMPLOYEES**

### **32. CONTRACTOR, AN INDEPENDENT AGENT**

The CONTRACTOR shall independently perform all work under this Contract and shall not be considered as an agent of the OWNER or of the ENGINEER, nor shall the CONTRACTOR's SUBCONTRACTORS or employees be subagents of the OWNER or of the ENGINEER.

#### **32. (a) ASSIGNMENT OF CONTRACT**

Assignment of any part or the whole of this Contract shall be subject to review and approval of the City Commission.

### **33. SUBCONTRACTING**

Unless modified in the Supplementary Conditions, within 10 days after the execution of the Contract, the CONTRACTOR shall submit to the ENGINEER the names of all SUBCONTRACTORS Proposed for the work, including the names of any SUBCONTRACTORS that were submitted with the Proposal. The CONTRACTOR shall not employ any SUBCONTRACTORS to which the OWNER may object to as lacking capability to properly perform work of the type and scope anticipated.

The CONTRACTOR is as fully responsible to the OWNER for the acts and omissions of his SUBCONTRACTORS and of persons either directly or indirectly employed by them as he is for the acts and omissions of persons directly employed by him.

Nothing contained in the Contract Documents shall create any contractual relationship between any SUBCONTRACTOR and the OWNER or ENGINEER.

### **34. INSURANCE AND LIABILITY**

#### **A. GENERAL**

The CONTRACTOR shall provide (from insurance companies acceptable to the OWNER) the insurance coverage designated hereinafter and pay all costs before commencing work under this Contract. The CONTRACTOR shall furnish the OWNER with certificates of insurance specified herein showing the type, amount class of operations covered, effective dates, and date of expiration of policies, and containing substantially the following statement:

"The insurance covered by this certificate shall not be canceled or materially altered, except after 30 days' written notice has been received by the OWNER."

In case of the breach of any Provision of this Article, the OWNER, at his option, may take out and maintain, at the expense of the CONTRACTOR, such insurance as the OWNER may deem Proper and may deduct the cost of such insurance from any monies which may be due or become due the CONTRACTOR under this Contract.

**B. CONTRACTOR AND SUBCONTRACTOR INSURANCE**

The CONTRACTOR shall not commence work under this Contract until he has obtained all the insurance required hereunder and such insurance has been reviewed by the OWNER, nor shall the CONTRACTOR allow any SUBCONTRACTOR to commence work on his subcontract until insurance specified below has been obtained. Review of the insurance by the OWNER shall not relieve or decrease the liability of the CONTRACTOR hereunder.

**C. COMPENSATION AND EMPLOYER'S LIABILITY INSURANCE**

The CONTRACTOR shall maintain during the life of this Contract the statutory amount of Workmen's Compensation Insurance, in addition, Employer's Liability Insurance in an amount as specified in the Supplementary Conditions, for each occurrence, for all of his employees to be engaged in work on the Project under this Contract. In case any such work is subcontracted, the CONTRACTOR shall require the SUBCONTRACTOR to provide similar Workmen's Compensation and Employer's Liability Insurance for all of the SUBCONTRACTOR's employees to be engaged in such work.

**D. GENERAL LIABILITY INSURANCE (INCLUDING AUTOMOBILE)**

The CONTRACTOR shall maintain during the life of this Contract such general liability, completed operations and Products liability, and automobile liability insurance as will Provide coverage for claims for damages for personal injury, including accidental death, as well as for claims for Property damage, which may arise directly or indirectly from performance of the work under this Contract. The general liability policy shall include contractual liability assumed by the CONTRACTOR under Article INDEMNITY. Coverage for Property damage shall be on a "broad form" basis with no exclusions for "X, C & U". The amount of insurance to be provided shall be as specified in the Supplementary Conditions.

In the event any work under this Contract is performed by a SUBCONTRACTOR, the CONTRACTOR shall be responsible for any liability directly or indirectly arising out of the work performed by the SUBCONTRACTOR; to the extent such liability is not covered by the SUBCONTRACTOR's

insurance.

The OWNER and ENGINEER, their officers, agents, and employees shall be named as Additional Insured's on the CONTRACTOR's and any SUBCONTRACTOR's general liability and automobile liability insurance policies for any claims arising out of work performed under this Contract.

**E. BUILDERS RISK ALL RISK INSURANCE**

Unless otherwise modified in the Supplementary Conditions, the CONTRACTOR shall secure and maintain during the life of this Contract, Builders Risk All Risk Insurance coverage in an amount equal to the full value of the facilities under construction. Such insurance shall include coverage for earthquake, landslide, flood, collapse, loss due to the results of faulty workmanship or design, and all other normally covered risks, and shall provide for losses to be paid to the CONTRACTOR, OWNER, and ENGINEER as their interests may appear.

The OWNER and ENGINEER, their officers, agents, and employees shall be named as additional insured's on the CONTRACTOR's and any SUBCONTRACTOR's Builders Risk All Risk insurance policies for any claims arising out of work performed under this Contract.

This insurance shall include a waiver of subrogation as to the ENGINEER, the OWNER, the CONTRACTOR, and their respective officers, agents, employees and SUBCONTRACTORS.

**F. NO PERSONAL LIABILITY OF PUBLIC OFFICIALS**

In carrying out any of the Provisions hereof in exercising any authority granted by the Contract, there will be no personal liability upon any public official.

**35. INDEMNITY**

To the maximum extent permitted by law, the CONTRACTOR shall indemnify and defend the OWNER and the ENGINEER, and their officers, employees, agents, and sub-consultants, from all claims and losses, including attorney's fees and litigation costs arising out of Property losses or health, safety, personal injury, or death claims by the CONTRACTOR, its SUBCONTRACTORS of any tier, and their employees, agents, or invitees regardless of the fault, breach of Contract, or negligence of the OWNER or ENGINEER, excepting only such claims or losses that have been adjudicated to have been caused solely by the negligence of the OWNER or the ENGINEER and regardless of whether or not the CONTRACTOR is or can be named a party in a litigation.

**36. EXCLUSION OF CONTRACTOR CLAIMS**

In performing its obligations, the ENGINEER and its consultants may cause expense for the CONTRACTOR or its SUBCONTRACTORS and equipment or material suppliers. However, those parties and their sureties shall maintain no direct action against the ENGINEER, its officers, employees, agents, and consultants for any claim arising out of, in connection with, or resulting from the engineering services performed or required to be performed.

**37. TAXES AND CHARGES**

The CONTRACTOR shall withhold and pay any and all sales and use taxes and all withholding taxes, whether State or Federal, and pay all Social Security charges and also all State Unemployment Compensation charges, and pay or cause to be withheld, as the case may be, any and all taxes, charges, or fees or sums whatsoever, which are now or may hereafter be required to be paid or withheld under any laws.

**38. REQUIREMENTS OF STATE LAW FOR PUBLIC WORKS PROJECTS**

When the Contract Documents concern public works of the state or any county, municipality, or political subdivision created by its laws, the applicable statutes shall apply. All parties to this Contract shall determine the contents of all applicable statutes and comply with their Provisions throughout the performance of the Contract.

**39. CODES, ORDINANCES, PERMITS AND LICENSES**

The CONTRACTOR shall keep himself fully informed of all local codes and ordinances, as well as state and federal laws, which in any manner affect the work herein specified. The CONTRACTOR shall at all times comply with said codes and ordinances, laws, and regulations, and Protect and indemnify the OWNER, the ENGINEER and their respective employees, and its officers and agents against any claim or liability arising from or based on the violation of any such laws, ordinances, or regulations. All permits, licenses and inspection fees necessary for Prosecution and completion of the work shall be secured and paid for by the CONTRACTOR, unless otherwise specified.

**40. SUPERINTENDENCE**

The CONTRACTOR shall keep at the project site, competent supervisory personnel. The CONTRACTOR shall designate, in writing, before starting work, a Project superintendent who shall be an employee of the CONTRACTOR and shall have complete authority to represent and to act for the CONTRACTOR. ENGINEER shall be notified in writing

prior to any change in superintendent assignment. The CONTRACTOR shall give efficient supervision to the work, using his best skill and attention. The CONTRACTOR shall be solely responsible for all construction means, methods, techniques, and Procedures, and for providing adequate safety Precautions and coordinating all portions of the work under the Contract. It is specifically understood and agreed that the ENGINEER, its employees and agents, shall not have control or charge of and shall not be responsible for the construction means, methods, techniques, Procedures, or for providing adequate safety Precautions in connection with the work under Contract.

**41. RECEPTION OF ENGINEER'S COMMUNICATIONS**

The superintendent shall receive for the CONTRACTOR all communications from the ENGINEER. Communications of major importance will be confirmed in writing upon request from the CONTRACTOR.

The ENGINEER may schedule Project meetings for the purposes of discussing and resolving matters concerning the various elements of the work. Time and place for these meetings and the names of persons required to be Present shall be as determined by the ENGINEER. CONTRACTOR shall comply with these attendance requirements and shall also require his SUBCONTRACTORS to comply.

**42. SAFETY**

The CONTRACTOR shall be solely and completely responsible for conditions of the jobsite, including safety of all persons (including employees) and Property during performance of the work. This requirement shall apply continuously and not be limited to normal working hours. Safety Provisions shall conform to U.S. Department of Labor (OSHA), and all other applicable federal, state, county, and local laws, ordinances, codes, and regulations. Where any of these are in conflict, the more stringent requirement shall be followed. The CONTRACTOR's failure to thoroughly familiarize himself with the aforementioned safety Provisions shall not relieve him from compliance with the obligations and penalties set forth therein.

The CONTRACTOR shall develop and maintain for the duration of this Contract, a safety Program that will effectively incorporate and implement all required safety Provisions. The CONTRACTOR shall appoint an employee who is qualified and authorized to supervise and enforce compliance with the safety Program. The duty of the ENGINEER to conduct construction review of the work does not include review or approval of the adequacy of the CONTRACTOR's safety Program, safety supervisor, or any safety measures taken in, on, or near the construction site. The CONTRACTOR, as a part of his safety Program, shall maintain at his office or other well-known place at the jobsite, safety equipment applicable to

the work as Prescribed by the aforementioned authorities, all articles necessary for giving first-aid to the injured, and shall establish the Procedure for the immediate removal to a hospital or a doctor's care of persons (including employees) who may be injured on the jobsite.

If death or serious injuries or serious damages are caused, the accident shall be reported immediately by telephone or messenger to both the ENGINEER and the OWNER. In addition, the CONTRACTOR must promptly report in writing to the ENGINEER all accidents whatsoever arising out of, or in connection with, the performance of the work whether on, or adjacent to, the site, giving full details and statements of witnesses.

If a claim is made by anyone against the CONTRACTOR or any SUBCONTRACTOR on account of any accident, the CONTRACTOR shall promptly report the facts in writing to the ENGINEER, giving full details of the claim.

#### **43. PROTECTION OF WORK AND PROPERTY**

The CONTRACTOR shall at all times safely guard and Protect from damage the OWNER's Property, adjacent Property, and his own work from injury or loss in connection with this Contract. All facilities required for Protection by federal, state, or municipal laws and regulations and local conditions must be provided and maintained.

The CONTRACTOR shall Protect his work and materials from damage due to the nature of the work, the elements, carelessness of other CONTRACTORS, or from any cause whatever until the completion and acceptance of the work. All loss or damages arising out of the nature of the work to be done under these Contract Documents, or from any unforeseen obstruction or defects which may be encountered in the Prosecution of the work, or from the action of the elements, shall be sustained by the CONTRACTOR.

#### **44. RESPONSIBILITY OF CONTRACTOR TO ACT IN AN EMERGENCY**

In case of an emergency which threatens loss or injury of Property, and/or safety of life, the CONTRACTOR shall act, without previous instructions from the OWNER or ENGINEER, as the situation may warrant. The CONTRACTOR shall notify the ENGINEER thereof immediately thereafter. Any claim for compensation by the CONTRACTOR, together with substantiating documents in regard to expense, shall be submitted to the OWNER through the ENGINEER and the amount of compensation shall be determined by agreement.

#### **45. MATERIALS AND APPLIANCES**

Unless otherwise stipulated, the CONTRACTOR shall Provide and pay for all materials, labor, water, tools,

equipment, heat, light, fuel, power, transportation, construction equipment and machinery, appliances, telephone, sanitary facilities, temporary facilities and other facilities and incidentals necessary for the execution and completion of the work.

Unless otherwise specified, all materials shall be new, and both workmanship and materials shall be of good quality. The CONTRACTOR shall, if required, furnish satisfactory evidence as to the kind and quality of materials.

In selecting and/or approving equipment for installation in the Project, the OWNER and ENGINEER assume no responsibility for injury or claims resulting from failure of the equipment to comply with applicable federal, state, and local safety codes or requirements, or the safety requirements of a recognized agency, or failure due to faulty design concepts, or defective workmanship and materials.

#### **46. CONTRACTORS' AND MANUFACTURERS' COMPLIANCE WITH STATE SAFETY, OSHA, AND OTHER CODE REQUIREMENTS**

The completed work shall include all necessary permanent safety devices, such as machinery guards and similar ordinary safety items required by the state and federal (OSHA) industrial authorities and applicable local and national codes. Further, any features of the work subject to such safety regulations shall be fabricated, furnished, and installed (including OWNER-furnished equipment) in compliance with these requirements. CONTRACTORS and manufacturers of equipment shall be held responsible for compliance with the requirements included herein. CONTRACTORS shall notify all equipment suppliers and SUBCONTRACTORS of the Provisions of this Article.

#### **47. SUBSTITUTION OF MATERIALS**

Except for OWNER-selected equipment items, and items where no substitution is clearly specified, whenever any material, article, device, Product, fixture, form, type of construction, or Process is indicated or specified by patent or Proprietary name, by name of manufacturer, or by catalog number, such specifications shall be deemed to be used for the purpose of establishing a standard of quality and facilitating the description of the material or Process desired. This Procedure

is not to be construed as eliminating from competition other Products of equal or better quality by other manufacturers where fully suitable in design, and shall be deemed to be followed by the words "or equal". The CONTRACTOR may, in such cases, submit complete data to the ENGINEER for consideration of another material, type, or Process that shall be substantially equal in every respect to that so indicated or specified. Substitute materials shall not be used unless approved in writing. The ENGINEER will be the sole judge

of the substituted article or material.

#### **48. TESTS, SAMPLES, AND OBSERVATIONS**

The CONTRACTOR shall furnish, without extra charge, the necessary test pieces and samples, including facilities and labor for obtaining the same, as requested by the ENGINEER. When required, the CONTRACTOR shall furnish certificates of tests of materials and equipment made at the point of manufacture by a recognized testing laboratory.

The OWNER, ENGINEER, and authorized government agents, and their representatives shall at all times be Provided safe access to the work wherever it is in Preparation or Progress, and the CONTRACTOR shall Provide facilities for such access and for observations, including maintenance of temporary and permanent access.

If the Specifications, laws, ordinances, or any public authority require any work, to be specially tested or approved, the CONTRACTOR shall give timely notice of its readiness for observations. If any work should be covered up without approval or consent of the ENGINEER, it shall, if required by the ENGINEER, be uncovered for examination at the CONTRACTOR's expense.

Reexamination of questioned work may be ordered by the ENGINEER, and, if so ordered, the work shall be uncovered by the CONTRACTOR. If such work is found to be in accordance with the Contract Documents, the OWNER will pay the cost of uncovering, exposure, observation, inspection, testing and reconstruction. If such work is found to be not in accordance with the Contract Documents, the CONTRACTOR shall correct the defective work, and the cost of reexamination and correction of the defective work shall be paid by the CONTRACTOR.

#### **49. ROYALTIES AND PATENTS**

The CONTRACTOR shall pay all royalty and licenses fees, unless otherwise specified. The CONTRACTOR shall defend all suits or claims for infringement of any patent rights and shall save the OWNER and the ENGINEER harmless from any and all loss, including reasonable attorneys' fees, on account thereof.

#### **50. CONTRACTOR'S RIGHT TO TERMINATE CONTRACT**

If the work should be stopped under an order of any court or other public authority for a period of more than 3 months, through no act or fault of the CONTRACTOR, its SUBCONTRACTORS, or respective employees or if the ENGINEER should fail to make recommendation for payment to the OWNER or return payment request to CONTRACTOR for revision within 30 days after it is due, or if the OWNER should fail to pay the CONTRACTOR within 30 days after

time specified in Article PARTIAL PAYMENTS, any sum recommended by the ENGINEER, then the CONTRACTOR may, upon 15 days' written notice to the OWNER and the ENGINEER, stop work or terminate this Contract and recover from the OWNER payment for all acceptable work performed and reasonable termination expenses, unless said default has been remedied.

#### **51. CORRECTION OF DEFECTIVE WORK DURING WARRANTY PERIOD**

The CONTRACTOR hereby agrees to make, at his own expense, all repairs or replacements necessitated by defects in materials or workmanship, Provided under terms of this Contract, and pay for any damage to other works resulting from such defects, which become evident within 2 years after the date of final acceptance of the work or within 2 years after the date of substantial completion established by the ENGINEER for specified items of equipment, or within such longer period as may be Prescribed by law or by the terms of any applicable special guarantee required by the Contract Documents. Un-remedied defects identified for correction during the warranty period but remaining after its expiration shall be considered as part of the obligations of the warranty. Defects in material, workmanship, or equipment which are remedied as a result of obligations of the warranty shall subject the remedied portion of the work to an extended warranty period of 2 years after the defect has been remedied.

The CONTRACTOR further assumes responsibility for a similar guarantee for all work and materials provided by SUBCONTRACTORS or manufacturers of packaged equipment components. The effective date for the start of the guarantee or warranty period for equipment qualifying as substantially complete is defined in Article SUBSTANTIAL COMPLETION, AND Article SUBSTANTIAL COMPLETION DATE, in these General Conditions.

The CONTRACTOR also agrees to hold the OWNER and the ENGINEER harmless from liability of any kind arising from damage due to said defects. The CONTRACTOR shall make all repairs and replacements promptly upon receipt of written order for same from the OWNER. If the CONTRACTOR fails to make the repairs and replacements promptly, or in an emergency where delay would cause serious risk, or loss, or damage, the OWNER may have the defective work corrected or the rejected work removed and replaced, and the CONTRACTOR and his Surety shall be liable for the cost thereof.

#### **PROGRESS OF THE WORK**

#### **52. BEGINNING OF THE WORK**

Following execution of the Contract, the CONTRACTOR shall meet with the OWNER and ENGINEER relative to his



arrangements for prosecuting the work.

### **53. SCHEDULES AND PROGRESS REPORTS**

Prior to starting the construction, the CONTRACTOR shall Prepare and submit to the ENGINEER, a Progress schedule showing the dates on which each part or division of the work is expected to be started and finished, and a Preliminary schedule for submittals. The Progress schedule for submittals shall be brought up to date and submitted to the ENGINEER at the end of each month or at such other times the ENGINEER may request.

The CONTRACTOR shall forward to the ENGINEER, at the end of each month, an itemized report of the delivery status of major and critical items of purchased equipment and material, including shop drawings and the status of shop and field fabricated work. These Progress reports shall indicate the date of the purchase order, the current percentage of completion, estimated delivery, and cause of delay, if any.

If the completion of any part of the work or the delivery of materials is behind the submitted Progress schedule, the CONTRACTOR shall submit in writing a plan acceptable to the OWNER and ENGINEER for bringing the work up to schedule.

The OWNER shall have the right to withhold Progress payments for the work if the CONTRACTOR fails to update and submit the Progress schedule and reports as specified.

### **54. PROSECUTION OF THE WORK**

It is expressly understood and agreed that the time of beginning, rate of Progress, and time of completion of the work are the essence of this Contract. The work shall be prosecuted at such time, and in or on such part or parts of the Project as may be required, to complete the Project as contemplated in the Contract Documents and the Progress schedule.

If the CONTRACTOR desires to carry on work at night or outside the regular hours, he shall give timely notice to the ENGINEER to allow satisfactory arrangements to be made for observing the work in Progress.

### **55. OWNER'S RIGHT TO RETAIN IMPERFECT WORK**

If any part or portion of the work completed under this Contract shall Prove defective and not in accordance with the Drawings and Specifications, and if the imperfection in the same shall not be of sufficient magnitude or importance as to make the work dangerous or unsuitable, or if the removal of such work will create conditions which are dangerous or undesirable, the OWNER shall have the right and authority to

retain such work but will make such deductions in the final payment therefore as may be just and reasonable.

### **56. OWNER'S RIGHT TO DO WORK**

Should the CONTRACTOR neglect to Prosecute the work in conformance with the Contract Documents or neglect or refuse at his own cost to remove and replace work rejected by the ENGINEER, then the OWNER may notify the Surety of the condition, and after 10 days' written notice to the CONTRACTOR and the Surety, or without notice if an emergency or danger to the work or public exists, and without Prejudice to any other right which the OWNER may have under Contract, or otherwise, take over that portion of the work which has been improperly or non timely executed, and make good the deficiencies and deduct the cost thereof from the payments then or thereafter due the CONTRACTOR.

### **57. OWNER'S RIGHT TO TRANSFER EMPLOYMENT**

If the CONTRACTOR should abandon the work or if he should persistently or repeatedly refuse or should fail to make prompt payment to SUBCONTRACTORS for material or labor, or to persistently disregard laws, ordinances, or to prosecute the work in conformance with the Contract Documents, or otherwise be guilty of a substantial violation of any Provision of the Contract or any laws or ordinance, then the OWNER may, without Prejudice to any other right or remedy, and after giving the CONTRACTOR and Surety 10 days' written notice, transfer the employment for said work from the CONTRACTOR to the Surety. Upon receipt of such notice, such Surety shall enter upon the Premises and take possession of all materials, tools, and appliances thereon for the purpose of completing the work included under this contract and employ by Contract or otherwise, any qualified person or persons to finish the work and Provide the materials therefore, in accordance with the Contract Documents, without termination of the continuing full force and effect of this contract. In case of such transfer of employment to such Surety, the Surety shall be paid in its own name on estimates according to the terms hereof without any right of the CONTRACTOR to make any claim for the same or any part thereof.

If, after the furnishing of said written notice to the Surety, the CONTRACTOR and the Surety still fail to make reasonable Progress on the performance of the work, the OWNER may terminate the employment of the CONTRACTOR and take possession of the Premises and of all materials, tools, and appliances thereon and finish the work by whatever method he may deem expedient and charge the cost thereof to the CONTRACTOR and the Surety. In such case, the CONTRACTOR shall not be entitled to receive any further payment until the work is finished. If the expense of



completing the Contract, including compensation for additional managerial and administrative services, shall exceed such unpaid balance, the CONTRACTOR and the Surety shall pay the difference to the OWNER.

#### **58. DELAYS AND EXTENSION OF TIME**

If the CONTRACTOR is delayed in the Progress of the work by any act or neglect of the OWNER or the ENGINEER, or by any separate CONTRACTOR employed by the OWNER, or by strikes, lockouts, fire, adverse weather conditions not reasonably anticipated, or acts of Nature, and if the CONTRACTOR, within 48 hours of the start of the occurrence, gives written notice to the OWNER of the cause of the potential delay and estimate of the possible time extension involved, and within 10 days after the cause of the delay has been remedied, the CONTRACTOR gives written notice to the OWNER of any actual time extension requested as a result of the aforementioned occurrence, then the Contract time may be extended by change order for such reasonable time as the ENGINEER determines. It is agreed that no claim shall be made or allowed for any damages, loss, or expense which may arise out of any delay caused by the above referenced acts or occurrences other than claims for the appropriate extension of time. No extension of time will be granted to the CONTRACTOR for delays occurring to parts of the work that have no measurable impact on the completion of the total work under this Contract. No extension of time will be considered for weather conditions reasonably anticipated for the area in which the work is being performed. Reasonably anticipated weather conditions will be based on official records of monthly Precipitation and other historical data. Adverse weather conditions, if determined to be of a severity that would impact Progress of the work, may be considered as cause for an extension of Contract completion time.

Delays in delivery of equipment or material purchased by the CONTRACTOR or his SUBCONTRACTORS, including OWNER-selected equipment shall not be considered as a just cause for delay, unless the OWNER determines that for good cause the delay is beyond the control of the CONTRACTOR. The CONTRACTOR shall be fully responsible for the timely ordering, scheduling, complete the work is the per-diem rate, as stipulated in the Proposal. The said amount is hereby agreed upon as a reasonable estimate of the costs, which may be accrued by the OWNER after the expiration of the time of completion. It is expressly understood and agreed that this amount is not to be considered in the nature of a penalty, but as liquidated damages which have accrued against the CONTRACTOR. The OWNER shall have the right to deduct such damages from any amount due, or that may become due the CONTRACTOR, or the amount of such damages shall be due and collectible from the CONTRACTOR or Surety.

#### **59. DIFFERING SITE CONDITIONS**

The CONTRACTOR shall promptly, and before the conditions are disturbed, give a written notice to the OWNER and ENGINEER of:

- A. subsurface or latent physical conditions at the site which differ materially from those indicated in this contract,
- B. unknown physical conditions at the site, of an unusual nature, which differ materially from those ordinarily encountered and generally recognized as inherent in work of the character provided for in the Contract.

The ENGINEER will investigate the site conditions promptly after receiving the notice. If the conditions do materially so differ and cause an increase or decrease in the CONTRACTOR's cost of, or the time required for, performing any part of the work under this Contract, whether or not changed as a result of the conditions, and equitable adjustment shall be made under this Article and the Contract modified in writing accordingly.

No request by the CONTRACTOR for an equitable adjustment to the Contract under this Article will be allowed, unless the CONTRACTOR has given the written notice required; Provided that the time prescribed above for giving written notice may be extended by the OWNER.

No request by the CONTRACTOR for an equitable adjustment to the Contract for differing site conditions will be allowed if made after final payment under this Contract.

#### **60. LIQUIDATED DAMAGES**

Should the CONTRACTOR fail to complete the work, or any part thereof, in the time agreed upon in the Contract or within such extra time as may have been allowed for delays by extensions granted as Provided in the Contract, the CONTRACTOR shall reimburse the OWNER for the additional expense and damage for each calendar day, Sundays and legal holidays included, that the Contract remains uncompleted after the Contract completion date. It is agreed that the amount of such additional expense and damage incurred by reason of failure to complete the work is the per-diem rate, as stipulated in the Proposal. The said amount is hereby agreed upon as a reasonable estimate of the costs which may be accrued by the OWNER after the expiration of the time of completion. It is expressly understood and agreed that this amount is not to be considered in the nature of a penalty, but as liquidated damages which have accrued against the CONTRACTOR. The OWNER shall have the right to deduct such damages from any amount due, or that may become due the CONTRACTOR, or the amount of such damages shall be due and collectible from the CONTRACTOR or Surety.

**61. OTHER CONTRACTS**

The OWNER reserves the right to let other Contracts in connection with the work. The CONTRACTOR shall afford other CONTRACTORS reasonable opportunity for the introduction and storage of their materials and the execution of their work and shall properly connect and coordinate his work with theirs.

If any part of the work under this Contract depends for Proper execution or results upon the work of any other CONTRACTOR, utility service company or OWNER, the CONTRACTOR shall inspect and Promptly report to the ENGINEER in writing any patent or apparent defects to deficiencies in such work that render it unsuitable for such Proper execution and results. The CONTRACTOR's failure to so report shall constitute and acceptance of the work by others as being fit and Proper for integration with work under this Contract, except for latent or non apparent defects and deficiencies in the work.

**62. USE OF PREMISES**

The CONTRACTOR shall confine his equipment, the storage of materials and the operation of his workers to limits shown on the Drawings or indicated by law, ordinances, permits, or directions of the ENGINEER, and shall not unreasonably encumber the Premises with his materials. The CONTRACTOR shall provide, at his own expense, the necessary rights-of-way and access to the work, which may be required outside the limits of the OWNER's Property and shall furnish the ENGINEER copies of permits and agreements for use of the Property outside that provided by the OWNER.

The CONTRACTOR shall not load nor permit any part of the structure to be loaded in any manner that will endanger the structure, nor shall CONTRACTOR subject any part of the work or adjacent Property to stresses or Pressures that will endanger it.

**63. SUBSTANTIAL COMPLETION DATE**

The ENGINEER may issue a written notice of substantial completion for the purpose of establishing the starting date for specific equipment guarantees, and to establish the date that the OWNER will assume the responsibility for the cost of operating such equipment. Said notice shall not be considered as final acceptance of any portion of the work or relieve the CONTRACTOR from completing the remaining work within the specified time and in full compliance with the Contract Documents. See SUBSTANTIAL COMPLETION under DEFINITIONS of these General Conditions.

**64. PERFORMANCE TESTING**

Operating equipment and systems shall be performance tested in the Presence of the ENGINEER to demonstrate compliance with the specified requirements. Performance testing shall be conducted under the specified design operating conditions or under such simulated operating conditions as recommended or approved by the ENGINEER. Schedule such testing with the ENGINEER at least one week in advance of the planned date for testing.

**65. OWNER'S USE OF PORTIONS OF THE WORK**

Following issuance of the written notice of Substantial Completion, the OWNER may initiate operation of the facility. Such use shall not be considered as final acceptance of any portion of the work, nor shall such use be considered as cause for an extension of the Contract completion time, unless authorized by a Change Order issued by the OWNER.

**66. CUTTING AND PATCHING**

The CONTRACTOR shall do all cutting, fitting, or patching of his work that may be required to make its several parts come together Properly and fit it to receive or be received by work of other CONTRACTORS shown upon or reasonably implied by the Drawings.

**67. CLEANING UP**

The CONTRACTOR shall, at all times, keep Property on which work is in Progress and the adjacent Property free from accumulations of waste material or rubbish caused by employees or by the work. Upon completion of the construction, the CONTRACTOR shall remove all temporary structures, rubbish, and waste materials resulting from his operations.

**PAYMENT**

**68. PAYMENT FOR CHANGE ORDERS**

The OWNER's request for quotations on alterations to the work shall not be considered authorization to proceed with the work expediting, delivery, and installation of all equipment and materials. Within a reasonable period after the CONTRACTOR submits to the OWNER a written request for an extension of time, the ENGINEER will Present his written opinion to the OWNER as to whether an extension of time is justified, and, if so, his recommendation as to the number of days for time extension. The OWNER will make the final decision on all requests for extension of time.

Prior to the issuance of a formal Change Order, nor shall such request justify any delay in existing work. Quotations for alterations to the work shall include substantiating documentation with an itemized breakdown of

CONTRACTOR and SUBCONTRACTOR costs, including labor, material, rentals, approved services, overhead, and profit. OWNER may require detailed cost data in order to substantiate the reasonableness of the proposed costs.

Any compensation paid in conjunction with the terms of a Change Order shall comprise total compensation due the CONTRACTOR for the work or alteration defined in the Change Order. By signing the Change Order, the CONTRACTOR acknowledges that the stipulated compensation includes payment for the work or alteration plus all payment for the interruption of schedules, extended overhead, delay, or any other impact claim or ripple effect, and by such signing specifically waives any reservation or claim for additional compensation in respect to the subject Change Order.

At the OWNER's option, payment or credit for any alterations covered by a Change Order shall be determined by one or a combination of the methods set forth in A, B, or C below, as applicable:

#### A. UNIT PRICES

Those unit Prices stipulated in the Proposal shall be utilized where they are applicable. In the event the Change Order results in a change in the original quantity that is materially and significantly different from the original bid quantity, a new unit Price shall be negotiated upon demand of either party. Unit Prices for new items included in the Change Order shall be negotiated and mutually agreed upon.

#### B. LUMP SUM

A total lump sum for the work negotiated and mutually acceptable to the CONTRACTOR and the OWNER. Lump sum quotations for modifications to the work shall include substantiating documentation with an itemized breakdown of CONTRACTOR and SUBCONTRACTOR costs, including labor, material, rentals, approved services, overhead, and Profit, all calculated as specified under "C" below.

#### C. COST REIMBURSEMENT WORK

The term "cost reimbursement" shall be understood to mean that payment for the work will be made on a time and expense basis, that is, on an accounting of the CONTRACTOR's forces, materials, equipment, and other items of cost as required and used to do the work.

If the method of payment cannot be agreed upon Prior to the beginning of the work, and the OWNER directs by written Change Order that the work be done on a cost reimbursement basis, then the CONTRACTOR shall furnish labor, and furnish and install equipment and materials necessary to complete the work in a satisfactory manner and within a reasonable period of time. For the work performed, payment

will be made for the documented actual cost of the following:

1. Labor including foremen for those hours they are assigned and participating in the cost reimbursement work (actual payroll cost, including wages, fringe benefits as established by negotiated labor agreements, labor insurance, and labor taxes as established by law). No other fixed labor burdens will be considered, unless approved in writing by the OWNER.
2. Material delivered and used on the designated work, including sales tax, if paid by the CONTRACTOR or his SUBCONTRACTOR.
3. Rental or equivalent rental cost of equipment, including necessary transportation for items having a value in excess of \$100. Rental or equivalent rental cost will be allowed for only those days or hours during which the equipment is in actual use. Rental and transportation allowances shall not exceed the current rental rates prevailing in the locality. The rentals allowed for equipment will, in all cases, be understood to cover all fuel, supplies, repairs, and renewals, and no further allowances will be made for those items, unless specific agreement to that effect is made.
4. Additional bond, as required and approved by the OWNER.
5. Additional insurance (other than labor insurance) as required and approved by the OWNER.

In addition to items 1 through 5 above, an added fixed fee for general overhead and Profit shall be negotiated and allowed for the CONTRACTOR (or approved SUBCONTRACTOR) actually executing the Cost Reimbursement work.

An additional fixed fee shall be negotiated and allowed the CONTRACTOR for the administrative handling of portions of the work that are executed by an approved SUBCONTRACTOR. No additional fixed fee will be allowed for the administrative handling of work executed by a SUBCONTRACTOR of a SUBCONTRACTOR, unless by written permission from the OWNER.

The added fixed fees shall be considered to be full compensation, covering the cost of general supervision, overhead, Profit, and any other general expense. The CONTRACTOR's records shall make clear distinction between the direct costs of work paid for on a cost reimbursement basis and the costs of other work. The CONTRACTOR shall furnish the ENGINEER report sheets in duplicate of each day's cost reimbursement work no later than the working day following the performance of said work. The daily report sheets shall itemize the materials used, and shall cover the direct cost of labor and the charges for equipment rental, whether furnished by the CONTRACTOR, SUBCONTRACTOR or other forces. The daily report sheets

shall provide names or identifications and classifications of workers, the hourly rate of pay and hours worked, and also the size, type, and identification number of equipment and hours operated.

Material charges shall be substantiated by valid copies of vendors' invoices. Such invoices shall be submitted with the daily report sheets, or, if not available, they shall be submitted with subsequent daily report sheets. Said daily report sheets shall be signed by the CONTRACTOR or his authorized agent.

The OWNER reserves the right to furnish such materials and equipment as he deems expedient and the CONTRACTOR shall have no claim for profit or added fees on the cost of such materials and equipment. To receive partial payments and final payment for cost reimbursement work, the CONTRACTOR shall submit to the ENGINEER, detailed and complete documented verification of the CONTRACTOR's and any of his SUBCONTRACTORS' actual costs involved in the cost reimbursement work. Such costs shall be submitted within 30 days after said work has been performed.

## **69. PARTIAL PAYMENTS**

### **A. GENERAL**

Nothing in this Article shall be construed to affect the right, hereby reserved, to reject the whole or any part of the aforesaid work, should such work be later found not to comply with the Provisions of the Contract Documents. All estimated quantities of work for which partial payments have been made are subject to review and correction on the final estimate. Payment by the OWNER and acceptance by the CONTRACTOR of partial payments based on periodic estimates of quantities of work performed shall not, in any way, constitute acceptance of the estimated quantities used as a basis for computing the amounts of the partial payments.

### **B. ESTIMATE**

At least 30 days before each Progress payment falls due, as specified in the Supplementary Conditions, the CONTRACTOR shall submit to the ENGINEER a detailed estimate of the amount earned during the Preceding month for the separate portions of the work, and request payment. As used in this Article, the words "amount earned" means the value, on the date of the estimate for partial payment, of the work completed in accordance with the Contract Documents, and the value of approved materials delivered to the Project site suitable stored and Protected Prior to incorporation into the work.

ENGINEER will, within 7 days after receipt of each request for payment, either indicate in writing a recommendation of payment and present the request to OWNER, or return the

request to CONTRACTOR indicating in writing ENGINEER's reasons for refusing to recommend payment. In the latter case, CONTRACTOR may, within 7 days, make the necessary corrections and resubmit the request.

ENGINEER may refuse to recommend the whole or any part of any payment if, in his opinion, it would be incorrect to make such representations to OWNER. ENGINEER may also refuse to recommend any such payment, or, because of subsequently discovered evidence or the results of subsequent inspections or tests, nullify any such payment previously recommended to such an extent as may be necessary in ENGINEER's opinion to protect the OWNER from loss because:

1. The work is defective, or completed work has been damaged requiring correction or replacement;
2. Written claims have been made against OWNER or Liens have been filed in connection with the work;
3. The Contract Price has been reduced because of Change Orders;
4. OWNER has been required to correct defective work or complete the work in accordance with Article OWNER'S RIGHT TO DO WORK;
5. Of CONTRACTOR's unsatisfactory Prosecution of the work in accordance with the Contract Documents; or
6. CONTRACTOR's failure to make payment to SUBCONTRACTORS or for labor, materials, or equipment.

### **C. DEDUCTION FROM ESTIMATE**

Unless modified in the Supplementary Conditions, deductions from the estimate will be as described below:

1. The OWNER will deduct from the estimate, and retain as part security, 10 percent of the amount earned for work satisfactorily completed. A deduction and retainage of 10 percent will be made on the estimated amount earned for approved items of material delivered to and properly stored at the jobsite but not incorporated into the work. When the work is 50 percent complete, the OWNER may reduce the retainage to 5 percent of the dollar value of all work satisfactorily completed to date provided the CONTRACTOR is making satisfactory progress and there is no specific cause for a greater retainage. The OWNER may reinstate the retainage up to 10 percent if the OWNER determines, at his discretion, that the CONTRACTOR is not making satisfactory

progress or where there is other specific cause for such withholding.

**D. QUALIFICATION FOR PARTIAL PAYMENT FOR MATERIALS DELIVERED**

Unless modified in the Supplementary Conditions, qualification for partial payment for materials delivered but not yet incorporated into the work shall be as described below:

1. Materials, as used herein, shall be considered to be those items which are fabricated and manufactured material and equipment. No consideration shall be given to individual purchases of less than \$200 for any one item.
2. To receive partial payment for materials delivered to the site, but not incorporated in the work, it shall be necessary for the CONTRACTOR to include a list of such materials on the Partial Payment Request. At his sole discretion, the ENGINEER may approve items for which partial payment is to be made. Partial payment shall be based on the CONTRACTOR's actual cost for the materials as evidenced by invoices from the supplier. Proper storage and Protection shall be provided by the CONTRACTOR, and as approved by the ENGINEER. Final payment shall be made only for materials actually incorporated in the work and, upon acceptance of the work, all materials remaining for which advance payments had been made shall revert to the CONTRACTOR, unless otherwise agreed, and partial payments made for these items shall be deducted from the final payment for the work.
3. CONTRACTOR warrants and guarantees that title to all work, materials, and equipment covered by any Application for Payment, whether incorporated in the Project or not, will pass to OWNER at the time of payment free and clear of all liens, claims, security interests, and encumbrances.
4. If requested by the ENGINEER, the CONTRACTOR shall provide, with subsequent pay requests, invoices receipted by the supplier showing payment in full has been made.

**E. PAYMENT**

After deducting the retainage and the amount of all previous partial payments made to the CONTRACTOR from the amount earned, the amount due will be made payable to the CONTRACTOR. Recommendations for payment received by the OWNER less than 9 days Prior to the scheduled day for payment will not be Processed or paid until the following month.

**70. CLAIMS FOR EXTRA WORK**

In any case where the CONTRACTOR deems additional time or compensation will become due him under this Contract for circumstances other than those defined in Article DELAYS AND EXTENSION OF TIME, the CONTRACTOR shall notify the ENGINEER, in writing, of his intention to make claim for such time or compensation before he begins the work on which he bases the claim, in order that such matters may be settled, if possible, or other appropriate action taken. The notice of claim shall be in duplicate, in writing, and shall state the circumstances and the reasons for the claim, but need not state the amount. If such notification is not given or if the ENGINEER is not afforded proper facilities by the CONTRACTOR for keeping strict account of actual cost, then the CONTRACTOR hereby agrees to waive the claim for such additional time or compensation. Such notice by the CONTRACTOR, and fact that the ENGINEER has kept account of the cost as aforesaid, shall not in any way be construed as proving the validity of the claim.

No extension of time will be granted to the CONTRACTOR for delays resulting from extra work that have no measurable impact on the completion of the total work under this Contract. Claims for additional time or compensation shall be made in itemized detail and submitted, in writing, to the OWNER and ENGINEER within 10 days following completion of that portion of the work for which the CONTRACTOR bases his claim. Failure to make the claim for additional compensation in the manner and within the time specified above shall constitute waiver of that claim. In case the claim is found to be just, it shall be allowed and paid for as provided in Article PAYMENT FOR CHANGE ORDERS.

**71. RELEASE OF LIENS OR CLAIMS**

The CONTRACTOR shall indemnify and hold harmless the OWNER from all claims for labor and materials furnished under this Contract. Prior to the final payment, the CONTRACTOR shall furnish to the OWNER, as part of his final payment request, a certification that all of the CONTRACTOR's obligations on the project have been satisfied and that all monetary claims and indebtedness have been paid. The CONTRACTOR shall furnish complete and legal effective releases or waivers, satisfactory to the OWNER, of all liens arising out of or filed in connection with the work.

**72. FINAL PAYMENT**

Upon completion of all the work under this Contract, the CONTRACTOR shall notify the ENGINEER, in writing, that he has completed his part of the Contract and shall request final payment. Upon receipt of such notice the ENGINEER will inspect and, if acceptable, submit to the OWNER his

recommendation as to acceptance of the completed work and as to the final estimate of the amount due the CONTRACTOR. Upon approval of this final estimate by the OWNER and compliance by the CONTRACTOR with Provisions in Article **RELEASE OF LIENS OR CLAIMS**, and other Provisions as may be applicable, the OWNER shall pay to the CONTRACTOR all monies due him under the Provisions of these Contract Documents.

**73. NO WAIVER OF RIGHTS**

Neither the inspection by the OWNER, through the ENGINEER or any of his employees, nor any order by the OWNER for payment of money, nor any payment for, or acceptance of, the whole or any part of the work by the OWNER or ENGINEER, nor any extension of time, nor any possession taken by the OWNER or its employees, shall operate as a waiver of any Provision of this Contract, or any power herein reserved to the OWNER, or any right to damages herein Provided, nor shall any waiver of any breach in this Contract be held to be a waiver of any other or subsequent breach. Acceptance or final payment shall not be final and conclusive with regards to latent defects, fraud, or such gross mistakes as may amount to fraud, or as regards the OWNER's rights under the warranty.

**74. ACCEPTANCE OF FINAL PAYMENT  
CONSTITUTES RELEASE**

The acceptance by the CONTRACTOR of the final payment shall release the OWNER and the ENGINEER, as representatives of the OWNER, from all claims and all liability to the CONTRACTOR for all things done or furnished in connection with the work, and every act of the OWNER and others relating to or arising out of the work except claims Previously made in writing and still unsettled. No payment, however, final or otherwise, shall operate to release the CONTRACTOR or his Sureties from obligations under this Contract and the Performance Bond, Payment Bond, and other bonds and warranties, as herein provide

## SUPPLEMENTARY CONDITIONS

The General Conditions are hereby revised as follows:

### ARTICLE 9 "ENGINEER"

Delete Article "ENGINEER" in its entirety and substitute the following:

The person or organization identified as such in the Contract Documents. The Term "ENGINEER" means City of Key West or their authorized representative.

### ARTICLE 34 "INSURANCE & LIABILITY"

Contractor shall maintain limits no less than those stated below:

#### 1.0 GENERAL INSURANCE REQUIREMENTS:

- 1.01 During the Term of the Agreement, the Contractor shall provide, pay for, and maintain with insurance companies satisfactory to the City of Key West, Florida ("City"), the types of insurance described herein.
- 1.02 All insurance shall be from responsible insurance companies eligible to do business in the State of Florida. The required policies of insurance shall be performable in Monroe County, Florida, and shall be construed in accordance with the laws of the State of Florida.
- 1.03 The City shall be specifically included as an additional insured on the Contractor's Liability policies with the exception of the Contractor's Professional Liability policies (if required) and shall also provide the "Severability of Interest" provision (a/k/a "Separation of Insured's" provision). The City's additional insured status should be extended to all Completed Operations coverages.
- 1.04 The Contractor shall deliver to the City, prior to commencing work/activities under the Agreement, properly executed "Certificate(s) of Insurance" setting forth the insurance coverage and limits required herein. The Certificates must be signed by the authorized representative of the insurance company(s) shown on the Certificate of Insurance. In addition, certified, true, and exact copies of the insurance policies required herein shall be provided to the City, on a timely basis, if requested by the City.
- 1.05 If the Contractor fails to provide or maintain the insurance coverages required in this Agreement at any time during the Term of the Agreement and if the Contractor refuses or otherwise neglects to deliver the required Certificate(s) of Insurance signed by the authorized representative of the insurance company(s) to the City, the City may, at the City's sole discretion, terminate or suspend this Agreement and seize the amount of Contractor's performance bond, letter of credit, or other security acceptable to the City).
- 1.06 The Contractor shall take immediate steps to make up any impairment to any Aggregate Policy Limit upon notification of the impairment. If at any time the City requests a written statement from the insurance company(s) as to any impairment to the Aggregate Limit, the Contractor shall promptly authorize and have delivered such statement to the City.

- 1.07 The Contractor authorizes the City and/or its insurance consultant to confirm all information furnished to the City, as to its compliance with its Bonds and Insurance Requirements, with the Contractor's insurance agents, brokers, surety, and insurance carriers.
- 1.08 All insurance coverage of the Contractor shall be primary to any insurance or self-insurance program carried by the City. The City's insurance or self-insurance programs or coverage shall not be contributory with any insurance required of the Contractor in this Agreement.
- 1.09 The acceptance of delivery to the City of any Certificate of Insurance evidencing the insurance coverage and limits required in the Agreement does not constitute approval or agreement by the City that the insurance requirements in the Agreement have been met or that the insurance policies shown in the Certificates of Insurance are in compliance with the Agreement requirements.
- 1.10 No work/activity under this Agreement shall commence or continue unless and until the required Certificate(s) of Insurance are in effect and the written Notice to Proceed is issued by the City.
- 1.11 The insurance coverage and limits required of the Contractor under this Agreement are designed to meet the minimum requirements of the City. They are not designed as a recommended insurance program for the Contractor. The Contractor alone shall be responsible for the sufficiency of its own insurance program. Should the Contractor have any question concerning its exposures to loss under this Agreement or the possible insurance coverage needed therefore, it should seek professional assistance.
- 1.12 During the Term of this Agreement, the City and its agents and contractors may continue to engage in necessary business activities during the operations of the Contractor. No personal property owned by City used in connection with these business activities shall be considered by the Contractor's insurance company as being in the care, custody, or control of the Contractor.
- 1.13 Should any of the required insurances specified in this Agreement provide for a deductible, self-insured retention, self-insured amount, or any scheme other than a fully insured program, the Contractor shall be responsible for all deductibles and self-insured retentions.
- 1.14 All of the required insurance coverages shall be issued as required by law and shall be endorsed, where necessary, to comply with the minimum requirements contained herein.
- 1.15 The Contractor shall provide the City thirty (30) days advance written notice of any cancellation, intent not to renew any policy and/or any change that will reduce the insurance coverage required in this Agreement, except for the application of the Aggregate Limits Provisions.
- 1.16 Renewal Certificate(s) of Insurance shall be provided to the City at least twenty (20) days prior to expiration of current coverage so that there shall be no termination of the Agreement due to lack of proof of the insurance coverage required of the Contractor.
- 1.17 If the Contractor utilizes contractors or sub-contractors to perform any operations or activities governed by this Agreement, the Contractor will ensure all contractors and sub-contractors to maintain the same types and amounts of insurance required of the Contractor. In addition, the Contractor will ensure that the contractor and sub-contractor insurances comply with all of the Insurance Requirements specified for the Contractor contained within this Agreement. The Contractor shall obtain Certificates of Insurance comparable to those



required of the Contractor from all contractors and sub-contractors. Such Certificates of Insurances shall be presented to the City upon request. Contractor's obligation to ensure that all contractor's and sub-contractor's insurance as provided herein shall not exculpate Contractor from the direct primary responsibility Contractor has to the City hereunder. The City will look directly to Contractor for any such liability hereunder and shall not be obligated to seek recovery from any contractor or subcontract or under such contractor's or sub-contractor's insurance coverages.

**2.0 SPECIFIC INSURANCE COVERAGES AND LIMITS:**

- 2.01 All requirements in this Insurance Section shall be complied with in full by the Contractor unless excused from compliance in writing by the City.
- 2.02 The amounts and types of insurance must conform to the following minimum requirements. Current Insurance Service Office (ISO) or National Council on Compensation Insurance (NCCI) policies, forms, and endorsements or broader shall be used where applicable. Notwithstanding the foregoing, the wording of all policies, forms, and endorsements must be acceptable to the City.

**Workers' Compensation and Employers' Liability Insurance** shall be maintained in force during the Term of this Agreement for all employees engaged in this work under this Agreement, in accordance with the laws of the State of Florida. The minimum acceptable limits shall be:

Workers' Compensation	Florida Statutory Requirements
Employer's Liability	\$100,000.00 Limit Each Accident
	\$500,000.00 Limit Disease Aggregate
	\$100,000.00 Limit Disease Each

Employee

If the Contractor has less than four (4) employees and has elected not to purchase Workers' Compensation/Employers Liability coverage as permitted by *Florida Statutes*, the Contractor will be required to issue a formal letter (on the Contractor's letterhead) stating that it has less than four (4) employees and has elected not to purchase Workers' Compensation/Employers Liability coverage as permitted by *Florida Statutes*. This exception does **not** apply to firms engaged in construction activities.

**Commercial General Liability Insurance** shall be maintained by the Contractor on a Full Occurrence Form. Coverage shall include, but not be limited to, Premises and Operations, Personal Injury, Contractual for this Agreement, Independent Contractors, and Products & Completed Operations Coverage. The limits of such coverage shall not be less than:

Bodily Injury & Property Damage Liability	\$1,000,000.00 Combined Single Limit each Occurrence and Aggregate
--	---

Completed Operations Liability Coverage shall be maintained by the Contractor for a period of not less than four (4) years following expiration or termination of this Agreement.

The use of an Excess, Umbrella and/or Bumbershoot policy shall be acceptable if the level of protection provided by the Excess, Umbrella and/or Bumbershoot policy is equal to or more comprehensive than the Primary Commercial General Liability policy.

**Business Automobile Liability Insurance** shall be maintained by the Contractor as to ownership, maintenance, use, loading and unloading of all owned, non-owned, leased, or hired vehicles with limits of such coverage of not less than:

\$200,000 per Person;  
\$300,000 per Occurrence  
\$200,000 Property Damage  
or  
\$300,000 Combined Single Limit

If the Contractor does not own any vehicles, this requirement can be satisfied by having the Contractor's Commercial General Liability policy endorsed with "Non-Owned and Hired Automobile" Liability coverage.

**Installation Floater Insurance** shall be maintained by the Contractor that will provide coverage for machinery and equipment while being transported, installed, and tested. The minimum acceptable limits of such coverage shall be not be less than the value of the machinery or equipment being installed. **City shall be designated as the "Loss Payee" on the policy.**

Add the following Article:

#### G. SURETY AND INSURER QUALIFICATIONS

All bonds, insurance contracts, and certificates of insurance shall be either executed by or countersigned by a licensed resident agent of the Surety or insurance company, having his place of business in the State of Florida, and in all ways complying with the insurance laws of the State of Florida. Further, the said Surety or Insurance Company shall be duly licensed and qualified to do business in the State of Florida. If requested, Contractor shall Provide Proof of Florida Licensure for all insurance companies. The City of Key West shall be named as Additional Insured on the insurance certificates.

#### ARTICLE 35 "INDEMNITY"

Delete Article "INDEMNITY" in its entirety and substitute the following:

##### INDEMNITY

To the fullest extent permitted by law, the CONTRACTOR expressly agrees to indemnify and hold harmless the City of Key West, their officers, directors, agents and employees \*(herein called the "indemnitees") from liabilities, damages, losses and costs, including but not limited to, reasonable attorney's fees and court costs, such legal expenses to include costs incurred in establishing the indemnification and other rights agreed to in this Paragraph, to persons or property, to the extent caused by the negligence, recklessness, or intentional wrongful misconduct of the CONTRACTOR, its Subcontractors or persons employed or utilized by them in the performance of the

Contract. Claims by indemnitees for indemnification shall be limited to the amount of CONTRACTOR's insurance or \$1 million per occurrence, whichever is greater. The parties acknowledge that the amount of the indemnity required hereunder bears a reasonable commercial relationship to the Contract and it is part of the project specifications or the bid documents, if any.

The indemnification obligations under the Contract shall not be restricted in any way by any limitation on the amount or type of damages, compensation, or benefits payable by or for the CONTRACTOR under Workers' Compensation acts, disability benefits acts, or other employee benefits acts, and shall extend to and include any actions brought by or in the name of any employee of the CONTRACTOR or of any third party to whom CONTRACTOR may subcontract a part or all of the Work. This indemnification shall continue beyond the date of completion of the work.

The indemnification obligations under the Contract shall not be restricted in any way by any limitation on the amount or type of damages, compensation, or benefits payable by or for the CONTRACTOR under workers' compensation acts, disability benefits acts, or other employee benefits acts, and shall extend to and include any actions brought by or in the name of any employee of the CONTRACTOR or of any third party to whom CONTRACTOR may subcontract a part or all of the Work. This indemnification shall continue beyond the date of completion of the work.

#### ARTICLE 39 "CODES, ORDINANCES, PERMITS, AND LICENSES"

Add the following:

##### A. PERMIT FOR WORK WITHIN LOCAL RIGHTS-OF-WAY

The Contractor shall obtain from the City of Key West the necessary permits for work within the rights-of-way. The Contractor shall abide by all regulations and conditions, including maintenance of traffic.

##### B. NOISE ORDINANCE

City of Key West has a noise ordinance that allows working hours between 8:00 AM to 7:00 PM, Monday through Friday. No work should be performed during weekends or City Holidays, State Holidays and National Holidays. Any construction operations outside these hours and these days will require a variance from the City of Key West Commission.

##### D. "LICENSES"

#### **THE BIDDER MUST BE A LICENSED CONTRACTOR BY THE STATE OF FLORIDA AND SUBMIT PROOF OF SUCH WITH THE BID.**

1. Within 10 days of Notice of Award, the successful Bidder must represent that he holds all applicable, county, and City of Key West licenses and permits required

to do business as a contractor with respect to the work described in the Contract Documents.

2. Further, the successful Bidder must, within 10 days of Notice of Award, furnish documentation showing that, as a minimum, he has complied with the provisions of Chapter 18 of the Code of Ordinances of the City of Key West in order to enter into the Agreement contained in the Contract Documents.
3. Specifically, within 10 days after Notice of Award, the successful Bidder must demonstrate that he holds, as a minimum, the following licenses and certificates:
  - a.) City of Key West Tax License Receipt;
  - b.) A valid occupational license issued by the City of Key West, Florida.

#### E. WORK DURING HOLIDAYS

There shall be no work during City Holidays, State Holidays and National Holidays. Any construction operations during these days shall be approved by the City of Key West.

#### ARTICLE 42 "SAFETY"

Add the following sub article:

##### OCCUPATIONAL SAFETY AND HEALTH

The Contractor shall observe and comply with all applicable local, state, and federal occupational safety and health regulations during the prosecution of work under this Contract. In addition, full compliance by the Contractor with the U.S. Department of Labor's Occupational Safety and Health Standards, as established in Public Law 91-596, will be required under the terms of this Contract.

#### ARTICLE 43 "PROTECTION OF WORK AND PROPERTY"

Add the following Article:

##### HISTORIC PRESERVATION

The Contractor shall comply with Florida's Archives and Historic Act (Florida Statutes, Chapter 267) and the regulations of the local historic preservation board as applicable and protect against the potential loss or destruction of significant historical or archaeological data, sites, and properties in connection with the project.

**ARTICLE 57 "OWNERS RIGHT TO TRANSFER EMPLOYMENT"**

Add the following Article:

**TERMINATION FOR CONVENIENCE AND RIGHT OF SUSPENSION**

- A. Owner shall have the right to terminate this Contract without cause by written notice of Termination to the Contractor. In the event of such termination for convenience, the Contractor's recovery against the Owner shall be limited to that portion of the Contract amount earned through the date of termination, together with any retainage withheld and reasonable termination expenses incurred. Contractor shall not be entitled to any other or further recovery against the Owner, including, but not limited to, damages or any anticipated profit on portions of the Work not performed.
  
- B. The Owner shall have the right to suspend all or any portions of the Work upon giving the Contractor prior written notice of such suspension. If all or any portion of the Work is so suspended, the Contractor shall be entitled to reasonable costs, expenses and time extension associated with the suspension.

**ARTICLE 60 "LIQUIDATED DAMAGES"**

Delete Article "LIQUIDATED DAMAGES" in its entirety and substitute the following:  
**LIQUIDATED DAMAGES**

Should the Contractor fail to complete the work or any part thereof in the time agreed upon in the Contract Documents or within such extra time as may have been allowed for delays by extensions granted as provided in the Contract, the Contractor shall reimburse the Owner for the additional expense and damage for each calendar day, Sundays and legal holidays included, that project outlined in Contract Documents remains uncompleted after the completion date. Liquidated damages shall be assessed. It is agreed that the amount of such additional expense and damage incurred by reason of failure to complete the work is the per diem rate as stipulated in the Proposal. The said amount is hereby agreed upon as a reasonable estimate of the costs which may be accrued by the Owner after the expiration of the time of completion. It is expressly understood and agreed that this amount is not to be considered in the nature of a penalty but as liquidated damages, which have accrued against the Contractor. The Owner shall have the right to deduct such damages from any amount due or that may become due the Contractor or the amount of such damages shall be due and collectible from the Contractor or Surety.

ARTICLE 69 "PARTIAL PAYMENTS"

Delete the first paragraph of Article "PARTIAL PAYMENTS" and substitute the following:

No more than once each month the Contractor shall submit to the Engineer a detailed estimate of the amount earned during the preceding month for the separate portions of the work and request payment. As used in this Article the words "amount earned" means the value, on the date of the estimate, for partial payment of the work completed in accordance with the Contract Documents and the value of approved materials delivered to the project site suitably stored and protected prior to incorporation into the work.

ARTICLE 69 "PARTIAL PAYMENTS"

Add the following:

Payment will be made by the Owner to the Contractor within 40 days receipt of the written recommendation of payment from the Engineer.

ARTICLE 69 "PARTIAL PAYMENT"

Delete Subarticle E "PAYMENT" in its entirety and substitute the following:  
PAYMENT

After deducting the retainage and the amount of all previous partial payments made to the Contractor from the amount earned the amount due will be made payable to the Contractor. Recommendations for payment received by the Owner less than 40 days prior to the scheduled day for payment will not be processed or paid until the following month.

The OWNER will withhold progress payments until the Contractor has satisfied the above conditions.

ARTICLE 72 "FINAL PAYMENT"

Delete Article "FINAL PAYMENT" in its entirety and substitute the following:

FINAL PAYMENT

Upon completion of the work the Contractor shall notify the Engineer, in writing, that he has completed it and shall request final payment. The Contractor shall be responsible for keeping an accurate and detailed record of his actual construction. Upon completion of construction and before final acceptance and payment the Contractor shall furnish the Engineer as-built

drawings of his construction. Upon receipt of a request for final payment and the as-built drawings the Engineer will inspect and, if acceptable, submit to the Owner his recommendation as to acceptance of the completed work and as to the final estimate of the amount due the Contractor. Upon approval of this final estimate by the Owner and compliance by the Contractor with provisions in Article RELEASE OF LIENS OR CLAIMS, and other provisions as may be applicable, the Owner shall pay to the Contractor all monies due him under the provisions of these Contract Documents.

## ARTICLE 72 "FINAL PAYMENT"

Add the following;

### **A. Acceptance and Final Payment.**

Whenever the Contractor has completely performed the work provided for under the Contract and the Engineer has performed a final inspection and made final acceptance and subject to the terms of the Engineer will prepare a final estimate showing the value of the work as soon as the Engineer makes the necessary measurements and computations. The Engineer will correct all prior estimates and payments in the final estimate and payment. The OWNER will pay the estimate, less any sums that the OWNER may have deducted or retained under the provisions of the Contract, as soon as practicable after final acceptance of the work, provided the Contractor has met the requirements of (1) through (8) below.

- 1 The Contractor has agreed in writing to accept the balance due or refund the overpayment, as determined by the OWNER, as full settlement of his account under the Contract and of all claims in connection therewith, or the Contractor, accepted the balance due or refunded the overpayment, as determined by the OWNER, with the stipulation that his acceptance of such payment or the making of such refund does not constitute any bar, admission, or estoppel, or have any effect as to those payments in dispute or the subject of a pending claim between the Contractor and the OWNER. To receive payment based on a FINAL PAYMENT CERTIFICATE, The Contractor further agrees, by submitting a FINAL PAYMENT CERTIFICATE that any pending or future arbitration claim or suit is limited to those particulars, including the itemized amounts, defined in the original FINAL PAYMENT CERTIFICATE, and that he will commence with any such arbitration claim or suit within 15 calendar days from and after the time of final PAYMENT of the work and that his failure to file a formal claim within this period constitutes his full acceptance of the Engineer's final estimate and payment. The overpayment refund check from the Contractor, if required, will be considered a part of any Acceptance Letter executed.
- 2 The Contractor has properly maintained the project, as specified hereinbefore.

- 3 The Contractor has furnished a sworn affidavit to the effect that the Contractor has paid all bills and no suits are pending (other than those exceptions listed, if any) in connection with work performed under the Contract and that the Contractor has not offered or made any gift or gratuity to, or made any financial transaction of any nature with, any employee of the OWNER in the performance of the Contract.
- 4 The surety on the contract bond consents, by completion of their portion of the affidavit and surety release subsequent to the Contractor's completion of his portion, to final payment to the Contractor and agrees that the making of such payment does not relieve the surety of any of its obligations under the bond.
- 5 The Contractor has furnished all required mill tests and analysis reports to the Engineer.
- 6 Final payment will not be released until the City receives Certified As-built drawings in AutoCAD & Adobe format as well as:

**As-Built Drawing Standards:**

All supplied data collections, as-builts, drawings and files to be compatible with esri ArcGIS 10.7.1 Software. The current computing environment consists of:

- Microsoft SQL Server - Windows 7/Server 2008 - ESRI GIS Platform

**Interfaces and Integrations:**

The City of Key West uses a number of software applications critical to its core operation and mission. The proposed mobile asset data collection solution will need to interface or integrate with these existing platforms. - Arc Collector-ArcGIS Online - ArcMap 10.2

If there are any questions or concerns on whether your files meet this request. Please contact the City of Key West GIS department. 305-809-3721.

\* \* \* \* \*



---

**PART 4**  
**GENERAL SPECIFICATIONS**

---

**SECTION 01001**  
**GENERAL REQUIREMENTS**

**1. PROJECT DESCRIPTION**

**1.1 GENERAL**

- A. The following information though not all-inclusive, is given to assist Contractors in the evaluation of the work required to meet the project objectives.
- B. A brief description of the work is stated in the Invitation to Bid. To determine the full scope of the project or of any particular part of the project, coordinate the applicable information in the several parts of these Contract Documents.

**2. SEQUENCE OF OPERATIONS**

**2.1 MOBILIZATION AND DEMOBILIZATION**

- A. Contractor shall be responsible for mobilization and demobilization of labor, materials and equipment. Payment for mobilization and demobilization will be included in the unit price indicated in the BID.

**B. DAILY REPORTS**

- 1) The CONTRACTOR shall submit daily reports of construction activities for each site, including non-work days. The report shall include:
  - a) Manpower, number of men by craft
  - b) Quality Control
  - c) Equipment on the Project;
  - d) Major deliveries
  - e) Activities worked with reference to the CPM schedule activity numbers
  - f) New problems
  - g) Other pertinent information
- 2) A similar report shall be submitted for/by each Subcontractor.
- 3) The reports shall be submitted to the ENGINEER each month.

**2.2 SCHEDULING**

- A. Plan the work and carry it out with minimum interference to the operation of the existing facilities. Prior to starting the work, confer with the Engineer and Owner's representative to develop an approved work schedule, which will permit the facilities to function as normally as practical. It may be necessary to do certain parts of the work outside normal working hours in order to avoid undesirable conditions. The Contractor shall do this work at such times and at no additional cost to the Owner.

**2.3 COORDINATION**

- A. Contractors shall cooperate in the coordination of their separate activities in a manner that will provide the least interference with the Owner's operations and other contractors and

utility companies working in the area, and in the interfacing and connection of the separate elements of the overall project work.

- B. If any difficulty or dispute should arise in the accomplishment of the above, the problem shall be brought immediately to the attention of the Engineer.

## 2.4 WORK TO BE PERFORMED BY OTHERS

- A. During the construction period for this project, the Owner (either with his own forces or under a separate contract) may be performing work that may require the cooperation of the Contractors in scheduling and coordination to avoid conflicts.
- B. If any difficulty or dispute should arise in the accomplishment of the above, the problem shall be brought immediately to the attention of the Engineer.
- C. All Contractors working on this site are subject to this requirement for cooperation, and all shall abide by the Engineer's decision in resolving project coordination problems without additional cost to the Owner.

## 3. SITE CONDITIONS

### 3.1 SITE INVESTIGATION AND REPRESENTATION

- A. The Contractor acknowledges satisfaction as to the nature and location of the work, the general and local conditions, particularly those bearing upon availability of transportation, access to the site, disposal, handling and storage of materials, availability of labor, water, electric power, roads, and uncertainties of weather, or similar physical conditions at the site, the conformation and conditions of the ground, the character of equipment and facilities needed preliminary to and during the prosecution of the work, and all other matters which can any way affect the work or the cost thereof under this Contract.
- B. The Contractor further acknowledges satisfaction as to character, quality, and quantity of surface and subsurface materials to be encountered from his inspection of the site and from reviewing any available records of exploratory work furnished by the Owner or included in these Documents. Failure by the Contractor to become acquainted with the physical conditions of the site and all available information will not relieve the Contractor from responsibility for properly estimating the difficulty or cost of successfully performing the work.
- C. The Contractor warrants that as a result of examination and investigation of all the aforesaid data, the contractor can perform the work in a good and workmanlike manner and to the satisfaction of the Owner.
- D. The Owner assumes no responsibility for any representations made by any of its officers or agents during or prior to the execution of this Contract, unless (1) such representations are expressly stated in the Contract, and (2) the Contract expressly provides that the responsibility therefore is assumed by the Owner.

### 3.2 INFORMATION ON SITE CONDITIONS

- A. General: Any information obtained by the Engineer regarding site conditions, subsurface information, water level, existing construction of site facilities as applicable, and similar data will be available for inspection at the office of the Engineer upon request. Such information is offered as supplementary information only. Neither the Engineer nor the Owner assumes any responsibility for the completeness or interpretation of such supplementary information.

### 3.3 DIFFERING SUBSURFACE CONDITIONS

- A. The Engineer shall investigate such conditions promptly and following this investigation, the Contractor shall proceed with the work, unless otherwise instructed by the Engineer. If the Engineer finds that such conditions do so materially differ and cause an increase or decrease in the cost of, or in the time required for performing the work, the Engineer will recommend to the Owner the amount of adjustment in cost and time he considers reasonable. The Owner will make the final decision on all Change Orders to the Contract regarding any adjustment in cost or time for completion.

### 3.4 UTILITIES

- A. During any excavation the Contractor shall be responsible for determining, at his cost, the locations of all known utilities in the project area.
- B. Contractor shall notify utility location service (e.g. Call Sunshine 1-800-432-4770) a minimum for 48 hours prior to work order mobilization. Assigned notification number shall be maintained at the job site at all times and recorded in the daily reports.

### 3.5 CONTRACTOR'S RESPONSIBILITY FOR UTILITY PROPERTIES AND SERVICE

- A. Where the Contractor's operations could cause damage or inconvenience to telephone, television, gas, water, sewer, or irrigation systems, the operations shall be suspended until all arrangements necessary for the protection of these utilities and services have been made by the Contractor.
- B. Notify all utility offices, which are affected by the construction operation at least 48 hours in advance. Under no circumstances expose any utility without first obtaining permission from the appropriate agency. Once permission has been granted, locate, expose, and provide temporary support for all existing underground utilities.
- C. The Contractor shall be solely and directly responsible to the Owner and operators of such properties for any damage, injury, expense, loss, inconvenience, delay, suits, actions, or claims of any character brought because of any injuries or damage which may result from the construction operations under this Contract.
- D. Neither the Owner nor its Officers or agents shall be responsible to the Contractor for damages as a result of the Contractor's failure to protect utilities encountered in the work.

- E. In the event of interruption to domestic water, sewer, storm drain, or other utility services as a result of accidental breakage due to construction operations, promptly notify the proper authority. Cooperate with said authority in restoration of service as promptly as possible and bear all costs of repair. In no case shall interruption of any water or utility service be allowed to exist outside working hours unless prior approval is granted.
- F. In the event the Contractor encounters water service lines that interfere with trenching, he may, by obtaining prior approval of the property owner, Water Department, or Fire Department as applicable, and the Engineer, cut the service dig through, and restore service with similar and equal materials at the Contractor's expense.
- G. The Contractor shall replace, at his own expense, all existing utilities or structures removed or damaged during construction, unless otherwise provided for in these Contract Documents or ordered by the Engineer.

#### **4. TEMPORARY CONSTRUCTION UTILITIES AND FACILITIES**

##### **4.1 TEMPORARY WATER**

- A. The Contractor shall make his own arrangements to obtain suitable water for any need and shall pay all costs.

##### **4.2 TEMPORARY ELECTRIC POWER**

- A. The Contractor shall make his own arrangements to obtain and pay for electrical power used until final acceptance by the Owner.

##### **4.3 SAFETY REQUIREMENTS FOR TEMPORARY ELECTRIC POWER**

- A. Temporary electric power installation shall meet the construction Safety requirements of OSHA, State, and other governing agencies.

##### **4.4 SANITARY FACILITIES**

- A. The Contractor shall provide and maintain sanitary facilities for his employees and his subcontractor's employees that will comply with the regulations of the local and State Departments of Health and as directed by the Owner.

##### **4.5 STORAGE OF MATERIALS**

- A. Materials shall be so stored as to ensure the preservation of their quality and fitness for the work. When considered necessary, they shall be placed on wooden platforms or other clean hard surfaces and not on the ground. Stored materials shall be located so as to facilitate prompt inspection. Stored materials in the right-of-way shall be fully barricaded, with bottom height of 47" or lower and top height of 36" min., also they must be fitted and should have lights at night. Private property shall not be used for storage purposes without the written permission of the owner or lessee. Materials shall not be stored where access to any structure, plot, or road is blocked. Any material the Contractor

wishes to store on the site must be approved by the Engineer or his designee, and must be stored at the location designated by him.

- B. Delicate instruments and materials subject to vandalism shall be placed under lock cover and, if necessary, provided with temperature control as recommended by the manufacturer.

## **5. SAFETY AND CONVENIENCE**

### **5.1 CONSTRUCTION SAFETY PROGRAM**

- A. The Contractor shall develop and maintain for the duration of this Contract, a safety program that will effectively incorporate and implement all required safety provisions. The Contractor shall appoint an employee who is qualified and authorized to supervise and enforce compliance with the safety program.
- B. The duty of the Engineer to conduct construction review of the Contractor's performance is not intended to include a review or approval of the adequacy of the Contractor's safety supervisor, the safety program or any safety measures taken in, on, or near the construction site.
- C. The Contractor shall do all work necessary to protect the general public from hazards, including, but not limited to, surface irregularities, or unramped grade changes in pedestrian sidewalk or roadway. Barricades, lights, and proper signs shall be furnished in sufficient amount to safeguard the public and the work.
- D. The performance of all work and all completed construction, particularly with respect to ladders, platforms, structure openings, scaffolding, shoring, lagging, machinery guards and the like, shall be in accordance with the applicable governing safety authorities.
- E. During construction, the Contractor shall construct and at all times maintain satisfactory and substantial temporary chain link fencing, solid fencing, railing, barricades or steel plates, as applicable, at all openings, obstructions, or other hazards in streets, sidewalks, floors, roofs, and walkways. All such barriers shall have adequate warning lights as necessary, or required for safety. Also all barriers shall have a lower horizontal continuous frame member at a maximum of 17" above grade.

### **5.2 ACCIDENT REPORTS**

- A. If death or serious injuries or serious damages are caused; the Contractor must promptly report by telephone or messenger to the Engineer. In addition, the Contractor must promptly report in writing to the Engineer all accidents whatsoever arising out of or in connection with, the performance of the work whether on, or adjacent, to the site, giving full details and statements of witnesses.
- B. If a claim is made against the Contractor or any subcontractor on account of any accident, the Contractor shall promptly report the facts in writing to the Engineer, giving full details of the claim.

### 5.3 TRAFFIC MAINTENANCE AND SAFETY

- A. Comply with all rules and regulations of the state, county, and city authorities regarding closing or restricting the use of public streets or highways. No public or private road shall be closed, except by express permission of the owner. Conduct the work so as to assure the least possible obstruction to traffic and normal commercial pursuits. Protect all obstructions within traveled roadways by installing approved signs, barricades, and lights where necessary for the safety of the public. The convenience of the general public and residents adjacent to the project and the protection of persons and property are of prime importance and shall be provided for in an adequate and satisfactory manner.
- B. Maintenance of Traffic shall be maintained at all construction sites until the work is either completed or any open trenches have been properly covered and all equipment is properly stored. Contractor shall maintain Maintenance of Traffic (MOT) signs in good repairs and required MOT lights should be operative at all times. The Owner shall stop work if MOT is not properly maintained; there shall not be any additional cost to the Owner for this downtime.
- C. When flagmen and guards are required by regulation, permits, or when deemed necessary for safety, they shall be furnished with approved orange wearing apparel and other regulation traffic-control devices. Flaggers shall be certified by State approved agency.

### 5.4 STREET MAINTENANCE

- A. CONTRACTOR shall notify all residents and proprietors adjacent to construction site of work to be performed, more specifically the notice shall state the day and time construction will begin, the name and phone number of the Contractor's representative responsible for the completion of the proposed improvements. Notice shall also include the Owner's representative for the project.

### 5.5 FIRE PREVENTION AND PROTECTION

- A. The Contractor shall perform all work in a fire-safe manner and shall supply and maintain on the site adequate fire-fighting equipment capable of extinguishing incipient fires. The Contractor shall comply with applicable federal, state, and local fire-prevention regulations. Where these regulations do not apply, applicable parts of the National Fire Prevention Standard for Safeguarding Building Construction Operations (NFPA No. 241) shall be followed.

### 5.6 HURRICANE PREPAREDNESS PLAN

- A. Within 30 days of the date of Notice to Proceed, the CONTRACTOR shall submit to the ENGINEER and City Representative a Hurricane Preparedness Plan. The plan should outline the necessary measures which the CONTRACTOR proposes to perform at no additional cost to the OWNER in case of a hurricane warning.
- B. In the event of inclement weather, or whenever Owners Representative shall direct, CONTRACTOR will, and will cause Subcontractors to protect carefully the Work and materials against damage or injury from the weather. If, in the opinion of Owner's

Representative, any portion of Work or materials shall have been damaged or injured by reason of failure on the part of CONTRACTOR or any Subcontractors to so protect the Work, such Work and materials shall be removed and replaced at the expense of the CONTRACTOR.

## **6. PRESERVATION, RESTORATION AND CLEANUP**

### **6.1 SITE RESTORATION AND CLEANUP:**

- A. At all times during the work keep the premises clean and orderly and upon completion of daily work repair all damage caused by equipment and leave the project free of rubbish or excess materials of any kind.
- B. Stockpile excavated materials in a manner that will cause the least damage to adjacent lawns, grassed areas, gardens, shrubbery, or fences regardless of whether these are on private property, or State, County, or City rights-of-way. Remove all excavated materials from grassed and planted areas, and leave these surfaces in a condition equivalent to their original condition.

### **6.2 FINISHING OF SITE, BORROW, AND STORAGE AREAS**

- A. Upon completion of the project, all areas used by the Contractor shall be properly cleared of all temporary structures, rubbish and waste materials and properly graded to drain and blend in with the abutting property. Areas used for the deposit of waste materials shall be finished to properly drain and blend in with the surrounding terrain.

### **6.3 AREA CLEANUP DURING CONSTRUCTION**

- A. Thoroughly clean all spilled dirt, gravel, sand, concrete, or other foreign materials caused by the construction operations from all streets and roads, grass, pathways, or concrete walkways and from adjacent areas at the conclusion of each day's operation. Wet concrete is not to be stored, dumped, or placed on the ground or other structures on any City property at any time. Truck or equipment wash down is not to be performed on City Property.

### **6.4 DUST PREVENTION**

- A. Give all unpaved areas used in the construction area an approved dust-preventive treatment or periodically water to prevent dust during construction. Applicable environmental regulations for dust prevention shall be strictly adhered to.

## **7. SUBMITTALS**

- A. See Submittals section of the specifications



**8. PAYMENT**

**8.1 GENERAL**

A. The cost of the work in this section is considered incidental to the contract.

\*\*\*\*\*

**SECTION 01010**  
**SCOPE OF WORK**

**PART 1 - SCOPE OF WORK**

**1.1 DESCRIPTION**

- A. Work Included: the removal and replacement of four (4) fire pumps with controller, four (4) jockey pumps with controller, four (4) FDC with signage at the Key West Historic Seaport (2 locations, supplied by existing backflow) and City Marina @ Garrison Bight (2 locations, supplied by existing backflow) along with all equipment per the Supplemental Information provided in the document and all necessary appurtenances and record drawings, surveys, and incidental work to provide a complete and serviceable project identified as:

**FIRE PUMPS REPLACEMENT**  
**KEY WEST HISTORIC SEAPORT**  
**CITY MARINA @ GARRISON BIGHT**

1. Design, installation & materials to be in accordance with NFPA 20, current edition, installation of stationary pumps for fire protection and NFPA 13, current edition, standard for the installation of sprinkler systems.
  2. All wiring of panels and controllers by Electrical Contractor.
  3. Standard for the Installation of Stationary Pumps for Fire Protection per NFPA 20, Chapter 4, current edition.
  4. Pipe stand & hangers provided where necessary to properly support the fire pump piping per NFPA 20, current edition.
  5. All grooved fittings to be standard Victaulic fittings with grooved couplings or approved equal.
  6. Fire pump to be electric fire pumps, U.L. listed and F.M. approved per attached supplemental information.
  7. Fire pump acceptance testing, performance and maintenance shall meet the requirements of NFPA 20, current edition, chapter 14.
  8. All pipe to be schedule 10 and painted REDF with non-rust paint.
  9. Remove existing fire pump and install new fire pump within existing location. Location shall meet all NFPA 20, current edition and local requirements.
  10. The fire pump contractor shall provide signed and sealed shop drawings.
  11. Fire pump contractors shall be licensed by the City of Key West, along with the State of Florida as a Fire Protection 1 contractor.
- B. The sites consist of an electric fire pump to be removed and new electric fire pump to be installed along with controller, as well as jockey pump and controller. Sites supplied by existing backflow. Contractor responsible for disposal of all removed pumps and equipment.

Provide and install new electric fire pumps to supply fire protection water to the existing locations and any sprinkler system that may be part of the system. Refer to Supplemental Information included in this document.

The existing fire pump locations are to remain and shall meet NFPA 20 requirements.

Fire Department Connections (FDC) shall be installed, as well as signage. All fire pumps are sized to meet existing conditions.

The Supplemental Information within this document provides the complete requirements for the replacement of each fire pump and equipment at all four (4) locations.

1. Key West Bight Ferry Terminal
2. Key West Bight, Margaret Street
3. City Marina West
4. City Marina East

C. Related requirements in other parts of the Contract Documents: General and Supplementary Conditions of the Contract for Construction.

D. Contractor's Duties:

1. In addition to provisions stipulated in other portions of the Contract Documents, the Contractor shall:

- a. Secure permits as necessary for proper execution and completion of the work.
- b. Notify (in writing) all residents and proprietors adjacent to construction site of work to be performed, more specifically the notice shall state the day and time construction will begin, hours of work, the name and phone number of the Contractor's Superintendent and an end date for the project.

E. The Contractor shall be totally responsible for all permits required and shall ensure that construction complies with all applicable local, state, and federal codes.

F. Provide an experienced, qualified, and competent Superintendent to oversee the Work and perform quality assurance inspections. Prior to starting construction, the proposed Superintendent's qualifications shall be submitted in writing to the City for approval. The approved Superintendent shall be expected to remain for the duration of the Project, unless the City or Engineer deem him/her inadequate and requests his/her removal or the Contractor cannot continue his services to the Project for a reason or reasons that shall be communicated in writing to the City.

G. A replacement Superintendent shall be required to follow the same approval process as required for the original. The Superintendent shall provide to the City Inspector Construction Reports for each day of construction, the reports shall be in English, legible, and signed. Contractor shall provide PDF copies monthly. Reports shall include quantity control checks done daily.

H. It shall be the Contractor's responsibility to request approval for entrance to the site for work on Saturdays, Sundays, holidays, and weekday hours other than 7:00 AM until 7:00 PM. No construction can commence before 8:00 AM on weekdays.

- I. The Contractor shall provide material safety data sheets (2 copies) for chemicals, paints, coatings, and materials used on-site prior to initiation of work.

1.2 CONTRACTOR'S USE OF PREMISES

- A. Work shall be scheduled as to not interfere with on-going area activities.
- B. Coordinate use of premises and requirements for security under direction of City.
- C. Assume full responsibility for the protection and safekeeping of products, under this Contract, stored on the site.
- D. Obtain and pay for the use of additional storage or work areas needed for operation.
- E. Contractor shall provide drinking water and toilet facilities for construction personnel; The City will not provide.

1.3 MAINTENANCE OF EXISTING UTILITIES OPERATION

- A. Provide at least three weeks' notice prior to interruption of utility services for temporary or permanent connections.
- B. Keep interruption of utility services, and utility outages during disconnection, moving, and reconnection to a minimum.
- C. All connections shall be installed and tested up to existing fire pump system. Once tested and approved, connection can be made. System down time must be limited to less than 24 hours. If down time is greater than 24 hrs. It shall be contractors' responsibility to provide Fire Watch at contractor's expense. Coordinate any fire watch needs with Lt. Michael Anderson, 305-809-3917 or [michael.anderson@cityofkeywest-fl.gov](mailto:michael.anderson@cityofkeywest-fl.gov).

Testing shall be approved AHJ prior to connections being made.

- D. Keys Energy shall be notified two weeks in advance in writing by the contractor for any KEYS support equipment required by the Contractor during any excavation. (e.g., Power poles next to excavations requiring support, etc.) No additional payment will be paid for this coordination.

\*\*\*\*\*

**SECTION 01014  
PROTECTION OF THE ENVIRONMENT**

**PART 1      GENERAL**

- A. The Contractor shall maintain all work areas within and outside the project boundaries free from environmental pollution, which would be in violation to any federal, state, or local regulations.
- B. The work specified in this Section consists of designing, providing, maintaining and removing temporary erosion and sedimentation controls as necessary.
- C. Temporary erosion controls include, but are not limited to, grassing, mulching, watering, and reseeding on-site surfaces and spoil and borrow area surfaces and providing interceptor ditches at ends of berms and at those locations which will ensure that erosion during construction will be either eliminated or maintained within acceptable limits as established by the OWNER.
- D. Temporary sedimentation controls include, but are not limited to, silt dams, traps, barriers, and appurtenances at the foot of sloped surfaces which will ensure that sedimentation pollution will be either eliminated or maintained within acceptable limits as established by the OWNER.
- E. CONTRACTOR is responsible for providing effective temporary erosion and sediment control measures during construction or until final controls become effective.

**PART 2      PROTECTION OF AIR QUALITY**

- A. The air pollution likely to occur due to construction operations shall be minimized by wetting down bare soils during windy periods, requiring the use of properly operating combustion emission control devices on construction vehicles and equipment used by contractors, and by encouraging the shutdown of motorized equipment not actually in use.
- B. Trash burning will not be permitted on the construction site.
- C. Contractor shall provide dust control for any asphalt / concrete removal and during the asphalt milling operations.

**PART 3      CONSTRUCTION NOISE CONTROL**

**1      GENERAL**

- A. The Contractor shall conduct all his work, use appropriate construction methods and equipment, and furnish and install acoustical barriers, all as necessary so that no noise emanating from the process or any related tool or equipment will exceed legal noise levels, as set forth in the Code of Ordinances, City of Key West, Florida.

2. MITIGATION OF CONSTRUCTION NOISE IMPACT

- A. The Contractor shall submit to the Engineer his plans to mitigate the construction noise impacts and to comply with the noise criteria specified herein, including the method of construction, the equipment to be used, and acoustical treatments if necessary.

**PART 4 PAYMENT**

7.1 GENERAL

- A. Payment for the work will be incidental to the contract.

\*\*\*\*\*

**SECTION 01050  
FIELD ENGINEERING**

**PART 1 GENERAL**

**1.01 DESCRIPTION:**

**A. Work Included:**

1. Provide field-engineering services required for the Project, including but not limited to:
  - a. Survey work required in execution of the Work.
  - b. Civil, Structural, or other professional engineering services specified or required to execute the Contractor's construction methods.

**B. Related Work:**

1. General and Supplementary Conditions of the Contract.
2. Section 01010 Scope of Work.

**1.02 QUALITY ASSURANCE:**

- A. Qualifications of Surveyor or Engineer: Professional Engineer and/or Surveyor currently licensed in the State of Florida.

**1.03 SUBMITTALS:**

- A. Submit name and address of proposed Surveyor and/or Contractor's Engineer to the City.
- B. Upon request of the City's Engineer, submit documentation to verify accuracy of field engineering work.
- C. Submit certificates signed by the Surveyor or Engineer certifying that elevations and locations of the work of this Project are in conformance, or non-conformance, with the Contract Documents.

**PART 2 EXECUTION**

**2.01 EXAMINATION AND PREPARATION OF SITE**

- A. Before starting operations, Contractor shall examine site of work to acquaint himself with conditions to be encountered.
- B. Compare actual site with drawings and specifications.
- C. Report discrepancies affecting work or cost thereof to the City.
- D. Verify exact locations of sewers, water mains, gas mains, above or below ground electrical wires and conduits and structures which may interfere with work.

- E. No extra compensation will be allowed for any extra work made necessary due to conditions or obstacles encountered during progress of work, which could have been determined by examination of site or by contacting Owners of utilities, pipelines and conduits before starting operations.
- F. Comply with State law concerning Sunshine State One Call of Florida, State Statute Title 33, Chapter 556.

## 2.02 LINES AND GRADES

- A. Prior to staking out work, Contractor shall verify established base line, benchmarks, and control points provided.
- B. Contractor shall furnish and maintain lines and grades.
- C. Contractor shall take immediate steps to correct errors or inconsistencies in lines and grades of work to be in conformity with Contract Documents.
- D. Contractor shall be fully responsible for accuracy of lines and grades of work and control and checking and immediate correction of it.

## 2.03 RESTORATION

- A. Items to remain which are disturbed, damaged, or removed when performing required work or for convenience of Contractor or to expedite his operations shall be restored, repaired, reinstalled, or replaced with new work and refinished, as appropriate, so as to be left in as good condition as existed before work commenced and such restoration shall be considered incidental to the work.
- B. Any sidewalks or pavement replaced or installed shall meet ADA requirements.
- C. Existing items to be altered, extended, salvaged, or relocated and reused, if found to be defective in any way, shall be reported to the City before items are disturbed.
- D. Materials and workmanship used in restoring work shall conform in type and quality to original existing construction.

## PART 4 - PAYMENT

### 4.1 GENERAL

- A. Payment for work specified in this section will be incidental to the contract.

\*\*\*\*\*



**SECTION 01300**  
**SUBMITTALS**

**PART 1      GENERAL**

**1.01          GENERAL**

- A. **Inquiries:** Direct to ENGINEER regarding procedure, purpose, or extent of Submittal.
- B. **Submittal Submission Procedures:** As provided in General Conditions, as specified herein, and as may otherwise be established during the preconstruction conference.
- C. **OWNER's Authorization:** At any time, OWNER may authorize changes to procedures and requirements for Submittals, as necessary to accomplish specific purpose of each Submittal. Such authorization will be by Field Order or Work Change Directive.
- D. **Timeliness:** Make submissions in accordance with requirements of individual Specification sections, as shown on the current accepted schedule of Submittals submissions, and in such sequence as to cause no delay in Work or in work of other contractors.
- E. **Identification of Submittals:**
  - 1. Complete, sign, and transmit with each Submittal package, one Transmittal of CONTRACTOR's Submittal Form attached at the end of this section.
  - 2. Identify each Submittal with numbering and tracking system reviewed by ENGINEER:
    - a. Sequentially number each Submittal.
    - b. Resubmission of a Submittal will have original number with sequential alphabetic suffix.
  - 3. Show date of submission and dates of previous submissions.
  - 4. Show Project title and OWNER's contract identification and contract number.
  - 5. Show names of CONTRACTOR, Subcontractor or Supplier, and manufacturer as appropriate.
  - 6. Identify, as applicable, Contract Document section and paragraph to which Submittal applies.
  - 7. Clearly identify revisions from previous submissions.
- F. **Incomplete Submittal Submissions:**
  - 1. At ENGINEER's sole discretion, ENGINEER will either (i) return the entire Submittal for CONTRACTOR's revision/correction and resubmission, or (ii) retain portions of the Submittal and request submission/resubmission of specified items or as noted thereon.
  - 2. Submittals which do not clearly bear CONTRACTOR's specific written indication of CONTRACTOR review and approval of Submittal or which are transmitted with an unsigned or uncertified submission form or as may otherwise be required under Contract Documents, will be returned to

CONTRACTOR unreviewed for resubmission in accordance with Contract Documents.

3. Delays, resequencing or other impact to Work resulting from CONTRACTOR's submission of unchecked or unreviewed, incomplete, inaccurate or erroneous, or nonconforming Submittals, which will require CONTRACTOR's resubmission of a Submittal for ENGINEER's review, shall not constitute a basis of claim for adjustment in Contract Price or Contract Times.

F. Non-specified Submissions: Submissions not required under these Contract Documents and not shown on schedule of Submittals submissions will not be reviewed and will be returned to CONTRACTOR.

G. Transmit Submittals in accordance with current accepted schedule of Submittal submissions, and deliver as follows:

1. Submittals to: Designated Engineer by the General Service Department of the City of Key West.

H. Disposition of Submittals: As specified herein for administrative Submittals. ENGINEER will review, stamp, and indicate requirements for resubmission or acceptance on Submittal as follows:

1. Reviewed as Noted:
  - a. Reference the General Conditions for intent.
  - b. CONTRACTOR may proceed to perform Submittal related Work.
  - d. One copy for ENGINEER's file.
  - e. One copy returned to CONTRACTOR.
2. Revise and Resubmit (Revise/Correct or Develop Replacement and Resubmit):
  - a. Revise/correct in accordance with ENGINEER's comments and resubmit.
  - b. One copy to ENGINEER's file.
  - c. One copy returned to CONTRACTOR appropriately annotated.

I. ENGINEER's Review: ENGINEER will act upon CONTRACTOR's Submittal and transmit response to CONTRACTOR not later than 30 days after receipt, unless: (i) specified otherwise or (ii) accepted by ENGINEER as set forth in Paragraph ENGINEER's Duties below and identified on current accepted schedule of Submittals submissions. Re-submittals will be subject to the same review time.

## 1.02 SHOP DRAWINGS

A. Description: Reference the General Conditions.

B. Excessive Shop Drawing Review: Review of the first submission and two resubmissions of Shop Drawings will be performed by ENGINEER at no cost to CONTRACTOR.

Subsequent additional resubmissions of that Shop Drawing will be reviewed by ENGINEER, however, ENGINEER will document work hours and other expenses required to perform such additional review(s). OWNER shall deduct these costs from Contractor's contract for reimbursement to the ENGINEER.

C. Copies: Submit two (2) copies.

D. Submit Shop Drawings to ENGINEER in accordance with the General Conditions and as specifically required by individual Specification sections for equipment and materials to be furnished under these Contract Documents.

E. Identify and Indicate:

1. Pertinent Drawing sheet(s) and detail number(s), products, units and assemblies, and system or equipment identification or tag numbers.
2. Critical field dimensions and relationships to other critical features of Work.
  - a. Each deviation or variation from Contract Documents.

F. Resubmissions: Clearly identify each correction or change made.

G. Foreign Manufacturers: When proposed, include following additional information:

1. Names and addresses of at least two companies closest to Project that maintain technical service representatives.
2. Complete inventory of spare parts and accessories for each piece of equipment.

H. Preparation:

1. Format: Whenever possible, schedule for and combine Shop Drawings required for submission in each Specification section into a single Submittal package.
2. Present in a clear and thorough manner and of sufficient detail to show kind, size, arrangement, and function of components, materials, and devices and compliance with Contract Documents. Identify details by reference to sheet and detail, and schedule or room numbers shown on Drawings.

#### **PART 4      PAYMENT**

B. Payment for the work in this section will be incidental

\* \* \* \* \*

**SECTION 01530**  
**BARRIERS**

**PART 1 - GENERAL**

1.01 **REQUIREMENTS**

Furnish, install, and maintain suitable barriers as required to prevent public entry, and to protect the work, existing facilities, trees, and plants from construction operations; remove when no longer needed, or at completion of work.

1.02 **RELATED REQUIREMENTS**

A. Section 01010 Scope of Work.

**PART 2 - PRODUCTS**

2.01 **MATERIALS - GENERAL**

Materials may be new or used, suitable for the intended purpose, but must not violate requirements of applicable codes and standards.

2.02 **FENCING**

Minimum fence height shall be four feet. Open-mesh orange plastic fence shall be used to prohibit entry to the construction zone.

2.03 **BARRIERS**

Materials are Contractor's option, as appropriate to serve required purpose.

**PART 3 - EXECUTION**

3.01 **GENERAL**

- A. Install facilities of a neat and reasonably uniform appearance, structurally adequate for the required purposes.
- B. Maintain barriers during entire construction period.
- C. Relocate barriers as required by the progress of construction.

3.02 **FENCES**

- A. Provide and maintain fences necessary to assure security of the site during construction to keep unauthorized people and animals from the site when construction is not in progress.
- B. Provide additional security measures as deemed necessary and approved by the OWNER.

3.03 TREE AND PLANT PROTECTION

- A. Preserve and protect existing trees and plants at site which are designated to remain, and those adjacent to site.
- B. Consult with the OWNER, and remove agreed-on roots and branches which interfere with construction. Employ a qualified tree surgeon to remove branches and treat cuts.

B. Protect root zones of trees and plants:

- 1. Do not allow vehicular traffic or parking.
- 2. Do not store materials or products.
- 3. Prevent dumping of refuse or chemically injurious materials or liquids.
- 4. Prevent puddling or continuous running water.

- D. Carefully supervise excavating, grading and filling, and other construction operations, to prevent damage.
- E. Replace, or suitably trim trees and plants designated to remain which are damaged or destroyed due to construction operations.

3.04 REMOVAL

- A. Completely remove barricades when construction has progressed to the point that they are no longer needed and when approved by the OWNER.
- B. Repair damage caused by construction. Fill and grade areas of the site to the required elevations, and clean up the area.

\*\*\*\*\*

**SECTION 01700**  
**CONTRACT CLOSEOUT**

**PART 1 - GENERAL**

**1.01 REQUIREMENTS**

Contract completion includes substantial completion, final inspection after completion, final cleaning, contractor's closeout submittals, and final adjustment of accounts.

**1.02 SUBSTANTIAL COMPLETION**

- A. When Contractor considers work has reached substantial completion, he shall submit to the OWNER the following:
  - a. Written notice that the work is substantially complete in accordance with Contract Documents.
  - b. A list of items yet to be completed or corrected and explanations thereof.
- B. Within a reasonable time upon receipt of such notice, the OWNER will make an inspection, if necessary, to determine the status of completion.
- C. Should the OWNER determine that the work is not substantially complete:
  - a. The OWNER will promptly notify the Contractor in writing, giving the reasons thereof.
  - b. Contractor shall remedy the deficiencies in the work and send a second written notice of Substantial Completion to the OWNER.
  - c. Upon receipt of the second notice, the OWNER will review the work.
- D. When the OWNER finds that the Work is substantially complete he will issue a Certificate of Substantial Completion with a tentative list of items to be completed or corrected before final inspection.

**1.03 FINAL INSPECTION AFTER COMPLETION**

- A. When Contractor considers the Work is complete with all minor deficiencies completed or corrected, he shall submit written certification that:
  - a. Contract Document requirements have been met.

- b. Work has been inspected for compliance with Contract Documents.
  - c. Work has been completed in accordance with Contract Documents.
  - d. All minor deficiencies have been corrected or completed and the Work is ready for final inspection.
  - e. Project record documents are complete and submitted.
- B. Within a reasonable time upon receipt of such certification, the OWNER will make an inspection to verify the status of completion.
  - C. Should the OWNER determine that the work is incomplete or defective:
    - a. The OWNER will promptly notify the Contractor in writing, listing the incomplete or defective work.
    - b. Contractor shall remedy the deficiencies in the work and send a second written certification to the OWNER that the work is complete.
    - c. Upon receipt of the second certification, the OWNER will review the Work.
  - D. When the OWNER determines that the work is acceptable, under the Contract Documents, he shall request the Contractor to make closeout submittals.

#### 1.04 FINAL CLEANING

- A. Execute final cleaning prior to final inspection.
- B. Clean site; sweep paved areas, rake clean other surfaces.
- C. Remove waste and surplus materials, rubbish, and construction facilities from the Project and from the site.

#### 1.05 CONTRACTOR'S CLOSEOUT SUBMITTALS

- A. Project Record Documents
  - a. At Contract Closeout, submit documents with transmittal letter containing date, project title, Contractor's name and address, list of documents, and signature of Contractor.
  - b. Changes made by Field Order or by Change Order.
- B. Evidence of payment and Release of Liens.

#### 1.06 FINAL ADJUSTMENT OF ACCOUNTS

- A. Submit a final statement of accounting to the OWNER.
- B. Statement shall reflect all adjustments to the Contract Sum.
  - a. The original Contract sum.
  - b. Additions and deductions resulting from:

- Previous change orders or written amendment.
  - Allowances
  - Unit prices
  - Deductions for uncorrected work.
  - Deductions for liquidated damages
  - Other adjustments
- c. Total contract sum as adjusted
  - d. Previous payments
  - e. Sum remaining due

PART 2 - PRODUCTS (not used)

PART 3 - EXECUTION (not used)

\*\*\*\*\*



---

**PART 5**

**SUPPLEMENTAL INFORMATION**

---



## LOCATION(S) MAP

(NTS)

**PUMP #1**

**KEY WEST BIGHT FERRY TERMINAL**



### City of Key West

Project name	Eight Ferry Terminal	Quote Number / ID	A-20347-F
Customer	City of Key West	Model / Stages	5PVF7 / 1
Tag Number		Flow, rated	500 USgpm
Customer ref. / PO		Differential head / pressure, rated	55.00 psi
		Speed, rated	3520 rpm

### LEAD TIME

	Lead Time Total	8 wks
--	-----------------	-------

### Pump

Qty	Description
1	<p><b>5PVF7</b></p> <p><b>Fire Pump System</b></p> <p><b>Mount</b></p> <p>PumpType: New Pump</p> <p>Scope of Supply: Fire Pump with driver and controller</p> <p><b>Pump</b></p> <p>Pump model: 5PVF7</p> <p>Selected pump listing: FM/UL Listed</p> <p>Casing material: Cast Iron</p> <p>Suction flange: 125lb ANSI Flat faced</p> <p>Discharge flange: 125lb ANSI Flat faced</p> <p>Impeller material: Silicon Brass</p> <p>Impeller Wear Ring: Integral</p> <p>Rotation: Clockwise (RH)</p> <p>Shaft material: Carbon steel</p> <p>Shaft sleeve material: Bronze with O-ring</p> <p>Packing type: Standard</p> <p>Nameplate units: US</p> <p>Coating: Standard Red Enamel</p> <p><b>Tests &amp; Certifications</b></p> <p>Performance Tests</p> <p>    Non-witnessed Performance Test</p> <p>Hydrostatic Pressure Tests</p> <p>    Non-witnessed Hydrostatic Test</p> <p><b>Driver Type</b></p> <p>Motor Phase: 3 Phase</p>

### Driver

Qty	Description
1	<p><b>Fire Pump System</b></p> <p><b>Driver Type</b></p> <p>Motor supplied by: Standard factory motor</p> <p>Motor voltage: 200 V</p> <p>Frequency: 60 Hz</p> <p>Starting method: Direct-on-line (DOL)</p> <p>Motor enclosure: Open Drip Proof</p> <p>Motor efficiency: Any</p> <p>Motor manufacturer: All motors</p> <p>Motor: Motor-electric, 02536OP3VFP256JPV-S 256JPV, 25hp, 200V, 60Hz, 3600 rpm WEG, IE2, 1.15</p>



### Accessories

Qty	Description
1	<p>Jockey pump casing relief valve: None selected</p> <p>Casing relief valve: Valve, casing relief, ClaVal, 0.75", 20-300psi, Listing: UL/FM</p> <p>Gauge: -14InHg/290psi Suction, 0-300psi Discharge</p> <p>Hose valve head: 4", Grooved, 0-500USgpm, 400psi MWP, 2 outlets, Cla-Val</p> <p>Hose valve: Valve, hose angle, 2.5" NPT internal thread, National standard, 300psi MWP, Listing: UL/FM</p>

### Controller

Qty	Description
1	<p>Controller brand: Tornatech</p> <p>Controller voltage: 200-208 V</p> <p>Transfer switch: No</p> <p>Controller frequency: 60 Hz</p> <p>Direct Ship Controller: No</p> <p>Controller type: Tornatech GPA Full voltage across the line starter, 25-25hp, 200-208V, 60hz</p> <p>Enclosure: - NEMA 2</p> <p>Enclosure type: NEMA Type 2</p> <p>Withstand Ratings (Controller): - Standard (see manufacturer documentation for value)</p>

### Jockey Pump

Qty	Description
1	<p>Jockey pump supply: Grundfos CR</p> <p>Frequency: 60 Hz</p> <p>Phase: Three</p> <p>Voltage: 208 V</p> <p>Flow rate: Flow rated: 5 USgpm</p> <p>Total discharge head: Total discharge head: 65.00 psi</p> <p>Direct Ship Jockey Pump: No</p> <p>Jockey pump selected: CR 1-6-3ph/0.75Hp 56CFr Duty point: 6USgpm, 69.3psi, Shutoff pressure: 75.8psi, 208V, Oval flange, HQQE Seal type</p> <p>Jockey pump companion flange kit: 250# Flange fitting set (CR1S/1/3/5)</p>

### Jockey Pump Controller

Qty	Description
1	<p>Jockey pump controller required: Yes</p> <p>Manufacturer: Tornatech</p> <p>Voltage: 200-208 V</p> <p>Frequency: 60 Hz</p> <p>Direct ship jockey pump controller: No</p> <p>Jockey pump controller selected: Tornatech Controller JP3, Across the line starter, 0.75hp, 200-208V, 3Ph, 60hz</p> <p>Enclosure: - NEMA 2</p> <p>Enclosure type: NEMA Type 2</p> <p>Application options: - None</p>

### Engineered Skid Package

Qty	Description
1	Engineered Packaged Skid: Not Required



**Commercial**

Qty	Description
1	Shipping Container: Standard Skid Incoterms 2020: FCA Freight Pre-paid and add Named Place:





### Pump Performance Curve

Performance based on test acceptance - Hyd Inst 14.6 Unilateral (1U)  
 The rated point is the only guaranteed point (within the specified HI grade) on the performance curve.  
 The published closed valve head has a +6% tolerance.

Other specified duty points, including their tolerances, shall be per separate agreement between Peerless Pump Co. and buyer.

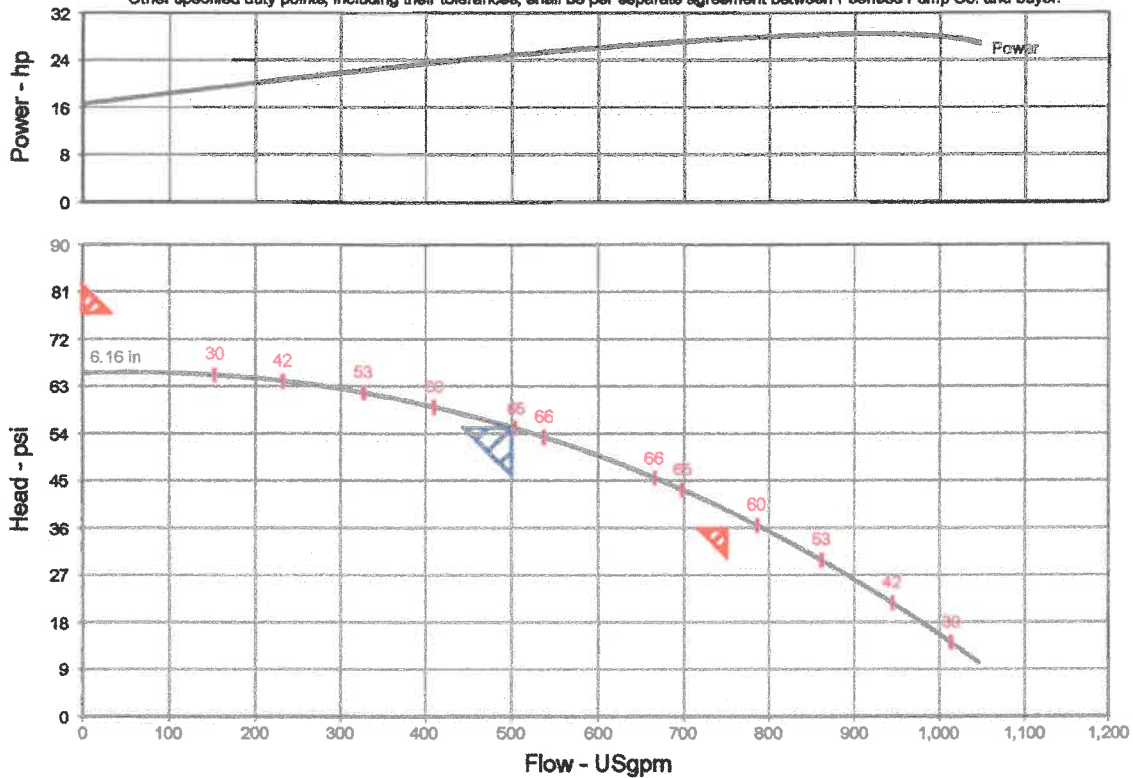

Customer	: Florida Keys Fire	Peerless Model	: 5PVF7
Customer ref. / PO	:	Stages	: 1
Tag Number	: 001	Speed, rated	: 3520 rpm
Service	:	Based on curve number	: 5PVF7-3520 Rev OCT 2020
Quantity	: 1	Efficiency	: 64.84 %
Quote Number / ID	: A-20347-F	Rated power (based on duty point)	: 24.8 hp
Date last saved	: 29 Mar 2023 1:46 PM	Max power (non-overloading)	: 28.4 hp
Flow, rated	: 500 USgpm	NPSH required	: -
Differential head / pressure, rated	: 55.00 psi	Viscosity	: 1.00 cP
Fluid density, rated / max	: 1.000 / 1.000 SG	Cq/Ch/Ce/Cn [ANSI/HI 9.6.7-2010]	: 1.00 / 1.00 / 1.00 / 1.00

Flow (USgpm)	Head (psi)	Efficiency (%)	Power (hp)	NPSHr (ft)	Thrust. total (lbf)
0	65.54	0.00	16.6	-	-
116	65.45	23.81	18.7	-	-
233	64.00	42.01	20.7	-	-
349	61.13	55.10	22.6	-	-
466	56.77	63.33	24.3	-	-
582	50.84	66.71	25.9	-	-
698	43.28	64.99	27.1	-	-
815	34.02	57.68	28.0	-	-
931	23.00	44.05	28.4	-	-
1,048	10.15	23.11	26.8	-	-

### General Arrangement General Arrangement

Installing Contractor(s) To Install Equipment In Accordance With Latest Editions Of National Electric Code, Local Codes And NFPA Pamphlet No. 20 Applicable TO Fire Pump Installations.

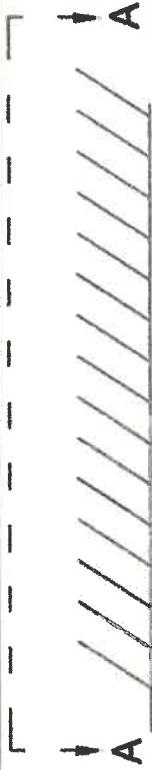

Clearance Recommended To Remove Motor

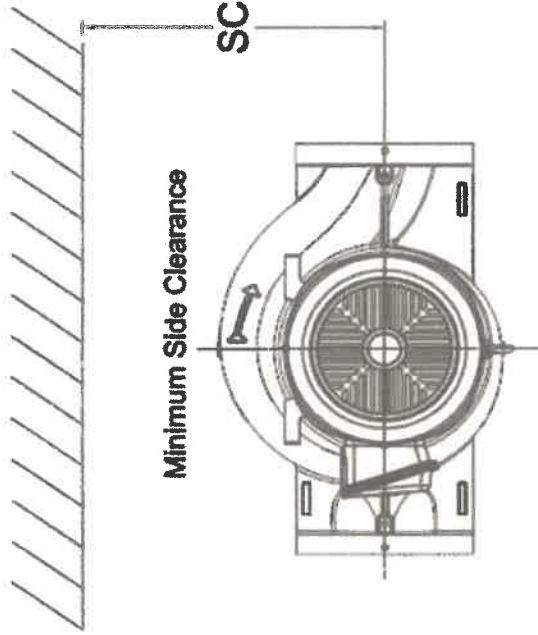

**VIEW A-A**

(H) = Diameter  
(N) = # Of Holes  
(HE) = Diameter Of Bolt Circle

**NOTE 1**  
CONDUIT BOX IS LOCATED 45 DEG FROM SUCTION WHEN VIEWED FROM TOP AND MAY BE ROTATED IN 90 DEG INCREMENTS

GENERAL	
Pump Model	5PVF7
Listing / Approval	FM/JUL Listed
Rated Flow	500 USgpm
Liquid Rated	Cold Water
Pressure Specific Gravity	55.00 psi
Rated Speed	0.99824
MOTOR	3520 rpm
Manufacturer	WEG
Enclosure	ODP
Hp	25.0 hp
Frame	256JPV
Volt/Ph/Hz	200V / 3Ph / 60Hz
Service Factor	1.15
Customer	Florida Keys Fire
Quote No.	A-20347-F
Item No.	001
Project	Signal Ferry Terminal
Date	10/29/2023

OHC	22.00 in	HA	11.00 in	SC	18.00 in	Discharge	5.00 in
O	7.25 in	HG	0.56 in	H	0.50 in	Suction	5.00 in
C	37.00 in	VV	11.00 in	N	4.00 in		
VD	10.00 in	X	9.50 in	HE	9.88 in		



# City of Key West Fire Pump Replacement

## FIRE PUMP GENERAL NOTES

1. DESIGN, INSTALLATION & MATERIALS TO BE IN ACCORDANCE WITH NFPA 20, 2016 EDITION, INSTALLATION OF STATIONARY PUMPS FOR FIRE PROTECTION AND NFPA 13, 2016 EDITION, STANDARD FOR THE INSTALLATION OF SPRINKLER SYSTEMS.
2. ALL WIRING OF PANELS AND CONTROLLERS BY ELECTRICAL CONTRACTOR.
3. PIPE STANDS & HANGERS PROVIDED WHERE NECESSARY TO PROPERLY SUPPORT THE FIRE PUMP PIPING PER NFPA 20, 2016 EDITION.
4. ALL GROOVED FITTINGS TO BE STANDARD VICTAULIC FITTINGS WITH GROOVED COUPLINGS OR APPROVED EQUAL.
5. FIRE PUMP TO BE CITY APPROVED ELECTRIC PEERLESS FIRE PUMPS, U.L. LISTED AND F.M. APPROVED PER SPECIFICATIONS ATTACHED.
6. FIRE PUMP ACCEPTANCE TESTING, PERFORMANCE AND MAINTENANCE SHALL MEET THE REQUIREMENTS OF NFPA 20, 2016 EDITION CHAPTER 14.
7. ALL PIPE TO BE SCHEDULE 10 AND PAINTED RED WITH NON-RUST PAINT.
8. REMOVE EXISTING FIRE PUMP AND INSTALL NEW FIRE PUMP WITHIN EXISTING LOCATION. LOCATION SHALL MEET ALL NFPA 20, 2016 EDITION AND LOCAL REQUIREMENTS.
9. THE FIRE PUMP CONTRACTOR SHALL PROVIDE SHOP DRAWINGS.
10. FIRE PUMP CONTRACTOR SHALL BE LICENSED BY THE CITY OF KEY WEST, ALONG WITH THE STATE OF FLORIDA AS A FIRE PROTECTION 1 CONTRACTOR.

# **City of Key West Fire Pump Replacement**

## **SCOPE OF WORK**

**THIS SITE CONSISTS OF AN EXISTING ELECTRIC FIRE PUMP TO BE REMOVED AND NEW PEERLESS FIRE PUMP WILL BE INSTALLED ALONG WITH CONTROLLER, AS WELL AS JOCKEY PUMP AND CONTROLLER. SITE SUPPLIED BY AN EXISTING BACKFLOW.**

**PROVIDE AND INSTALL NEW PEERLESS ELECTRIC FIRE PUMP TO SUPPLY FIRE PROTECTION WATER TO THE EXISTING LOCATION AND ANY SPRINKLER SYSTEM THAT MAYBE PART OF SYSTEM. SEE ATTACHED PEERLESS FIRE PUMP DESCRIPTION, ALONG WITH EQUIPMENT ATTACHED.**

**THE EXISTING FIRE PUMP LOCATION IS TO REMAIN AND SHALL MEET NFPA 20 REQUIREMENTS.**

**FIRE DEPARTMENT CONNECTION SHALL BE INSTALLED, AS WELL AS SIGNAGE. THE FIRE PUMP IS SIZED TO MEET THE EXISTING CONDITIONS.**

**FIND ATTACHED COMPLETE REQUIREMENT AND SPECIFICATIONS FOR THE REPLACEMENT OF EXISTING FIRE PUMP AT THIS LOCATION.**

**PUMP #2**

**KEY WEST BIGHT – MARGARET STREET**



### City of Key West

Project name	Margaret Street	Quote Number / ID	A-20348-F
Customer	City of Key West	Model / Stages	5PVF11 / 1
Tag Number		Flow, rated	500 USgpm
Customer ref. / PO		Differential head / pressure, rated	95.00 psi
		Speed, rated	3550 rpm

### LEAD TIME

	Lead Time Total	8 wks
--	-----------------	-------

### Pump

Qty	Description
1	<p><b>5PVF11</b></p> <p><b>Fire Pump System</b></p> <p><b>Mount</b></p> <p>PumpType: New Pump</p> <p>Scope of Supply: Fire Pump with driver and controller</p> <p><b>Pump</b></p> <p>Pump model: 5PVF11</p> <p>Selected pump listing: UL Listed</p> <p>Casing material: Cast iron</p> <p>Suction flange: 125lb ANSI Flat faced</p> <p>Discharge flange: 125lb ANSI Flat faced</p> <p>Impeller material: Silicon Brass</p> <p>Impeller Wear Ring: Integral</p> <p>Rotation: Clockwise (RH)</p> <p>Shaft material: Carbon steel</p> <p>Shaft sleeve material: Bronze with O-ring</p> <p>Packing type: Standard</p> <p>Nameplate units: US</p> <p>Coating: Standard Red Enamel</p> <p><b>Tests &amp; Certifications</b></p> <p>Performance Tests</p> <p>    Non-witnessed Performance Test</p> <p>Hydrostatic Pressure Tests</p> <p>    Non-witnessed Hydrostatic Test</p> <p><b>Driver Type</b></p> <p>Motor Phase: 3 Phase</p>

### Driver

Qty	Description
1	<p><b>Fire Pump System</b></p> <p><b>Driver Type</b></p> <p>Motor supplied by: Standard factory motor</p> <p>Motor voltage: 460 V</p> <p>Frequency: 60 Hz</p> <p>Starting method: Direct-on-line (DOL)</p> <p>Motor enclosure: Open Drip Proof</p> <p>Motor efficiency: Any</p> <p>Motor manufacturer: All motors</p> <p>Motor: Motor-electric, 05036OP3EFP324JPV-W4 324JPV, 50hp, 460V, 60Hz, 3600 rpm WEG, IE2, 1.15</p>



### Accessories

Qty	Description
1	<p>Jockey pump casing relief valve: None selected</p> <p>Casing relief valve: Valve, casing relief, ClaVal, 0.75", 20-300psi, Listing: UL/FM</p> <p>Gauge: -14InHg/290psi Suction, 0-300psi Discharge</p> <p>Hose valve head: 4", Grooved, 0-500USgpm, 400psi MWP, 2 outlets, Cla-Val</p> <p>Hose valve: Valve, hose angle, 2.5" NPT internal thread, National standard, 300psi MWP, Listing: UL/FM</p>

### Controller

Qty	Description
1	<p>Controller brand: Tomatech</p> <p>Controller voltage: 440-480 V</p> <p>Transfer switch: No</p> <p>Controller frequency: 60 Hz</p> <p>Direct Ship Controller: No</p> <p>Controller type: Tomatech GPA Full voltage across the line starter, 50-50hp, 440-480V, 60hz</p> <p>Enclosure: - NEMA 2</p> <p>Enclosure type: NEMA Type 2</p> <p>Withstand Ratings (Controller): - Standard (see manufacturer documentation for value)</p>

### Jockey Pump

Qty	Description
1	<p>Jockey pump supply: Grundfos CR</p> <p>Frequency: 60 Hz</p> <p>Phase: Three</p> <p>Voltage: 460 V</p> <p>Flow rate: Flow rated: 5 USgpm</p> <p>Total discharge head: Total discharge head: 105.0 psi</p> <p>Direct Ship Jockey Pump: No</p> <p>Jockey pump selected: CR 1-9-3ph/1Hp 56CFr Duty point: 6USgpm, 103.9psi, Shutoff pressure: 112.1psi, 460V, Oval flange, HQQE Seal type</p> <p>Jockey pump companion flange kit: 250# Flange fitting set (CR1S/1/3/5)</p>

### Jockey Pump Controller

Qty	Description
1	<p>Jockey pump controller required: Yes</p> <p>Manufacturer: Tomatech</p> <p>Voltage: 440-480 V</p> <p>Frequency: 60 Hz</p> <p>Direct ship jockey pump controller: No</p> <p>Jockey pump controller selected: Tomatech Controller JP3, Across the line starter, 1.00hp, 440-480V, 3Ph, 60hz</p> <p>Enclosure: - NEMA 2</p> <p>Enclosure type: NEMA Type 2</p> <p>Application options: - None</p>

### Engineered Skid Package

Qty	Description
1	Engineered Packaged Skid: Not Required

### Commercial

Qty	Description
1	Shipping Container: Standard Skid



Commercial	
Qty	Description
	Incoterms 2020: FCA Freight Pre-paid and add Named Place:



### Pump Performance Curve

Performance based on test acceptance - Hyd Inst 14.8 Unilateral (1U)  
 The rated point is the only guaranteed point (within the specified HI grade) on the performance curve.  
 The published closed valve head has a +6% tolerance.

Other specified duty points, including their tolerances, shall be per separate agreement between Peerless Pump Co. and buyer.

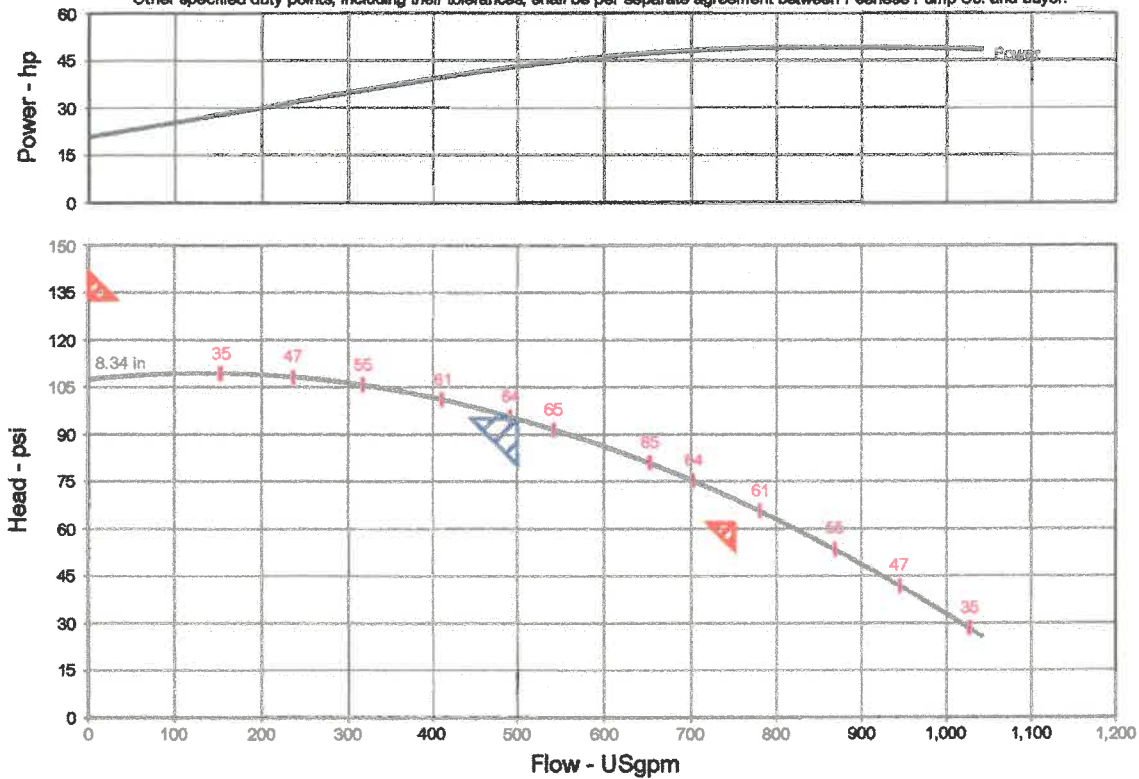

Customer	: Florida Keys Fire	Peerless Model	: 5PVF11
Customer ref. / PO	:	Stages	: 1
Tag Number	: 001	Speed, rated	: 3550 rpm
Service	:	Based on curve number	: 5PVF11-3550 Rev May 2019
Quantity	: 1	Efficiency	: 64.22 %
Quote Number / ID	: A-20348-F	Rated power (based on duty point)	: 43.1 hp
Date last saved	: 29 Mar 2023 1:57 PM	Max power (non-overloading)	: 49.2 hp
Flow, rated	: 500 USgpm	NPSH required	: -
Differential head / pressure, rated	: 95.00 psi	Viscosity	: 1.00 cP
Fluid density, rated / max	: 1.000 / 1.000 SG	Cq/Ch/Ce/Cn [ANSI/HI 9.6.7-2010]	: 1.00 / 1.00 / 1.00 / 1.00

Flow (USgpm)	Head (psi)	Efficiency (%)	Power (hp)	NPSHr (ft)	Thrust, total (lbf)
0	107.5	0.00	20.9	-	-
116	109.4	28.38	26.1	-	-
232	108.4	46.45	31.5	-	-
348	104.5	57.32	37.0	-	-
463	97.70	63.18	41.8	-	-
579	88.20	65.33	45.6	-	-
695	76.08	64.18	48.1	-	-
811	61.48	59.25	49.1	-	-
927	44.61	49.17	49.1	-	-
1,043	25.71	32.21	48.6	-	-





### General Arrangement

Installing Contractor(s) To Install Equipment In Accordance With Latest Editions Of National Electric Code, Local Codes And NFPA Pamphlet No. 20 Applicable TO Fire Pump Installations.

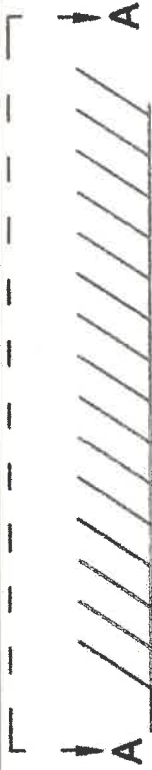

Clearance Recommended To Remove Motor

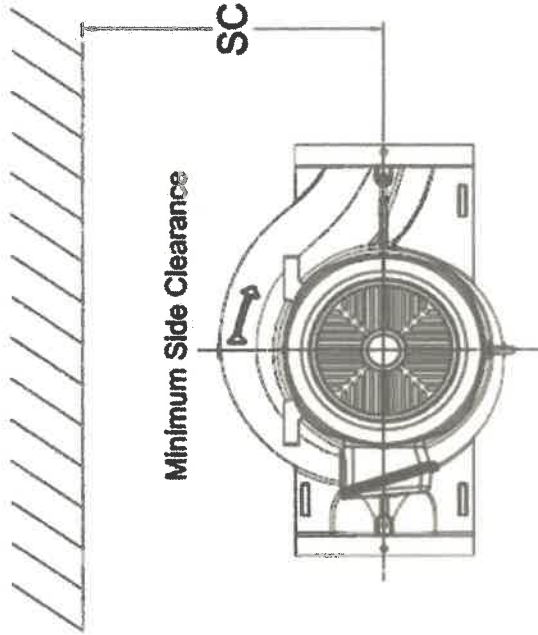

### VIEW A-A

(H) = Diameter  
(N) = # Of Holes  
(HE) = Diameter Of Bolt Circle

**NOTE 1**  
CONDUIT BOX IS LOCATED 45 DEG FROM SUCTION WHEN VIEWED FROM TOP AND MAY BE ROTATED IN 90 DEG INCREMENTS

<b>GENERAL</b>	
Pump Model	SPVF11
Listing / Approval	UL Listed
Rated Flow	500 USgpm
Liquid Rated	Cold Water
Pressure	95.00 psi
Specific Gravity	0.99824
Rated Speed	3550 rpm
<b>MOTOR</b>	
Manufacturer	WEG
Enclosure	ODP
Hp	50.0 hp
Frame	324JpV
Volt/Ph/Hz	460V / 3Ph / 60Hz
Service Factor	1.15
<b>Customer</b>	
Customer	Florida Keys Fire
Quote No.	A-203-8-F
Item No.	001
Project	Bight Marina Turtle Krawis
Date	03/29/2023

OHC	6.00 in	HA	11.00 in	SC	18.00 in	Discharge	5.00 in
O	8.38 in	HG	0.56 in	H	0.50 in	Suction	5.00 in
C	41.00 in	YY	11.63 in	N	4.00 in		
VD	9.81 in	X	11.62 in	HE	9.88 in		



# City of Key West Fire Pump Replacement

## FIRE PUMP GENERAL NOTES

1. DESIGN, INSTALLATION & MATERIALS TO BE IN ACCORDANCE WITH NFPA 20, 2016 EDITION, INSTALLATION OF STATIONARY PUMPS FOR FIRE PROTECTION AND NFPA 13, 2016 EDITION, STANDARD FOR THE INSTALLATION OF SPRINKLER SYSTEMS.
2. ALL WIRING OF PANELS AND CONTROLLERS BY ELECTRICAL CONTRACTOR.
3. PIPE STANDS & HANGERS PROVIDED WHERE NECESSARY TO PROPERLY SUPPORT THE FIRE PUMP PIPING PER NFPA 20, 2016 EDITION.
4. ALL GROOVED FITTINGS TO BE STANDARD VICTAULIC FITTINGS WITH GROOVED COUPLINGS OR APPROVED EQUAL.
5. FIRE PUMP TO BE CITY APPROVED ELECTRIC PEERLESS FIRE PUMPS, U.L. LISTED AND F.M. APPROVED PER SPECIFICATIONS ATTACHED.
6. FIRE PUMP ACCEPTANCE TESTING, PERFORMANCE AND MAINTENANCE SHALL MEET THE REQUIREMENTS OF NFPA 20, 2016 EDITION CHAPTER 14.
7. ALL PIPE TO BE SCHEDULE 10 AND PAINTED RED WITH NON-RUST PAINT.
8. REMOVE EXISTING FIRE PUMP AND INSTALL NEW FIRE PUMP WITHIN EXISTING LOCATION. LOCATION SHALL MEET ALL NFPA 20, 2016 EDITION AND LOCAL REQUIREMENTS.
9. THE FIRE PUMP CONTRACTOR SHALL PROVIDE SHOP DRAWINGS.
10. FIRE PUMP CONTRACTOR SHALL BE LICENSED BY THE CITY OF KEY WEST, ALONG WITH THE STATE OF FLORIDA AS A FIRE PROTECTION 1 CONTRACTOR.

# **City of Key West Fire Pump Replacement**

## **SCOPE OF WORK**

**THIS SITE CONSISTS OF AN EXISTING ELECTRIC FIRE PUMP TO BE REMOVED AND NEW PEERLESS FIRE PUMP WILL BE INSTALLED ALONG WITH CONTROLLER, AS WELL AS JOCKEY PUMP AND CONTROLLER. SITE SUPPLIED BY AN EXISTING BACKFLOW.**

**PROVIDE AND INSTALL NEW PEERLESS ELECTRIC FIRE PUMP TO SUPPLY FIRE PROTECTION WATER TO THE EXISTING LOCATION AND ANY SPRINKLER SYSTEM THAT MAYBE PART OF SYSTEM. SEE ATTACHED PEERLESS FIRE PUMP DESCRIPTION, ALONG WITH EQUIPMENT ATTACHED.**

**THE EXISTING FIRE PUMP LOCATION IS TO REMAIN AND SHALL MEET NFPA 20 REQUIREMENTS.**

**FIRE DEPARTMENT CONNECTION SHALL BE INSTALLED, AS WELL AS SIGNAGE. THE FIRE PUMP IS SIZED TO MEET THE EXISTING CONDITIONS.**

**FIND ATTACHED COMPLETE REQUIREMENT AND SPECIFICATIONS FOR THE REPLACEMENT OF EXISTING FIRE PUMP AT THIS LOCATION.**

**PUMP #3**

**CITY MARINA @ GARRISON BIGHT - WEST**



### City of Key West

Project name	City Marina at Garrison Bight	Quote Number / ID	A-20345-F
Customer	City of Key West	Model / Stages	5PVF7 / 1
Tag Number	West Side	Flow, rated	500 USgpm
Customer ref. / PO		Differential head / pressure, rated	70.00 psi
		Speed, rated	3520 rpm

### Lead Time

	<b>Lead Time Total</b>	8 wks
--	------------------------	-------

### Pump

Qty	Description
1	<p><b>5PVF7</b></p> <p><b>Fire Pump System</b></p> <p><b>Mount</b></p> <p>PumpType: New Pump</p> <p>Scope of Supply: Fire Pump with driver and controller</p> <p><b>Pump</b></p> <p>Pump model: 5PVF7</p> <p>Selected pump listing: FM/UL Listed</p> <p>Casing material: Cast Iron</p> <p>Suction flange: 125lb ANSI Flat faced</p> <p>Discharge flange: 125lb ANSI Flat faced</p> <p>Impeller material: Silicon Brass</p> <p>Impeller Wear Ring: Integral</p> <p>Rotation: Clockwise (RH)</p> <p>Shaft material: Carbon steel</p> <p>Shaft sleeve material: Bronze with O-ring</p> <p>Packing type: Standard</p> <p>Nameplate units: US</p> <p>Coating: Standard Red Enamel</p> <p><b>Tests &amp; Certifications</b></p> <p>Performance Tests</p> <p style="padding-left: 20px;">Non-witnessed Performance Test</p> <p>Hydrostatic Pressure Tests</p> <p style="padding-left: 20px;">Non-witnessed Hydrostatic Test</p> <p><b>Driver Type</b></p> <p>Motor Phase: 3 Phase</p>

### Driver

Qty	Description
1	<p><b>Fire Pump System</b></p> <p><b>Driver Type</b></p> <p>Motor supplied by: Standard factory motor</p> <p>Motor voltage: 230 V</p> <p>Frequency: 60 Hz</p> <p>Starting method: Direct-on-line (DOL)</p> <p>Motor enclosure: Open Drip Proof</p> <p>Motor efficiency: Any</p> <p>Motor manufacturer: All motors</p> <p>Motor: Motor-electric, 04036OP3EFP286JPV-W4 286JPV, 40hp, 230V, 60Hz, 3600 rpm WEG, IE2, 1.15</p>



### Accessories

Qty	Description
1	<p>Jockey pump casing relief valve: None selected</p> <p>Casing relief valve: Valve, casing relief, ClaVal, 0.75", 20-300psi, Listing: UL/FM</p> <p>Gauge: -14InHg/290psi Suction, 0-300psi Discharge</p> <p>Hose valve head: 4", Grooved, 0-500USgpm, 400psi MWP, 2 outlets, Cla-Val</p> <p>Hose valve: Valve, hose angle, 2.5" NPT internal thread, National standard, 300psi MWP, Listing: UL/FM</p>

### Controller

Qty	Description
1	<p>Controller brand: All manufacturers</p> <p>Controller voltage: 220-240 V</p> <p>Transfer switch: No</p> <p>Controller frequency: 60 Hz</p> <p>Direct Ship Controller: No</p> <p>Controller type: Tornatech GPA Full voltage across the line starter, 40-40hp, 220-240V, 60hz</p> <p>Enclosure: - NEMA 2</p> <p>Enclosure type: NEMA Type 2</p> <p>Withstand Ratings (Controller): - Standard (see manufacturer documentation for value)</p>

### Jockey Pump

Qty	Description
1	<p>Jockey pump supply: Grundfos CR</p> <p>Frequency: 60 Hz</p> <p>Phase: Three</p> <p>Voltage: 230 V</p> <p>Flow rate: Flow rated: 5 USgpm</p> <p>Total discharge head: Total discharge head: 80.00 psi</p> <p>Direct Ship Jockey Pump: No</p> <p>Jockey pump selected: CR 1-7-3ph/0.75Hp 56CFr Duty point: 4USgpm, 86.6psi, Shutoff pressure: 86.6psi, 230V, Oval flange, HQQE Seal type</p> <p>Jockey pump companion flange kit: 250# Flange fitting set (CR1S/1/3/5)</p>

### Jockey Pump Controller

Qty	Description
1	<p>Jockey pump controller required: Yes</p> <p>Manufacturer: Tornatech</p> <p>Voltage: 230-350 V</p> <p>Frequency: 60 Hz</p> <p>Direct ship jockey pump controller: No</p> <p>Jockey pump controller selected: Tornatech Controller JP3, Across the line starter, 0.75hp, 220-240V, 3Ph, 60hz</p> <p>Enclosure: - NEMA 2</p> <p>Enclosure type: NEMA Type 2</p> <p>Application options: - None</p>

### Engineered Skid Package

Qty	Description
1	Engineered Packaged Skid: Not Required



Commercial	
Qty	Description
1	Shipping Container: Standard Skid Incoterms 2020: FCA Freight Pre-paid and add Named Place:



### Pump Performance Curve

Performance based on test acceptance - Hyd Inst 14.6 Unilateral (1U)  
 The rated point is the only guaranteed point (within the specified HI grade) on the performance curve.  
 The published closed valve head has a +6% tolerance.

Other specified duty points, including their tolerances, shall be per separate agreement between Peerless Pump Co. and buyer.

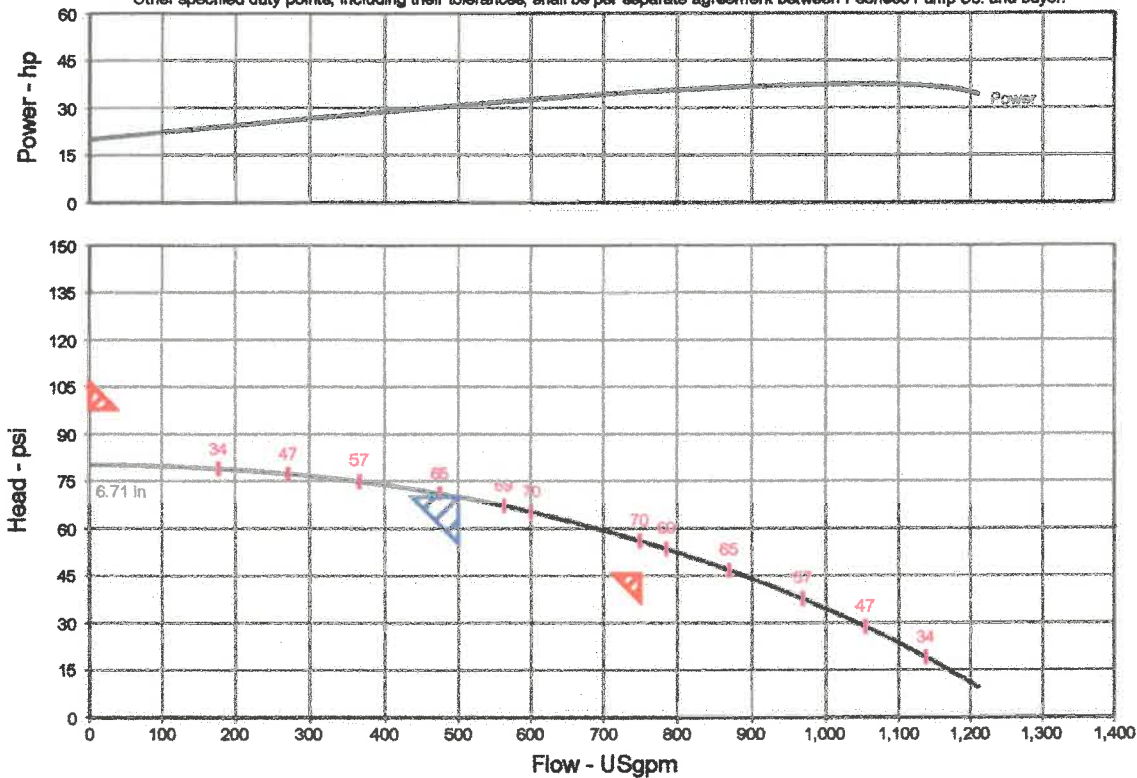

Customer	: Florida Keys Fire	Peerless Model	: 5PVF7
Customer ref. / PO	:	Stages	: 1
Tag Number	: Miami Subs side	Speed, rated	: 3520 rpm
Service	:	Based on curve number	: 5PVF7-3520 Rev OCT 2020
Quantity	: 1	Efficiency	: 66.40 %
Quote Number / ID	: A-20345-F	Rated power (based on duty point)	: 30.8 hp
Date last saved	: 29 Mar 2023 1:17 PM	Max power (non-overloading)	: 37.5 hp
Flow, rated	: 500 USgpm	NPSH required	: -
Differential head / pressure, rated	: 70.00 psi	Viscosity	: 1.00 cP
Fluid density, rated / max	: 1.000 / 1.000 SG	Cq/Ch/Ca/Cn [ANSI/HI 9.6.7-2010]	: 1.00 / 1.00 / 1.00 / 1.00

Flow (USgpm)	Head (psi)	Efficiency (%)	Power (hp)	NPSHr (ft)	Thrust, total (lbf)
0	80.17	0.00	20.1	-	-
135	79.42	27.16	23.0	-	-
269	77.31	46.83	26.0	-	-
404	73.67	60.24	28.8	-	-
539	68.31	68.14	31.5	-	-
674	61.05	70.83	33.9	-	-
808	51.70	68.14	35.8	-	-
943	40.08	59.45	37.1	-	-
1,078	26.02	43.66	37.5	-	-
1,213	9.31	19.25	34.2	-	-



General Arrangement General Arrangement

Installing Contractor(s) To Install Equipment In Accordance With Latest Editions Of National Electric Code, Local Codes And NFPA Pamphlet No. 20 Applicable TO Fire Pump Installations.

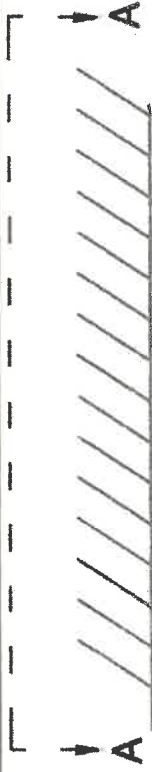

Clearance Recommended To Remove Motor

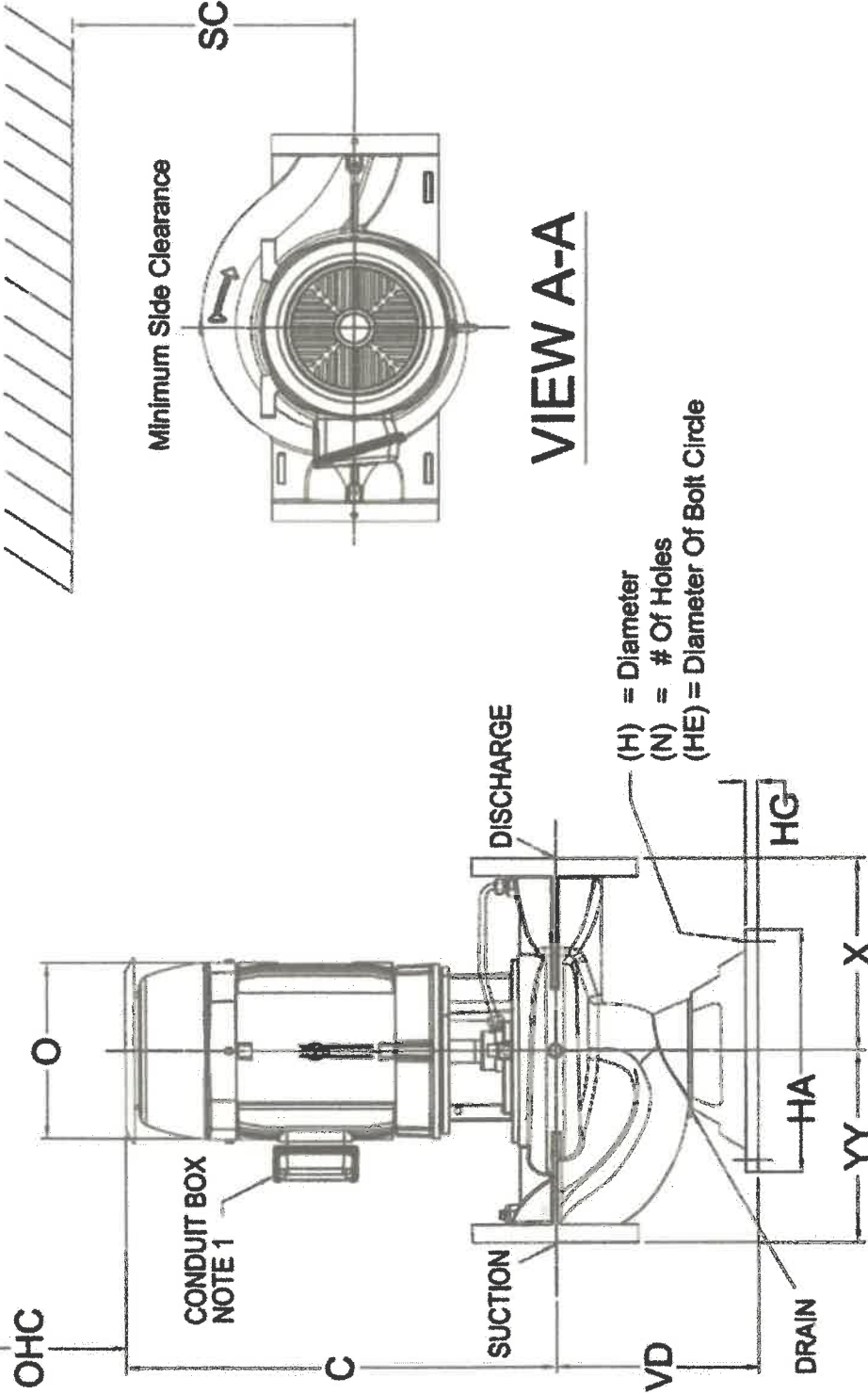

CONDUIT BOX  
NOTE 1

Minimum Side Clearance

VIEW A-A

(H) = Diameter  
(N) = # Of Holes  
(HE) = Diameter Of Bolt Circle

NOTE 1  
CONDUIT BOX IS LOCATED 45 DEG FROM SUCTION WHEN VIEWED FROM TOP AND MAY BE ROTATED IN 90 DEG INCREMENTS

GENERAL	
Pump Model	5PVF7
Listing / Approval	FMUL Listed
Rated Flow	500 USgpm
Liquid	Cold Water
Rated Pressure	70.00 psi
Specific Gravity	0.99824
Rated Speed	3520 rpm
MOTOR	
Manufacturer	WEG
Enclosure	ODP
Hp	40.0 hp
Frame	286JPV
Volt/Ph/Hz	280V / 3Ph / 60Hz
Service Factor	1.15
Customer	
Customer	Florida Keys Fire
Quote No.	A-20345-F
Item No.	Miami Subs side
Project	Garrison Bright Marina
Date	03/29/2023

OHC	22.00 in	RA	11.00 in	SC	18.00 in	Discharge	5.00 in
O	7.25 in	HG	0.56 in	H	0.50 in	Suction	5.00 in
C	40.00 in	YY	11.00 in	N	4.00 in		
VD	10.00 in	X	9.50 in	HE	9.88 in		







### Customer Price Sheet Total Only

Project name	City Marina at Garrison Bight	Quote Number / ID	A-20345-F
Customer	City of Key West	Model / Stages	5PVF7 / 1
Tag Number	West Side	Flow, rated	500 USgpm
Customer ref. / PO		Differential head / pressure, rated	70.00 psi
		Speed, rated	3520 rpm

### Lead Time

		Lead Time Total	8 wks
--	--	-----------------	-------

### Pump

Qty	Description
1	<p><b>5PVF7</b></p> <p><b>Fire Pump System</b></p> <p><b>Mount</b></p> <p>PumpType: New Pump</p> <p>Scope of Supply: Fire Pump with driver and controller</p> <p><b>Pump</b></p> <p>Pump model: 5PVF7</p> <p>Selected pump listing: FM/UL Listed</p> <p>Casing material: Cast Iron</p> <p>Suction flange: 125lb ANSI Flat faced</p> <p>Discharge flange: 125lb ANSI Flat faced</p> <p>Impeller material: Silicon Brass</p> <p>Impeller Wear Ring: Integral</p> <p>Rotation: Clockwise (RH)</p> <p>Shaft material: Carbon steel</p> <p>Shaft sleeve material: Bronze with O-ring</p> <p>Packing type: Standard</p> <p>Nameplate units: US</p> <p>Coating: Standard Red Enamel</p> <p><b>Tests &amp; Certifications</b></p> <p>Performance Tests</p> <p>    Non-witnessed Performance Test</p> <p>Hydrostatic Pressure Tests</p> <p>    Non-witnessed Hydrostatic Test</p> <p><b>Driver Type</b></p> <p>Motor Phase: 3 Phase</p>

### Driver

Qty	Description
1	<p><b>Fire Pump System</b></p> <p><b>Driver Type</b></p> <p>Motor supplied by: Standard factory motor</p> <p>Motor voltage: 230 V</p> <p>Frequency: 60 Hz</p> <p>Starting method: Direct-on-line (DOL)</p> <p>Motor enclosure: Open Drip Proof</p> <p>Motor efficiency: Any</p> <p>Motor manufacturer: All motors</p> <p>Motor: Motor-electric, 04036OP3EFP286JPV-W4 286JPV, 40hp, 230V, 60Hz, 3600 rpm WEG, IE2, 1.15</p>



### Accessories

Qty	Description
1	Jockey pump casing relief valve: None selected Casing relief valve: Valve, casing relief, ClaVal, 0.75", 20-300psi, Listing: UL/FM Gauge: -14InHg/290psi Suction, 0-300psi Discharge Hose valve head: 4", Grooved, 0-500USgpm, 400psi MWP, 2 outlets, Cla-Val Hose valve: Valve, hose angle, 2.5" NPT internal thread, National standard, 300psi MWP, Listing: UL/FM

### Controller

Qty	Description
1	Controller brand: All manufacturers Controller voltage: 220-240 V Transfer switch: No Controller frequency: 60 Hz Direct Ship Controller: No Controller type: Tomatech GPA Full voltage across the line starter, 40-40hp, 220-240V, 60hz Enclosure: - NEMA 2 Enclosure type: NEMA Type 2 Withstand Ratings (Controller): - Standard (see manufacturer documentation for value)

### Jockey Pump

Qty	Description
1	Jockey pump supply: Grundfos CR Frequency: 60 Hz Phase: Three Voltage: 230 V Flow rate: Flow rated: 5 USgpm Total discharge head: Total discharge head: 80.00 psi Direct Ship Jockey Pump: No Jockey pump selected: CR 1-7-3ph/0.75Hp 56CFr Duty point: 4USgpm, 86.6psi, Shutoff pressure: 86.6psi, 230V, Oval flange, HQQE Seal type Jockey pump companion flange kit: 250# Flange fitting set (CR1S/1/3/5)

### Jockey Pump Controller

Qty	Description
1	Jockey pump controller required: Yes Manufacturer: Tomatech Voltage: 230-350 V Frequency: 60 Hz Direct ship jockey pump controller: No Jockey pump controller selected: Tomatech Controller JP3, Across the line starter, 0.75hp, 220-240V, 3Ph, 60hz Enclosure: - NEMA 2 Enclosure type: NEMA Type 2 Application options: - None

### Engineered Skid Package

Qty	Description
1	Engineered Packaged Skid: Not Required



Commercial	
Qty	Description
1	Shipping Container: Standard Skid Incoterms 2020: FCA Freight Pre-paid and add Named Place:



### Pump Performance Curve

Performance based on test acceptance - Hyd Inst 14.6 Unilateral (1U)  
 The rated point is the only guaranteed point (within the specified HI grade) on the performance curve.  
 The published closed valve head has a +6% tolerance.

Other specified duty points, including their tolerances, shall be per separate agreement between Peerless Pump Co. and buyer.

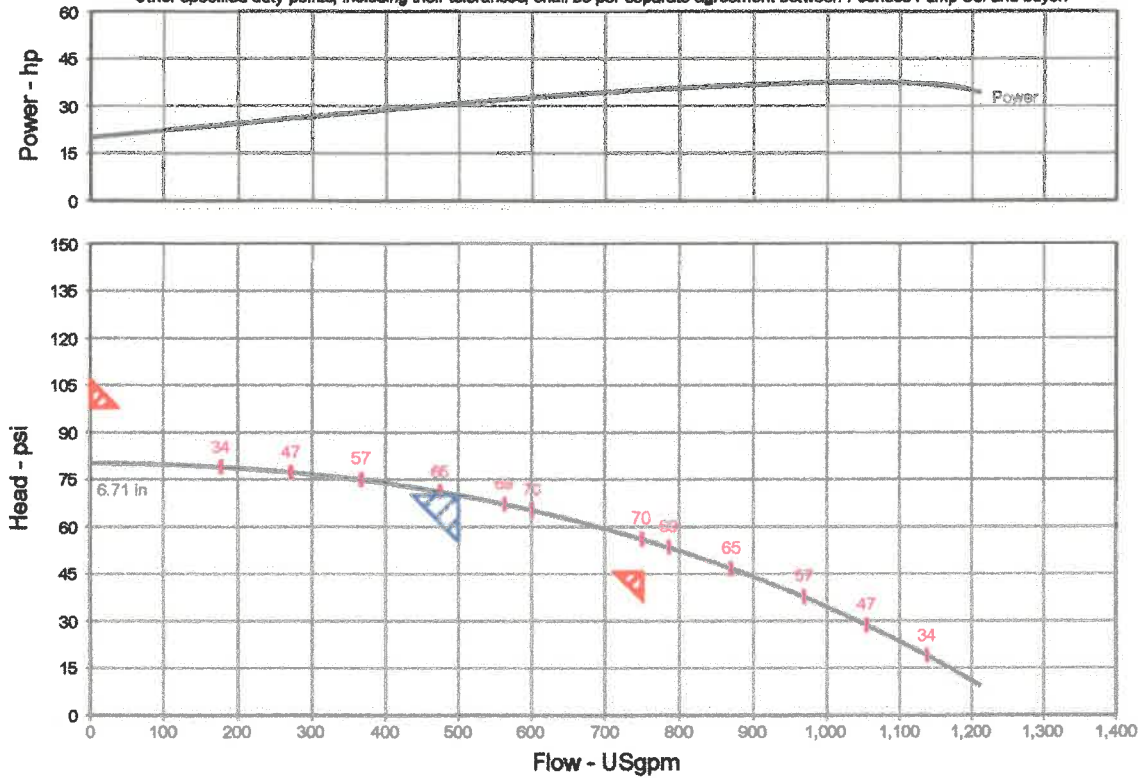

Customer	: Florida Keys Fire	Peerless Model	: 5PVF7
Customer ref. / PO	:	Stages	: 1
Tag Number	: Miami Subs side	Speed, rated	: 3520 rpm
Service	:	Based on curve number	: 5PVF7-3520 Rev OCT 2020
Quantity	: 1	Efficiency	: 66.40 %
Quote Number / ID	: A-20345-F	Rated power (based on duty point)	: 30.8 hp
Date last saved	: 29 Mar 2023 1:18 PM	Max power (non-overloading)	: 37.5 hp
Flow, rated	: 500 USgpm	NPSH required	: -
Differential head / pressure, rated	: 70.00 psi	Viscosity	: 1.00 cP
Fluid density, rated / max	: 1.000 / 1.000 SG	Cq/Ch/Ce/Cn [ANSI/HI 9.6.7-2010]	: 1.00 / 1.00 / 1.00 / 1.00

Flow (USgpm)	Head (psi)	Efficiency (%)	Power (hp)	NPSHr (ft)	Thrust, total (lbf)
0	80.17	0.00	20.1	-	-
135	79.42	27.16	23.0	-	-
269	77.31	46.83	26.0	-	-
404	73.67	60.24	28.8	-	-
539	68.31	68.14	31.5	-	-
674	61.05	70.83	33.9	-	-
808	51.70	68.14	35.8	-	-
943	40.08	59.45	37.1	-	-
1,078	26.02	43.66	37.5	-	-
1,213	9.31	19.25	34.2	-	-



### General Arrangement

Installing Contractor(s) To Install Equipment In Accordance With Latest Editions Of National Electric Code, Local Codes And NFPA Pamphlet No. 20 Applicable TO Fire Pump Installations.



Clearance Recommended To Remove Motor

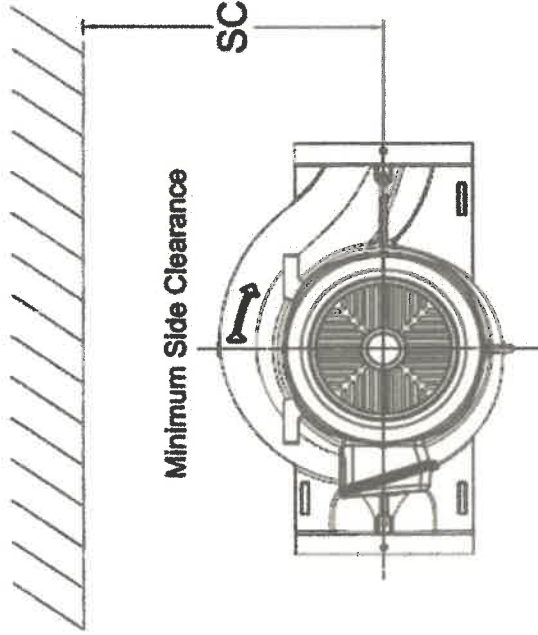

### VIEW A-A

(H) = Diameter  
(N) = # Of Holes  
(HE) = Diameter Of Bolt Circle

**NOTE 1**  
CONDUIT BOX IS LOCATED 45 DEG FROM SUCTION WHEN VIEWED FROM TOP AND MAY BE ROTATED IN 90 DEG INCREMENTS

GENERAL	
Pump Model	5PVF7
Listing / Approval	FM/JUL Listed
Rated Flow	500 USGpm
Liquid	Cold Water
Rated Pressure	70.00 psi
Specific Gravity	0.99824
Rated Speed	3520 rpm
MOTOR	
Manufacturer	WEG
Enclosure	ODP
Hp	40.0 hp
Frame	286JFV
Volt/Ph/Hz	230V / 3Ph / 60Hz
Service Factor	1.15
Customer	
Florida Keys	Fire
Quote No.	A-23-45-F
Item No.	Miami Subs side
Project	Garrison Digital Marina
Date	03/29/2023

OHC	22.00 in	HA	11.00 in	SC	18.00 in	Discharge	5.00 in
O	7.25 in	HG	0.56 in	H	0.50 in	Suction	5.00 in
C	40.00 in	YY	11.00 in	N	4.00 in		
VD	10.00 in	X	9.50 in	HE	9.88 in		

**PUMP #4**

**CITY MARINA @ GARRISON BIGHT - EAST**





### City of Key West

Project name	City Marina At Garrison Bight	Quote Number / ID	A-20345-F
Customer	City of Key West	Model / Stages	5PVF7 / 1
Tag Number	East Side	Flow, rated	500 USgpm
Customer ref. / PO		Differential head / pressure, rated	70.00 psi
		Speed, rated	3520 rpm

		Lead Time Total	8 wks
--	--	-----------------	-------

### Pump

Qty	Description
1	<p><b>5PVF7</b></p> <p><b>Fire Pump System</b></p> <p><b>Mount</b></p> <p>PumpType: New Pump</p> <p>Scope of Supply: Fire Pump with driver and controller</p> <p><b>Pump</b></p> <p>Pump model: 5PVF7</p> <p>Selected pump listing: FM/UL Listed</p> <p>Casing material: Cast Iron</p> <p>Suction flange: 125lb ANSI Flat faced</p> <p>Discharge flange: 125lb ANSI Flat faced</p> <p>Impeller material: Silicon Brass</p> <p>Impeller Wear Ring: Integral</p> <p>Rotation: Clockwise (RH)</p> <p>Shaft material: Carbon steel</p> <p>Shaft sleeve material: Bronze with O-ring</p> <p>Packing type: Standard</p> <p>Nameplate units: US</p> <p>Coating: Standard Red Enamel</p> <p><b>Tests &amp; Certifications</b></p> <p>Performance Tests</p> <p>    Non-witnessed Performance Test</p> <p>Hydrostatic Pressure Tests</p> <p>    Non-witnessed Hydrostatic Test</p> <p><b>Driver Type</b></p> <p>Motor Phase: 3 Phase</p>

### Driver

Qty	Description
1	<p><b>Fire Pump System</b></p> <p><b>Driver Type</b></p> <p>Motor supplied by: Standard factory motor</p> <p>Motor voltage: 230 V</p> <p>Frequency: 60 Hz</p> <p>Starting method: Direct-on-line (DOL)</p> <p>Motor enclosure: Open Drip Proof</p> <p>Motor efficiency: Any</p> <p>Motor manufacturer: All motors</p> <p>Motor: Motor-electric, 04038OP3EFP286JPV-W4 286JPV, 40hp, 230V, 60Hz, 3600 rpm WEG, IE2, 1.15</p>



### Accessories

Qty	Description
1	Jockey pump casing relief valve: None selected Casing relief valve: Valve, casing relief, ClaVal, 0.75", 20-300psi, Listing: UL/FM Gauge: -14InHg/290psi Suction, 0-300psi Discharge Hose valve head: 4", Grooved, 0-500USgpm, 400psi MWP, 2 outlets, Cla-Val Hose valve: Valve, hose angle, 2.5" NPT internal thread, National standard, 300psi MWP, Listing: UL/FM

### Controller

Qty	Description
1	Controller brand: All manufacturers Controller voltage: 220-240 V Transfer switch: No Controller frequency: 60 Hz Direct Ship Controller: No Controller type: Tornatech GPA Full voltage across the line starter, 40-40hp, 220-240V, 60hz Enclosure: - NEMA 2 Enclosure type: NEMA Type 2 Withstand Ratings (Controller): - Standard (see manufacturer documentation for value)

### Jockey Pump

Qty	Description
1	Jockey pump supply: Grundfos CR Frequency: 60 Hz Phase: Three Voltage: 230 V Flow rate: Flow rated: 5 USgpm Total discharge head: Total discharge head: 80.00 psi Direct Ship Jockey Pump: No Jockey pump selected: CR 1-7-3ph/0.75Hp 56CFr Duty point: 4USgpm, 86.6psi, Shutoff pressure: 86.6psi, 230V, Oval flange, HQQE Seal type Jockey pump companion flange kit: 250# Flange fitting set (CR1S/1/3/5)

### Jockey Pump Controller

Qty	Description
1	Jockey pump controller required: Yes Manufacturer: Tornatech Voltage: 230-350 V Frequency: 60 Hz Direct ship jockey pump controller: No Jockey pump controller selected: Tornatech Controller JP3, Across the line starter, 0.75hp, 220-240V, 3Ph, 60hz Enclosure: - NEMA 2 Enclosure type: NEMA Type 2 Application options: - None

### Engineered Skid Package

Qty	Description
1	Engineered Packaged Skid: Not Required





**Commercial**

Qty	Description
1	<b>Shipping Container: Standard Skid</b> Incoterms 2020: FCA Freight Pre-paid and add Named Place:



### Pump Performance Curve

Performance based on test acceptance - Hyd Inst 14.6 Unilateral (1U)  
 The rated point is the only guaranteed point (within the specified HI grade) on the performance curve.  
 The published closed valve head has a +6% tolerance.

Other specified duty points, including their tolerances, shall be per separate agreement between Peerless Pump Co. and buyer.

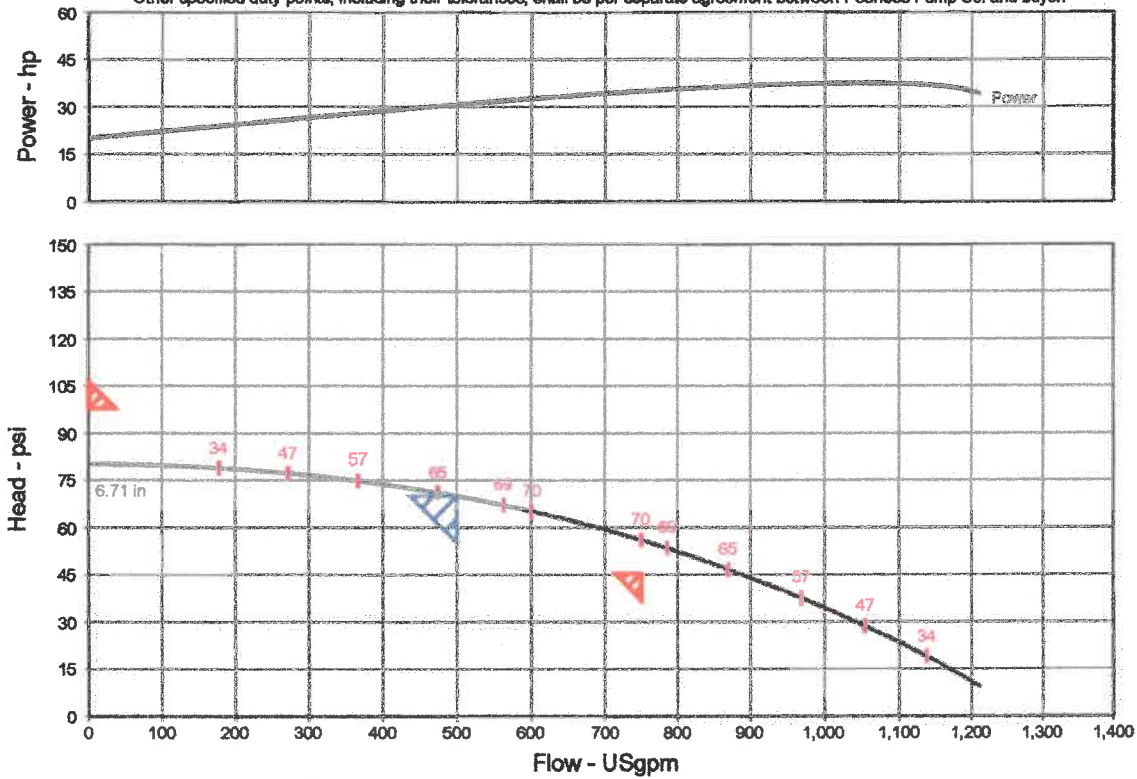

Customer	: Florida Keys Fire	Peerless Model	: 5PVF7
Customer ref. / PO	:	Stages	: 1
Tag Number	: Miami Subs side	Speed, rated	: 3520 rpm
Service	:	Based on curve number	: 5PVF7-3520 Rev OCT 2020
Quantity	: 1	Efficiency	: 66.40 %
Quote Number / ID	: A-20345-F	Rated power (based on duty point)	: 30.8 hp
Date last saved	: 29 Mar 2023 1:17 PM	Max power (non-overloading)	: 37.5 hp
Flow, rated	: 500 USgpm	NPSH required	: -
Differential head / pressure, rated	: 70.00 psi	Viscosity	: 1.00 cP
Fluid density, rated / max	: 1.000 / 1.000 SG	Cq/Ch/Ce/Cn [ANSI/HI 9.6.7-2010]	: 1.00 / 1.00 / 1.00 / 1.00

Flow (USgpm)	Head (psi)	Efficiency (%)	Power (hp)	NPSHr (ft)	Thrust, total (lbf)
0	80.17	0.00	20.1	-	-
135	79.42	27.16	23.0	-	-
269	77.31	46.83	26.0	-	-
404	73.67	60.24	28.8	-	-
539	68.31	68.14	31.5	-	-
674	61.05	70.83	33.9	-	-
808	51.70	68.14	35.8	-	-
943	40.08	59.45	37.1	-	-
1,078	26.02	43.66	37.5	-	-
1,213	9.31	19.25	34.2	-	-



### General Arrangement

Installing Contractor(s) To Install Equipment In Accordance With Latest Editions Of National Electric Code, Local Codes And NFPA Pamphlet No. 20 Applicable TO Fire Pump Installations.

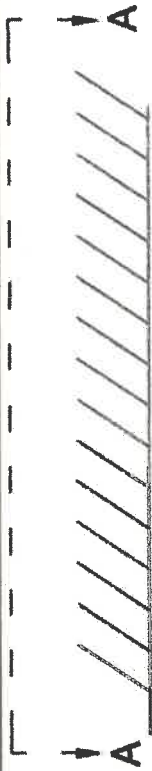

Clearance Recommended To Remove Motor

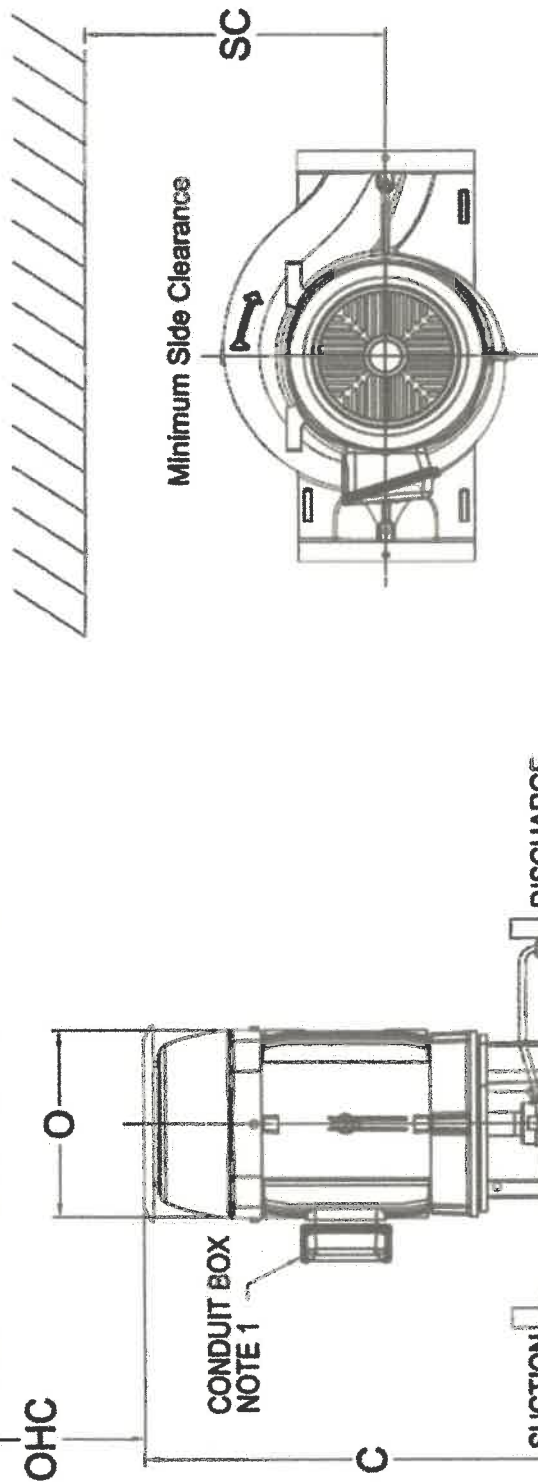

### VIEW A-A

(H) = Diameter  
(N) = # Of Holes  
(HE) = Diameter Of Bolt Circle

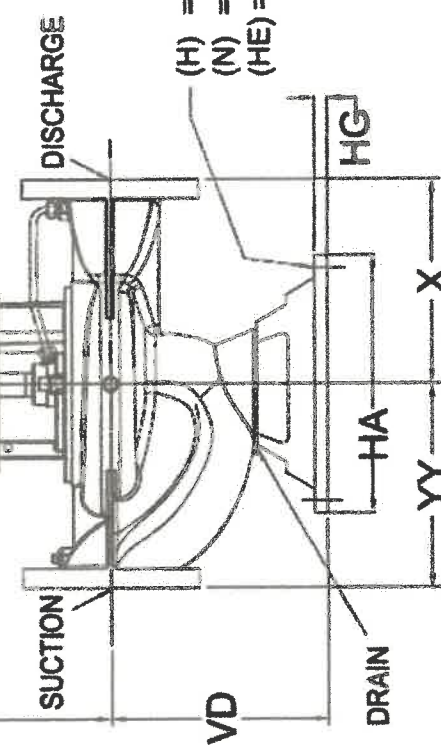

**NOTE 1**  
CONDUIT BOX IS LOCATED 45 DEG FROM SUCTION WHEN VIEWED FROM TOP AND MAY BE ROTATED IN 90 DEG INCREMENTS

GENERAL	
Pump Model	5SPVF7
Listing / Approval	FMJUL Listed
Rated Flow	500 USGPM
Liquid	Cold Water
Rated Pressure	70.00 psi
Specific Gravity	0.99824
Rated Speed	3520 rpm
MOTOR	
Manufacturer	WEG
Enclosure	ODP
Hp	40.0 hp
Frame	285J1PV
Volt/Ph/Hz	280V / 3Ph / 60Hz
Service Factor	1.15
Customer	
Customer	Florida Keys Fire
Quote No.	A-20343-F
Item No.	Miami Sube side
Project	Garrison Bright Marina
Date	03/29/2023

OHC	22.00 in	HA	11.00 in	SC	18.00 in	Discharge	5.00 in
O	7.25 in	HG	0.56 in	H	0.50 in	Suction	5.00 in
C	40.00 in	YY	11.00 in	N	4.00 in		
VD	10.00 in	X	9.50 in	HE	9.88 in		





### City of Key West

Project name	City Marina at Garrison Bight	Quote Number / ID	A-20345-F
Customer	City of Key West	Model / Stages	5PVF7 / 1
Tag Number	West Side	Flow, rated	500 USgpm
Customer ref. / PO		Differential head / pressure, rated	70.00 psi
		Speed, rated	3520 rpm

### Lead Time

	Lead Time Total	8 wks
--	-----------------	-------

### Pump

Qty	Description
1	<p><b>5PVF7</b></p> <p><b>Fire Pump System</b></p> <p><b>Mount</b></p> <p>PumpType: New Pump</p> <p>Scope of Supply: Fire Pump with driver and controller</p> <p><b>Pump</b></p> <p>Pump model: 5PVF7</p> <p>Selected pump listing: FM/UL Listed</p> <p>Casing material: Cast Iron</p> <p>Suction flange: 125lb ANSI Flat faced</p> <p>Discharge flange: 125lb ANSI Flat faced</p> <p>Impeller material: Silicon Brass</p> <p>Impeller Wear Ring: Integral</p> <p>Rotation: Clockwise (RH)</p> <p>Shaft material: Carbon steel</p> <p>Shaft sleeve material: Bronze with O-ring</p> <p>Packing type: Standard</p> <p>Nameplate units: US</p> <p>Coating: Standard Red Enamel</p> <p><b>Tests &amp; Certifications</b></p> <p>Performance Tests</p> <p>    Non-witnessed Performance Test</p> <p>Hydrostatic Pressure Tests</p> <p>    Non-witnessed Hydrostatic Test</p> <p><b>Driver Type</b></p> <p>Motor Phase: 3 Phase</p>

### Driver

Qty	Description
1	<p><b>Fire Pump System</b></p> <p><b>Driver Type</b></p> <p>Motor supplied by: Standard factory motor</p> <p>Motor voltage: 230 V</p> <p>Frequency: 60 Hz</p> <p>Starting method: Direct-on-line (DOL)</p> <p>Motor enclosure: Open Drip Proof</p> <p>Motor efficiency: Any</p> <p>Motor manufacturer: All motors</p> <p>Motor: Motor-electric, 04036OP3EFP286JPV-W4 286JPV, 40hp, 230V, 60Hz, 3600 rpm WEG, IE2, 1.15</p>



### Accessories

Qty	Description
1	<p>Jockey pump casing relief valve: None selected</p> <p>Casing relief valve: Valve, casing relief, ClaVal, 0.75", 20-300psi, Listing: UL/FM</p> <p>Gauge: -14InHg/290psi Suction, 0-300psi Discharge</p> <p>Hose valve head: 4", Grooved, 0-500USgpm, 400psi MWP, 2 outlets, Cla-Val</p> <p>Hose valve: Valve, hose angle, 2.5" NPT internal thread, National standard, 300psi MWP, Listing: UL/FM</p>

### Controller

Qty	Description
1	<p>Controller brand: All manufacturers</p> <p>Controller voltage: 220-240 V</p> <p>Transfer switch: No</p> <p>Controller frequency: 60 Hz</p> <p>Direct Ship Controller: No</p> <p>Controller type: Tornatech GPA Full voltage across the line starter, 40-40hp, 220-240V, 60hz</p> <p>Enclosure: - NEMA 2</p> <p>Enclosure type: NEMA Type 2</p> <p>Withstand Ratings (Controller): - Standard (see manufacturer documentation for value)</p>

### Jockey Pump

Qty	Description
1	<p>Jockey pump supply: Grundfos CR</p> <p>Frequency: 60 Hz</p> <p>Phase: Three</p> <p>Voltage: 230 V</p> <p>Flow rate: Flow rated: 5 USgpm</p> <p>Total discharge head: Total discharge head: 80.00 psi</p> <p>Direct Ship Jockey Pump: No</p> <p>Jockey pump selected: CR 1-7-3ph/0.75Hp 56CFr Duty point: 4USgpm, 86.6psi, Shutoff pressure: 86.6psi, 230V, Oval flange, HQQE Seal type</p> <p>Jockey pump companion flange kit: 250# Flange fitting set (CR1S/1/3/5)</p>

### Jockey Pump Controller

Qty	Description
1	<p>Jockey pump controller required: Yes</p> <p>Manufacturer: Tornatech</p> <p>Voltage: 230-350 V</p> <p>Frequency: 60 Hz</p> <p>Direct ship jockey pump controller: No</p> <p>Jockey pump controller selected: Tornatech Controller JP3, Across the line starter, 0.75hp, 220-240V, 3Ph, 60hz</p> <p>Enclosure: - NEMA 2</p> <p>Enclosure type: NEMA Type 2</p> <p>Application options: - None</p>

### Engineered Skid Package

Qty	Description
1	Engineered Packaged Skid: Not Required





Commercial	
Qty	Description:
1	Shipping Container: Standard Skid Incoterms 2020: FCA Freight Pre-paid and add Named Place:



### Pump Performance Curve

Performance based on test acceptance - Hyd Inst 14.6 Unilateral (1U)  
 The rated point is the only guaranteed point (within the specified HI grade) on the performance curve.  
 The published closed valve head has a +6% tolerance.

Other specified duty points, including their tolerances, shall be per separate agreement between Peerless Pump Co. and buyer.

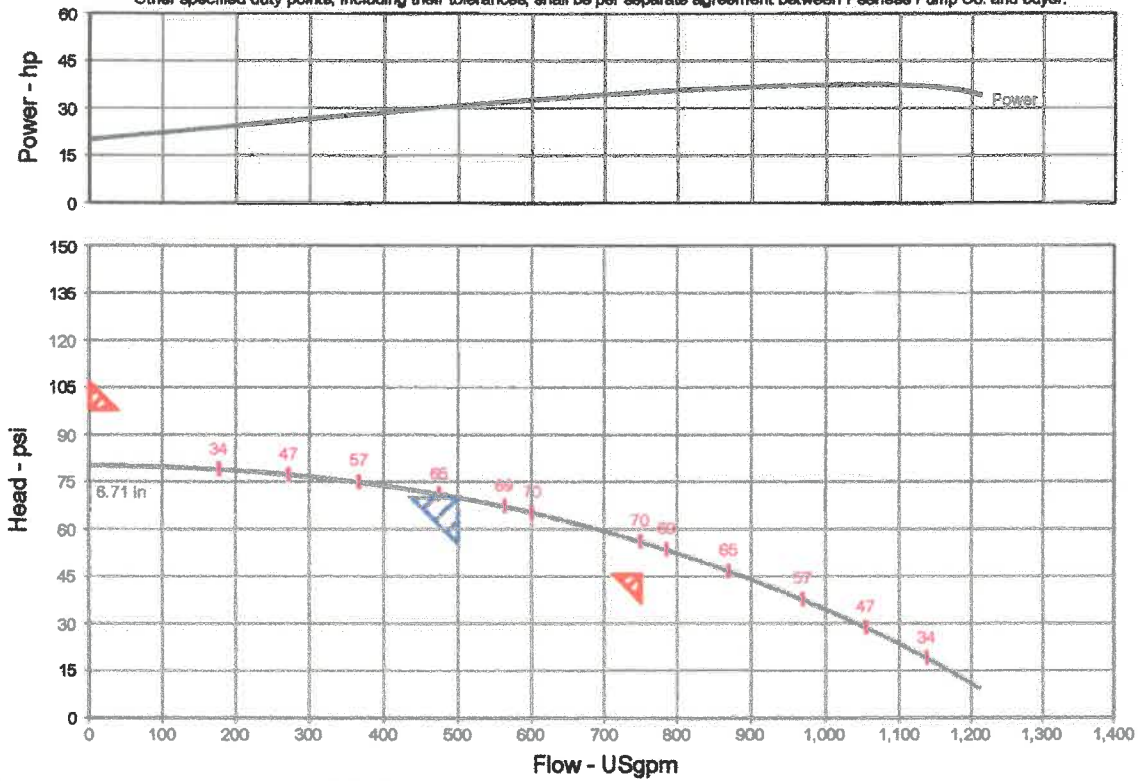

Customer : Florida Keys Fire  
 Customer ref. / PO :  
 Tag Number : Miami Subs side  
 Service :  
 Quantity : 1  
 Quote Number / ID : A-20345-F  
 Date last saved : 29 Mar 2023 1:18 PM  
 Flow, rated : 500 USgpm  
 Differential head / pressure, rated : 70.00 psi  
 Fluid density, rated / max : 1.000 / 1.000 SG

Peerless Model : 5PVF7  
 Stages : 1  
 Speed, rated : 3520 rpm  
 Based on curve number : 5PVF7-3520 Rev OCT 2020  
 Efficiency : 66.40 %  
 Rated power (based on duty point) : 30.8 hp  
 Max power (non-overloading) : 37.5 hp  
 NPSH required : -  
 Viscosity : 1.00 cP  
 Cq/Ch/Ce/Cn [ANSI/HI 9.6.7-2010] : 1.00 / 1.00 / 1.00 / 1.00

Flow (USgpm)	Head (psi)	Efficiency (%)	Power (hp)	NPSHr (ft)	Thrust, total (lbf)
0	80.17	0.00	20.1	-	-
135	79.42	27.16	23.0	-	-
269	77.31	46.83	26.0	-	-
404	73.67	60.24	28.8	-	-
539	68.31	68.14	31.5	-	-
674	61.05	70.83	33.9	-	-
808	51.70	68.14	35.8	-	-
943	40.08	59.45	37.1	-	-
1,078	26.02	43.66	37.5	-	-
1,213	9.31	19.25	34.2	-	-



### General Arrangement

Installing Contractor(s) To Install Equipment In Accordance With Latest Editions Of National Electric Code, Local Codes And NFPA Pamphlet No. 20 Applicable TO Fire Pump Installations.

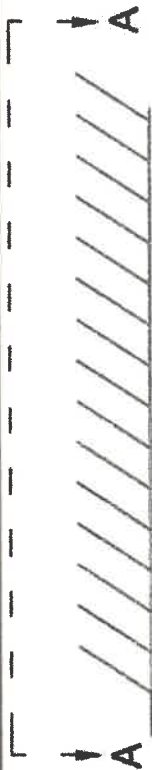

Clearance Recommended To Remove Motor

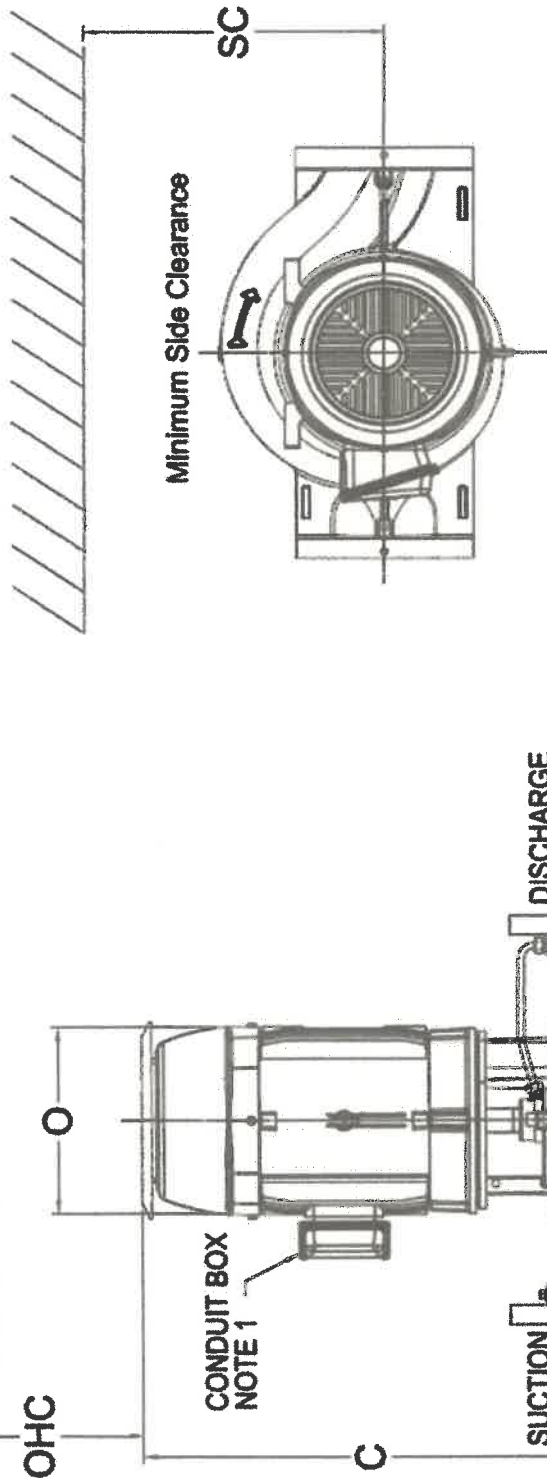

### VIEW A-A

(H) = Diameter  
(N) = # Of Holes  
(HE) = Diameter Of Bolt Circle

**NOTE 1**  
CONDUIT BOX IS LOCATED 45 DEG FROM SUCTION WHEN VIEWED FROM TOP AND MAY BE ROTATED IN 90 DEG INCREMENTS

GENERAL	
Pump Model	SPVF7
Listing / Approval	FMUL Listed
Rated Flow	500 USgpm
Liquid	Cold Water
Rated Pressure	70.00 psi
Specific Gravity	0.99824
Rated Speed	3520 rpm
MOTOR	
Manufacturer	WEG
Enclosure	ODP
Hp	40.0 hp
Frame	286JPV
Volt/Ph/Hz	230V / 3Ph / 60Hz
Service Factor	1.15
Customer	
Customer	Florida Keys Fire
Quote No.	A-20345-F
Item No.	Miami Subs side
Project	Garrison Bight Marina
Date	03/29/2023

OHC	22.00 in	HA	11.00 in	SC	18.00 in	Discharge	5.00 in
O	7.25 in	HG	0.56 in	H	0.50 in	Suction	5.00 in
C	40.00 in	YY	11.00 in	N	4.00 in		
VD	10.00 in	X	9.50 in	HE	9.88 in		



# **City of Key West Fire Pump Replacement**

## **SCOPE OF WORK**

**THIS SITE CONSISTS OF AN EXISTING ELECTRIC FIRE PUMP TO BE REMOVED AND NEW PEERLESS FIRE PUMP WILL BE INSTALLED ALONG WITH CONTROLLER, AS WELL AS JOCKEY PUMP AND CONTROLLER. SITE SUPPLIED BY AN EXISTING BACKFLOW.**

**PROVIDE AND INSTALL NEW PEERLESS ELECTRIC FIRE PUMP TO SUPPLY FIRE PROTECTION WATER TO THE EXISTING LOCATION AND ANY SPRINKLER SYSTEM THAT MAYBE PART OF SYSTEM. SEE ATTACHED PEERLESS FIRE PUMP DESCRIPTION, ALONG WITH EQUIPMENT ATTACHED.**

**THE EXISTING FIRE PUMP LOCATION IS TO REMAIN AND SHALL MEET NFPA 20 REQUIREMENTS.**

**FIRE DEPARTMENT CONNECTION SHALL BE INSTALLED, AS WELL AS SIGNAGE. THE FIRE PUMP IS SIZED TO MEET THE EXISTING CONDITIONS.**

**FIND ATTACHED COMPLETE REQUIREMENT AND SPECIFICATIONS FOR THE REPLACEMENT OF EXISTING FIRE PUMP AT THIS LOCATION.**