

2407-2409 N. Roosevelt Boulevard
Key West, Florida

A graphic consisting of a white rectangular area with a thin blue border, containing the text 'TRAFFIC STUDY' in a bold, dark blue, sans-serif font. Below the text is a solid blue horizontal bar. To the right of this graphic is a vertical cyan bar.

TRAFFIC STUDY

prepared for:
Trepanier & Associates, Inc.

KBP CONSULTING, INC.

December 2018
Updated May 2019

2407-2409 N. Roosevelt Boulevard

Key West, Florida

Traffic Study

December 2018
Updated May 2019

Prepared for:
Trepanier & Associates, Inc.

Prepared by:
KBP Consulting, Inc.
8400 N. University Drive, Suite 309
Tamarac, Florida 33321
Phone: (954) 560-7103

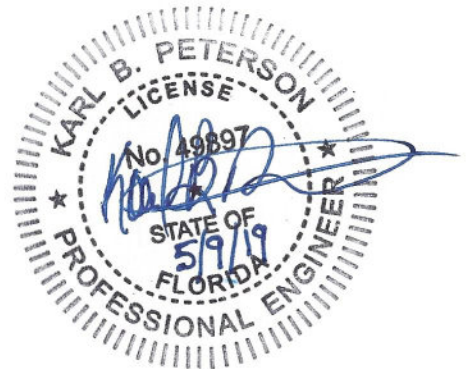

Karl B. Peterson, P.E.
Florida Registration Number 49897
KBP Consulting, Inc.
8400 N. University Drive, Suite 309
Tamarac, Florida 33321
CA # 29939

TABLE OF CONTENTS

INTRODUCTION	1
INVENTORY	3
Existing/Approved Land Uses and Access	3
Proposed Land Uses and Access	3
Transportation System	4
Transit Service	4
Alternative Modes of Transportation.....	4
TRIP GENERATION	7
TRIP DISTRIBUTION AND TRAFFIC ASSIGNMENT	11
SITE CIRCULATION	15
SUMMARY & CONCLUSIONS	16

LIST OF FIGURES

FIGURE 1 – Project Location Map	2
FIGURE 2 – Trip Distribution.....	12
FIGURE 3 – Driveway Traffic Assignment	14

LIST OF TABLES

TABLE 1 – Trip Generation Analysis (Currently Proposed Development Program).....	9
TABLE 2 – Trip Generation Analysis (Initially Proposed Development Program)	10

INTRODUCTION

The properties located at 2407-2409 N. Roosevelt Boulevard (State Road 5) in Key West, Monroe County, Florida currently contain a two-story mixed-use building (i.e. medical office, general office, and residential uses) and a single-story office building. Plans are underway to redevelop a portion of this site by repurposing the single-story office building, reallocating some of the space within the two-story mixed-use building, and introducing affordable housing by way of establishing liveaboard boat slips. The location of this project site is illustrated in Figure 1 on the following page.

KBP Consulting, Inc. has been retained by Trepanier & Associates, Inc. to prepare a traffic study in connection with the proposed redevelopment of this property. This study addresses the trip generation characteristics of the existing/approved and proposed development, the projected turning movement volumes at the project access driveways on N. Roosevelt Boulevard, site circulation and the vehicular access to N. Roosevelt Boulevard.

This traffic study is divided into five (5) sections, as listed below:

1. Inventory
2. Trip Generation
3. Trip Distribution and Traffic Assignment
4. Site Circulation
5. Summary & Conclusions



KBP
CONSULTING, INC.

Project Location Map

FIGURE 1
2407-2409 N. Roosevelt
Key West, Florida

INVENTORY

Existing/Approved Land Uses and Access

The subject site is comprised of two (2) parcels with a total land area of +/- 5.117 acres. The Parcel ID Numbers are 00002280-000100 and 00002280-000101. The existing development on the site consists of a two-story mixed-use building with two (2) apartment dwelling units, medical office space (4,185 square feet), and general office space (i.e. a 1,720 square foot massage parlor). There is also a 4,621 square foot single-story office building. And, the site has been approved (pursuant to Res. No. 14-316) for a marina with 74 berths that are currently under construction (pursuant to Permit No. 17-1560). Vehicular access is provided by one (1) full access driveway for each parcel both of which are located on N. Roosevelt Boulevard.

Proposed Land Uses and Access

Within the existing two-story mixed-use building, the medical office will remain as is and approximately 310 square feet of the general office space will be retained. The remaining general office area will be incorporated into the building's existing residential units (i.e. there will be no increase in the number of dwelling units within this building). The existing single-story building will be converted to accommodate bicycle lockers and storage areas for residents, showers and restrooms, and a dockmaster's office.

This project seeks to modify the existing/approved marina use to allow liveaboard vessels within the marina. The original request was to allow 74 liveaboard vessels. That proposal required a parking variance which was ultimately denied. Without a parking variance, the project must be reduced in order to comply with Key West's parking regulations. Until, or unless, the project obtains additional parking or parking variances, this project will contain 70 berths, 30 of which will be liveaboards.

Approximately 12 parking spaces will be provided on-site while an additional 20 parking spaces will be provided on the adjacent parcel to the southwest. Extensive parking will be provided on-site for both bicycles and scooters. Appendix A contains a preliminary site plan for the proposed redevelopment activity.

Transportation System

The primary roadway serving the subject study area is N. Roosevelt Boulevard (State Road 5). This facility is a state-maintained five-lane principal arterial roadway with two (2) northbound lanes, two (2) southbound lanes, and a center two-way left-turn lane. The posted speed limit in this area is 35 miles per hour (mph) and the FDOT's access management classification is "6-Non-Restrictive". The subject area is well-served by an existing designated shared bicycle lane along N. Roosevelt Boulevard and pedestrian sidewalks / crosswalks.

Transit Service

The subject site is served by Key West Transit. The Blue, Green, and Red routes along with the Lower Keys Shuttle provide service along N. Roosevelt Boulevard. The northbound bus stop is located immediately across N. Roosevelt Boulevard near the northern boundary of the subject site. The southbound bus stop is located approximately 140 feet to the south of the project driveway and across from the Taco Bell.

Alternative Modes of Transportation

The City of Key West has made a real investment in its plan to be a vibrant bicycling and pedestrian friendly community. Since adopting its first bicycle and pedestrian plan in 1996, Key West has been committed for over two decades to establish bicycles as a major mode of transportation for visitors and residents (as well as to integrate bicycle use with other modes of transportation). As such, the City recently completed the Key West Bicycle and Pedestrian Master Plan which highlights multi-modal mobility options that support the quality of life and economic vitality for residents, businesses, and visitors. This plan considers findings and recommendations from numerous other plans and initiatives:

- Key West Climate Action Plan 2009 promotes bicycling and walking for transportation. Given the island's sensitive environmental conditions, this plan recognizes that transportation is a main contributor to greenhouse gasses (not to mention major household expenses).

-
- 2013 Key West Comprehensive Plan considers bicyclists and pedestrians along with motor vehicles and transit in development and land use regulations. Specifically, Policy 2-1.1.3 recognizes that the City’s development characteristics make expansion of capacity of the roadway system prohibitive, so multi-modal transportation improvements (i.e. transit, air, boat, bicycles, pedestrianism, mixed-use development) are prioritized as its primary strategies for addressing current and projected transportation needs (as well as to reduce parking demand and alleviate congestion particularly in Old Town).
 - The Monroe County 2030 Comprehensive Plan includes several policies that support a robust multi-modal transportation system, focusing on changes to the current development code including Policy 1503.1.3 which seeks to update the Land Development Code to increase bicycle and pedestrian-friendly development with more transportation options and increase the construction of energy efficient and climate resilient structures.
 - Key West Transit Development Plan Update (2015-2024) promotes multi-modal trip chaining and combines walking, biking and transit to expand the range people can travel without a personal vehicle.
 - Bike Florida Grant provides funding to hire a marketing firm to develop branding, make maps and brochures, and engage the community.
 - South Florida Commuter Services (SFCS) supports initiatives that promote bike-walk-transit options and commuter benefits program to large employers in the area. For example, SFCS worked with Key West’s Bike/Ped Coordinator to launch the “Car-Free Key West” campaign – the umbrella brand that all alternative transportation options fall under, whether they be bicycle, pedestrian, transit, carpooling and ride-sharing. The SFCS was also a prime player in the design of the Duval Loop brand.

Phase I of the Key West Bicycle and Pedestrian Master Plan included broad public engagement activities, and most respondents felt that walking and biking served their mobility needs. Many residents and visitors already ride bicycles in the city, both for recreation and transportation.

In fact, Key West and Stock Island are an ideal size for biking and walking, and this is reflected in the high percentage of residents that commute to work on foot or by bicycle – a combined 22 percent in 2016. Key West is clearly committed to shift some people from cars to other modes of transportation and recognizes that an effective multimodal transportation system provides a balance of facilities for all modes.

The city commission appointed the Parking and Alternative Transportation Group to formulate recommendations to alleviate congestion, encourage public transportation, reduce reliance on personal vehicle use and improve parking availability. The city commission has already acted on many of the suggestions which includes a continued emphasis on alternative transportation. For example, applicable project improvements in the immediate vicinity of the proposed redevelopment project include a series of Connectors and Loops that form the core of the recommended bike network and work together to connect popular destinations and facilitate comfortable, safe and efficient travel by bicycle:

- Sunrise Loop Intersection and Trail Improvements enhance infrastructure around 1st Street, 5th Street, 7th Street, and Gulfview Drive and N. Roosevelt Blvd. intersections.
- Island Loop Intersection and Trail Improvements enhance infrastructure around Eisenhower Drive and Palm Avenue corridor into Old Town. (A majority of critical intersections on the Island Loop are also part of the Sunrise Loop.)
- Smathers Beach Connector enhances infrastructure around 7th Street.
- Bicycle Lanes on Cow Key Bridge were recently improved by the Florida Department of Transportation (FDOT) through consultation with the City.

The City of Key West has prioritized alternative methods of transportation and continues to invest in many important assets key to building, operating and encouraging strong bicycle and walking mode shares for daily transportation and recreation.

TRIP GENERATION

A trip generation analysis has been conducted for the existing/approved and proposed development on the site. The analysis was performed using the trip generation rates and equations published in the Institute of Transportation Engineer's (ITE) *Trip Generation Manual (10th Edition)*. The trip generation analysis was undertaken for the daily, AM peak hour, and PM peak hour conditions. According to the ITE report, the most appropriate "land use" categories for the existing/approved and proposed development are as follows:

Medical-Dental Office Building – ITE Land Use #720

- Weekday: $T = 38.42 (X) - 87.62$
where T = number of trips and X = gross floor area
- AM Peak Hour: $\ln(T) = 0.89 \ln(X) + 1.31$ (78% in / 22% out)
- PM Peak Hour: $T = 3.39 (X) + 2.02$ (28% in / 72% out)

Small Office Building – ITE Land Use #712

- Weekday: $T = 16.19 (X)$
where T = number of trips and X = gross floor area
- AM Peak Hour: $T = 1.92 (X)$ (83% in / 17% out)
- PM Peak Hour: $T = 2.45 (X)$ (32% in / 68% out)

Multifamily Housing (Low-Rise) – ITE Land Use #220

- Weekday: $T = 7.32 (X)$
where T = number of trips and X = number of dwelling units
- AM Peak Hour: $T = 0.46 (X)$ (23% in / 77% out)
- PM Peak Hour: $T = 0.56 (X)$ (63% in / 37% out)

Multifamily Housing (Liveboards) – ITE Land Use #220

- Daily: $T = 7.56 (X) - 40.86$
where T = number of trips and X = number of dwelling units
- AM Peak Hour: $\ln(T) = 0.95 \ln(X) - 0.51$ (23% in / 77% out)
- PM Peak Hour: $\ln(T) = 0.89 \ln(X) - 0.02$ (63% in / 37% out)

Marina – ITE Land Use #420

- Weekday: $T = 2.41 (X)$
where T = number of trips and X = number of berths
- AM Peak Hour: $T = 0.07 (X)$ (33% in / 67% out)
- PM Peak Hour: $T = 0.21 (X)$ (60% in / 40% out)

As noted previously, automobile parking on-site (and adjacent to the site) will be limited. On the other hand, every boat slip will have the ability to park bicycles and scooters on site. As a result of this site characteristic, it is evident that the traditional automobile trip generation of the site will be significantly reduced. Additionally, it is noted that the area is well served by Key West Transit (i.e. the Blue, Green, and Red routes along with the Lower Keys Shuttle), wide accessible sidewalks, and a designated bicycle facility along N. Roosevelt Boulevard. Given these characteristics and the urbanized location of this site, it is estimated that the number of vehicle trips will be at least 30% less than a traditional multifamily housing site. Therefore, a 30% trip reduction has been factored in the trip generation analysis for this site.

Utilizing the previously listed trip generation rates and equations from the referenced ITE document along with the appropriate trip reduction factor for the liveaboard component of this site, a trip generation analysis was undertaken for the existing/approved and proposed development. The results of this effort are documented in Table 1 on the following page and excerpts from the referenced ITE manual are presented in Appendix B.

Land Use	Size	Daily Trips	AM Peak Hour Trips			PM Peak Hour Trips		
			In	Out	Total	In	Out	Total
Existing/Approved Land Uses								
Medical Office	4,185 SF	73	10	3	13	4	12	16
Small Office Building	4,621 SF	75	7	2	9	4	7	11
Small Office Building (Massage Parlor)	1,720 SF	28	2	1	3	1	3	4
Multifamily Housing (Low-Rise)	2 DU	15	0	1	1	1	0	1
Marina	74 Berths	178	2	3	5	10	6	16
Total		369	21	10	31	20	28	48
Proposed Land Uses								
Medical Office	4,185 SF	73	10	3	13	4	12	16
Small Office Building	310 SF	5	1	0	1	0	1	1
Multifamily Housing (Low-Rise)	2 DU	15	0	1	1	1	0	1
Marina	40 Berths	96	1	2	3	5	3	8
Multifamily Housing (Liveaboards)	30 DU	186	3	12	15	13	7	20
- Alternative Mode Reduction for the Proposed Liveaboards (-30%)		(56)	(1)	(4)	(5)	(4)	(2)	(6)
Total		319	14	14	28	19	21	40
Difference (Proposed - Existing)		(50)	(7)	4	(3)	(1)	(7)	(8)

Compiled by: KBP Consulting, Inc. (May 2019).

Source: ITE Trip Generation Manual (10th Edition).

As indicated in Table 1 above, the number of vehicle trips expected to be generated by the proposed development program consists of 319 daily vehicle trips, 28 vehicle trips in the AM peak hour (14 inbound and 14 outbound), and 40 vehicle trips in the PM peak hour (19 inbound and 21 outbound). When considering the existing/approved development on this site, this represents a decrease of 50 daily vehicle trips, a decrease of three (3) vehicle trips during the AM peak hour, and a decrease of eight (8) vehicle trips during the PM peak hour.

As a basis of comparison, a trip generation analysis has also been prepared for the initially proposed development program (i.e. 74 liveboard vessels). The results of this analysis are presented in Table 2 on the following page. This development program would produce a minimal increase in daily, AM and PM peak hour traffic.

Table 2								
Trip Generation Analysis (Initially Proposed Development Program)								
2407-2409 N. Roosevelt Boulevard - Key West, Florida								
Land Use	Size	Daily Trips	AM Peak Hour Trips			PM Peak Hour Trips		
			In	Out	Total	In	Out	Total
<i>Existing-Approved Land Uses</i>								
Medical Office	4,185 SF	73	10	3	13	4	12	16
Small Office Building	4,621 SF	75	7	2	9	4	7	11
Small Office Building (Massage Parlor)	1,720 SF	28	2	1	3	1	3	4
Multifamily Housing (Low-Rise)	2 DU	15	0	1	1	1	0	1
Marina	74 Berths	178	2	3	5	10	6	16
Total		369	21	10	31	20	28	48
<i>Proposed Land Uses</i>								
Medical Office	4,185 SF	73	10	3	13	4	12	16
Small Office Building	310 SF	5	1	0	1	0	1	1
Multifamily Housing (Low-Rise)	2 DU	15	0	1	1	1	0	1
Multifamily Housing (Liveboards)	74 DU	519	8	28	36	28	17	45
- Alternative Mode Reduction for the Proposed Liveboards (-30%)		(156)	(2)	(9)	(11)	(8)	(6)	(14)
Total		456	17	23	40	25	24	49
Difference (Proposed - Existing)		87	(4)	13	9	5	(4)	1

Compiled by: KBP Consulting, Inc. (May 2019).

Source: ITE Trip Generation Manual (10th Edition).

TRIP DISTRIBUTION AND TRAFFIC ASSIGNMENT

The trip distribution and traffic assignment for the subject site located at 2407-2409 N. Roosevelt Boulevard was developed based upon knowledge of the study area, examination of the surrounding roadway network characteristics, review of current traffic volumes, and existing land use patterns. Figure 2 on the following page depicts the anticipated trip distribution for this project.



KBP
CONSULTING, INC.

Trip Distribution

FIGURE 2
2407-2409 N. Roosevelt
Key West, Florida

The AM peak hour and PM peak hour traffic to be generated by the proposed development program at 2407-2409 N. Roosevelt Boulevard was assigned to the site's project driveway on N. Roosevelt Boulevard as well as the driveway immediately to the southwest that will provide access to the additional parking spaces to be created on the adjacent parcel.

Based upon a site review of the existing access point to the subject parcel, it is evident that left-turns out onto N. Roosevelt Boulevard can be difficult and potentially unsafe. There is an existing mid-block pedestrian crosswalk immediately to the northeast that has raised medians on either side. The presence of these raised medians limits the ability of motorists to perform two-stage left-turn maneuvers to travel north on N. Roosevelt Boulevard. For this reason, it is recommended that egress movements from the project driveway be limited to right-turns only.

For those motorists wishing to travel north on N. Roosevelt Boulevard and generally in the northeasterly direction, a U-turn maneuver in the immediate area would only be practical for the smallest of vehicles. As such, it is anticipated that most motorists will travel in a westerly direction to the next signalized intersection at 5th Street. At this point, motorists could continue to Flagler Avenue or utilize the area's grid network to re-route to N. Roosevelt Boulevard.

The driveway traffic assignment is summarized in Figure 3 on the following page. As indicated in Figure 3, the projected driveway volumes will be minimal during both of the peak periods of the day.



KBP
 CONSULTING, INC.

Driveway Traffic Assignment

FIGURE 3
 2407-2409 N. Roosevelt
 Key West, Florida

SITE CIRCULATION

This property was designed with a large "T" turn-around area immediately adjacent to the entrance for the marina docks. This area has been reviewed and approved by the City of Key West Fire Department as it relates to fire truck maneuverability. The turnaround is located so that the area can be used for maneuverability purposes including service vehicles and private vehicles. The area can also support non-parking activities such as pick-up and drop-off for taxis and rideshares. The trash containers will be located immediately adjacent to the subject turn around area in order to allow the utilization of this area for maneuverability of garbage trucks. AutoTurn analyses have been performed for the fire truck, garbage truck, and delivery truck design vehicles. The results are presented in Appendix C of this report.

SUMMARY & CONCLUSIONS

The properties located at 2407-2409 N. Roosevelt Boulevard in Key West, Monroe County, Florida currently contain a two-story mixed-use building (i.e. medical office, general office, and residential uses) and a single-story general office building. Plans are underway to redevelop a portion of this site by repurposing the single-story office building, reallocating some of the space within the two-story mixed-use building, and introducing affordable housing by way of establishing liveboard boat slips.

The existing/approved development on the site consists of a two-story mixed-use building with two (2) residential apartment dwelling units, medical office space (4,185 square feet), and general office space (i.e. a 1,720 square foot massage parlor). There is also a 4,621 square foot single-story general office building. Within the existing two-story mixed-use building, the medical office will remain as is and approximately 310 square feet of the general office space will be retained and the number of apartment dwelling units will remain the same. The existing single-story building will be converted to accommodate bicycle lockers and storage areas for residents, showers and restrooms, and a dockmaster's office.

This project seeks to modify the existing/approved marina use to allow liveboard vessels within the marina. The original request was to allow 74 liveboard vessels. That proposal required a parking variance which was ultimately denied. Without a parking variance, the project must be reduced in order to comply with Key West's parking regulations. Until, or unless, the project obtains additional parking or parking variances, this project will contain 70 berths, 30 of which will be liveboards.

Based upon the location of the site and the operational characteristics of the community, it is anticipated that many of the residents will choose alternative modes of transportation (i.e. walking, bicycling, and using Key West Transit which offers service immediately adjacent to the site) thereby significantly reducing the traffic impacts of the liveboard vessels.

As indicated in the trip generation analysis, the number of vehicle trips expected to be generated by the proposed development program consists of 319 daily vehicle trips, 28 vehicle trips in the AM peak hour (14 inbound and 14 outbound), and 40 vehicle trips in the PM peak hour (19 inbound and 21 outbound). When considering the existing/approved development on this site, this represents a decrease of 50 daily vehicle trips, a decrease of three (3) vehicle trips during the AM peak hour, and a decrease of eight (8) vehicle trips during the PM peak hour.

APPENDIX A

2407-2409 N. Roosevelt Boulevard

Preliminary Site Plan

Site Data	Required/ Allowed	Existing	Proposed	Compliance
Zoning	Conservation	Conservation	No Change	Complies
Site Size	10 ac	5.12 ac (222,918 sq. ft.)	No Change	Complies
Upland Area	NA	0.69 ac (30,149 sq. ft.)	No Change	Complies
Density	0.5 units	3.0 units	No Change	Complies
Pleasure slips	74	40	No Change	Complies
Live-aboard Slips	NA	0	30	Conditional Use
FAR	0.04	0.04	No Change	Complies
Max Height	25 ft.	~ 30 ft.	No Change	Complies
Open Space:	20%	92%	No Change	Complies
Landscape: Total Area	20%	29%	No Change	Complies
Buffer	30 ft.	30 ft.	No Change	Complies
Max Building Coverage	5%	3%	No Change	Complies
Impervious Surface	5%	9%	No Change	Complies
Setback (Shoreline)	30ft from M-W 50ft from Class III waters	0 ft from M-W 0 ft from Class III waters	No Change	Complies
Parking: Auto	32	32	32	Complies
Bike	18	18	84	Complies

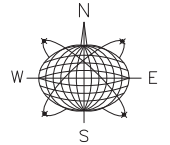
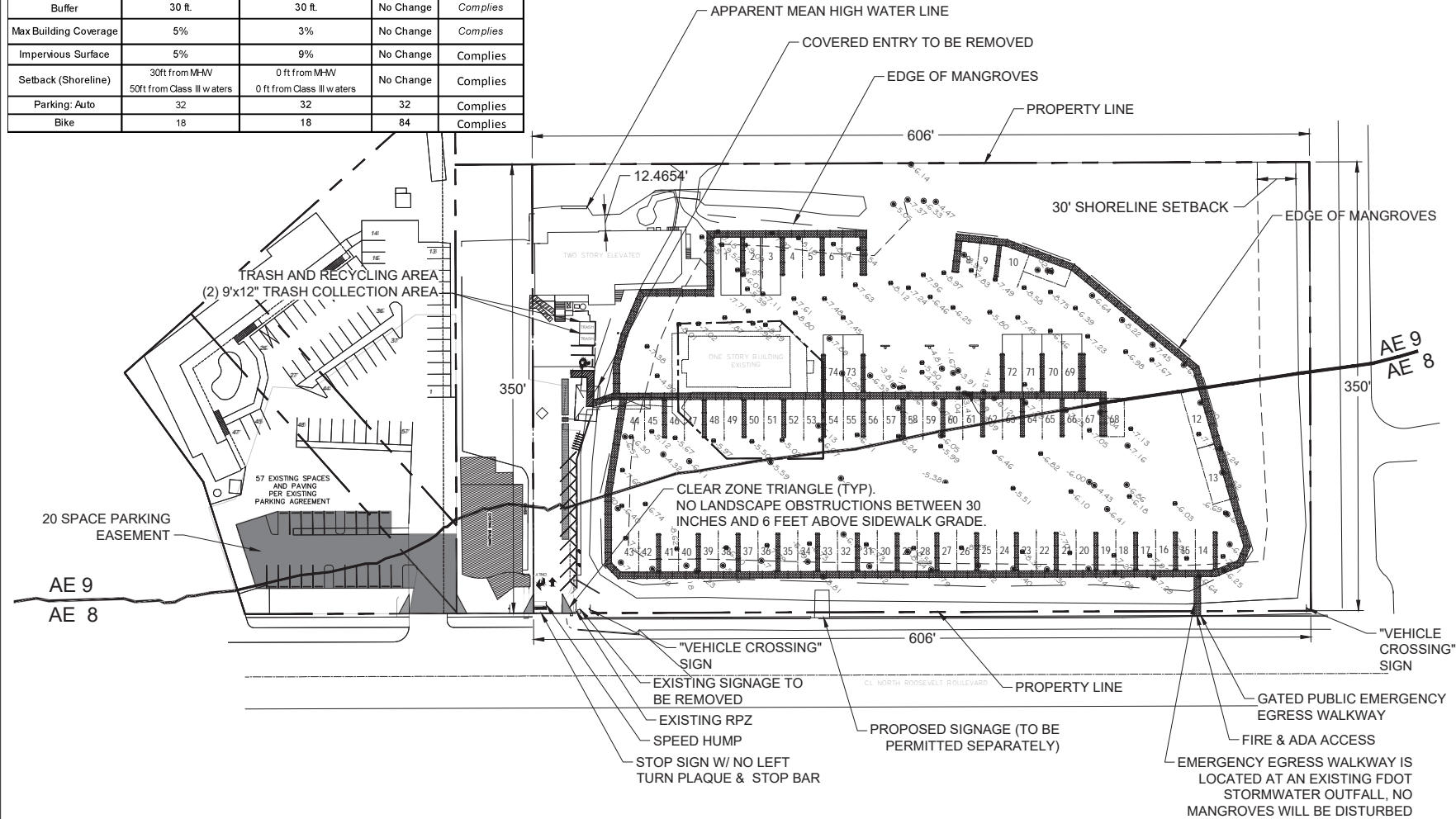

Meridian Engineering LLC
 201 Front Street, Suite 203
 Key West, Florida 33040
 AUTHORIZATION #29401
 ph:305-293-3263 fax:293-4899

Seal:

NOT VALID FOR CONSTRUCTION UNLESS
 SIGNED AND SEALED IN THIS BLOCK
 RICHARD J. MILELLI
 PE #58315

2407-2409 N. ROOSEVELT BLVD

KEY WEST, FLORIDA

Drawn By: ANF
 Checked By: RJM

Revisions:

Title:
**PROPOSED
 SITE
 PLAN**

Sheet Number:
C-1.0

Date: MARCH 12, 2018

APPENDIX B
ITE Trip Generation Data

Land Use: 720

Medical-Dental Office Building

Description

A medical-dental office building is a facility that provides diagnoses and outpatient care on a routine basis but is unable to provide prolonged in-house medical and surgical care. One or more private physicians or dentists generally operate this type of facility. Clinic (Land Use 630) is a related use.

Additional Data

Time-of-day distribution data for this land use for a weekday, Saturday, and Sunday are presented in Appendix A. For the 19 general urban/suburban sites with data, the overall highest vehicle volumes during the AM and PM on a weekday were counted between 9:30 and 10:30 a.m. and 2:15 and 3:15 p.m., respectively.

The sites were surveyed in the 1980s, the 1990s, the 2000s, and the 2010s in Alberta (CAN), California, Connecticut, Kentucky, Maryland, Minnesota, New Jersey, New York, Ohio, Oregon, Pennsylvania, South Dakota, Texas, Virginia, Washington, and Wisconsin.

Source Numbers

104, 109, 120, 157, 184, 209, 211, 253, 287, 294, 295, 304, 357, 384, 404, 407, 423, 444, 509, 601, 715, 867, 879, 901, 902, 908, 959, 972

Medical-Dental Office Building (720)

Vehicle Trip Ends vs: 1000 Sq. Ft. GFA
On a: Weekday

Setting/Location: General Urban/Suburban
 Number of Studies: 28
 1000 Sq. Ft. GFA: 24
 Directional Distribution: 50% entering, 50% exiting

Vehicle Trip Generation per 1000 Sq. Ft. GFA

Average Rate	Range of Rates	Standard Deviation
34.80	9.14 - 100.75	9.79

Data Plot and Equation

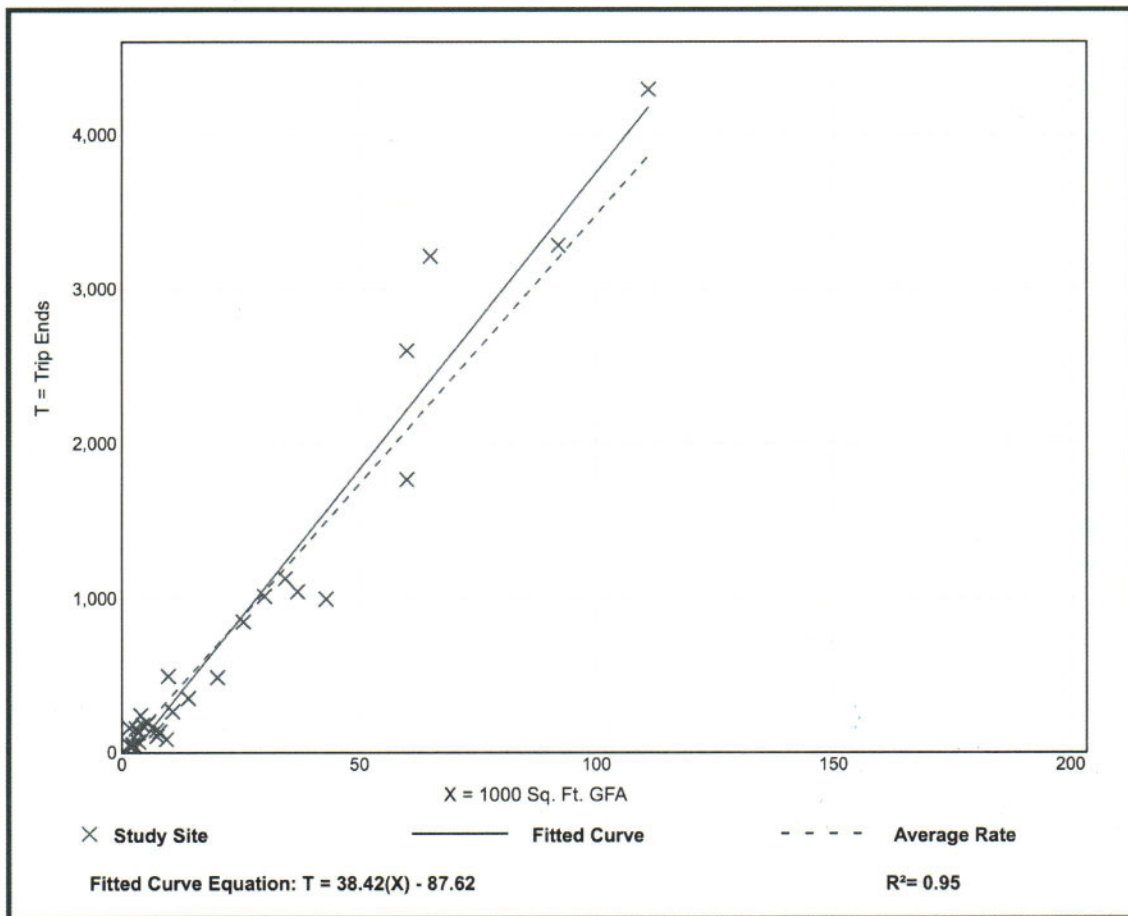

Medical-Dental Office Building (720)

Vehicle Trip Ends vs: 1000 Sq. Ft. GFA
On a: Weekday,
Peak Hour of Adjacent Street Traffic,
One Hour Between 7 and 9 a.m.
Setting/Location: General Urban/Suburban
 Number of Studies: 44
 1000 Sq. Ft. GFA: 32
 Directional Distribution: 78% entering, 22% exiting

Vehicle Trip Generation per 1000 Sq. Ft. GFA

Average Rate	Range of Rates	Standard Deviation
2.78	0.85 - 14.30	1.28

Data Plot and Equation

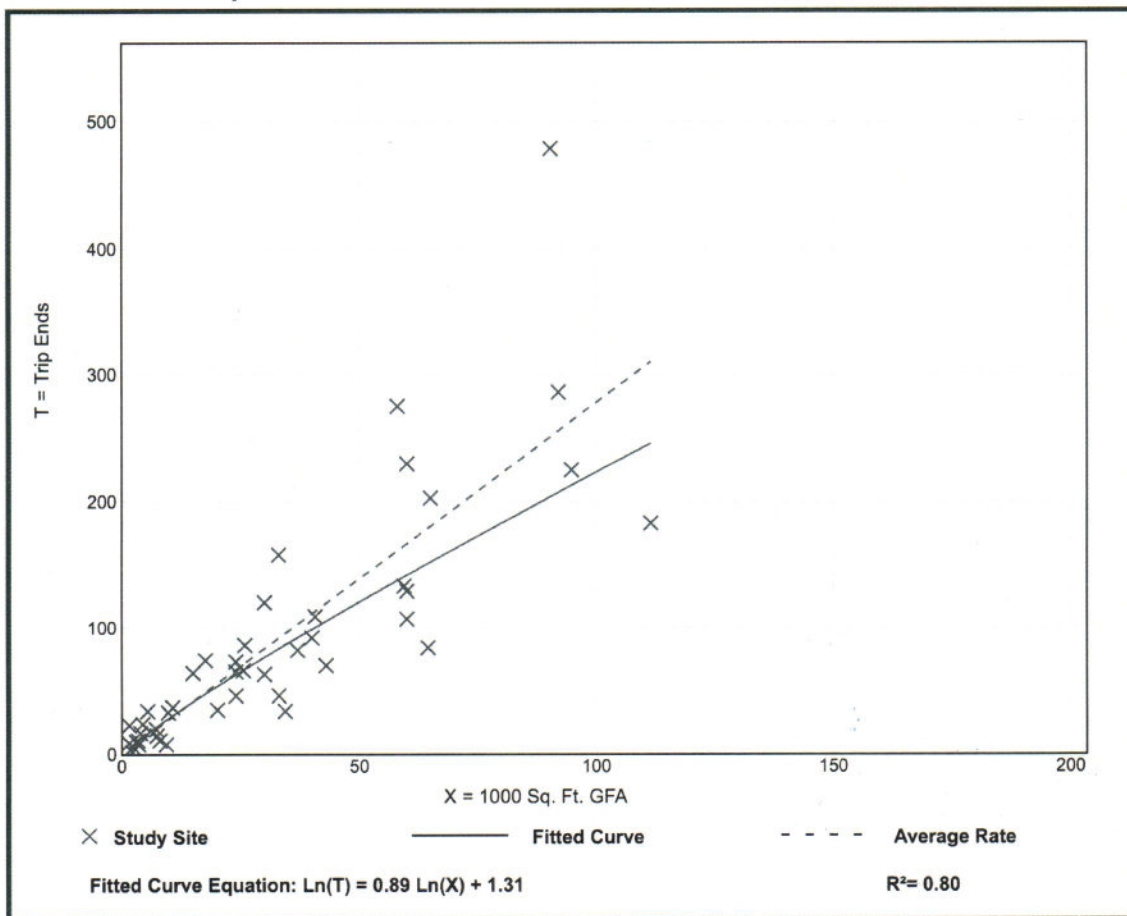

Medical-Dental Office Building (720)

Vehicle Trip Ends vs: 1000 Sq. Ft. GFA
On a: Weekday,
Peak Hour of Adjacent Street Traffic,
One Hour Between 4 and 6 p.m.
Setting/Location: General Urban/Suburban
 Number of Studies: 65
 1000 Sq. Ft. GFA: 28
 Directional Distribution: 28% entering, 72% exiting

Vehicle Trip Generation per 1000 Sq. Ft. GFA

Average Rate	Range of Rates	Standard Deviation
3.46	0.25 - 8.86	1.58

Data Plot and Equation

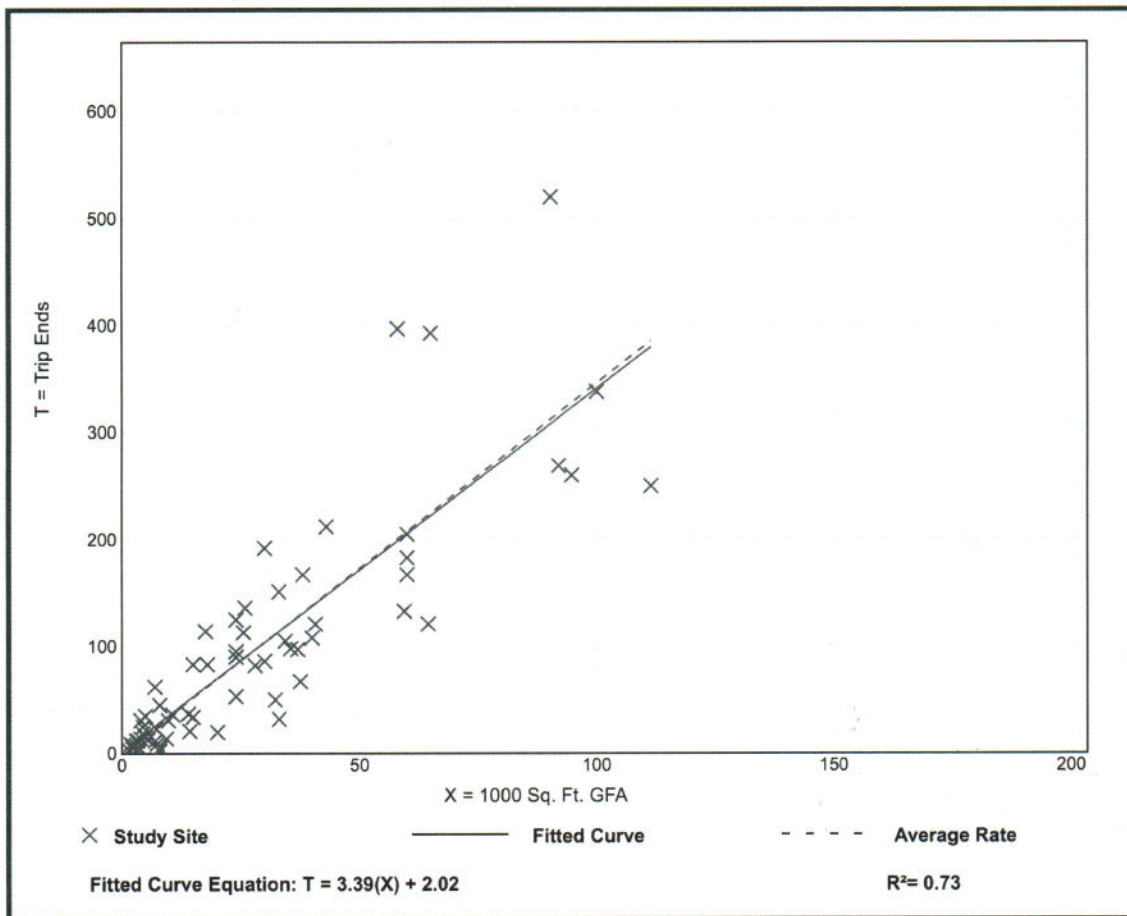

Land Use: 712 Small Office Building

Description

A small office building houses a single tenant and is less than or equal to 5,000 gross square feet in size. It is a location where affairs of a business, commercial or industrial organization, or professional person or firm are conducted. General office building (Land Use 710) is a related use.

Additional Data

Time-of-day distribution data for this land use are presented in Appendix A. For the 18 general urban/suburban sites with data, the overall highest vehicle volumes during the AM and PM on a weekday were counted between 11:30 a.m. and 12:30 p.m. and 5:00 and 6:00 p.m., respectively.

The sites were surveyed in the 1980s and the 2010s in Alberta (CAN), Texas, and Wisconsin.

Source Numbers

890, 891, 959, 976

Small Office Building (712)

Vehicle Trip Ends vs: 1000 Sq. Ft. GFA
On a: **Weekday**

Setting/Location: General Urban/Suburban
Number of Studies: 17
1000 Sq. Ft. GFA: 2
Directional Distribution: 50% entering, 50% exiting

Vehicle Trip Generation per 1000 Sq. Ft. GFA

Average Rate	Range of Rates	Standard Deviation
16.19	4.44 - 50.91	11.03

Data Plot and Equation

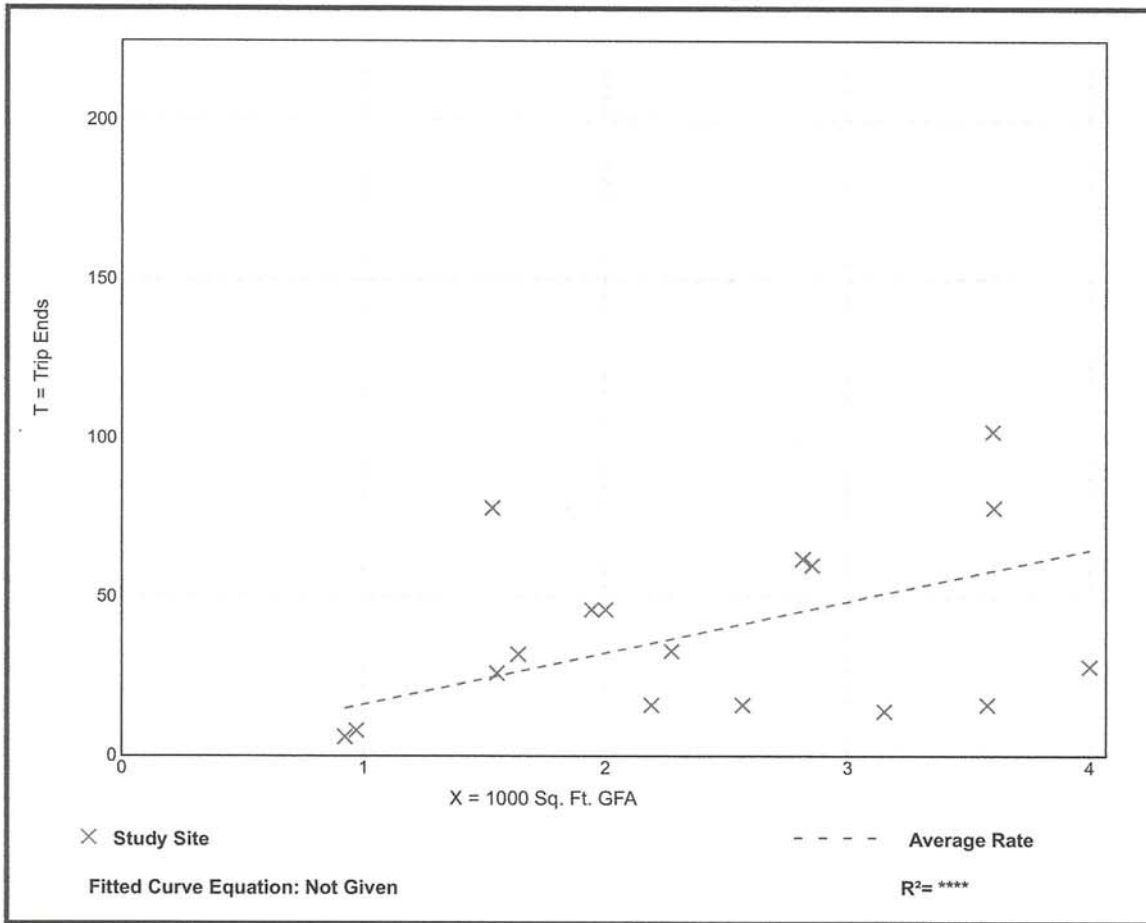

Small Office Building (712)

Vehicle Trip Ends vs: 1000 Sq. Ft. GFA
On a: Weekday,
 Peak Hour of Adjacent Street Traffic,
 One Hour Between 7 and 9 a.m.
Setting/Location: General Urban/Suburban
 Number of Studies: 17
 1000 Sq. Ft. GFA: 2
 Directional Distribution: 83% entering, 18% exiting

Vehicle Trip Generation per 1000 Sq. Ft. GFA

Average Rate	Range of Rates	Standard Deviation
1.92	0.78 - 4.12	0.97

Data Plot and Equation

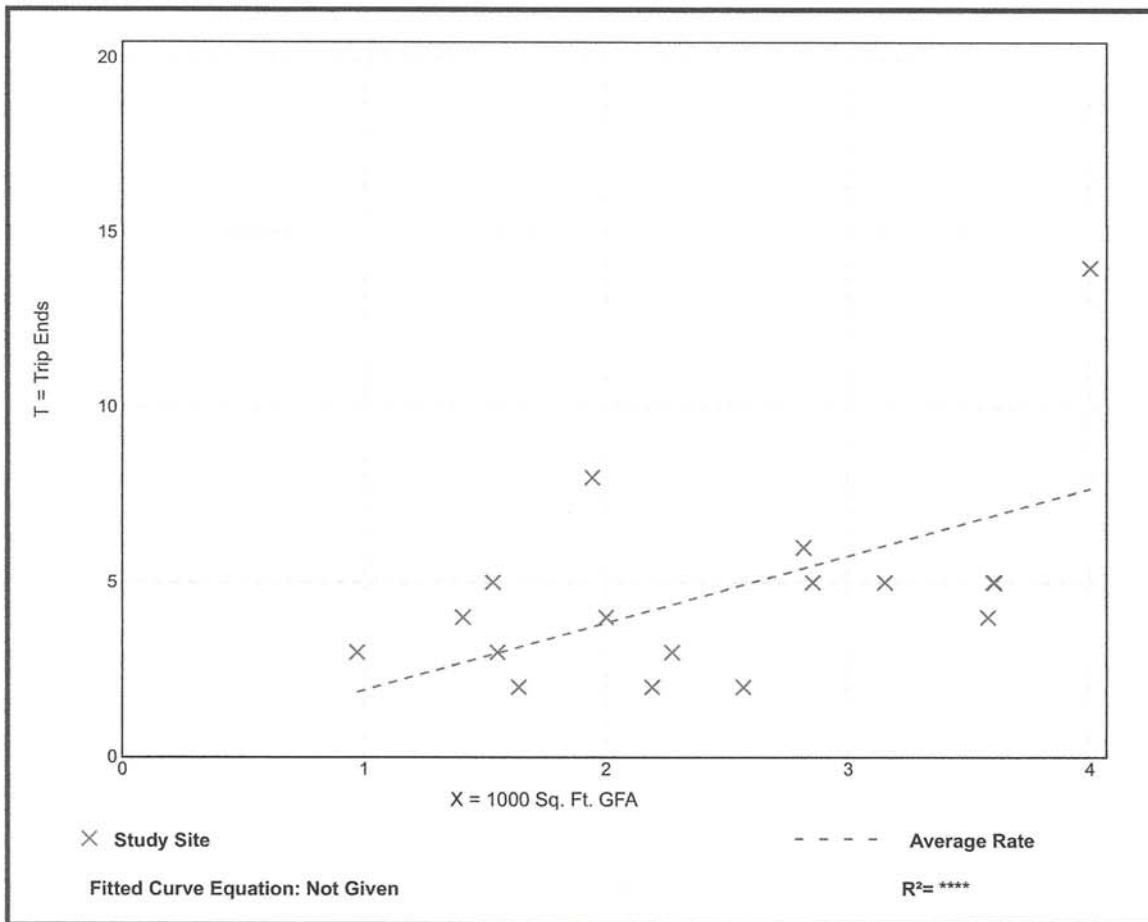

Small Office Building (712)

Vehicle Trip Ends vs: 1000 Sq. Ft. GFA
On a: Weekday,
Peak Hour of Adjacent Street Traffic,
One Hour Between 4 and 6 p.m.
Setting/Location: General Urban/Suburban
 Number of Studies: 17
 1000 Sq. Ft. GFA: 3
 Directional Distribution: 32% entering, 68% exiting

Vehicle Trip Generation per 1000 Sq. Ft. GFA

Average Rate	Range of Rates	Standard Deviation
2.45	0.56 - 5.50	1.38

Data Plot and Equation

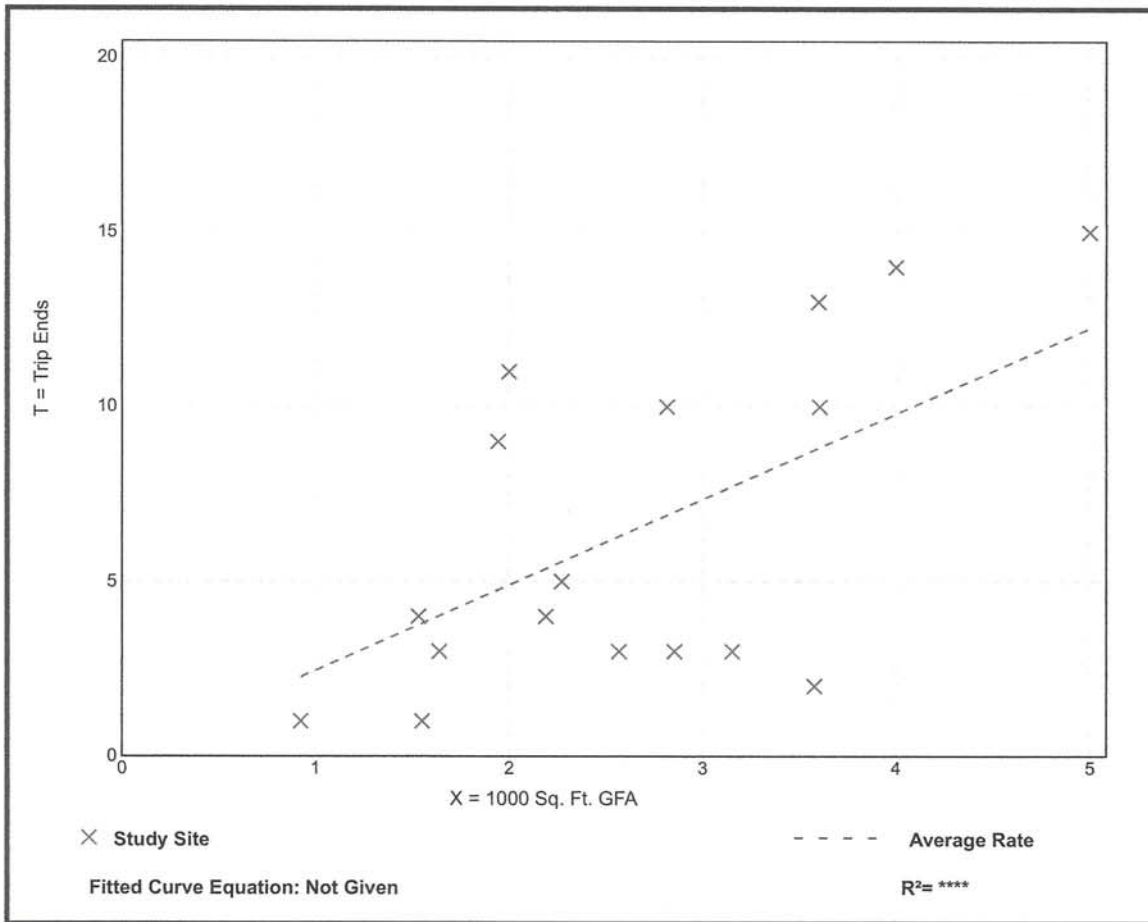

Land Use: 220

Multifamily Housing (Low-Rise)

Description

Low-rise multifamily housing includes apartments, townhouses, and condominiums located within the same building with at least three other dwelling units and that have one or two levels (floors). Multifamily housing (mid-rise) (Land Use 221), multifamily housing (high-rise) (Land Use 222), and off-campus student apartment (Land Use 225) are related land uses.

Additional Data

In prior editions of *Trip Generation Manual*, the low-rise multifamily housing sites were further divided into rental and condominium categories. An investigation of vehicle trip data found no clear differences in trip making patterns between the rental and condominium sites within the ITE database. As more data are compiled for future editions, this land use classification can be reinvestigated.

For the three sites for which both the number of residents and the number of occupied dwelling units were available, there were an average of 2.72 residents per occupied dwelling unit.

For the two sites for which the numbers of both total dwelling units and occupied dwelling units were available, an average of 96.2 percent of the total dwelling units were occupied.

This land use included data from a wide variety of units with different sizes, price ranges, locations, and ages. Consequently, there was a wide variation in trips generated within this category. Other factors, such as geographic location and type of adjacent and nearby development, may also have had an effect on the site trip generation.

Time-of-day distribution data for this land use are presented in Appendix A. For the 10 general urban/suburban sites with data, the overall highest vehicle volumes during the AM and PM on a weekday were counted between 7:15 and 8:15 a.m. and 4:45 and 5:45 p.m., respectively. For the one site with Saturday data, the overall highest vehicle volume was counted between 9:45 and 10:45 a.m. For the one site with Sunday data, the overall highest vehicle volume was counted between 11:45 a.m. and 12:45 p.m.

For the one dense multi-use urban site with 24-hour count data, the overall highest vehicle volumes during the AM and PM on a weekday were counted between 7:00 and 8:00 a.m. and 6:15 and 7:15 p.m., respectively.

For the three sites for which data were provided for both occupied dwelling units and residents, there was an average of 2.72 residents per occupied dwelling unit.

The average numbers of person trips per vehicle trip at the five general urban/suburban sites at which both person trip and vehicle trip data were collected were as follows:

- 1.13 during Weekday, Peak Hour of Adjacent Street Traffic, one hour between 7 and 9 a.m.
- 1.21 during Weekday, Peak Hour of Adjacent Street Traffic, one hour between 4 and 6 p.m.

The sites were surveyed in the 1980s, the 1990s, the 2000s, and the 2010s in British Columbia (CAN), California, District of Columbia, Florida, Georgia, Illinois, Indiana, Maine, Maryland, Minnesota, New Jersey, New York, Ontario, Oregon, Pennsylvania, South Dakota, Tennessee, Texas, Utah, Virginia, and Washington.

It is expected that the number of bedrooms and number of residents are likely correlated to the number of trips generated by a residential site. Many of the studies included in this land use did not indicate the total number of bedrooms. To assist in the future analysis of this land use, it is important that this information be collected and included in trip generation data submissions.

Source Numbers

168, 187, 188, 204, 211, 300, 305, 306, 319, 320, 321, 357, 390, 412, 418, 525, 530, 571, 579, 583, 864, 868, 869, 870, 896, 903, 918, 946, 947, 948, 951

Multifamily Housing (Low-Rise) (220)

Vehicle Trip Ends vs: Dwelling Units
On a: Weekday

Setting/Location: General Urban/Suburban
Number of Studies: 29
Avg. Num. of Dwelling Units: 168
Directional Distribution: 50% entering, 50% exiting

Vehicle Trip Generation per Dwelling Unit

Average Rate	Range of Rates	Standard Deviation
7.32	4.45 - 10.97	1.31

Data Plot and Equation

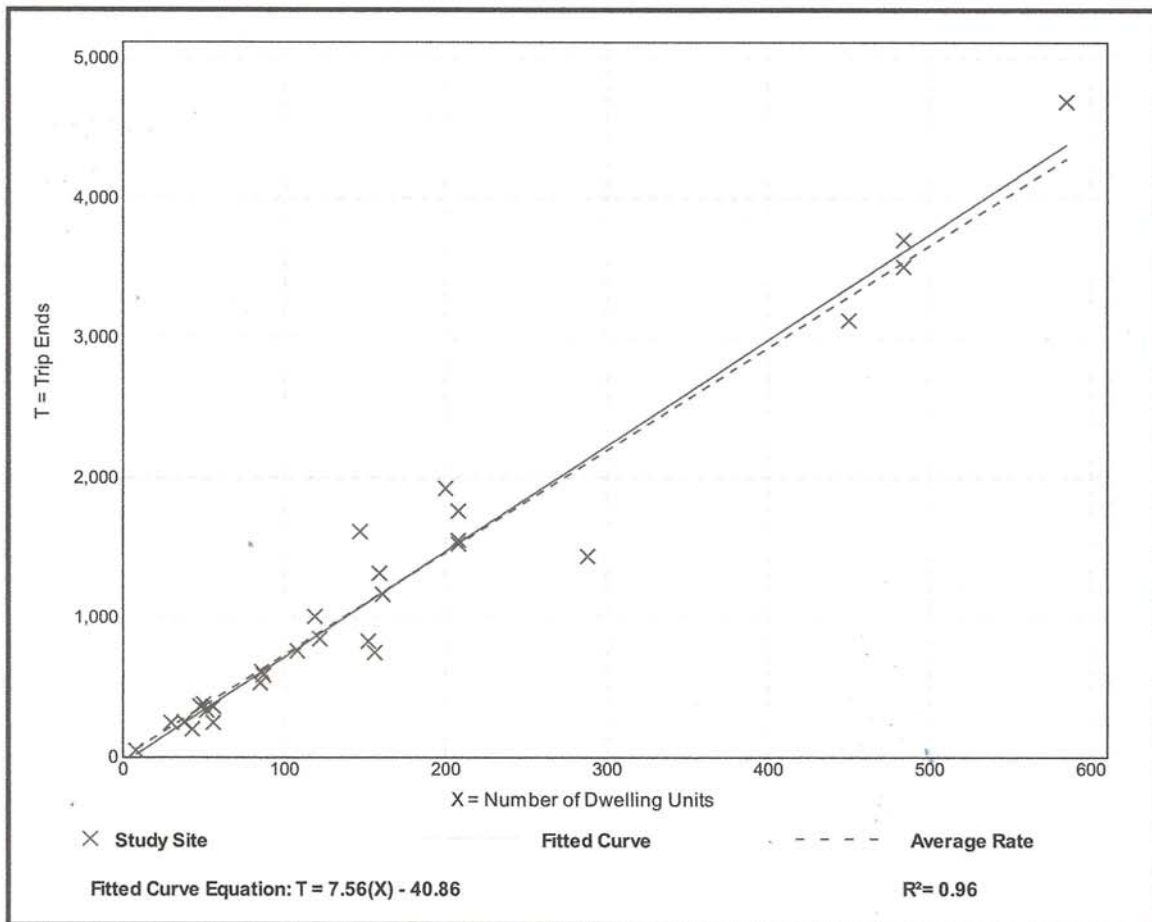

Multifamily Housing (Low-Rise) (220)

Vehicle Trip Ends vs: Dwelling Units
On a: Weekday,
Peak Hour of Adjacent Street Traffic,
One Hour Between 7 and 9 a.m.

Setting/Location: General Urban/Suburban
 Number of Studies: 42
 Avg. Num. of Dwelling Units: 199
 Directional Distribution: 23% entering, 77% exiting

Vehicle Trip Generation per Dwelling Unit

Average Rate	Range of Rates	Standard Deviation
0.46	0.18 - 0.74	0.12

Data Plot and Equation

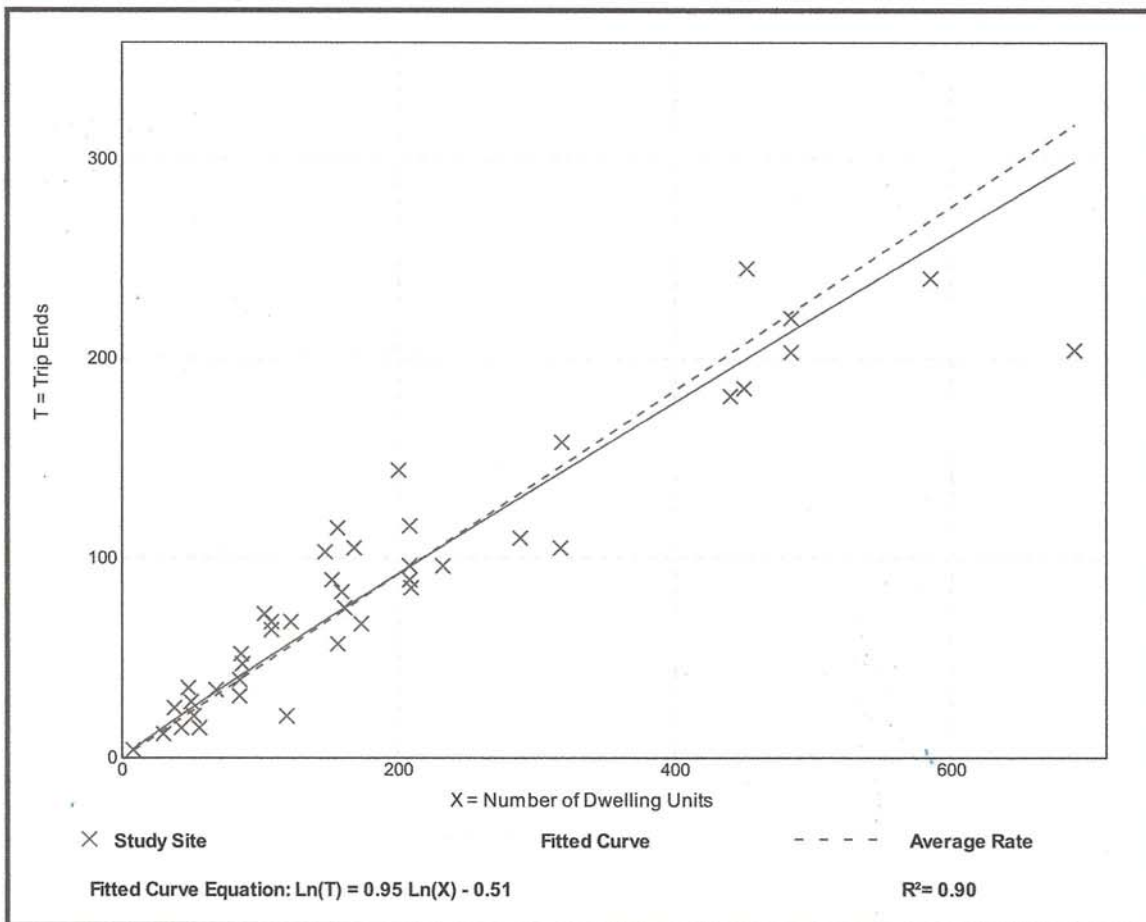

Multifamily Housing (Low-Rise) (220)

Vehicle Trip Ends vs: Dwelling Units
On a: Weekday,
Peak Hour of Adjacent Street Traffic,
One Hour Between 4 and 6 p.m.

Setting/Location: General Urban/Suburban
 Number of Studies: 50
 Avg. Num. of Dwelling Units: 187
 Directional Distribution: 63% entering, 37% exiting

Vehicle Trip Generation per Dwelling Unit

Average Rate	Range of Rates	Standard Deviation
0.56	0.18 - 1.25	0.16

Data Plot and Equation

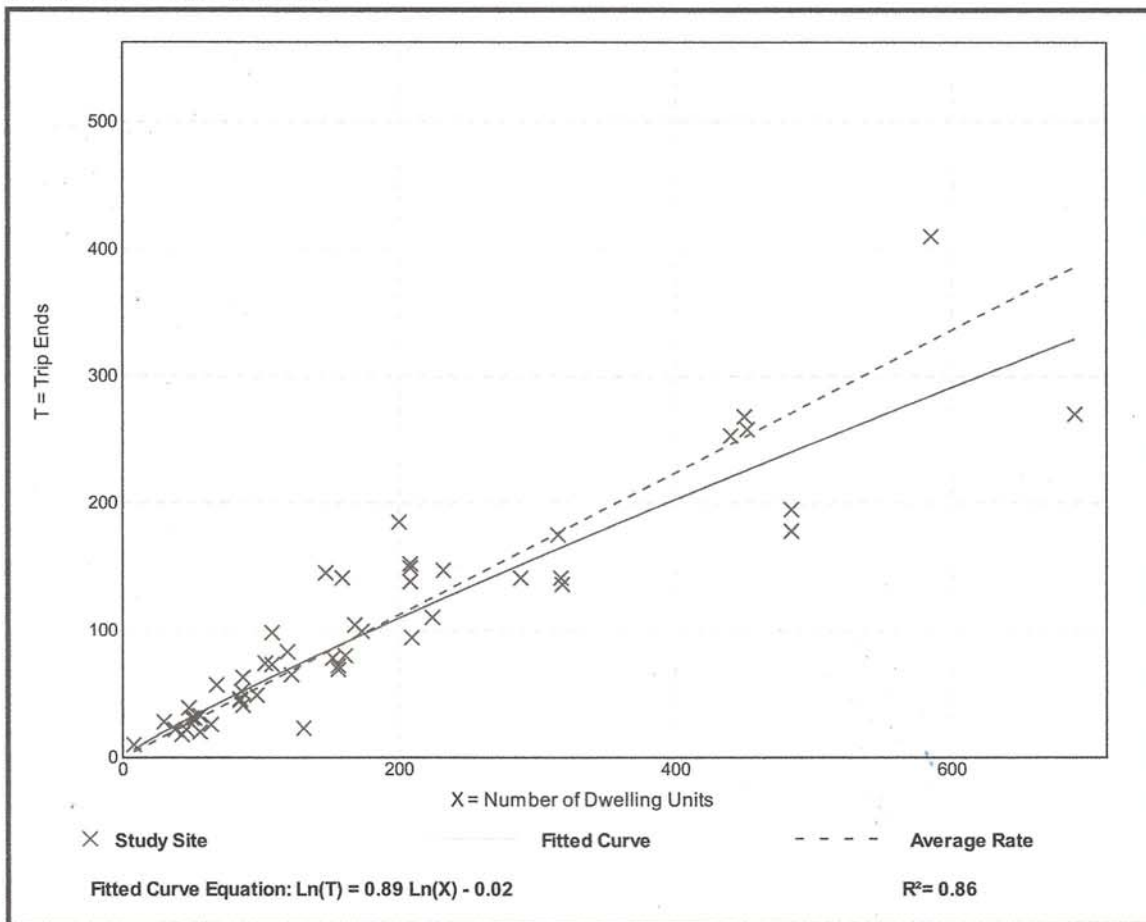

Land Use: 420 Marina

Description

A marina is a public or private facility that provides docks and berths for boats and may include limited retail and restaurant space.

Additional Data

The sites were surveyed in the 1980s in Connecticut and Washington.

Source Numbers

123, 265

Marina (420)

Vehicle Trip Ends vs: Berths
On a: **Weekday**

Setting/Location: General Urban/Suburban
Number of Studies: 2
Avg. Num. of Berths: 939
Directional Distribution: 50% entering, 50% exiting

Vehicle Trip Generation per Berth

Average Rate	Range of Rates	Standard Deviation
2.41	2.14 - 6.21	*

Data Plot and Equation

Caution – Small Sample Size

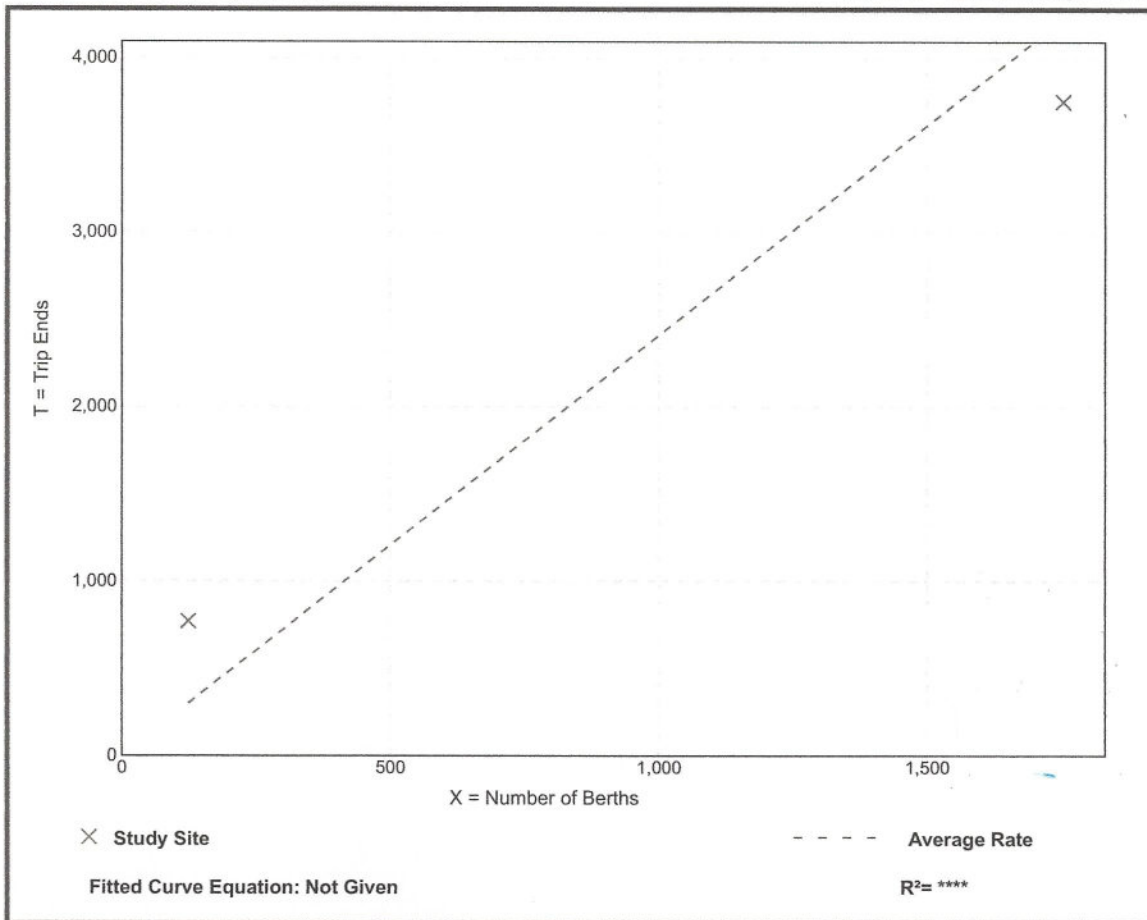

Marina (420)

Vehicle Trip Ends vs: Berths
On a: Weekday,
 Peak Hour of Adjacent Street Traffic,
 One Hour Between 7 and 9 a.m.
Setting/Location: General Urban/Suburban
 Number of Studies: 1
 Avg. Num. of Berths: 300
 Directional Distribution: 33% entering, 67% exiting

Vehicle Trip Generation per Berth

Average Rate	Range of Rates	Standard Deviation
0.07	0.07 - 0.07	*

Data Plot and Equation

Caution – Small Sample Size

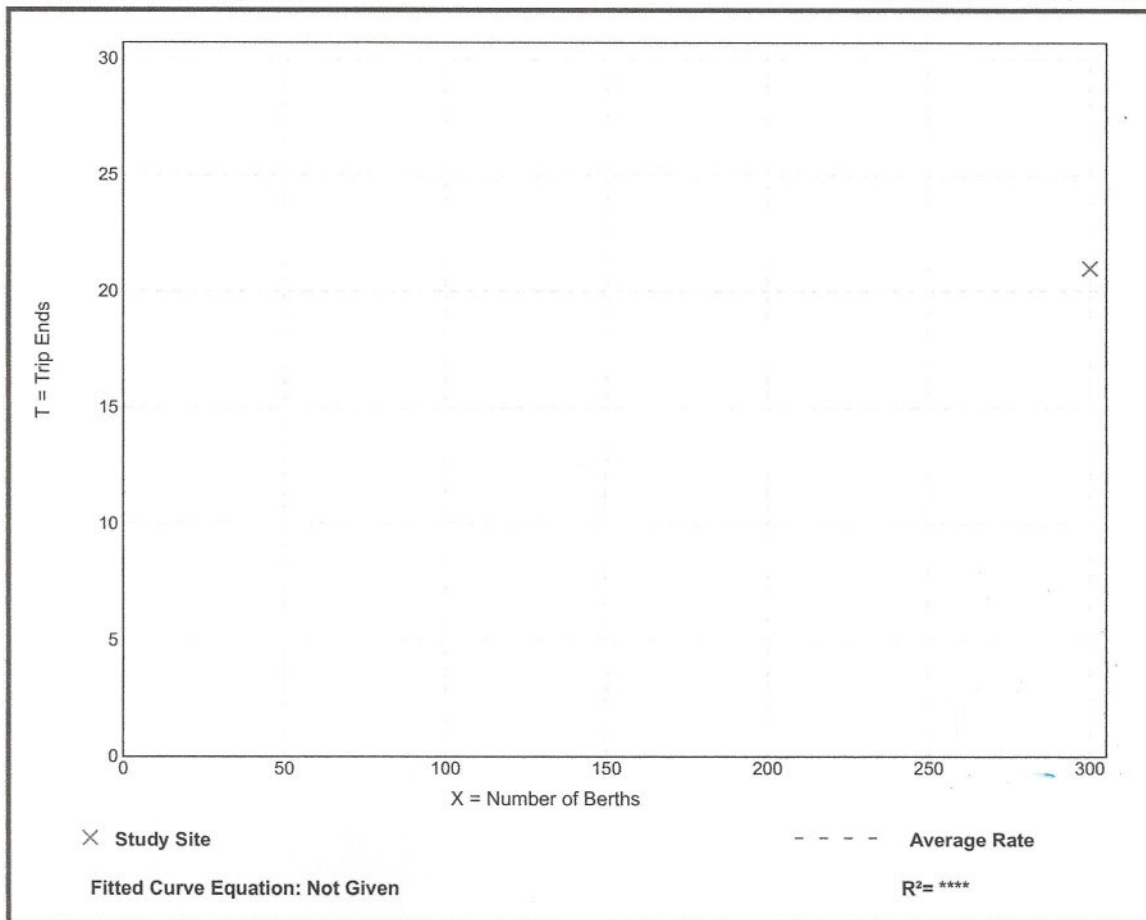

Marina (420)

Vehicle Trip Ends vs: Berths
On a: Weekday,
Peak Hour of Adjacent Street Traffic,
One Hour Between 4 and 6 p.m.
Setting/Location: General Urban/Suburban
 Number of Studies: 1
 Avg. Num. of Berths: 300
 Directional Distribution: 60% entering, 40% exiting

Vehicle Trip Generation per Berth

Average Rate	Range of Rates	Standard Deviation
0.21	0.21 - 0.21	*

Data Plot and Equation

Caution – Small Sample Size

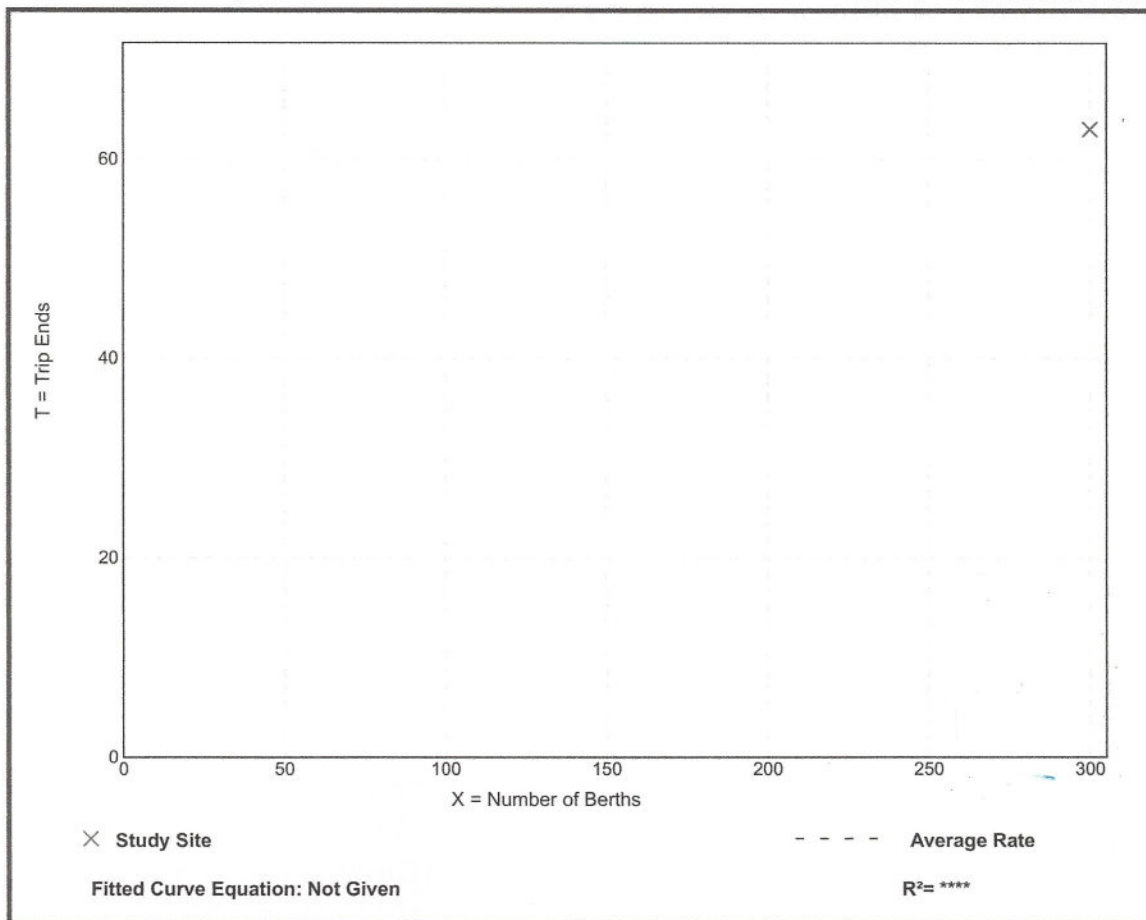

APPENDIX C
Auto Turn Analyses

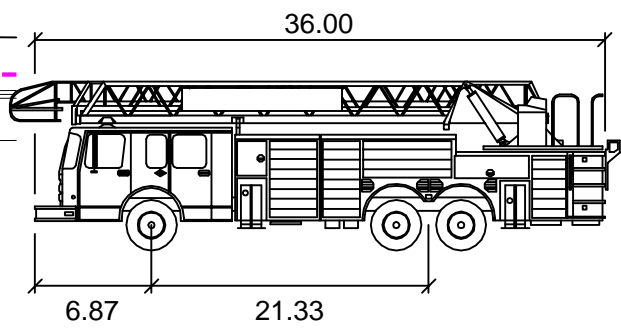
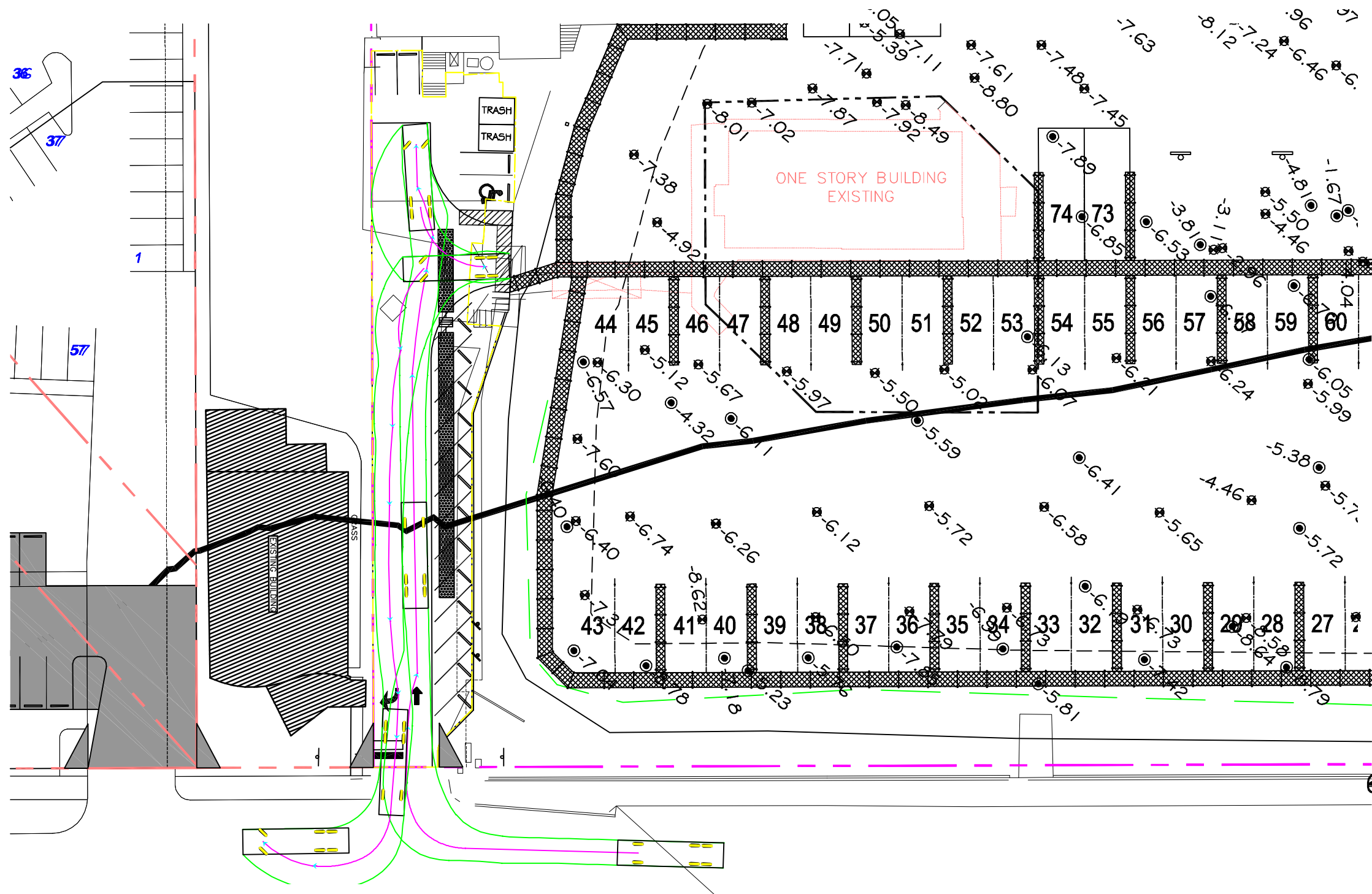

36' FIRE TRUCK		feet
Width	:	8.50
Track	:	7.08
Lock to Lock Time	:	6.00
Steering Angle	:	44.50

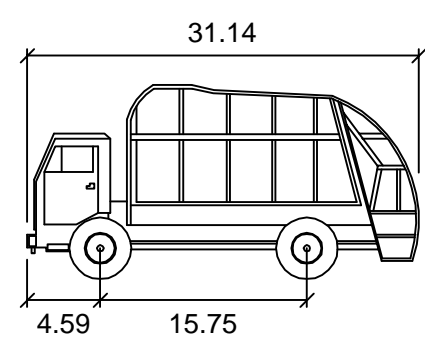
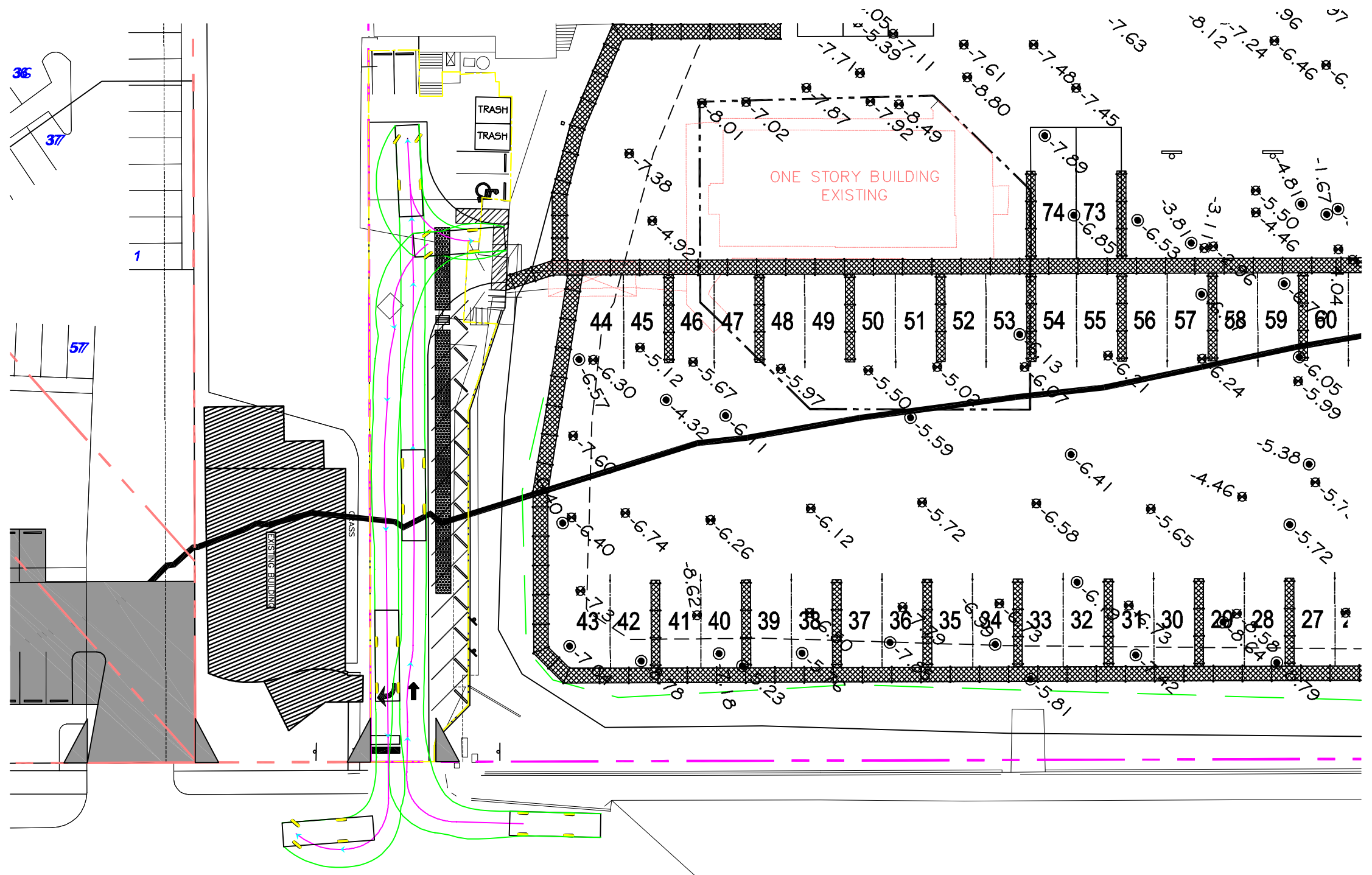

VUILNISAUTO	feet
Width	: 8.17
Track	: 8.17
Lock to Lock Time	: 6.00
Steering Angle	: 46.40

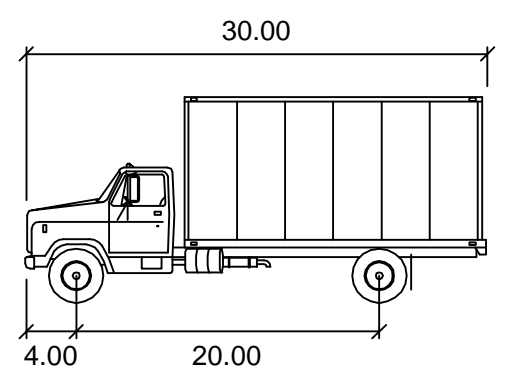
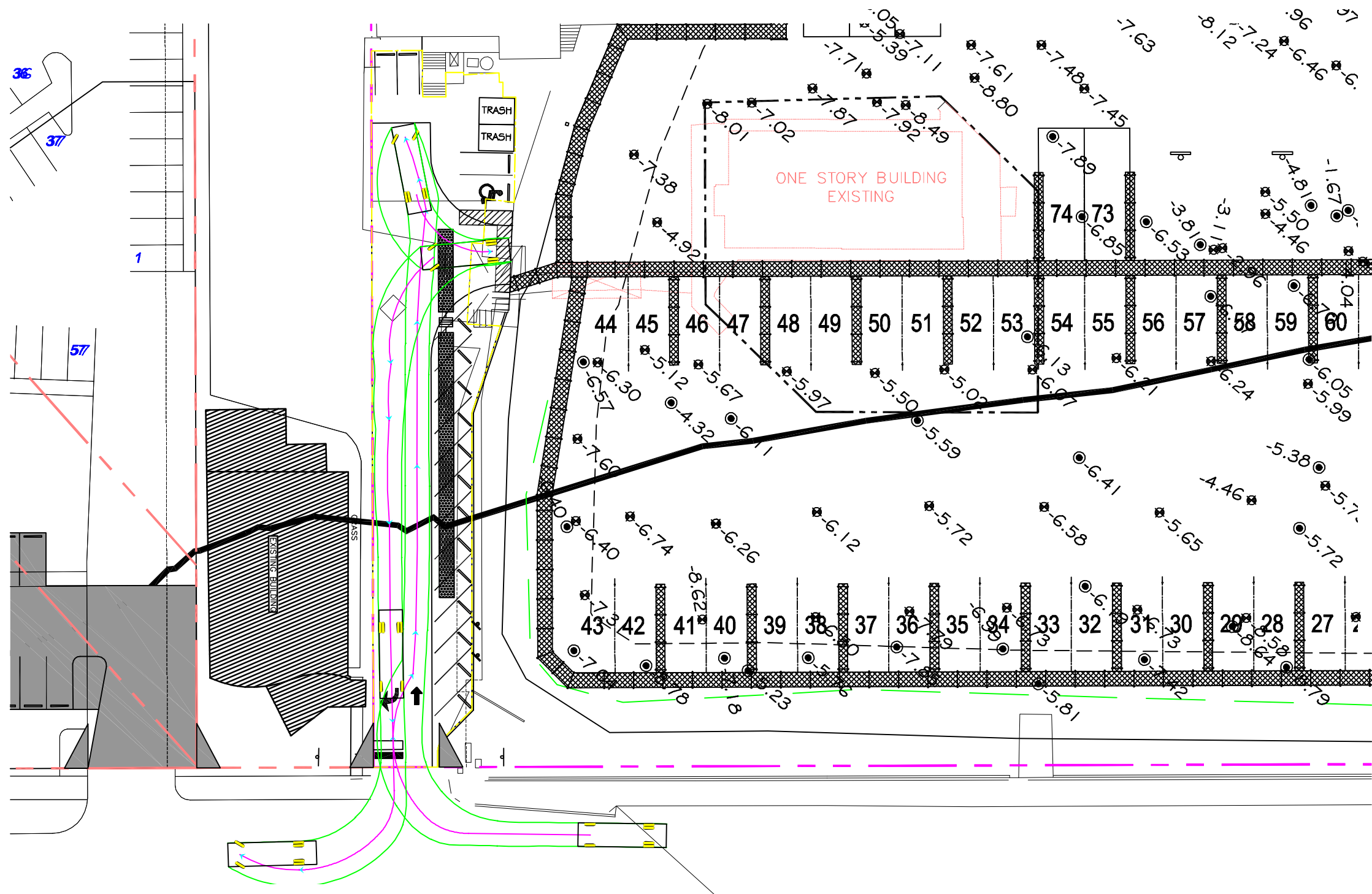

SU	feet
Width	: 8.00
Track	: 8.00
Lock to Lock Time	: 6.00
Steering Angle	: 31.80