

CONTRACT DOCUMENTS FOR:



RIGHT-OF-WAY IMPROVEMENTS 2017

ITB 17-017

FEBRUARY 2017

MAYOR: CRAIG CATES

COMMISSIONERS:

SAMUEL KAUFMAN

BILLY WARDLOW

JIMMY WEEKLEY

MARGARET ROMERO

CLAYTON LOPEZ

RICHARD PAYNE

PREPARED BY:
ENGINEERING SERVICES

TABLE OF CONTENTS

PART 1: BIDDING DOCUMENTS.....	1
INVITATION TO BID.....	2
INSTRUCTIONS TO BIDDERS.....	4
BID PROPOSAL.....	10
BID PROPOSAL FORM.....	12
FLORIDA BID BOND.....	19
PUBLIC ENTITY CRIMES FORM.....	21
ANTI-KICKBACK AFFIDAVIT.....	23
INDEMNIFICATION.....	24
LOCAL VENDOR CERTIFICATION.....	25
EQUAL BENEFITS FOR DOMESTIC PARTNERS AFFIDAVIT.....	26
CONE OF SILENCE AFFIDAVIT.....	27
BIDDER'S CHECKLIST.....	28
PART 2: CONTRACT DOCUMENTS.....	29
CONTRACT.....	30
FLORIDA PERFORMANCE BOND.....	32
FLORIDA PAYMENT BOND.....	34
PART 3: CONDITIONS OF THE CONTRACT.....	36
GENERAL CONDITIONS.....	37
SUPPLEMENTARY CONDITIONS.....	57
PART 4: GENERAL REQUIREMENTS.....	65
01001: GENERAL REQUIREMENTS.....	66
01014: ENVIRONMENT PROTECTION.....	74
01020: SUMMARY OF WORK.....	76
01025: MEASUREMENT AND PAYMENT.....	80
01050: FIELD ENGINEERING.....	85
01300: SUBMITTALS.....	87
01390: PRECONSTRUCTION AUDIO-VIDEO RECORDINGS.....	89
01500: TESTING SERVICES.....	90
01530: BARRIERS.....	92
01700: CONTRACT CLOSEOUT.....	94
PART 5: TECHNICAL SPECIFICATIONS.....	96
TECHNICAL SPECIFICATIONS AND REFERENCES.....	97
PART 6: STANDARD DETAILS.....	98
CITY OF KEY WEST DETAILS.....	99

PART 1: BIDDING DOCUMENTS

INVITATION TO BID

Sealed bids for RIGHT-OF-WAY IMPROVEMENTS 2017 / ITB 17-017 addressed to the City of Key West, will be received at the Office of the City Clerk, 1300 White Street., Key West Florida, until 3:00 p.m., local time, on the 16th day of March 2017, and then will be publicly opened and read. Any bids received after the time and date specified will not be considered.

Please submit ONE (1) ORIGINAL and TWO (2) USB drives each with a single file of the entire bid proposal package. Bid package shall be enclosed in a sealed envelope clearly marked on the outside “ITB 17-017: RIGHT OF WAY IMPROVEMENTS”; addressed and delivered to the City Clerk’s office at the address noted above.

The Project contemplated consists of work within the City’s RIGHTS OF WAY including asphalt paving, sidewalk construction, utility trench repair and shoulder restoration as directed by the City.

Drawings and Specifications may be obtained from Demand Star by Onvia or on the City of Key West website www.cityofkeywest-fl.gov. For bid package access on Demand Star please contact www.demandstar.com or call 1-800-711- 1712.

The successful Bidder will be required to furnish the necessary additional bond(s) for the faithful performance of the Contract, as Prescribed in the Bidding Documents. Within 10 days after the Notice of Award, the successful Bidder will also be required to furnish documentation showing that he is in compliance with the licensing requirements of the state and that the Provisions of Chapter 66 of the Code of Ordinances of the City of Key West. Compliance with these Provisions is required before the Contractor can enter into the agreement contained in the Contract Documents.

EACH BID MUST BE SUBMITTED ON THE PRESCRIBED FORM AND ACCOMPANIED BY BID SECURITY AS PRESCRIBED IN THE INSTRUCTIONS TO BIDDERS, PAYABLE TO THE CITY OF KEY WEST, FLORIDA, IN AN AMOUNT NOT LESS THAN FIVE (5) PERCENT OF THE AMOUNT BID.

THE BIDDER MUST BE A LICENSED CONTRACTOR BY THE STATE OF FLORIDA AND SUBMIT PROOF OF SUCH WITH THE BID.

The Bidder shall furnish documentation showing that he is in compliance with the licensing requirements of the provisions of Chapter 66 Section 87 of the Code of Ordinances of the City of Key West; within 10 days the following the Notice of Award and must demonstrate that he holds at a minimum, the following licenses & certificates;

- A. City of Key West Business Tax License Receipt
- B. A valid Certificate of Competency issued by the Chief Building Official of Key West, Florida.

All bid bonds, contract bonds, insurance contracts, and certificates of insurance shall be either executed by or countersigned by a licensed resident agent of the Surety or Insurance Company having his place of business in the State of Florida, and in all ways complying with the insurance laws of the State of Florida. Further, the said Surety or Insurance Company shall be duly licensed and qualified to do business in the State of Florida.

Before a Contract will be awarded for the work contemplated herein, the OWNER will conduct such investigation as is necessary to determine the performance record and ability of the apparent low Bidder to

perform the size and type of work specified under this Contract. Upon request, the Bidder shall submit such information as deemed necessary by the OWNER to evaluate the Bidder's qualifications.

At the time of the award, the successful Bidder must show satisfactory documents of such State, County, and City licenses as would be required. Any permit and/or license requirement and subsequent costs are located within the bid documents. The successful Bidder must also be able to satisfy the City Attorney as to such insurance coverage and legal requirements as may be demanded by the Bid in question. The City may reject bids for any and/or all of the following reasons: (1) for budgetary reasons, (2) if the bidder misstates or conceals a material fact in its bid, (3) if the bid does not strictly conform to the law or is non-responsive to the bid requirements, (4) if the bid is conditional, (5) if a change of circumstances occurs making the purpose of the bid unnecessary to the City, or (6) if such rejection is in the best interest of the City. The City may also waive any minor formalities or irregularities in any bid.

The Owner reserves the right to award contracts to multiple bidders (maximum of two) as necessary to meet required work schedules as determined by the City.

INSTRUCTIONS TO BIDDERS

1. CONTRACT DOCUMENTS

A. FORMAT

The Contract Documents are divided into parts, divisions, and sections for convenient organization and reference. Generally, there has been no attempt to divide the Specification sections into work performed by the various building trades, work by separate subcontractors, or work required for separate facilities in the Project.

B. DOCUMENT INTERPRETATION

The separate sections contained within these Contract Documents are intended to be mutually cooperative and to provide all details reasonably required for the execution of the proposed work.

Should there be any doubt as to the meaning or intent of said Contract Documents, the Bidder should request of the Engineer, in writing (at least eight (8) calendar days prior to the Bid opening) an interpretation thereof. Any interpretation or change in said Contract Documents will be made only in writing, in the form of addenda to the Documents which will become available to all registered holders of Bidding Documents. Bidders shall submit with their BIDS, or indicate receipt of, all Addenda. The Owner will not be responsible for any other explanation or interpretations of said Documents.

2. GENERAL DESCRIPTION OF THE PROJECT

A general description of the work to be done is contained in the Invitation to Bid and the scope is specified in applicable parts of these Contract Documents.

3. QUALIFICATION OF CONTRACTORS

The Prospective Bidders must meet the statutorily prescribed requirements before award of the Contract by the Owner.

4. BIDDER'S UNDERSTANDING

Each Bidder must inform himself of the conditions relating to the execution of the work and make himself thoroughly familiar with all the Contract Documents. Failure to do so will not relieve the successful Bidder of his obligation to enter into a Contract and complete the contemplated work in strict accordance with the Contract Documents. Each Bidder shall inform himself of, and the Bidder awarded a Contract shall comply with, federal, state, and local laws, statutes, and ordinances relative to the work. This requirement includes, but is not limited to, regulations concerning minimum wage rates, nondiscrimination in the employment of labor, protection of public and employee safety and health, environmental protection, natural resource protection, fire protection, burning and non-burning requirements, permits, fees, and similar subjects.

5. TYPE OF BID

A. UNIT PRICE

The bid for the work is to be submitted on a Unit Price basis. Unit prices shall be submitted in all appropriate places in the Bid Proposal Form.

6. PREPARATION OF BIDS

A. GENERAL

All blank spaces in the Bid form must be filled in, as required, in BLACK INK. All Price information will be shown in figures where required. No changes shall be made in the phraseology of the forms.

Any Bid shall be deemed informal which contains omissions erasures, alterations, or additions of any kind, or Prices uncalled for, or in which any of the Prices are obviously unbalanced, or which in any manner shall fail to conform to the conditions of the published Invitation to Bid.

Only one Bid from any individual, firm, partnership, or corporation under the same or different names will be considered. Should it appear to the Owner that any Bidder is interested in more than one Bid for work contemplated, all Bids in which such Bidder is interested will be rejected.

B. SIGNATURE

The Bidder shall sign his Bid in the blank space provided therefore. If Bidder is a corporation, the legal name of the corporation shall be set forth above, together with the signature of the officer or officers authorized to sign Contracts on behalf of the corporation. If the Bidder is a partnership, the true name of the firm shall be set forth above, together with the signature of the partner or partners authorized to sign Contracts on behalf of the partnership. If signature is by an agent, other than an officer of a corporation or a member of a partnership, a notarized power of attorney must be on file with the Owner Prior to opening of Bids or submitted with the Bid, otherwise the Bid will be regarded as not properly authorized.

C. SPECIAL BIDDING REQUIREMENTS

The Bidder's attention is brought to the hiring Practices and licenses and permits of the City of Key West. These are defined in the addition to Article 39, ORDINANCES, PERMITS, AND LICENSES, as set forth in the Supplementary Conditions.

The Bidder shall submit with his Bid his experience record showing their experience and expertise in RIGHT OF WAY improvement work. Such experience record shall provide at least five (5) current or recent Projects of similar work, preferably within Florida or the Southeastern United States.

The following information will be provided:

1. Description and location of work
2. Contract amount
3. Dates work was performed
4. Owner
5. Name of Owner's contact person and phone number

D. ATTACHMENTS

Bidder shall complete and submit the following forms with his Bid:

State of Florida Contractor's License
Anti-Kickback Affidavit
Public Entity Crime Form
Local Vendors Certification
Domestic Partnership Affidavit
Cone of Silence
Indemnification
Bidder's Checklist

7. STATE AND LOCAL SALES AND USE TAXES

Unless the Supplementary Conditions contains a statement that the Owner is exempt from state sales tax on materials incorporated into the work due to the qualification of the work under this Contract, the Contractor, as required by the laws and statutes of the state and its political subdivisions, shall pay all state and local sales and use taxes. Prices quoted in the Bid shall include all nonexempt sales and use taxes, unless Provision is made in the Bid form to separately itemize the tax.

8. SUBMISSION OF BID PROPOSALS

All Bids must be submitted not later than the time prescribed, at the place, and in the manner set forth in the Invitation to Bid. Bids must be made on the Bid Proposal forms provided herewith, submit one (1) original and two (2) USB drives each with a single file of the entire bid proposal package.

Each Bid must be submitted in a sealed envelope, so marked as to indicate the Bidder's name and its contents without being opened, and addressed in conformance with the instructions in the Invitation to Bid.

9. MODIFICATION OR WITHDRAWAL OF BID PROPOSALS

Prior to the time and date designated for receipt of Bids, any Bid submitted may be modified or withdrawn by notice to the party receiving Bids at the place designated for the receipt of Bids.

Such notice shall be in writing over the signature of the Bidder or by email. If by email, written confirmation over the signature of the Bidder shall be mailed and postmarked on or before the date and time set for receipt of Bids, and it shall be so worded as not to reveal the amount of the original Bid. No Bid may be withdrawn after the time scheduled for the opening of Bids, unless the time specified in paragraph AWARD OF CONTRACT of these Instructions to Bidders shall have elapsed.

10. BID SECURITY

Bids must be accompanied by cash, a certified check drawn on a bank in good standing, or a Bid Bond issued by a Surety authorized to issue such bonds in the state where the work is located, in the amount of five (5) percent of the total amount of the Bid submitted. This Bid security shall be given as a guarantee that the Bidder will not withdraw his Bid for a period of Sixty (60) days after Bid opening, and that if awarded the Contract, the successful Bidder will execute the attached Contract and furnish properly executed performance and payment bonds, each in the full amount of the contract price, within the time specified. Agent and surety phone numbers must be provided.

The attorney-in-Fact who executes this bond in behalf of the Surety must attach a notarized copy of his power-of-attorney as evidence of his authority to bind the Surety on the date of the execution of the bond. Where State Statute requires, certification by a resident agent shall also be provided.

If the Bidder elects to furnish a Bid Bond, he shall use the Bid Bond form bound herewith, or one conforming substantially thereto in form and content.

11. RETURN OF BID SECURITY

Within fifteen (15) days after the award of the Contract, the City will return the Bid securities to all Bidders who's Bids are not to be further considered in awarding the Contract. Retained Bid securities will be held until the Contract(s) has been finally executed, after which all Bid securities, other than Bidder's Bonds and any guarantees which have been forfeited, will be returned to the respective Bidders whose Bids they accompanied.

12. AWARD OF CONTRACT

Within sixty (60) calendar days after the opening of the Bids, the City will accept up to two of the Bids. The acceptance of the Bid(s) will be by written notice of award, mailed to the office designated in the Bid, or delivered to the Bidder's representative. In the event of failure of the lowest responsive Bidder(s) to sign the Contract and provide acceptable insurance certificate(s) and acceptable performance and payment bonds, and evidence of holding required licenses, the City may award the Contract to the next lowest, responsive, responsible Bidder.

The City reserves the right to accept or reject any and all Bids, and to waive any informalities and irregularities in said Bids.

13. BASIS OF AWARD

The award will be made by the City, on the basis of the Total of Base Bid Items found on the Bid Proposal Form from the lowest responsive, responsible Bidder(s), which in the City's sole and absolute judgment, will serve the best interests of the City. **The Owner reserves the right to award contracts to multiple bidders (maximum of two) as necessary to meet required work schedules as determined by the City.**

If at the time this Contract is to be awarded, the total of the lowest acceptable Bids exceed the funds then estimated by the City as available, the City may reject all Bids or take such other action as best serves the City's interest.

14. EXECUTION OF CONTRACT

The successful Bidder(s) shall, within ten (10) working days after receiving Notice of Award, sign and deliver to the City a Contract and two (2) copies in the form hereto attached together with the acceptable insurance certificates, bonds, and evidence of the holding required licenses as required in these Documents. Within ten (10) working days after receiving the signed Contract from the successful Bidder(s), the City's authorized agent will sign the Contract. Signature by both parties constitutes execution of the Contract.

15. CONTRACT BONDS

A. PERFORMANCE AND PAYMENT BONDS

The successful Bidders shall file with the City, at the time of delivery of the signed Contract, a Performance Bond and Payment Bond on the forms bound herewith, each in the full amount of the Contract Price in accordance with the requirements of Florida Statutes Section 255.05 or 713.23, as applicable, as security for the faithful performance of the Contract and the payment of all persons supplying labor and materials for the construction of the work, and to cover all guarantees against defective workmanship or materials, or both, during the warranty period following the date of final acceptance of the work by the City. The Surety furnishing this bond shall have a sound financial standing and a record of service satisfactory to the City, shall be authorized to do business in the State of Florida, and shall be listed on the current U.S. Department of Treasury Circular Number 570, or amendments thereto in the Federal Register, of acceptable Sureties for federal Projects. Section 255.05(7), Florida Statutes, in lieu of the bond required by law, the contractor may file with the city an alternative form of security in the form of cash, a money order, a certified check, a cashier's check or an irrevocable letter of credit.

B. POWER-OF-ATTORNEY

The Attorney-in-Fact (Resident Agent) who executes Performance and Payment Bonds on behalf of the Surety must attach a notarized copy of his power-of-attorney as evidence of his authority to bind the Surety on the date of execution of the bond. Performance and Payment Bonds, and respective powers-of-attorney will have the same date.

16. FAILURE TO EXECUTE CONTRACT AND FURNISH BOND

The Bidder(s) who has a Contract awarded to him and who fails to promptly and properly execute the Contract or furnish the required Bonds shall forfeit the bid security that accompanied his bid, and the bid security shall be retained as liquidated damages by the City, and it is agreed that this said sum is a fair estimate of the amount of damages the City will sustain in case the Bidders fail to enter into a Contract or furnish the required Bonds. Bid security deposited in the form of cash, a certified check, or cashier's check shall be subject to the same requirement as a Bid Bond.

17. PERFORMANCE OF WORK BY SUBCONTRACTOR

Each Bidder must furnish with his proposal a list of subcontractor performed items and the estimated value of each item.

18. TIME OF COMPLETION

The time of completion of the work to be performed under this Contract is the essence of the Contract. Delays and extensions of time may be allowed in accordance with the Provisions stated in the General Conditions. Work Orders will be issued by Engineer as a means to track time & materials for work performed in the referenced right of way. A time estimate for the completion of each work order will be stated in that particular Work Order; when the Contractor receives a Work Order, work shall commence as soon as possible and all work shall be completed within the number of calendar days stipulated in that particular Work Order.

Should the Contractor disagree with the time of completion for a specific Work Order, he shall, within five (5) calendar days of the receipt of the Work Order, make a written claim to the Engineer and City for an extension in the time of completion. If in the opinion of the Engineer and City, the Contractor presents sufficient evidence to justify the claim, an extension in the time of completion will be allowed for the period determined by the Engineer and City.

Should a Work Order extend past the one (1) year contract period for unforeseen reasons the work shall be automatically extended to the date of completion not to exceed 90 days.

NOTE TO BIDDER: Use Preferably BLACK ink for completing this Bid Proposal form.

BID PROPOSAL

To: The City of Key West, Florida

Address: 1300 White Street
Key West, Florida 33040

Project Title: RIGHT OF WAY IMPROVEMENTS 2017

Project No.: ITB 17-017

Bidder's person to contact for additional information on this Bid:

Name: RONALD J. ARMSTRONG

Telephone: 305 296-5606

E mail: RONALD J. ARMSTRONG

BIDDER'S DECLARATION AND UNDERSTANDING

The undersigned, hereinafter called the Bidder, declares that the only persons or parties interested in this Bid are those named herein, that this Bid is, in all respects, fair and without fraud, that it is made without collusion with any official of the City, and that the Bid is made without any connection or collusion with any person submitting another Bid on this Contract.

The Bidder further declares that he has carefully examined the Contract Documents for the construction of the Project, that he has satisfied himself as to the work involved, including materials and equipment, and conditions of work, including the fact that the description of the quantities of work and materials, as included herein, is brief and is intended only to indicate the general nature of the work and to identify the said quantities with the detailed requirements of the Contract Documents, and that this Bid is made according to the Provisions and under the terms of the Contract Documents, which Documents are hereby made a part of this Bid.

The Bidder further agrees that he has exercised his own judgment regarding the interpretation of subsurface information and has utilized all data which he believes pertinent from the Engineer, City, and other sources in arriving at his conclusions.

CONTRACT EXECUTION AND BONDS

The Bidder agrees that if this Bid is accepted, he will, within 10 days after Notice of Award, sign the Contract in the form annexed hereto, and will at that time, deliver to the City examples of the Performance Bond and Payment Bond required herein, and evidence of holding required licenses and certificates, and will, to the extent of his Bid, furnish all machinery, tool, apparatus, and other means of

construction and do the work and furnish all the materials necessary to complete all work as specified or indicated in the Contract Documents.

CERTIFICATES OF INSURANCE

Bidder agrees to furnish the City, before commencing the work under this Contract, the certificates of insurance as specified in these Documents.

START OF CONSTRUCTION AND CONTRACT COMPLETION TIME

The Bidder further agrees to begin work within 10 calendar days after the date of the Notice to Proceed and to complete the construction, in all respects, within the number of calendar days set forth in each Work Order.

This Contract will automatically expire and be terminated one (1) year after the date of the execution of the Contract by the City unless granted a one year contract extension at the discretion of the City.

LIQUIDATED DAMAGES

In the event the Bidder is awarded the Contract and shall fail to complete the work authorized by a particular Work Order within the time limit or extended time limit agreed upon in that Work Order, as more particularly set forth in the Contract Documents, liquidated damages shall be paid to the City at the rate of \$500 per day for all work authorized under said Work Order until the work shall have been satisfactorily completed as provided by the Contract Documents. Sundays and legal holidays shall be included in determining days in default.

ADDENDA

The Bidder hereby acknowledges that he has received Addenda Nos'. 1, 2, 3, _____, _____ (Bidder shall insert the number of each Addendum received) and agrees that all addenda issued are hereby made part of the Contract Documents, and the Bidder further agrees that his Bid(s) includes all impacts resulting from said Addenda.

SALES AND USE TAXES

The Bidder agrees that all federal, state, and local sales and use taxes are included in the stated bid Prices for the work.

ESTIMATED QUANTITIES

Estimated Quantities in Bid Proposal Form are provided for Bid comparison purposes. Work will be performed on a unit price basis and actual quantities for payment may vary significantly.

REVISION 1

BID PROPOSAL FORM

FDOT ITEM NUMBER	ITEM DESCRIPTION	QUANTITY	UNIT	UNIT PRICE	TOTAL EXTENDED PRICE
0101-1	MOBILIZATION/DEMOBILIZATION Per Work Order	1	EA	\$ 5,000.00	\$ 5,000.00
0210-1-1	Reworking Limerock Base (up to 6" thickness)	3,000	SY	\$ 4.40	\$ 13,200.00
0230-1	Limerock Stabilized base (12" thickness at 98% of T-180)	3,800	SY	\$ 21.00	\$ 79,800.00
0327-70-5	Asphalt Mining (2" average thickness, includes disposal)	20,000	SY	\$ 7.60	\$ 152,000.00
0334-1-13	Superpave Asphalt Leveling Course SP-12.5 (1.5" Thickness - Overlay) (Traffic Level C)	3,000	TON	\$ 213.00	\$ 639,000.00
0337-7-54	Asphalt Friction Course FC-9.5 (0.5" Thickness) (Traffic Level C)	1,000	TON	\$ 215.00	\$ 215,000.00
0425-3-50	Manholes, (Raise / Lower)	10	EA	\$ 550.00	\$ 5,500.00
0425-6	Valve/Meter Box, Adjustment	200	EA	\$ 100.00	\$ 20,000.00
0425-7	Manhole Cover-Replacement	10	EA	\$ 650.00	\$ 6,500.00
0425-8	Drainage Structures-Misc Adjustments	20	EA	\$ 500.00	\$ 10,000.00
0520-1-10	Concrete Curb & Gutter, Type "F"	1,000	LF	\$ 40.00	\$ 40,000.00
0520-2-4	Concrete Curb, Type "D"	1,000	LF	\$ 32.00	\$ 32,000.00
0522-1	Concrete Sidewalks, 4" thickness	2,000	SY	\$ 79.00	\$ 158,000.00
0522-2	Concrete Sidewalks & Driveways, 6" thickness	1,000	SY	\$ 83.00	\$ 83,000.00
0527-2	Detectable Warning(Endicott ADA Truncated Domes or equal)	4,000	SF	\$ 15.00	\$ 60,000.00
0570-1-2	Performance Sod	450	SY	\$ 11.00	\$ 4,950.00
0706-3	Retro-reflective Pavement Markers	200	EA	\$ 9.00	\$ 1,800.00
0710-11111	Painted Pave Marking (Standard, White, Solid, 6")	500	LF	\$ 2.00	\$ 1,000.00

FDOT ITEM NUMBER	ITEM DESCRIPTION	QUANTITY	UNIT	UNIT PRICE	TOTAL EXTENDED PRICE
0711-11121	Thermoplastic (70 Mil, White, Solid, 6")	3,000	LF	\$ 1.30	\$ 3,900.00
0711-11123	Thermoplastic (70 Mil, White, Solid, 12")	500	LF	\$ 3.25	\$ 1,625.00
0711-11124	Thermoplastic (70 Mil, White, Solid, 18")	200	LF	\$ 4.00	\$ 800.00
0711-11125	Thermoplastic (70 Mil, White, Solid, 24")	500	LF	\$ 5.00	\$ 2,500.00
0711-11160	Thermoplastic (70 Mil, White, Message) RESIDENTIAL PARKING	100	EA	\$ 150.00	\$ 15,000.00
0711-11170	Thermoplastic (70 Mil, White, Arrow)	10	EA	\$ 300.00	\$ 3,000.00
0710-11211	Painted Pavement Markings (Standard, Yellow, Solid, 6")	4,000	LF	\$ 1.40	\$ 5,600.00
0711-11221	Thermoplastic (70 Mil, Yellow, Solid, 6")	3,000	LF	\$ 1.40	\$ 4,200.00
0711-11223	Thermoplastic (70 Mil, Yellow, Solid, 12")	200	LF	\$ 4.00	\$ 800.00
0711-11224	Thermoplastic (70 Mil, Yellow, Solid, 18")	200	LF	\$ 5.00	\$ 1,000.00
0711-11421	Thermoplastic (70 Mil, Blue, Solid, 6")	500	LF	\$ 2.00	\$ 1,000.00
0710-11421	Painted Pavement Markings (Standard, Blue, Solid, 6")	500	LF	\$ 2.00	\$ 1,000.00
0711-11460	Thermoplastic (70 Mil, Blue, Handicap Symbol)	15	EA	\$ 300.00	\$ 4,500.00
1080-11201	Utility Fixtures, 2" - 4.9", Furnish & Install, Valve/Meter Box	20	EA	\$ 250.00	\$ 5,000.00
1080-15	Utility Fixtures, Adjust & Modify	10	EA	\$ 200.00	\$ 2,000.00
NS-1	New Single Post & New Sign (includes existing sign/post removal, 3" dia. Alum. Post, brackets, concrete footer & installation)	20	EA	\$ 450.00	\$ 9,000.00
NS-2	Single Sign Post (includes existing post removal, 3" dia. Alum. Post, brackets, concrete footer & installation, reuse existing sign)	20	EA	\$ 275.00	\$ 5,500.00
NS-3	Concrete Curb Thickened Edge	1,000	FT	\$ 2.00	\$ 2,000.00

FDOT ITEM NUMBER	ITEM DESCRIPTION	QUANTITY	UNIT	UNIT PRICE	TOTAL EXTENDED PRICE
NS-4	Shoulder Restoration (includes all equipment, labor, material (FDOT Certified Washed Miami No. 57 Stone) & cleanup/dust control)	20,000	SY	\$ 14.25	\$ 285,000.00
NS-5	Seepage Trench	500	LF	\$ 34.00	\$ 17,000.00
NS-6	Failed Trench Restoration	1,000	SY	\$ 119.00	\$ 119,000.00

SUB TOTAL OF EXTENDED AMOUNTS

TWO MILLION EIGHTEEN THOUSAND ONE HUNDRED SEVENTY FIVE--00/100 **\$ 2,016,175.00**
TOTAL IN WORDS TOTAL IN FIGURES

NS-7	Performance & Payment Bonds (based upon Subtotal Extended Amounts= \$ _____) To Be Paid on a Per Work Order Basis	Per \$1,000	2,018.18	\$ 14.00	\$ 28,254.52
------	---	-------------	----------	----------	--------------

TOTAL OF BASE BID ITEMS

TWO MILLION FORTY FOUR THOUSAND FOUR HUNDRED TWENTY NINE--52/100 **\$ 2,044,429.52**
TOTAL IN WORDS TOTAL IN FIGURES

CHARLEY TOPPINO & SONS, INC.

Company Name

Frank P. Toppino

Authorized Signature

PRESEDENT

Title

SUBCONTRACTORS

The Bidder further Proposes that the following subcontracting firms or businesses will be awarded subcontracts for the following portions of the work in the event that the Bidder is awarded the Contract:

Portion of Work: ASPHALT Value: \$1,006,000.00

Name: GENERAL ASPHALT CORP.

Address: 4850 NW 72ND AVE, MIAMI, FL 33166

Phone: (305) 592-3480

Portion of Work: PAVEMENT MARKINGS Value: \$47,700.00

Name: ROAD RUNNERS STRIPING

Address: 9804 NW 80th Ave. Hialeah Gardens, FL 33016

Phone: (305) 885-9448

Portion of Work: _____ Value: _____

Name: _____

Address: _____

Phone: _____

Portion of Work: _____ Value _____

Name: _____

Address: _____

Phone: _____

BIDDER

The names of the Principal officers of the corporation submitting this Bid, or of the partnership, or of all persons interested in this Bid as Principals are as follows:

Name	Title
FRANK P. TOPPINO	PRESIDENT
EDWARD TOPPINO SR.	SECRETARY
DANIEL P. TOPPINO	ASSISTANT SECRETARY
RICHAR J. TOPPINO	ASSISTANT TREASURER

If Sole Proprietor or Partnership

IN WITNESS hereto the undersigned has set his (its) hand this _____ day of _____, 2017.

Signature of Bidder

Title

If Corporation

IN WITNESS WHEREOF the undersigned corporation has caused this instrument to be executed and its seal affixed by its duly authorized officers this 15 day of MARCH, 2017.

(SEAL)



Name of Corporation CHARLEY TOPPINO & SONS, INC.

By *Frank R. Toppino*

Title PRESIDENT

Attest *Quilley Dymo Seig*

EXPERIENCE OF BIDDER

The Bidder states that he is an experienced Contractor and has completed similar Projects within the last 5 years. Refer to Instructions to Bidders paragraph 6.C.

(List five (5) similar Projects, with types, names of clients, construction costs, and references with phone numbers. Use additional sheets if necessary.)

SEE ATTACHED

CHARLEY TOPPINO & SONS, INC.

P.O. BOX 787

KEY WEST, FL 33041

305 296-5606

PAST PROJECTS

1.) CITY OF KEY WEST

P.O. BOX 1409

KEY WEST, FL 33040

305 809-3965

SCOPE OF WORK: STORM DRAINAGE, INJECTIONS WELLS, SIDEWALKS, CURBS, FOUNDATIONS, PIER REPAIR, LANDSCAPING & MAINTENANCE, ROADWORK, ASPHALT.

PROJECTS:

RIGHT OF WAY MAINTENANCE: 1998-2009	\$2,352,000	BOND YES
CONCRETE PLACEMENT- 2002, 2005, 2007	\$2,400,000	BOND YES
WHITE STREET PIER REPAIR	\$ 88,000	BOND YES
STAPLES AVE BRIDGE	\$ 81,000	BOND YES
HOCKEY RINK	\$ 50,000	BOND YES
KAMIEN SUBDIVISION	\$1,656,000	BOND YES
SOUTHERNMOST POINT REHABILITATION	\$ 73,000	BOND YES
GENERAL SERVICES CON. 1998---2000	\$4,000,000	BOND YES
GENERAL SERVICES CON. 2002, 2005	\$2,000,000	BOND YES
GENERAL SERVICES CON. 2007	\$2,000,000	BOND YES
GENERAL SERVICES CON. 2011	\$1,000,000	BOND YES
GRAVITY INJECTION WELLS: PHASE I	\$4,800,000	BOND YES
GRAVITY INJECTION WELLS: PHASE II	\$2,236,000	BOND YES
GRAVITY INJECTION WELLS: PHASE 5	\$1,998,385	BOND YES
GRAVITY INJECTION WELLS: PHASE 6	\$1,989,225	BOND YES
JOSE MARTI VEG REMOVAL / DRAINAGE	\$ 90,000	BOND NO
SMATHERS BEACH LANDSCAPING	\$ 100,000	BOND YES
DONALD AVE DRAINAGE SWALE	\$ 61,000	BOND NO
HURRICANE GEORGES CLEANUP	\$ 431,000	BOND NO
MITIGATION FLOW PROJECT	\$2,100,000	BOND YES
HARBOR WALK KW BIGHT	\$3,040,000	BOND YES
DINGY DOCKS 2001	\$ 104,000	BOND YES
WHITE ST PIER RIP RAP	\$ 131,054	BOND YES
FLAGLER AVE PHASE 1 & 2	\$1,391,000	BOND YES
WHITE ST PUMP STATION	\$1,645,000	BOND YES
SIDEWALK ENHANCEMENTS: PHASE 1	\$ 218,890	BOND YES
SIDEWALK ENHANCEMENTS: PHASE 2	\$ 164,181	BOND YES
SIDEWALK ENHANCEMENTS: PHASE 3	\$ 253,666.00	BOND YES
SIDEWALK ENHANCEMENTS: PHASE 4	\$ 197,080.00	BOND YES
SIDEWALK ENHANCEMENTS: PHASE 5	\$ 294,826.00	BOND YES
SIDEWALK ENHANCEMENTS: PHASE 6	\$ 446,800.00	BOND YES
SIDEWALK ENHANCEMENTS: PHASE 7	\$ 235,100.00	BOND YES
COLLEGE ROAD ENHANCEMENTS	\$ 283,921.84	BOND YES

ATLANTIC BLVD ENHANCEMENTS	\$ 498,839.13	BOND YES
DONALD AVE CANAL EMBANK	\$ 50,912.00	BOND NO
16 TH ST PAVEMENT STABILIZATION	\$108,000.00	BOND NO
CAROLINE STREET IMPROVEMENTS	\$3,000,000.00	BOND YES
PUMP STATION "F"	\$1,671,000.00	BOND YES
SIMONTON STREET EMER OUTFALL	\$ 893,000.00	BOND YES

2.) MONROE COUNTY
1100 SIMONTON STREET
KEY WEST, FL 33040
305 292-4426

SCOPE OF WORK: SITE WORK, STORM DRAINAGE, INJECTIONS WELLS, SIDEWALKS, CURBS, LANDSCAPING, ROADWORK, ASPHALT, PLAYGROUNDS.

PROJECTS:

PALM AVE ROADWAY	\$ 931,000	BOND YES
WILHELMINA PARK	\$ 145,000	BOND YES
MARATHON AIRPORT TAXILANES, T HANGER DEV.	\$2,366,000	BOND YES
MARATHON AIRPORT SERVICE ROAD	\$ 688,000	BOND YES
KW INTN AIRPORT: EXOTIC VEGETATION REMOVE	\$ 192,000	BOND YES
KW INTN AIRPORT: PARKING LOTS	\$ 531,000	BOND YES
BIG COPPITT PARK	\$ 860,242	BOND YES
BIG PINE BASIN FILL IN AND DEMO	\$ 904,943	BOND YES
MARATHON AIRPORT APRONS	\$ 376,344	BOND YES
PRADO CIRCLE	\$ 339,000	BOND YES
PALM DR BRIDGE REPAIR	\$ 131,000	BOND NO
KWIA DRAINAGE RECONSTRUCTION	\$ 295,000	BOND YES

3.) FLORIDA DEPT OF TRANSPORTATION
605 Suwannee Street
Tallahassee, FL 32399-0450
(850) 414-4000

SCOPE OF WORK: SITE WORK, DEMOLITION, STORM DRAINAGE, SANITARY SEWER, INJECTIONS WELLS, SIDEWALKS, CURBS, ROADWORK, ASPHALT, HURRICANE CLEANUP, RIP-RAP INSTALL, SIGNAGE, FENCING.

TRUMAN AVE PROJECT:	\$10,500,000	BOND YES
BIG COPPITT BIKE PATH:	\$ 480,000	BOND YES
EMERGENCY ROAD REPAIRS, HURR WILMA:	\$ 185,000	BOND NO
HURRICANE GEORGES ROAD REPAIRS:	\$ 52,000	BOND NO
KNIGHTS KEY	\$ 373,000	BOND YES
BIG COPPITT BOAT RAMP & SPANISH HARBOR:	\$ 500,000	BOND NO
BIKE PATH SADDLE BUNCH KEYS	\$ 450,000	BOND YES
BOCA CHICA SEAGRASS MITIGATION	\$ 1,352,930	BOND YES
SUMMERLAND KEY DRAINAGE	\$2,000,000	BOND YES

3.) SAUER INC.
11223 PHILLIPS PARKWAY DR EAST
JACKSONVILLE, FL 32256-15274
904 262-6444

SCOPE OF WORK: SITE WORK, DEMOLITION, STORM DRAINAGE, SANITARY SEWER, INJECTIONS WELLS, SIDEWALKS, CURBS, ROADWORK, ASPHALT.

PROJECTS:

CONTROL TOWER, BOCA CHICA NAS	\$832,000	BOND YES
WEATHER STATION, KEY WEST	\$366,000	BOND YES
NAVAL RESEARCH LAB	\$100,000	BOND NO
REPAIR MARINE OPS, COAST GUARD	\$337,000	BOND NO

4.) FLORIDA KEY AQUADUCT AUTHORITY
1100 KENNEDY DRIVE
KEY WEST, FL 33040
305 296-2454

SCOPE OF WORK: SITE WORK, STORM DRAINAGE, SIDEWALKS, CURBS, ROADWORK, ASPHALT, STEEL BUILDING, WATER MAINS, DEMOLITION.

PROJECTS:

FCAA CONSTRUCTION YARD BUILDING	\$ 682,000	BOND YES
PUMP STATION	\$ 377,555	BOND YES
BIG COPPITT WASTE WATER SYSTEM	\$11,078,347	BOND YES
DEMO WATER TANKS, BIG COPPITT	\$ 55,000	BOND YES
FLAGLER AVE WATERMAIN	\$ 306,861	BOND YES
REPUMP STATION BIG PINE KEY	\$ 919,020.00	BOND YES

5.) GULF BUILDERS
P.O. BOX 668307
POMPANO BEACH, FL 33066
954 583-5115

SCOPE OF WORK: SITE WORK, STORM DRAINAGE, SANITARY SEWER, WATER MAINS, INJECTIONS WELLS, SIDEWALKS, CURBS, ROADWORK, PARKING LOTS, ASPHALT.

PROJECTS:

ROOSEVELT GARDENS HOUSING PROJECT	\$1,256,000	BOND	YES
-----------------------------------	-------------	------	-----

6.) BJ&K CONSTRUCTION
970 WEST MCNAB ROAD
FORT LAUDERDALE, FL 33309
954 974-7744

SCOPE OF WORK: SITE WORK, DEMOLITION, STORM DRAINAGE, SANITARY SEWER, WATER MAINS, INJECTIONS WELLS, SIDEWALKS, CURBS, ROADWORK, PARKING LOTS, ASPHALT.

PROJECTS:

MERIDIAN WEST APARTMENTS	\$1,700,000	BOND	YES
--------------------------	-------------	------	-----

7.) HEERY INTERNATIONAL
1625 DENNIS STREET
KEY WEST, FL 33040
305 293-3008

SCOPE OF WORK: SITE WORK, DEMOLITION, STORM DRAINAGE, SANITARY SEWER, WATER MAINS, INJECTIONS WELLS, GAS LINES, SIDEWALKS, CURBS, ROADWORK, PARKING LOTS, ASPHALT.

PROJECTS:

KEY WEST HIGH SCHOOL REPLACEMENT: PHASES 1, 2, 3	\$2,363,000	BOND	YES
POINCIANA ELEMENTARY SCHOOL:	\$633,000	BOND	YES

8. COASTAL CONSTRUCTION
5959 BLUE LAGOON DR
STE 200
MIAMI, FL 33126
305 559-4900

SCOPE OF WORK: SITE WORK, DEMOLITION, FILL, CONCRETE FLATWORK, COLUMNS, RETAINING WALLS, CURBS, ROADWORK, PARKING LOTS, ASPHALT.

PROJECTS:

SUGARLOAF ELEMENTARY SCHOOL:	\$2,300,000	BOND	YES
BEACHSIDE CONDOS	\$2,665,000	BOND	YES
POINCIANA ROYALE	\$ 524,520	BOND	YES
HORACE O BRYANT MIDDLE SCH DEMO	\$ 388,081	BOND	YES
HORACE O BRYANT MIDDLE SCH SITE	\$1,553,202	BOND	YES

9.) HISTORIC TOURS OF AMERICA
201 FRONT STREET
Key West, Florida 33040
305 296-3609

SCOPE OF WORK: SITE WORK, DEMOLITION, STORM DRAINAGE, SANITARY SEWER, WATER MAINS, INJECTIONS WELLS, GAS LINES, SIDEWALKS, CURBS, ROADWORK, PARKING LOTS, ASPHALT.

PROJECTS:

PARK VILLAGE	\$ 317,000	BOND NO
MARQUESA COURT	\$ 405,000	BOND NO
KEY COVE LANDINGS	\$ 675,000	BOND NO
LANDINGS AT KEY HAVEN	\$1,500,000	BOND NO

10.) DEMOYA GROUP
12209 S. DIXIE HWY
MIAMI, FL 33156
305 255-5713

SCOPE OF WORK: STORM DRAINAGE , INJECTIONS WELLS, ROAD BASE, CONCRETE WORK.

PROJECTS:

SOUTH ROOSEVELT BLVD. REHAB	\$1,507,000.00	BOND NO (SUB)
BIG COPPITT US 1 ROAD EXPANSION	\$ 2,157,000	BOND NO (SUB)

11.) DL PORTER
6574 PALMER CIRCLE
SARASOTA, FL 34238
941 929-9400

SCOPE OF WORK: SITE WORK, DEMOLITION, STORM DRAINAGE, SANITARY SEWER, WATER MAINS, INJECTIONS WELLS, GAS LINES, SIDEWALKS, CURBS, ROADWORK, PARKING LOTS, ASPHALT.

PROJECTS:

HOMELAND SECURITY, KEY WEST	\$ 231,600.00	BOND NO
KEY WEST INTERNATIONAL AIRPORT	\$ 724,000.00	BOND NO
SANTA MARIA HOTEL	\$ 225,000.00	BOND NO
COUCH HARBOR	\$ 210,000.00	BOND NO
ATLANTIC SHORES DEMO & SITEWORK	\$1,011,000.00	BOND NO
TRUMAN HOTEL SITEWORK	\$ 55,000.00	BOND NO

SPINDRIFT HOTEL DEMO & SITEWORK	\$300,000.00	BOND NO
FIRE STATION # 2 CITY OF KEY WEST	\$661,000.00	BOND NO
SPINDRIFT HOTEL	\$150,000.00	BOND NO
HISTORIC SEAPORT COMMONS	\$ 81,000.00	BOND NO

12. HARRY PEPPER & ASSOCIATES
215 CENTURY 21 DRIVE
JACKSONVILLE, FL 32216
904 721-3300

SCOPE OF WORK: SITE WORK, DEMOLITION, STORM DRAINAGE, SANITARY SEWER, WATER MAINS, INJECTIONS WELLS, GAS LINES, SIDEWALKS, CURBS, ROADWORK, PARKING LOTS, ASPHALT.

PROJECTS:

REPAIR BASE OPERATIONS, BOCA CHICA	\$601,000	BOND NO
ELLISON DRIVE, TRUMBO POINT	\$ 116,000	BOND NO
BEQ, TRUMAN ANNEX	\$ 70,000	BOND NO
JIAFT EAST WAREHOUSE	\$462,000	BOND NO

13. BRPH
3275 SUNTREE BLVD
MELBOURNE, FL 32940

SCOPE OF WORK: SITE WORK, DEMOLITION, STORM DRAINAGE, SANITARY SEWER, WATER MAINS, INJECTIONS WELLS, GAS LINES, SIDEWALKS, CURBS, ROADWORK, PARKING LOTS, ASPHALT.

PROJECTS:

ECO DISCOVERY CENTER	\$ 50,000	BOND NO
BOCA CHICA FITNESS CENTER	\$ 36,000	BOND NO
MARINA BY PASS ROAD, BOCA	\$348,000	BOND NO
TACTS BUILDING, BOCA CHICA	\$ 32,000	BOND NO
NANCY FOSTER ENVIRONMENTAL CTR	\$541,000	BOND NO
BLDG. # 324 PARKING	\$93,000	BOND NO
SIGSBEE PARK YOUTH CENTER	\$89,600	BOND NO

14. DOOLEY MACK CONTRACTORS
5800 LAKEWOOD RANCH BLVD.
SARASOTA, FL 34240
941 921-4636

SCOPE OF WORK: SITE WORK, DEMOLITION, STORM DRAINAGE, SANITARY SEWER, WATER MAINS, INJECTIONS WELLS, GAS LINES, SIDEWALKS, CURBS, ROADWORK, PARKING LOTS, ASPHALT.

PROJECTS:

STEAMPLANT CONDOS	\$1,332,000.00	BOND YES
THE MEADOWS, KEY WEST	\$ 145,000.00	BOND NO

**15. BOTANICAL GARDENS
5210 COLLEGE ROAD
KEY WEST, FL 33040
305 296-1504**

SCOPE OF WORK: DEMOLITION, , SIDEWALKS, CURBS, ROADWORK, PARKING LOTS, BOARDWALK / PILE CONSTRUCTION, BOULDER CUTTING & PLACEMENT, LAKE / POND CONSTRUCTION.

PROJECTS:

BOTANICAL GARDENS PHASE 1 POND	\$329,896.50	BOND YES
BOTANICAL GARDENS PHASE III	\$167,000.00	BOND YES

**16. BALFOUR BEATTY MILITARY HOUSING MANAGEMENT LLC
10 CAMPUS BLVD.
NEWTOWN SQUARE, PA 19073
610 355-8051**

SCOPE OF WORK: DEMOLITION, , SIDEWALKS, CURBS, ROADWORK, PARKING LOTS, BOARDWALK / PILE CONSTRUCTION, BOULDER CUTTING & PLACEMENT, LAKE / POND CONSTRUCTION.

PROJECTS:

RENOVATIONS FAMILY HOUSING MEDICAL CTR	\$141,350.00	BOND NO
RENOVATIONS TO QUARTERS LB, MEDICAL CTR	\$ 39,800.00	BOND NO

**17. FL DEPT OF ENVIRONMENTAL PROTECTION
3900 COMMONWEALTH BLVD.
TALLAHASSEE, FL 32399-3000
305 420-8432**

SCOPE OF WORK: BRIDGE REPAIR TO OLD OHIO BAHIA HONDA BRIDGE, MM 38.7, REPAIR ENTIRE SUPER STRUCTURE DECK, PROVIDE AND INSTALL AL PEDESTRIAN RAILING, MILL/RESURFACE AND STRIPE, SPALL / CRACK REPAIR.

PROJECTS:

OHIO BAHIA HONDA BRIDGE REPAIR:	\$837,700.00	BOND YES
HERITAGE TRAIL: SUGARLOAF SEGMENT:	\$255,000.00	BOND YES
HERITAGE TRAIL: KEY HAVEN TO BIG COPPITT:	\$2,052,268.00	BOND YES
HERITAGE TRAIL: SPANISH HARBOR	\$4,083,000.00	BOND YES

18. SH MARATHON, LTD.
506 FLEMING ST.
KEY WEST, FL 33040
305 294-6100

SCOPE OF WORK: DEMOLITION AND REBUILD OF HOTEL, RESTAURANT, MARINA AND BOAT SLIPS IN MARATHON, FL. HOLIDAY INN EXPRESS.

HOLIDAY INN EXPRESS: \$8,890,227 BOND YES

19. DORADO/CONQUISTADOR
541 N. PALMATTO AVE.
SUITE 104
SANFORD, FL 32771
407 688-0600

SCOPE OF WORK: SITEWORK, ENVIRONMENTAL MITIGATION, CANAL EXCAVATION, FILL REMOVAL AND PROCESSING AT THE BOCA CHICA NAVAL AIR STATION AIRFIELD.

PROJECTS:

BOCA CHICA AIRFIELD VEGETATION	\$1,057,126.00	BOND YES
BOCA CHICA ANTENNA PAD MITIGATION	\$ 385,213.00	BOND NO
GEIGER KEY MITIGATION	\$ 432,549.46	BOND NO
NE HYDRO RESTORATION	\$1,206,399.00	BOND YES
BOCA CHICA WEST LAGOONS	\$ 910,420.00	BOND YES
BOCA CHICA PERIMETER ROAD	\$ 315,317.00	BOND YES
ROCKLAND STAGING AREA	\$ 69,899.00	BOND YES
BIG COPPITT SITE 2 EAST	\$ 47,910.00	BOND YES
AREAS: 1,2,3,5,6, 20,21,22,23,24	\$6,800,000.00	BOND YES

20. SS RAFFERTY, LLC
3717 EAGLE AVE
KEY WEST, FL 33040

SCOPE OF WORK: DEMOLITION, SITEWORK, BUILDING.

512 DUVAL STREET BUILDING \$1,071,586.28 BOND NO

21. BOTSFORD BUILDERS
937 107th Street Gulf
Marathon, FL 33050
(305) 743-9644

SCOPE OF WORK: SITEWORK, DEMOLITION, STORM DRAINAGE, SANITARY SEWER, WATER MAINS, PARKING LOTS, ASPHALT, SIDEWALKS, CURBS, ROADWORK.

PROJECTS:

FLAGLER'S VILLAGE	\$956,445.00	BOND YES
OCEANSIDE MARINA DEMO	\$193,950.00	BOND NO

22. GENERAL ASPHALT

4950 NW 172 AVE
MIAMI, FL 33166
(305) 592-3480

SCOPE OF WORK: EXCAVATION, CLEAR / GRUBBING, ROAD BASE, CONCRETE WORK
STORM DRAINAGE

SUGARLOAF SEGMENT US # 1	\$401,598.22	BOND NO
SHARK KEY WEST US # 1	\$61,320.86	BOND NO
RAMROD LITTLE TORCH US # 1	\$463,939.28	BOND NO
SUGARLOAF TO BIG COPPITT US # 1	\$136,250.46	BOND NO
TRUMAN AVE E6I33	\$125,588.00	BOND NO
S. ROOSEVELT-BIG COPPITT US # 1 T6320	\$1,860,000.00	BOND NO

23. WHARTON SMITH

3547 SW CORPORATE PARKWAY
PALM CITY, FL 34990-8152
(772) 283-2944

SCOPE OF WORK: STORM DRAINAGE, INJECTION WELLS.

GEORGE ST BASIN PROJECT	\$ 80,134.50	BOND YES
CUDJOE REGIONAL AWRF	\$250,800.00	BOND YES

24. AJAX BUILDING CORPORATION

6050 PORTER WAY
SARASOTA, FL 34232
(941) 371-6222

SCOPE OF WORK: SITE WORK, DEMOLITION, STORM DRAINAGE, SANITARY SEWER,
WATER MAINS, INJECTIONS WELLS, FIRE LINES, SIDEWALKS, CURBS, ROADWORK,
PARKING LOTS, ASPHALT

FKCC MARINE TECH BUILDING	\$466,000.00	BOND YES
---------------------------	--------------	----------

25. CIVIC CONSTRUCTION

7144 SW 47TH STREET
MIAMI, FL 33155
(305) 661-4859

JL WOODE, LLC
49 IMMIGRATION ST
SUITE 103
CHARLESTON, SC 29403
(312) 363-6000

SCOPE OF WORK: SITE WORK, DEMOLITION, STORM DRAINAGE, SANITARY SEWER,
WATER MAINS, FIRE LINES, SIDEWALKS, CURBS, ROADWORK, PARKING LOTS, ASPHALT

PROJECTS:

HILTON GARDEN INN, SITE B DEMO	\$62,000.00	BOND NO
FAIRFIELD INN, SITE A DEMO	\$50,000.00	BOND NO
QUALITY INN, SITE C DEMO	\$235,502.00	BOND NO
HAMPTON INN, SITE D SITEWORK	\$244,653.00	BOND NO
HILTON GARDEN INN, SITE B SITEWORK	\$603,000.00	BOND NO
FAIRFIELD INN, SITE A SITEWORK	\$461,000.00	BOND NO
QUALITY INN, SITE C SITEWORK	\$477,000.00	BOND NO

27. SCHOOL BOARD, MONROE COUNTY

241 TRUMBO RD
KEY WEST, FL 33040
(305) 293-1400

SCOPE OF WORK: SITE WORK, SIDEWALKS, CURBS, ROADWORK, PARKING LOTS, ASPHALT, FIELD LIGHTING.

HARRIS SCHOOL DEMO	\$86,000.00	BOND NO
HOB PARKING LOT, SOCCER FIELD	\$343,882.00	BOND YES

28. BOY SCOUTS OF AMERICA, SOUTH FL COUNCIL

15255 NW 82ND AVE
MIAMI LAKES, FL 33016
(305) 364-0020

SCOPE OF WORK: SITEWORK, DEMOLITION, STORM DRAINAGE, SANITARY SEWER, LIFT STATION, GRINDER PUMPS, WATER MAINS, PARKING LOTS, ASPHALT, SIDEWALKS, CURBS, ROADWORK, MODULAR HOUSE, TWO STORY BATHHOUSE FACILITY, ELECTRICAL, PLUMBING, LANDSCAPING, ENVIRONMENTAL MITIGATION.

CAMP SAWYER, BOY SCOUT CAMP	\$2,295,049.13	BOND YES
-----------------------------	----------------	----------

29. LONGSTOCK II, LLC STOCK ISLAND MARINA VILLAGE, PHASE 1

7009 SHRIMP ROAD
KEY WEST, FL 33040
(305) 294-2288

SCOPE OF WORK: SITE WORK, DEMOLITION, STORM DRAINAGE, INJECTIONS WELLS, SANITARY SEWER, WATER MAINS, FIRE LINES, SIDEWALKS, CURBS, BRICK PAVING, ROADWORK, PARKING LOTS, ASPHALT, FENCING, MARINE DOCK FACILITIES: DECKING, FIRE SYSTEM, SANITARY SEWER LIFT STATION, FORCE MAINS, SEAWALLS, FLOATING DOCKS, FUEL SYSTEM, LANDSCAPING, IRRIGATION, DREDGING.

STOCK ISLAND MARINA VILLAGE PH 1	\$ 15,010,683.79	BOND YES
----------------------------------	------------------	----------

30. DOUGLAS N. HIGGINS, KEY WEST

5707 College Road
Key West, FL 33040
(305) 292-7717

SCOPE OF WORK: DEMOLITION, STORM DRAINAGE, INJECTIONS WELLS, SANITARY SEWER.

EAST FRONT ST FLOOD MITIGATION, CKW	\$444,000.00	BOND NO
KEY WEST TRANSIT FACILITY	\$ 77,487.00	BOND NO

31. LAYNE HEAVY CIVIL
4520 NORTH STATE ROAD 37
ORLEANS, IN 47452
812 865-3232

SCOPE OF WORK: TEMP INJECTIONS WELLS, SANITARY SEWER, WATER MAINS.

CUDJOE REGIONAL WASTEWATER COLLECTION SYSTEM: OUTER ISLANDS	\$5,400,000.00	BOND NO
--	----------------	---------

32. GIANNETTI CONTRACTING OF FL, INC.
2660 NW 15th Court # 108
Pompano Beach, FL 33069-1500
(954) 972-8104

SCOPE OF WORK: TEMP INJECTIONS WELLS

CUDJOE REGIONAL WASTEWATER COLLECTION SYSTEM: OUTER ISLANDS	\$391,200.00	BOND NO
--	--------------	---------

33. SOUTHERNMOST CABANA RESORT, LLC
P.O. Box 420236
Summerland Key, FL. 33042
(850) 221 2338

SCOPE OF WORK: SITEWORK, SANITARY SEWER, STORM SEWER, FIRE LINES, WATERMAINS.

SOUTHERNMOST CABANA RESORT	\$430,000.00	BOND NO
----------------------------	--------------	---------

33. MARATHON OCEAN HOUSING LLC
5604 PGA BOULEVARD
SUITE 109
PALM BEACH GARDENS, FL 33418
(561) 722-9725

SCOPE OF WORK: SITEWORK, SANITARY SEWER (GRAVITY & VAC SYSTEM), STORM SEWER, FIRE LINES, WATERMAINS, DEMOLITION, ROADWORK, CONCRETE WORK, ASPHALT PAVING, PAVEMENT STRIPING, LANDSCAPING.

TARPON HARBOR, MARATHON	\$2,223,000.00	BOND NO
-------------------------	----------------	---------

FLORIDA BID BOND

BOND NO. Not applicable

AMOUNT: \$ --- 5% ---

KNOW ALL MEN BY THESE PRESENTS, that Charley Toppino & Sons, Inc. hereinafter called the PRINCIPAL, and Travelers Casualty and Surety Company of America a corporation duly organized under the laws of the State of Connecticut having its principal place of business at in the State of CT and authorized to do business in the State of Florida, as SURETY, are held firmly bound unto City of Key West, hereinafter called the Obligee, in the sum of DOLLARS (\$ --- 5% of Bid Proposal Submitted - - - - -) for the payment for which we bind ourselves, our heirs, executors, administrators, successors, and assigns, jointly and severally, firmly by these present.

THE CONDITION OF THIS BOND IS SUCH THAT:

WHEREAS, the PRINCIPAL is herewith submitting his or its Bid or Proposal, said Bid Proposal, by reference thereto, being hereby made a part hereof.

WHEREAS, the PRINCIPAL contemplates submitting or has submitted a bid to the OBLIGEE for the furnishing of labor, materials, (except those specifically furnished by the Owner), equipment, machinery, tools, apparatus, means of transportation for, and the performance of the work covered in the Proposal and the detailed Drawings and Specifications entitled:

RIGHT OF WAY IMPROVEMENTS 2017

WHEREAS, it was a condition precedent to the submission of said bid that a cashier's check, certified check, or bid bond in the amount of 5 percent of the base bid be submitted with said bid as a guarantee that the Bidder would, if awarded the Contract, enter into a written Contract with the Owner for the performance of said Contract, within ten (10) working days after written notice having been given of the award of the Contract.

NOW, THEREFORE, the conditions of this obligation are such that if the PRINCIPAL within ten (10) working days after written notice of such acceptance, enters into a written Contract with the OBLIGEE then this obligation shall be void; otherwise the sum herein stated shall be due and payable to the OBLIGEE and the Surety herein agrees to pay said sum immediately upon demand of the OBLIGEE in good and lawful money of the United States of America, as liquidated damages for failure thereof of said principal.

Signed and sealed this 8th day of March, 2017.

Charley Toppino & Sons, Inc.

PRINCIPAL

By: Frank P Toppino

Travelers Casualty and Surety Company of America

SURETY

By: [Signature]

ATTORNEY-IN-FACT

William L. Parker, Attorney in Fact & FL Res Agent

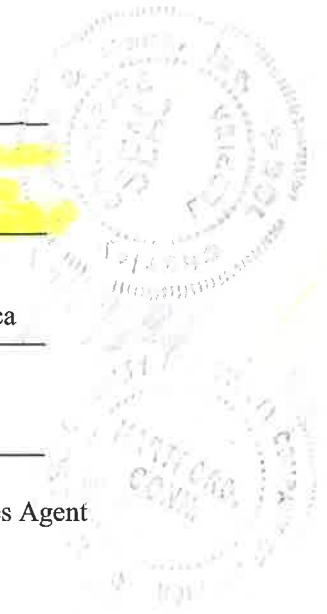



POWER OF ATTORNEY

Farmington Casualty Company
Fidelity and Guaranty Insurance Company
Fidelity and Guaranty Insurance Underwriters, Inc.
St. Paul Fire and Marine Insurance Company
St. Paul Guardian Insurance Company

St. Paul Mercury Insurance Company
Travelers Casualty and Surety Company
Travelers Casualty and Surety Company of America
United States Fidelity and Guaranty Company

Attorney-In Fact No. 230629

Certificate No. 006719147

KNOW ALL MEN BY THESE PRESENTS: That Farmington Casualty Company, St. Paul Fire and Marine Insurance Company, St. Paul Guardian Insurance Company, St. Paul Mercury Insurance Company, Travelers Casualty and Surety Company, Travelers Casualty and Surety Company of America, and United States Fidelity and Guaranty Company are corporations duly organized under the laws of the State of Connecticut, that Fidelity and Guaranty Insurance Company is a corporation duly organized under the laws of the State of Iowa, and that Fidelity and Guaranty Insurance Underwriters, Inc., is a corporation duly organized under the laws of the State of Wisconsin (herein collectively called the "Companies"), and that the Companies do hereby make, constitute and appoint

William L. Parker, Davor I. Mimica, Ileana M. Bauza, William Frederick Kleis, and Eduardo A. Menendez

of the City of Miami, State of Florida, their true and lawful Attorney(s)-in-Fact, each in their separate capacity if more than one is named above, to sign, execute, seal and acknowledge any and all bonds, recognizances, conditional undertakings and other writings obligatory in the nature thereof on behalf of the Companies in their business of guaranteeing the fidelity of persons, guaranteeing the performance of contracts and executing or guaranteeing bonds and undertakings required or permitted in any actions or proceedings allowed by law.

IN WITNESS WHEREOF, the Companies have caused this instrument to be signed and their corporate seals to be hereto affixed, this 25th day of March, 2016.

Farmington Casualty Company
Fidelity and Guaranty Insurance Company
Fidelity and Guaranty Insurance Underwriters, Inc.
St. Paul Fire and Marine Insurance Company
St. Paul Guardian Insurance Company

St. Paul Mercury Insurance Company
Travelers Casualty and Surety Company
Travelers Casualty and Surety Company of America
United States Fidelity and Guaranty Company



State of Connecticut
City of Hartford ss.

By: [Signature]
Robert L. Raney, Senior Vice President

On this the 25th day of March, 2016, before me personally appeared Robert L. Raney, who acknowledged himself to be the Senior Vice President of Farmington Casualty Company, Fidelity and Guaranty Insurance Company, Fidelity and Guaranty Insurance Underwriters, Inc., St. Paul Fire and Marine Insurance Company, St. Paul Guardian Insurance Company, St. Paul Mercury Insurance Company, Travelers Casualty and Surety Company, Travelers Casualty and Surety Company of America, and United States Fidelity and Guaranty Company, and that he, as such, being authorized so to do, executed the foregoing instrument for the purposes therein contained by signing on behalf of the corporations by himself as a duly authorized officer.

In Witness Whereof, I hereunto set my hand and official seal. My Commission expires the 30th day of June, 2016.



[Signature]
Marie C. Tetreault, Notary Public

PUBLIC ENTITY CRIMES FORM

**SWORN STATEMENT UNDER SECTION 287.133(3)(a)
FLORIDA STATUTES, ON PUBLIC ENTITY CRIMES**

**THIS FORM MUST BE SIGNED IN THE PRESENCE OF A NOTARY PUBLIC OR OTHER
OFFICE AUTHORIZED TO ADMINISTER OATHS.**

1. This sworn statement is submitted with Bid, Proposal or Contract No. ITB 17-017
for RIGHT OF WAY IMPROVEMENT 2017

2. This sworn statement is submitted by CHARLEY TOPPINO & SONS, INC.
(name of entity submitting sworn statement)
whose business address is P.O. BOX 787 KEY WEST, FL 33041
_____ and (if applicable) its Federal Employer
Identification Number (FEIN) is 59 2426906 (If the entity has no FEIN, include the Social
Security Number of the individual signing this sworn statement.)

3. My name is FRANK P. TOPPINO and my relationship
to PRESIDENT (please Print name of individual signing) the entity named above is
.

4. I understand that a "public entity crime" as defined in Paragraph 287.133(1)(g), Florida Statutes, means a violation of
any state or federal law by a person with respect to and directly related to the transaction of business with any public
entity or with an agency or political subdivision of any other state or with the United States, including but not limited
to, any bid or contract for goods or services to be Provided to any public entity or an agency or political subdivision of
any other state or of the United States and involving antitrust, fraud, theft, bribery, collusion, racketeering, conspiracy,
material misrepresentation.

5. I understand that "convicted" or "conviction" as defined in Paragraph 287.133(1)(b), Florida Statutes, means a finding
of guilt or a conviction of a public entity crime, with or without an adjudication guilt, in any federal or state trial court
of record relating to charges brought by indictment information after July 1, 1989, as a result of a jury verdict, non-
jury trial, or entry of a plea of guilty or nolo contendere.

6. I understand that an "affiliate" as defined in Paragraph 287.133(1)(a), Florida Statutes, means
 1. A Predecessor or successor of a person convicted of a public entity crime: or
 2. An entity under the control of any natural person who is active in the management of t entity and who has
been convicted of a public entity crime. The term "affiliate" includes those officers, directors, executives,
partners, shareholders, employees, members, and agents who are active in the management of an affiliate.
The ownership by one person of shares constituting controlling interest in another person, or a pooling of
equipment or income among persons when not for fair market value under an arm's length agreement, shall
be a prima facie case that one person controls another person. A person who knowingly enters into a joint
venture with a person who has been convicted of a public entity crime in Florida during the Preceding 36
months shall be considered an affiliate.

7. I understand that a "person" as defined in Paragraph 287.133(1)(8), Florida Statutes, means any natural person or
entity organized under the laws of any state or of the United States with the legal power to enter into a binding
contract and which bids or applies to bid on contracts for the Provision of goods or services let by a public entity, or
which otherwise transacts or applies to transact business with a public entity. The term "person" includes those
officers, directors, executives, partners, shareholders, employees, members, and agents who are active in management

of an entity.

8. Based on information and belief, the statement that I have marked below is true in relation to the entity submitting this sworn statement. (Please indicate which statement applies.)

Neither the entity submitting this sworn statement, nor any officers, directors, executives, partners, shareholders, employees, members, or agents who are active in management of the entity, nor any affiliate of the entity have been charged with and convicted of a public entity crime subsequent to July 1, 1989.

The entity submitting this sworn statement, or one or more of the officers, directors, executives, partners, shareholders, employees, members, or agents who are active in management of the entity, or an affiliate of the entity has been charged with no convicted of a public entity crime subsequent to July 1, 1989, AND (Please indicate which additional statement applies.)

There has been a Proceeding concerning the conviction before a hearing of the State of Florida, Division of Administrative Hearings. The final order entered by the hearing officer did not place the person or affiliate on the convicted vendor list. (Please attach a copy of the final order.)

The person or affiliate was placed on the convicted vendor list. There has been a subsequent Proceeding before a hearing officer of the State of Florida, Division of Administrative Hearings. The final order entered by the hearing officer determined that it was in the public interest to remove the person or affiliate from the convicted vendor list. (Please attach a copy of the final order.)

The person or affiliate has not been put on the convicted vendor list. (Please describe any action taken by or pending with the Department of General Services.)

Frank P. Toppino
(signature) 3-15-17
(date)

STATE OF FL

COUNTY OF MONROE

PERSONALLY APPEARED BEFORE ME, the undersigned authority,
FRANK P. TOPPINO who, after first being sworn by me, affixed his/her signature
in the space provided above on this 15TH
(name of individual signing)
day of MARCH, 2017

My commission expires:

Ronald J. Armstrong
NOTARY PUBLIC

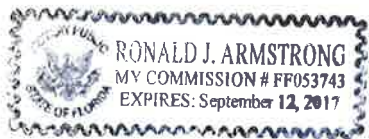

ANTI-KICKBACK AFFIDAVIT

STATE OF FL)
COUNTY OF MONROE) : SS

I, the undersigned hereby duly sworn, depose and say that no portion of the sum herein bid will be paid to any employees of the City of Key West as a commission, kickback, reward or gift, directly or indirectly by me or any member of my firm or by an officer of the corporation.

By: *Joseph P. Sappier*

Sworn and subscribed before me this

15 day of MARCH, 2017

Ronald J. Armstrong
NOTARY PUBLIC, State of Florida at Large

My Commission Expires: _____

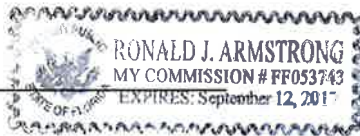

INDEMNIFICATION

To the fullest extent permitted by law, the CONTRACTOR expressly agrees to indemnify and hold harmless the City of Key West, their officers, directors, agents, and employees (herein called the "indemnitees") from liabilities, damages, losses and costs, including, but not limited to, reasonable attorney's fees and court costs, such legal expenses to include costs incurred in establishing the indemnification and other rights agreed to in this Paragraph, to persons or property, to the extent caused by the negligence, recklessness, or intentional wrongful misconduct of the CONTRACTOR, its Subcontractors or persons employed or utilized by them in the performance of the Contract. Claims by indemnitees for indemnification shall be limited to the amount of CONTRACTOR's insurance or \$1 million per occurrence, whichever is greater. The parties acknowledge that the amount of the indemnity required hereunder bears a reasonable commercial relationship to the Contract and it is part of the project specifications or the bid documents, if any.

The indemnification obligations under the Contract shall not be restricted in any way by any limitation on the amount or type of damages, compensation, or benefits payable by or for the CONTRACTOR under workers' compensation acts, disability benefits acts, or other employee benefits acts, and shall extend to and include any actions brought by or in the name of any employee of the CONTRACTOR or of any third party to whom CONTRACTOR may subcontract a part or all of the Work. This indemnification shall continue beyond the date of completion of the work.



CONTRACTOR: CHARLEY TOPPINO & SONS, INC.

SEAL:

P.O. BOX 787, KEY WEST, FL 33041

Address

Frank P. Toppino
Signature

FRANK P. TOPPINO

Print Name

PRESIDENT

Title

3-15-17

Date

LOCAL VENDOR CERTIFICATION
PURSUANT TO CKW ORDINANCE 09-22 SECTION 2-798

The undersigned, as a duly authorized representative of the vendor listed herein, certifies to the best of his/her knowledge and belief, that the vendor meets the definition of a "Local Business." For purposes of this section, "local business" shall mean a business which:

- a. Principle address as registered with the FL Department of State located within 30 miles of the boundaries of the city, listed with the chief licensing official as having a business tax receipt with its principle address within 30 miles of the boundaries of the city for at least one year immediately prior to the issuance of the solicitation.
- b. Maintains a workforce of at least 50 percent of its employees from the city or within 30 miles of its boundaries.
- c. Having paid all current license taxes and any other fees due the city at least 24 hours prior to the publication of the call for bids or request for proposals.
 - Not a local vendor pursuant to Ordinance 09-22 Section 2-798
 - Qualifies as a local vendor pursuant to Ordinance 09-22 Section 2-798

If you qualify, please complete the following in support of the self-certification & submit copies of your County and City business licenses. Failure to provide the information requested will result in denial of certification as a local business.

Business Name CHARLEY TOPPINO & SONS, INC. Phone: 305 296-5606
US HWY # 1, MM 8.5, ROCKLAND KEY
Current Local Address: KEY WEST, FL 33040 Fax: 305 296-5189
(P.O Box numbers may not be used to establish status)

Length of time at this address: 35 YEARS

Frank P. Toppino Date: 3-15-17
Signature of Authorized Representative

STATE OF FL COUNTY OF MONROE

The foregoing instrument was acknowledged before me this 15 day of MARCH, 2017.

By Frank P. Toppino, of CHARLEY TOPPINO & SONS, INC.
(Name of officer or agent, title of officer or agent) (Name of corporation acknowledging)

or has produced identification _____ as identification
(Type of identification)

Ronald J. Armstrong
Signature of Notary



Return Completed form with
Supporting documents to:
City of Key West Purchasing

Print Type or Stamp Name of Notary

Title or Rank

CONE OF SILENCE AFFIDAVIT

STATE OF FL)
)
) : SS
COUNTY OF MONROE)

I the undersigned hereby duly sworn depose and say that all owner(s), partners, officers, directors, employees and agents representing the firm of CHARLEY TOPPINO & SONS, INC have read and understand the limitations and procedures regarding communications concerning City of Key West issued competitive solicitations pursuant to City of Key West Ordinance Section 2-773 Cone of Silence.

Frank P. Toppino

Signature

3-15-17

Date

Sworn and subscribed before me this

15 Day of MARCH, 2017.

Ronald J. Armstrong

NOTARY PUBLIC, State of F at Large
L

My Commission Expires: _____

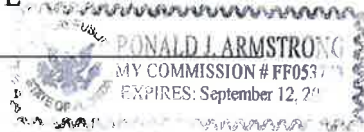

BIDDER'S CHECKLIST

(Note: The purpose of this checklist is to serve as a reminder of major items to be addressed in submitting a bid and is not intended to be all inclusive. It does not alleviate the Bidder from the responsibility of becoming familiar with all aspects of the Contract Documents and proper completion and submission of his bid.)

1. All Contract Documents thoroughly read and understood
2. All blank spaces in Bid filled in black ink.
3. Extended amounts and sum of these amounts added correctly.
4. Addenda acknowledged.
5. Subcontractors named in the Bid.
6. Experience record included.
7. Bid signed by authorized officer.
8. Bid Bond completed and executed, including power-of-attorney dated the same day.
9. Bidder familiar with federal, state, and local laws, ordinances, rules and regulations affecting performance of the work.
10. Bidder, if successful, able to obtain and/or demonstrate possession of required licenses and certificates within 10 days after receiving a Notice of Award.
11. Bid submitted intact with the volume containing the Bidding Requirements and one (1) original and two (2) USB drives each with a single file of the entire bid package.
12. Bid Documents submitted in sealed envelope and addressed and labeled in conformance with the instructions in the Invitation to Bid.
13. Bid Proposal Submitted with Anti-kickback Affidavit, Public Entity Crime Forms, City of Key West Indemnification Form, Local Vendor Certification, Equal Benefits, Cone of Silence, State of Florida License, and Bidder's Checklist.

**2016 / 2017
MONROE COUNTY BUSINESS TAX RECEIPT
EXPIRES SEPTEMBER 30, 2017**

RECEIPT# 30140-89799

Business Name: CHARLEY TOPPINO & SONS INC

Owner Name: FRANK TOPPINO, JOHN P TOPPINO QUAL
Mailing Address: BOX 787
KEY WEST, FL 33041

Business Location: US HWY 1
KEY WEST, FL 33040
Business Phone: 305-296-5606
Business Type: CONTRACTOR (GENERAL & ENGINEERING CONTRACTORS)

Employees 70

COMP CARD: ENG I 131A /GC 152A

STATE LICENSE: CGC1518488

Tax Amount	Transfer Fee	Sub-Total	Penalty	Prior Years	Collection Cost	Total Paid
250.00	0.00	250.00	0.00	0.00	0.00	250.00

Paid 116-15-00001144 07/08/2016 250.00

THIS BECOMES A TAX RECEIPT
WHEN VALIDATED

Danise D. Henriquez, CFC, Tax Collector
PO Box 1129, Key West, FL 33041

THIS IS ONLY A TAX.
YOU MUST MEET ALL
COUNTY AND/OR
MUNICIPALITY PLANNING
AND ZONING REQUIREMENTS.

**MONROE COUNTY BUSINESS TAX RECEIPT
P.O. Box 1129, Key West, FL 33041-1129
EXPIRES SEPTEMBER 30, 2017**

RECEIPT# 30140-89799

Business Name: CHARLEY TOPPINO & SONS INC

Owner Name: FRANK TOPPINO, JOHN P TOPPINO QUAL
Mailing Address: BOX 787
KEY WEST, FL 33041

Business Location: US HWY 1
KEY WEST, FL 33040
Business Phone: 305-296-5606
Business Type: CONTRACTOR (GENERAL & ENGINEERING CONTRACTORS)

Employees 70

COMP CARD: ENG I 131A /GC 15

STATE LICENSE: CGC1518488

Tax Amount	Transfer Fee	Sub-Total	Penalty	Prior Years	Collection Cost	Total Paid
250.00	0.00	250.00	0.00	0.00	0.00	250.00

Paid 116-15-00001144 07/08/2016 250.00

**2016 / 2017
MONROE COUNTY BUSINESS TAX RECEIPT
EXPIRES SEPTEMBER 30, 2017**

RECEIPT# 39140-67814

Business Name: MONROE CONCRETE PRODUCTS INC

Owner Name: FRANK AND GEORGE TOPPINO
Mailing Address: PO DRAWER 1149
KEY WEST, FL 33041

Business Location: MM 9 ROCKLAND KEY
KEY WEST, FL 33040
Business Phone: 305-296-9164
Business Type: MANUFACTURING (MANUFACTURING CONCRETE)

Employees 10

Tax Amount	Transfer Fee	Sub-Total	Penalty	Prior Years	Collection Cost	Total Paid
30.00	0.00	30.00	0.00	0.00	0.00	30.00

Paid 107-15-00000899 07/11/2016 30.00

THIS BECOMES A TAX RECEIPT
WHEN VALIDATED

Danise D. Henriquez, CFC, Tax Collector
PO Box 1129, Key West, FL 33041

THIS IS ONLY A TAX.
YOU MUST MEET ALL
COUNTY AND/OR
MUNICIPALITY PLANNING
AND ZONING REQUIREMENTS.

MONROE COUNTY BUSINESS TAX RECEIPT
P.O. Box 1129, Key West, FL 33041-1129
EXPIRES SEPTEMBER 30, 2017

RECEIPT# 39140-67814

Business Name: MONROE CONCRETE PRODUCTS INC

Owner Name: FRANK AND GEORGE TOPPINO
Mailing Address: PO DRAWER 1149
KEY WEST, FL 33041

Business Location: MM 9 ROCKLAND KEY
KEY WEST, FL 33040
Business Phone: 305-296-9164
Business Type: MANUFACTURING (MANUFACTURING CONCRETE)

Employees 10

Tax Amount	Transfer Fee	Sub-Total	Penalty	Prior Years	Collection Cost	Total Paid
30.00	0.00	30.00	0.00	0.00	0.00	30.00

Paid 107-15-00000899 07/11/2016 30.00

**2016 / 2017
MONROE COUNTY BUSINESS TAX RECEIPT
EXPIRES SEPTEMBER 30, 2017**

RECEIPT# 53110-25514

Business Name: ROCKLAND RECYCLING CENTER ENERGY
COMMONS INC DBA

Owner Name: FRANK & EDWARD & GEORGE TOPPINO
Mailing Address:

P O BOX 1149
KEY WEST, FL 33041

Business Location: MM 8.5 US HWY 1
KEY WEST, FL 33040

Business Phone: 305-296-5606
Business Type: WHOLESALE SALES (RECYCLING CONST DEBRIS)

0

Tax Amount	Transfer Fee	Sub-Total	Penalty	Prior Years	Collection Cost	Total Paid
30.00	0.00	30.00	0.00	0.00	0.00	30.00

Paid 116-15-00001144 07/08/2016 30.00

THIS BECOMES A TAX RECEIPT
WHEN VALIDATED

Danise D. Henriquez, CFC, Tax Collector
PO Box 1129, Key West, FL 33041

THIS IS ONLY A TAX.
YOU MUST MEET ALL
COUNTY AND/OR
MUNICIPALITY PLANNING
AND ZONING REQUIREMENTS.

MONROE COUNTY BUSINESS TAX RECEIPT
P.O. Box 1129, Key West, FL 33041-1129
EXPIRES SEPTEMBER 30, 2017

RECEIPT# 53110-25514

Business Name: ROCKLAND RECYCLING CENTER ENERGY
COMMONS INC DBA

Owner Name: FRANK & EDWARD & GEORGE TOPPINO
Mailing Address:

P O BOX 1149
KEY WEST, FL 33041

Business Location: MM 8.5 US HWY 1
KEY WEST, FL 33040

Business Phone: 305-296-5606
Business Type: WHOLESALE SALES (RECYCLING CONST DEBRIS)

0

Tax Amount	Transfer Fee	Sub-Total	Penalty	Prior Years	Collection Cost	Total Paid
30.00	0.00	30.00	0.00	0.00	0.00	30.00

Paid 116-15-00001144 07/08/2016 30.00

**2016 / 2017
MONROE COUNTY BUSINESS TAX RECEIPT
EXPIRES SEPTEMBER 30, 2017**

RECEIPT# 30140-99340

Business Name: T AND B DRILLING LLC

Owner Name: FRANK P TOPPINO, GEORGE LEONARD
Mailing Address: QUALIFIER
PO BOX 787
KEY WEST, FL 33041

Business Location: MM 9 ROCKLAND KEY
KEY WEST, FL 33040
Business Phone: 305-296-5606
Business Type: CONTRACTOR (WELL DRILLING)

Employees 5

STATE LICENSE: 2947

Tax Amount	Transfer Fee	Sub-Total	Penalty	Prior Years	Collection Cost	Total Paid
20.00	0.00	20.00	0.00	0.00	0.00	20.00

Paid 107-15-00002231 08/17/2016 20.00

THIS BECOMES A TAX RECEIPT
WHEN VALIDATED

Danise D. Henriquez, CFC, Tax Collector
PO Box 1129, Key West, FL 33041

THIS IS ONLY A TAX.
YOU MUST MEET ALL
COUNTY AND/OR
MUNICIPALITY PLANNING
AND ZONING REQUIREMENTS.

MONROE COUNTY BUSINESS TAX RECEIPT
P.O. Box 1129, Key West, FL 33041-1129
EXPIRES SEPTEMBER 30, 2017

RECEIPT# 30140-99340

Business Name: T AND B DRILLING LLC

Owner Name: FRANK P TOPPINO, GEORGE LEONARD
Mailing Address: QUALIFIER
PO BOX 787
KEY WEST, FL 33041

Business Location: MM 9 ROCKLAND KEY
KEY WEST, FL 33040
Business Phone: 305-296-5606
Business Type: CONTRACTOR (WELL DRILLING)

Employees 5

STATE LICENSE: 2947

Tax Amount	Transfer Fee	Sub-Total	Penalty	Prior Years	Collection Cost	Total Paid
20.00	0.00	20.00	0.00	0.00	0.00	20.00

Paid 107-15-00002231 08/17/2016 20.00

STATE OF FLORIDA
DEPARTMENT OF BUSINESS AND PROFESSIONAL REGULATION
CONSTRUCTION INDUSTRY LICENSING BOARD

LICENSE NUMBER	
RG0045369	

The GENERAL CONTRACTOR
Named below HAS REGISTERED
Under the provisions of Chapter 489 FS.
Expiration date: AUG 31, 2017

(INDIVIDUAL MUST MEET ALL LOCAL LICENSING
REQUIREMENTS PRIOR TO CONTRACTING IN ANY AREA)

TOPPINO, FRANK P
CHARLEY TOPPINO & SONS INC
POST OFFICE BOX 787
KEY WEST FL 33041-0787



ISSUED: 08/10/2015

DISPLAY AS REQUIRED BY LAW

SEQ # L1508100001321

CITY OF KEY WEST, FLORIDA

Business Tax Receipt

This Document is a business tax receipt

Holder must meet all City zoning and use provisions.

P.O. Box 1409, Key West, Florida 33040 (305) 809-3955

Business Name T AND B DRILLING LLC CtINbr: 0018407
Location Addr M M 9 ROCKLAND KEY
Lic NBR/Class 17-00022594 CONTRACTOR - SPEC WELL DRILLING
Issue Date: August 17, 2016 Expiration Date: September 30, 2017
License Fee \$103.00
Add. Charges \$0.00
Penalty \$0.00
Total \$103.00

Comments: LEONARD, GEORGE, QUALIFIER

KARL SICKLE, SECONDARY QUALIFIER

This document must be prominently displayed.

T AND B DRILLING LLC
P.O. BOX 787

KEY WEST FL 33041

T AND B DRILLING INC

0507 250500 Type: OC Dr
Date: 8/17/15 Receipt no: 22594
2017 LIC 001 PATIOWAL PERM
OR 1.00
Trans number: 3089753
CR CHDR 8030 \$103.00

Trans date: 8/17/15 Time: 14:19:16

CITY OF KEY WEST, FLORIDA

Business Tax Receipt

This Document is a business tax receipt
Holder must meet all City zoning and use provisions.
P.O. Box 1409, Key West, Florida 33040 (305) 809-3955

Business Name	CHARLEY TOPPINO & SONS (EDWAR)	CLINbr:0005358
Location Addr	MM 8 1/2 ROCKLAND KEY	
Lic NBR/Class	17-00017557 CONTRACTOR - REG ENGINEERING I	
Issue Date:	July 14, 2016	Expiration Date:September 30, 2017
License Fee	\$325.00	
Add. Charges	\$0.00	
Penalty	\$0.00	
Total	\$325.00	

Comments:

This document must be prominently displayed.

CHARLEY TOPPINO & SONS (EDWAR)
 EDWARD TOPPINO
 P.O. BOX 787
 KEY WEST FL 33041

CHARLEY TOPPINO & SONS, INC.

Oper: 00000000	Type: 00	Dr: 0000
Date: 2017	Receipt no: 17557	
OR	LIC OCCUPATIONAL RENEWAL	
Trans number: 67842		\$325.00
OK CHECK		3008160
		\$975.00
Trans date: 7/20/16	Time: 9:00:41	

CITY OF KEY WEST, FLORIDA

Business Tax Receipt

This Document is a business tax receipt

Holder must meet all City zoning and use provisions.

P.O. Box 1409, Key West, Florida 33040 (305) 809-3955

Business Name CHARLEY TOPPINO & S (FRANK RG) CtInbr:0005344
Location Addr 2011 FLAGLER AVE
Lic NBR/Class 17-00023997 CONTRACTOR - REG GENERAL
Issue Date: July 14, 2016 Expiration Date: September 30, 2017
License Fee \$325.00
Add. Charges \$0.00
Penalty \$0.00
Total \$325.00

Comments:

This document must be prominently displayed.

FRANK P. TOPPINO

CHARLEY TOPPINO & S (FRANK RG)

POB 787

KEY WEST FL 33041

Op: 07/16/2016 Type: CC Draw: 1
Date: 2017 Receipt no: 22594

OR LIC REGISTRATION RBXW

Trans number: 67842 \$325.00
OK CHECK \$975.00

Trans date: 7/20/16 Time: 9:00:41

CITY OF KEY WEST, FLORIDA

Business Tax Receipt

This Document is a business tax receipt

Holder must meet all City zoning and use provisions.

P.O. Box 1409, Key West, Florida 33040 (305) 809-3955

Business Name CHARLEY TOPPINO & S (FRANK ENG CTINbr:0010428
Location Addr 2011 FLAGLER AVE
Lic NBR/Class 17-00023996 CONTRACTOR - REG ENGINEERING I
Issue Date: July 14, 2016 Expiration Date: September 30, 2017
License Fee \$325.00
Add. Charges \$0.00
Penalty \$0.00
Total \$325.00

Comments:

This document must be prominently displayed.

CHARLEY TOPPINO & SONS, INC.

CHARLEY TOPPINO & S (FRANK ENG
FRANK TOPPINO
P.O. BOX 787
KEY WEST FL 33041

Trans date: 7/20/16 Time: 9:00:41
Trans number: 67842
OK 325.00



CERTIFICATE OF LIABILITY INSURANCE

DATE (MM/DD/YYYY)
03/10/2017

THIS CERTIFICATE IS ISSUED AS A MATTER OF INFORMATION ONLY AND CONFERS NO RIGHTS UPON THE CERTIFICATE HOLDER. THIS CERTIFICATE DOES NOT AFFIRMATIVELY OR NEGATIVELY AMEND, EXTEND OR ALTER THE COVERAGE AFFORDED BY THE POLICIES BELOW. THIS CERTIFICATE OF INSURANCE DOES NOT CONSTITUTE A CONTRACT BETWEEN THE ISSUING INSURER(S), AUTHORIZED REPRESENTATIVE OR PRODUCER, AND THE CERTIFICATE HOLDER.

IMPORTANT: If the certificate holder is an ADDITIONAL INSURED, the policy(ies) must be endorsed. If SUBROGATION IS WAIVED, subject to the terms and conditions of the policy, certain policies may require an endorsement. A statement on this certificate does not confer rights to the certificate holder in lieu of such endorsement(s).

PRODUCER Marsh & McLennan Agency LLC Co - Florida 9850 NW 41st Street Suite 100 Miami FL 33178	CONTACT NAME: PHONE (A/C, No, Ext): (305) 591-0090 FAX (A/C, No): (212) 948-5665	
	E-MAIL ADDRESS: INSURER(S) AFFORDING COVERAGE NAIC #	
INSURED Charley Toppino & Sons, Inc. Monroe Concrete Products Inc. P.O. Box 787 Key West FL 33041	(305) 296-5606	
	INSURER A: Travelers Indemnity Co. America 25666	
	INSURER B: Travelers Property Casualty Co. 25674	
	INSURER C: Phoenix Insurance Company 25623	
	INSURER D: INSURER E: INSURER F:	

COVERAGES **CERTIFICATE NUMBER: Cert ID 55163** **REVISION NUMBER:**

THIS IS TO CERTIFY THAT THE POLICIES OF INSURANCE LISTED BELOW HAVE BEEN ISSUED TO THE INSURED NAMED ABOVE FOR THE POLICY PERIOD INDICATED. NOTWITHSTANDING ANY REQUIREMENT, TERM OR CONDITION OF ANY CONTRACT OR OTHER DOCUMENT WITH RESPECT TO WHICH THIS CERTIFICATE MAY BE ISSUED OR MAY PERTAIN, THE INSURANCE AFFORDED BY THE POLICIES DESCRIBED HEREIN IS SUBJECT TO ALL THE TERMS, EXCLUSIONS AND CONDITIONS OF SUCH POLICIES. LIMITS SHOWN MAY HAVE BEEN REDUCED BY PAID CLAIMS.

INSR LTR	TYPE OF INSURANCE	ADDL INSD	SUBR WVD	POLICY NUMBER	POLICY EFF (MM/DD/YYYY)	POLICY EXP (MM/DD/YYYY)	LIMITS
A	<input checked="" type="checkbox"/> COMMERCIAL GENERAL LIABILITY <input type="checkbox"/> CLAIMS-MADE <input checked="" type="checkbox"/> OCCUR GEN'L AGGREGATE LIMIT APPLIES PER: <input type="checkbox"/> POLICY <input checked="" type="checkbox"/> PRO-JECT <input type="checkbox"/> LOC <input type="checkbox"/> OTHER:			DTCO3202M181TIA-16	05/19/2016	05/19/2017	EACH OCCURRENCE \$ 2,000,000 DAMAGE TO RENTED PREMISES (Ea occurrence) \$ 300,000 MED EXP (Any one person) \$ 5,000 PERSONAL & ADV INJURY \$ 2,000,000 GENERAL AGGREGATE \$ 4,000,000 PRODUCTS - COMP/OP AGG \$ 2,000,000
A	<input checked="" type="checkbox"/> AUTOMOBILE LIABILITY <input type="checkbox"/> ANY AUTO ALL OWNED AUTOS <input type="checkbox"/> SCHEDULED AUTOS NON-OWNED AUTOS <input checked="" type="checkbox"/> HIRED AUTOS <input checked="" type="checkbox"/>			DT8103202M181TCT-16	05/19/2016	05/19/2017	COMBINED SINGLE LIMIT (Ea accident) \$ 1,000,000 BODILY INJURY (Per person) \$ BODILY INJURY (Per accident) \$ PROPERTY DAMAGE (Per accident) \$
B	<input checked="" type="checkbox"/> UMBRELLA LIAB <input checked="" type="checkbox"/> OCCUR <input type="checkbox"/> EXCESS LIAB <input type="checkbox"/> CLAIMS-MADE DED <input checked="" type="checkbox"/> RETENTION \$ 10,000			DTCUP3202M181TIL-16	05/19/2016	05/19/2017	EACH OCCURRENCE \$ 10,000,000 AGGREGATE \$ 10,000,000
C	WORKERS COMPENSATION AND EMPLOYERS' LIABILITY ANY PROPRIETOR/PARTNER/EXECUTIVE OFFICER/MEMBER EXCLUDED? (Mandatory in NH) If yes, describe under DESCRIPTION OF OPERATIONS below	Y/N	N/A	DTNUB3202M1811-16	05/19/2016	05/19/2017	<input checked="" type="checkbox"/> PER STATUTE <input type="checkbox"/> OTH-ER E.L. EACH ACCIDENT \$ 1,000,000 E.L. DISEASE - EA EMPLOYEE \$ 1,000,000 E.L. DISEASE - POLICY LIMIT \$ 1,000,000
							\$
							\$

DESCRIPTION OF OPERATIONS / LOCATIONS / VEHICLES (ACORD 101, Additional Remarks Schedule, may be attached if more space is required)
RE: For bid: CITY OF KEY WEST: ROW IMPROVEMENT 2017, CITY PRJ # ITB 017-17
PROOF OF INSURANCE ONLY

CERTIFICATE HOLDER
CITY OF KEY WEST
3132 FLAGLER AVE
Key West FL 33040
CANCELLATION

SHOULD ANY OF THE ABOVE DESCRIBED POLICIES BE CANCELLED BEFORE THE EXPIRATION DATE THEREOF, NOTICE WILL BE DELIVERED IN ACCORDANCE WITH THE POLICY PROVISIONS.

AUTHORIZED REPRESENTATIVE



THE CITY OF KEY WEST

Post Office Box 1409 Key West, FL 33041-1409 (305) 809-3883

ADDENDUM NO. 1

RIGHT OF WAY IMPROVEMENTS / ITB 17-017

March 8, 2017

This addendum is issued as supplemental information to the bid package for clarification of certain matters of both a general and a technical nature. The referenced Invitation to Bid (ITB) package is hereby amended in accordance with the following items:

Pre-Bid Request for Information:

- 1.) Upon reviewing the bid proposal form for the ROW improvements 2017 project, I noticed that the "mobilization/demobilization" line is filled in at \$5,000.00 EA (per work order). This could be an issue, as for larger work orders (above 50K) would require much more than 5K in mobilization. Especially if there is milling/asphalt paving involved, which requires a substantial mobilization cost. The maintenance of traffic item also would be rolled into "mobilization/demobilization"..
We recommend that this be adjusted to a percentage of the overall work-order amount (10-12%), as done in the past. The mobilization percentage would be tabulated based on the base bid total.
The same scenario applies to smaller projects. If the work-order is below 10K, than a 5K mobilization would be too much.

Response: There is no change to bid item 0101-1

FDOT Item Number	Item Description	Quantity & Unit	Unit Price	Total Extended Price
0101-1	Mobilization/Demobilization per Work Order	1 per Each	\$5,000.00	\$5000.00

All Bidders shall acknowledge receipt and acceptance of this Addendum No. 1 with Attachment by submitting the addendum with their proposal. Proposals submitted without acknowledgement or without this Addendum may be considered non-responsive.

CHARLEY TOPPINO & SONS, INC.

Signature

Name of Business



THE CITY OF KEY WEST

Post Office Box 1409 Key West, FL 33041-1409 (305) 809-3883

ADDENDUM NO. 2

RIGHT OF WAY IMPROVEMENTS / ITB 17-017

March 15, 2017

This addendum is issued as supplemental information to the bid package for clarification of certain matters of both a general and a technical nature. The referenced Invitation to Bid (ITB) package is hereby amended in accordance with the following items:

Pre-Bid Request for Information:

1.) The 4" sidewalk quantity/unit of measurement on the bid proposal form is "20,000 SY" which is a huge number compared to years past. Is this supposed to be 20,000 SF?

Response: Please see changes to bid items 0522-1 & 0522-2 below

FDOT Item Number	Item Description	Quantity & Unit	Unit Price	Total Extended Price
0522-1	Concrete Sidewalks, 4" thickness	2,000 SY	\$ _____	\$ _____
0522-2	Concrete Sidewalks and Driveways, 6" thickness	1,000 SY	\$ _____	\$ _____

The BID OPENING has been extended to March 22,2017 at 3:30 p.m.

All Bidders shall acknowledge receipt and acceptance of this Addendum No. 2 with Attachment by submitting the addendum with their proposal. Proposals submitted without acknowledgement or without this Addendum may be considered non-responsive.

CHARLEY TOPPINO & SONS, INC.

Signature

Name of Business



THE CITY OF KEY WEST

Post Office Box 1409 Key West, FL 33041-1409 (305) 809-3883

ADDENDUM NO. 3

RIGHT OF WAY IMPROVEMENTS / ITB 17-017

March 16, 2017

This addendum is issued as supplemental information to the bid package for clarification of certain matters of both a general and a technical nature. The referenced Invitation to Bid (ITB) package is hereby amended in accordance with the following items:

PLEASE REMOVE AND REPLACE BID PROPOSAL FORM WITH ATTACHED.

All Bidders shall acknowledge receipt and acceptance of this Addendum No. 3 with Attachment by submitting the addendum with their proposal. Proposals submitted without acknowledgement or without this Addendum may be considered non-responsive.



CHARLEY TOPPINO & SONS, INC.

Signature

Name of Business

REVISION 1

BID PROPOSAL FORM

FDOT Item Number	Item Description	Quantity & Unit	Unit Price	Total Extended Price
0101-1	Mobilization/Demobilization per Work Order	1 per Each	\$5,000.00	\$5000.00
0210-1-1	Reworking Limerock Base (up to 6" thickness)	3,000 SY	\$ _____	\$ _____
0230-1	Limerock Stabilized base (12" thickness at 98% of T-180)	3,800 SY	\$ _____	\$ _____
0327-70-5	Asphalt Milling (2 inch average thickness, includes disposal)	20,000 SY	\$ _____	\$ _____
0334-1-13	Superpave Asphalt Leveling Course SP-12.5 (1.5" Thickness - Overlay) (Traffic Level C)	3,000 Ton	\$ _____	\$ _____
0337-7-54	Asphalt Friction Course FC-9.5 (0.5" Thickness) (Traffic Level C)	1,000 Ton	\$ _____	\$ _____
0425-3-50	Manholes, (Raise/Lower)	10 Each	\$ _____	\$ _____
0425-6	Valve/Meter Box, Adjustment	200 Each	\$ _____	\$ _____
0425-7	Manhole Cover – Replacement	10 Each	\$ _____	\$ _____
0425-8	Drainage Structures – Miscellaneous Adjustment	20 Each	\$ _____	\$ _____
0520-1-10	Concrete Curb and Gutter, Type "F"	1,000 LF	\$ _____	\$ _____
0520-2-4	Concrete Curb, Type "D"	1,000 LF	\$ _____	\$ _____
0522-1	Concrete Sidewalks, 4" thickness	2,000 SY	\$ _____	\$ _____
0522-2	Concrete Sidewalks and Driveways, 6" thickness	1,000 SY	\$ _____	\$ _____
0527-2	Detectable Warnings (Endicott ADA Truncated Domes or equal)	4,000 S.F.	\$ _____	\$ _____
0570-1-2	Performance Turf, Sod	450 SY	\$ _____	\$ _____
0706-3	Retro-reflective Pavement Markers	200 Each	\$ _____	\$ _____
0710-11111	Painted Pavement Markings (Standard, White, Solid, 6")	500 LF	\$ _____	\$ _____

FDOT Item Number	Item Description	Quantity & Unit	Unit Price	Total Extended Price
0711-11121	Thermoplastic (70 Mil, White, Solid, 6")	3,000 LF	\$ _____	\$ _____
0711-11123	Thermoplastic (70 Mil, White, Solid, 12")	500 LF	\$ _____	\$ _____
0711-11124	Thermoplastic (70 Mil, White, Solid, 18")	200 LF	\$ _____	\$ _____
0711-11125	Thermoplastic (70 Mil, White, Solid, 24")	500 LF	\$ _____	\$ _____
0711-11160	Thermoplastic (70 Mil, White, Message) RESIDENTIAL PARKING	100 Each	\$ _____	\$ _____
0711-11170	Thermoplastic (70 Mil, White, Arrow)	10 Each	\$ _____	\$ _____
0710-11211	Painted Pavement Markings (Standard, Yellow, Solid, 6")	4,000 LF	\$ _____	\$ _____
0711-11221	Thermoplastic (70 Mil, Yellow, Solid, 6")	3,000 LF	\$ _____	\$ _____
0711-11223	Thermoplastic (70 Mil, Yellow, Solid, 12")	200 LF	\$ _____	\$ _____
0711-11224	Thermoplastic (70 Mil, Yellow, Solid, 18")	200 LF	\$ _____	\$ _____
0711-11421	Thermoplastic (70 Mil, Blue, Solid, 6")	500 LF	\$ _____	\$ _____
0710-11421	Painted Pavement Markings (Standard, Blue, Solid, 6")	500 LF	\$ _____	\$ _____
0711-11460	Thermoplastic (70 Mil, Blue, Handicap Symbol)	15 Each	\$ _____	\$ _____
1080-11201	Utility Fixtures, 2" - 4.9", Furnish and Install, Valve/Meter Box	20 Each	\$ _____	\$ _____
1080-15	Utility Fixtures, Adjust and Modify	10 Each	\$ _____	\$ _____
NS-1	New Single Post and New Sign (includes existing sign/post removal, 3" dia. Alum. Post, brackets, concrete footer and installation)	20 Each	\$ _____	\$ _____
NS-2	Single Sign Post (includes existing post removal, 3" dia. Alum. Post, brackets, concrete footer and installation, reuse existing sign)	20 Each	\$ _____	\$ _____
NS-3	Concrete Curb Thickened Edge	1,000 LF	\$ _____	\$ _____

FDOT Item Number	Item Description	Quantity & Unit	Unit Price	Total Extended Price
NS-4	Shoulder Restoration (includes all equipment, labor, material (FDOT Certified Washed Miami No. 57 Stone) and clean-up/dust control)	20,000 SY	\$ _____	\$ _____
NS-5	Seepage Trench	500 LF	\$ _____	\$ _____
NS-6	Failed Trench Restoration	1,000 SY	\$ _____	\$ _____

SUBTOTAL OF EXTENDED AMOUNTS

_____ \$ _____
TOTAL IN WORDS TOTAL IN FIGURES

NS-7	Performance and Payment Bonds (based upon Subtotal Extended Amounts = \$ _____) To Be Paid on a Per Work Order Basis	Per \$1,000	\$ _____	\$ _____
------	---	-------------	----------	----------

TOTAL OF BASE BID ITEMS

_____ \$ _____
TOTAL IN WORDS TOTAL IN FIGURES

Company Name

Authorized Signature

Title

PART 2: CONTRACT DOCUMENTS

CONTRACT

This Contract, made and entered into this 11 day of April, 2017, by and between the City of Key West, hereinafter called the "Owner", and Charley Toppino & Sons, Inc. hereinafter called the "Contractor";

WITNESSETH:

The Contractor, in consideration of the sum to be paid him by the Owner and of the covenants and agreements herein contained, hereby agrees at his own Proper cost and expense to do all the work and furnish all the materials, tools, labor, and all appliances, machinery, and appurtenances necessary for installation, repair and replacement of sidewalks, curbs, ADA ramps, roadways, shoulder and trench restoration and any scope assigned by the City located throughout the City of Key West, FL, to the extent of the Bid made by the Contractor, dated the 15 day of March, 2017, all in full compliance with the Contract Documents referred to herein:

INVITATION TO BID, INSTRUCTIONS TO BIDDER, PROPOSAL, PERFORMANCE AND PAYMENT BONDS, CONTRACT FORMS, CONDITIONS OF THE CONTRACT, SPECIFICATIONS, DRAWINGS AND ADDENDA, which consists of RIGHT OF WAY IMPROVEMENTS 2017, ITB 17-017 are hereby referred to and by reference made a part of this Contract as fully and completely as if the same were fully set forth herein and are mutually cooperative therewith.

In consideration of the performance of the work as set forth in these Contract Documents, the Owner agrees to pay to the Contractor the amount bid in the Bid as adjusted in accordance with the Contract Documents, or as otherwise herein provided, and to make such payments in the manner and at the times provided in the Contract Documents.

The Contractor agrees to complete the work within the time specified in the Work Orders and to accept as full payment hereunder the amounts computed as determined by the Contract Documents and based on the said Bid.

The Contractor agrees to remedy all defects appearing in the work or developing in the materials furnished and the workmanship performed under this Contract during the warranty period after the date of final acceptance of the work by the Owner, and further agrees to indemnify and save the Owner harmless from any costs encountered in remedying such defects.

It is agreed that the Contract, based upon the Bid, shall be fully complete within the stated number of consecutive calendar days from the date the Notice to Proceed is issued, for each Work Order.

In the event that the Contractor shall fail to complete the work within the time limit established in a specific work order or the extended time limit agreed upon, as more particularly set forth in the Contract Documents, liquidated damages shall be paid at the rate of \$500 per day. Sundays and legal holidays shall be included in determining days in default.

This Contract will automatically expire and be terminated two (2) year after the date of the execution of the Contract by the Owner, unless Owner grants a one-year contract extension at the discretion of the City.

IN WITNESS WHEREOF, we, the parties hereto, each herewith subscribe the same, this 11 day of April, 2017.

CITY OF KEY WEST, FLORIDA

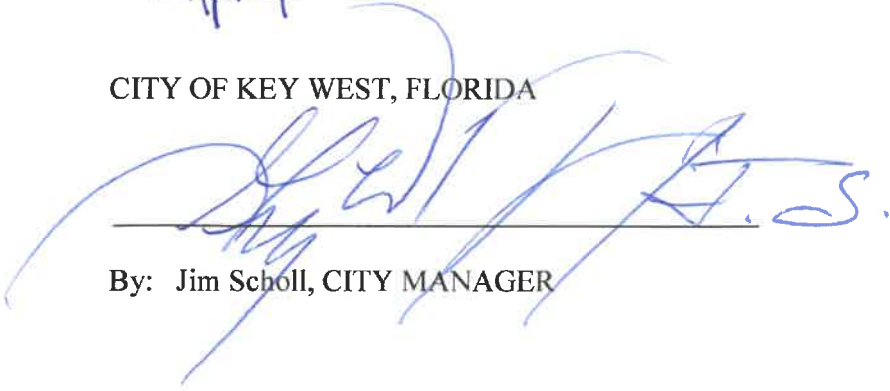

By: Jim Scholl, CITY MANAGER

CHARLEY TOPPINO & SONS, INC.

Contractor: _____

By: Frank P. Toppino

Title: PRESIDENT

3. Pays CITY all losses, costs, expenses, damages, attorney's fees, including appellate proceedings, injury or loss of whatever kind and however arising including, without limitation, delay damages to which said CITY may be subject by reason of any wrongdoing, misconduct, want of care or skill, negligence, failure of performance, breach, failure to petition within the prescribed time, or default, including patent infringements, on the part of said CONTRACTOR, his agents or employees, in the execution or performance of said Contract; and

4. Performs the guarantee of all work and materials furnished under the contract for the time specified in the contract, then this obligation shall be void; otherwise, to remain in full force and effect for the term of said Contract.

AND, the said Surety for value received, hereby stipulates and agrees that no change involving any extension of time, or addition to the terms of the Contract Documents, or to the work to be performed, or materials to be furnished there under shall affect said obligation of said Surety on this Bond, and the said Surety does hereby waive notice of any such changes, extension of time, alterations, or additions of the terms of the Contract Documents, or to the work.

Any action instituted by a claimant under this bond for payment must be in accordance with the notice and time limitation provisions in Section 255.05(2), Florida Statutes.

10th IN WITNESS WHEREOF, the above parties bonded together have executed this instrument this day of April, 2017, the name and corporate seal of each corporate party being hereto affixed and those presents duly signed by its undersigned representative, pursuant to authority of its governing body.

CONTRACTOR

Charley Toppino & Sons, Inc.

By: Charley R. Toppino (Seal)

Asy Pettin

Travelers Casualty and Surety Company of America
SURETY

By William L. Parker (Seal)

William L. Parker, Attorney in Fact & FL Res Agent

William L. Parker

Attest

FLORIDA PAYMENT BOND

BOND NO. 106540154

AMOUNT: \$ 250,000.00

KNOW ALL MEN BY THESE PRESENTS, that in accordance with Florida Statutes Section 255.05, Charley Toppino & Sons, Inc

with offices at 8 1/2 Rockland Key, Key West, FL 33040

hereinafter called the CONTRACTOR, (Principal), and

Travelers Casualty and Surety Company of America

with offices at One Tower Square, Hartford, CT06183

a corporation duly organized and existing under and by virtue of the laws of the State of CT, hereinafter called the SURETY, and authorized to transact business within the State of Florida, as SURETY, are held and firmly bound CITY OF KEY WEST,

represented by its _____, hereinafter called the City (Obligee), in the sum of:

Two Hundred Fifty Thousand and 00/100 DOLLARS (\$250,000.00), lawful money of the United States of America, for the payment of which, well and truly be made to the CITY, and the CONTRACTOR and the SURETY bind themselves and each of their heirs, executors, administrators, successors, and assigns, jointly and severally, firmly by these presents as follows:

THE CONDITION OF THE ABOVE OBLIGATION IS SUCH THAT:

WHEREAS, the CONTRACTOR has executed and entered into a certain Contract for

RIGHT OF WAY IMPROVEMENTS 2017

attached hereto, with the CITY, dated _____, 2015, to furnish at his own cost, charges, and expense the necessary materials, equipment, and/or labor in strict and express accordance with said Contract and the plans, drawings (if any), and specifications prepared by the CITY, all of which is made a part of said Contract by certain terms and conditions in said Contract more particularly mentioned, which Contract, consisting of the various Contract Documents specifically mentioned herein and relative hereto, is made a part of this Bond as fully and completely as if said Contract Documents were set forth herein.

NOW THEREFORE, the conditions of this obligation are such that if the above bounden CONTRACTOR shall in all respects comply with the terms and conditions of said Contract and his obligation thereunder, including the Contract Documents (which include the permit form, coral relocation plan, the specifications, and conditions prepared by the CITY, invitation to bid, instructions to bidders, the CONTRACTOR'S bid as accepted by the CITY, the bid and contract and payment bonds, and all addenda, if any, issued prior to

the opening of bids), and further that if said CONTRACTOR shall promptly make payments to all persons supplying materials, equipment, and/or labor, used directly or indirectly by said CONTRACTOR or SUBCONTRACTORS in the prosecution of the work for said contract in accordance with Florida Statutes, Section 255.05 or Section 713.23, then this obligation shall be void; otherwise to remain in full force and effect for the term of said contract, including and all guarantee periods as specifically mentioned in said Contract Documents.

AND, the said SURETY for value received, hereby stipulates and agrees that no change involving any extension of time, or addition to the terms of the Contract or to the work to be performed, or materials to be furnished thereunder, or in the Contract Documents and specifications accompanying the said contract shall affect said obligation of said SURETY on this Bond, and the said SURETY does hereby waive notice of any such changes, extension of time, alternations, or additions of the terms of the Contract, or to the work, to the Contract Documents, or to the specifications.

Claimant shall give written notice to the CONTRACTOR and the SURETY as required by Section 255.05 or Section 713.23, Florida Statutes. Any action instituted against the CONTRACTOR or SURETY under this bond for payment must be in accordance with the notice and time limitation provisions in Section 255.05(2) or Section 713.23, Florida Statutes.

IN WITNESS WHEREOF, the above parties bounded together have executed this instrument this 10th day of April, 2017, the name and corporate seal of each corporate party being hereto affixed and those presents duly signed by its undersigned representative, pursuant to authority of its governing body.

CONTRACTOR

Charley Toppino & Sons, Inc.

By: Frank P. Toppino (Seal)

Ady Patri

Travelers Casualty and Surety Company of America
SURETY

By: William L. Parker (Seal)

William L. Parker, Attorney in Fact & FL Res Agent

William L. Parker
Attest

This bond is given to comply with section 255.05 Florida Statutes, and any action instituted by a claimant under this bond for payment must be in accordance with the notice and time limitation provisions in Section 255.05 (2), Florida Statutes



POWER OF ATTORNEY

Farmington Casualty Company
Fidelity and Guaranty Insurance Company
Fidelity and Guaranty Insurance Underwriters, Inc.
St. Paul Fire and Marine Insurance Company
St. Paul Guardian Insurance Company

St. Paul Mercury Insurance Company
Travelers Casualty and Surety Company
Travelers Casualty and Surety Company of America
United States Fidelity and Guaranty Company

Attorney-In Fact No. 230629

Certificate No. 006719184

KNOW ALL MEN BY THESE PRESENTS: That Farmington Casualty Company, St. Paul Fire and Marine Insurance Company, St. Paul Guardian Insurance Company, St. Paul Mercury Insurance Company, Travelers Casualty and Surety Company, Travelers Casualty and Surety Company of America, and United States Fidelity and Guaranty Company are corporations duly organized under the laws of the State of Connecticut, that Fidelity and Guaranty Insurance Company is a corporation duly organized under the laws of the State of Iowa, and that Fidelity and Guaranty Insurance Underwriters, Inc., is a corporation duly organized under the laws of the State of Wisconsin (herein collectively called the "Companies"), and that the Companies do hereby make, constitute and appoint

William L. Parker, Davor I. Mimica, Ileana M. Bauza, William Frederick Kleis, and Eduardo A. Menendez

of the City of Miami, State of Florida, their true and lawful Attorney(s)-in-Fact, each in their separate capacity if more than one is named above, to sign, execute, seal and acknowledge any and all bonds, recognizances, conditional undertakings and other writings obligatory in the nature thereof on behalf of the Companies in their business of guaranteeing the fidelity of persons, guaranteeing the performance of contracts and executing or guaranteeing bonds and undertakings required or permitted in any actions or proceedings allowed by law.

IN WITNESS WHEREOF, the Companies have caused this instrument to be signed and their corporate seals to be hereto affixed, this 25th day of March, 2016.

Farmington Casualty Company
Fidelity and Guaranty Insurance Company
Fidelity and Guaranty Insurance Underwriters, Inc.
St. Paul Fire and Marine Insurance Company
St. Paul Guardian Insurance Company

St. Paul Mercury Insurance Company
Travelers Casualty and Surety Company
Travelers Casualty and Surety Company of America
United States Fidelity and Guaranty Company



State of Connecticut
City of Hartford ss.

By: [Signature]
Robert L. Raney, Senior Vice President

On this the 25th day of March, 2016, before me personally appeared Robert L. Raney, who acknowledged himself to be the Senior Vice President of Farmington Casualty Company, Fidelity and Guaranty Insurance Company, Fidelity and Guaranty Insurance Underwriters, Inc., St. Paul Fire and Marine Insurance Company, St. Paul Guardian Insurance Company, St. Paul Mercury Insurance Company, Travelers Casualty and Surety Company, Travelers Casualty and Surety Company of America, and United States Fidelity and Guaranty Company, and that he, as such, being authorized so to do, executed the foregoing instrument for the purposes therein contained by signing on behalf of the corporations by himself as a duly authorized officer.

In Witness Whereof, I hereunto set my hand and official seal. My Commission expires the 30th day of June, 2016.



[Signature]
Marie C. Tetreault, Notary Public

This Power of Attorney is granted under and by the authority of the following resolutions adopted by the Boards of Directors of Farmington Casualty Company, Fidelity and Guaranty Insurance Company, Fidelity and Guaranty Insurance Underwriters, Inc., St. Paul Fire and Marine Insurance Company, St. Paul Guardian Insurance Company, St. Paul Mercury Insurance Company, Travelers Casualty and Surety Company, Travelers Casualty and Surety Company of America, and United States Fidelity and Guaranty Company, which resolutions are now in full force and effect, reading as follows:

RESOLVED, that the Chairman, the President, any Vice Chairman, any Executive Vice President, any Senior Vice President, any Vice President, any Second Vice President, the Treasurer, any Assistant Treasurer, the Corporate Secretary or any Assistant Secretary may appoint Attorneys-in-Fact and Agents to act for and on behalf of the Company and may give such appointee such authority as his or her certificate of authority may prescribe to sign with the Company's name and seal with the Company's seal bonds, recognizances, contracts of indemnity, and other writings obligatory in the nature of a bond, recognizance, or conditional undertaking, and any of said officers or the Board of Directors at any time may remove any such appointee and revoke the power given him or her; and it is

FURTHER RESOLVED, that the Chairman, the President, any Vice Chairman, any Executive Vice President, any Senior Vice President or any Vice President may delegate all or any part of the foregoing authority to one or more officers or employees of this Company, provided that each such delegation is in writing and a copy thereof is filed in the office of the Secretary; and it is

FURTHER RESOLVED, that any bond, recognizance, contract of indemnity, or writing obligatory in the nature of a bond, recognizance, or conditional undertaking shall be valid and binding upon the Company when (a) signed by the President, any Vice Chairman, any Executive Vice President, any Senior Vice President or any Vice President, any Second Vice President, the Treasurer, any Assistant Treasurer, the Corporate Secretary or any Assistant Secretary and duly attested and sealed with the Company's seal by a Secretary or Assistant Secretary; or (b) duly executed (under seal, if required) by one or more Attorneys-in-Fact and Agents pursuant to the power prescribed in his or her certificate or their certificates of authority or by one or more Company officers pursuant to a written delegation of authority; and it is

FURTHER RESOLVED, that the signature of each of the following officers: President, any Executive Vice President, any Senior Vice President, any Vice President, any Assistant Vice President, any Secretary, any Assistant Secretary, and the seal of the Company may be affixed by facsimile to any Power of Attorney or to any certificate relating thereto appointing Resident Vice Presidents, Resident Assistant Secretaries or Attorneys-in-Fact for purposes only of executing and attesting bonds and undertakings and other writings obligatory in the nature thereof, and any such Power of Attorney or certificate bearing such facsimile signature or facsimile seal shall be valid and binding upon the Company and any such power so executed and certified by such facsimile signature and facsimile seal shall be valid and binding on the Company in the future with respect to any bond or understanding to which it is attached.

I, Kevin E. Hughes, the undersigned, Assistant Secretary, of Farmington Casualty Company, Fidelity and Guaranty Insurance Company, Fidelity and Guaranty Insurance Underwriters, Inc., St. Paul Fire and Marine Insurance Company, St. Paul Guardian Insurance Company, St. Paul Mercury Insurance Company, Travelers Casualty and Surety Company, Travelers Casualty and Surety Company of America, and United States Fidelity and Guaranty Company do hereby certify that the above and foregoing is a true and correct copy of the Power of Attorney executed by said Companies, which is in full force and effect and has not been revoked.

IN TESTIMONY WHEREOF, I have hereunto set my hand and affixed the seals of said Companies this 10th day of April, 2017.

Kevin E. Hughes, Assistant Secretary



To verify the authenticity of this Power of Attorney, call 1-800-421-3880 or contact us at www.travelersbond.com. Please refer to the Attorney-In-Fact number, the above-named individuals and the details of the bond to which the power is attached.

PART 3: CONDITIONS OF THE CONTRACT

GENERAL CONDITIONS

DEFINITIONS

1. AS APPROVED
2. AS SHOWN, AND AS INDICATED
3. BIDDER
4. CONTRACT DOCUMENTS
5. CONTRACTOR
6. CONTRACT COMPLETION
7. DAYS
8. DRAWINGS
9. ENGINEER
10. NOTICE
11. OR EQUAL
12. OWNER
13. PLANS
14. SPECIFICATIONS
15. NOTICE TO PROCEED
16. SUBSTANTIAL COMPLETION
17. WORK

CONTRACT DOCUMENTS

18. INTENT OF CONTRACT DOCUMENTS
19. DISCREPANCIES AND OMISSIONS
20. CHANGES IN THE WORK
21. EXAMINATION AND VERIFICATION OF CONTRACT DOCUMENTS
22. DOCUMENTS TO BE KEPT ON THE JOBSITE
23. ADDITIONAL CONTRACT DOCUMENTS
24. OWNERSHIP OF CONTRACT DOCUMENTS

THE ENGINEER

25. AUTHORITY OF THE ENGINEER
26. DUTIES AND RESPONSIBILITIES OF THE ENGINEER
27. LIMITATIONS ON ENGINEER'S RESPONSIBILITIES
28. REJECTED WORK
29. LINES AND GRADES
30. SUBMITTALS
31. DETAIL DRAWINGS AND INSTRUCTIONS

THE CONTRACTOR AND HIS EMPLOYEES

32. CONTRACTOR, AN INDEPENDENT AGENT
 - A. ASSIGNMENT OF CONTRACT
33. SUBCONTRACTING
34. INSURANCE AND LIABILITY
 - A. GENERAL
 - B. CONTRACTOR AND SUB-CONTRACTOR INSURANCE
 - C. COMPENSATION AND EMPLOYER'S LIABILITY INSURANCE
 - D. GENERAL LIABILITY INSURANCE (INCLUDING AUTOMOBILE)
 - E. BUILDER'S RISK ALL RISK INSURANCE
 - F. NO PERSONAL LIABILITY OF PUBLIC OFFICIALS
35. INDEMNITY
36. EXCLUSION OF CONTRACTOR CLAIMS
37. TAXES AND CHARGES
38. REQUIREMENTS OF STATE LAW FOR PUBLIC WORKS PROJECTS
39. CODES, ORDINANCES, PERMITS, AND LICENSES
40. SUPERINTENDENCE
41. RECEPTION OF ENGINEER'S COMMUNICATIONS

42. SAFETY
43. PROTECTION OF WORK AND PROPERTY
44. RESPONSIBILITY OF CONTRACTOR TO ACT IN AN EMERGENCY
45. MATERIALS AND APPLIANCES
46. CONTRACTORS' AND MANUFACTURERS' COMPLIANCE WITH STATE SAFETY, OSHA,
AND OTHER CODE REQUIREMENTS
47. SUBSTITUTION OF MATERIALS
48. TESTS, SAMPLES, AND OBSERVATIONS
49. ROYALTIES AND PATENT
50. CONTRACTOR'S RIGHT TO TERMINATE CONTRACT
51. CORRECTION OF DEFECTIVE WORK DURING WARRANTY PERIOD

PROGRESS OF THE WORK

52. BEGINNING OF THE WORK
53. SCHEDULES AND PROGRESS REPORTS
54. PROSECUTION OF THE WORK
55. OWNER'S RIGHT TO RETAIN IMPERFECT WORK
56. OWNER'S RIGHT TO DO WORK
57. OWNER'S RIGHT TO TRANSFER EMPLOYMENT
58. DELAYS AND EXTENSION OF TIME
59. DIFFERING SITE CONDITION
60. LIQUIDATED DAMAGES
61. OTHER CONTRACTS
62. USE OF PREMISES
63. SUBSTANTIAL COMPLETION DATE
64. PERFORMANCE TESTING
65. OWNER'S USE OF PORTION OF THE WORK
66. CUTTING AND PATCHING
67. CLEANING UP

PAYMENT

68. PAYMENT FOR CHANGE ORDERS
 - A. UNIT PRICE
 - B. LUMP SUM
 - C. COST REIMBURSEMENT WORK
69. PARTIAL PAYMENTS
 - A. GENERAL
 - B. ESTIMATE
 - C. DEDUCTION FROM ESTIMATE
 - D. QUALIFICATIONS FOR PARTIAL PAYMENT FOR MATERIALS DELIVERED
 - E. PAYMENT
70. CLAIMS FOR EXTRA WORK
71. RELEASE OF LIENS OR CLAIMS
72. FINAL PAYMENT
73. NO WAIVER OF RIGHTS
74. ACCEPTANCE OF FINAL PAYMENT CONSTITUTES RELEASE

DEFINITIONS

Whenever in the Contract Documents the following terms are used, the intent and meaning shall be interpreted as follows:

1. AS APPROVED

The words "as approved", unless otherwise qualified, shall be understood to be followed by the words "by the Engineer for conformance with the Contract Document".

2. AS SHOWN, AND AS INDICATED

The words "as shown" and "as Indicated" shall be understood to be followed by the words "on the Drawings".

3. BIDDER

The person or persons, partnership, firm, or corporation submitting a Bid for the work contemplated.

4. CONTRACT DOCUMENTS

The "Contract Documents" consist of the Bidding Requirements, Contract Forms, Conditions of the Contract, Specifications, Drawings, all modifications thereof incorporated into the Documents before their execution, Change Orders, and all other requirements incorporated by specific reference thereto. These form the Contract.

5. CONTRACTOR

The person or persons, partnership, firm, or corporation who enters into the Contract awarded him by the Owner.

6. CONTRACT COMPLETION

The "Contract Completion" is the date the Owner accepts the entire work as being in compliance with the Contract Documents, or formally waives nonconforming work to extent of nonconformity, and issues the final payment in accordance with the requirements set forth in Article, "Final Payment" of these General Conditions.

7. DAYS

Unless otherwise specifically stated, the term "days" will be understood to mean calendar days. Business day or working day means any day other than Saturday, Sunday, or legal holiday.

8. DRAWINGS

The term "Drawings" refers to the official Drawings, Profiles, cross sections, elevations, details, and other working drawings and supplementary drawings, or reproductions thereof, signed by the Engineer, which shows the location, character, dimensions, and details of the work to be performed. Drawings may either be bound in the same book as the balance of the Contract Documents, or bound in separate sets, and are a part of the Contract Documents, regardless of the method of binding.

9. ENGINEER

The person or organization identified as such in the Contract Documents. The Term "Engineer" means Engineer or his authorized representative.

10. NOTICE

The term "notice" or the requirement to notify, as used in the Contract Documents or applicable state or federal statutes, shall signify a written communication delivered in person or by registered mail to the individual, or to a member of the firm, or to an officer of the corporation for whom it is intended. Certified or registered mail shall be addressed to the last business address known to him who gives the notice.

11. OR EQUAL

The term "or equal" shall be understood to indicate that the "equal" Product is equivalent to or better than the Product named in function, performance, reliability, quality, and general configuration. Determination of equality in reference to the Project design requirements will be made by the Engineer. Such equal Products shall not be purchased or installed by the Contractor without written authorization.

12. OWNER

The person, organization, or public body identified as such in the Contract Documents.

13. PLANS (See Drawings)

14. SPECIFICATIONS

The term "Specifications" refers to those portions of the Contract Documents consisting of written technical descriptions of materials, equipment, construction systems, standards, and workmanship as applied to the work and certain administrative details applicable thereto. Where standard specifications, such as those of ASTM, AASHTO, etc., have been referred to, the applicable portions of such standard specifications shall become a part of these Contract Documents. If referenced specifications conflict with specifications contained herein, the requirements contained herein shall prevail.

15. NOTICE TO PROCEED

A written notice given by the Owner to the Contractor (with a copy to the Engineer) fixing the date on which the Contract time will commence to run and on which the Contractor shall start to perform his obligation under the Contract Documents. The Notice to Proceed will be given within 30 days following the execution of the Contract by the Owner.

16. SUBSTANTIAL COMPLETION

"Substantial Completion" shall be that degree of completion of the Project or a defined portion of the Project, as evidenced by the Engineer's written notice of Substantial Completion, sufficient to Provide the Owner, at his discretion, the full-time use of the Project or defined portion of the Project for the purposes for which it was intended. "Substantial Completion" of an operating facility shall be that degree of completion that has Provided a minimum of 7 continuous days of successful, trouble-free, operation, which period shall begin after all performance and acceptance testing has been successfully demonstrated to the Engineer. All equipment contained in the work, plus all other components necessary to enable the Owner to operate the facility in a manner that was intended, shall be complete on the substantial completion date.

17. WORK

The word "work" within these Contract Documents shall include all material, labor, tools, and all appliances, machinery, transportation, and appurtenances necessary to perform and complete the Contract, and such additional items not specifically indicated or described which can be reasonably inferred as belonging to the item described or indicated and as required by good Practice to Provide a complete and satisfactory system or structure. As used herein, "Provide" shall be understood to mean "furnish and install, complete in-place".

CONTRACT DOCUMENTS

18. INTENT OF CONTRACT DOCUMENTS

The Contract Documents are complementary, and what is called for by one shall be as binding as if called for by all. The intent of the Documents is to describe a functionally complete Project (or part thereof) to be constructed in accordance with the Contract Documents. Any work, materials, or equipment that may reasonably be inferred from the Contract Documents as being required to produce the intended result shall be supplied whether or not specifically called for. When words which have a well-known technical or trade meaning are used to describe work, materials, or equipment, such words shall be interpreted in accordance with that meaning.

Reference to standard specifications, manuals, or codes of any technical society, organization or association, or to the laws or

regulations of any governmental authority, whether such reference be specific or by implication, shall mean the latest standard specification, manual, code or laws or regulations in effect on the first published date of the Invitation to Bid, except as may be otherwise specifically stated. However, no Provision of any referenced standard specification, manual or code (whether or not specifically incorporated by reference in the Contract Documents) shall be effective to change the duties and responsibilities of Owner, Contractor, or Engineer, or any of their consultants, agents, or employees from those set forth in the Contract Documents, nor shall it be effective to assign to Engineer, or any Engineer's consultants, agents, or employees, any duty or authority to supervise or direct the furnishing or performance of the work or any duty or authority to undertake responsibility contrary to the Provisions of Article LIMITATIONS ON ENGINEER'S RESPONSIBILITIES.

19. DISCREPANCIES AND OMISSIONS

Any discrepancies or omissions found in the Contract Documents shall be reported to the Engineer immediately. The Engineer will clarify discrepancies or omissions, in writing, within a reasonable time.

In resolving inconsistencies among two or more sections of the Contract Documents, Precedence shall be given in the following order:

- A. CONTRACT
- B. BID
- C. SUPPLEMENTARY CONDITIONS
- D. INVITATION TO BID
- E. INSTRUCTIONS TO BIDDERS
- F. GENERAL CONDITIONS
- G. SPECIFICATIONS
- H. DRAWINGS

Addenda shall take Precedence over all sections referenced therein. Figure dimensions on Drawings shall take Precedence over scale dimensions. Detailed Drawings shall take Precedence over general Drawings.

20. CHANGES IN THE WORK

The Owner, without notice to the Sureties and without invalidating the Contract, may order changes in the work within the general scope of the Contract by altering, adding to, or deducting from the work, the Contract being adjusted accordingly. All such work shall be executed under the conditions of the original Contract, except as specifically adjusted at the time of ordering such change.

In giving instructions, the Engineer may order minor changes in the work not involving extra cost and not inconsistent with the purposes of the Project, but otherwise, except in an emergency endangering life and Property, additions or deductions from the work shall be performed only in pursuance of an approved Change Order from the Owner, countersigned by the Engineer.

If the work is reduced by alterations, such action shall not constitute a claim for damages based on loss of anticipated Profits.

21. EXAMINATION AND VERIFICATION OF CONTRACT DOCUMENTS

The Contractor shall thoroughly examine and become familiar with all of the various parts of these Contract Documents and determine the nature and location of the work, the general and local conditions, and all other matters, which can in any way affect the work under this Contract. Failure to make an examination necessary for this determination shall not release the Contractor from the obligations of this Contract. No verbal agreement or conversation with any officer, agent, or employee of the Owner, or with the Engineer either before or after the execution of this Contract shall affect or modify any of the terms or obligations herein contained.

22. DOCUMENTS TO BE KEPT ON THE JOBSITE

The Contractor shall keep one copy of the Contract Documents on the job- site, in good order, available to the Engineer and to his representatives.

The Contractor shall maintain on a daily basis at the jobsite, and make available to the Engineer on request, one current record set

of the Drawings which have been accurately marked to indicate all modifications in the completed work that differ from the design information shown on the Drawings. Upon Substantial completion of the work, the Contractor shall give the Engineer one complete set of these marked up record Drawings.

23. ADDITIONAL CONTRACT DOCUMENTS

Copies of Contract Documents or Drawings may be obtained on request from the Engineer and by paying the actual cost of reproducing the Contract Documents or Drawings.

24. OWNERSHIP OF CONTRACT DOCUMENTS

All portions of the Contract Documents, and copies thereof furnished by the Engineer are instruments of service for this Project. They are not to be used on other work and are to be returned to the Engineer on request at the completion of the work. Any reuse of these materials without specific written verification or adaptation by the Engineer will be at the risk of the user and without liability or legal expense to the Engineer. Such user shall hold the Engineer harmless from any and all damages, including reasonable attorneys' fees, from any and all claims arising from any such reuse. Any such verification and adaptation shall entitle the Engineer to further compensation at rates to be agreed upon by the user and the Engineer.

THE ENGINEER

25. AUTHORITY OF THE ENGINEER

The Engineer will be the Owner's representative during the construction period. His authority and responsibility will be limited to the Provisions set forth in these Contract Documents. The Engineer will have the Authority to reject work that does not conform to the Contract Documents. However, neither the Engineer's authority to act under this Provision, nor any decision made by him in good faith either to exercise or not to exercise such authority, shall give rise to any duty or responsibility of the Engineer to the Contractor, any Subcontractor, their respective Sureties, any of their agents or employees, or any other person performing any of the work.

26. DUTIES AND RESPONSIBILITIES OF THE ENGINEER

The Engineer will make periodic visits to the site at various stages of construction to observe the Progress and quality of the work and to determine, in general, if the work is proceeding in accordance with the intent of the Contract Documents. He will not make comprehensive or continuous review or observation to check quality or quantity of the work, and will not be responsible for construction means, methods, techniques, sequences, or Procedures, or for safety Precautions and Programs in connection with the work. Visits and observations made by the Engineer shall not relieve the Contractor of his obligation to conduct comprehensive inspections of the work and to furnish materials and perform acceptable work, and to provide adequate safety Precautions, in conformance with the intent of the Contract.

The Engineer will make recommendations to the Owner, in writing, on all claims of the Owner or the Contractor arising from interpretation or execution of the Contract Documents. Such recommendations will be of factual and/or technical nature, and will not include the legal interpretation of the Contract Documents. Any necessary legal interpretation of the Contract Document will be made by the Owner. Such recommendation shall be necessary before the Contractor can receive additional money under the terms of the Contract. Changes in work ordered by the Engineer shall be made in compliance with Article CHANGES IN THE WORK.

One or more Project representatives may be assigned to observe the work. It is understood that such Project representatives shall have the authority to issue notice of nonconformance and make decisions within the limitations of the authority of the Engineer. The Contractor shall furnish all reasonable assistance required by the Engineer or Project representatives for Proper observation of the work. The above-mentioned Project representatives shall not relieve the Contractor of his obligations to conduct comprehensive inspections of the work and to furnish materials and perform acceptable work, and to provide adequate safety Precautions, in conformance with the intent of the Contract.

27. LIMITATIONS ON ENGINEER'S RESPONSIBILITIES

Engineer will not be responsible for Contractor's means, methods, techniques, sequences, or Procedures of construction, or the safety Precautions and Programs incident thereto, and Engineer will not be responsible for Contractor's failure to perform or furnish the work in accordance with the Contract Documents.

Engineer will not be responsible for the acts or omissions of Contractor or of any Subcontractor, any supplier, or of any other person or organization performing or furnishing any of the work.

Whenever in the Contract Documents the terms "as ordered", "as directed", "as required", "as allowed", "as approved", or terms of like effect or import are used, or the adjectives "reasonable", "suitable", "acceptable", "Proper", or "satisfactory", or adjectives of like effect or import are used to describe a requirement, direction, review or judgment of Engineer as to the work, it is intended that such requirement, direction, review or judgment will be solely to evaluate the work for compliance with the Contract Documents (unless there is a specific statement indicating otherwise). The use of any such term or adjective shall not be effective to assign to Engineer any duty or authority to supervise or direct the furnishing or performance of the work or any duty or authority to undertake responsibility contrary to the Provisions of this Article.

28. REJECTED WORK

Any defective work or nonconforming materials or equipment that may be discovered at any time prior to expiration of the warranty period, shall be removed and replaced by work which shall conform to the Provisions of the Contract Documents. Any material condemned or rejected shall be removed at once from the Project site.

Failure on the part of the Engineer to condemn or reject bad or inferior work or to note nonconforming materials or equipment on Contractor submittals shall not be construed to imply acceptance of such work. The Owner shall reserve and retain all of its rights and remedies at law against the Contractor and its Surety for correction of any and all latent defects discovered after the guarantee period.

29. LINES AND GRADES

Lines and grades shall be established as provided in the supplementary conditions. All stakes, marks, and other reference information shall be carefully Preserved by the Contractor, and in case of their careless or unnecessary destruction or removal by him or his employees, such stakes, marks, and other information shall be replaced at the Contractor's expense.

30. SUBMITTALS

After checking and verifying all field measurements and after complying with applicable Procedures specified in Division I, GENERAL REQUIREMENTS, Contractor shall submit to Engineer, in accordance with the schedule for submittals for review, shop drawings, electrical diagrams, and catalog cuts for fabricated items and manufactured items (including mechanical and electrical equipment), which shall bear a stamp or specific written indication that Contractor has satisfied Contractor's responsibilities under the Contract Documents with respect to the review of the submittal. All submittals shall be identified as Engineer may require. The data shown shall be complete with respect to quantities, dimensions specified, performance and design criteria, materials, and similar data to enable Engineer to review the information. Contractor shall also submit to Engineer for review, with such Promptness as to cause no delay in work, all samples required by the Contract Documents. All samples shall have been checked by and accompanied by a specific written indication that Contractor has satisfied Contractor's responsibilities under the Contract Documents with respect to the review of the submission and shall be identified clearly as to material, supplier, pertinent data such as catalog numbers and the use for which intended.

Before submission of each submittal, Contractor shall have determined and verified all quantities, dimensions, specified performance criteria, installation requirements, materials, catalog numbers, and similar data with respect thereto and reviewed or coordinated each submittal with other submittals and with the requirements of the work and the Contract Documents.

At the time of each submission, Contractor shall give Engineer specific written notice of each variation that the submittal may have from the requirements of the Contract Documents, and, in addition, shall cause a specific notation to be made on each shop drawing submitted to Engineer for review and approval of each variation.

Engineer will review submittals with reasonable Promptness, but Engineer's review will be only for conformance with the design concept of the Project and for compliance with the information given in the Contract Documents and shall not extend to means, methods, techniques, sequences, or Procedures of construction (except where a specific means, method, technique, sequence, or Procedure of construction is indicated in or required by the Contract Documents) or to safety Precautions or Programs incident thereto. The review of a separate item as such will not indicate review of the assembly in which the item functions. Contractor shall make corrections required by Engineer, and shall return the required number of corrected copies of shop drawings and submit as required new samples for review. Contractor shall direct specific attention in writing to revisions other than the corrections called

for by Engineer on Previous submittals.

Engineer's review of submittals shall not relieve Contractor from the responsibility for any variation from the requirements of the Contract Documents unless Contractor has in writing called Engineer's attention to each such variation at the time of submission and Engineer has given written approval of each such variation by a specific written notation thereof incorporated therein or accompanying the shop drawing or sample approval; nor will any approval by Engineer relieve Contractor from responsibility for errors or omissions in the shop drawings or from responsibility for having complied with the Provisions herein.

Where a shop drawing or sample is required by the specifications, any related work performed prior to Engineer's review and approval of the pertinent submission shall be at the sole expense and responsibility of the Contractor.

31. DETAIL DRAWINGS AND INSTRUCTIONS

The Engineer will furnish, with reasonable Promptness, additional instructions by means of Drawings or otherwise, if, in the Engineer's opinion, such are required for the Proper execution of the work. All such Drawings and instructions will be consistent with the Contract Documents, true developments thereof, and reasonably inferable there from.

THE CONTRACTOR AND HIS EMPLOYEES

32. CONTRACTOR, AN INDEPENDENT AGENT

The Contractor shall independently perform all work under this Contract and shall not be considered as an agent of the Owner or of the Engineer, nor shall the Contractor's Subcontractors or employees be subagents of the Owner or of the Engineer.

A. ASSIGNMENT OF CONTRACT

Assignment of any part or the whole of this Contract shall be subject to review and approval of the City Commission.

33. SUBCONTRACTING

Unless modified in the Supplementary Conditions, within 10 days after the execution of the Contract, the Contractor shall submit to the Engineer the names of all Subcontractors Proposed for the work, including the names of any Subcontractors that were submitted with the Bid. The Contractor shall not employ any subcontractors to which the Owner may object to as lacking capability to properly perform work of the type and scope anticipated.

The Contractor is as fully responsible to the Owner for the acts and omissions of his Subcontractors and of persons either directly or indirectly employed by them as he is for the acts and omissions of persons directly employed by him.

Nothing contained in the Contract Documents shall create any contractual relationship between any Subcontractor and the Owner or Engineer.

34. INSURANCE AND LIABILITY

A. GENERAL

The Contractor shall provide (from insurance companies acceptable to the Owner) the insurance coverage designated hereinafter and pay all costs before commencing work under this Contract. Contractor shall furnish the Owner with certificates of insurance specified herein showing the type, amount class of operations covered, effective dates, and date of expiration of policies, and containing substantially the following statement:

"The insurance covered by this certificate shall not be canceled or materially altered, except after 30 days' written notice has been received by the Owner."

In case of the breach of any Provision of this Article, the Owner, at his option, may take out and maintain, at the expense of the Contractor, such insurance as the Owner may deem Proper and may deduct the cost of such insurance from any monies which may be due or become due the Contractor under this Contract.

B. CONTRACTOR & SUBCONTRACTOR INSURANCE

The Contractor shall not commence work under this Contract until he has obtained all the insurance required hereunder and such insurance has been reviewed by the Owner, nor shall the Contractor allow any Subcontractor to commence work on his subcontract until insurance specified below has been obtained. Review of the insurance by the Owner shall not relieve or decrease the liability of the Contractor hereunder.

C. COMPENSATION AND EMPLOYER'S LIABILITY INSURANCE

The Contractor shall maintain during the life of this Contract the statutory amount of Workmen's Compensation Insurance, in addition, Employer's Liability Insurance in an amount as specified in the Supplementary Conditions, for each occurrence, for all of his employees to be engaged in work on the Project under this Contract. In case any such work is subcontracted, the Contractor shall require the Subcontractor to provide similar Workmen's Compensation and Employer's Liability Insurance for all of the Subcontractor's employees to be engaged in such work.

D. GENERAL LIABILITY INSURANCE (INCLUDING AUTOMOBILE)

The Contractor shall maintain during the life of this Contract such general liability, completed operations and Products liability, and automobile liability insurance as will Provide coverage for claims for damages for personal injury, including accidental death, as well as for claims for Property damage, which may arise directly or indirectly from performance of the work under this Contract. The general liability policy shall include contractual liability assumed by the Contractor under Article **INDEMNITY**. Coverage for Property damage shall be on a "broad form" basis with no exclusions for "X, C & U". The amount of insurance to be provided shall be as specified in the Supplementary Conditions.

In the event any work under this Contract is performed by a Subcontractor, the Contractor shall be responsible for any liability directly or indirectly arising out of the work performed by the Subcontractor, to the extent such liability is not covered by the Subcontractor's insurance.

The Owner and Engineer, their officers, agents, and employees shall be named as Additional Insured's on the Contractor's and any Subcontractor's general liability and automobile liability insurance policies for any claims arising out of work performed under this Contract.

E. BUILDERS RISK ALL RISK INSURANCE

Unless otherwise modified in the Supplementary Conditions, the Contractor shall secure and maintain during the life of this Contract, Builders Risk All Risk Insurance coverage in an amount equal to the full value of the facilities under construction. Such insurance shall include coverage for earthquake, landslide, flood, collapse, loss due to the results of faulty workmanship or design, and all other normally covered risks, and shall provide for losses to be paid to the Contractor, Owner, and Engineer as their interests may appear. The Owner and Engineer, their officers, agents, and employees shall be named as additional insured's on the Contractor's and any subcontractor's Builders Risk All Risk insurance policies for any claims arising out of work performed under this Contract.

This insurance shall include a waiver of subrogation as to the Engineer, the Owner, the Contractor, and their respective officers, agents, employees and subcontractors.

F. NO PERSONAL LIABILITY OF PUBLIC OFFICIALS

In carrying out any of the Provisions hereof in exercising any authority granted by the Contract, there will be no personal liability upon any public official.

35. INDEMNITY

To the maximum extent permitted by law, the Contractor shall indemnify and defend the Owner and the Engineer, and their officers, employees, agents, and sub-consultants, from all claims and losses, including attorney's fees and litigation costs arising out of Property losses or health, safety, personal injury, or death claims by the Contractor, its subcontractors of any tier, and their employees, agents, or invitees regardless of the fault, breach of Contract, or negligence of the Owner or Engineer, excepting only such claims or losses that have been adjudicated to have been caused solely by the negligence of the Owner or the Engineer and regardless of whether or not the Contractor is or can be named a party in a litigation.

36. EXCLUSION OF CONTRACTOR CLAIMS

In performing its obligations, the Engineer and its consultants may cause expense for the Contractor or its subcontractors and

equipment or material suppliers. However, those parties and their sureties shall maintain no direct action against the Engineer, its officers, employees, agents, and consultants for any claim arising out of, in connection with, or resulting from the engineering services performed or required to be performed.

37. TAXES AND CHARGES

The Contractor shall withhold and pay any and all sales and use taxes and all withholding taxes, whether State or Federal, and pay all Social Security charges and also all State Unemployment Compensation charges, and pay or cause to be withheld, as the case may be, any and all taxes, charges, or fees or sums whatsoever, which are now or may hereafter be required to be paid or withheld under any laws.

38. REQUIREMENTS OF STATE LAW FOR PUBLIC WORKS PROJECTS

When the Contract Documents concern public works of the state or any county, municipality, or political subdivision created by its laws, the applicable statutes shall apply. All parties to this Contract shall determine the contents of all applicable statutes and comply with their Provisions throughout the performance of the Contract.

39. CODES, ORDINANCES, PERMITS AND LICENSES

The Contractor shall keep himself fully informed of all local codes and ordinances, as well as state and federal laws, which in any manner affect the work herein specified. The Contractor shall at all times comply with said codes and ordinances, laws, and regulations, and Protect and indemnify the Owner, the Engineer and their respective employees, and its officers and agents against any claim or liability arising from or based on the violation of any such laws, ordinances, or regulations. All permits, licenses and inspection fees necessary for Prosecution and completion of the work shall be secured and paid for by the Contractor, unless otherwise specified.

40. SUPERINTENDENCE

The Contractor shall keep at the Project site, competent supervisory personnel. The Contractor shall designate, in writing, before starting work, a Project superintendent who shall be an employee of the Contractor and shall have complete authority to represent and to act for the Contractor. Engineer shall be notified in writing prior to any change in superintendent assignment. The Contractor shall give efficient supervision to the work, using his best skill and attention. The Contractor shall be solely responsible for all construction means, methods, techniques, and Procedures, and for providing adequate safety Precautions and coordinating all portions of the work under the Contract. It is specifically understood and agreed that the Engineer, its employees and agents, shall not have control or charge of and shall not be responsible for the construction means, methods, techniques, Procedures, or for providing adequate safety Precautions in connection with the work under Contract.

41. RECEPTION OF ENGINEER'S COMMUNICATIONS

The superintendent shall receive for the Contractor all communications from the Engineer. Communications of major importance will be confirmed in writing upon request from the Contractor. The Engineer may schedule Project meetings for the purposes of discussing and resolving matters concerning the various elements of the work. Time and place for these meetings and the names of persons required to be Present shall be as determined by the Engineer. Contractor shall comply with these attendance requirements and shall also require his Subcontractors to comply.

42. SAFETY

The Contractor shall be solely and completely responsible for conditions of the jobsite, including safety of all persons (including employees) and Property during performance of the work. This requirement shall apply continuously and not be limited to normal working hours. Safety Provisions shall conform to U.S. Department of Labor (OSHA), and all other applicable federal, state, county, and local laws, ordinances, codes, and regulations. Where any of these are in conflict, the more stringent requirement shall be followed. The Contractor's failure to thoroughly familiarize himself with the aforementioned safety Provisions shall not relieve him from compliance with the obligations and penalties set forth therein.

The Contractor shall develop and maintain for the duration of this Contract, a safety Program that will effectively incorporate and implement all required safety Provisions. The Contractor shall appoint an employee who is qualified and authorized to supervise and enforce compliance with the safety Program.

The duty of the Engineer to conduct construction review of the work does not include review or approval of the adequacy of the Contractor's safety Program, safety supervisor, or any safety measures taken in, on, or near the construction site.

The Contractor, as a part of his safety Program, shall maintain at his office or other well-known place at the jobsite, safety equipment applicable to the work as Prescribed by the aforementioned authorities, all articles necessary for giving first-aid to the injured, and shall establish the Procedure for the immediate removal to a hospital or a doctor's care of persons (including employees) who may be injured on the jobsite.

If death or serious injuries or serious damages are caused, the accident shall be reported immediately by telephone or messenger to both the Engineer and the Owner. In addition, the Contractor must promptly report in writing to the Engineer all accidents whatsoever arising out of, or in connection with, the performance of the work whether on, or adjacent to, the site, giving full details and statements of witnesses.

If a claim is made by anyone against the Contractor or any Subcontractor on account of any accident, the Contractor shall promptly report the facts in writing to the Engineer, giving full details of the claim.

43. PROTECTION OF WORK AND PROPERTY

The Contractor shall at all times safely guard and Protect from damage the Owner's Property, adjacent Property, and his own work from injury or loss in connection with this Contract. All facilities required for Protection by federal, state, or municipal laws and regulations and local conditions must be provided and maintained. The Contractor shall Protect his work and materials from damage due to the nature of the work, the elements, carelessness of other contractors, or from any cause whatever until the completion and acceptance of the work. All loss or damages arising out of the nature of the work to be done under these Contract Documents, or from any unforeseen obstruction or defects which may be encountered in the Prosecution of the work, or from the action of the elements, shall be sustained by the Contractor.

44. RESPONSIBILITY OF CONTRACTOR TO ACT IN AN EMERGENCY

In case of an emergency which threatens loss or injury of Property, and/or safety of life, the Contractor shall act, without previous instructions from the Owner or Engineer, as the situation may warrant. The Contractor shall notify the Engineer thereof immediately thereafter. Any claim for compensation by the Contractor, together with substantiating documents in regard to expense, shall be submitted to the Owner through the Engineer and the amount of compensation shall be determined by agreement.

45. MATERIALS AND APPLIANCES

Unless otherwise stipulated, the Contractor shall Provide and pay for all materials, labor, water, tools, equipment, heat, light, fuel, power, transportation, construction equipment and machinery, appliances, telephone, sanitary facilities, temporary facilities and other facilities and incidentals necessary for the execution and completion of the work.

Unless otherwise specified, all materials shall be new, and both workmanship and materials shall be of good quality. The Contractor shall, if required, furnish satisfactory evidence as to the kind and quality of materials.

In selecting and/or approving equipment for installation in the Project, the Owner and Engineer assume no responsibility for injury or claims resulting from failure of the equipment to comply with applicable federal, state, and local safety codes or requirements, or the safety requirements of a recognized agency, or failure due to faulty design concepts, or defective workmanship and materials.

46. CONTRACTORS' AND MANUFACTURERS' COMPLIANCE WITH STATE SAFETY, OSHA, AND OTHER CODE REQUIREMENTS

The completed work shall include all necessary permanent safety devices, such as machinery guards and similar ordinary safety items required by the state and federal (OSHA) industrial authorities and applicable local and national codes. Further, any features of the work subject to such safety regulations shall be fabricated, furnished, and installed (including Owner-furnished equipment) in compliance with these requirements. Contractors and manufacturers of equipment shall be held responsible for compliance with the requirements included herein. Contractors shall notify all equipment suppliers and Subcontractors of the Provisions of this Article.

47. SUBSTITUTION OF MATERIALS

Except for Owner-selected equipment items, and items where no substitution is clearly specified, whenever any material, article, device, Product, fixture, form, type of construction, or Process is indicated or specified by patent or Proprietary name, by name of manufacturer, or by catalog number, such specifications shall be deemed to be used for the purpose of establishing a standard of

quality and facilitating the description of the material or Process desired. This Procedure is not to be construed as eliminating from competition other Products of equal or better quality by other manufacturers where fully suitable in design, and shall be deemed to be followed by the words "or equal". The Contractor may, in such cases, submit complete data to the Engineer for consideration of another material, type, or Process that shall be substantially equal in every respect to that so indicated or specified. Substitute materials shall not be used unless approved in writing. The Engineer will be the sole judge of the substituted article or material.

48. TESTS, SAMPLES, AND OBSERVATIONS

The Contractor shall furnish, without extra charge, the necessary test pieces and samples, including facilities and labor for obtaining the same, as requested by the Engineer. When required, the Contractor shall furnish certificates of tests of materials and equipment made at the point of manufacture by a recognized testing laboratory.

The Owner, Engineer, and authorized government agents, and their representatives shall at all times be Provided safe access to the work wherever it is in Preparation or Progress, and the Contractor shall Provide facilities for such access and for observations, including maintenance of temporary and permanent access.

If the Specifications, laws, ordinances, or any public authority require any work, to be specially tested or approved, the Contractor shall give timely notice of its readiness for observations. If any work should be covered up without approval or consent of the Engineer, it shall, if required by the Engineer, be uncovered for examination at the Contractor's expense.

Reexamination of questioned work may be ordered by the Engineer, and, if so ordered, the work shall be uncovered by the Contractor. If such work is found to be in accordance with the Contract Documents, the Owner will pay the cost of uncovering, exposure, observation, inspection, testing and reconstruction. If such work is found to be not in accordance with the Contract Documents, the Contractor shall correct the defective work, and the cost of reexamination and correction of the defective work shall be paid by the Contractor.

49. ROYALTIES AND PATENTS

The Contractor shall pay all royalty and licenses fees, unless otherwise specified. The Contractor shall defend all suits or claims for infringement of any patent rights and shall save the Owner and the Engineer harmless from any and all loss, including reasonable attorneys' fees, on account thereof.

50. CONTRACTOR'S RIGHT TO TERMINATE CONTRACT

If the work should be stopped under an order of any court or other public authority for a period of more than 3 months, through no act or fault of the Contractor, its Subcontractors, or respective employees or if the Engineer should fail to make recommendation for payment to the Owner or return payment request to Contractor for revision within 30 days after it is due, or if the Owner should fail to pay the Contractor within 30 days after time specified in Article PARTIAL PAYMENTS, any sum recommended by the Engineer, then the Contractor may, upon 15 days' written notice to the Owner and the Engineer, stop work or terminate this Contract and recover from the Owner payment for all acceptable work performed and reasonable termination expenses, unless said default has been remedied.

51. CORRECTION OF DEFECTIVE WORK DURING WARRANTY PERIOD

The Contractor hereby agrees to make, at his own expense, all repairs or replacements necessitated by defects in materials or workmanship, Provided under terms of this Contract, and pay for any damage to other works resulting from such defects, which become evident within 2 years after the date of final acceptance of the work or within 2 years after the date of substantial completion established by the Engineer for specified items of equipment, or within such longer period as may be Prescribed by law or by the terms of any applicable special guarantee required by the Contract Documents. Un-remedied defects identified for correction during the warranty period but remaining after its expiration shall be considered as part of the obligations of the warranty. Defects in material, workmanship, or equipment which are remedied as a result of obligations of the warranty shall subject the remedied portion of the work to an extended warranty period of 2 years after the defect has been remedied.

The Contractor further assumes responsibility for a similar guarantee for all work and materials provided by Subcontractors or manufacturers of packaged equipment components. The effective date for the start of the guarantee or warranty period for equipment qualifying as substantially complete is defined in Article SUBSTANTIAL COMPLETION, AND Article SUBSTANTIAL COMPLETION DATE, in these General Conditions.

The Contractor also agrees to hold the Owner and the Engineer harmless from liability of any kind arising from damage due to said defects. The Contractor shall make all repairs and replacements promptly upon receipt of written order for same from the Owner. If the Contractor fails to make the repairs and replacements promptly, or in an emergency where delay would cause serious risk, or loss, or damage, the Owner may have the defective work corrected or the rejected work removed and replaced, and the Contractor and his Surety shall be liable for the cost thereof.

PROGRESS OF THE WORK

52. BEGINNING OF THE WORK

Following execution of the Contract, the Contractor shall meet with the Owner and Engineer relative to his arrangements for prosecuting the work.

53. SCHEDULES AND PROGRESS REPORTS

Prior to starting the construction, the Contractor shall Prepare and submit to the Engineer, a Progress schedule showing the dates on which each part or division of the work is expected to be started and finished, and a Preliminary schedule for submittals. The Progress schedule for submittals shall be brought up to date and submitted to the Engineer at the end of each month or at such other times the Engineer may request.

The Contractor shall forward to the Engineer, at the end of each month, an itemized report of the delivery status of major and critical items of purchased equipment and material, including shop drawings and the status of shop and field fabricated work. These Progress reports shall indicate the date of the purchase order, the current percentage of completion, estimated delivery, and cause of delay, if any.

If the completion of any part of the work or the delivery of materials is behind the submitted Progress schedule, the Contractor shall submit in writing a plan acceptable to the Owner and Engineer for bringing the work up to schedule.

The Owner shall have the right to withhold Progress payments for the work if the Contractor fails to update and submit the Progress schedule and reports as specified.

54. PROSECUTION OF THE WORK

It is expressly understood and agreed that the time of beginning, rate of Progress, and time of completion of the work are the essence of this Contract. The work shall be prosecuted at such time, and in or on such part or parts of the Project as may be required, to complete the Project as contemplated in the Contract Documents and the Progress schedule.

If the Contractor desires to carry on work at night or outside the regular hours, he shall give timely notice to the Engineer to allow satisfactory arrangements to be made for observing the work in Progress.

55. OWNER'S RIGHT TO RETAIN IMPERFECT WORK

If any part or portion of the work completed under this Contract shall Prove defective and not in accordance with the Drawings and Specifications, and if the imperfection in the same shall not be of sufficient magnitude or importance as to make the work dangerous or unsuitable, or if the removal of such work will create conditions which are dangerous or undesirable, the Owner shall have the right and authority to retain such work but will make such deductions in the final payment therefore as may be just and reasonable.

56. OWNER'S RIGHT TO DO WORK

Should the Contractor neglect to Prosecute the work in conformance with the Contract Documents or neglect or refuse at his own cost to remove and replace work rejected by the Engineer, then the Owner may notify the Surety of the condition, and after 10 days' written notice to the Contractor and the Surety, or without notice if an emergency or danger to the work or public exists, and without Prejudice to any other right which the Owner may have under Contract, or otherwise, take over that portion of the work which has been improperly or non-timely executed, and make good the deficiencies and deduct the cost thereof from the payments then or thereafter due the Contractor.

57. OWNER'S RIGHT TO TRANSFER EMPLOYMENT

If the Contractor should abandon the work or if he should persistently or repeatedly refuse or should fail to make Prompt payment to Subcontractors for material or labor, or to persistently disregard laws, ordinances, or to Prosecute the work in conformance with the Contract Documents, or otherwise be guilty of a substantial violation of any Provision of the Contract or any laws or ordinance, then the Owner may, without Prejudice to any other right or remedy, and after giving the Contractor and Surety 10 days' written notice, transfer the employment for said work from the Contractor to the Surety. Upon receipt of such notice, such Surety shall enter upon the Premises and take possession of all materials, tools, and appliances thereon for the purpose of completing the work included under this Contract and employ by Contract or otherwise, any qualified person or persons to finish the work and Provide the materials therefore, in accordance with the Contract Documents, without termination of the continuing full force and effect of this Contract. In case of such transfer of employment to such Surety, the Surety shall be paid in its own name on estimates according to the terms hereof without any right of the Contractor to make any claim for the same or any part thereof.

If, after the furnishing of said written notice to the Surety, the Contractor and the Surety still fail to make reasonable Progress on the performance of the work, the Owner may terminate the employment of the Contractor and take possession of the Premises and of all materials, tools, and appliances thereon and finish the work by whatever method he may deem expedient and charge the cost thereof to the Contractor and the Surety. In such case, the Contractor shall not be entitled to receive any further payment until the work is finished. If the expense of completing the Contract, including compensation for additional managerial and administrative services, shall exceed such unpaid balance, the Contractor and the Surety shall pay the difference to the Owner.

58. DELAYS AND EXTENSION OF TIME

If the Contractor is delayed in the Progress of the work by any act or neglect of the Owner or the Engineer, or by any separate Contractor employed by the Owner, or by strikes, lockouts, fire, adverse weather conditions not reasonably anticipated, or acts of Nature, and if the Contractor, within 48 hours of the start of the occurrence, gives written notice to the Owner of the cause of the potential delay and estimate of the possible time extension involved, and within 10 days after the cause of the delay has been remedied, the Contractor gives written notice to the Owner of any actual time extension requested as a result of the aforementioned occurrence, then the Contract time may be extended by change order for such reasonable time as the Engineer determines. It is agreed that no claim shall be made or allowed for any damages, loss, or expense which may arise out of any delay caused by the above referenced acts or occurrences other than claims for the appropriate extension of time. No extension of time will be granted to the Contractor for delays occurring to parts of the work that have no measurable impact on the completion of the total work under this Contract. No extension of time will be considered for weather conditions reasonably anticipated for the area in which the work is being performed. Reasonably anticipated weather conditions will be based on official records of monthly Precipitation and other historical data. Adverse weather conditions, if determined to be of a severity that would impact Progress of the work, may be considered as cause for an extension of Contract completion time.

Delays in delivery of equipment or material purchased by the Contractor or his Subcontractors, including Owner-selected equipment shall not be considered as a just cause for delay, unless the Owner determines that for good cause the delay is beyond the control of the Contractor. The Contractor shall be fully responsible for the timely ordering, scheduling, expediting, delivery, and installation of all equipment and materials.

Within a reasonable period after the Contractor submits to the Owner a written request for an extension of time, the Engineer will Present his written opinion to the Owner as to whether an extension of time is justified, and, if so, his recommendation as to the number of days for time extension. The Owner will make the final decision on all requests for extension of time.

59. DIFFERING SITE CONDITIONS

The Contractor shall promptly, and before the conditions are disturbed, give a written notice to the Owner and Engineer of:

- A. subsurface or latent physical conditions at the site which differ materially from those indicated in this contract,
- B. unknown physical conditions at the site, of an unusual nature, which differ materially from those ordinarily encountered and generally recognized as inherent in work of the character provided for in the Contract.

The Engineer will investigate the site conditions promptly after receiving the notice. If the conditions do materially so differ and cause an increase or decrease in the Contractor's cost of, or the time required for, performing any part of the work under this Contract, whether or not changed as a result of the conditions, and equitable adjustment shall be made under this Article and the Contract modified in writing accordingly.

No request by the Contractor for an equitable adjustment to the Contract under this Article will be allowed, unless the Contractor

has given the written notice required; Provided that the time prescribed above for giving written notice may be extended by the Owner.

No request by the Contractor for an equitable adjustment to the Contract for differing site conditions will be allowed if made after final payment under this Contract.

60. LIQUIDATED DAMAGES

Should the Contractor fail to complete the work, or any part thereof, in the time agreed upon in the Contract or within such extra time as may have been allowed for delays by extensions granted as Provided in the Contract, the Contractor shall reimburse the Owner for the additional expense and damage for each calendar day, Sundays and legal holidays included, that the Contract remains uncompleted after the Contract completion date. It is agreed that the amount of such additional expense and damage incurred by reason of failure to complete the work is the per-diem rate, as stipulated in the Bid. The said amount is hereby agreed upon as a reasonable estimate of the costs, which may be accrued by the Owner after the expiration of the time of completion. It is expressly understood and agreed that this amount is not to be considered in the nature of a penalty, but as liquidated damages which have accrued against the Contractor. The Owner shall have the right to deduct such damages from any amount due, or that may become due the Contractor, or the amount of such damages shall be due and collectible from the Contractor or Surety.

61. OTHER CONTRACTS

The Owner reserves the right to let other Contracts in connection with the work. The Contractor shall afford other Contractors reasonable opportunity for the introduction and storage of their materials and the execution of their work and shall properly connect and coordinate his work with theirs.

If any part of the work under this Contract depends for Proper execution or results upon the work of any other Contractor, utility service company or Owner, the Contractor shall inspect and Promptly report to the Engineer in writing any patent or apparent defects to deficiencies in such work that render it unsuitable for such Proper execution and results. The Contractor's failure to so report shall constitute and acceptance of the work by others as being fit and Proper for integration with work under this Contract, except for latent or non-apparent defects and deficiencies in the work.

62. USE OF PREMISES

The Contractor shall confine his equipment, the storage of materials and the operation of his workers to limits shown on the Drawings or indicated by law, ordinances, permits, or directions of the Engineer, and shall not unreasonably encumber the Premises with his materials. The Contractor shall provide, at his own expense, the necessary rights of way and access to the work, which may be required outside the limits of the Owner's Property and shall furnish the Engineer copies of permits and agreements for use of the Property outside that provided by the Owner.

The Contractor shall not load nor permit any part of the structure to be loaded in any manner that will endanger the structure, nor shall Contractor subject any part of the work or adjacent Property to stresses or Pressures that will endanger it.

63. SUBSTANTIAL COMPLETION DATE

The Engineer may issue a written notice of substantial completion for the purpose of establishing the starting date for specific equipment guarantees, and to establish the date that the Owner will assume the responsibility for the cost of operating such equipment. Said notice shall not be considered as final acceptance of any portion of the work or relieve the Contractor from completing the remaining work within the specified time and in full compliance with the Contract Documents. See SUBSTANTIAL COMPLETION under DEFINITIONS of these General Conditions.

64. PERFORMANCE TESTING

Operating equipment and systems shall be performance tested in the Presence of the Engineer to demonstrate compliance with the specified requirements. Performance testing shall be conducted under the specified design operating conditions or under such simulated operating conditions as recommended or approved by the Engineer. Schedule such testing with the Engineer at least one week in advance of the planned date for testing.

65. OWNER'S USE OF PORTIONS OF THE WORK

Following issuance of the written notice of Substantial Completion, the Owner may initiate operation of the facility. Such use shall not be considered as final acceptance of any portion of the work, nor shall such use be considered as cause for an extension of the Contract completion time, unless authorized by a Change Order issued by the Owner.

66. CUTTING AND PATCHING

The Contractor shall do all cutting, fitting, or patching of his work that may be required to make its several parts come together Properly and fit it to receive or be received by work of other Contractors shown upon or reasonably implied by the Drawings.

67. CLEANING UP

The Contractor shall, at all times, keep Property on which work is in Progress and the adjacent Property free from accumulations of waste material or rubbish caused by employees or by the work. Upon completion of the construction, the Contractor shall remove all temporary structures, rubbish, and waste materials resulting from his operations.

PAYMENT

68. PAYMENT FOR CHANGE ORDERS

The Owner's request for quotations on alterations to the work shall not be considered authorization to proceed with the work prior to the issuance of a formal Change Order, nor shall such request justify any delay in existing work. Quotations for alterations to the work shall include substantiating documentation with an itemized breakdown of Contractor and Subcontractor costs, including labor, material, rentals, approved services, overhead, and profit. Owner may require detailed cost data in order to substantiate the reasonableness of the proposed costs.

Any compensation paid in conjunction with the terms of a Change Order shall comprise total compensation due the Contractor for the work or alteration defined in the Change Order. By signing the Change Order, the Contractor acknowledges that the stipulated compensation includes payment for the work or alteration plus all payment for the interruption of schedules, extended overhead, delay, or any other impact claim or ripple effect, and by such signing specifically waives any reservation or claim for additional compensation in respect to the subject Change Order.

At the Owner's option, payment or credit for any alterations covered by a Change Order shall be determined by one or a combination of the methods set forth in A, B, or C below, as applicable:

A. UNIT PRICES

Those unit Prices stipulated in the Bid shall be utilized where they are applicable. In the event the Change Order results in a change in the original quantity that is materially and significantly different from the original bid quantity, a new unit Price shall be negotiated upon demand of either party. Unit Prices for new items included in the Change Order shall be negotiated and mutually agreed upon.

B. LUMP SUM

A total lump sum for the work negotiated and mutually acceptable to the Contractor and the Owner.

Lump sum quotations for modifications to the work shall include substantiating documentation with an itemized breakdown of Contractor and Subcontractor costs, including labor, material, rentals, approved services, overhead, and Profit, all calculated as specified under "C" below.

C. COST REIMBURSEMENT WORK

The term "cost reimbursement" shall be understood to mean that payment for the work will be made on a time and expense basis, that is, on an accounting of the Contractor's forces, materials, equipment, and other items of cost as required and used to do the work. If the method of payment cannot be agreed upon Prior to the beginning of the work, and the Owner directs by written Change Order that the work be done on a cost reimbursement basis, then the Contractor shall furnish labor, and furnish and install equipment and materials necessary to complete the work in a satisfactory manner and within a reasonable period of time. For the work performed, payment will be made for the documented actual cost of the following:

1. Labor including foremen for those hours they are assigned and participating in the cost reimbursement work (actual payroll cost, including wages, fringe benefits as established by negotiated labor agreements, labor insurance, and labor taxes as

established by law). No other fixed labor burdens will be considered, unless approved in writing by the Owner.

2. Material delivered and used on the designated work, including sales tax, if paid by the Contractor or his Subcontractor.
3. Rental or equivalent rental cost of equipment, including necessary transportation for items having a value in excess of \$100.

Rental or equivalent rental cost will be allowed for only those days or hours during which the equipment is in actual use. Rental and transportation allowances shall not exceed the current rental rates prevailing in the locality. The rentals allowed for equipment will, in all cases, be understood to cover all fuel, supplies, repairs, and renewals, and no further allowances will be made for those items, unless specific agreement to that effect is made.

4. Additional bond, as required and approved by the owner.
 5. Additional insurance (other than labor insurance) as required and approved by the Owner.
- In addition to items 1 through 5 above, an added fixed fee for general overhead and Profit shall be negotiated and allowed for the Contractor (or approved Subcontractor) actually executing the Cost Reimbursement work.

An additional fixed fee shall be negotiated and allowed the Contractor for the administrative handling of portions of the work that are executed by an approved Subcontractor. No additional fixed fee will be allowed for the administrative handling of work executed by a Subcontractor of a Subcontractor, unless by written permission from the Owner.

The added fixed fees shall be considered to be full compensation, covering the cost of general supervision, overhead, Profit, and any other general expense. The Contractor's records shall make clear distinction between the direct costs of work paid for on a cost reimbursement basis and the costs of other work. The Contractor shall furnish the Engineer report sheets in duplicate of each day's cost reimbursement work no later than the working day following the performance of said work. The daily report sheets shall itemize the materials used, and shall cover the direct cost of labor and the charges for equipment rental, whether furnished by the Contractor, Subcontractor or other forces. The daily report sheets shall provide names or identifications and classifications of workers, the hourly rate of pay and hours worked, and also the size, type, and identification number of equipment and hours operated.

Material charges shall be substantiated by valid copies of vendors' invoices.. Such invoices shall be submitted with the daily report sheets, or, if not available, they shall be submitted with subsequent daily report sheets. Said daily report sheets shall be signed by the Contractor or his authorized agent.

The Owner reserves the right to furnish such materials and equipment as he deems expedient, and the Contractor shall have no claim for Profit or added fees on the cost of such materials and equipment. To receive partial payments and final payment for cost reimbursement work, the Contractor shall submit to the Engineer, detailed and complete documented verification of the Contractor's and any of his Subcontractors' actual costs involved in the cost reimbursement work. Such costs shall be submitted within 30 days after said work has been performed.

69. PARTIAL PAYMENTS

A. GENERAL

Nothing in this Article shall be construed to affect the right, hereby reserved, to reject the whole or any part of the aforesaid work, should such work be later found not to comply with the Provisions of the Contract Documents. All estimated quantities of work for which partial payments have been made are subject to review and correction on the final estimate. Payment by the Owner and acceptance by the Contractor of partial payments based on periodic estimates of quantities of work performed shall not, in any way, constitute acceptance of the estimated quantities used as a basis for computing the amounts of the partial payments.

B. ESTIMATE

At least 30 days before each Progress payment falls due, as specified in the Supplementary Conditions, the Contractor shall submit to the Engineer a detailed estimate of the amount earned during the Preceding month for the separate portions of the work, and request payment. As used in this Article, the words "amount earned" means the value, on the date of the estimate for partial payment, of the work completed in accordance with the Contract Documents, and the value of approved materials delivered to the Project site suitable stored and Protected Prior to incorporation into the work.

Engineer will, within 7 days after receipt of each request for payment, either indicate in writing a recommendation of payment and present the request to Owner, or return the request to Contractor indicating in writing Engineer's reasons for refusing to recommend payment. In the latter case, Contractor may, within 7 days, make the necessary corrections and resubmit the request.

Engineer may refuse to recommend the whole or any part of any payment if, in his opinion, it would be incorrect to make such representations to Owner. Engineer may also refuse to recommend any such payment, or, because of subsequently discovered evidence or the results of subsequent inspections or tests, nullify any such payment previously recommended to such an extent as may be necessary in Engineer's opinion to protect the Owner from loss because:

1. The work is defective, or completed work has been damaged requiring correction or replacement;
2. Written claims have been made against Owner or Liens have been filed in connection with the work;
3. The Contract Price has been reduced because of Change Orders;
4. Owner has been required to correct defective work or complete the work in accordance with Article OWNER'S RIGHT TO DO WORK;
5. Of Contractor's unsatisfactory Prosecution of the work in accordance with the Contract Documents; or
6. Contractor's failure to make payment to Subcontractors or for labor, materials, or equipment.

C. DEDUCTION FROM ESTIMATE

Unless modified in the Supplementary Conditions, deductions from the estimate will be as described below:

The Owner will deduct from the estimate, and retain as part security, 10 percent of the amount earned for work satisfactorily completed. A deduction and retainage of 10 percent will be made on the estimated amount earned for approved items of material delivered to and properly stored at the jobsite but not incorporated into the work. When the work is 50 percent complete, the Owner may reduce the retainage to 5 percent of the dollar value of all work satisfactorily completed to date provided the Contractor is making satisfactory progress and there is no specific cause for a greater retainage. The Owner may reinstate the retainage up to 10 percent if the Owner determines, at his discretion, that the Contractor is not making satisfactory Progress or where there is other specific cause for such withholding.

D. QUALIFICATION FOR PARTIAL PAYMENT FOR MATERIALS DELIVERED

Unless modified in the Supplementary Conditions, qualification for partial payment for materials delivered but not yet incorporated into the work shall be as described below:

1. Materials, as used herein, shall be considered to be those items which are fabricated and manufactured material and equipment. No consideration shall be given to individual purchases of less than \$200 for any one item.
2. To receive partial payment for materials delivered to the site, but not incorporated in the work, it shall be necessary for the Contractor to include a list of such materials on the Partial Payment Request. At his sole discretion, the Engineer may approve items for which partial payment is to be made. Partial payment shall be based on the Contractor's actual cost for the materials as evidenced by invoices from the supplier. Proper storage and Protection shall be provided by the Contractor, and as approved by the Engineer. Final payment shall be made only for materials actually incorporated in the work and, upon acceptance of the work, all materials remaining for which advance payments had been made shall revert to the Contractor, unless otherwise agreed, and partial payments made for these items shall be deducted from the final payment for the work.
3. Contractor warrants and guarantees that title to all work, materials, and equipment covered by any Application for Payment, whether incorporated in the Project or not, will pass to Owner at the time of payment free and clear of all liens, claims, security interests, and encumbrances.
4. If requested by the Engineer, the Contractor shall provide, with subsequent pay requests, invoices received by the supplier showing payment in full has been made.

E. PAYMENT

After deducting the retainage and the amount of all Previous partial payments made to the Contractor from the amount earned, the amount due will be made payable to the Contractor. Recommendations for payment received by the Owner less than 9 days Prior to the scheduled day for payment will not be Processed or paid until the following month.

70. CLAIMS FOR EXTRA WORK

In any case where the Contractor deems additional time or compensation will become due him under this Contract for circumstances other than those defined in Article DELAYS AND EXTENSION OF TIME, the Contractor shall notify the Engineer, in writing, of his intention to make claim for such time or compensation before he begins the work on which he bases the claim, in order that such matters may be settled, if possible, or other appropriate action taken. The notice of claim shall be in duplicate, in writing, and shall state the circumstances and the reasons for the claim, but need not state the amount. If such notification is not given or if the Engineer is not afforded Proper facilities by the Contractor for keeping strict account of actual cost, then the Contractor hereby agrees to waive the claim for such additional time or compensation. Such notice by the Contractor, and fact that the Engineer has kept account of the cost as aforesaid, shall not in any way be construed as Proving the validity of the claim.

No extension of time will be granted to the Contractor for delays resulting from extra work that have no measurable impact on the completion of the total Work under this Contract. Claims for additional time or compensation shall be made in itemized detail and submitted, in writing, to the Owner and Engineer within 10 days following completion of that portion of the work for which the Contractor bases his claim. Failure to make the claim for additional compensation in the manner and within the time specified above shall constitute waiver of that claim. In case the claim is found to be just, it shall be allowed and paid for as provided in Article PAYMENT FOR CHANGE ORDERS.

71. RELEASE OF LIENS OR CLAIMS

The Contractor shall indemnify and hold harmless the Owner from all claims for labor and materials furnished under this Contract. Prior to the final payment, the Contractor shall furnish to the Owner, as part of his final payment request, a certification that all of the Contractor's obligations on the Project have been satisfied and that all monetary claims and indebtedness have been paid. The Contractor shall furnish complete and legal effective releases or waivers, satisfactory to the Owner, of all liens arising out of or filed in connection with the work.

72. FINAL PAYMENT

Upon completion of all the work under this Contract, the Contractor shall notify the Engineer, in writing, that he has completed his part of the Contract and shall request final payment. Upon receipt of such notice the Engineer will inspect and, if acceptable, submit to the Owner his recommendation as to acceptance of the completed work and as to the final estimate of the amount due the Contractor. Upon approval of this final estimate by the Owner and compliance by the Contractor with Provisions in Article **RELEASE OF LIENS OR CLAIMS**, and other Provisions as may be applicable, the Owner shall pay to the Contractor all monies due him under the Provisions of these Contract Documents.

73. NO WAIVER OF RIGHTS

Neither the inspection by the Owner, through the Engineer or any of his employees, nor any order by the Owner for payment of money, nor any payment for, or acceptance of, the whole or any part of the work by the Owner or Engineer, nor any extension of time, nor any possession taken by the owner or its employees, shall operate as a waiver of any Provision of this Contract, or any power herein reserved to the Owner, or any right to damages herein Provided, nor shall any waiver of any breach in this Contract be held to be a waiver of any other or subsequent breach. Acceptance or final payment shall not be final and conclusive with regards to latent defects, fraud, or such gross mistakes as may amount to fraud, or as regards the Owner's rights under the warranty.

74. ACCEPTANCE OF FINAL PAYMENT CONSTITUTES RELEASE

The acceptance by the Contractor of the final payment shall release the Owner and the Engineer, as representatives of the Owner, from all claims and all liability to the Contractor for all things done or furnished in connection with the work, and every act of the Owner and others relating to or arising out of the work except claims Previously made in writing and still unsettled. No payment, however, final or otherwise, shall operate to release the Contractor or his Sureties from obligations under this Contract and the

Performance Bond, Payment Bond, and other bonds and warranties, as herein provided.

SUPPLEMENTARY CONDITIONS

REVISIONS AND ADDITIONS TO THE GENERAL CONDITIONS

ARTICLE 9 – ENGINEER

ARTICLE 12 – OWNER

ARTICLE 14 – SPECIFICATIONS

ARTICLE 29 – LINES AND GRADES

ARTICLE 34 – INSURANCE & LIABILITY

ARTICLE 35 – INDEMNITY

ARTICLE 39 – CODES, ORDINANCES, PERMITS, AND LICENSES

ARTICLE 40 – SUPERINTENDENCE

ARTICLE 42 – SAFETY

ARTICLE 43 – PROTECTION OF WORK AND PROPERTY

ARTICLE 57 – OWNERS RIGHT TO TRANSFER EMPLOYMENT

ARTICLE 60 – LIQUIDATED DAMAGES

ARTICLE 68 – PAYMENT

ARTICLE 69 – PARTIAL PAYMENTS

ARTICLE 72 – FINAL PAYMENT

ARTICLE 9 "ENGINEER"

Add the following:

Wherever in these Documents the word "Engineer" appears, it shall be understood to mean the City Engineer or his/her authorized representative, who will perform the Contract administrative and field inspections as authorized agents of the Owner.

ARTICLE 12 "OWNER"

Add the following:

Wherever in these Documents the word "Owner" appears, it shall be understood to mean the City of Key West whose address is 1300 White Street, P.O. Box 1409, Key West, Florida 33041-1409.

ARTICLE 14 "SPECIFICATIONS"

Add the following:

FEDERAL, STATE, COUNTY, AND LOCAL STANDARD SPECIFICATIONS

Where portions of the work traverse or cross federal, state, county, or local highways, roads, or streets, and the agency in control of such Property has established standard specifications governing items of work that differ from these Specifications, the most stringent requirements shall apply.

The Contractor shall comply with all regulations and requirements of the Florida Department of Transportation and the County Road Department wherever the work traverses or crosses state or county highways.

ARTICLE 29 "LINES AND GRADES"

Add the following:

It will be the Contractor's responsibility to layout the work and to transfer elevations from benchmarks. Where new construction connects to existing facilities, the Contractor shall check and establish the exact location prior to construction of the facilities.

The Contractor shall furnish all surveys, labor, and equipment, including setting all alignment and gradient, grade stakes, batter boards, and everything necessary to lay out his work. The Contractor shall be responsible for maintaining and re-establishing at his expense, all control points. After completion of his construction, he shall reset all permanent monuments at their original locations and elevations through the use of registered surveys.

Layout work may be checked by the Engineer, and the Contractor shall furnish all necessary labor, equipment, and materials, and shall cooperate and assist the Engineer in making such checks.

The dimensions for lines and elevations for grades of the structures, appurtenances, and utilities will be shown on Drawings attached to each Work Order, together with other pertinent information required for laying out the work. If site conditions vary from those indicated, the Contractor shall notify the Engineer immediately, who will make any minor adjustment as required.

ARTICLE 34 "INSURANCE & LIABILITY"

Delete Article 34 (A), (B), (C), (D), and (E) and substitute with the following:

Contractor shall maintain limits no less than those stated below:

CONTRACTOR is to secure, pay for, and file with the City of Key West, prior to commencing any work under the Contract, all certificates for workers' compensation, public liability, and property damage liability insurance, and such other insurance coverages as may be required by specifications and addenda thereto, in at least the following minimum amounts with specification amounts to prevail if greater than minimum amounts indicated. Notwithstanding any other provision of the Contract, the CONTRACTOR shall provide the minimum limits of liability insurance coverage as follows:

Auto Liability	\$1,000,000	Combined Single Limit
General Liability	\$2,000,000	Aggregate (Per Project)
	\$2,000,000	Products Aggregate
	\$1,000,000	Any One Occurrence
	\$2,000,000	Personal Injury
	\$ 300,000	Fire Damage/Legal
Additional Umbrella Liability	\$2,000,000	Occurrence / Aggregate

CONTRACTOR shall furnish an original Certificate of Insurance indicating, and such policy providing coverage to, City of Key West named as an additional insured on a PRIMARY and NON CONTRIBUTORY basis utilizing an ISO standard endorsement at least as broad as CG 2010 (11/85) or its equivalent, (combination of CG 20 10 07 04 and CG 20 37 07 04, providing coverage for completed operations, is acceptable) including a waiver of subrogation clause in favor of City of Key West on all policies. CONTRACTOR will maintain the General Liability and Umbrella Liability insurance coverages summarized above with coverage continuing in

full force including the additional insured endorsement until at least 3 years beyond completion and delivery of the work contracted herein.

Notwithstanding any other provision of the Contract, the CONTRACTOR shall maintain complete workers' compensation coverage for each and every employee, principal, officer, representative, or agent of the CONTRACTOR who is performing any labor, services, or material under the Contract. Further, CONTRACTOR shall additionally maintain the following minimum limits of coverage:

Bodily Injury Each Accident	\$1,000,000
Bodily Injury by Disease Each Employee	\$1,000,000
Bodily Injury by Disease Policy Limit	\$1,000,000

If the work is being done on or near a navigable waterway, CONTRACTOR's workers compensation policy shall be endorsed to provide USL&H Act (WC 00 01 06 A) and Jones Act (WC 00 02 01 A) coverage if specified by the City of Key West. CONTRACTOR shall provide the City of Key West with a Certificate of Insurance verifying compliance with the workman's compensation coverage as set forth herein and shall provide as often as required by the City of Key West such certification which shall also show the insurance company, policy number, effective and expiration date, and the limits of workman's compensation coverage under each policy.

CONTRACTOR's insurance policies shall be endorsed to give 30 days' written notice to the City of Key West in the event of cancellation or material change, using form CG 02 24, or its equivalent.

Certificates of Insurance submitted to the City of Key West will not be accepted without copies of the endorsements being requested. This includes additional insured endorsements, cancellation/material change notice endorsements, and waivers of subrogation. Copies of USL&H Act and Jones Act endorsements will also be required if necessary. PLEASE ADVISE YOUR INSURANCE AGENT ACCORDINGLY.

CONTRACTOR will comply with any and all safety regulations required by any agency or regulatory body including but not limited to OSHA. CONTRACTOR will notify City of Key West immediately by telephone at (305) 809-3867 any accident or injury to anyone that occurs on the jobsite and is related to any of the work being performed by the CONTRACTOR.

Add the following Article:

G. SURETY AND INSURER QUALIFICATIONS

All bonds, insurance contracts, and certificates of insurance shall be either executed by or countersigned by a licensed resident agent of the Surety or insurance company, having his place of business in the State of Florida, and in all ways complying with the insurance laws of the State of Florida. Further, the said Surety or Insurance Company shall be duly licensed and qualified to do business in the State of Florida. If requested, Contractor shall Provide Proof of Florida Licensure for all insurance companies. The City of Key West shall be named as Additional Insured on the insurance certificates.

THIS CERTIFICATE IS ISSUED AS A MATTER OF INFORMATION ONLY AND CONFERS NO RIGHTS UPON THE CERTIFICATE HOLDER. THIS CERTIFICATE DOES NOT AFFIRMATIVELY OR NEGATIVELY AMEND, EXTEND OR ALTER THE COVERAGE AFFORDED BY THE POLICIES BELOW. THIS CERTIFICATE OF INSURANCE DOES NOT CONSTITUTE A CONTRACT BETWEEN THE ISSUING INSURER(S), AUTHORIZED REPRESENTATIVE OR PRODUCER, AND THE CERTIFICATE HOLDER.

IMPORTANT: If the certificate holder is an **ADDITIONAL INSURED**, the policy(ies) must be endorsed. If **SUBROGATION IS WAIVED**, subject to the terms and conditions of the policy, certain policies may require an endorsement. A statement on this certificate does not confer rights to the certificate holder in lieu of such endorsement(s).

PRODUCER 	CONTACT NAME:
	PHONE (A/C, No, Ext):
	FAX (A/C, No):
	E-MAIL ADDRESS:
INSURER(S) AFFORDING COVERAGE	
NAIC #	
INSURED Vendor Sample	INSURER A :
	INSURER B :
	INSURER C :
	INSURER D :
	INSURER E :
	INSURER F :

COVERAGES **CERTIFICATE NUMBER:** **REVISION NUMBER:**

THIS IS TO CERTIFY THAT THE POLICIES OF INSURANCE LISTED BELOW HAVE BEEN ISSUED TO THE INSURED NAMED ABOVE FOR THE POLICY PERIOD INDICATED. NOTWITHSTANDING ANY REQUIREMENT, TERM OR CONDITION OF ANY CONTRACT OR OTHER DOCUMENT WITH RESPECT TO WHICH THIS CERTIFICATE MAY BE ISSUED OR MAY PERTAIN, THE INSURANCE AFFORDED BY THE POLICIES DESCRIBED HEREIN IS SUBJECT TO ALL THE TERMS, EXCLUSIONS AND CONDITIONS OF SUCH POLICIES. LIMITS SHOWN MAY HAVE BEEN REDUCED BY PAID CLAIMS.

INSR LTR	TYPE OF INSURANCE	ADDL INSR	SUBR WVD	POLICY NUMBER	POLICY EFF (MM/DD/YYYY)	POLICY EXP (MM/DD/YYYY)	LIMITS
	GENERAL LIABILITY <input checked="" type="checkbox"/> COMMERCIAL GENERAL LIABILITY <input type="checkbox"/> CLAIMS-MADE <input checked="" type="checkbox"/> OCCUR GEN'L AGGREGATE LIMIT APPLIES PER: <input type="checkbox"/> POLICY <input type="checkbox"/> PRO-JECT <input type="checkbox"/> LOC	<input checked="" type="checkbox"/>	<input checked="" type="checkbox"/>				EACH OCCURRENCE \$ 1,000,000 DAMAGE TO RENTED PREMISES (Ea occurrence) \$ 300,000 MED EXP (Any one person) \$ PERSONAL & ADV INJURY \$ 1,000,000 GENERAL AGGREGATE \$ 2,000,000 PRODUCTS - COMP/OP AGG \$ 2,000,000 \$
	AUTOMOBILE LIABILITY <input checked="" type="checkbox"/> ANY AUTO <input type="checkbox"/> ALL OWNED AUTOS <input type="checkbox"/> SCHEDULED AUTOS <input checked="" type="checkbox"/> HIRED AUTOS <input checked="" type="checkbox"/> NON-OWNED AUTOS	<input checked="" type="checkbox"/>	<input checked="" type="checkbox"/>				COMBINED SINGLE LIMIT (Ea accident) \$ 1,000,000 BODILY INJURY (Per person) \$ BODILY INJURY (Per accident) \$ PROPERTY DAMAGE (Per accident) \$ \$
	<input checked="" type="checkbox"/> UMBRELLA LIAB <input checked="" type="checkbox"/> OCCUR <input type="checkbox"/> EXCESS LIAB <input type="checkbox"/> CLAIMS-MADE DED <input checked="" type="checkbox"/> RETENTION \$	<input checked="" type="checkbox"/>	<input checked="" type="checkbox"/>				EACH OCCURRENCE \$,000,000 AGGREGATE \$,000,000 \$
	WORKERS COMPENSATION AND EMPLOYERS' LIABILITY ANY PROPRIETOR/PARTNER/EXECUTIVE OFFICER/MEMBER EXCLUDED? <input type="checkbox"/> Y <input checked="" type="checkbox"/> N (Mandatory in NH) If yes, describe under DESCRIPTION OF OPERATIONS below	N/A	<input checked="" type="checkbox"/>				<input checked="" type="checkbox"/> WC STATU-TORY LIMITS <input type="checkbox"/> OTH-ER E.L. EACH ACCIDENT \$ 1,000,000 E.L. DISEASE - EA EMPLOYEE \$ 1,000,000 E.L. DISEASE - POLICY LIMIT \$ 1,000,000
	Professional Liability (if applicable)						Per Claim Aggregate \$ 1,000,000 \$ 1,000,000

DESCRIPTION OF OPERATIONS / LOCATIONS / VEHICLES (Attach ACORD 101, Additional Remarks Schedule, if more space is required)

CERTIFICATE HOLDER **CANCELLATION**

City of Key West P.O. Box 1409 Key West, FL 33041-1409	SHOULD ANY OF THE ABOVE DESCRIBED POLICIES BE CANCELLED BEFORE THE EXPIRATION DATE THEREOF, NOTICE WILL BE DELIVERED IN ACCORDANCE WITH THE POLICY PROVISIONS. AUTHORIZED REPRESENTATIVE
--	---

THIS ENDORSEMENT CHANGES THE POLICY. PLEASE READ IT CAREFULLY.

**ADDITIONAL INSURED – OWNERS, LESSEES OR
CONTRACTORS – AUTOMATIC STATUS WHEN
REQUIRED IN CONSTRUCTION AGREEMENT WITH YOU**

This endorsement modifies insurance provided under the following:

COMMERCIAL GENERAL LIABILITY COVERAGE PART

- A. Section II – Who Is An Insured** is amended to include as an additional insured any person or organization for whom you are performing operations when you and such person or organization have agreed in writing in a contract or agreement that such person or organization be added as an additional insured on your policy. Such person or organization is an additional insured only with respect to liability for "bodily injury", "property damage" or "personal and advertising injury" caused, in whole or in part, by:
1. Your acts or omissions; or
 2. The acts or omissions of those acting on your behalf;
- in the performance of your ongoing operations for the additional insured.
- A person's or organization's status as an additional insured under this endorsement ends when your operations for that additional insured are completed.
- B. With respect to the insurance afforded to these additional insureds, the following additional exclusions apply:**
- This insurance does not apply to:
1. "Bodily injury", "property damage" or "personal and advertising injury" arising out of the rendering of, or the failure to render, any professional architectural, engineering or surveying services, including:
 - a. The preparing, approving, or failing to prepare or approve, maps, shop drawings, opinions, reports, surveys, field orders, change orders or drawings and specifications; or
 - b. Supervisory, inspection, architectural or engineering activities.
 2. "Bodily injury" or "property damage" occurring after:
 - a. All work, including materials, parts or equipment furnished in connection with such work, on the project (other than service, maintenance or repairs) to be performed by or on behalf of the additional insured(s) at the location of the covered operations has been completed; or
 - b. That portion of "your work" out of which the injury or damage arises has been put to its intended use by any person or organization other than another contractor or subcontractor engaged in performing operations for a principal as a part of the same project.

POLICY NUMBER:

COMMERCIAL GENERAL LIABILITY
CG 20 10 07 04

THIS ENDORSEMENT CHANGES THE POLICY. PLEASE READ IT CAREFULLY.

**ADDITIONAL INSURED – OWNERS, LESSEES OR
CONTRACTORS – SCHEDULED PERSON OR
ORGANIZATION**

This endorsement modifies insurance provided under the following:

COMMERCIAL GENERAL LIABILITY COVERAGE PART

SCHEDULE

Name Of Additional Insured Person(s) Or Organization(s):	Location(s) Of Covered Operations
Information required to complete this Schedule, if not shown above, will be shown in the Declarations.	

A. Section II – Who Is An Insured is amended to include as an additional insured the person(s) or organization(s) shown in the Schedule, but only with respect to liability for "bodily injury", "property damage" or "personal and advertising injury" caused, in whole or in part, by:

1. Your acts or omissions; or
2. The acts or omissions of those acting on your behalf;

in the performance of your ongoing operations for the additional insured(s) at the location(s) designated above.

B. With respect to the insurance afforded to these additional insureds, the following additional exclusions apply:

This insurance does not apply to "bodily injury" or "property damage" occurring after:

1. All work, including materials, parts or equipment furnished in connection with such work, on the project (other than service, maintenance or repairs) to be performed by or on behalf of the additional insured(s) at the location of the covered operations has been completed; or
2. That portion of "your work" out of which the injury or damage arises has been put to its intended use by any person or organization other than another contractor or subcontractor engaged in performing operations for a principal as a part of the same project.

POLICY NUMBER:

COMMERCIAL GENERAL LIABILITY
CG 20 37 07 04

THIS ENDORSEMENT CHANGES THE POLICY. PLEASE READ IT CAREFULLY.

**ADDITIONAL INSURED – OWNERS, LESSEES OR
CONTRACTORS – COMPLETED OPERATIONS**

This endorsement modifies insurance provided under the following:

COMMERCIAL GENERAL LIABILITY COVERAGE PART

SCHEDULE

Name Of Additional Insured Person(s) Or Organization(s):	Location And Description Of Completed Operations
Information required to complete this Schedule, if not shown above, will be shown in the Declarations.	

Section II – Who Is An Insured is amended to include as an additional insured the person(s) or organization(s) shown in the Schedule, but only with respect to liability for "bodily injury" or "property damage" caused, in whole or in part, by "your work" at the location designated and described in the schedule of this endorsement performed for that additional insured and included in the "products-completed operations hazard".

THIS ENDORSEMENT CHANGES THE POLICY. PLEASE READ IT CAREFULLY.

**EARLIER NOTICE OF CANCELLATION
PROVIDED BY US**

Number of Days Notice 30

For any statutorily permitted reason **other than nonpayment of premium**, the number of days required for notice of cancellation is increased to the number of days shown in the Schedule above.

If this policy is cancelled by us we will send the Named Insured and any party listed in the following schedule notice of cancellation based on the number of days notice shown above.

Schedule

Name of Person or Organization

Mailing Address

POLICY NUMBER:

COMMERCIAL GENERAL LIABILITY
CG 24 04 05 09

WAIVER OF TRANSFER OF RIGHTS OF RECOVERY AGAINST OTHERS TO US

This endorsement modifies insurance provided under the following:

COMMERCIAL GENERAL LIABILITY COVERAGE PART
PRODUCTS/COMPLETED OPERATIONS LIABILITY COVERAGE PART

SCHEDULE

Name Of Person Or Organization:

Information required to complete this Schedule, if not shown above, will be shown in the Declarations.

The following is added to Paragraph 8. **Transfer Of Rights Of Recovery Against Others To Us** of Section IV – Conditions:

We waive any right of recovery we may have against the person or organization shown in the Schedule above because of payments we make for injury or damage arising out of your ongoing operations or "your work" done under a contract with that person or organization and included in the "products-completed operations hazard". This waiver applies only to the person or organization shown in the Schedule above.

WAIVER OF OUR RIGHT TO RECOVER FROM OTHERS ENDORSEMENT

We have the right to recover our payments from anyone liable for an injury covered by this policy. We will not enforce our right against the person or organization named in the Schedule. (This agreement applies only to the extent that you perform work under a written contract that requires you to obtain this agreement from us.)

This agreement shall not operate directly or indirectly to benefit anyone not named in the Schedule.

Schedule

This endorsement changes the policy to which it is attached and is effective on the date issued unless otherwise stated.

(The information below is required only when this endorsement is issued subsequent to preparation of the policy.)

Endorsement
Insured

Effective Policy No.

Endorsement No.
Premium

Insurance Company

Countersigned by _____

WC 00 03 13
(Ed. 4-84)

ARTICLE 35 “INDEMNITY”

Delete Text for Article 35 “INDEMNITY” in its entirety and substitute the following:

To the fullest extent permitted by law, the CONTRACTOR expressly agrees to indemnify and hold harmless the City of Key West, their officers, directors, agents, and employees (herein called the “indemnitees”) from liabilities, damages, losses and costs, including, but not limited to, reasonable attorney’s fees and court costs, such legal expenses to include costs incurred in establishing the indemnification and other rights agreed to in this Paragraph, to persons or property, to the extent caused by the negligence, recklessness, or intentional wrongful misconduct of the CONTRACTOR, its Subcontractors or persons employed or utilized by them in the performance of the Contract. Claims by indemnitees for indemnification shall be limited to the amount of CONTRACTOR’s insurance or \$1 million per occurrence, whichever is greater. The parties acknowledge that the amount of the indemnity required hereunder bears a reasonable commercial relationship to the Contract and it is part of the project specifications or the bid documents, if any. The indemnification obligations under the Contract shall not be restricted in any way by any limitation on the amount or type of damages, compensation, or benefits payable by or for the CONTRACTOR under workers’ compensation acts, disability benefits acts, or other employee benefits acts, and shall extend to and include any actions brought by or in the name of any employee of the CONTRACTOR or of any third party to whom CONTRACTOR may subcontract a part or all of the Work. This indemnification shall continue beyond the date of completion of the work.

ARTICLE 39 "CODES, ORDINANCES, PERMITS, AND LICENSES"

Add the following:

A. PERMIT FOR WORK WITHIN LOCAL RIGHTS OF WAY

For each Work Order issued, the Contractor shall obtain from the City of Key West the necessary permits for work within the rights of way. The Contractor shall abide by all regulations and conditions, including maintenance of traffic. RIGHT OF WAY Permit fees will be waived by the City for work within the City’s RIGHT OF WAY.

B. NOISE ORDINANCE

City of Key West has a noise ordinance that allows working hours between 8:00 AM to 7:00 PM, Monday through Friday, and 9:00 AM to 5:00 PM on Saturday. No work should be performed during Sundays or City Holidays, State Holidays and National Holidays. Any construction operations outside these hours and these days will require a variance from the City of Key West Commission.

C. "LICENSES"

THE BIDDER MUST BE A LICENSED CONTRACTOR BY THE STATE OF FLORIDA AND SUBMIT PROOF OF SUCH WITH THE BID.

1. Within 10 days of Notice of Award, the successful Bidder must represent that he holds all applicable, county, and City of Key West licenses and permits required to do business as a contractor with respect to the work described in the Contract Documents.
2. Further, the successful Bidder must, within 10 days of Notice of Award, furnish documentation showing that, as a minimum, he has complied with the provisions of Chapter 18 of the Code of Ordinances of the City of Key West in order to enter into the Agreement contained in the Contract Documents.
3. Specifically, within 10 days after Notice of Award, the successful Bidder must demonstrate that he holds, as a minimum, the following licenses and certificates:
 - a.) City of Key West Tax License Receipt;
 - b.) A valid Certificate of Competency issued by the Chief Building Official of Key West, Florida
 - c.) A valid occupational license issued by the City of Key West, Florida.

D. WORK DURING HOLIDAYS

There shall be no work during City Holidays, State Holidays and National Holidays. Any construction operations during these days shall be approved by the City of Key West Commission.

ARTICLE 40 "SUPERINTENDENCE"

Add the following sub article:

The CONTRACTOR shall keep at the project site, competent supervisory personnel, able to read, write and speak English to effectively communicate with City staff.

ARTICLE 42 "SAFETY"

Add the following sub article:

OCCUPATIONAL SAFETY AND HEALTH

The Contractor shall observe and comply with all applicable local, state, and federal occupational safety and health regulations during the prosecution of work under this Contract. In addition, full compliance by the Contractor with the U.S. Department of Labor's Occupational Safety and Health Standards, as established in Public Law 91-596, will be required under the terms of this Contract.

Add the following sub article:

The Bidder further agrees, as evidenced by signing the Bid that if awarded a Contract, the Florida Trench Safety Act and applicable trench safety standards will be complied with.

ARTICLE 43 "PROTECTION OF WORK AND PROPERTY"

Add the following Article:

HISTORIC PRESERVATION

The Contractor shall comply with Florida's Archives and Historic Act (Florida Statutes, Chapter 267) and the regulations of the local historic preservation board as applicable and protect against the potential loss or destruction of significant historical or archaeological data, sites, and properties in connection with the project.

ARTICLE 57 "OWNERS RIGHT TO TRANSFER EMPLOYMENT"

Add the following Article:

TERMINATION FOR CONVENIENCE AND RIGHT OF SUSPENSION

- A. Owner shall have the right to terminate this Contract without cause by written notice of Termination to the Contractor. In the event of such termination for convenience, the Contractor's recovery against the Owner shall be limited to that portion of the Contract amount earned through the date of termination, together with any retainage withheld and reasonable termination expenses incurred. Contractor shall not be entitled to any other or further recovery against the Owner, including, but not limited to, damages or any anticipated profit on portions of the Work not performed.
- B. The Owner shall have the right to suspend all or any portions of the Work upon giving the Contractor prior written notice of such suspension. If all or any portion of the Work is so suspended, the Contractor shall be entitled to reasonable costs, expenses and time extension associated with the suspension.

ARTICLE 60 "LIQUIDATED DAMAGES"

Delete Article "LIQUIDATED DAMAGES" in its entirety and substitute the following: LIQUIDATED DAMAGES

Should the Contractor fail to complete the work or any part thereof (e.g., individual Work Order) in the time agreed upon in the Contract Documents or within such extra time as may have been allowed for delays by extensions granted as provided in the Contract, the Contractor shall reimburse the Owner for the additional expense and damage for each calendar day, Sundays and legal holidays included, that project outlined in Contract Documents remains uncompleted after the completion date. Liquidated damages shall be assessed. It is agreed that the amount of such additional expense and damage incurred by reason of failure to complete the work is the per diem rate as stipulated in the Bid. The said amount is hereby agreed upon as a reasonable estimate of the costs which may be accrued by the Owner after the expiration of the time of completion. It is expressly understood and agreed that this amount is not to be considered in the nature of a penalty but as liquidated damages, which have accrued against the Contractor. The Owner shall have the right to deduct

such damages from any amount due or that may become due the Contractor or the amount of such damages shall be due and collectible from the Contractor or Surety.

ARTICLE 68 "PAYMENT FOR CHANGE ORDERS"

Sub article C. "COST REIMBURSEMENT WORK"

Delete the third & fourth paragraph in its entirety & substitute the following;

In addition to 1 through 5 above , an added fixed fee of 15 percent (%) for general overhead & profit shall be allowed for the CONTRACTOR (or approved SUBCONTRACTOR) actually executing the Cost Reimbursement work.

An additional fixed fee of 5% will be allowed the CONTRACTOR for the administrative handling of portions of the work that are executed by an approved SUBCONTRACTOR. No additional fixed fee will be allowed for the administrative handling of work executed by the SUBCONTRACTOR of a SUBCONTRACTOR.

ARTICLE 69 "PARTIAL PAYMENTS"

Delete the first paragraph of Sub article B. "ESTIMATE" and substitute the following:

No more than once each month the Contractor shall submit to the Engineer a detailed estimate of the amount earned during the preceding month for the separate portions of the work and request payment. As used in this Article the words "amount earned" means the value, on the date of the estimate, for partial payment of the work completed in accordance with the Contract Documents and the value of approved materials delivered to the project site suitably stored and protected prior to incorporation into the work. Payment will be made by the Owner to the Contractor within 40 days receipt of the written recommendation of payment from the Engineer.

Sub Article C. "DEDUCTION FROM ESTIMATE"

Delete fourth sentence in its entirety and substitute the following;

The OWNER shall hold retainage for an individual Work Order until such time as work associated with that Work Order is deemed complete by the OWNER.

Delete Sub article E. "PAYMENT" in its entirety and substitute the following:

After deducting the retainage and the amount of all previous partial payments made to the Contractor from the amount earned the amount due will be made payable to the Contractor.

ARTICLE 72 "FINAL PAYMENT"

Delete Article "FINAL PAYMENT" in its entirety and substitute the following:

FINAL PAYMENT

Upon completion of the an individual Work Order, the Contractor shall notify the Engineer, in writing, that he has completed it and shall request final payment for that Work Order. The Contractor shall be responsible for keeping an accurate and detailed record of his actual construction. Upon completion of construction and before final acceptance and payment the Contractor shall furnish the Engineer as-built drawings of his construction. Upon receipt of a request for final payment and the as-built drawings the Engineer will inspect and, if acceptable, submit to the Owner his recommendation as to acceptance of the completed work and as to the final estimate of the amount due the Contractor. Upon approval of this final estimate by the Owner and compliance by the Contractor with provisions in Article RELEASE OF LIENS OR CLAIMS, and other provisions as may be applicable, the Owner shall pay to the Contractor all monies due him under the provisions of these Contract Documents.

* * * * *

PART 4: GENERAL REQUIREMENTS

01001: GENERAL REQUIREMENTS

PART 1 - GENERAL

1.1 PROJECT DESCRIPTION

- A. The following information though not all-inclusive, is given to assist Contractors in the evaluation of the work required to meet the project objectives.
- B. A brief description of the work is stated in the Invitation to Bid. To determine the full scope of the project or of any particular part of the project, coordinate the applicable information in the several parts of these Contract Documents.
- C. Individual project assignments shall be in accordance with Work Orders approved by the City's Engineering Project Manager and issued for the specific project. Work Order costs will be based on unit prices included in the Bid Proposal. Each Work Order shall include a project duration.

1.2 FDOT SPECIFICATIONS

- A. Portions of The Florida Department of Transportation (FDOT) Standard Specifications for Road and Bridge Construction and their Roadway and Traffic Design Standards, hereinafter referred to as the DOT Specifications, are referred to herein and amended, in part, and the same are hereby made a part of this Contract to the extent of such references and shall be as binding upon the Contract as though reproduced herein. Such reference shall mean the current edition, including all supplements. In case of a conflict in the requirements of the DOT Specifications and the requirements stated herein, the requirements herein shall prevail.

1.3 MOBILIZATION AND DEMOBILIZATION

- A. Contractor shall be responsible for mobilization and demobilization of labor, materials and equipment. Payment for mobilization and demobilization will be included in the unit price indicated in the BID.
- B. DAILY REPORTS
 - 1) The CONTRACTOR shall maintain daily reports of construction activities for each site. The report shall include:
 - a) Manpower, number of men by craft
 - b) Quality Control
 - c) Equipment on the Project
 - d) Major deliveries
 - e) Activities worked with reference to the Work Order items
 - f) New problems
 - g) Other pertinent information
 - 2) The reports shall be submitted to the ENGINEER upon request.

1.4 SCHEDULING

- A. Plan the work and carry it out with minimum interference to the operation of the existing facilities. Prior to starting the work, confer with the Engineer and Owner's representative to develop an approved work schedule, which will permit the facilities to function as normally as practical. It may be necessary to do certain parts of the work outside normal working hours in order to avoid undesirable conditions. The Contractor shall do this work at such times and at no additional cost to the Owner.
- B. SPECIAL EVENTS: Contractor may be asked to stop work during special events. No work will be allowed for intersections (TBD) on days corresponding to the events and schedule listed below. All material and equipment shall be totally off all streets by 5:00 P.M. the day before these dates:

No work on roads and streets shall be allowed to interfere with polling locations open on election days. Monroe County Precincts (as of 2016)

PRECINCT#	ADDRESS	CITY
Prec. #1	Jaycee Clubhouse, 3825 Flagler Avenue.	Key West
Prec. #2	Key West High School Auditorium, 2100 Flagler Ave.	Key West
Prec. #3	Key West High School Auditorium, 2100 Flagler Ave.	Key West
Prec. #4	Martin Luther King Community Pool, 300 Catherine St.	Key West
Prec. #5	Old City Hall, 510 Greene Street.	Key West
Prec. #6	<u>NEW</u> : Gato Building, 1100 Simonton St, Conference Room 1st Floor.	Key West
Prec. #7	Moose Club, 700 Eisenhower Dr.	Key West
Prec. #8	Glad Tiding Tabernacle Assembly of God 1209 United St (Georgia St Entrance).	Key West
Prec. #9	Senior Citizens Plaza Auditorium (Rear Entrance), 1400 Kennedy Dr.	Key West
Prec. #10	<u>NEW 2016</u> : Senior Citizens Plaza Auditorium (Rear Entrance), 1400 Kennedy Dr.	Key West

1.5 COORDINATION

- A. Contractors shall cooperate in the coordination of their separate activities in a manner that will provide the least interference with the Owner's operations and other contractors and utility companies working in the area, and in the interfacing and connection of the separate elements of the overall project work.
- B. If any difficulty or dispute should arise in the accomplishment of the above, the problem shall be brought immediately to the attention of the Engineer.

1.6 WORK TO BE PERFORMED BY OTHERS

- A. During the construction period for this project, the Owner (either with his own forces or under a separate contract) may be performing work that may require the cooperation of the Contractors in scheduling and coordination to avoid conflicts.
- B. If any difficulty or dispute should arise in the accomplishment of the above, the problem shall be brought immediately to the attention of the Engineer.
- C. All Contractors working on this site are subject to this requirement for cooperation, and all shall abide by the Engineer's decision in resolving project coordination problems without additional cost to the Owner.

1.7 SITE INVESTIGATION AND REPRESENTATION

- A. The Contractor acknowledges satisfaction as to the nature and location of the work, the general and local conditions, particularly those bearing upon availability of transportation, access to the site, disposal, handling and storage of materials, availability of labor, water, electric power, roads, and uncertainties of weather, or similar physical conditions at the site, the conformation and conditions of the ground, the character of equipment and facilities needed preliminary to and during the prosecution of the work, and all other matters which can any way affect the work or the cost thereof under this Contract.
- B. The Contractor further acknowledges satisfaction as to character, quality, and quantity of surface and subsurface materials to be encountered from his inspection of the site and from reviewing any available records of exploratory work furnished by the Owner or included in these Documents. Failure by the Contractor to become acquainted with the physical conditions of the site and all available information will not relieve the Contractor from responsibility for properly estimating the difficulty or cost of successfully performing the work.
- C. The Contractor warrants that as a result of examination and investigation of all the aforesaid data, the contractor can perform the work in a good and workmanlike manner and to the satisfaction of the Owner.
- D. The Owner assumes no responsibility for any representations made by any of its officers or agents during or prior to the execution of this Contract, unless (1) such representations are expressly stated in the Contract, and (2) the Contract expressly provides that the responsibility therefore is assumed by the Owner.

1.8 INFORMATION ON SITE CONDITIONS

- A. General: Any information obtained by the Engineer regarding site conditions, subsurface information, water level, existing construction of site facilities as applicable, and similar data will be available for inspection at the office of the Engineer upon request. Such information is offered as supplementary information only. Neither the Engineer nor the Owner assumes any responsibility for the completeness or interpretation of such supplementary information.

1.9 DIFFERING SUBSURFACE CONDITIONS

- A. The Engineer shall investigate such conditions promptly and following this investigation, the Contractor shall proceed with the work, unless otherwise instructed by the Engineer. If the Engineer finds that such conditions do so materially differ and cause an increase or decrease in the cost of, or in the time required for performing the work, the Engineer will recommend to the Owner the amount of adjustment in cost and time he considers reasonable. The Owner will make the final decision on all Change Orders to the Contract regarding any adjustment in cost or time for completion.

1.10 UTILITIES

- A. During excavation the Contractor shall be responsible for determining, at his cost, the locations of all known utilities in the project area.
- B. Contractor shall notify utility location service (e.g. Call Sunshine 1-800-432-4770) a minimum for 48 hours prior to work order mobilization. Assigned notification number shall be maintained at the job site at all times and recorded in the daily reports.

1.11 CONTRACTOR'S RESPONSIBILITY FOR UTILITY PROPERTIES AND SERVICE

- A. Where the Contractor's operations could cause damage or inconvenience to telephone, television, gas, water, sewer, or irrigation systems, the operations shall be suspended until all arrangements necessary for the protection of these utilities and services have been made by the Contractor.
- B. Notify all utility offices, which are affected by the construction operation at least 48 hours in advance. Under no circumstances expose any utility without first obtaining permission from the appropriate agency. Once permission has been granted, locate, expose, and provide temporary support for all existing underground utilities.
- C. The Contractor shall be solely and directly responsible to the Owner and operators of such properties for any damage, injury, expense, loss, inconvenience, delay, suits, actions, or claims of any character brought because of any injuries or damage which may result from the construction operations under this Contract
- D. Neither the Owner nor its Officers or agents shall be responsible to the Contractor for damages as a result of the Contractor's failure to protect utilities encountered in the work.
- E. In the event of interruption to domestic water, sewer, storm drain, or other utility services as a result of accidental breakage due to construction operations, promptly notify the proper authority. Contractor shall cooperate with said authority in restoration of service as promptly as possible and the contractor shall bear all costs of repair. In no case shall interruption of any water or utility service be allowed to exist outside working hours unless prior approval is granted.
- F. In the event the Contractor encounters water service lines that interfere with trenching, he may, by obtaining prior approval of the property owner, Florida Keys Aqueduct Authority (FKAA), or Fire

Department as applicable, and the ENGINEER, cut and restore service with similar and equal materials at the Contractor's expense.

- G. The Contractor shall replace, at his own expense, all existing utilities or structures removed or damaged during construction, unless otherwise provided for in these Contract Documents or ordered by the Engineer.

1.12 TEMPORARY WATER

- A. The Contractor shall make his own arrangements to obtain suitable water for any need and shall pay all costs.

1.13 TEMPORARY ELECTRIC POWER

- A. The Contractor shall make his own arrangements to obtain and pay for electrical power used until final acceptance by the Owner.

1.14 SAFETY REQUIREMENTS FOR TEMPORARY ELECTRIC POWER

- A. Temporary electric power installation shall meet the construction Safety requirements of NEC, OSHA, State, and other governing agencies.

1.15 SANITARY FACILITIES

- A. The Contractor shall provide and maintain sanitary facilities for his employees and his subcontractor's employees that will comply with the regulations of the local and State Departments of Health and as directed by the Owner.

1.16 STORAGE OF MATERIALS

- A. Materials shall be so stored as to ensure the preservation of their quality and fitness for the work. When considered necessary, they shall be placed on wooden platforms or other clean hard surfaces and not on the ground. Materials stored shall be located so as to facilitate prompt inspection. Materials stored in the Right of Way shall be fully barricaded and must be fitted with lights at night. Private property shall not be used for storage purposes without the written permission of the owner or lessee. Materials shall not be stored where access to any structure, plot, or road is blocked. Location of stored materials must be approved by the ENGINEER or his designee.
- B. Delicate instruments and materials subject to vandalism shall be placed under lock and cover and, if necessary, provided with temperature control as recommended by the manufacturer.

1.17 CONSTRUCTION SAFETY PROGRAM

- A. The Contractor shall develop and maintain for the duration of this Contract, a safety program that will effectively incorporate and implement all required safety provisions. The Contractor shall appoint an employee who is qualified and authorized to supervise and enforce compliance with the safety program.

- B. The duty of the Engineer to conduct construction review of the Contractor's performance is not intended to include a review or approval of the adequacy of the Contractor's safety supervisor, the safety program or any safety measures taken in, on, or near the construction site.
- C. The Contractor shall do all work necessary to protect the general public from hazards, including, but not limited to, surface irregularities, or unramped grade changes in pedestrian sidewalk or roadway. Barricades, lights, and proper signs shall be furnished in sufficient amount to safeguard the public and the work.
- D. The performance of all work and all completed construction, particularly with respect to ladders, platforms, structure openings, scaffolding, shoring, lagging, machinery guards and the like, shall be in accordance with the applicable governing safety authorities.
- E. During construction, the Contractor shall construct and at all times maintain satisfactory and substantial temporary chain link fencing, solid fencing, railing, barricades or steel plates, as applicable, at all openings, obstructions, or other hazards in streets, sidewalks, floors, roofs, and walkways. All such barriers shall have adequate warning lights as necessary, or required for safety. Also all barriers shall have a lower horizontal continuous frame member at a maximum of 17" above grade.

1.18 ACCIDENT REPORTS

- A. If death or serious injuries or serious damages are caused; the Contractor must promptly report by telephone or messenger to the Engineer. In addition, the Contractor must promptly report in writing to the Engineer all accidents whatsoever arising out of or in connection with, the performance of the work whether on, or adjacent, to the site, giving full details and statements of witnesses.
- B. If a claim is made against the Contractor or any subcontractor on account of any accident, the Contractor shall promptly report the facts in writing to the Engineer, giving full details of the claim.

1.19 TRAFFIC MAINTENANCE AND SAFETY

- A. Comply with all rules and regulations of the state, county, and city authorities regarding closing or restricting the use of public streets or highways. No public or private road shall be closed, except by express permission of the owner. Conduct the work so as to assure the least possible obstruction to traffic and normal commercial business operations. Protect all obstructions within traveled roadways by installing approved signs, barricades, and lights where necessary for the safety of the public. The convenience of the general public and residents adjacent to the project and the protection of persons and property are of prime importance and shall be provided for in an adequate and satisfactory manner.
- B. Maintenance of Traffic shall be maintained at all construction sites until the work is either completed or any open trenches have been properly covered and all equipment is properly stored. Contractor shall maintain Maintenance of Traffic (MOT) signs in good repairs and required MOT

lights should be operative at all times. The Owner shall stop work if MOT is not properly maintained; there shall not be any additional cost to the Owner for this downtime.

- C. When flagmen and guards are required by regulation, permits, or when deemed necessary for safety, they shall be furnished with approved orange wearing apparel and other regulation traffic-control devices. Flaggers shall be certified by State approved agency.
- D. MOT plans shall be submitted with the Work Order Right of Way Permit application for review and approval by the Engineering Department.

1.20 STREET MAINTENANCE

- A. CONTRACTOR shall notify all residents and proprietors adjacent to construction site of work to be performed, more specifically the notice shall state the day and time construction will begin, the name and phone number of the Contractor's representative responsible for the completion of the proposed improvements. Notice shall also include the Owner's representative for the project.

1.21 FIRE PREVENTION AND PROTECTION

- A. The Contractor shall perform all work in a fire-safe manner and shall supply and maintain on the site adequate fire-fighting equipment capable of extinguishing incipient fires. The Contractor shall comply with applicable federal, state, and local fire-prevention regulations. Where these regulations do not apply, applicable parts of the National Fire Prevention Standard for Safeguarding Building Construction Operations (NFPA No. 241) shall be followed.

1.22 HURRICANE PREPAREDNESS PLAN

- A. Within 30 days of the date of Notice to Proceed, the CONTRACTOR shall submit to the ENGINEER and City Representative a Hurricane Preparedness Plan. The plan should outline the necessary measures which the CONTRACTOR proposes to perform at no additional cost to the OWNER in case of a hurricane warning.
- B. In the event of inclement weather, or whenever Owners Representative shall direct, CONTRACTOR will, and will cause Subcontractors to protect carefully the Work and materials against damage or injury from the weather. If, in the opinion of Owner's Representative, any portion of Work or materials shall have been damaged or injured by reason of failure on the part of CONTRACTOR or any Subcontractors to so protect the Work, such Work and materials shall be removed and replaced at the expense of the CONTRACTOR.

1.23 SITE RESTORATION AND CLEANUP:

- A. At all times during the work keep the premises clean and orderly and upon completion of daily work repair all damage caused by equipment and leave the project free of rubbish or excess materials of any kind.
- B. Stockpile excavated materials in a manner that will cause the least damage to adjacent lawns, grassed areas, gardens, shrubbery, or fences regardless of whether these are on private property, or

State, County, or City Right of Way. Remove all excavated materials from grassed and planted areas, and leave these surfaces in a condition equivalent to their original condition.

1.24 FINISHING OF SITE, BORROW, AND STORAGE AREAS

- A. Upon completion of the project, all areas used by the Contractor shall be properly cleared of all temporary structures, rubbish and waste materials and properly graded to drain and blend in with the abutting property. Areas used for the deposit of waste materials shall be finished to properly drain and blend in with the surrounding terrain.

1.25 AREA CLEANUP DURING CONSTRUCTION

- A. Thoroughly clean all spilled dirt, gravel, sand, concrete, or other foreign materials caused by the construction operations from all streets and roads, grass, pathways, or concrete walkways and from adjacent areas at the conclusion of each day's operation. Wet concrete is not to be stored, dumped, or placed on the ground or other structures on any City property at any time. Truck or equipment wash down is not to be performed on City Property.

1.26 PREVENTION

- A. Give all unpaved areas used in the construction area an approved dust-preventive treatment or periodically water to prevent dust during construction. Applicable environmental regulations for dust prevention shall be strictly adhered to.

1.27 PAYMENT

- A. The cost of the work in this section is considered incidental to the contract.

PART 2 – Not used

PART 3 – Not used

END OF SECTION

01014: ENVIRONMENT PROTECTION

PART 1 GENERAL

1.1 GENERAL

- A. The Contractor shall maintain all work areas within and outside the project boundaries free from environmental pollution, which would be in violation to any federal, state, or local regulations.
- B. The work specified in this Section consists of designing, providing, maintaining and removing temporary erosion and sedimentation controls as necessary.
- C. Temporary erosion controls include, but are not limited to, grassing, mulching, watering, and reseeding on-site surfaces and spoil and borrow area surfaces and providing interceptor ditches at ends of berms and at those locations which will ensure that erosion during construction will be either eliminated or maintained within acceptable limits as established by the OWNER.
- D. Temporary sedimentation controls include, but are not limited to, silt dams, traps, barriers, and appurtenances at the foot of sloped surfaces which will ensure that sedimentation pollution will be either eliminated or maintained within acceptable limits as established by the OWNER.
- E. CONTRACTOR is responsible for providing effective temporary erosion and sediment control measures during construction or until final controls become effective.

1.2 PROTECTION OF AIR QUALITY

- A. The air pollution likely to occur due to construction operations shall be minimized by wetting down bare soils during windy periods, requiring the use of properly operating combustion emission control devices on construction vehicles and equipment used by contractors, and by encouraging the shutdown of motorized equipment not actually in use.
- B. Trash burning will not be permitted on the construction site.
- C. Contractor shall provide dust control for any asphalt / concrete removal and during the asphalt milling operations.

1.3 CONSTRUCTION NOISE CONTROL

- A. The Contractor shall conduct all his work, use appropriate construction methods and equipment, and furnish and install acoustical barriers, all as necessary so that no noise emanating from the process or any related tool or equipment will exceed legal noise levels, as set forth in the Code of Ordinances, City of Key West, Florida.

1.5 PAYMENT

- A. Payment for the work associated with this Section will be incidental to the contract.

PART 2 – Not used

PART 3 – Not used

END OF SECTION

01020: SUMMARY OF WORK

PART 1 - GENERAL

1.1 DESCRIPTION

- A. Work Included: Furnishing all materials, equipment and labor for the construction and/ or replacement of pavement overlay and reconstruction, shoulder restoration, sidewalks, curbs, gutters, crosswalks, site clean-up, and all necessary appurtenances and incidental work to provide a complete and serviceable project identified as:

**CITY OF KEY WEST, FLORIDA
RIGHT OF WAY IMPROVEMENTS 2017**

- B. Related requirements in other parts of the Contract Documents: General Conditions of the Contract for Construction.
- C. Contractor's Duties:
1. In addition to provisions stipulated in other portions of the Contract Documents, the Contractor shall:
 - a. Secure permits (including City of Key West Right of Way Permit) as necessary for proper execution and completion of the work.
 - b. Hand-out notices to all residents in immediate project area detailing the work and schedule of completion.
 - c. Video tape project area and submit to City before commencing work
 2. The Contractor shall be totally responsible for all permits required and shall ensure that construction complies with all applicable local, state, and federal codes.
 3. Provide an experienced, qualified, and competent Superintendent to oversee the Work. Prior to starting construction, the Proposed Superintendent's qualifications shall be submitted in writing to the City for approval. The approved Superintendent shall be expected to remain for the duration of the Project, unless the Owner or Engineer deem him inadequate and requests his removal or the Contractor cannot continue his services to the project for a reason or reasons that shall be communicated to the Owner. A replacement Superintendent shall be required to follow the same approval process as required for the original.
 4. It shall be the Contractor's responsibility to request approval for performance of work other than 8:00 am until 7:00 pm Monday through Friday.

5. The Contractor shall provide two (2) copies of Material Safety Data Sheets (MSDS) for chemicals, paints, coatings and materials used on-site prior to initiation of work.

1.2 CONTRACTOR'S USE OF PREMISES

- A. Work shall be scheduled as to not interfere with on-going area activities.
- B. Coordinate use of premises and requirements for security under direction of City.
- C. Assume full responsibility for the protection and safekeeping of products under this Contract, stored on the site.
- D. Obtain and pay for the use of additional storage or work areas needed for operation.
- E. Contractor shall provide drinking water and sanitary facilities for construction personnel

1.3 MAINTENANCE OF EXISTING UTILITIES OPERATION

- A. Provide at least three weeks' notice prior to interruption of utility services for temporary or permanent connections.
- B. Keep interruption of utility services, including disconnection, moving, and reconnection times, to a minimum.

1.4 ASPHALT PAVEMENT

Work necessary for asphalt pavement construction shall include but is not limited to maintenance of traffic, existing surface demolition, subgrade excavation, material removal and disposal, utility installation/adjustments, flowable fill installation, asphalt milling, subgrade preparation, base rework/construction, asphalt installation, roadway signage, and roadway striping.

1.5 CONCRETE SIDEWALK

Work necessary for concrete sidewalk and appurtenance construction shall include but is not limited to maintenance of traffic, existing surface demolition, subgrade excavation, material removal and disposal, utility installation/adjustments, flowable fill installation, asphalt milling, subgrade preparation, base rework/construction, asphalt installation, concrete curb and gutter construction, Endicott detectable warning installation, roadway signage, and roadway striping.

1.6 SHOULDER RESTORATION

Work necessary for the construction of shoulder restoration shall include but is not limited to maintenance of traffic, existing surface demolition, subgrade excavation, material removal, utility installation/adjustment, and installation of washed 57 stone backfill.

1.7 PROPOSED WORK LOCATIONS

Work associated with this contract is anticipated to include, but may not be limited to, the locations listed in the following paragraphs. The Owner reserves the right to add or delete locations.

A. Asphalt Paving Locations

<u>Street / Segment</u>	<u>Proposed Work</u>
Ann Street (Front Street to Caroline Street)	Mill and Pave
Dey Street (Simonton Street to Elizabeth Street)	Mill and Pave
Greene St. (Duval to Simonton)	Mill & Pave
Southard Street (White to Whitehead)	Reconstruction
Kennedy Drive (South Roosevelt to Flagler)	Mill & Pave
Venetia Street (Bertha Street to Duncombe Street)	Mill and Pave
Duncombe Street (Flagler Avenue to Venetia Street)	Mill and Pave
Jose Marti Drive (Roosevelt Boulevard to Virginia Street)	Reconstruction
Whitehead Street (Virginia Street to United Street)	Mill and Pave
Windsor Lane (Olivia to Truman)	Mill & Pave
Grinnell Street (Eaton to Caroline)	Mill & Pave

- Notes: 1. Asphalt Paving Estimated Quantities – 24,000 SY
 2. Mill and Pave - Mill existing pavement 2 inches and replace with 2” (two lifts) of new asphalt or as directed by Project Manager
 3. Reconstruction – Removal of existing asphalt and rework existing base and /or add base material; pave with 2 inches of new asphalt (two lifts) or as directed by Project Manager.

B. Sidewalk and ADA Ramp Locations

<u>Street / Segment</u>	<u>Proposed Work</u>
Whitehead St. (Truman to Julia / Westside)	remove & replace & ADA
Whitehead St. (Julia to Virginia / Both Sides)	remove & replace & ADA
Whitehead St. (Virginia to Amelia / East Side)	remove & replace & ADA

<u>Street / Segment</u>	<u>Proposed Work</u>
Seminary St. (Whalton to United / Northside)	install sidewalk & ADA
19th St.,20th St.& Donald Ave. (Donald to Duck to 19 th Terrace)	remove, replace, install sidewalk with ADA
James St. (Eaton to Grinnell)	install sidewalk & ADA
Virginia (White to Georgia)	remove replace sidewalk & ADA
White St. (Atlantic to Eaton)	remove replace sidewalk & ADA
Jose Marti (North Roosevelt to Virginia)	remove replace sidewalk & ADA

Notes: 1. Sidewalk Estimated Quantities – 5560 SY
2. Typical sidewalk shall be 5’ wide except where directed by Engineer to match existing

C. Swale /Shoulder Restoration Locations

<u>Street / Segment</u>	<u>Proposed Work</u>
2900 Fogarty	Swale/Shoulder Restoration
Tenth & Eleventh Avenue	Swale/Shoulder Restoration
8th thru 5th Street (Flagler to North Roosevelt)	Swale/Shoulder Restoration
Fogarty St. (Eighth to George)	Swale/Shoulder Restoration

Notes: 1. Swale/Shoulder Restoration Estimated Quantities – 24,000SY
2. Swale/Shoulder Restoration to be performed in accordance with the Standard Details herein.

All Quantities shown herein are approximate and for Bid purposes only. Actual Quantities will be on a per Work Order basis issued by ENGINEER. **City staff reserves the right to change, delete, add or revise any paving, sidewalk or shoulder projects listed above due to need, time or for monetary reasons.**

END OF SECTION

01025: MEASUREMENT AND PAYMENT

PART 1 GENERAL

1.1 GENERAL

- A. The CONTRACTOR shall receive and accept the compensation as provided in the BID and the Contract in full payment for performing all operations necessary to complete the work under this Contract, and also in full payment for all loss or damages arising from the nature of the work, until the final acceptance by the OWNER.

- B. The Unit prices stated in the Bid include all costs and expenses for performing and completing the work as ordered and as described in the Contract Documents, details, technical specifications, and specified herein. Measurement and payment for an item at a Unit Price or Lump Sum shown in the Bid shall be in accordance with the description of the item in this section.

- C. The CONTRACTOR'S attention is called to the fact that the quotations for various items of work are intended to establish a total price for completing the work. Should the CONTRACTOR feel that the cost for an item has not been established in the BID, or this section, they shall include the cost for that work in an applicable BID item, so that this bid reflects his total Unit Prices and Aggregate Sums for completing the work in its entirety.

- D. The quantities for payment under this Contract shall be determined by actual measurement of completed items, in-place, and ready for service and accepted by the OWNER, in accordance with the applicable method of payment therefore contained herein. The CONTRACTOR shall designate and provide a representative to be present at, to witness, and to assist in the making of field measurement of payment.

1.2 MEASUREMENT GENERAL

- A. Whenever pay quantities of material are determined by weight, the material shall be weighed on scales furnished by CONTRACTOR and certified accurate by the state agency responsible. A weight or load slip shall be obtained from the scale operator and delivered to the OWNER'S representative at the point of delivery of the material.

- B. Vehicles used to haul material being paid for by weight shall be weighed empty daily and at such additional times as required by ENGINEER. Each vehicle shall bear a plainly legible identification mark.

- C. All materials which are specified for measurement by the cubic yard "measured in the vehicle" shall be hauled in vehicles of such type and size that the actual contents may be readily and accurately determined. Unless all vehicles are of uniform capacity, each vehicle must bear a plainly legible identification mark indicating its water level capacity. All vehicles shall be loaded to at least their water level capacity. Loads hauled in vehicles not meeting the above requirements or loads of a quantity less than the capacity of the vehicle, measured after being leveled off as above provided, will be subject to rejection, and no compensation will be allowed for such

material.

D. Units of measure shown on the Bid shall be as follows unless specified otherwise.

<u>Item</u>	<u>Method of Measurement</u>
CY	Cubic Yard: Field Measure Calculated by ENGINEER within the limits specified or shown
EA	Each: Field Count by ENGINEER
LF	Linear Foot: Field Measure by ENGINEER
LS	Lump Sum: Unit is one; no measurement will be made
SF	Square Foot: Measurement & calculation by ENGINEER
SY	Square Yard: Measurement & calculation by ENGINEER
TON	Ton: Haul tickets signed by ENGINEER

1.3 PAYMENT

- A. General: Progress payments on individual Work Orders will be made monthly based on the date of Work Order issuance.
- B. Payment for all Work shown or specified in the Contract Documents is included in the Contract Price. No measurement or payment will be made for individual items except as itemized herein as unit price items.
- C. Payment will not be made for following:
1. Loading, hauling, and disposing of rejected material.
 2. Quantities of material wasted or disposed of in manner not called for under Contract Documents.
 3. Rejected loads of material, including material rejected after it has been placed by reason of failure of CONTRACTOR to conform to provisions of Contract Documents.
 4. Material not unloaded from transporting vehicle.
 5. Defective Work not accepted by OWNER.
 6. Material remaining on hand after completion of Work.

1.4 DESCRIPTION OF BID ITEMS

- A. Performance and Payment Bonds (NS-7) shall be paid per individual work order total cost based on unit price per \$1,000 in the Bid Proposal.
- B. Mobilization/Demobilization (Item 0101-1) shall be paid at the unit price \$5,000.00 per each Work Order issued. Mobilization includes Maintenance of Traffic and General & Supplementary Conditions.
- C. Reworking Existing Limerock Base (Item 0210-1-1) shall be paid at the unit price per square yard of base course material reworked and tested as stated in the CONTRACTOR's Bid and shall constitute full compensation for all earthwork required for this work. Asphalt removal is included in the unit price bid for reworking existing base.
- D. Limerock Stabilized Base (Item 0230-1) shall be paid at the unit price per square yard of limerock as stated in the CONTRACTOR's Bid and shall constitute full compensation for furnishing and delivering the limerock. All other labor, materials, equipment, compaction, testing and incidentals necessary to complete the work shall be considered incidental to the unit price as stated in the CONTRACTOR's Bid.
- E. Asphalt Milling (Item 0327-70-5) ordered by the ENGINEER will be paid at the unit price per square yard of asphalt concrete pavement milled as stated in the CONTRACTOR's Bid, and shall constitute full compensation for all asphalt concrete pavement milled beyond that considered to be incidental and required for connections to existing pavement. No compensation will be paid for milling in areas damaged due to the CONTRACTOR's failure to protect surface.
- F. Asphalt Concrete Courses (Items 0334-1-13 and 0337-7-54) Payment for the asphalt concrete pavement courses will be made at the unit price per ton of concrete asphalt stated in the CONTRACTOR's Bid, and shall constitute full compensation for furnishing and applying the tack coat, furnishing, laying, and compacting. Measurement for payment will be based on the number of tons (2,000 pounds) of asphalt concrete incorporated in the pavement, as weighed on tested scales. Present trip ticket to the ENGINEER for signature as the material is delivered. Each trip ticket will show the date and time of delivery, truck number or driver's name, net weight of the material, and shall be considered as valid delivery receipts only when signed by the ENGINEER. Payment will be made only for the items of work shown in the Schedule of Unit Prices and individual Work Order. All other labor, materials, equipment, testing and incidentals necessary to complete the work shall be considered incidental to the unit prices shown in the Bid.
- G. Utility Appurtenance Extensions and Replacements (Items 0425-3-50, 0425-6, 0425-7, 0425-8, 1080-11201, and 1080-15) including extensions of valves, valve boxes, meter boxes, manholes, catch basins, inlets or other appurtenances and replacement of valve and meter boxes will include full compensation for all work and materials required to raise, lower, extend, move (horizontally) or replace each appurtenance. All adjustments of Valve/Meter boxes, Manhole Cover and other applicable structures must be completed prior to installation of adjacent concrete and/or asphalt. Payment for utility appurtenance extensions and replacements will be based on the unit price for each extension stated in the CONTRACTOR's Bid.

- H. Curbs and Gutters (Items 0520-1-10, 0520-2-4 and NS-3) shall be paid by the lineal foot of curb, curb and gutter, or thickened edge constructed at unit prices stated in the CONTRACTOR's BID. Payment shall be considered full compensation for furnishing all labor, materials, and equipment to complete the work. Payment for replacing curbs damaged by contractor will be incidental to the contract.
- I. Concrete Sidewalks (Items 0522-1 and 0522-2) shall be paid by the square yard of concrete surface at unit prices stated in the CONTRACTOR's BID. Payment shall be considered full compensation for demolition and removal of existing concrete sidewalks, furnishing all labor, materials, and equipment to complete the work as specified under this section. There will be no payment for replacing sidewalks damaged by contractor as that work is incidental to the contract.
- J. Detectable Warnings (Item 0527-2) shall be paid by the square foot of detectable warnings installed as stated in the CONTRACTOR's Bid and shall constitute full compensation for all labor, materials and equipment required for this work. Endicott brick with truncated domes or equal shall be used on all ADA crossings.
- K. Sod (Item 0570-1-2) shall be paid at the unit price per square yard of sod as stated in the CONTRACTOR's Bid and shall constitute full compensation for all labor, materials and equipment required for this work.
- L. Retro-Reflective Pavement Markers (Item 0706-3) shall be paid per each marker at the unit price stated in the CONTRACTOR's Bid and shall constitute full compensation for furnishing and installing said marker.
- M. Thermoplastic Pavement Striping (Items 0711-11121, 0711-11123, 0711-11124, 0711-11125, 0711-11221, 0711-11223, 0711-11224, and 0711-11421) shall be paid by the lineal foot of striping as stated in the CONTRACTOR's Bid and shall constitute full compensation for furnishing and installing striping, including temporary striping.
- N. Painted Pavement Striping (Items 0710-11111, 0710-11211, and 0710-11421) shall be paid by the lineal foot of striping as stated in the CONTRACTOR's Bid and shall constitute full compensation for furnishing and installing striping.
- O. Thermoplastic Pavement Markings (Items 0711-11160, 0711-11170, and 0711-11460) shall be paid per each marking stated in the CONTRACTOR's Bid and shall constitute full compensation for furnishing and installing said marking including temporary markings.
- P. New Single Post Sign and New Sign (Item NS-1) shall be paid for each sign at the unit price as stated in the CONTRACTOR's Bid and shall constitute full compensation for furnishing and installation.
- Q. Single Post Sign Reusing Existing Sign (NS-2) shall be paid for each sign post at the unit price as stated in the CONTRACTOR's Bid and shall constitute full compensation for removal, furnishing and installation of the new pole and existing sign.

- R. Shoulder Restoration (Item NS-4) shall be paid at the unit price per square yard of restoration as stated in the CONTRACTOR's Bid and shall constitute full compensation for all labor, materials and equipment required for this work.
- S. Seepage Trench (Item NS-5) shall be paid at the unit price per lineal foot of trench construction as stated in the CONTRACTOR's Bid and shall constitute full compensation for all labor, materials and equipment required for this work.
- T. Failed Trench Restoration (Item NS-6) shall be paid at the unit price per square yard of trench restoration as stated in the CONTRACTOR's Bid and shall constitute full compensation for all labor, materials, equipment, compaction, testing and incidentals required for this work.

END OF SECTION

01050: FIELD ENGINEERING

PART 1 - GENERAL

1.1 DESCRIPTION:

A. Work Included:

1. Provide field-engineering services required for the Project, including but not limited to survey work required in execution of the Work.

B. Related Work:

1. General and Supplementary Conditions of the Contract.
2. Section 01020 Summary of Work.

1.2 SUBMITTALS:

- A. Upon request of the City's Engineer, submit documentation to verify accuracy of field engineering work.
- B. Upon request, submit certificates signed by the Surveyor or Engineer certifying that elevations and locations of the work of this Project are in conformance, or non-conformance, with the Contract Documents.

PART 2 – MATERIALS (not used)

PART 3 - EXECUTION

3.1 EXAMINATION AND PREPARATION OF SITE

- A. Before starting operations, Contractor shall examine work site to acquaint himself with conditions to be encountered.
- B. Compare actual site with drawings and specifications.
- C. Report discrepancies affecting work or cost thereof to the City.
- D. Verify exact locations of sewers, water mains, gas mains, above or below ground electrical wires and conduits and structures which may interfere with work.
- E. No extra compensation will be allowed for any extra work made necessary due to conditions or obstacles encountered during progress of work, which could have been determined by examination of site or by contacting Owners of utilities, pipelines and conduits before starting operations.

- F. Comply with State law concerning Sunshine State One Call of Florida, State Statute Title 33, Chapter 556.

3.2 LINES AND GRADES

- A. Prior to staking out work, Contractor shall verify established base line, benchmarks, and control points provided.
- B. Contractor shall furnish and maintain lines and grades.
- C. Contractor shall take immediate steps to correct errors or inconsistencies in lines and grades of work to be in conformity with Contract Documents.
- D. Contractor shall be fully responsible for accuracy of lines and grades of work and control and checking and immediate correction of it.

3.3 RESTORATION

- A. Items to remain which are disturbed, damaged, or removed when performing required work or for convenience of Contractor or to expedite his operations shall be restored, repaired, reinstalled, or replaced with new work and refinished, as appropriate, so as to be left in as good condition as existed before work commenced and such restoration shall be considered incidental to the work.
- B. Any sidewalks or pavement replaced or installed shall meet ADA requirements.
- C. Existing items to be altered, extended, salvaged, or relocated and reused, if found to be defective in any way, shall be reported to the City before items are disturbed.
- D. Materials and workmanship used in restoring work shall conform in type and quality to original existing construction.

3.4 PAYMENT

- A. Payment for work specified in this section will be incidental to the contract.

END OF SECTION

01300: SUBMITTALS

PART 1 - GENERAL

1.1 GENERAL

- A. Inquiries: Direct to ENGINEER regarding procedure, purpose, or extent of Submittal.
- B. Submittal Submission Procedures: As provided in General Conditions, as specified herein, and as may otherwise be established during the preconstruction conference.
- C. OWNER's Authorization: At any time, OWNER may authorize changes to procedures and requirements for Submittals, as necessary to accomplish specific purpose of each Submittal. Such authorization will be by Field Order or Work Change Directive.
- D. Timeliness: Make submissions in accordance with requirements of individual Specification sections, as shown on the current accepted schedule of Submittals submissions, and in such sequence as to cause no delay in Work or in work of other contractors.
- E. Identification of Submittals:
 - 1. Complete, sign, and transmit with each Submittal package, one Transmittal of CONTRACTOR's Submittal Form attached at the end of this section.
 - 2. Identify each Submittal with numbering and tracking system reviewed by ENGINEER:
 - a. Sequentially number each Submittal.
 - b. Resubmission of a Submittal will have original number with sequential alphabetic suffix.
 - 3. Show date of submission and dates of previous submissions.
 - 4. Show Project title and OWNER's contract identification and contract number.
 - 5. Show names of CONTRACTOR, Subcontractor or Supplier, and manufacturer as appropriate.
 - 6. Identify, as applicable, Contract Document section and paragraph to which Submittal applies.
 - 7. Clearly identify revisions from previous submissions.
- F. Incomplete Submittal Submissions:
 - 1. At ENGINEER's sole discretion, ENGINEER will either (i) return the entire Submittal for CONTRACTOR's revision/correction and resubmission, or (ii) retain portions of the Submittal and request submission/resubmission of specified items or as noted thereon.
 - 2. Submittals which do not clearly bear CONTRACTOR's specific written indication of CONTRACTOR review and approval of Submittal or which are transmitted with an unsigned or uncertified submission form or as may otherwise be required under

Contract Documents, will be returned to CONTRACTOR unreviewed for resubmission in accordance with Contract Documents.

3. Delays, re-sequencing or other impact to Work resulting from CONTRACTOR's submission of unchecked or unreviewed, incomplete, inaccurate or erroneous, or nonconforming Submittals, which will require CONTRACTOR's resubmission of a Submittal for ENGINEER's review, shall not constitute a basis of claim for adjustment in Contract Price or Contract Times.

G. Non-specified Submissions: Submissions not required under these Contract Documents and not shown on schedule of Submittals submissions will not be reviewed and will be returned to CONTRACTOR.

H. Transmit submittals in accordance with current accepted schedule of Submittal submissions, and deliver the Engineer designated by the Engineering Department of the City of Key West.

I. Disposition of Submittals: As specified herein for administrative Submittals. ENGINEER will review, stamp, and indicate requirements for resubmission or acceptance on Submittal as follows:

1. No Exceptions Taken.
2. Reviewed as Noted:
 - a. Reference the General Conditions for intent.
 - b. CONTRACTOR may proceed to perform Submittal related Work.
 - d. One copy for ENGINEER's file.
 - e. One copy returned to CONTRACTOR.
3. Revise and Resubmit (Revise/Correct or Develop Replacement and Resubmit):
 - a. Revise/correct in accordance with ENGINEER's comments and resubmit.
 - b. One copy to ENGINEER's file.
 - c. One copy returned to CONTRACTOR appropriately annotated.

J. Payment for the work in this section will be incidental to the contract.

PART 2 - Not used

PART 3 - Not used

END OF SECTION

01390: PRECONSTRUCTION AUDIO-VIDEO RECORDINGS

PART 1 – GENERAL

1.1 REQUIREMENTS

A. For each Work Order, the Contractor shall provide a color audio-video recording showing the entire preconstruction site. The videos shall be in DVD format or .wav files on removable USB drive, indicating the date, project name, and a brief description of the location where the video was taken. The Contractor shall submit one (1) copy of the preconstruction audio-video to the OWNER.

B. All video recordings shall, by electronic means, display on the screen the time of day, the month, day, and year of the recording.

PART 2 – PRODUCTS (Not used)

PART 3 – EXECUTION

3.1 GENERAL

A. The following shall be included with the audio-video documentation:

1. Coverage is required within and adjacent to the right of way, easements, storage, and staging areas where the work is to be constructed.
2. Documentation of the conditions of the adjacent properties or any affected structures as a result of the impending construction.
3. Videos shall be properly identified by Work Order name and number

B. There will be no separate payment for this preconstruction audio-video recording. The cost will be incidental to the contract.

END OF SECTION

01500: TESTING SERVICES

PART 1 - GENERAL

1.1 WORK INCLUDED

- A. The Contractor shall employ and pay for the services of a qualified commercial independent testing laboratory acceptable to the Owner to perform specified services.
- B. Inspection, sampling, and testing is required for:
 - 1. Backfill
 - 2. Paving and surfacing
 - 3. Concrete
 - 3. Additional quality checks as required by the Engineer
- C. Employment of a testing laboratory shall in no way relieve the Contractor of his obligation to perform work in accordance with the Contract.

PART 2 - PRODUCTS

2.1 SUBMITTALS

- A. For each Work Order, submit two copies of reports of inspections and tests to Engineer promptly upon completion of inspections and tests, including: Provide one copy in PDF.
 - 1. Date issued.
 - 2. Project title and Engineer's job number.
 - 3. Testing laboratory name and address.
 - 4. Name and signature of inspector.
 - 5. Date of inspection or sampling.
 - 6. Record of temperature and weather.
 - 7. Date of test.
 - 8. Location of inspection or test.
 - 9. Identification of product and specification section.
 - 10. Type of inspection or test.
 - 11. Observation regarding compliance with the Contract Documents.

PART 3 - EXECUTION

3.1 LABORATORY DUTIES - LIMITATIONS OF AUTHORITY

- A. Cooperate with the Owner and Contractor; provide qualified personnel promptly on notice.
- B. Perform specified inspections, sampling, and testing of materials and methods of construction:
 - 1. Comply with specified standards; ASTM, other recognized standards, authorized and as specified.

- 2. Ascertain compliance with requirements of Contract Documents.
- C. Notify the Engineer and Contractor immediately of irregularities or deficiencies of work that are observed during performance of services.
- D. Perform additional services as required by the Engineer.

3.2 ON SITE TESTING

- A. On site testing must be performed by technical staff certified/accredited by state approved agencies and industry standards.
- B. Testing as required by other sections of this document.

3.3 PAYMENT

- A. Payment for the work in this section will be incidental to the respective unit price items.

END OF SECTION

01530: BARRIERS

PART 1 – GENERAL

1.1 REQUIREMENTS

A. Furnish, install, and maintain suitable barriers as required to prevent public entry, and to protect the work, existing facilities, trees, and plants from construction operations; remove when no longer needed, or at completion of work.

1.2 RELATED REQUIREMENTS

A. Section 01020 Summary of Work.

PART 2 - PRODUCTS

2.1 MATERIALS – GENERAL

A. Materials may be new or used, suitable for the intended purpose, but must not violate requirements of applicable codes and standards.

2.2 FENCING

A. Minimum fence height shall be four feet. Open-mesh orange plastic fence shall be used to prohibit

2.3 BARRIERS

A. Materials are Contractor's option, as appropriate to serve required purpose.

2.4 NO PARKING SIGNS

A. The Contractor is responsible to furnish and place “No Parking” signs when necessary to perform work.

PART 3 - EXECUTION

3.01 GENERAL

A. Install facilities of a neat and reasonably uniform appearance, structurally adequate for the required purposes.

B. Maintain barriers during entire construction period.

C. Relocate barriers as required by the progress of construction.

3.02 FENCES

- A. Provide and maintain fences necessary to assure security of the site during construction to keep unauthorized people and animals from the site when construction is not in progress.
- B. Provide additional security measures as deemed necessary and approved by the OWNER.

3.03 TREE AND PLANT PROTECTION

- A. Preserve and protect existing trees and plants at site which are designated to remain, and those adjacent to site.
- B. Consult with the ENGINEER and the City's Urban Forestry Manager and remove agreed-on roots and branches which interfere with construction. Employ a qualified tree surgeon to remove branches and treat cuts. No trees or roots shall be removed without approval and/or a permit issued by the City Tree Commission.
- C. Protect root zones of trees and plants:
 - 1. Do not allow vehicular traffic or parking.
 - 2. Do not store materials or products.
 - 3. Prevent dumping of refuse or chemically injurious materials or liquids.
 - 4. Prevent puddling or continuous running water.
- D. Carefully supervise excavating, grading and filling, and other construction operations, to prevent damage.
- E. Replace, or suitably trim trees and plants designated to remain which are damaged or destroyed due to construction operations.

3.04 REMOVAL

- A. Completely remove barricades when construction has progressed to the point that they are no longer needed and when approved by the OWNER.
- B. Repair damage caused by construction. Fill and grade areas of the site to the required evaluations, and clean up the area.

END OF SECTION

01700: CONTRACT CLOSEOUT

PART 1 – GENERAL

1.1 REQUIREMENTS

- A. Work Order completion includes completion of all work, final inspection after completion, final cleaning, contractor's closeout submittals, and final adjustment of accounts.

1.2 FINAL INSPECTION AFTER COMPLETION

- A. When Contractor considers the Work Order complete with all minor deficiencies completed or corrected, he shall submit written certification that:
 - 1. Contract Document requirements have been met.
 - 2. Work has been inspected for compliance with Contract Documents.
 - 3. Work has been completed in accordance with Contract Documents.
 - 4. All minor deficiencies have been corrected or completed and the Work is ready for final inspection.
 - 5. Project record documents are complete and submitted.
- B. Within a reasonable time upon receipt of such certification, the OWNER will make an inspection to verify the status of completion.
- C. Should the OWNER determine that the work is incomplete or defective:
 - 1. The OWNER will promptly notify the Contractor in writing, listing the incomplete or defective work.
 - 2. Contractor shall remedy the deficiencies in the work and send a second written certification to the OWNER that the work is complete.
 - 3. Upon receipt of the second certification, the OWNER will review the Work.
- D. When the OWNER determines that the work is acceptable under the Contract Documents, the Contractor shall provide all closeout submittals.

1.3 FINAL CLEANING

- A. Execute final cleaning prior to final inspection.
- B. Clean site; sweep paved areas, rake clean other surfaces.

- C. Remove waste and surplus materials, rubbish, and construction facilities from the Project and from the site.

1.5 CONTRACTOR'S CLOSEOUT SUBMITTALS

A. Project Record Documents

1. At Contract Closeout, submit documents with transmittal letter containing date, project title, Contractor's name and address, list of documents, and signature of Contractor.
2. Changes made by Field Order or by Change Order.

B. Evidence of payment and Release of Liens.

1.6 FINAL ADJUSTMENT OF ACCOUNTS

A. Submit a final statement of accounting to the OWNER.

B. Statement shall reflect all adjustments to the Contract Sum.

1. The original Contract sum.
2. Additions and deductions resulting from:
 - a. Previous change orders or written amendment.
 - b. Allowances
 - c. Unit prices
 - d. Deductions for uncorrected work.
 - e. Deductions for liquidated damages
 - f. Other adjustments
3. Total contract sum as adjusted
4. Previous payments
5. Sum remaining due

PART 2 - PRODUCTS (not used)

PART 3 - EXECUTION (not used)

END OF SECTION

PART 5: TECHNICAL SPECIFICATIONS

TECHNICAL SPECIFICATIONS AND REFERENCES

1. CONSTRUCTION SPECIFICATIONS:

- A. Work associated with this contract shall comply with the January 2016 edition of the FDOT Standard Specifications for Road and Bridge Construction – Divisions II and III, the 2016-17 FDOT Design Standards, and the January 2016 FDOT Drainage Manual. (<http://www.dot.state.fl.us/programmanagement/Implemented/SpecBooks/January2016/Files/116eBook.pdf>) (<http://www.dot.state.fl.us/rddesign/DesignStandards/Standards.shtm>) (<http://www.dot.state.fl.us/rddesign/Drainage/files/DrainageManual.pdf>)
- B. Work associated with this contract shall include but is not limited to FDOT Specifications and Details:
- i. Section 102 - Maintenance of Traffic
 - ii. Section 110 – Clearing and Grubbing
 - iii. Section 120 – Excavation and Embankment
 - iv. Section 125 – Excavation for Structures
 - v. Section 200 – Rock Base
 - vi. Section 300 – Prime and Tack Coats
 - vii. Section 327 – Milling of Existing Asphalt Pavement
 - viii. Section 330 – Hot Mix Asphalt – General Construction Requirements
 - ix. Section 334 – Superpave Asphalt Concrete
 - x. Section 337 – Asphalt Concrete Friction Courses
 - xi. Section 350 – Cement Concrete Pavement
 - xii. Section 522 – Concrete Sidewalk and Driveways
 - xiii. Section 527 – Detectable Warnings
 - xiv. Section 700 – Highway Signing
 - xv. Section 710 – Painted Pavement Markings
 - xvi. Section 711 – Thermoplastic Pavement markings
 - xvii. Section 990 – Temporary Traffic Control Device Materials
 - xviii. Detail 307 – Miscellaneous Utility Details
 - xix. Detail 600s – Traffic Control

2. STRIPING AND SIGNAGE SPECIFICATIONS:

All roadway striping and signage shall comply with the 2009 Manual on Uniform Traffic Control Devices, revised May 2012.

3. SUPPLEMENTARY SPECIFICATIONS:

- A. All work associated with this contract shall conform to the Standard Details shown in Section herein. In case of a conflict with the referenced specifications, requirements shown in Section 6 / City of Key West Details shall prevail.

- End of Section –

PART 6: STANDARD DETAILS

CITY OF KEY WEST DETAILS

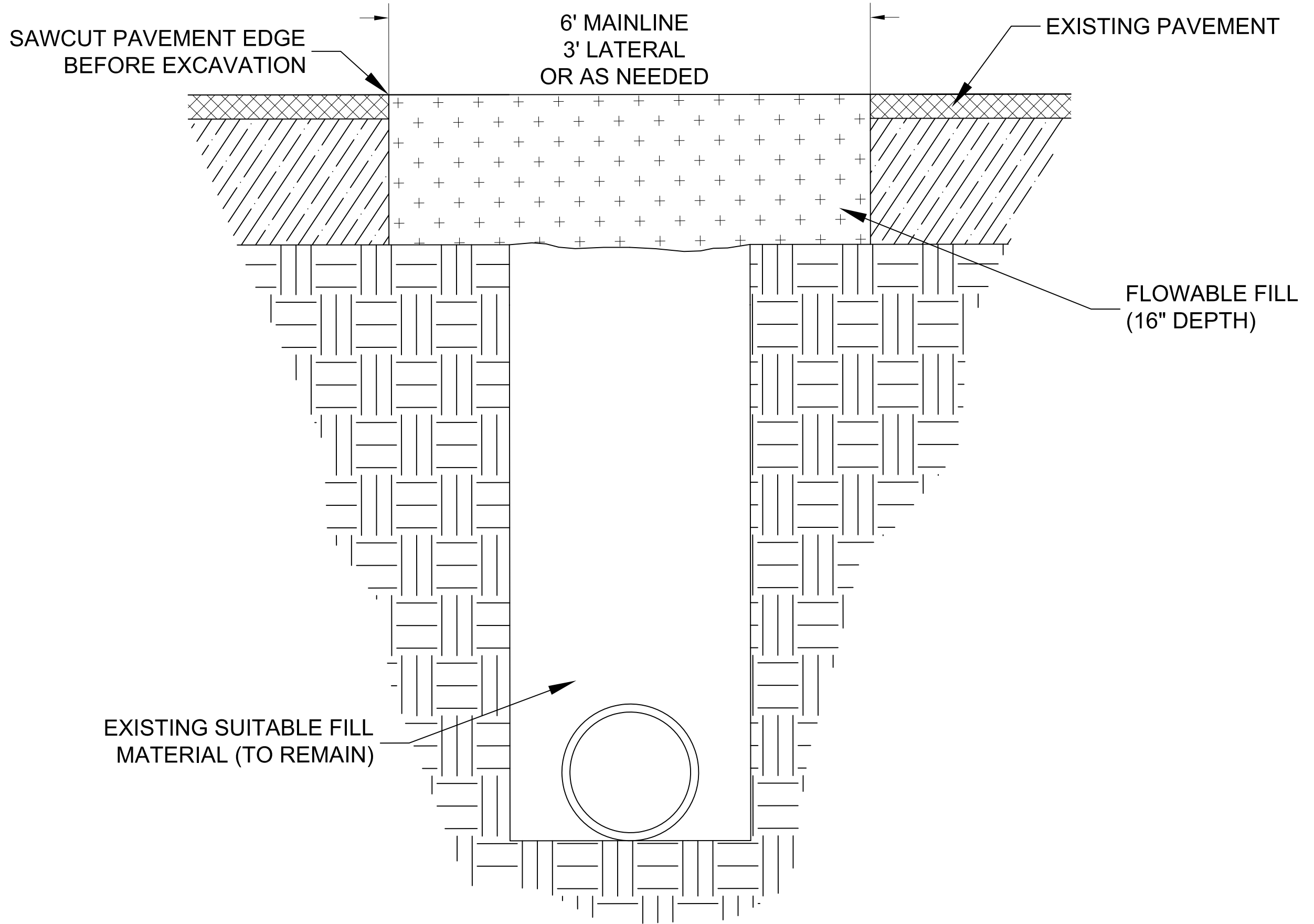

City of Key West

Engineering Services
3132 Flagler Avenue, Key West, FL 33040

NOTES:
1.) THE CONTRACTOR SHALL BE RESPONSIBLE FOR THE ADJUSTMENT OF ALL UTILITIES AND UTILITY APPURTENANCES. MANHOLE LIDS AND RINGS SHALL BE REPLACED AS SHOWN ON PLANS.

TRENCH RESTORATION DETAIL

CITY OF KEY WEST STANDARD DETAIL

DRAWN	THC
SCALE	NTS
DATE	02/21/17
SHEET	1 of 1

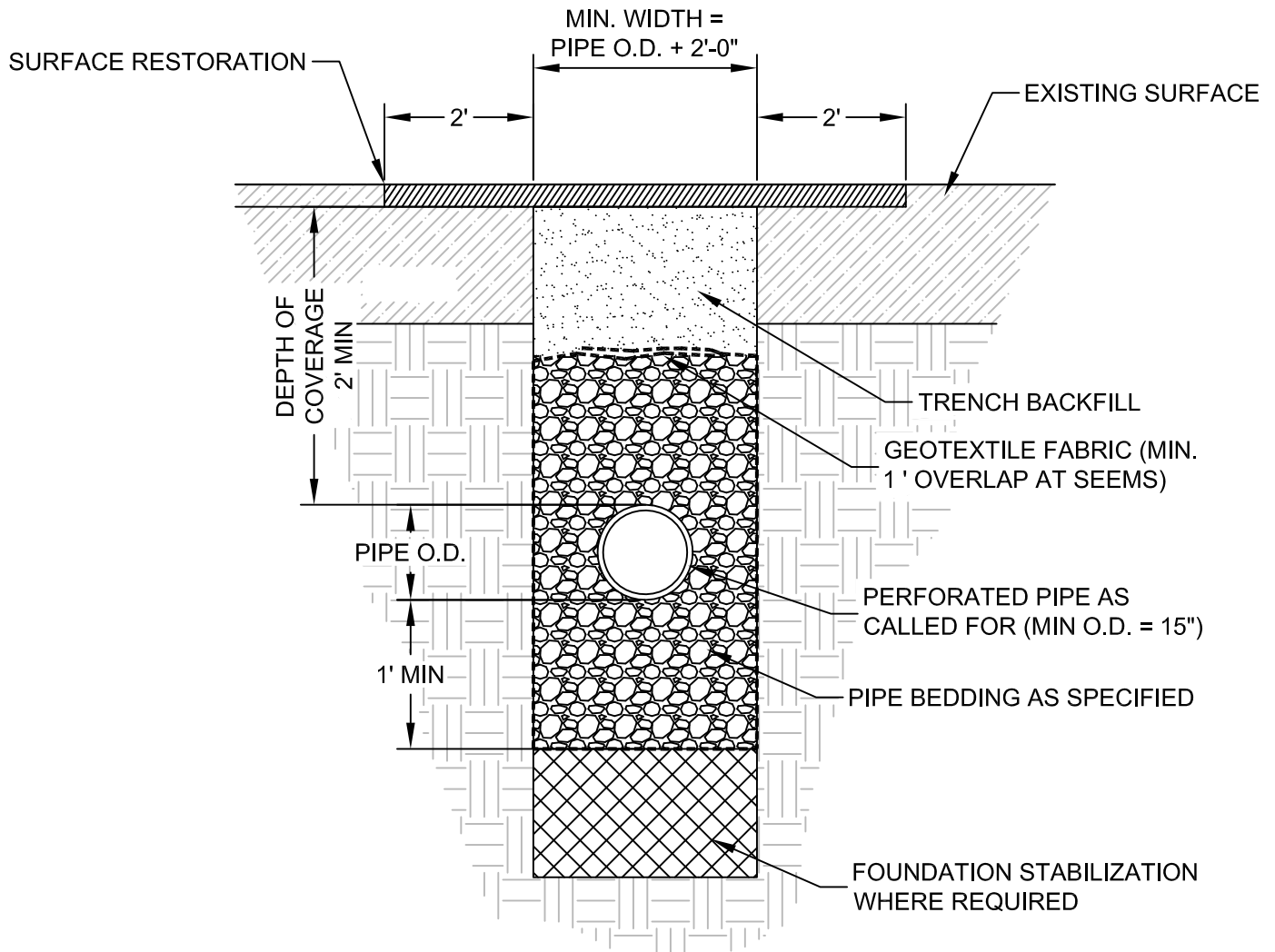

* OR TO WATER ELEVATION, WHICHEVER IS HIGHER

EXFILTRATION TRENCH

1. AFTER THE FOUNDATION STABILIZATION HAS BEEN PLACED TO THE SPECIFIED ELEVATION, IT SHALL BE CAREFULLY WASHED DOWN WITH CLEAN WATER IN ORDER TO ALLOW FOR ANY INITIAL SETTLEMENT THAT MAY OCCUR. IF SETTLEMENT DOES TAKE PLACE, ADDITIONAL FOUNDATION ROCK WILL BE ADDED TO RESTORE THE FOUNDATION TO THE PROPER ELEVATION.



City of Key West

Engineering Services
3132 Flagler Avenue, Key West, FL 33040

TITLE

EXFILTRATION TRENCH

DRAWN
JTJ
SCALE
NTS

SECTION

JUL 2015
DETAIL
23

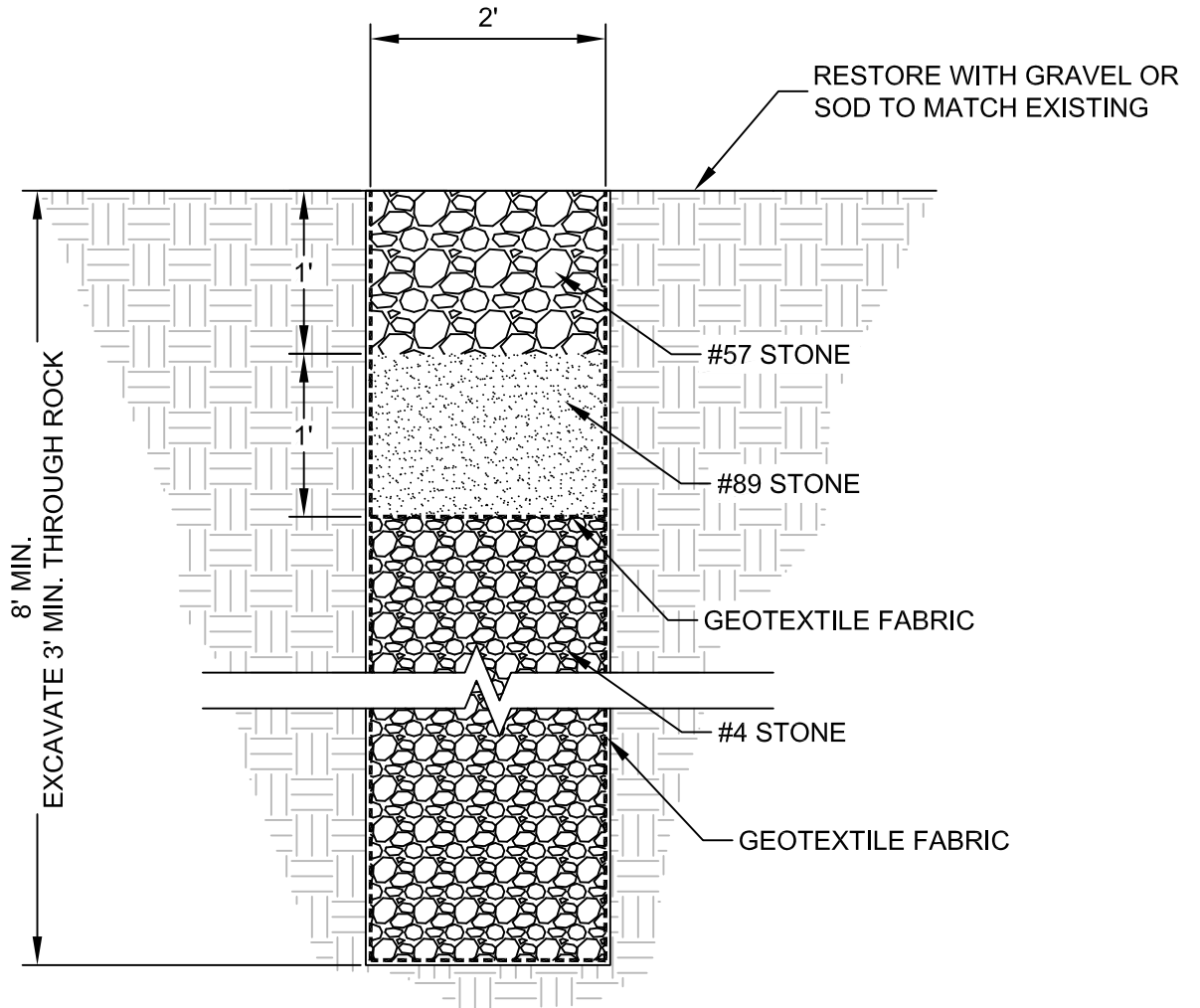

SEEPAGE TRENCH

NOTE:
COMPACTION SHALL OCCUR IN 8" LIFTS THROUGH THE USE OF A VIBRATORY COMPACTOR.



City of Key West

Engineering Services
3132 Flagler Avenue, Key West, FL 33040

TITLE

SEEPAGE TRENCH

DRAWN
JTJ
SCALE
NTS

SECTION

JUL 2015
DETAIL
24

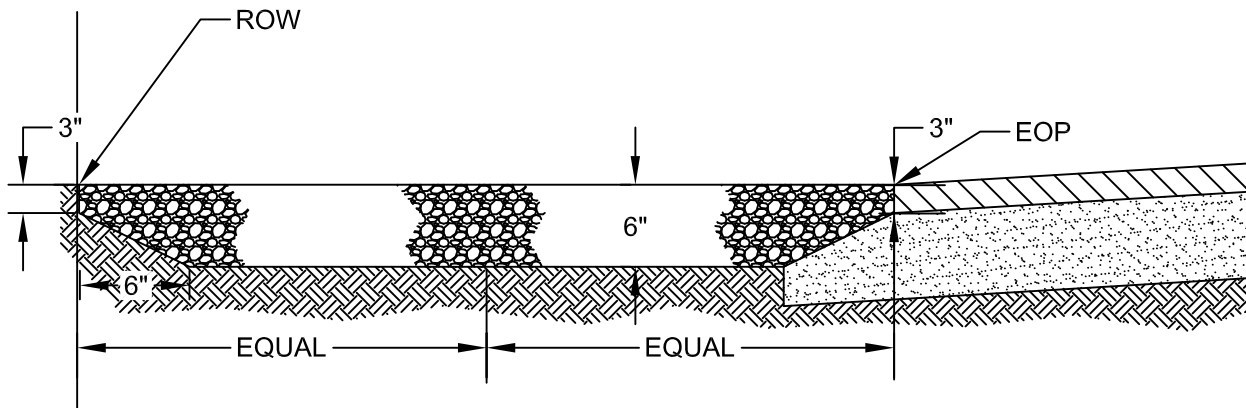

RESTORATION FROM EDGE OF PAVEMENT TO EDGE OF RIGHT-OF-WAY

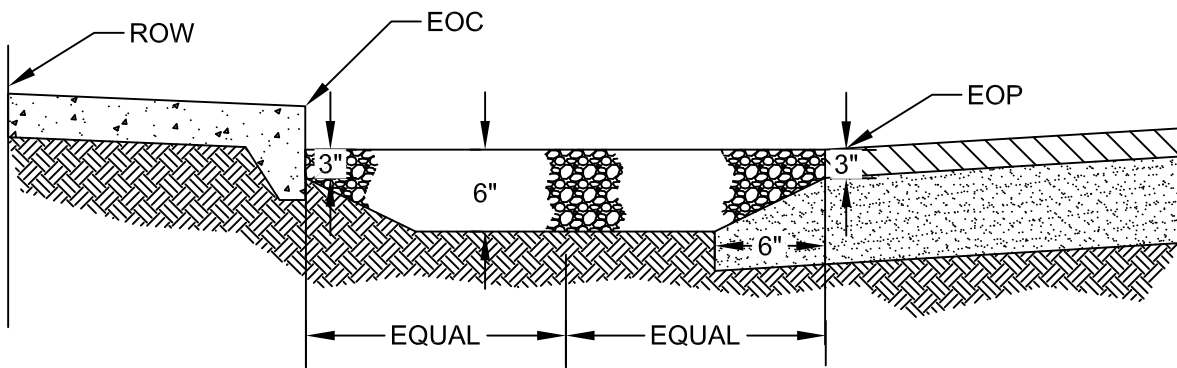

RESTORATION FROM EDGE OF PAVEMENT TO EDGE OF CURB

NOTES:

1. GRADE EXISTING SWALE OR SHOULDER AS INDICATED
2. INSTALL WASHED #57 STONE; AND COMPACT WITH VIBRATORY COMPACTOR.



City of Key West

Engineering Services
3132 Flagler Avenue, Key West, FL 33040

TITLE

SHOULDER RESTORATION

DRAWN
JTJ
SCALE
NTS

DETAIL

JUL 2015

DETAIL

25

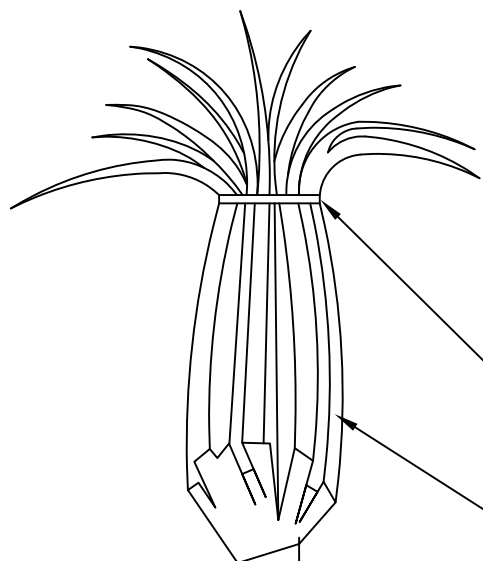

NOTES:
 SEE PLAN FOR C.T. HEIGHTS OF
 GEOMETRIC ARRANGEMENTS.
 ALL OTHER AREAS SHALL BE
 PLANTED AT RANDOM HEIGHTS.

TIE OUTER FRONDS WITH 3/16"
 HEMP (NO MORE THAN 6 WRAPS)

LEAVE A MINIMUM OF 6 FRONDS.
 CUTTING OF ALL FRONDS AND
 BUD WILL NOT BE ACCEPTED.

5 LAYERS OF BURLAP
 5 - 2" x 4" x 16" WOOD BATTEN
 CONNECTED WITH 2 - 3/4" STEEL
 BANDS

2" x 4" WOOD BRACE (3 MIN.)
 TOE NAIL TO BATTEN.
 ALL WOOD PRESSURE
 TREATED.

BACKFILL WITH
 NATIVE SOIL

36" x 36" DIA. BALL



City of Key West

Engineering Services
 3132 Flagler Avenue, Key West, FL 33040

TITLE
 TYPICAL PALM PLANTING/STAKING

DRAWN
 JTJ
 SCALE
 NTS

STANDARD DETAIL

JUL 2015
 DETAIL
 26

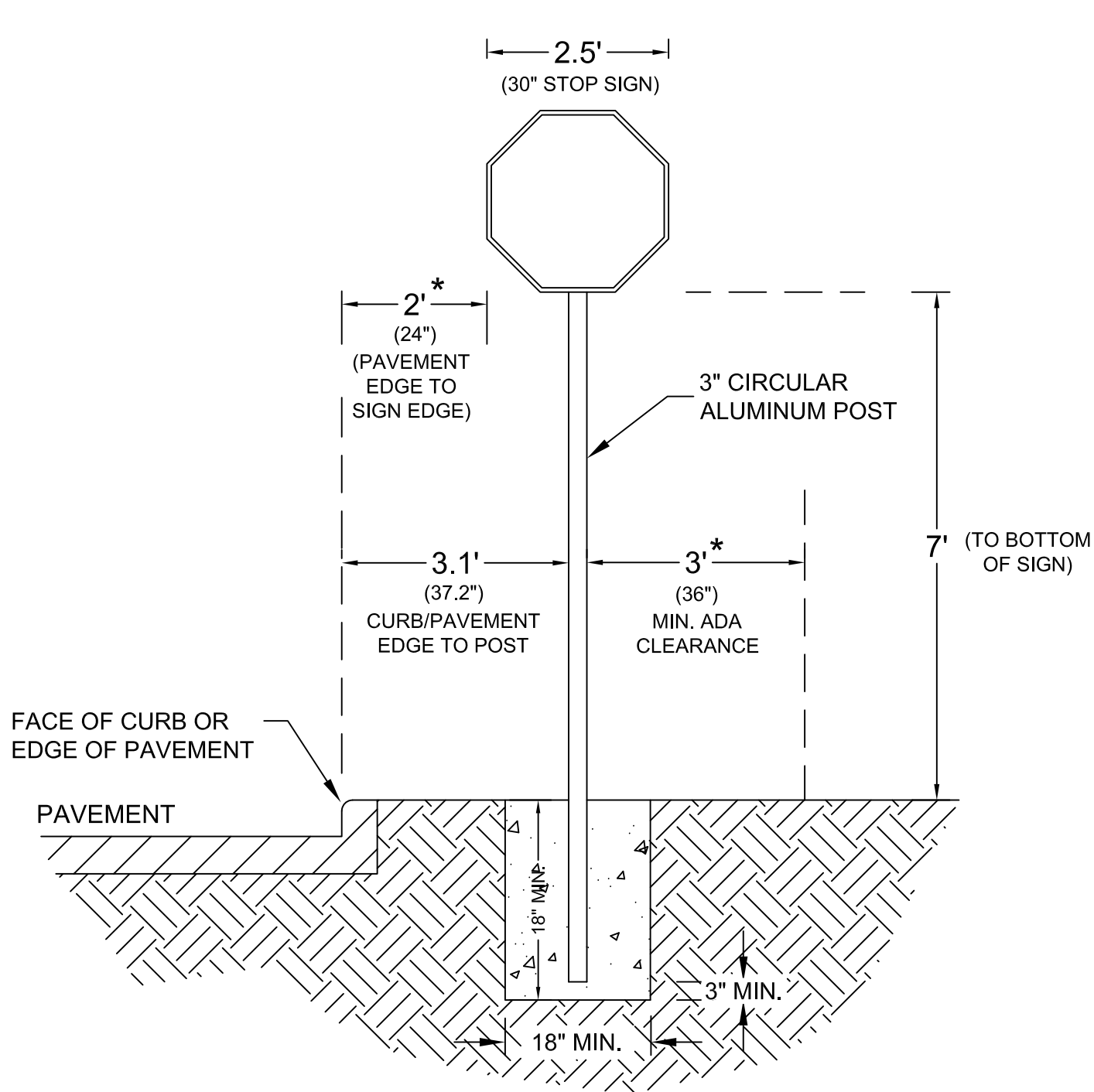

STOP SIGN

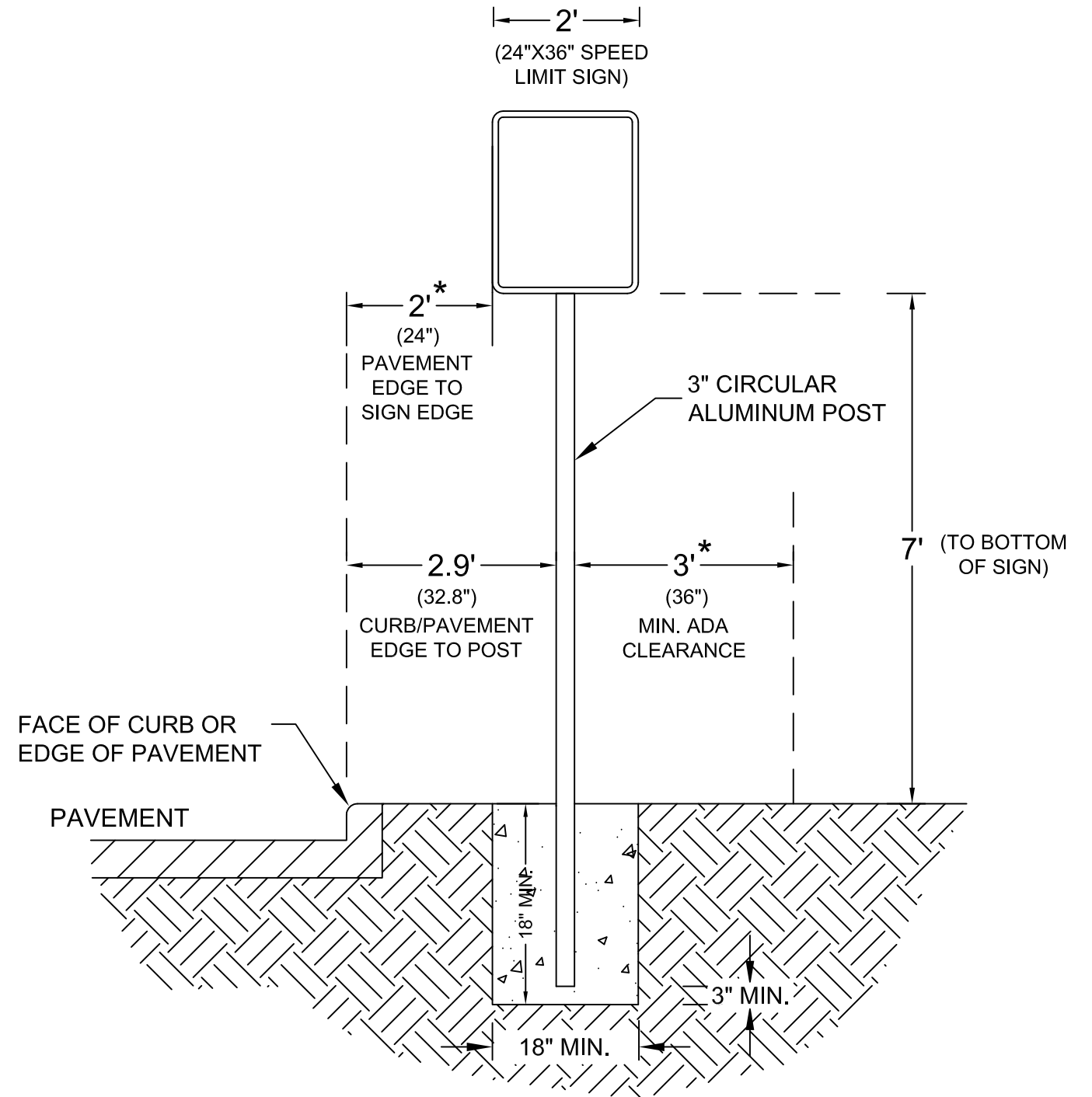

SPEED LIMIT SIGN

* IF DIMENSIONS INDICATED ARE NOT ABLE TO BE MET FOR SIGN INSTALLATION, CONTACT ENGINEERING DEPARTMENT FOR GUIDANCE.



City of Key West

Engineering Services
3132 Flagler Avenue, Key West, FL 33040

STREET SIGN INSTALLATION

LOCATION DETAILS

DRAWN	THC/GJV
SCALE	NTS
DATE	NOV 2016
SHEET	1 of 1

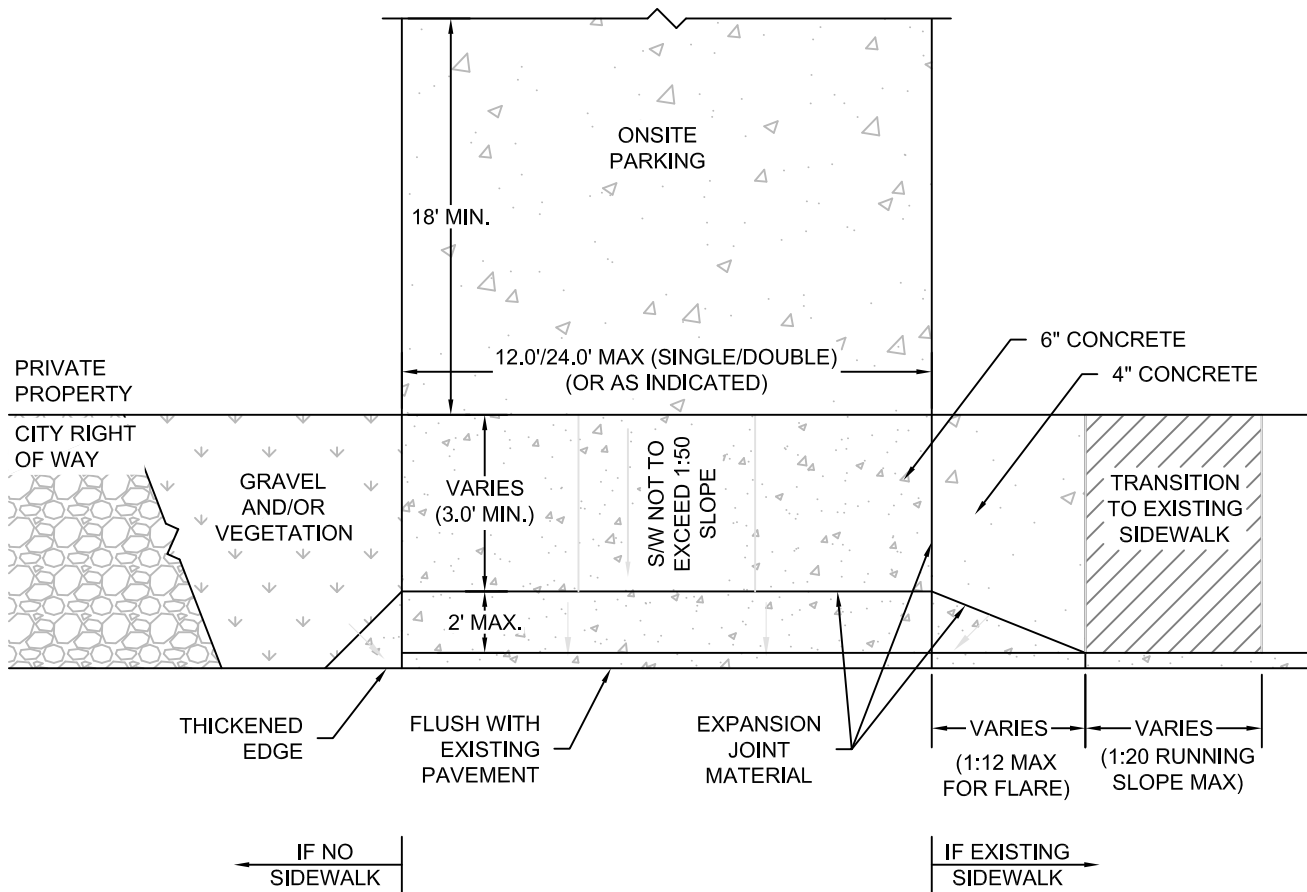

GENERAL NOTES:

- ADA ACCESSIBILITY GUIDELINES APPLY
- PROPERTY SURVEY MUST ACCOMPANY ROW PERMIT APPLICATION
- USE 3,000 PSI CONCRETE MIN.
- NO DRIVEWAY SHALL BE LOCATED WITHIN 25' OF AN INTERSECTION
- ONSITE PARKING SPACE IS REQUIRED TO BE 18' LONG (MIN.) MEASURED FROM THE PROPERTY LINE
- CONTRACTOR MUST COMPLY WITH TYPICAL CITY DESIGNS
- CITY RETAINS THE RIGHT TO MODIFY DESIGN BASED ON FIELD CONDITIONS

CONSTRUCTION REQUIREMENTS (IF APPLICABLE):

- CURB PAINT
- UTILITY ADJUSTMENT OR RELOCATION
- ROADWAY RESTRIPING REWORK
- ASPHALT RESTORATION
- PLANTER RESTORATION

OWNER RESPONSIBILITIES:

- WILL VERIFY 18' ONSITE DRIVEWAY DEPTH REQUIREMENT
- COMPLY WITH CITY LOT PERVIOUS REQUIREMENTS
- OBTAIN HARC APPROVAL (IF LOCATED IN OLD TOWN)
- OBTAIN CITY RIGHT OF WAY PERMIT
- HAVE CONTRACTOR COORDINATE WITH CITY



City of Key West

Engineering Services
3132 Flagler Avenue, Key West, FL 33040

TITLE

DRIVEWAY APRON - RESIDENTIAL

DRAWN
JTJ
SCALE
NTS

TYPICAL DETAIL

SEP 2015

DETAIL

28

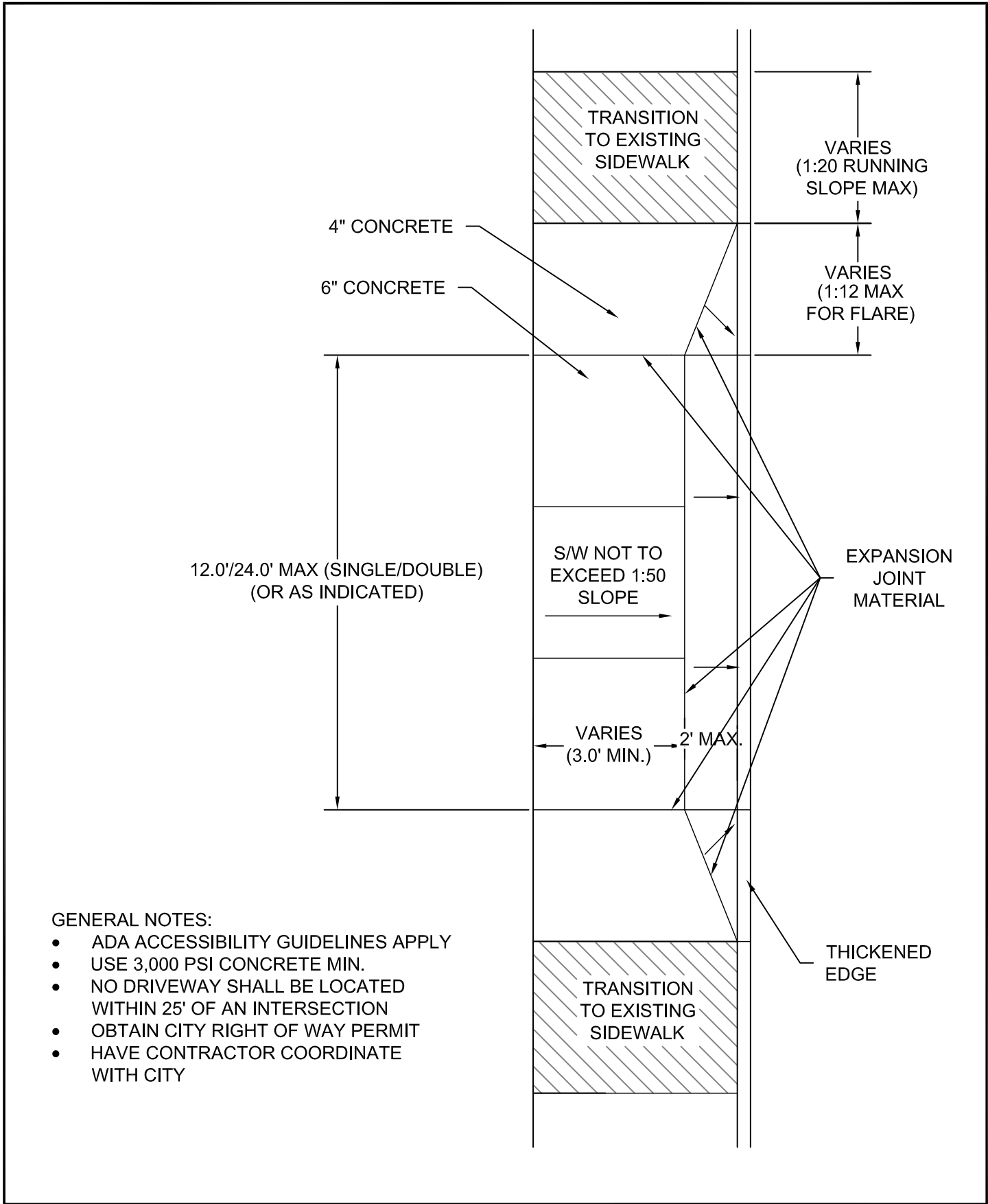

GENERAL NOTES:

- ADA ACCESSIBILITY GUIDELINES APPLY
- USE 3,000 PSI CONCRETE MIN.
- NO DRIVEWAY SHALL BE LOCATED WITHIN 25' OF AN INTERSECTION
- OBTAIN CITY RIGHT OF WAY PERMIT
- HAVE CONTRACTOR COORDINATE WITH CITY



City of Key West

Engineering Services
3132 Flagler Avenue, Key West, FL 33040

TITLE
DRIVEWAY APRON - COMMERCIAL

DRAWN
JTJ
SCALE
NTS

TYPICAL DETAIL

SEP 2015
DETAIL
29

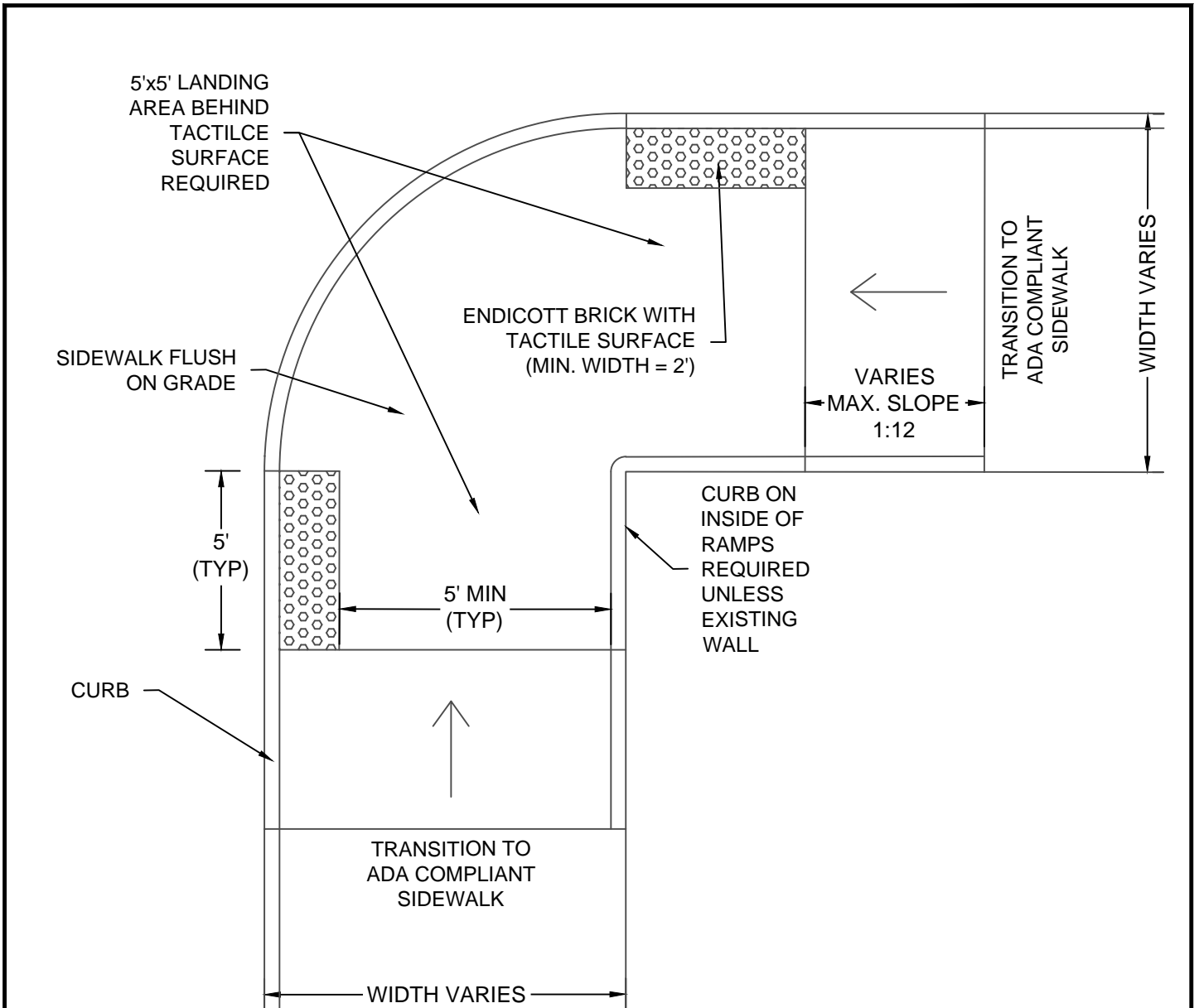

NOTES:

- 1.) ALL SIDEWALK CORNERS SHALL BE ADA COMPLIANT.
2. IF POSSIBLE AVOID ROUNDED 'RADIUS' TACTILE PAD AND ONLY INSTALL 2 SEPARATE 'DIRECTIONAL' RECTANGULAR TACTILE PADS.



City of Key West

Engineering Services
3132 Flagler Avenue, Key West, FL 33040

TITLE

SIDEWALK CORNER

DRAWN

THC

SCALE

NTS

TYPICAL DETAIL

FEB 2017

DETAIL

30

<p>P1</p> <p>DETAIL: PAY TO PARK THIS BLOCK NTS</p>	<p>P2</p> <p>DETAIL: PAY TO PARK INSTRUCTIONS NTS</p>	<p>P3</p> <p>DETAIL: WEEKLY PARKING TIMES NTS</p>	<p>P4</p> <p>DETAIL: PAY TO PARK WEEKLY TIMES NTS</p>	<p>P5</p> <p>DETAIL: PAY TO PARK (6 PM - 6 AM) NTS</p>	<p>P6</p> <p>DETAIL: SCOOTER PARKING (6 PM - 6 AM) NTS</p>	<p>P7</p> <p>DETAIL: TAXI STAND (6 PM - 6 AM) NTS</p>	<p>P8</p> <p>DETAIL: 15 MINUTE LOADING ZONE NTS</p>
--	--	--	--	---	---	--	--

<p>R1-A</p> <p>DETAIL: LOADING ZONE NTS</p>	<p>R1-B</p> <p>DETAIL: LOADING ZONE NTS</p>	<p>R1-C</p> <p>DETAIL: LOADING ZONE NTS</p>	<p>R2</p> <p>DETAIL: LOADING ZONE NTS</p>	<p>R3</p> <p>DETAIL: SCOOTER PARKING ONLY NTS</p>	<p>R4</p> <p>DETAIL: MOTORCYCLE PARKING NTS</p>	<p>R5</p> <p>DETAIL: BICYCLE PARKING ONLY NTS</p>	<p>R6</p> <p>DETAIL: BUS STOP - NO PARKING NTS</p>
--	--	--	--	--	--	--	---

<p>R7</p> <p>DETAIL: LOADING ZONE NTS</p>	<p>R8</p> <p>DETAIL: NO PARKING NTS</p>	<p>R9-A</p> <p>DETAIL: NO PARKING NTS</p>	<p>R9-B</p> <p>DETAIL: NO PARKING NTS</p>	<p>R10-A</p> <p>DETAIL: NO PARKING NTS</p>	<p>R10-B</p> <p>DETAIL: NO PARKING NTS</p>	<p>S1</p> <p>DETAIL: STOP SIGN NTS</p>	<p>S2</p> <p>DETAIL: DO NOT ENTER NTS</p>
--	--	--	--	---	---	---	--

<p>S3</p> <p>DETAIL: ROAD FLOODED NTS</p>	<p>S4</p> <p>DETAIL: ONE WAY NTS</p>	<p>H1</p> <p>DETAIL: HANDICAP PARKING NTS</p>
--	---	--

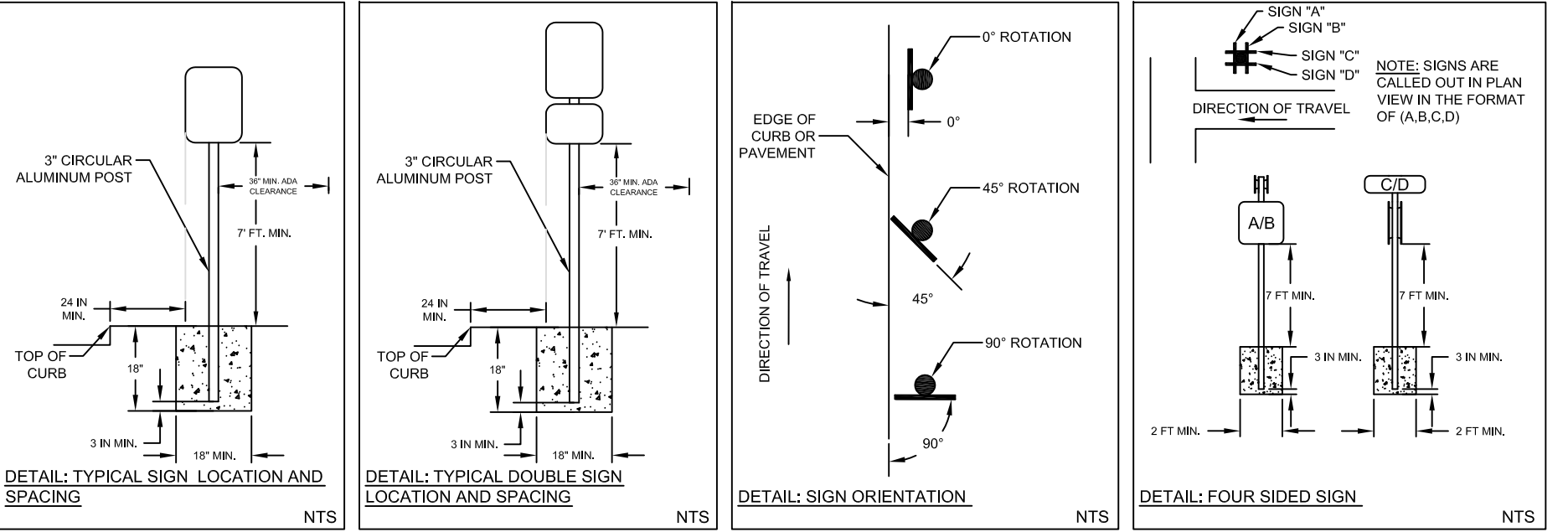

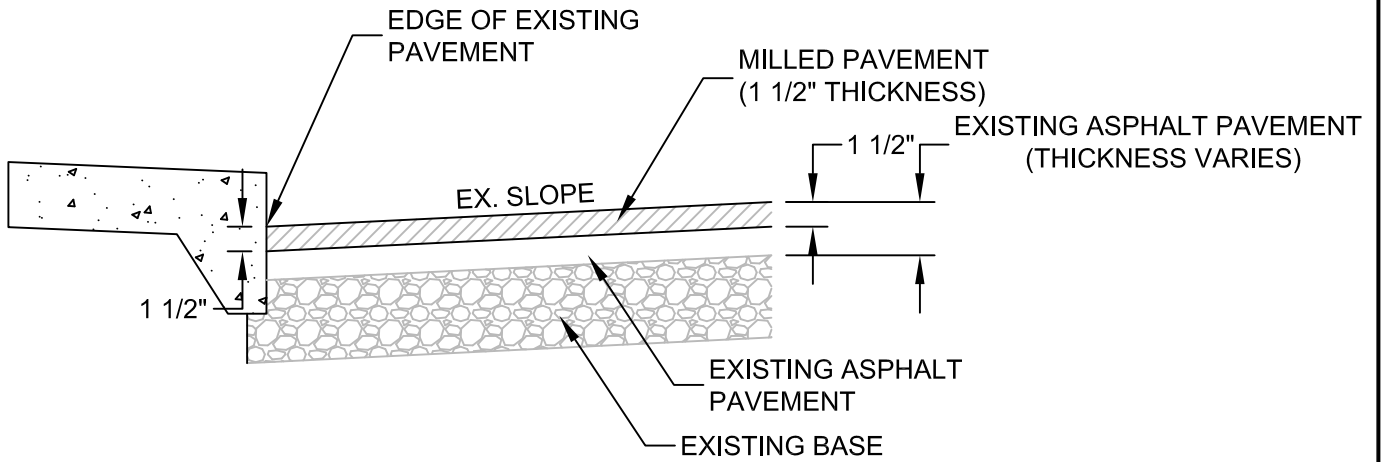

TYPICAL MILLING DETAIL

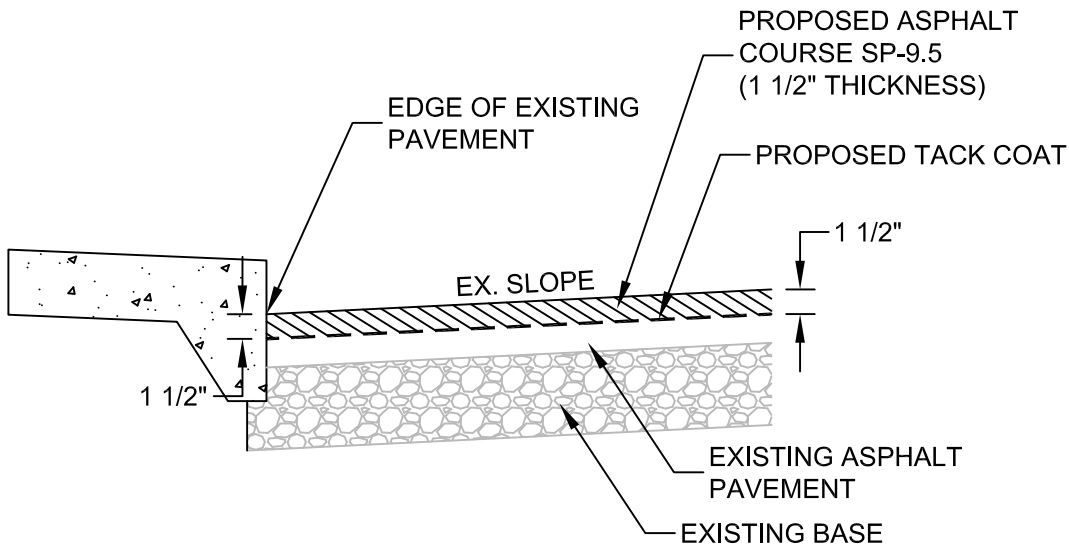

TYPICAL REPAVING DETAIL

NOTES:

- 1.) MILLING SHALL BE PERFORMED IN ACCORDANCE WITH FDOT STANDARD AND SPECIFICATION SECTION 327.
- 2.) TACK COAT SHALL BE INSTALLED IN ACCORDANCE WITH FDOT STANDARD AND SPECIFICATION SECTION 300.
- 3.) ASPHALT COURSE SHALL BE CONSTRUCTED AND INSTALLED IN ACCORDANCE WITH FDOT STANDARD AND SPECIFICATION SECTION 334.



City of Key West

Engineering Services
3132 Flagler Avenue, Key West, FL 33040

TITLE

MILLING AND PAVING

DRAWN
JTJ
SCALE
NTS

ASPHALT RESURFACING

OCT 2015
DETAIL

32

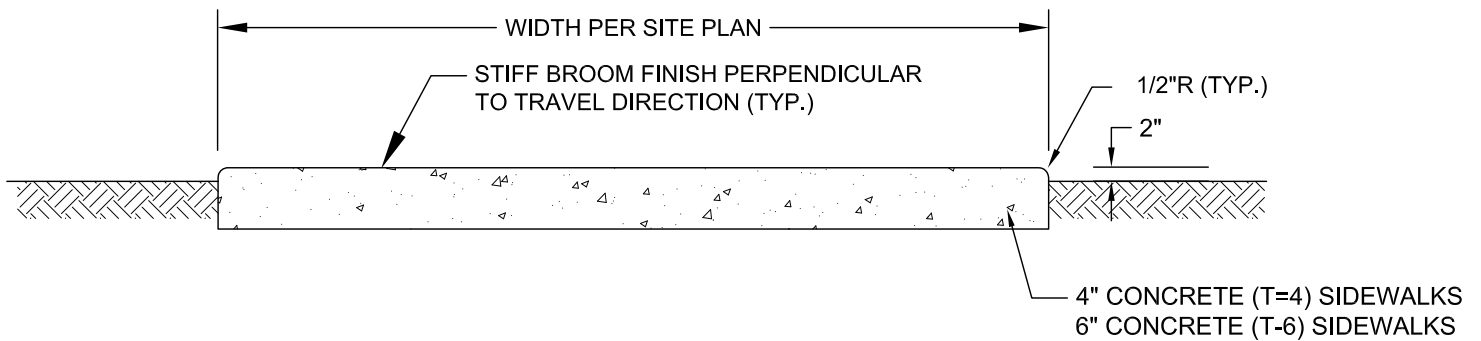

TYPICAL SIDEWALK SECTION

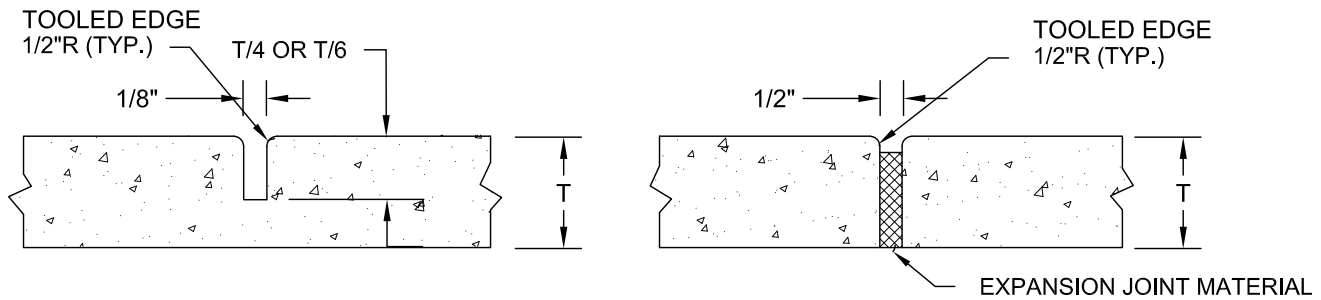

CONTRACTION JOINT

EXPANSION JOINT

NOTES:

1. PROVIDE EXPANSION JOINTS WHERE NEW SIDEWALKS ABUT STRUCTURES AND CONTRACTION JOINTS AT INTERVALS EQUAL TO SIDEWALK WIDTH.
2. REPLACE CONCRETE SIDEWALKS AT SCORED JOINTS TO AVOID A PATCHED APPEARANCE. PROVIDE A 2" LEVELING COURSE BENEATH NEW SIDEWALK.
3. NEW SLABS SHALL BE GRADED TO POSITIVELY DRAIN WITHOUT ANY STORMWATER PONDING.
4. PROVIDE CONTRACTION JOINTS AT 12' O.C. MAX. JOINT PATTERNS IN PAVEMENTS AND SIDEWALKS SHALL BE GENERALLY SQUARE. AT CURBS PROVIDE FULL DEPTH EXPANSION JOINTS AT 100 FT. O.C. MAX, AND AT LOCATIONS WHERE STRAIGHT CURB RUNS CHANGE DIRECTIONS. AT SIDEWALKS PROVIDE WEAKENED PLANE CONTRACTION JOINTS NOT MORE THAN 5'-0" MAX. AND EXPANSION JOINTS AT 20-FT. O.C. MAX (TOOL ALL EDGES). INSTALL SELF-LEVELING SEALANT AT ALL ISOLATION/ EXPANSION JOINTS.
5. MATERIALS AND CONSTRUCTION SHALL CONFORM WITH SECTION 350 OF THE FDOT STANDARDS AND SPECIFICATIONS. CONCRETE SHALL BE 3,000 PSI MINIMUM STRENGTH.



City of Key West

Engineering Services
3132 Flagler Avenue, Key West, FL 33040

TITLE

CONCRETE SIDEWALK

DRAWN
JTJ
SCALE
NTS

TYPICAL DETAIL

JUL 2015
DETAIL
36