

CONTRACT DOCUMENTS FOR:
ITB 15-016



DONALD AVE. AND 16TH TERRACE
STREET PAVEMENT STABILIZATION

April 2015

MAYOR: CRAIG CATES

COMMISSIONERS:

TERRI JOHNSTON

CLAYTON LOPEZ

JIMMY WEEKLEY

TONY YANIZ

MARK ROSSI

BILLY WARDLOW

CITY OF KEY WEST
KEY WEST, FLORIDA

CONTRACT DOCUMENTS

for

DONALD AVENUE and 16th TERRACE
STREET PAVEMENT STABILIZATION

ITB 15-016

CONSISTING OF:
BIDDING REQUIREMENTS
CONTRACT FORMS
CONDITIONS OF THE CONTRACT
SPECIFICATIONS
DRAWINGS

CITY OF KEY WEST
ENGINEERING SERVICES
KEY WEST, FLORIDA

INFORMATION TO BIDDERS

SUBJECT: INVITATION TO BID NO. 15-016:
DONALD AVENUE AND 16TH TERRACE
STREET PAVEMENT STABILIZATION

ISSUE DATE: FRIDAY, MARCH 27, 2015

MAIL OR SPECIAL
DELIVERY REPOSSES TO: CITY CLERK
CITY OF KEYWEST
3126 FLAGLER AVE
KEY WEST, FL
33040

DELIVER BIDS TO: SAME AS

ABOVE BIDS MUST BE
RECEIVED: WEDNESDAY, APRIL 22, 2015

NOT LATER THAN: 3:00 P.M. LOCAL TIME

SUE SNIDER
PURCHASING AGENT
CITY OF KEY WEST

ses

Enclosures

TABLE OF CONTENTS

<u>PART 1</u>	<u>BIDDING REQUIREMENTS</u>	<u>PAGE NO.</u>
	INVITATION TO BID.....	1
	INSTRUCTIONS TO BIDDERS.....	3
	PROPOSAL BID FORM.....	9
	FLORIDA BID BOND.....	17
	ANTI-KICKBACK AFFIDAVIT.....	19
	PUBLIC ENTITY CRIMES FORM.....	20
	CITY OF KEY WEST INDEMNIFICATION FORM	23
	LOCAL VENDORS CERTIFICATE.....	24
	DOMESTIC PARTNERSHIP AFFIDAVIT.....	25
	CONE OF SILENCE.....	26
	BIDDER'S CHECKLIST.....	27
<u>PART 2</u>	<u>CONTRACT FORMS</u>	
	CONTRACT.....	29
	PERFORMANCE BOND.....	31
	PAYMENT BOND	33
<u>PART 3</u>	<u>CONDITIONS OF THE CONTRACT</u>	
	GENERAL CONDITIONS	36
	SUPPLEMENTARY CONDITION	62
<u>PART 4</u>	<u>GENERAL REQUIREMENTS</u>	
	GENERAL REQUIREMENTS.....	72
	ENVIRONMENTAL PROTECTION.....	83
	FIELD ENGINEERING.....	88
	CONTRACT CLOSE-OUT.....	90
<u>PART 5</u>	<u>DRAWING, SFWMD PERMIT AND GEOTECHNICAL REPORT</u>	
	DRAWING C-1: PAVEMENT RECONSTRUCTION	
	SOUTH FLORIDA WATER MANAGEMENT ADMINSTRATION PERMIT	
	DONALD AVENUE ROADWAY STRESS EVALUATION	

PART 1

BIDDING REQUIREMENTS

INVITATION TO BID

Sealed Bids for the construction of ITB 15-016 DONALD AVENUE and 16TH TERRACE STREET PAVEMENT STABILIZATION, addressed to the City of Key West, will be received at the office of the City Clerk, City of Key West, 3126 Flagler Avenue St., Key West, Florida, until 3:00 p.m., local time, on the 22nd day of APRIL 2015, and then will be publicly opened and read. Any bids received after the time and date specified will not be considered.

Please submit ONE (1) ORIGINAL and TWO (2) USB drives each with a single file of the entire bid proposal package. Bid package shall be enclosed in a sealed envelope clearly marked on the outside "ITB 15-016: "DONALD AVENUE AND 16TH TERRACE STREET PAVEMENT STABILIZATION"; addressed and delivered to the City Clerk's office at the address noted above.

The City retains the right to award bid to the bidder that best meet the needs of the City.

The project contemplated consists of the installation of approximately 60 lineal feet of light-weight sheet pile and reconstruction of approximately 5,000 square feet of roadway pavement at the intersection of Donald Avenue and 16th Terrace as shown in the attached drawing.

Drawings and Specifications may be obtained from Demand Star by Onvia. Please contact Demand Star at www.demandstar.com or call 1-800-711-1712 and the City of Key West website at www.cityofkeywest-fl.gov

A **pre-bid meeting** will be held at the project site on April 1, 2015 at 10:00 a.m.

EACH BID MUST BE SUBMITTED ON THE PRESCRIBED FORM AND ACCOMPANIED BY BID SECURITY AS PRESCRIBED IN THE INSTRUCTIONS TO BIDDERS, PAYABLE TO THE CITY OF KEY WEST, FLORIDA, IN AN AMOUNT NOT LESS THAN FIVE (5) PERCENT OF THE AMOUNT BID.

The successful Bidder will be required to furnish the necessary additional bond(s) for the faithful performance of the Contract, as Prescribed in the Bidding Documents. Within 10 days after the Notice of Award, the successful Bidder will also be required to furnish documentation showing that he is in compliance with the licensing requirements of the state and that the Provisions of Chapter 66 of the Code of Ordinances of the City of Key West. Compliance with these Provisions is required before the Contractor can enter into the agreement contained in the Contract Documents.

THE BIDDER MUST BE A LICENSED CONTRACTOR BY THE STATE OF FLORIDA AND SUBMIT PROOF OF SUCH WITH THE BID.

Specifically within 10 days the following the Notice of Award the successful bidder must demonstrate that he holds at a minimum, the following licenses & certificates;

- A. City of Key West Business Tax License Receipt
- B. A valid Certificate of Competency issued by the Chief Building Official of Key West, Florida.

All bid bonds, contract bonds, insurance contracts, and certificates of insurance shall be either executed by or countersigned by a licensed resident agent of the Surety or Insurance Company having his place of

business in the State of Florida, and in all ways complying with the insurance laws of the State of Florida. Further, the said Surety or Insurance Company shall be duly licensed and qualified to do business in the State of Florida.

Before a Contract will be awarded for the work contemplated herein, the OWNER will conduct such investigation as is necessary to determine the performance record and ability of the apparent low Bidder to perform the size and type of work specified under this Contract. Upon request, the Bidder shall submit such information as deemed necessary by the OWNER to evaluate the Bidder's qualifications.

For information concerning the proposed work or for an appointment to visit the site of the proposed work, contact Jim Bouquet, P.E., Director of Engineering, @ (305) 809-3962.

At the time of the award, the successful Bidder must show satisfactory document of such State, County and City licenses as would be required. Any permit and/or license requirement and subsequent costs are located within the bid documents. The successful Bidder must also be able to satisfy the City Attorney as to such insurance coverage and legal requirements as may be demanded in Bid. The City may reject bids: (1) for budgetary reasons, (2) if the bidder misstates or conceals a material fact in its bid, (3) if the bid does not strictly conform to the law or is non-responsive to the bid requirements, (4) if the bid is conditional, (5) if a change of circumstances occurs making the purpose of the bid unnecessary, (6) or if such rejection is in the best interest of the City. The City may also waive any minor formalities or irregularities in any bid.

Dated this _____ day of, _____ 2015.

CITY OF KEY WEST

By: _____
James Scholl, City Manager

INSTRUCTIONS TO BIDDERS

1. CONTRACT DOCUMENTS

A. FORMAT

The Contract Documents are divided into parts, divisions, and sections for convenient organization and reference. Generally, there has been no attempt to divide the Specification sections into work performed by the various building trades, work by separate SUBCONTRACTORS, or work required for separate facilities in the project.

B. DOCUMENT INTERPRETATION

The separate sections contained within these Contract Documents are intended to be mutually cooperative and to provide all details reasonably required for the execution of the proposed work.

Should there be any doubt as to the meaning or intent of said Contract Documents, the Bidder should request of the Engineer, in writing (at least eight (8) days prior to the Bid opening) an interpretation thereof. Any interpretation or change in said Contract Documents will be made only in writing, in the form of addenda to the Documents which will be furnished to all registered holders of Bidding Documents. Bidders shall submit with their PROPOSALS, or indicate receipt of, all Addenda. The Owner will not be responsible for any other explanation or interpretations of said Documents.

2. GENERAL DESCRIPTION OF THE PROJECT

A general description of the work to be done is contained in the Invitation to Bid and the scope is specified in applicable parts of these Contract Documents.

3. QUALIFICATION OF CONTRACTORS

The prospective Bidders must meet the statutorily prescribed requirements before award of the Contract by the Owner.

4. BIDDER'S UNDERSTANDING

Each Bidder must inform himself of the conditions relating to the execution of the work, and it is required that he will inspect the site and make himself thoroughly familiar with all the Contract Documents. Failure to do so will not relieve the successful Bidder of his obligation to enter into a Contract and complete the contemplated work in strict accordance with the Contract Documents. Each Bidder shall inform himself of, and the Bidder awarded a Contract shall comply with, federal, state, and local laws, statutes, and ordinances relative to the execution of the work.

This requirement includes, but is not limited to, applicable regulations concerning minimum wage rates, nondiscrimination in the employment of labor, protection of public and employee safety and health, environmental protection, the protection of natural resources, fire protection, burning and

nonburning requirements, permits, fees, and similar subjects.

5. TYPE OF PROPOSAL

A. LUMP SUM

The Proposal for the work is to be submitted on a LUMP SUM basis. LUMP SUM prices shall be submitted in all appropriate places in the Proposal. A breakdown of the LUMP SUM is required in the Proposal. The total amount to be paid the Contractor shall be the amount of the Lump Sum Proposal as adjusted for additions or deletions resulting from Owner authorized changes in the project.

6. PREPARATION OF PROPOSALS

A. GENERAL

All blank spaces in the Proposal form must be filled in, as required, in BLACK INK. All price information will be shown in both words and figures where required. No changes shall be made in the phraseology of the forms. Written amounts shall govern in case of discrepancy between amounts stated in writing and the amounts stated in figures.

Any Proposal shall be deemed informal which contains omissions erasures, alterations, or additions of any kind, or prices uncalled for, or in which any of the prices are obviously unbalanced, or which in any manner shall fail to conform to the conditions of the published Invitation to Bid.

Only one Proposal from any individual, firm, partnership, or corporation under the same or different names, will be considered. Should it appear to the Owner that any Bidder is interested in more than one Proposal for work contemplated; all Proposals in which such Bidder is interested will be rejected.

B. SIGNATURE

The Bidder shall sign his proposal in the blank space provided therefor. If Bidder is a corporation, the legal name of the corporation shall be set forth above, together with the signature of the officer or officers authorized to sign Contracts on behalf of the corporation. If the Bidder is a partnership, the true name of the firm shall be set forth above, together with the signature of the partner or partners authorized to sign Contracts on behalf of the partnership. If signature is by an agent, other than an officer of a corporation or a member of a partnership, a notarized power of attorney must be on file with the Owner prior to opening of Proposals or submitted with the Proposal, otherwise the Proposal will be regarded as not properly authorized.

C. SPECIAL BIDDING REQUIREMENTS

The Bidder's attention is brought to the hiring practices and licenses and permits of the City of Key West. These are defined in the addition to Article 38, ORDINANCES, PERMITS, and LICENSES, as set forth in the Supplementary Conditions.

The Bidder shall submit with his Bid his experience record showing his experience and expertise in related work. Such experience record shall provide at least ten (10) current or recent projects of similar work, preferably within Florida or the Southeastern United States. For each project the following information will be provided:

1. Description and location of work
2. Contract amount
3. Dates work was performed
4. Owner
5. Name of Owner's contact person and phone number

D. ATTACHMENTS

Bidder shall complete and submit the following forms with his Bid:

Anti-Kickback Affidavit
Public Entity Crime Form
Key West Insurance Form
Local bidders
Cone of silence
Domestic partnership affidavit

7. STATE AND LOCAL SALES AND USE TAX

Unless the Supplementary Conditions contains a statement that the Owner is exempt from state sales tax on materials incorporated into the work due to the qualification of the work under this Contract; all state and local sales and use taxes as required by the laws and statutes of the state and its political subdivisions shall be paid by the Contractor. Prices quoted in the Proposal shall include all nonexempt sales and use taxes, unless provision is made in the Proposal form to separately itemize the tax.

8. SUBMISSION OF PROPOSALS

All Proposals must be submitted not later than the time prescribed, at the place, and in the manner set forth in the Invitation to Bid. Proposals must be made on the Proposal forms provided herewith and submitted intact with the volume containing the Bidding requirements, Contract forms, and Conditions of the Contract. Each Proposal must be submitted in a sealed envelope, so marked as to indicate the Bidder's name and its contents without being opened, and addressed in conformance with the instructions in the Invitation to Bid.

9. MODIFICATION OR WITHDRAWAL OF PROPOSALS

Prior to the time and date designated for receipt of Proposals, any Proposal submitted may be modified or withdrawn by notice to the party receiving Proposals at the place designated for the receipt of Proposals. Such notice shall be in writing over the signature of the Bidder or by telegram. If by telegram, written confirmation over the signature of the Bidder shall be mailed and postmarked on or before the date and time set for receipt of Proposals, and it shall be so worded

as not to reveal the amount of the original Proposal. No Proposal may be withdrawn after the time scheduled for the opening of Proposals, unless the time specified in paragraph AWARD OF CONTRACT of these Instructions to Bidders shall have elapsed.

10. BID SECURITY

Proposals must be accompanied by cash, a certified check drawn on a bank in good standing, or a Bid Bond issued by a Surety authorized to issue such bonds in the state where the work is located, in the amount of five (5) percent of the total amount of the Proposal submitted. This Bid security shall be given as a guarantee that the Bidder will not withdraw his Proposal for a period of Sixty (60) days after Bid opening, and that if awarded the Contract, the successful Bidder will execute the attached Contract within the time specified.

The attorney-in-fact who executes this bond in behalf of the Surety must attach a notarized copy of his power-of-attorney as evidence of his authority to bind the Surety on the date of the execution of the bond. Where State Statute requires, certification by a resident agent shall also be provided.

If the Bidder elects to furnish a Bid Bond, he shall use the Bid Bond form bound herewith, or one conforming substantially thereto in form and content.

11. RETURN OF BID SECURITY

Within fifteen (15) days after the award of the Contract, the Owner will return the Bid securities to all Bidders whose Proposals are not to be further considered in awarding the Contract. Retained Bid securities will be held until the Contract has been finally executed, after which all Bid securities, other than Bidder's Bonds and any guarantees which have been forfeited, will be returned to the respective Bidders whose Proposals they accompanied.

12. AWARD OF CONTRACT

Within forty-five (45) calendar days after the opening of the Proposals, the Owner will accept one of the Proposals or will act in accordance with the following paragraphs. The acceptance of the Proposal will be by written notice of award, mailed to the office designated in the Proposal, or delivered to the Bidder's representative. In the event of failure of the lowest responsive Bidder to sign the Contract and provide acceptable insurance certificate(s), the Owner may award the Contract to the next lowest, responsive, responsible Bidder. Such award, if made, will be made within sixty (60) days after the opening of the Proposals.

The Owner reserves the right to accept or reject any and all Proposals, and to waive any informalities and irregularities in said Proposal.

13. BASIS OF AWARD

The award will be made by the Owner on the basis of that Bid from the lowest responsive, responsible Bidder, which in the Owner's sole and absolute judgment, will serve the best interests of the Owner.

If at the time this Contract is to be awarded, the total of the lowest acceptable Base Bid exceeds the funds then estimated by the Owner as available, the Owner may reject all Bids or take such other action as best serves the Owner's interest.

14. EXECUTION OF CONTRACT

The successful Bidder shall, within ten (10) working days after receiving notice of award, sign and deliver to the Owner a Contract in the form hereto attached together with the acceptable insurance certificates as required in these Documents. Within ten (10) working days after receiving the signed Contract, with acceptable insurance from the successful Bidder, the Owner's authorized agent will sign the Contract. Signature by both parties constitutes execution of the Contract.

15. CONTRACT BONDS

A. PERFORMANCE AND PAYMENT BONDS

The successful Bidder shall file with the OWNER, at the time of delivery of the signed Contract, a Performance Bond and Payment Bond on the form bound herewith, each in the full amount of the Contract price in accordance with the requirements of Florida Statutes Section 255.05 or 713.23, as applicable, as security for the faithful performance of the Contract and the payment of all persons supplying labor and materials for the construction of the work and to cover all guarantees against defective workmanship or materials, or both, during the warranty period following the date of final acceptance of the work by the OWNER. The Surety furnishing this bond shall have a sound financial standing and a record of service satisfactory to the OWNER, shall be authorized to do business in the State of Florida, and shall be listed on the current U.S. Department of Treasury Circular Number 570 or amendments thereto in the Federal Register of acceptable Sureties for federal projects. The CONTRACTOR shall supply the OWNER with phone numbers, addresses, and contacts for the Surety and their agents. Pursuant to Section 255.05(7), Florida Statutes, in lieu of the bond required by law, the contractor may file with the city an alternative form of security in the form of cash, a money order, a certified check, a cashier's check or an irrevocable letter of credit.

B. POWER-OF-ATTORNEY

The Attorney-in-Fact (Resident Agent) who executes this Performance and Payment Bond in behalf of the Surety must attach a notarized copy of his power-of-attorney as evidence of his authority to bind the Surety on the date of execution of the bond.

All Contracts, Performance and Payment Bonds, and respective powers-of-attorney will have the same date.

16. FAILURE TO EXECUTE CONTRACT AND FURNISH BONDS

The Bidder who has a contract awarded to him and who fails to promptly and properly execute the contract shall forfeit the Bid security that accompanied his Bid, and the Bid security shall be retained as liquidated damages by the Owner, and it is agreed that said sum is a fair estimate of the amount of the damages the Owner will sustain in case the Bidder fails to enter into a Contract or furnish the required bonds. Bid security deposited in the form of cash, a certified check, or cashier's check shall be subject to the same requirements as a Bid Bond.

17. PERFORMANCE OF WORK BY CONTRACTOR

The Contractor shall perform on site and with his own organization, labor equivalent to at least

forty (40) percent of the total amount of the work to be performed under this Contract. If, during the progress of the work hereunder, the Contractor requests a reduction of such percentage, and the Engineer determines that it would be to the client's advantage, the percentage of labor to be performed by the Contractor's own organization may be reduced; provided prior written approval of such reduction is obtained by the Contractor from the Engineer.

18. TIME OF COMPLETION

The time of the completion of the work to be performed under this contract is stated in the Proposal and is the essence of this Contract. Delays and extensions of time may be allowed in accordance with the provisions stated in the Contract Documents.

PROPOSAL

TO: CITY OF KEY WEST

ADDRESS: 3140 FLAGLER AVENUE
P.O. BOX 1409
KEY WEST, FLORIDA 33041

PROJECT TITLE: DONALD AVENUE AND 16TH TERRACE
STREET PAVEMENT STABILIZATION

PROJECT NUMBER: EN 1404

Bidder's person to contact for additional information on this proposal:

NAME: _____

TELEPHONE: _____

EMAIL: _____

BIDDER'S DECLARATION AND UNDERSTANDING

The undersigned, hereinafter called the Bidder, declares that the only persons or parties interested in this Proposal are those named herein, that this Proposal is, in all respects, fair and without fraud, that it is made without collusion with any official of the Owner, and that the proposal is made without any connection or collusion with any person submitting another Proposal on this Contract.

The Bidder further declares that he has carefully examined the Contract Documents for the construction of the project, that he has personally inspected the site, that he has satisfied himself as to the quantities involved, including materials and equipment, and conditions of work involved, including the fact that the description of the quantities of work and materials, as included herein, is brief and is intended only to indicate the general nature of the work and to identify the said quantities with the detailed requirements of the Contract Documents, and that this Proposal is made according to the provisions and under the terms of the Contract Documents, which Documents are hereby made a part of this Proposal.

The Bidder further agrees that he has exercised his own judgment regarding the interpretation of subsurface information and has utilized all data that he believes pertinent from the Engineer, Owner, and other sources in arriving at his conclusions.

The Bidder further agrees that the Owner may "non-perform" the work in the event that the low bid is in excess of available funding. Non-performance will be determined prior to Notice of Award.

CONTRACT EXECUTION AND BONDS

The Bidder agrees that if this Proposal is accepted, he will, within ten (10) days including Sundays and legal holidays, after Notice of Award, sign the Contract in the form annexed hereto, and will, at that time deliver to the Owner evidence of holding the required licenses and certificates, and will, to the extent of his Proposal, furnish all machinery, tools, apparatus, and other means of construction and do the work and furnish all the materials necessary to complete all work as specified or indicated in the Contract Documents.

CERTIFICATES OF INSURANCE

The Bidder agrees to furnish the Owner, before commencing the work under this Contract, the Certificates of Insurance as specified in these Documents.

START OF CONSTRUCTION AND CONTRACT COMPLETION TIME

The Bidder further agrees to begin work within ten (10) calendar days after the date of the Notice to Proceed, and to complete the construction, in all respects, within sixty (60) calendar days. This Contract will automatically expire and be terminated on final acceptance by the Owner.

LIQUIDATED DAMAGES

In the event the Bidder is awarded the Contract and shall fail to complete the work authorized by the Contract within the time limit or extended time limit agreed upon in that Contract, as more particularly set forth in the Contract Documents, liquidated damages shall be paid to the Owner at the rate of \$250.00 per day for all work authorized under the Contract Documents, until the work shall have been satisfactorily completed as provided in the Contract Documents. Sundays and legal holidays shall be included in determining days in default.

The Bidder hereby acknowledges that he has received Addenda No. _____, _____,

_____, _____, _____. (Bidder shall insert No. of each addendum received) and agrees that all addenda issued are hereby made part of the Contract Documents, and the Bidder further agrees that his proposal(s) includes all impacts resulting from said addenda.

SALES AND USE TAX

The Bidder agrees that all federal, state, and local sales and use taxes are included in the stated prices for the work.

SUBCONTRACTORS

The Bidder further proposes that the following subcontracting firms or businesses will be awarded subcontracts for the following portions of the work in the event that the Bidder is awarded the Contract:

Portion of Work: _____

Name: _____

Address: _____

Portion of Work: _____

Name: _____

Address: _____

Portion of Work: _____

Name: _____

Address: _____

Portion of Work: _____

Name: _____

Address: _____

Portion of Work: _____

Name: _____

Address: _____

SURETY

_____ whose address is

_____, _____, _____
Street City State Zip

BIDDER

The name of the Bidder submitting this Proposal is

_____ doing business at

_____, _____, _____, _____
Street City State Zip

which is the address to which all communications concerned with this Proposal and with the Contract shall be sent.

The names of the principal officers of the corporation submitting this Proposal, or of the partnership, or of all persons interested in this Proposal as principals are as follows:

_____	_____
_____	_____
_____	_____
_____	_____
_____	_____

If Sole Proprietor or Partnership

IN WITNESS hereto the undersigned has set his (its) hand this _____ day of _____ 2015.

Signature of Bidder

Title

If Corporation

IN WITNESS WHEREOF the undersigned corporation has caused this instrument to be executed and its seal affixed by its duly authorized officers this _____ day of _____ 2015.

(SEAL)

Name of Corporation

By _____

Title _____

Attest _____
Secretary

EXPERIENCE OF BIDDER

The Bidder states that he is an experienced Contractor and has completed similar projects within the last 5 years.

(List similar projects, with types, names of clients, construction costs, and references with phone numbers. Use additional sheets if necessary.)

FLORIDA BID BOND

BOND NO. _____

AMOUNT: \$ _____

KNOW ALL MEN BY THESE PRESENTS, that _____
_____ hereinafter called the PRINCIPAL, and _____
_____ a corporation duly organized under the laws of the State
of _____ having its principal place of business at _____
_____ in the State of _____ and authorized to do
business in the State of Florida, as SURETY, are held firmly bound unto hereinafter called the
Obligee, in the sum of _____ DOLLARS
(\$ _____)

for the payment for which we bind ourselves, our heirs, executors, administrators, successors, and
assigns, jointly and severally, firmly by these present.

THE CONDITION OF THIS BOND IS SUCH THAT:

WHEREAS, the PRINCIPAL is herewith submitting his or its Bid or Proposal, said Bid Proposal, by
reference thereto, being hereby made a part hereof.

WHEREAS, the PRINCIPAL contemplates submitting or has submitted a bid to the OBLIGEE for
the furnishing of labor, materials, (except those specifically furnished by the Owner), equipment,
machinery, tools, apparatus, means of transportation for, and the performance of the work covered in
the Proposal and the detailed Drawings and Specifications entitled:

DONALD AVENUE and 16TH TERRACE STREET PAVEMENT STABLIZATION

WHEREAS, it was a condition precedent to the submission of said bid that a cashier's check, certified
check, or bid bond in the amount of 5 percent of the base bid be submitted with said bid as a guarantee
that the Bidder would, if awarded the Contract, enter into a written Contract with the Owner for the
performance of said Contract, within 5 working days after written notice having been given of the
award of the Contract.

NOW, THEREFORE, the conditions of this obligation are such that if the PRINCIPAL within 5
working days after written notice of such acceptance, enters into a written Contract with the
OBLIGEE then this obligation shall be void: otherwise the sum herein stated shall be due and payable
to the OBLIGEE and the Surety herein agrees to pay said sum immediately upon demand of the

OBLIGEE in good and lawful money of the United States of America, as liquidated damages for failure thereof of said principal.

Signed and sealed this _____ day of _____, 2015.

PRINCIPAL

By: _____

SURETY

By: _____
Attorney-In-Fact

ANTI-KICKBACK AFFIDAVIT

STATE OF FLORIDA)
 : SS
COUNTY OF MONROE)

I, the undersigned hereby duly sworn, depose and say that no portion of the sum herein bid will be paid to any employees of the City of Key West as a commission, kickback, reward or gift, directly or indirectly by me or any member of my firm or by an officer of the corporation.

By _____

Sworn and subscribed before me this _____ day of _____, 2015

NOTARY PUBLIC, State of Florida at Large

My Commission Expires:

**SWORN STATEMENT UNDER SECTION 287.133(3)(A)
FLORIDA STATUTES, ON PUBLIC ENTITY CRIMES**

THIS FORM MUST BE SIGNED IN THE PRESENCE OF A NOTARY PUBLIC OR OTHER OFFICER AUTHORIZED TO ADMINISTER OATHS.

1. This sworn statement is submitted with Bid or Proposal for _____

2. This sworn statement is submitted by _____
(name of entity submitting sworn statement)

whose business address is _____

and (if applicable) its Federal Employer Identification Number (FEIN) is _____

(If the entity has no FEIN, include the Social Security Number of the individual
signing this sworn statement _____

3. My name is _____
(please print name of individual signing)

and my relationship to the entity named above is _____

4. I understand that a “public entity crime” as defined in Paragraph 287.133(1)(g), Florida Statutes, means a violation of any state or federal law by a person with respect to and directly related to the transaction of business with any public entity or with an agency or political subdivision of any other state or with the United States, including but not limited to, any bid or contract for goods or services to be provided to any public or an agency or political subdivision of any other state or of the United States and involving antitrust, fraud, theft, bribery, collusion, racketeering, conspiracy, material misrepresentation.

5. I understand that “convicted” or “conviction” as defined in Paragraph 287.133(1)(b), Florida Statutes, means a finding of guilt or a conviction of a public entity crime, with or without an adjudication guilt, in any federal or state trial court of record relating to charges brought by indictment information after July 1, 1989, as a result of a jury verdict, nonjury trial, or entry of a plea of guilty or nolo contendere.

6. I understand that an “affiliate” as defined in Paragraph 287.133(1)(a), Florida Statutes, means

1. A predecessor or successor of a person convicted of a public entity crime; or

2. An entity under the control of any natural person who is active in the management of the entity and who has been convicted of a public entity crime. The term “affiliate” includes those officers, directors, executives, partners, shareholders, employees, members, and agents who are active in the management of an affiliate. The ownership by one person of shares constituting controlling interest in another person, or a pooling of equipment or income among persons when not for fair market value under an arm’s length agreement, shall be a prima facie case that one person controls another person. A person who knowingly enters into a joint venture with a person who has been convicted of a public entity crime in Florida during the preceding 36 months shall be considered an affiliate.
7. I understand that a “person” as defined in Paragraph 287.133(1)(8), Florida Statutes, means any natural person or entity organized under the laws of any state or of the United States with the legal power to enter into a binding contract and which bids or applies to bid on contracts for the provision of goods or services let by a public entity, or which otherwise transacts or applies to transact business with public entity. The term “person” includes those officers, directors, executives, partners, shareholders, employees, members, and agents who are active in management of an entity.
8. Based on information and belief, the statement which I have marked below is true in relation to the entity submitting this sworn statement. (Please indicate which statement applies).

____ Neither the entity submitting this sworn statement, nor any officers, directors, executives, partners, shareholders, employees, members, or agents who are active in management of the entity, nor any affiliate of the entity have been charged with and convicted of a public entity crime subsequent to July 1, 1989, AND (Please indicate which additional statement applies.)

____ There has been a proceeding concerning the conviction before a hearing of the State of Florida, Division of Administrative Hearings. The final order entered by the hearing officer did not place the person or affiliate on the convicted vendor list. (Please attach a copy of the final order.)

____ The person or affiliate was placed on the convicted vendor list. There has been a subsequent proceeding before a hearing officer of the State of Florida, Division of Administrative Hearings. The final order entered by the hearing officer determined that it was in the public interest to remove the person or affiliate from the convicted vendor list. (Please attach a copy of the final order.)

____ The person or affiliate has not been put on the convicted vendor list. (Please describe any action taken by or pending with the Department of General Services.)

(signature)

(date)

STATE OF _____

COUNTY OF _____

PERSONALLY APPEARED BEFORE ME, the undersigned authority,

_____ who, after first being sworn by me, affixed his/her
(name of individual signing)

signature in the space provided above on this _____ day of _____, 2015.

My commission expires:

NOTARY PUBLIC

CITY OF KEY WEST INDEMNIFICATION FORM

To the fullest extent permitted by law, the CONTRACTOR expressly agrees to indemnify and hold harmless the City of Key West, their officers, directors, agents, and employees (herein called the "indemnitees") from liabilities, damages, losses and costs, including, but not limited to, reasonable attorney's fees and court costs, such legal expenses to include costs incurred in establishing the indemnification and other rights agreed to in this Paragraph, to persons or property, to the extent caused by the negligence, recklessness, or intentional wrongful misconduct of the CONTRACTOR, its Subcontractors or persons employed or utilized by them in the performance of the Contract. Claims by indemnitees for indemnification shall be limited to the amount of CONTRACTOR's insurance or \$1 million per occurrence, whichever is greater. The parties acknowledge that the amount of the indemnity required hereunder bears a reasonable commercial relationship to the Contract and it is part of the project specifications or the bid documents, if any.

The indemnification obligations under the Contract shall not be restricted in any way by any limitation on the amount or type of damages, compensation, or benefits payable by or for the CONTRACTOR under workers' compensation acts, disability benefits acts, or other employee benefits acts, and shall extend to and include any actions brought by or in the name of any employee of the CONTRACTOR or of any third party to whom CONTRACTOR may subcontract a part or all of the Work. This indemnification shall continue beyond the date of completion of the work.

CONTRACTOR: _____

SEAL:

Address _____

Signature _____

Print Name _____

Title _____

Date _____

LOCAL VENDOR CERTIFICATION PURSUANT TO CKW ORDINANCE 09-22 SECTION 2-798

The undersigned, as a duly authorized representative of the vendor listed herein, certifies to the best of his/her knowledge and belief, that the vendor meets the definition of a "Local Business." For purposes of this section, "local business" shall mean a business which:

- a. Principle address as registered with the FL Department of State located within 30 miles of the boundaries of the city, listed with the chief licensing official as having a business tax receipt with its principle address within 30 miles of the boundaries of the city for at least one year immediately prior to the issuance of the solicitation.
- b. Maintains a workforce of at least 50 percent of its employees from the city or within 30 miles of its boundaries.
- c. Having paid all current license taxes and any other fees due the city at least 24 hours prior to the publication of the call for bids or request for proposals.
 - Not a local vendor pursuant to Ordinance 09-22 Section 2-798
 - Qualifies as a local vendor pursuant to Ordinance 09-22 Section 2-798

If you qualify, please complete the following in support of the self-certification & submit copies of your County and City business licenses. Failure to provide the information requested will result in denial of certification as a local business.

Business Name _____ Phone: _____

Current Local Address: _____ Fax: _____
(P.O Box numbers may not be used to establish status)

Length of time at this address: _____

Date: _____

Signature of Authorized Representative

STATE OF _____ COUNTY OF _____

The foregoing instrument was acknowledged before me this _____ day of _____, 2015.

By _____, of _____
(Name of officer or agent, title of officer or agent) (Name of corporation acknowledging)

or has produced identification _____ as identification
(Type of identification)

Signature of Notary

Print, Type or Stamp Name of Notary

Title or Rank

Return Completed form with
Supporting documents to:
City of Key West Purchasing

EQUAL BENEFITS FOR DOMESTIC PARTNERS AFFIDAVIT

STATE OF _____)

: SS

COUNTY OF _____)

I, the undersigned hereby duly sworn, depose and say that the firm of _____ provides benefits to domestic partners of its employees on the same basis as it provides benefits to employees' spouses per City of Key West Ordinance Sec. 2-799.

By: _____

Sworn and subscribed before me this

_____ Day of _____, 2015.

NOTARY PUBLIC, State of _____ at Large

My Commission Expires: _____

CONE OF SILENCE AFFIDAVIT

STATE OF _____)

: SS

COUNTY OF _____)

I the undersigned hereby duly sworn depose and say that all owner(s), partners, officers, directors, employees and agents representing the firm of _____ have read and understand the limitations and procedures regarding communications concerning City of Key West issued competitive solicitations pursuant to City of Key West Ordinance Section 2-773 Cone of Silence (attached).

Sworn and subscribed before me this

_____ Day of _____, 2015.

NOTARY PUBLIC, State of _____ at Large

My Commission Expires: _____

BIDDER'S CHECKLIST

(Note: The purpose of this checklist is to serve as a reminder of major items to be addressed in submitting a bid and is not intended to be all inclusive. It does not alleviate the Bidder from the responsibility of becoming familiar with all aspects of the Contract Documents and proper completion and submission of his bid.)

1. All Contract Documents thoroughly read and understood
2. All blank spaces in Proposal filled in, preferably in black ink
3. Check that lump sum total in numbers and words are the same.
4. Addenda acknowledged
5. SUBCONTRACTORS are named as indicated in the Proposal
6. Experience record included
7. Proposal signed by authorized officer
8. Bid Bond completed and executed, including power-of-attorney dated the same date as Bid Bond
9. Bidder familiar with federal, state, and local laws, ordinances, rules and regulations affecting performance of the work
10. Bidder, if successful, able to obtain and/or demonstrate possession of required licenses and certificates within 10 days after receiving a Notice of Award
11. Proposal submitted intact with the section named "BIDDING REQUIREMENTS" as ONE (1) ORIGINAL AND TWO (2) JUMP DRIVES ,each with a single PDF file of the full SECTION including all additional bidding submittals required by the contract documents
12. Bid Documents submitted in sealed envelope and addressed and labeled in conformance with the instructions in the Invitation to Bid
13. Bidder is currently a contractor licensed to do business in Florida

PART 2

CONTRACT FORMS

CONTRACT

This Contract, made and entered into this _____ day of _____ 2015,
by and between the City of Key West, hereinafter called the "OWNER", and _____

_____ hereinafter called the "CONTRACTOR";

WITNESSETH:

The CONTRACTOR, in consideration of the sum to be paid him by the OWNER and of the covenants and agreements herein contained, hereby agrees at his own proper cost and expense to do all the work and furnish all the materials, tools, labor, and all appliances, machinery, and appurtenances for DONALD AVENUE AND 16TH TERRACE STREET PAVEMENT STABILIZATION, ITB 15-016, Key West, Florida to the extent of the Proposal made by the CONTRACTOR, dated the _____ day of _____ 2015, all in full compliance with the Contract Documents referred to herein.

The BIDDING REQUIREMENTS, including the signed copy of the Proposal, the CONTRACT FORMS, the PERFORMANCE AND PAYMENT BONDS, the CONDITIONS OF THE CONTRACT, the SPECIFICATIONS, and the PERMIT & DRAWINGS, which consist of Detailed Drawings for rip rap placement, appurtenances and other items, dated January 2015, are hereby referred to and by reference made a part of this Contract as fully and completely as if the same were fully set forth herein and are mutually cooperative therewith.

In consideration of the performance of the work as set forth in these Contract Documents, the OWNER agrees to pay to the CONTRACTOR the amount bid in the Proposal as adjusted in accordance with the Contract Documents, or as otherwise herein provided, and to make such payments in the manner and at the times provided in the Contract Documents.

The CONTRACTOR agrees to complete the work within the time specified in the Proposal and to accept as full payment hereunder the amounts computed as determined by the Contract Documents and based on the said Proposal.

The CONTRACTOR agrees to remedy all defects appearing in the work or developing in the materials furnished and the workmanship performed under this Contract during the warranty period after the date of final acceptance of the work by the OWNER, and further agrees to indemnify and save the OWNER harmless from any costs encountered in remedying such defects.

It is agreed that the Contract, based upon the Proposal, shall be fully complete within the stated number of consecutive calendar days from the date the Notice to Proceed is issued.

In the event that the CONTRACTOR shall fail to complete the work within the time limit or the extended time limit agreed upon, as more particularly set forth in the Contract Documents, liquidated damages shall be paid at the rate of \$250.00 per day. Sundays and legal holidays shall be included in determining days in default.

This Contract will automatically expire upon completion of the contract.

IN WITNESS WHEREOF, we, the parties hereto, each herewith subscribe the same this

_____ day of _____, A.D., 2015.

CITY OF KEY WEST

By_____

Title_____

CONTRACTOR

By_____

Title_____

PERFORMANCE BOND

BOND NO. _____

AMOUNT: \$ _____

KNOW ALL MEN BY THESE PRESENTS, that in accordance with Florida Statutes Section 255.05, _____

with offices at _____ hereinafter called the CONTRACTOR (Principal), and

_____ with offices at _____ a corporation duly organized and existing under and by virtue of the laws of the State of Florida, hereinafter called the SURETY, and authorized to transact business within the State of Florida, as SURETY, are held and firmly bound unto **CITY OF KEY WEST**, represented by its _____, hereinafter called the CITY (Obligee), in the sum of:

_____ DOLLARS (\$ _____), lawful money of the United States of America, for the payment of which, well and truly be made to the CITY, the CONTRACTOR and the SURETY bind themselves and each of their heirs, executors, administrators, successors, and assigns, jointly and severally, firmly by these presents as follows:

THE CONDITION OF THE ABOVE OBLIGATION IS SUCH THAT:

WHEREAS, the CONTRACTOR has executed and entered into a certain Contract hereto attached, with the CITY, dated _____, 2015, to furnish at his own cost, charges, and expense all the necessary materials, equipment, and/or labor in strict and express accordance with said Contract and the Contract Documents as defined therein, all of which is made a part of said Contract by certain terms and conditions in said Contract more particularly mentioned, which Contract, consisting of the various Contract Documents is made a part of this Bond as fully and completely as if said Contract Documents were set forth herein;

NOW THEREFORE, the conditions of this obligation are such that if the above bounden CONTRACTOR:

1. Shall in all respects comply with the terms and conditions of said Contract and his obligation there under, including the Contract Documents (which include the permit form, coral relocation plan, specifications, and conditions as prepared by the CITY, invitation to bid, instructions to bidders, the CONTRACTOR’S bid as accepted by the above CITY, the bid and contract performance and payment bonds, and all addenda, if any, issued prior to the opening of bids), being made a part of this bond by reference, at the times and in the manner prescribed in the contract; and

2. Promptly makes payments to all claimants, as defined in Section 255.05(1), Florida Statutes, supplying PRINCIPAL with labor, materials, or supplies, used directly or indirectly by PRINCIPAL in the prosecution of the work provided for in the contract; and

3. Pays CITY all losses, costs, expenses, damages, attorney's fees, including appellate proceedings, injury or loss of whatever kind and however arising including, without limitation, delay damages to which said CITY may be subject by reason of any wrongdoing, misconduct, want of care or skill, negligence, failure of performance, breach, failure to petition within the prescribed time, or default, including patent infringements, on the part of said CONTRACTOR, his agents or employees, in the execution or performance of said Contract; and

4. Performs the guarantee of all work and materials furnished under the contract for the time specified in the contract, then this obligation shall be void; otherwise, to remain in full force and effect for the term of said Contract.

AND, the said Surety for value received, hereby stipulates and agrees that no change involving any extension of time, or addition to the terms of the Contract Documents, or to the work to be performed, or materials to be furnished there under shall affect said obligation of said Surety on this Bond, and the said Surety does hereby waive notice of any such changes, extension of time, alterations, or additions of the terms of the Contract Documents, or to the work.

Any action instituted by a claimant under this bond for payment must be in accordance with the notice and time limitation provisions in Section 255.05(2), Florida Statutes.

IN WITNESS WHEREOF, the above parties bonded together have executed this instrument this day of _____, 2015, the name and corporate seal of each corporate party being hereto affixed and those presents duly signed by its undersigned representative, pursuant to authority of its governing body.

CONTRACTOR

By: _____

(SEAL)

ATTEST

SURETY

By: _____

(SEAL)

ATTEST

PAYMENT BOND

BOND NO. _____

AMOUNT: \$ _____

KNOW ALL MEN BY THESE PRESENTS, that in accordance with Florida Statutes Section 255.05, _____

with offices at _____

hereinafter called the CONTRACTOR, (Principal), and

_____ with offices at _____

a corporation duly organized and existing under and by virtue of the laws of the State of _____, hereinafter called the SURETY, and authorized to transact business within the State of Florida, as SURETY, are held and firmly bound CITY OF KEY WEST,

represented by its _____, hereinafter called the City (Obligee), in the sum of:

_____ DOLLARS (\$ _____), lawful money of the United States of America, for the payment of which, well and truly be made to the CITY, and the CONTRACTOR and the SURETY bind themselves and each of their heirs, executors, administrators, successors, and assigns, jointly and severally, firmly by these presents as follows:

THE CONDITION OF THE ABOVE OBLIGATION IS SUCH THAT:

WHEREAS, the CONTRACTOR has executed and entered into a certain Contract for

DONALD AVENUE AND 16TH TERRACE STREET PAVEMENT STABILIZATION

attached hereto, with the CITY, dated _____, 2015, to furnish at his own cost, charges, and expense the necessary materials, equipment, and/or labor in strict and express accordance with said Contract and the plans, drawings (if any), and specifications prepared by the CITY, all of which is made a part of said Contract by certain terms and conditions in said Contract more particularly mentioned, which Contract, consisting of the various Contract Documents specifically mentioned herein and relative hereto, is made a part of this Bond as fully and completely as if said Contract Documents were set forth herein.

NOW THEREFORE, the conditions of this obligation are such that if the above bounden CONTRACTOR shall in all respects comply with the terms and conditions of said Contract and his

obligation thereunder, including the Contract Documents (which include the permit form, coral relocation plan, the specifications, and conditions prepared by the CITY, invitation to bid, instructions to bidders, the CONTRACTOR'S bid as accepted by the CITY, the bid and contract and payment bonds, and all addenda, if any, issued prior to the opening of bids), and further that if said CONTRACTOR shall promptly make payments to all persons supplying materials, equipment, and/or labor, used directly or indirectly by said CONTRACTOR or SUBCONTRACTORS in the prosecution of the work for said contract in accordance with Florida Statutes, Section 255.05 or Section 713.23, then this obligation shall be void; otherwise to remain in full force and effect for the term of said contract, including and all guarantee periods as specifically mentioned in said Contract Documents.

AND, the said SURETY for value received, hereby stipulates and agrees that no change involving any extension of time, or addition to the terms of the Contract or to the work to be performed, or materials to be furnished thereunder, or in the Contract Documents and specifications accompanying the said contract shall affect said obligation of said SURETY on this Bond, and the said SURETY does hereby waive notice of any such changes, extension of time, alternations, or additions of the terms of the Contract, or to the work, to the Contract Documents, or to the specifications.

Claimant shall give written notice to the CONTRACTOR and the SURETY as required by Section 255.05 or Section 713.23, Florida Statutes. Any action instituted against the CONTRACTOR or SURETY under this bond for payment must be in accordance with the notice and time limitation provisions in Section 255.05(2) or Section 713.23, Florida Statutes.

IN WITNESS WHEREOF, the above parties bounded together have executed this instrument this day of _____, 2015, the name and corporate seal of each corporate party being hereto affixed and those presents duly signed by its undersigned representative, pursuant to authority of its governing body.

CONTRACTOR

By: _____

(SEAL)

ATTEST

SURETY

By: _____

(SEAL)

ATTEST

PART 3

CONDITIONS OF THE CONTRACT

GENERAL CONDITIONS
CONTENTS

Article

DEFINITIONS

1. AS APPROVED
2. AS SHOWN, AND AS INDICATED
3. BIDDER
4. CONTRACT DOCUMENTS
5. CONTRACTOR
6. CONTRACT COMPLETION
7. DAYS
8. DRAWINGS
9. ENGINEER
10. NOTICE
11. OR EQUAL
12. OWNER
13. PLANS
14. SPECIFICATIONS
15. NOTICE TO PROCEED
16. SUBSTANTIAL COMPLETION
17. WORK

CONTRACT DOCUMENTS

18. INTENT OF CONTRACT DOCUMENTS
19. DISCREPANCIES AND OMISSIONS
20. CHANGES IN THE WORK
21. EXAMINATION AND VERIFICATION OF CONTRACT DOCUMENTS
22. DOCUMENTS TO BE KEPT ON THE JOBSITE
23. ADDITIONAL CONTRACT DOCUMENTS
24. OWNERSHIP OF CONTRACT DOCUMENTS

THE ENGINEER

25. AUTHORITY OF THE ENGINEER
26. DUTIES AND RESPONSIBILITIES OF THE ENGINEER
27. LIMITATIONS ON ENGINEER'S RESPONSIBILITIES
28. REJECTED WORK
29. LINES AND GRADES
30. SUBMITTALS
31. DETAIL DRAWINGS AND INSTRUCTIONS

THE CONTRACTOR AND HIS EMPLOYEES

32. CONTRACTOR, AN INDEPENDENT AGENT
32. (a) ASSIGNMENT OF CONTRACT
33. SUBCONTRACTING
34. INSURANCE AND LIABILITY
 - A. GENERAL
 - B. CONTRACTOR AND SUB- CONTRACTOR INSURANCE
 - C. COMPENSATION AND EMPLOYER'S LIABILITY INSURANCE
 - D. GENERAL LIABILITY INSURANCE (INCLUDING AUTOMOBILE)
 - E. BUILDER'S RISK ALL RISK INSURANCE
 - F. NO PERSONAL LIABILITY OF PUBLIC OFFICIALS
35. INDEMNITY

36. EXCLUSION OF CONTRACTOR CLAIMS
37. TAXES AND CHARGES
38. REQUIREMENTS OF STATE LAW FOR PUBLIC WORKS PROJECTS
39. CODES, ORDINANCES, PERMITS, AND LICENSES
40. SUPERINTENDENCE
41. RECEPTION OF ENGINEER'S COMMUNICATIONS
42. SAFETY
43. PROTECTION OF WORK AND PROPERTY
44. RESPONSIBILITY OF CONTRACTOR TO ACT IN AN EMERGENCY
45. MATERIALS AND APPLIANCES
46. CONTRACTORS' AND MANUFACTURERS' COMPLIANCE WITH STATE SAFETY, OSHA AND OTHER CODE REQUIREMENTS
47. SUBSTITUTION OF MATERIALS
48. TESTS, SAMPLES, AND OBSERVATIONS
49. ROYALTIES AND PATENT
50. CONTRACTOR'S RIGHT TO TERMINATE CONTRACT
51. CORRECTION OF DEFECTIVE WORK DURING WARRANTY PERIOD

PROGRESS OF THE WORK

52. BEGINNING OF THE WORK
53. SCHEDULES AND PROGRESS REPORTS
54. PROSECUTION OF THE WORK
55. OWNER'S RIGHT TO RETAIN IMPERFECT WORK
56. OWNER'S RIGHT TO DO WORK
57. OWNER'S RIGHT TO TRANSFER EMPLOYMENT
58. DELAYS AND EXTENSION OF TIME
59. DIFFERING SITE CONDITION
60. LIQUIDATED DAMAGES
61. OTHER CONTRACTS
62. USE OF PREMISES
63. SUBSTANTIAL COMPLETION DATE
64. PERFORMANCE TESTING
65. OWNER'S USE OF PORTION OF THE WORK
66. CUTTING AND PATCHING
67. CLEANING UP

PAYMENT

68. CHANGE ORDERS
 - A. UNIT PRICE
 - B. LUMP SUM
 - C. COST REIMBURSEMENT WORK
69. PARTIAL PAYMENTS
 - A. GENERAL
 - B. ESTIMATE
 - C. DEDUCTION FROM ESTIMATE
 - D. QUALIFICATIONS FOR PARTIAL PAYMENT FOR MATERIALS DELIVERED
 - E. PAYMENT
70. CLAIMS FOR EXTRA WORK
71. RELEASE OF LIENS OR CLAIMS
72. FINAL PAYMENT
73. NO WAIVER OF RIGHTS
74. ACCEPTANCE OF FINAL PAYMENT CONSTITUTES RELEASE

DEFINITIONS

Whenever in the Contract Documents the following terms are used, the intent and meaning shall be interpreted as follows:

1. AS APPROVED

The words “as approved”, unless otherwise qualified, shall be understood to be followed by the words “by the ENGINEER for conformance with the Contract Document”.

2. AS SHOWN, AND AS INDICATED

The words “as shown” and “as Indicated” shall be understood to be followed by the words “on the Drawings”.

3. BIDDER

The person or persons, partnership, firm, or corporation submitting a Proposal for the work contemplated.

4. CONTRACT DOCUMENTS

The “Contract Documents” consist of the Bidding Requirements, Contract Forms, Conditions of the Contract, Specifications, Drawings, all modifications thereof incorporated into the Documents before their execution, Change Orders, and all other requirements incorporated by specific reference thereto. These form the Contract.

5. CONTRACTOR

The person or persons, partnership, firm, or corporation who enters into the Contract awarded him by the OWNER.

6. CONTRACT COMPLETION

The “Contract Completion” is the date the OWNER accepts the entire work as being in compliance with the Contract Documents, or formally waives nonconforming work to extent of nonconformity, and issues the final payment in accordance with the requirements set forth in Article, “Final Payment” of these General Conditions.

7. DAYS

Unless otherwise specifically stated, the term “days” will be understood to mean calendar days. Business day or working day means any day other than Saturday, Sunday, or legal holiday.

8. DRAWINGS

The term “Drawings” refers to the official Drawings, Profiles, cross sections, elevations, details, and

other working drawings and supplementary drawings, or reproductions thereof, signed by the ENGINEER, which shows the location, character, dimensions, and details of the work to be performed. Drawings may either be bound in the same book as the balance of the Contract Documents, or bound in separate sets, and are a part of the Contract Documents, regardless of the method of binding.

9. ENGINEER

The person or organization identified as such in the Contract Documents. The Term “ENGINEER” means ENGINEER or his authorized representative.

10. NOTICE

The term “notice” or the requirement to notify, as used in the Contract Documents or applicable state or federal statutes, shall signify a written communication delivered in person or by registered mail to the individual, or to a member of the firm, or to an officer of the corporation for whom it is intended. Certified or registered mail shall be addressed to the last business address known to him who gives the notice.

11. OR EQUAL

The term “or equal” shall be understood to indicate that the “equal” Product is equivalent to or better than the Product named in function, performance, reliability, quality, and general configuration. Determination of equality in reference to the Project design requirements will be made by the ENGINEER. Such equal Products shall not be purchased or installed by the CONTRACTOR without written authorization.

12. OWNER

The person, organization, or public body identified as such in the Contract Documents.

13. PLANS (See Drawings)

14. SPECIFICATIONS

The term “Specifications” refers to those portions of the Contract Documents consisting of written technical descriptions of materials, equipment, construction systems, standards, and workmanship as applied to the work and certain administrative details applicable thereto. Where standard specifications, such as those of ASTM, AASHTO, etc., have been referred to, the applicable portions of such standard specifications shall become a part of these Contract Documents. If referenced specifications conflict with specifications contained herein, the requirements contained herein shall prevail.

15. NOTICE TO PROCEED

A written notices given by the OWNER to the CONTRACTOR (with a copy to the ENGINEER) fixing the date on which the Contract time will commence to run and on which the CONTRACTOR shall start to perform his obligation under the Contract Documents. The Notice to Proceed will be given within 30 days following the execution of the Contract by the OWNER.

16. SUBSTANTIAL COMPLETION

“Substantial Completion” shall be that degree of completion of the Project or a defined portion of the Project, as evidenced by the ENGINEER’s written notice of Substantial Completion, sufficient to Provide the OWNER, at his discretion, the full-time use of the Project or defined portion of the Project for the purposes for which it was intended. “Substantial Completion” of an operating facility shall be that degree of completion that has Provided a minimum of 7 continuous days of successful, trouble-free, operation, which period shall begin after all performance and acceptance testing has been successfully demonstrated to the ENGINEER. All equipment contained in the work, plus all other components necessary to enable the OWNER to operate the facility in a manner that was intended, shall be complete on the substantial completion date.

17. WORK

The word “work” within these Contract Documents shall include all material, labor, tools, and all appliances, machinery, transportation, and appurtenances necessary to perform and complete the Contract, and such additional items not specifically indicated or described which can be reasonably inferred as belonging to the item described or indicated and as required by good Practice to Provide a complete and satisfactory system or structure. As used herein, “Provide” shall be understood to mean, “furnish and install, complete in-place”.

CONTRACT DOCUMENTS

18. INTENT OF CONTRACT DOCUMENTS

The Contract Documents are complementary, and what is called for by one shall be as binding as if called for by all. The intent of the Documents is to describe a functionally complete Project (or part thereof) to be constructed in accordance with the Contract Documents. Any work, materials, or equipment that may reasonably be inferred from the Contract Documents as being required to produce the intended result shall be supplied whether or not specifically called for. When words, which have a well-known technical or trade meaning are used to describe work, materials, or equipment, such words shall be interpreted in accordance with that meaning.

Reference to standard specifications, manuals, or codes of any technical society, organization or association, or to the laws or regulations of any governmental authority, whether such reference be specific or by implication, shall mean the latest standard specification, manual, code or laws or regulations in effect on the first published date of the Invitation to Bid, except as may be otherwise specifically stated. However, no Provision of any referenced standard specification, manual or code (whether or not specifically incorporated by reference in the Contract Documents) shall be effective to change the duties and responsibilities of OWNER, CONTRACTOR, or ENGINEER, or any of their consultants, agents, or employees from those set forth in the Contract Documents, nor shall it be effective to assign to ENGINEER, or any ENGINEER’s consultants, agents, or employees, any duty or authority to supervise or direct the furnishing or performance of the work or any duty or authority to undertake responsibility contrary to the Provisions of Article LIMITATIONS ON ENGINEER’S RESPONSIBILITIES.

19. DISCREPANCIES AND OMISSIONS

Any discrepancies or omissions found in the Contract Documents shall be reported to the ENGINEER immediately. The ENGINEER will clarify discrepancies or omissions, in writing, within a reasonable time.

In resolving inconsistencies among two or more sections of the Contract Documents, Precedence shall be given in the following order:

- A. CONTRACT
- B. PROPOSAL
- C. SUPPLEMENTARY CONDITIONS
- D. INVITATION TO BID
- E. INSTRUCTIONS TO BIDDERS
- F. GENERAL CONDITIONS
- G. SPECIFICATIONS
- H. DRAWINGS

Addenda shall take Precedence over all sections referenced therein. Figure dimensions on Drawings shall take Precedence over scale dimensions. Detailed Drawings shall take Precedence over general Drawings.

20. CHANGES IN THE WORK

The OWNER, without notice to the Sureties and without invalidating the Contract, may order changes in the work within the general scope of the Contract by altering, adding to, or deducting from the work, the Contract being adjusted accordingly. All such work shall be executed under the conditions of the original Contract, except as specifically adjusted at the time of ordering such change.

In giving instructions, the ENGINEER may order minor changes in the work not involving extra cost and not inconsistent with the purposes of the Project, but otherwise, except in an emergency endangering life and Property, additions or deductions from the work shall be performed only in pursuance of an approved Change Order from the OWNER, countersigned by the ENGINEER.

If the work is reduced by alterations, such action shall not constitute a claim for damages based on loss of anticipated Profits.

21. EXAMINATION & VERIFICATION OF CONTRACT DOCUMENTS

The CONTRACTOR shall thoroughly examine and become familiar with all of the various parts of these Contract Documents and determine the nature and location of the work, the general and local conditions, and all other matters, which can in any way affect the work under this Contract. Failure to make an examination necessary for this determination shall not release the CONTRACTOR from the obligations of this Contract. No verbal agreement or conversation with any officer, agent, or employee of the OWNER, or with the ENGINEER either before or after the execution of this Contract shall affect or modify any of the terms or obligations herein contained.

22. DOCUMENTS TO BE KEPT ON THE JOBSITE

The CONTRACTOR shall keep one copy of the Contract Documents on the job- site, in good order, available to the ENGINEER and to his representatives.

The CONTRACTOR shall maintain on a daily basis at the jobsite, and make available to the ENGINEER on request, one current record set of the Drawings which have been accurately marked to indicate all modifications in the completed work that differ from the design information shown on the

Drawings. Upon Substantial completion of the work, the CONTRACTOR shall give the ENGINEER one complete set of these marked up record Drawings.

23. ADDITIONAL CONTRACT DOCUMENTS

Copies of Contract Documents or Drawings may be obtained on request from the ENGINEER and by paying the actual cost of reproducing the Contract Documents or Drawings.

24. OWNERSHIP OF CONTRACT DOCUMENTS

All portions of the Contract Documents, and copies thereof furnished by the ENGINEER are instruments of service for this Project. They are not to be used on other work and are to be returned to the ENGINEER on request at the completion of the work. Any reuse of these materials without specific written verification or adaptation by the ENGINEER will be at the risk of the user and without liability or legal expense to the ENGINEER. Such user shall hold the ENGINEER harmless from any and all damages, including reasonable attorneys' fees, from any and all claims arising from any such reuse. Any such verification and adaptation shall entitle the ENGINEER to further compensation at rates to be agreed upon by the user and the ENGINEER.

THE ENGINEER

25. AUTHORITY OF THE ENGINEER

The ENGINEER will be the OWNER's representative during the construction period. His authority and responsibility will be limited to the Provisions set forth in these Contract Documents. The ENGINEER will have the Authority to reject work that does not conform to the Contract Documents. However, neither the ENGINEER's authority to act under this Provision, nor any decision made by him in good faith either to exercise or not to exercise such authority, shall give rise to any duty or responsibility of the ENGINEER to the CONTRACTOR, any SUBCONTRACTOR, their respective Sureties, any of their agents or employees, or any other person performing any of the work.

26. DUTIES AND RESPONSIBILITIES OF THE ENGINEER

The ENGINEER will make visits to the site at intervals appropriate to the various stages of construction to observe the Progress and quality of the work and to determine, in general, if the work is proceeding in accordance with the intent of the Contract Documents. He will not make comprehensive or continuous review or observation to check quality or quantity of the work, and he will not be responsible for construction means, methods, techniques, sequences, or Procedures, or for safety Precautions and Programs in connection with the work. Visits and observations made by the ENGINEER shall not relieve the CONTRACTOR of his obligation to conduct comprehensive inspections of the work and to furnish materials and perform acceptable work, and to provide adequate safety Precautions, in conformance with the intent of the Contract.

The ENGINEER will make recommendations to the OWNER, in writing, on all claims of the OWNER or the CONTRACTOR arising from interpretation or execution of the Contract Documents. Such recommendations will be of factual and/or technical nature, and will not include the legal interpretation of the Contract Documents. Any necessary legal interpretation of the Contract Document will be made by the OWNER. Such recommendation shall be necessary before the CONTRACTOR can receive additional money under the terms of the Contract. Changes in work ordered by the ENGINEER shall

be made in compliance with Article CHANGES IN THE WORK.

One or more Project representatives may be assigned to observe the work. It is understood that such Project representatives shall have the authority to issue notice of nonconformance and make decisions within the limitations of the authority of the ENGINEER. The CONTRACTOR shall furnish all reasonable assistance required by the ENGINEER or Project representatives for Proper observation of the work. The above-mentioned Project representatives shall not relieve the CONTRACTOR of his obligations to conduct comprehensive inspections of the work and to furnish materials and perform acceptable work, and to provide adequate safety Precautions, in conformance with the intent of the Contract.

27. LIMITATIONS ON ENGINEER'S RESPONSIBILITIES

ENGINEER will not be responsible for CONTRACTOR's means, methods, techniques, sequences, or Procedures of construction, or the safety Precautions and Programs incident thereto, and ENGINEER will not be responsible for CONTRACTOR's failure to perform or furnish the work in accordance with the Contract Documents.

ENGINEER will not be responsible for the acts or omissions of CONTRACTOR or of any SUBCONTRACTOR, any supplier, or of any other person or organization performing or furnishing any of the work.

Whenever in the Contract Documents the terms "as ordered", "as directed", "as required", "as allowed", "as approved", or terms of like effect or import are used, or the adjectives "reasonable", "suitable", "acceptable", "Proper", or "satisfactory", or adjectives of like effect or import are used to describe a requirement, direction, review or judgment of ENGINEER as to the work, it is intended that such requirement, direction, review or judgment will be solely to evaluate the work for compliance with the Contract Documents (unless there is a specific statement indicating otherwise). The use of any such term or adjective shall not be effective to assign to ENGINEER any duty or authority to supervise or direct the furnishing or performance of the work or any duty or authority to undertake responsibility contrary to the Provisions of this Article.

28. REJECTED WORK

Any defective work or nonconforming materials or equipment that may be discovered at any time prior to expiration of the warranty period shall be removed and replaced by work which shall conform to the Provisions of the Contract Documents. Any material condemned or rejected shall be removed at once from the Project site.

Failure on the part of the ENGINEER to condemn or reject bad or inferior work or to note nonconforming materials or equipment on CONTRACTOR submittals shall not be construed to imply acceptance of such work. The OWNER shall reserve and retain all of its rights and remedies at law against the CONTRACTOR and its Surety for correction of any and all latent defects discovered after the guarantee period.

29. LINES AND GRADES

Lines and grades shall be established as provided in the supplementary conditions. All stakes, marks, and other reference information shall be carefully Preserved by the CONTRACTOR, and in case of their careless or unnecessary destruction or removal by him or his employees, such stakes, marks, and

other information shall be replaced at the CONTRACTOR's expense.

30. SUBMITTALS

After checking and verifying all field measurements and after complying with applicable Procedures specified in Division I, GENERAL REQUIREMENTS, CONTRACTOR shall submit to ENGINEER, in accordance with the schedule for submittals for review, shop drawings, electrical diagrams, and catalog cuts for fabricated items and manufactured items (including mechanical and electrical equipment), which shall bear a stamp or specific written indication that CONTRACTOR has satisfied CONTRACTOR's responsibilities under the Contract Documents with respect to the review of the submittal. All submittals shall be identified as ENGINEER may require. The data shown shall be complete with respect to quantities, dimensions specified, performance and design criteria, materials, and similar data to enable ENGINEER to review the information. CONTRACTOR shall also submit to ENGINEER for review, with such Promptness as to cause no delay in work, all samples required by the Contract Documents. All samples shall have been checked by and accompanied by a specific written indication that CONTRACTOR has satisfied CONTRACTOR's responsibilities under the Contract Documents with respect to the review of the submission and shall be identified clearly as to material, supplier, pertinent data such as catalog numbers and the use for which intended.

Before submission of each submittal, CONTRACTOR shall have determined and verified all quantities, dimensions, specified performance criteria, installation requirements, materials, catalog numbers, and similar data with respect thereto and reviewed or coordinated each submittal with other submittals and with the requirements of the work and the Contract Documents.

At the time of each submission, CONTRACTOR shall give ENGINEER specific written notice of each variation that the submittal may have from the requirements of the Contract Documents, and, in addition, shall cause a specific notation to be made on each shop drawing submitted to ENGINEER for review and approval of each variation.

ENGINEER will review submittals with reasonable Promptness, but ENGINEER's review will be only for conformance with the design concept of the Project and for compliance with the information given in the Contract Documents and shall not extend to means, methods, techniques, sequences, or Procedures of construction (except where a specific means, method, technique, sequence, or Procedure of construction is indicated in or required by the Contract Documents) or to safety Precautions or Programs incident thereto. The review of a separate item as such will not indicate review of the assembly in which the item functions. CONTRACTOR shall make corrections required by ENGINEER, and shall return the required number of corrected copies of shop drawings and submit as required new samples for review. CONTRACTOR shall direct specific attention in writing to revisions other than the corrections called for by ENGINEER on Previous submittals.

ENGINEER's review of submittals shall not relieve CONTRACTOR from the responsibility for any variation from the requirements of the Contract Documents unless CONTRACTOR has in writing called ENGINEER's attention to each such variation at the time of submission and ENGINEER has given written approval of each such variation by a specific written notation thereof incorporated therein or accompanying the shop drawing or sample approval; nor will any approval by ENGINEER relieve CONTRACTOR from responsibility for errors or omissions in the shop drawings or from responsibility for having complied with the Provisions herein.

Where a shop drawing or sample is required by the specifications, any related work performed Prior to ENGINEER's review and approval of the pertinent submission shall be at the sole expense and responsibility of the CONTRACTOR.

31. DETAIL DRAWINGS AND INSTRUCTIONS

The ENGINEER will furnish, with reasonable Promptness, additional instructions by means of Drawings or otherwise, if, in the ENGINEER's opinion, such are required for the Proper execution of the work. All such Drawings and instructions will be consistent with the Contract Documents, true developments thereof, and reasonably inferable there from.

THE CONTRACTOR & HIS EMPLOYEES

32. CONTRACTOR, AN INDEPENDENT AGENT

The CONTRACTOR shall independently perform all work under this Contract and shall not be considered as an agent of the OWNER or of the ENGINEER, nor shall the CONTRACTOR's SUBCONTRACTORS or employees be subagents of the OWNER or of the ENGINEER.

32. (a) ASSIGNMENT OF CONTRACT

Assignment of any part or the whole of this Contract shall be subject to review and approval of the City Commission.

33. SUBCONTRACTING

Unless modified in the Supplementary Conditions, within 10 days after the execution of the Contract, the CONTRACTOR shall submit to the ENGINEER the names of all SUBCONTRACTORS Proposed for the work, including the names of any SUBCONTRACTORS that were submitted with the Proposal. The CONTRACTOR shall not employ any SUBCONTRACTORS to which the OWNER may object to as lacking capability to properly perform work of the type and scope anticipated.

The CONTRACTOR is as fully responsible to the OWNER for the acts and omissions of his SUBCONTRACTORS and of persons either directly or indirectly employed by them as he is for the acts and omissions of persons directly employed by him.

Nothing contained in the Contract Documents shall create any contractual relationship between any SUBCONTRACTOR and the OWNER or ENGINEER.

34. INSURANCE AND LIABILITY

A. GENERAL

The CONTRACTOR shall provide (from insurance companies acceptable to the OWNER) the insurance coverage designated hereinafter and pay all costs before commencing work under this Contract. The CONTRACTOR shall furnish the OWNER with certificates of insurance specified herein showing the type, amount class of operations covered, effective dates, and date of expiration of policies, and containing substantially the following statement:

“The insurance covered by this certificate shall not be canceled or materially altered, except after 30 days' written notice has been received by the OWNER.”

In case of the breach of any Provision of this Article, the OWNER, at his option, may take out and

maintain, at the expense of the CONTRACTOR, such insurance as the OWNER may deem Proper and may deduct the cost of such insurance from any monies which may be due or become due the CONTRACTOR under this Contract.

B. CONTRACTOR & SUBCONTRACTOR INSURANCE

The CONTRACTOR shall not commence work under this Contract until he has obtained all the insurance required hereunder and such insurance has been reviewed by the OWNER, nor shall the CONTRACTOR allow any SUBCONTRACTOR to commence work on his subcontract until insurance specified below has been obtained. Review of the insurance by the OWNER shall not relieve or decrease the liability of the CONTRACTOR hereunder.

C. COMPENSATION & EMPLOYER'S LIABILITY INSURANCE

The CONTRACTOR shall maintain during the life of this Contract the statutory amount of Workmen's Compensation Insurance, in addition, Employer's Liability Insurance in an amount as specified in the Supplementary Conditions, for each occurrence, for all of his employees to be engaged in work on the Project under this Contract. In case any such work is subcontracted, the CONTRACTOR shall require the SUBCONTRACTOR to provide similar Workmen's Compensation and Employer's Liability Insurance for all of the SUBCONTRACTOR's employees to be engaged in such work.

D. GENERAL LIABILITY INSURANCE (INCLUDING AUTOMOBILE)

The CONTRACTOR shall maintain during the life of this Contract such general liability, completed operations and Products liability, and automobile liability insurance as will Provide coverage for claims for damages for personal injury, including accidental death, as well as for claims for Property damage, which may arise directly or indirectly from performance of the work under this Contract. The general liability policy shall include contractual liability assumed by the CONTRACTOR under Article **INDEMNITY**. Coverage for Property damage shall be on a "broad form" basis with no exclusions for "X, C & U". The amount of insurance to be provided shall be as specified in the Supplementary Conditions.

In the event any work under this Contract is performed by a SUBCONTRACTOR, the CONTRACTOR shall be responsible for any liability directly or indirectly arising out of the work performed by the SUBCONTRACTOR, to the extent such liability is not covered by the SUBCONTRACTOR's insurance.

The OWNER and ENGINEER, their officers, agents, and employees shall be named as Additional Insured's on the CONTRACTOR's and any SUBCONTRACTOR's general liability and automobile liability insurance policies for any claims arising out of work performed under this Contract.

E. BUILDERS RISK ALL RISK INSURANCE

Unless otherwise modified in the Supplementary Conditions, the CONTRACTOR shall secure and maintain during the life of this Contract, Builders Risk All Risk Insurance coverage in an amount equal to the full value of the facilities under construction. Such insurance shall include coverage for earthquake, landslide, flood, collapse, loss due to the results of faulty workmanship or design, and all other normally covered risks, and shall provide for losses to be paid to the CONTRACTOR, OWNER, and ENGINEER as their interests may appear.

The OWNER and ENGINEER, their officers, agents, and employees shall be named as additional insured's on the CONTRACTOR's and any SUBCONTRACTOR's Builders Risk All Risk insurance policies for any claims arising out of work performed under this Contract.

This insurance shall include a waiver of subrogation as to the ENGINEER, the OWNER, the CONTRACTOR, and their respective officers, agents, employees and SUBCONTRACTORS.

F. NO PERSONAL LIABILITY OF PUBLIC OFFICIALS

In carrying out any of the Provisions hereof in exercising any authority granted by the Contract, there will be no personal liability upon any public official.

35. INDEMNITY

To the maximum extent permitted by law, the CONTRACTOR shall indemnify and defend the OWNER and the ENGINEER, and their officers, employees, agents, and sub-consultants, from all claims and losses, including attorney's fees and litigation costs arising out of Property losses or health, safety, personal injury, or death claims by the CONTRACTOR, its SUBCONTRACTORS of any tier, and their employees, agents, or invitees regardless of the fault, breach of Contract, or negligence of the OWNER or ENGINEER, excepting only such claims or losses that have been adjudicated to have been caused solely by the negligence of the OWNER or the ENGINEER and regardless of whether or not the CONTRACTOR is or can be named a party in a litigation.

36. EXCLUSION OF CONTRACTOR CLAIMS

In performing its obligations, the ENGINEER and its consultants may cause expense for the CONTRACTOR or its SUBCONTRACTORS and equipment or material suppliers. However, those parties and their sureties shall maintain no direct action against the ENGINEER, its officers, employees, agents, and consultants for any claim arising out of, in connection with, or resulting from the Engineering services performed or required to be performed.

37. TAXES AND CHARGES

The CONTRACTOR shall withhold and pay any and all sales and use taxes and all withholding taxes, whether State or Federal, and pay all Social Security charges and also all State Unemployment Compensation charges, and pay or cause to be withheld, as the case may be, any and all taxes, charges, or fees or sums whatsoever, which are now or may hereafter be required to be paid or withheld under any laws.

38. REQUIREMENTS OF STATE LAW FOR PUBLIC WORKS PROJECTS

When the Contract Documents concern public works of the state or any county, municipality, or political subdivision created by its laws, the applicable statutes shall apply. All parties to this Contract shall determine the contents of all applicable statutes and comply with their Provisions throughout the performance of the Contract.

39. CODES, ORDINANCES, PERMITS AND LICENSES

The CONTRACTOR shall keep himself fully informed of all local codes and ordinances, as well as

state and federal laws, which in any manner affect the work herein specified. The CONTRACTOR shall at all times comply with said codes and ordinances, laws, and regulations, and Protect and indemnify the OWNER, the ENGINEER and their respective employees, and its officers and agents against any claim or liability arising from or based on the violation of any such laws, ordinances, or regulations. All permits, licenses and inspection fees necessary for Prosecution and completion of the work shall be secured and paid for by the CONTRACTOR, unless otherwise specified.

40. SUPERINTENDENCE

The CONTRACTOR shall keep at the Project site, competent supervisory personnel. The CONTRACTOR shall designate, in writing, before starting work, a Project superintendent who shall be an employee of the CONTRACTOR and shall have complete authority to represent and to act for the CONTRACTOR. ENGINEER shall be notified in writing prior to any change in superintendent assignment. The CONTRACTOR shall give efficient supervision to the work, using his best skill and attention. The CONTRACTOR shall be solely responsible for all construction means, methods, techniques, and Procedures, and for providing adequate safety Precautions and coordinating all portions of the work under the Contract. It is specifically understood and agreed that the ENGINEER, its employees and agents, shall not have control or charge of and shall not be responsible for the construction means, methods, techniques, Procedures, or for providing adequate safety Precautions in connection with the work under Contract.

41. RECEPTION OF ENGINEER'S COMMUNICATIONS

The superintendent shall receive for the CONTRACTOR all communications from the ENGINEER. Communications of major importance will be confirmed in writing upon request from the CONTRACTOR.

The ENGINEER may schedule Project meetings for the purposes of discussing and resolving matters concerning the various elements of the work. Time and place for these meetings and the names of persons required to be Present shall be as determined by the ENGINEER. CONTRACTOR shall comply with these attendance requirements and shall also require his SUBCONTRACTORS to comply.

42. SAFETY

The CONTRACTOR shall be solely and completely responsible for conditions of the jobsite, including safety of all persons (including employees) and Property during performance of the work. This requirement shall apply continuously and not be limited to normal working hours. Safety Provisions shall conform to U.S. Department of Labor (OSHA), and all other applicable federal, state, county, and local laws, ordinances, codes, and regulations. Where any of these are in conflict, the more stringent requirement shall be followed. The CONTRACTOR's failure to thoroughly familiarize himself with the aforementioned safety Provisions shall not relieve him from compliance with the obligations and penalties set forth therein.

The CONTRACTOR shall develop and maintain for the duration of this Contract, a safety Program that will effectively incorporate and implement all required safety Provisions. The CONTRACTOR shall appoint an employee who is qualified and authorized to supervise and enforce compliance with the safety Program. The duty of the ENGINEER to conduct construction review of the work does not include review or approval of the adequacy of the CONTRACTOR's safety Program, safety supervisor, or any safety measures taken in, on, or near the construction site. The CONTRACTOR, as a part of his safety Program, shall maintain at his office or other well-known place at the jobsite, safety equipment applicable to the work as Prescribed by the aforementioned authorities, all articles necessary for giving

first-aid to the injured, and shall establish the Procedure for the immediate removal to a hospital or a doctor's care of persons (including employees) who may be injured on the jobsite.

If death or serious injuries or serious damages are caused, the accident shall be reported immediately by telephone or messenger to both the ENGINEER and the OWNER. In addition, the CONTRACTOR must promptly report in writing to the ENGINEER all accidents whatsoever arising out of, or in connection with, the performance of the work whether on, or adjacent to, the site, giving full details and statements of witnesses.

If a claim is made by anyone against the CONTRACTOR or any SUBCONTRACTOR on account of any accident, the CONTRACTOR shall promptly report the facts in writing to the ENGINEER, giving full details of the claim.

43. PROTECTION OF WORK AND PROPERTY

The CONTRACTOR shall at all times safely guard and Protect from damage the OWNER's Property, adjacent Property, and his own work from injury or loss in connection with this Contract. All facilities required for Protection by federal, state, or municipal laws and regulations and local conditions must be provided and maintained.

The CONTRACTOR shall Protect his work and materials from damage due to the nature of the work, the elements, carelessness of other CONTRACTORS, or from any cause whatever until the completion and acceptance of the work. All loss or damages arising out of the nature of the work to be done under these Contract Documents, or from any unforeseen obstruction or defects which may be encountered in the Prosecution of the work, or from the action of the elements, shall be sustained by the CONTRACTOR.

44. RESPONSIBILITY OF CONTRACTOR TO ACT IN AN EMERGENCY

In case of an emergency, which threatens loss or injury of Property, and/or safety of life, the CONTRACTOR shall act, without previous instructions from the OWNER or ENGINEER, as the situation may warrant. The CONTRACTOR shall notify the ENGINEER thereof immediately thereafter. Any claim for compensation by the CONTRACTOR, together with substantiating documents in regard to expense, shall be submitted to the OWNER through the ENGINEER and the amount of compensation shall be determined by agreement.

45. MATERIALS AND APPLIANCES

Unless otherwise stipulated, the CONTRACTOR shall Provide and pay for all materials, labor, water, tools, equipment, heat, light, fuel, power, transportation, construction equipment and machinery, appliances, telephone, sanitary facilities, temporary facilities and other facilities and incidentals necessary for the execution and completion of the work.

Unless otherwise specified, all materials shall be new, and both workmanship and materials shall be of good quality. The CONTRACTOR shall, if required, furnish satisfactory evidence as to the kind and quality of materials.

In selecting and/or approving equipment for installation in the Project, the OWNER and ENGINEER assume no responsibility for injury or claims resulting from failure of the equipment to comply with applicable federal, state, and local safety codes or requirements, or the safety requirements of a recognized agency, or failure due to faulty design concepts, or defective workmanship and materials.

46. CONTRACTORS' AND MANUFACTURERS' COMPLIANCE WITH STATE SAFETY, OSHA, AND OTHER CODE REQUIREMENTS

The completed work shall include all necessary permanent safety devices, such as machinery guards and similar ordinary safety items required by the state and federal (OSHA) industrial authorities and applicable local and national codes. Further, any features of the work subject to such safety regulations shall be fabricated, furnished, and installed (including OWNER-furnished equipment) in compliance with these requirements. CONTRACTORS and manufacturers of equipment shall be held responsible for compliance with the requirements included herein. CONTRACTORS shall notify all equipment suppliers and SUBCONTRACTORS of the Provisions of this Article.

47. SUBSTITUTION OF MATERIALS

Except for OWNER-selected equipment items, and items where no substitution is clearly specified, whenever any material, article, device, Product, fixture, form, type of construction, or Process is indicated or specified by patent or Proprietary name, by name of manufacturer, or by catalog number, such specifications shall be deemed to be used for the purpose of establishing a standard of quality and facilitating the description of the material or Process desired. This Procedure

is not to be construed as eliminating from competition other Products of equal or better quality by other manufacturers where fully suitable in design, and shall be deemed to be followed by the words "or equal". The CONTRACTOR may, in such cases, submit complete data to the ENGINEER for consideration of another material, type, or Process that shall be substantially equal in every respect to that so indicated or specified. Substitute materials shall not be used unless approved in writing. The ENGINEER will be the sole judge of the substituted article or material.

48. TESTS, SAMPLES, & OBSERVATIONS

The CONTRACTOR shall furnish, without extra charge, the necessary test pieces and samples, including facilities and labor for obtaining the same, as requested by the ENGINEER. When required, the CONTRACTOR shall furnish certificates of tests of materials and equipment made at the point of manufacture by a recognized testing laboratory.

The OWNER, ENGINEER, and authorized government agents, and their representatives shall at all times be Provided safe access to the work wherever it is in Preparation or Progress, and the CONTRACTOR shall Provide facilities for such access and for observations, including maintenance of temporary and permanent access.

If the Specifications, laws, ordinances, or any public authority require any work, to be specially tested or approved, the CONTRACTOR shall give timely notice of its readiness for observations. If any work should be covered up without approval or consent of the ENGINEER, it shall, if required by the ENGINEER, be uncovered for examination at the CONTRACTOR's expense.

Reexamination of questioned work may be ordered by the ENGINEER, and, if so ordered, the work shall be uncovered by the CONTRACTOR. If such work is found to be in accordance with the Contract Documents, the OWNER will pay the cost of uncovering, exposure, observation, inspection, testing and reconstruction. If such work is found to be not in accordance with the Contract Documents, the CONTRACTOR shall correct the defective work, and the cost of reexamination and correction of the defective work shall be paid by the CONTRACTOR.

49. ROYALTIES AND PATENTS

The CONTRACTOR shall pay all royalty and licenses fees, unless otherwise specified. The CONTRACTOR shall defend all suits or claims for infringement of any patent rights and shall save the OWNER and the ENGINEER harmless from any and all loss, including reasonable attorneys' fees, on account thereof.

50. CONTRACTOR'S RIGHT TO TERMINATE CONTRACT

If the work should be stopped under an order of any court or other public authority for a period of more than 3 months, through no act or fault of the CONTRACTOR, its SUBCONTRACTORS, or respective employees or if the ENGINEER should fail to make recommendation for payment to the OWNER or return payment request to CONTRACTOR for revision within 30 days after it is due, or if the OWNER should fail to pay the CONTRACTOR within 30 days after time specified in Article PARTIAL PAYMENTS, any sum recommended by the ENGINEER, then the CONTRACTOR may, upon 15 days' written notice to the OWNER and the ENGINEER, stop work or terminate this Contract and recover from the OWNER payment for all acceptable work performed and reasonable termination expenses, unless said default has been remedied.

51. CORRECTION OF DEFECTIVE WORK DURING WARRANTY PERIOD

The CONTRACTOR hereby agrees to make, at his own expense, all repairs or replacements necessitated by defects in materials or workmanship, Provided under terms of this Contract, and pay for any damage to other works resulting from such defects, which become evident within 2 years after the date of final acceptance of the work or within 2 years after the date of substantial completion established by the ENGINEER for specified items of equipment, or within such longer period as may be Prescribed by law or by the terms of any applicable special guarantee required by the Contract Documents. Unremedied defects identified for correction during the warranty period but remaining after its expiration shall be considered as part of the obligations of the warranty. Defects in material, workmanship, or equipment which are remedied as a result of obligations of the warranty shall subject the remedied portion of the work to an extended warranty period of 2 years after the defect has been remedied.

The CONTRACTOR further assumes responsibility for a similar guarantee for all work and materials provided by SUBCONTRACTORS or manufacturers of packaged equipment components. The effective date for the start of the guarantee or warranty period for equipment qualifying as substantially complete is defined in Article SUBSTANTIAL COMPLETION, AND Article SUBSTANTIAL COMPLETION DATE, in these General Conditions.

The CONTRACTOR also agrees to hold the OWNER and the ENGINEER harmless from liability of any kind arising from damage due to said defects. The CONTRACTOR shall make all repairs and replacements promptly upon receipt of written order for same from the OWNER. If the CONTRACTOR fails to make the repairs and replacements Promptly, or in an emergency where delay would cause serious risk, or loss, or damage, the OWNER may have the defective work corrected or the rejected work removed and replaced, and the CONTRACTOR and his Surety shall be liable for the cost thereof.

PROGRESS OF THE WORK

52. BEGINNING OF THE WORK

Following execution of the Contract, the CONTRACTOR shall meet with the OWNER and ENGINEER relative to his arrangements for prosecuting the work.

53. SCHEDULES AND PROGRESS REPORTS

Prior to starting the construction, the CONTRACTOR shall Prepare and submit to the ENGINEER, a Progress schedule showing the dates on which each part or division of the work is expected to be started and finished, and a Preliminary schedule for submittals. The Progress schedule for submittals shall be brought up to date and submitted to the ENGINEER at the end of each month or at such other times the ENGINEER may request.

The CONTRACTOR shall forward to the ENGINEER, at the end of each month, an itemized report of the delivery status of major and critical items of purchased equipment and material, including shop drawings and the status of shop and field fabricated work. These Progress reports shall indicate the date of the purchase order, the current percentage of completion, estimated delivery, and cause of delay, if any.

If the completion of any part of the work or the delivery of materials is behind the submitted Progress schedule, the CONTRACTOR shall submit in writing a plan acceptable to the OWNER and ENGINEER for bringing the work up to schedule.

The OWNER shall have the right to withhold Progress payments for the work if the CONTRACTOR fails to update and submit the Progress schedule and reports as specified.

54. PROSECUTION OF THE WORK

It is expressly understood and agreed that the time of beginning, rate of Progress, and time of completion of the work are the essence of this Contract. The work shall be prosecuted at such time, and in or on such part or parts of the Project as may be required, to complete the Project as contemplated in the Contract Documents and the Progress schedule.

If the CONTRACTOR desires to carry on work at night or outside the regular hours, he shall give timely notice to the ENGINEER to allow satisfactory arrangements to be made for observing the work in Progress.

55. OWNER'S RIGHT TO RETAIN IMPERFECT WORK

If any part or portion of the work completed under this Contract shall Prove defective and not in accordance with the Drawings and Specifications, and if the imperfection in the same shall not be of sufficient magnitude or importance as to make the work dangerous or unsuitable, or if the removal of such work will create conditions which are dangerous or undesirable, the OWNER shall have the right and authority to retain such work but will make such deductions in the final payment therefore as may be just and reasonable.

56. OWNER'S RIGHT TO DO WORK

Should the CONTRACTOR neglect to Prosecute the work in conformance with the Contract Documents or neglect or refuse at his own cost to remove and replace work rejected by the ENGINEER, then the OWNER may notify the Surety of the condition, and after 10 days' written notice to the CONTRACTOR and the Surety, or without notice if an emergency or danger to the work or public exists, and without Prejudice to any other right which the OWNER may have under Contract, or otherwise, take over that portion of the work which has been improperly or non-timely executed, and make good the deficiencies and deduct the cost thereof from the payments then or thereafter due the CONTRACTOR.

57. OWNER'S RIGHT TO TRANSFER EMPLOYMENT

If the CONTRACTOR should abandon the work or if he should persistently or repeatedly refuse or should fail to make Prompt payment to SUBCONTRACTORS for material or labor, or to persistently disregard laws, ordinances, or to Prosecute the work in conformance with the Contract Documents, or otherwise be guilty of a substantial violation of any Provision of the Contract or any laws or ordinance, then the OWNER may, without Prejudice to any other right or remedy, and after giving the CONTRACTOR and Surety 10 days' written notice, transfer the employment for said work from the CONTRACTOR to the Surety. Upon receipt of such notice, such Surety shall enter upon the Premises and take possession of all materials, tools, and appliances thereon for the purpose of completing the work included under this Contract and employ by Contract or otherwise, any qualified person or persons to finish the work and Provide the materials therefore, in accordance with the Contract Documents, without termination of the continuing full force and effect of this Contract. In case of such transfer of employment to such Surety, the Surety shall be paid in its own name on estimates according to the terms hereof without any right of the CONTRACTOR to make any claim for the same or any part thereof.

If, after the furnishing of said written notice to the Surety, the CONTRACTOR and the Surety still fail to make reasonable Progress on the performance of the work, the OWNER may terminate the employment of the CONTRACTOR and take possession of the Premises and of all materials, tools, and appliances thereon and finish the work by whatever method he may deem expedient and charge the cost thereof to the CONTRACTOR and the Surety. In such case, the CONTRACTOR shall not be entitled to receive any further payment until the work is finished. If the expense of completing the Contract, including compensation for additional managerial and administrative services, shall exceed such unpaid balance, the CONTRACTOR and the Surety shall pay the difference to the OWNER.

58. DELAYS AND EXTENSION OF TIME

If the CONTRACTOR is delayed in the Progress of the work by any act or neglect of the OWNER or the ENGINEER, or by any separate CONTRACTOR employed by the OWNER, or by strikes, lockouts, fire, adverse weather conditions not reasonably anticipated, or acts of Nature, and if the CONTRACTOR, within 48 hours of the start of the occurrence, gives written notice to the OWNER of the cause of the potential delay and estimate of the possible time extension involved, and within 10 days after the cause of the delay has been remedied, the CONTRACTOR gives written notice to the OWNER of any actual time extension requested as a result of the aforementioned occurrence, then the Contract time may be extended by change order for such reasonable time as the ENGINEER determines. It is agreed that no claim shall be made or allowed for any damages, loss, or expense which may arise out of any delay caused by the above referenced acts or occurrences other than claims for the appropriate extension of time. No extension of time will be granted to the CONTRACTOR for delays occurring to

parts of the work that have no measurable impact on the completion of the total work under this Contract. No extension of time will be considered for weather conditions reasonably anticipated for the area in which the work is being performed. Reasonably anticipated weather conditions will be based on official records of monthly Precipitation and other historical data. Adverse weather conditions, if determined to be of a severity that would impact Progress of the work, may be considered as cause for an extension of Contract completion time.

Delays in delivery of equipment or material purchased by the CONTRACTOR or his SUBCONTRACTORS, including OWNER-selected equipment shall not be considered as a just cause for delay, unless the OWNER determines that for good cause the delay is beyond the control of the CONTRACTOR. The CONTRACTOR shall be fully responsible for the timely ordering; scheduling, complete the work is the per-diem rate, as stipulated in the Proposal. The said amount is hereby agreed upon as a reasonable estimate of the costs, which may be accrued by the OWNER after the expiration of the time of completion. It is expressly understood and agreed that this amount is not to be considered in the nature of a penalty, but as liquidated damages which have accrued against the CONTRACTOR. The OWNER shall have the right to deduct such damages from any amount due, or that may become due the CONTRACTOR, or the amount of such damages shall be due and collectible from the CONTRACTOR or Surety.

59. DIFFERING SITE CONDITIONS

The CONTRACTOR shall promptly, and before the conditions are disturbed, give a written notice to the OWNER and ENGINEER of:

- A. Subsurface or latent physical conditions at the site which differ materially from those indicated in this contract,
- B. Unknown physical conditions at the site, of an unusual nature, which differ materially from those ordinarily encountered and generally recognized as inherent in work of the character provided for in the Contract.

The ENGINEER will investigate the site conditions promptly after receiving the notice. If the conditions do materially so differ and cause an increase or decrease in the CONTRACTOR's cost of, or the time required for, performing any part of the work under this Contract, whether or not changed as a result of the conditions, and equitable adjustment shall be made under this Article and the Contract modified in writing accordingly.

No request by the CONTRACTOR for an equitable adjustment to the Contract under this Article will be allowed, unless the CONTRACTOR has given the written notice required; Provided that the time prescribed above for giving written notice may be extended by the OWNER.

No request by the CONTRACTOR for an equitable adjustment to the Contract for differing site conditions will be allowed if made after final payment under this Contract.

60. LIQUIDATED DAMAGES

Should the CONTRACTOR fail to complete the work, or any part thereof, in the time agreed upon in the Contract or within such extra time as may have been allowed for delays by extensions granted as Provided in the Contract, the CONTRACTOR shall reimburse the OWNER for the additional expense and damage for each calendar day, Sundays and legal holidays included, that the Contract remains uncompleted after the Contract completion date. It is agreed that the amount of such additional expense and damage incurred by reason of failure to complete the work is the per-diem rate, as stipulated in the

Proposal. The said amount is hereby agreed upon as a reasonable estimate of the costs which may be accrued by the OWNER after the expiration of the time of completion. It is expressly understood and agreed that this amount is not to be considered in the nature of a penalty, but as liquidated damages which have accrued against the CONTRACTOR. The OWNER shall have the right to deduct such damages from any amount due, or that may become due the CONTRACTOR, or the amount of such damages shall be due and collectible from the CONTRACTOR or Surety.

61. OTHER CONTRACTS

The OWNER reserves the right to let other Contracts in connection with the work. The CONTRACTOR shall afford other CONTRACTORS reasonable opportunity for the introduction and storage of their materials and the execution of their work and shall properly connect and coordinate his work with theirs.

If any part of the work under this Contract depends for Proper execution or results upon the work of any other CONTRACTOR, utility service company or OWNER, the CONTRACTOR shall inspect and Promptly report to the ENGINEER in writing any patent or apparent defects to deficiencies in such work that render it unsuitable for such Proper execution and results. The CONTRACTOR's failure to so report shall constitute and acceptance of the work by others as being fit and Proper for integration with work under this Contract, except for latent or non-apparent defects and deficiencies in the work.

62. USE OF PREMISES

The CONTRACTOR shall confine his equipment, the storage of materials and the operation of his workers to limits shown on the Drawings or indicated by law, ordinances, permits, or directions of the ENGINEER, and shall not unreasonably encumber the Premises with his materials. The CONTRACTOR shall provide, at his own expense, the necessary rights-of-way and access to the work, which may be required outside the limits of the OWNER's Property and shall furnish the ENGINEER copies of permits and agreements for use of the Property outside that provided by the OWNER.

The CONTRACTOR shall not load nor permit any part of the structure to be loaded in any manner that will endanger the structure, nor shall CONTRACTOR subject any part of the work or adjacent Property to stresses or Pressures that will endanger it.

63. SUBSTANTIAL COMPLETION DATE

The ENGINEER may issue a written notice of substantial completion for the purpose of establishing the starting date for specific equipment guarantees, and to establish the date that the OWNER will assume the responsibility for the cost of operating such equipment. Said notice shall not be considered as final acceptance of any portion of the work or relieve the CONTRACTOR from completing the remaining work within the specified time and in full compliance with the Contract Documents. See SUBSTANTIAL COMPLETION under DEFINITIONS of these General Conditions.

64. PERFORMANCE TESTING

Operating equipment and systems shall be performance tested in the Presence of the ENGINEER to demonstrate compliance with the specified requirements. Performance testing shall be conducted under the specified design operating conditions or under such simulated operating conditions as recommended or approved by the ENGINEER. Schedule such testing with the ENGINEER at least one week in advance of the planned date for testing.

65. OWNER'S USE OF PORTIONS OF THE WORK

Following issuance of the written notice of Substantial Completion, the OWNER may initiate operation of the facility. Such use shall not be considered as final acceptance of any portion of the work, nor shall such use be considered as cause for an extension of the Contract completion time, unless authorized by a Change Order issued by the OWNER.

66. CUTTING AND PATCHING

The CONTRACTOR shall do all cutting, fitting, or patching of his work that may be required to make its several parts come together Properly and fit it to receive or be received by work of other CONTRACTORS shown upon or reasonably implied by the Drawings.

67. CLEANING UP

The CONTRACTOR shall, at all times, keep Property on which work is in Progress and the adjacent Property free from accumulations of waste material or rubbish caused by employees or by the work. Upon completion of the construction, the CONTRACTOR shall remove all temporary structures, rubbish, and waste materials resulting from his operations.

PAYMENT

68. PAYMENT FOR CHANGE ORDERS

The OWNER's request for quotations on alterations to the work shall not be considered authorization to proceed with the work expediting, delivery, and installation of all equipment and materials. Within a reasonable period after the CONTRACTOR submits to the OWNER a written request for an extension of time, the ENGINEER will Present his written opinion to the OWNER as to whether an extension of time is justified, and, if so, his recommendation as to the number of days for time extension. The OWNER will make the final decision on all requests for extension of time.

Prior to the issuance of a formal Change Order, nor shall such request justify any delay in existing work. Quotations for alterations to the work shall include substantiating documentation with an itemized breakdown of CONTRACTOR and SUBCONTRACTOR costs, including labor, material, rentals, approved services, overhead, and profit. OWNER may require detailed cost data in order to substantiate the reasonableness of the proposed costs.

Any compensation paid in conjunction with the terms of a Change Order shall comprise total compensation due the CONTRACTOR for the work or alteration defined in the Change Order. By signing the Change Order, the CONTRACTOR acknowledges that the stipulated compensation includes payment for the work or alteration plus all payment for the interruption of schedules, extended overhead, delay, or any other impact claim or ripple effect, and by such signing specifically waives any reservation or claim for additional compensation in respect to the subject Change Order.

At the OWNER's option, payment or credit for any alterations covered by a Change Order shall be determined by one or a combination of the methods set forth in A, B, or C below, as applicable:

A. UNIT PRICES

Those unit Prices stipulated in the Proposal shall be utilized where they are applicable. In the event the Change Order results in a change in the original quantity that is materially and significantly different from the original bid quantity, a new unit Price shall be negotiated upon demand of either party. Unit Prices for new items included in the Change Order shall be negotiated and mutually agreed upon.

B. LUMP SUM

A total lump sum for the work negotiated and mutually acceptable to the CONTRACTOR and the OWNER. Lump sum quotations for modifications to the work shall include substantiating documentation with an itemized breakdown of CONTRACTOR and SUBCONTRACTOR costs, including labor, material, rentals, approved services, overhead, and Profit, all calculated as specified under "C" below.

C. COST REIMBURSEMENT WORK

The term "cost reimbursement" shall be understood to mean that payment for the work will be made on a time and expense basis, that is, on an accounting of the CONTRACTOR's forces, materials, equipment, and other items of cost as required and used to do the work.

If the method of payment cannot be agreed upon prior to the beginning of the work, and the OWNER directs by written Change Order that the work be done on a cost reimbursement basis, then the CONTRACTOR shall furnish labor, and furnish and install equipment and materials necessary to complete the work in a satisfactory manner and within a reasonable period of time. For the work performed, payment will be made for the documented actual cost of the following:

1. Labor including foremen for those hours they are assigned and participating in the cost reimbursement work (actual payroll cost, including wages, fringe benefits as established by negotiated labor agreements, labor insurance, and labor taxes as established by law). No other fixed labor burdens will be considered, unless approved in writing by the OWNER.
2. Material delivered and used on the designated work, including sales tax, if paid by the CONTRACTOR or his SUBCONTRACTOR.
3. Rental or equivalent rental cost of equipment, including necessary transportation for items having a value in excess of \$100. Rental or equivalent rental cost will be allowed for only those days or hours during which the equipment is in actual use. Rental and transportation allowances shall not exceed the current rental rates prevailing in the locality. The rentals allowed for equipment will, in all cases, be understood to cover all fuel, supplies, repairs, and renewals, and no further allowances will be made for those items, unless specific agreement to that effect is made.
4. Additional bond, as required and approved by the OWNER.
5. Additional insurance (other than labor insurance) as required and approved by the OWNER.

In addition to items 1 through 5 above, an added fixed fee for general overhead and profit shall be negotiated and allowed for the Contractor (or approved SUBCONTRACTOR) actually executing the Cost Reimbursement work.

An additional fixed fee shall be negotiated and allowed the CONTRACTOR for the administrative handling of portions of the work that are executed by an approved SUBCONTRACTOR. No additional fixed fee will be allowed for the administrative handling of work executed by a SUBCONTRACTOR of a SUBCONTRACTOR, unless by written permission from the OWNER.

The added fixed fees shall be considered to be full compensation, covering the cost of general supervision, overhead, Profit, and any other general expense. The CONTRACTOR's records shall make clear distinction between the direct costs of work paid for on a cost reimbursement basis and the costs of other work. The CONTRACTOR shall furnish the ENGINEER report sheets in duplicate of each day's cost reimbursement work no later than the working day following the performance of said work. The daily report sheets shall itemize the materials used, and shall cover the direct cost of labor and the charges for equipment rental, whether furnished by the CONTRACTOR, SUBCONTRACTOR or other forces. The daily report sheets shall provide names or identifications and classifications of workers, the hourly rate of pay and hours worked, and also the size, type, and identification number of equipment and hours operated.

Material charges shall be substantiated by valid copies of vendors' invoices. Such invoices shall be submitted with the daily report sheets, or, if not available, they shall be submitted with subsequent daily report sheets. Said daily report sheets shall be signed by the CONTRACTOR or his authorized agent.

The OWNER reserves the right to furnish such materials and equipment as he deems expedient and the CONTRACTOR shall have no claim for Profit or added fees on the cost of such materials and equipment. To receive partial payments and final payment for cost reimbursement work, the CONTRACTOR shall submit to the ENGINEER, detailed and complete documented verification of the CONTRACTOR's and any of his SUBCONTRACTORS' actual costs involved in the cost reimbursement work. Such costs shall be submitted within 30 days after said work has been performed.

69. PARTIAL PAYMENTS

A. GENERAL

Nothing in this Article shall be construed to affect the right, hereby reserved, to reject the whole or any part of the aforesaid work, should such work be later found not to comply with the Provisions of the Contract Documents. All estimated quantities of work for which partial payments have been made are subject to review and correction on the final estimate. Payment by the OWNER and acceptance by the CONTRACTOR of partial payments based on periodic estimates of quantities of work performed shall not, in any way, constitute acceptance of the estimated quantities used as a basis for computing the amounts of the partial payments.

B. ESTIMATE

At least 30 days before each Progress payment falls due, as specified in the Supplementary Conditions, the CONTRACTOR shall submit to the ENGINEER a detailed estimate of the amount earned during the Preceding month for the separate portions of the work, and request payment. As used in this Article, the words "amount earned" means the value, on the date of the estimate for partial payment, of the work completed in accordance with the Contract Documents, and the value of approved materials delivered to the Project site suitable stored and Protected Prior to incorporation into the work.

ENGINEER will, within 7 days after receipt of each request for payment, either indicate in writing a

recommendation of payment and present the request to OWNER, or return the request to CONTRACTOR indicating in writing ENGINEER's reasons for refusing to recommend payment. In the latter case, CONTRACTOR may, within 7 days, make the necessary corrections and resubmit the request.

ENGINEER may refuse to recommend the whole or any part of any payment if, in his opinion, it would be incorrect to make such representations to OWNER. ENGINEER may also refuse to recommend any such payment, or, because of subsequently discovered evidence or the results of subsequent inspections or tests, nullify any such payment previously recommended to such an extent as may be necessary in ENGINEER's opinion to protect the OWNER from loss because:

1. The work is defective, or completed work has been damaged requiring correction or replacement;
2. Written claims have been made against OWNER or Liens have been filed in connection with the work;
3. The Contract Price has been reduced because of Change Orders;
4. OWNER has been required to correct defective work or complete the work in accordance with Article OWNER'S RIGHT TO DO WORK;
5. Of CONTRACTOR's unsatisfactory Prosecution of the work in accordance with the Contract Documents; or
6. CONTRACTOR's failure to make payment to SUBCONTRACTORS or for labor, materials, or equipment.

C. DEDUCTION FROM ESTIMATE

Unless modified in the Supplementary Conditions, deductions from the estimate will be as described below:

1. The OWNER will deduct from the estimate, and retain as part security, 10 percent of the amount earned for work satisfactorily completed. A deduction and retainage of 10 percent will be made on the estimated amount earned for approved items of material delivered to and properly stored at the jobsite but not incorporated into the work. When the work is 50 percent complete, the OWNER may reduce the retainage to 5 percent of the dollar value of all work satisfactorily completed to date provided the CONTRACTOR is making satisfactory Progress and there is no specific cause for a greater retainage. The OWNER may reinstate the retainage up to 10 percent if the OWNER determines, at his discretion, that the CONTRACTOR is not making satisfactory Progress or where there is other specific cause for such withholding.

D. QUALIFICATION FOR PARTIAL PAYMENT FOR MATERIALS DELIVERED

Unless modified in the Supplementary Conditions, qualification for partial payment for materials delivered but not yet incorporated into the work shall be as described below:

1. Materials, as used herein, shall be considered to be those items which are fabricated and

manufactured material and equipment. No consideration shall be given to individual purchases of less than \$200 for any one item.

2. To receive partial payment for materials delivered to the site, but not incorporated in the work, it shall be necessary for the CONTRACTOR to include a list of such materials on the Partial Payment Request. At his sole discretion, the ENGINEER may approve items for which partial payment is to be made. Partial payment shall be based on the CONTRACTOR's actual cost for the materials as evidenced by invoices from the supplier. Proper storage and Protection shall be provided by the CONTRACTOR, and as approved by the ENGINEER. Final payment shall be made only for materials actually incorporated in the work and, upon acceptance of the work, all materials remaining for which advance payments had been made shall revert to the CONTRACTOR, unless otherwise agreed, and partial payments made for these items shall be deducted from the final payment for the work.
3. CONTRACTOR warrants and guarantees that title to all work, materials, and equipment covered by any Application for Payment, whether incorporated in the Project or not, will pass to OWNER at the time of payment free and clear of all liens, claims, security interests, and encumbrances.
4. If requested by the ENGINEER, the CONTRACTOR shall provide, with subsequent pay requests, invoices receipted by the supplier showing payment in full has been made.

E. PAYMENT

After deducting the retainage and the amount of all previous partial payments made to the CONTRACTOR from the amount earned, the amount due will be made payable to the CONTRACTOR. Recommendations for payment received by the OWNER less than 9 days Prior to the scheduled day for payment will not be Processed or paid until the following month.

70. CLAIMS FOR EXTRA WORK

In any case where the CONTRACTOR deems additional time or compensation will become due him under this Contract for circumstances other than those defined in Article DELAYS AND EXTENSION OF TIME, the CONTRACTOR shall notify the ENGINEER, in writing, of his intention to make claim for such time or compensation before he begins the work on which he bases the claim, in order that such matters may be settled, if possible, or other appropriate action taken. The notice of claim shall be in duplicate, in writing, and shall state the circumstances and the reasons for the claim, but need not state the amount. If such notification is not given or if the ENGINEER is not afforded Proper facilities by the CONTRACTOR for keeping strict account of actual cost, then the CONTRACTOR hereby agrees to waive the claim for such additional time or compensation. Such notice by the CONTRACTOR, and fact that the ENGINEER has kept account of the cost as aforesaid, shall not in any way be construed as proving the validity of the claim.

No extension of time will be granted to the CONTRACTOR for delays resulting from extra work that have no measurable impact on the completion of the total Work under this Contract. Claims for additional time or compensation shall be made in itemized detail and submitted, in writing, to the OWNER and ENGINEER within 10 days following completion of that portion of the work for which the CONTRACTOR bases his claim. Failure to make the claim for additional compensation in the manner and within the time specified above shall constitute waiver of that claim. In case the claim is found to be just, it shall be allowed and paid for as provided in Article PAYMENT FOR CHANGE

ORDERS.

71. RELEASE OF LIENS OR CLAIMS

The CONTRACTOR shall indemnify and hold harmless the OWNER from all claims for labor and materials furnished under this Contract. Prior to the final payment, the CONTRACTOR shall furnish to the OWNER, as part of his final payment request, a certification that all of the CONTRACTOR's obligations on the project have been satisfied and that all monetary claims and indebtedness have been paid. The CONTRACTOR shall furnish complete and legal effective releases or waivers, satisfactory to the OWNER, of all liens arising out of or filed in connection with the work.

72. FINAL PAYMENT

Upon completion of all the work under this Contract, the CONTRACTOR shall notify the ENGINEER, in writing, that he has completed his part of the Contract and shall request final payment. Upon receipt of such notice the ENGINEER will inspect and, if acceptable, submit to the OWNER his recommendation as to acceptance of the completed work and as to the final estimate of the amount due the CONTRACTOR. Upon approval of this final estimate by the OWNER and compliance by the CONTRACTOR with Provisions in Article **RELEASE OF LIENS OR CLAIMS**, and other Provisions as may be applicable, the OWNER shall pay to the CONTRACTOR all monies due him under the Provisions of these Contract Documents.

73. NO WAIVER OF RIGHTS

Neither the inspection by the OWNER, through the ENGINEER or any of his employees, nor any order by the OWNER for payment of money, nor any payment for, or acceptance of, the whole or any part of the work by the OWNER or ENGINEER, nor any extension of time, nor any possession taken by the OWNER or its employees, shall operate as a waiver of any Provision of this Contract, or any power herein reserved to the OWNER, or any right to damages herein Provided, nor shall any waiver of any breach in this Contract be held to be a waiver of any other or subsequent breach. Acceptance or final payment shall not be final and conclusive with regards to latent defects, fraud, or such gross mistakes as may amount to fraud, or as regards the OWNER's rights under the warranty.

74. ACCEPTANCE OF FINAL PAYMENT CONSTITUTES RELEASE

The acceptance by the CONTRACTOR of the final payment shall release the OWNER and the ENGINEER, as representatives of the OWNER, from all claims and all liability to the CONTRACTOR for all things done or furnished in connection with the work, and every act of the OWNER and others relating to or arising out of the work except claims Previously made in writing and still unsettled. No payment, however, final or otherwise, shall operate to release the CONTRACTOR or his Sureties from obligations under this Contract and the Performance Bond, Payment Bond, and other bonds and warranties, as herein provided.

SUPPLEMENTARY CONDITIONS

REVISIONS AND ADDITIONS TO THE GENERAL CONDITIONS

The General Conditions are hereby revised as follows:

ARTICLE 9 "ENGINEER"

Add the following:

Wherever in these Documents the word "Engineer" appears, it shall be understood to mean

**The Engineer of Record Perez Engineering & Development, Inc.,
Key West, Florida**

ARTICLE 12 "OWNER"

Add the following:

Wherever in these Documents the word "Owner" appears, it shall be understood to mean the City of Key West whose address is 3126 Flagler Avenue, P.O. Box 1409, Key West, Florida 33041-1409.

The City Engineer or his/her authorized representative, who will perform the Contract administrative and field inspections as authorized agents of the Owner.

ARTICLE 14 "SPECIFICATIONS"

Add the following:

FEDERAL, STATE, COUNTY, AND LOCAL STANDARD SPECIFICATIONS

Where portions of the work traverse or cross federal, state, county, or local highways, roads, or streets, and the agency in control of such property has established standard specifications governing items of work that differ from these Specifications, the most stringent requirements shall apply.

The Contractor shall comply with all regulations and requirements of the State Highway Department and the County Road Department wherever the work traverses or crosses state or county highways.

ARTICLE 29 "LINES AND GRADES"

Add the following:

It will be the Contractor's responsibility to layout the work and to transfer elevations from benchmarks. Where new construction connects to existing facilities, the Contractor shall check and establish the exact location prior to construction of the facilities.

The Contractor shall furnish all surveys, labor, and equipment, including setting all alignment and gradient, grade stakes, batter boards, and everything necessary to lay out his work. The Contractor shall be responsible for maintaining and re-establishing at his expense, all control points. After completion of his construction, he shall reset all permanent monuments at their original locations and elevations.

All layout work may be checked by the Engineer, and the Contractor shall furnish all necessary labor, equipment, and materials, and shall cooperate and assist the Engineer in making such checks.

The dimensions for lines and elevations for grades of the structures, appurtenances, and utilities will be shown on Drawings, together with other pertinent information required for laying out the work. If site conditions vary from those indicated, the Contractor shall notify the Engineer immediately, who will make any minor adjustment as required.

ARTICLE 34 "INSURANCE & LIABILITY"

Delete Sub Articles A,B,C & D and substitute the following:

CONTRACTOR Insurance/Indemnity Language

Insurance

CONTRACTOR is to secure, pay for, and file with the City of Key West, prior to commencing any work under the Contract, all certificates for Workers' Compensation, Public Liability, and Property Damage Liability Insurance and such other insurance coverages as may be required by specifications and addenda thereto, in at least the following minimum amounts with specification amounts to prevail if greater than minimum amounts indicated. Notwithstanding any other provision of the Contract, the CONTRACTOR shall provide the minimum limits of liability insurance coverages as follows:

Auto Liability	\$1,000,000	Combined Single Limit
General Liability	\$2,000,000	Aggregate (Per Project)
	\$2,000,000	Products Aggregate
	\$1,000,000	Any One Occurrence
	\$1,000,000	Personal Injury
	\$300,000	Fire Damage/Legal
Additional Umbrella Liability	\$2,000,000	Occurrence/Aggregate

CONTRACTOR shall furnish an original Certificate of Insurance indicating, and such policy providing coverage to, City of Key West named as "Additional Insured" on **PRIMARY** and **NON CONTRIBUTORY** basis utilizing an ISO standard endorsement at **least as broad as CG 2010**

(11/85) or its Equivalent, (COMBINATION OF CG 20 10 07 04 and CG 20 37 07 04, providing coverage for completed operations is acceptable) INCLUDING A “Waiver of Subrogation” clause in favor of City of Key West on all policies. CONTRACTOR will maintain the General Liability and Umbrella Liability insurance coverages summarized above with coverage continuing in full force including the “additional insured” endorsement until at least 3 years beyond completion and delivery of the work contracted herein.

Notwithstanding any other provision of the Contract, the **CONTRACTOR** shall maintain complete Workers’ Compensation coverage for each and every employee, principal, officer, representative, or agent of the **CONTRACTOR** who is performing any labor, services, or material under the Contract. Further, **CONTRACTOR** shall additionally maintain the following minimum limits of coverage:

Bodily Injury Each Accident	\$1,000,000
Bodily Injury by Disease Each Employee	\$1,000,000
Bodily Injury by Disease Policy Limit	\$1,000,000

If the work is being done on or near a navigable waterway, **CONTRACTOR’s** Workers’ Compensation policy shall be endorsed to provide **USL&H Act (WC 00 01 06 A)** and **Jones Act (WC 00 02 01 A)** coverage if specified by the City of Key West. **CONTRACTOR** shall provide the City of Key West with a Certificate of Insurance verifying compliance with the workman’s compensation coverage as set forth herein and shall provide as often as required by the City of Key West such certification which shall also show the insurance company, policy number, effective and expiration date, and the limits of workman’s compensation coverage under each policy.

CONTRACTOR’s insurance policies shall be endorsed to give 30 days’ written notice to the City of Key West in the event of cancellation or material change, using form CG 02 24, or its equivalent.

Certificates of Insurance submitted to the City of Key West will not be accepted without copies of the endorsements being requested. This includes additional insured endorsements, cancellation/material change notice endorsements, and waivers of subrogation. Copies of USL&H Act and Jones Act endorsements will also be required if necessary. **PLEASE ADVISE YOUR INSURANCE AGENT ACCORDINGLY.**

CONTRACTOR will comply with any and all safety regulations required by any agency or regulatory body including but not limited to OSHA. **CONTRACTOR** will notify City of Key West immediately by telephone at (305) 809-3811 of any accident or injury to anyone that occurs on the jobsite and is related to any of the work being performed by the **CONTRACTOR**.

Add the following Sub Article:

G. SURETY AND INSURER QUALIFICATIONS

All bonds, insurance contracts, and certificates of insurance shall be either executed by or countersigned by a licensed resident agent of the Surety or insurance company, having his place of business in the State of Florida, and in all ways complying with the insurance laws of the State of Florida. Further, the said Surety or Insurance Company shall be duly licensed and qualified to do business in the State of Florida. If requested, Contractor shall Provide Proof of Florida Licensure

for all insurance companies. The City of Key West shall be named as Additional Insured on the insurance certificates.

ARTICLE 35 “INDEMNITY”

Delete Text for Article 35 “INDEMNITY” in its entirety and substitute the following:

To the fullest extent permitted by law, the CONTRACTOR expressly agrees to indemnify and hold harmless the City of Key West, their officers, directors, agents, and employees (herein called the “indemnitees”) from liabilities, damages, losses and costs, including, but not limited to, reasonable attorney’s fees and court costs, such legal expenses to include costs incurred in establishing the indemnification and other rights agreed to in this Paragraph, to persons or property, to the extent caused by the negligence, recklessness, or intentional wrongful misconduct of the CONTRACTOR, its Subcontractors or persons employed or utilized by them in the performance of the Contract. Claims by indemnitees for indemnification shall be limited to the amount of CONTRACTOR’s insurance or \$1 million per occurrence, whichever is greater. The parties acknowledge that the amount of the indemnity required hereunder bears a reasonable commercial relationship to the Contract and it is part of the project specifications or the bid documents, if any. The indemnification obligations under the Contract shall not be restricted in any way by any limitation on the amount or type of damages, compensation, or benefits payable by or for the CONTRACTOR under workers’ compensation acts, disability benefits acts, or other employee benefits acts, and shall extend to and include any actions brought by or in the name of any employee of the CONTRACTOR or of any third party to whom CONTRACTOR may subcontract a part or all of the Work. This indemnification shall continue beyond the date of completion of the work.

ARTICLE 39 "CODES, ORDINANCES, PERMITS, AND LICENSES"

Add the following Subarticles:

A. PERMIT FOR WORK WITHIN LOCAL RIGHTS-OF-WAY

The Contractor shall obtain from the City of Key West the necessary permits for work within the rights-of-way. The Contractor shall abide by all regulations and conditions, including maintenance of traffic, FDOT Standard.

B. NOISE ORDINANCE

The Contractor shall comply with the City of Key West Noise Ordinance.

C. LICENSES

Within 10 days of Notice of Award, the successful Bidder must represent that he holds all applicable state, county, and City of Key West licenses and permits required to do business as a contractor with respect to the work described in the Contract Documents.

Further, the successful Bidder must, within 10 days of Notice of Award, furnish documentation

showing that, as a minimum, he has complied with the provisions of Chapter 91 of the Code of Ordinances of the City of Key West in order to enter into the Agreement contained in the Contract Documents.

Specifically, within 10 days after Notice of Award, the successful Bidder must demonstrate that he holds, as a minimum, the following licenses and certificates:

- A. All licenses or certificates required by federal, state or local statutes or regulations.
- B. A valid occupational license issued by the City of Key West, if required.
- C. A valid Certificate of Competency issued by the Building Official of the City of Key West which shall remain valid throughout the time period of the Contract, if required.

FOLLOWING ARTICLE 40 "SUPERINTENDENCE"

Add the following Article:

40 A. CONTRACTOR'S RESPONSIBILITIES:

a. The Contractor shall employ such superintendents, foremen, and workmen as are careful and competent. Whenever the Engineer shall determine that any person employed by the Contractor is in his opinion, incompetent, unfaithful, disorderly or insubordinate, such person shall, upon notice, be discharged from the work and shall not again be employed on it except with the written consent of the Engineer.

Should the Contractor fail to remove such person or persons, or fail to furnish suitable or sufficient machinery, equipment or force for the proper prosecution of the work the Engineer may withhold all estimates which are, or may become due, or may suspend the work until such orders are complied with.

b. The Contractor shall provide qualified personnel to assist the Engineer in making field checks, measurements, asbuilt checks, inspection, test runs, and the necessary quality check work related to the project work. An English speaking superintendent or foreman shall be onsite at all times.

c. The Contractor shall provide and maintain at his own expense, in a sanitary condition, such accommodations for the use of his employees as is necessary to comply with the requirements and regulations of the State and City Boards of Health. He shall commit no public nuisance.

d. The Contractor shall conduct the work so as to insure the least obstruction to traffic practicable, and shall provide for the convenience of the general public and of the residents along and adjacent to the work in a manner satisfactory to the Engineer. Materials and equipment stored on the work site shall be placed so as to cause as little obstruction to the public as possible and shall be lighted and barricaded as hereinafter provided. Keep driveways and entrances serving the premises clear and available to the Owner and the Owner's employees at all times. Do not use these areas for parking or storage of materials and equipment on site.

e. Unless otherwise expressly stipulated herein, the use of explosives is not contemplated in the prosecution of the Contract, and in no case will their use be permitted within a municipality without the written permission of the City Engineer and a permit issued by the Chief of the Fire Department. Where such permission for the use of explosives is obtained, the Contractor shall use the utmost care so as not to endanger life or property, and whenever directed the size and number of charges shall be reduced. All explosives shall be stored in a secure manner, and all such storage places shall be marked clearly, "DANGEROUS EXPLOSIVES", and shall be in care of competent watchmen.

ARTICLE 42 "SAFETY"

Add the following paragraphs:

OWNERS RIGHT TO STOP WORK

If the Contractor or SUBCONTRACTOR fails to provide adequate safety provisions as required by the contract documents the Owner has the right to stop all construction work at the location with inadequate safety provisions until adequate provisions are in place. The Owner shall not be liable for any delays caused by the Contractor's failure to provide and maintain required safety provisions.

CLEANUP PROCEDURES FOR HURRICANE WARNINGS AND HURRICANE WATCH

In the event the National Oceanographic and Atmospheric Administration(NOAA) issues a Tropical Storm Watch or a Hurricane Watch for the Keys the Engineer will Contact the Contractor informing him that the Watch has been established. Within 4 hours of the notice the Contractor shall provide the Engineer with a written plan and schedule describing how and when the Contractor will remove all unnecessary items from the work area and tie down all necessary supplies and barricades in the event a Tropical Storm Warning or a Hurricane Warning is issued. The Contractor shall remove all unnecessary items from work areas and shall tie down all movable objects (under 200 lbs.) The Engineer will determine "necessary" items. The Owner shall not be liable for any financial hardship or delays caused as a result of demobilization or remobilization of work due to the above.

Add the following subarticle:

A. OCCUPATIONAL SAFETY AND HEALTH

The Contractor shall observe and comply with all applicable local, state, and federal occupational safety and health regulations during the prosecution of work under this Contract. In addition, full compliance by the Contractor with the U.S. Department of Labor's Occupational Safety and Health Standards, as established in Public Law 91-596, will be required under the terms of this Contract.

ARTICLE 43 "PROTECTION OF WORK AND PROPERTY"

Add the following Article:

43 A. HISTORIC PRESERVATION

The Contractor shall comply with Florida's Archives and Historic Act (Florida Statutes, Chapter 267) and the regulations of the local historic preservation board as applicable and protect against the potential loss or destruction of significant historical or archaeological data, sites, and properties in connection with the project.

ARTICLE 53 "SCHEDULES & PROGRESS REPORTS"

Add the following paragraph:

Unless specifically authorized by the Engineer work shall not be performed within 3 days prior to the Goombay Festival, Fantasy Fest, Thanksgiving, Christmas or the period from Christmas to New Year's Day.

ARTICLE 55 "OWNERS RIGHT TO RETAIN IMPERFECT WORK"

Add the following Article:

55 A. OWNERS RIGHT TO STOP WORK

If the Contractor or any SUBCONTRACTOR should fail to provide adequate safety provisions required by the contract documents, including but not limited to maintenance of traffic, trench safety devices and procedures, safety fencing, barricading, signage or unsafe work practices, the Owner has the right to issue a Stop Work Notice and stop all construction work at the location with the inadequate safety provisions until such time that adequate safety provisions are in place. The Owner shall not be liable for delays caused by the Contractor's failure to provide and maintain required safety provisions. No extension of time will be granted to the Contractor for delays occurring due to a Stop Work Notice.

ARTICLE 60 "LIQUIDATED DAMAGES"

Delete Article "LIQUIDATED DAMAGES" in its entirety and substitute the following: LIQUIDATED DAMAGES

Should the Contractor fail to complete the work, or any part thereof in the time agreed upon or within such extra time as may have been allowed for delays by extensions granted as provided in the Contract, the Contractor shall reimburse the Owner for the additional expense and damage for each calendar day, Sundays, and legal holidays included, that project remains uncompleted after the completion date. It is agreed that the amount of such additional expense and damage incurred by reason of failure to complete the work is the per diem rate, as stipulated in the Proposal. The said amount is hereby agreed upon as a reasonable estimate of the costs which may be accrued by the Owner after the

expiration of the time of completion. It is expressly understood and agreed that this amount is not to be considered in the nature of a penalty, but as liquidated damages which have accrued against the Contractor. The Owner shall have the right to deduct such damages from any amount due, or that may become due the Contractor, or the amount of such damages shall be due and collectible from the Contractor or Surety.

ARTICLE 68 "PAYMENT"

Sub article C. "COST REIMBURSEMENT WORK"

Delete the third & fourth paragraph in its entirety & substitute the following;

In addition to 1 through 5 above , an added fixed fee of 15 percent (%) for General overhead & profit shall be allowed for the CONTRACTOR (or approved SUBCONTRACTOR) actually executing the Cost Reimbursement work.

An additional fixed fee of 5 % will be allowed the CONTRACTOR for the administrative handling of portions of the work that are executed by an approved. SUBCONTRACTOR. No additional fixed fee will be allowed for the administrative handling of work executed by the SUBCONTRACTOR of a SUBCONTRACTOR

ARTICLE 69 "PARTIAL PAYMENTS"

Delete the first paragraph of Subarticle B "ESTIMATE" and substitute the following:

No more than once each month, the Contractor shall submit to the Engineer a detailed estimate of the amount earned during the preceding month for the separate portions of the work, and request payment. As used in this Article, the words "amount earned" means the value, on the date of the estimate for partial payment, of the work completed in accordance with the Contract Documents, and the value of approved materials delivered to the project site suitably stored and protected prior to incorporation into the work.

Add the following subparagraph to Subarticle B "ESTIMATE"

Payment will be made by the Owner to the Contractor within 45 days receipt of the written recommendation of payment from the Engineer.

Delete Subarticle E. "PAYMENT" in its entirety and substitute the following:

After deducting the retainage and the amount of all previous partial payments made to the Contractor from the amount earned, the amount due will be made payable to the Contractor. Retainage will be held until final completion of the project.

ARTICLE 72 "FINAL PAYMENT"

Delete Article 72 "FINAL PAYMENT" in its entirety and substitute the following:

FINAL PAYMENT

Upon completion of the work, the Contractor shall notify the Engineer, in writing, that he has completed it and shall request final payment for the project. The Contractor shall be responsible for keeping an accurate and detailed record of his actual construction. Upon completion of construction and before final acceptance and payment, the Contractor shall furnish the Engineer record drawings of his construction. Upon receipt of a request for final payment and the record drawings, the Engineer will inspect and, if acceptable, submit to the Owner his recommendation as to acceptance of the completed work and as to the final estimate of the amount due the Contractor. Upon approval of this final estimate by the Owner and compliance by the Contractor with provisions in Article 71 RELEASE OF LIENS OR CLAIMS, and other provisions as may be applicable, the Owner shall pay to the Contractor all monies due him under the provisions of these Contract Documents.

END OF SECTION

PART 4

GENERAL REQUIREMENTS

GENERAL REQUIREMENTS

PART 1 PROJECT DESCRIPTION

1.1 GENERAL

- A. A brief description of the work is stated in the Invitation to Bid. To determine the full scope of the project or, any particular part of the project, coordinate the applicable information in the several parts of these Contract Documents.
- B. The work under this Contract shall be performed by the CONTRACTOR as required by the OWNER. The CONTRACTOR will receive a Notice to Proceed for the work authorized in this contract. The CONTRACTOR shall complete all work within the number of calendar days stipulated in the Notice to Proceed unless an extension in the time of completion is granted by the ENGINEER, as stated in the Instructions to Bidders. Upon completion of the work and compliance with applicable provisions in the Contract Documents and acceptance by the OWNER the CONTRACTOR will receive final payment for all work done.
- C. The following additional information, though not all-inclusive, is given to assist CONTRACTORS in their evaluation of the work required to meet the project objectives.
- D. This project will provide the OWNER with the installation of approximately 1,000 square feet of light-weight sheet piling and 5,000 square feet of roadway reconstruction as shown on attached drawing. The area is located at the intersection of Donald Avenue and 16th Terrace in Key West. See location map on drawing.
- E. The work is likely to be influenced by the tides. The tides can have an effect on the timing and work schedule. No extra claims shall be made for the tides or for other natural causes.
- F. The CONTRACTOR shall become familiar with the site and water conditions and take such into consideration in planning and scheduling work. No extra claims shall be made for work required to achieve conditions beyond those obtainable under normal operation to accomplish the work.

1.2 PERMITS

- A. All conditions of local, state and federal permits must be adhered to and acceptance of the project by the City must be obtained before final payment will be made.
- B. The City of Key West Right-of-Way permit shall be obtained by the CONTRACTOR prior to commencing work. The permit fee will be waived.

1.3 AS-BUILT DRAWINGS

- A. As-builts must be performed, signed and sealed by a Florida Professional Land Surveyor.

1.4 ENGINEER

- A. Questions should be directed to Jim Bouquet, P.E., Director of Project Manager, at jbouquet@cityofkeywest-fl.gov.

1.5 SUPERVISION

- A. Provide an experienced, qualified, and competent Superintendent to oversee the work. Prior to starting construction, the proposed Superintendent's qualifications shall be submitted in writing to the City for approval. The approved superintendent shall be expected to remain for the duration of the Project, unless the City or Engineer deem him inadequate and requests his removal or the contractor cannot continue his services to the Project for a reason or reasons that shall be communicated to the City. A replacement Superintendent shall be required to follow the same approval process as required for the original.

PART 2 SEQUENCE OF OPERATIONS

2.1 MOBILIZATION AND DEMOBILIZATION

- A. CONTRACTOR shall be responsible for mobilization and demobilization of labor, materials and equipment. Payment for mobilization and demobilization will be based on the unit price indicated in the Proposal for mobilization and demobilization.

2.2 SCHEDULING

- A. Plan the work and carry it out with minimum interference to the operation of the existing facilities. Prior to starting the works confer with the ENGINEER and OWNER's representative to develop an approved work schedule that will permit the facilities to function normally as practical. It may be necessary to do certain parts of the construction work outside normal working hours in order to avoid undesirable conditions. The CONTRACTOR shall do this work at such times and at no additional cost to the OWNER.
- B. In order to meet the overall objectives of the project certain elements of work may have to be completed or substantially completed in a given sequence that will be outlined by the ENGINEER.
- C. No work shall be started until the CONTRACTOR has sufficient manpower, equipment, and material to complete the project. No work shall commence without express consent of the ENGINEER.
- D. It shall be the Contractor's responsibility to request approval for entrance to the site for work on Saturdays, Sundays, holiday, and weekday hours other than 8:00 am until 7:00 pm.

2.3 COORDINATION

- A. The CONTRACTOR shall cooperate in the coordination of their activities in a manner that will provide the least interference with the OWNER's operations and other CONTRACTORS working in the area and in the interfacing and connection of the separate elements of the overall project work.
- B. If any difficulty or dispute should arise in the accomplishment of the above, the problem shall be brought immediately to the attention of the ENGINEER.

PART 3 SITE CONDITIONS

3.1 SITE INVESTIGATION AND REPRESENTATION

- A. The CONTRACTOR acknowledges satisfaction as to the general nature and location of the work, the general and local conditions, particularly those bearing upon availability of transportation, availability of labor, water, electric power, roads, and uncertainties of weather, tides, or similar physical conditions, the character of equipment and facilities needed preliminary to and during the prosecution of the work, and all other matters which can in any way affect the work or the cost thereof under this contract.
- B. Failure by the CONTRACTOR to become acquainted with the physical conditions and all the available information will not relieve the CONTRACTOR from responsibility for properly estimating the difficulty or cost of successfully performing the work.
- C. The CONTRACTOR warrants that as a result of examination and investigation of all the aforesaid data, the CONTRACTOR can perform the work in a good and workmanlike manner and to the satisfaction of the OWNER. The OWNER assumes no responsibility for any representations made by any of its officers or agents during or prior to the execution of this Contract, unless (1) such representations are expressly stated in the Contract, and (2) the Contract expressly provides that the responsibility therefore is assumed by the OWNER.

3.2 INFORMATION ON SITE CONDITIONS

- A. General: Any information obtained by the ENGINEER regarding site conditions, subsurface information, groundwater elevations, existing construction of site facilities as applicable and similar data will be available for inspection at the office of the ENGINEER upon request. Such information is offered as supplementary information only. Neither the ENGINEER nor the OWNER assumes any responsibility for the completeness or interpretation of such supplementary information.

3.3 SUBSURFACE INVESTIGATION

- A. Refer to Donald Avenue Roadway Stress Evaluation by PSI dated April 6, 2014 in Part 5.

- B. The CONTRACTOR shall examine the site and may make arrangements with the OWNER to conduct his own subsurface investigation.

3.4 UTILITIES

- A. The CONTRACTOR shall be responsible for determining, at his cost, the locations and elevations of all utilities in each project areas and shall be responsible for contacting each utility for location and notification prior to commencing work.

3.5 CONTRACTOR'S RESPONSIBILITY FOR UTILITY PROPERTIES AND SERVICE

- A. Where the CONTRACTOR's operations could cause damage or inconvenience to power, water, or sewer systems, the operations shall be suspended until all arrangements necessary for the protection of these utilities and services have been made by the CONTRACTOR.
- B. Notify all utility offices, which are affected by the construction operation at least 48 hours in advance. Under no circumstances expose any utility without first obtaining permission from the appropriate agency. Once permission has been granted, locate, expose, and provide temporary support for all existing underground utilities. Hand digging is required in the tolerance zone. If the CONTRACTOR fails to adhere to State Statutes and the Florida Administrative Code the appropriate law enforcement agencies will be contacted
- C. The CONTRACTOR shall be solely and directly responsible to the OWNER and operators of such properties for any damage, injury, expense, loss inconvenience, delay, suits, actions, or claims of any character brought because of any injuries or damage that may result from the construction operations under this Contract.
- D. Neither the OWNER nor its officers or agents shall be responsible to the CONTRACTOR for damages as a result of the CONTRACTOR's failure to protect utilities encountered in the work.
- E. In the event of interruption to domestic water, sewer, storm drain, or other utility services as a result of accidental breakage due to construction operations, promptly notify the proper authority. Cooperate with said authority in restoration of service as promptly as possible and bear all costs of repair. In no case shall interruption of any water or utility service be allowed to exist outside working hours unless prior approval is granted.
- F. In the event the CONTRACTOR encounters water service lines that interfere with the work he may, by obtaining prior approval of the property OWNER, Florida Keys Aqueduct Authority or Fire Department, as applicable, and the ENGINEER cut the service, dig through, and restore the service with similar and equal materials at the CONTRACTOR's expense.
- G. The CONTRACTOR shall replace, at his own expense, all existing utilities or structures removed or damaged during construction unless otherwise provided for in these Contract documents or ordered by the ENGINEER.

3.6 INTERFERING STRUCTURES

- A. Take necessary precautions to prevent damage to existing structures whether on the surface, aboveground, or underground.
- B. Protect underground and above ground existing structures from damage, whether or not they lie within the limits of the easements obtained by the OWNER. Where such existing fences, gates, sheds, buildings, or any other structure must be removed in order to properly carry out the construction, or are damaged during construction, restore to their original condition to the satisfaction of the property OWNER involved at the CONTRACTOR's own expense. Notify the ENGINEER of any damaged underground structure and make repairs or replacements before backfilling.
- C. Without additional compensation the CONTRACTOR may remove and replace in a condition as good as or better than original such small miscellaneous structures as fences and signposts that interfere with the CONTRACTOR's operations.
- D. The light and power poles are to be protected against damage by the Contractor. Where the CONTRACTORs operations could cause damage to existing lights poles; it shall be the CONTRACTORS responsibility to remove the pole and have the pole reinstalled by KEYS ENERGY. All costs associated with the removal and reinstallation of the poles and appurtanecs shall be paid by the Contractor.

3.7 FIELD RELOCATION

- A. During the progress of construction it is expected that minor relocations of the work will be necessary. Such relocations shall be made only by direction of the ENGINEER. If existing structures are encountered which prevent the construction and which are not properly shown on any Drawings that may be issued, notify the ENGINEER before continuing with the construction that may be issued in order that the ENGINEER may make such field revisions as necessary to avoid conflict with the existing structures. If the CONTRACTOR shall fail to so notify the ENGINEER when an existing structure is encountered and shall proceed with the construction despite this interference he shall do so at his own risk.

3.8 LAND MONUMENTS:

- A. The CONTRACTOR shall notify the ENGINEER prior to disturbing any existing federal, state, county, city, and private land monuments. CONTRACTOR shall hire a licensed land surveyor to research and reference all private and government land monuments prior to construction. Private and government land monuments shall be preserved or replaced by a licensed surveyor at the CONTRACTOR's expense. When government monuments are encountered the CONTRACTOR shall notify the ENGINEER at least 2 weeks in advance of the proposed construction in order that the ENGINEER will have ample opportunity to notify the proper authority to reference these monuments for later replacement.

PART 4 TEMPORARY CONSTRUCTION UTILITIES AND FACILITIES

4.1 TEMPORARY WATER

- A. The CONTRACTOR shall make his own arrangements to obtain suitable water and shall pay all costs.

4.2 TEMPORARY ELECTRIC POWER

- A. The CONTRACTOR shall make arrangements to obtain and pay for electrical power used until final acceptance by the OWNER.

4.3 SAFETY REQUIREMENTS FOR TEMPORARY ELECTRIC POWER

- A. Temporary electric power installation shall meet the construction safety requirements of OSHA, state and other governing agencies.

4.4 SANITARY FACILITIES

- A. The CONTRACTOR shall provide and maintain sanitary facilities for his employees and his SUB-CONTRACTORS' employees that will comply with the regulations of the local and state departments of health and as directed by the ENGINEER.

4.5 STORAGE OF MATERIALS

- A. Materials shall be so stored as to ensure the preservation of their quality and fitness for the work. When considered necessary they shall be placed on wooden platforms or other hard, clean surfaces and not on the ground. Stored materials shall be located so as to facilitate prompt inspection. Private property shall not be used for storage purposes without the written permission of the OWNER or lessee.
- B. Delicate instruments and materials subject to vandalism shall be placed under locked cover and, if necessary, provided with temperature control as recommended by the manufacturer.

PART 5 SAFETY AND CONVENIENCE

5.1 SAFETY EQUIPMENT

- A. The CONTRACTOR shall do all work necessary to protect the general public from hazards, including but not limited to, surface irregularities or unramped grade changes in pedestrian sidewalk or walkway. Barricades, lanterns, and proper signs shall be furnished in sufficient amount to safeguard the public and the work. All barricades and signs shall be, in the opinion of the ENGINEER, clean and serviceable.
- B. During construction the CONTRACTOR shall construct and at all times maintain satisfactory and substantial temporary chain link fencing, solid fencing, railing, barricades or steel plates, as applicable, at all openings, obstructions, or other hazards in sidewalks and walkways. All such barriers shall have adequate warning lights as necessary, or required, for safety. All lights shall be regularly maintained and in a fully operational state at all times as determined by OWNER.

5.2 ACCIDENT REPORTS

- A. In addition, the CONTRACTOR must promptly report in writing to the ENGINEER all accidents whatsoever arising out of or in connection with the performance of the work whether on or adjacent to the site, giving full details and statements of witness. If death or serious injuries or serious damages are caused, the accident shall be reported immediately by telephone or messenger to the ENGINEER.
- B. If a claim is made by anyone against the CONTRACTOR or any SUB-CONTRACTOR on account of any accident the CONTRACTOR shall promptly report the facts in writing to the ENGINEER, giving full details of the claim.

5.3 SAFE ACCESS BY FEDERAL, STATE, AND LOCAL GOVERNMENT OFFICIALS

- A. Authorized representatives of the state, federal, or local governmental agencies shall at all times have safe access to the work and the CONTRACTOR shall provide proper facilities for such access and inspection. (i.e. hard hats, safety glasses, hearing protection)

5.4 TRAFFIC MAINTENANCE AND SAFETY

- A. Provide a traffic maintenance plan to accompany the City of Key West Right-of-Way permit application to be prepared and obtained by the CONTRACTOR.
- B. Access to Buttonwood Court must be maintained at all times. Clean up operations shall follow immediately behind the worksite and shall be kept in an orderly and clean condition at all times.
- C. Comply with all rules and regulations of the state, county, and city authorities regarding closing or restricting the use of public streets or highways. No public or private road shall be closed, except by express permission of the OWNER. Conduct the work so as to assure the least possible obstruction to traffic and normal commercial pursuits. Protect all obstructions within traveled roadways by installing approved signs, barricades, and lights where necessary for the safety of the public. The convenience of the general public and residents adjacent to the project and the protection of person and property are of prime importance and shall be provided for in an adequate and satisfactory manner.
- D. When flaggers and guards are required by regulation or when deemed necessary for safety, they shall be furnished with approved orange wearing apparel and other regulation traffic-control devices in accordance with FDOT provisions. To be determined by Engineer.

5.5 TRAFFIC CONTROL

- A. Traffic control on all city, county and state highway rights-of-way shall meet the requirements of the Florida Department of Transportation Standard Specifications for Road and Bridge Construction, as well as FDOT Standard Details for Maintenance of

Traffic, in accordance with The Manual for Uniform Traffic Control and Safe Practices.

- B. The CONTRACTOR shall provide an 11 x 17 engineered drawing of his intended maintenance of traffic scheme to the ENGINEER for approval prior to commencement of work. This shall include barrier details, barricade type, and location.

5.6 PROTECTION OF PROPERTY

- A. Notify property OWNERS affected by the construction at least 48 hours in advance of the time construction begins. During construction operations construct and maintain such facilities as may be required to prevent access to the pier; specifically construct a chain link fence with a gate at the entrance of the pier. No person shall be allowed on the pier for the duration of the project .
- B. The CONTRACTOR shall identify and isolate his work zone in such a manner as to exclude all personnel not employed by him, the ENGINEER, and the OWNER.

5.7 FIRE PREVENTION AND PROTECTION

- A. The CONTRACTOR shall perform all work in a fire-safe manner. He shall supply and maintain on the site adequate fire-fighting equipment capable of extinguishing incipient fires. The CONTRACTOR shall comply with applicable federal, state, and local fire-prevention regulations. Where these regulations do not apply, applicable parts of the National Fire Prevention Standard for Safeguarding Building Construction Operations (NFPA No. 241) shall be followed.

5.8 ACCESS FOR POLICE and FIRE

- A. Notify the City ENGINEER and City liaison a minimum of 48 hours before closing any street, sidewalk or bike path or portion thereof. No closing shall be made without the OWNER's approval. Notify said departments when the streets are again passable for emergency vehicles. Do not block off emergency vehicle access to consecutive arterial crossings or dead-end streets in excess of 300 linear feet without special written permission from City ENGINEER. Conduct operations with the least interference to fire equipment access, and at no time prevent such access.
- B. The CONTRACTOR shall leave a night emergency telephone number or numbers with the police department, the ENGINEER and the OWNER, so that contact may be made easily at all times in case of barricade and flare trouble or other emergencies.

PART 6 PRESERVATION, RESTORATION, AND CLEANUP

6.1 SITE RESTORATION AND CLEANUP

- A. At all times during the work keep the premises clean and orderly. Upon completion of the day's work repair all damage caused by equipment and leave the project clean and free of rubbish or excess materials of any kind.

- B. Stockpile excavated materials in a manner that will cause the least damage to adjacent lawns, grassed areas, gardens, shrubbery, or fences, regardless of whether these are on private property or on state, county, or city rights-of-way. Remove all excavated materials from grassed and planted areas and leave these surfaces in a condition equivalent to their original condition.
- C. Upon completion of work, hand-rake all planted areas, leaving all disturbed areas free from rocks, gravel, clay, or any other foreign material. The finished surface shall conform to the original surface, and shall be free draining and free from holes, ruts, rough spots, or other surface features detrimental to the area.

6.2 FINISHING OF SITE, BORROW, AND STORAGE AREAS

- A. Upon completion of the project all areas used by the CONTRACTOR shall be properly cleared of all temporary structures, rubbish, and waste materials and properly graded to drain and blend in with the abutting property. Areas used for the deposit of waste materials shall be finished to properly drain and blend with the surrounding terrain.

6.3 STREET CLEANUP DURING CONSTRUCTION

- A. Thoroughly clean all spilled dirt, gravel, or other foreign material caused by the construction operations from all streets, roads and bike paths at the conclusion of each day's operation. Sidewalks and bike paths, unless under construction, shall be kept clear of material and available for pedestrian use at all times.

6.4 DUST PREVENTION

- A. Give all unpaved or disturbed areas used in the construction an approved dust-preventive treatment or periodically water to prevent dust. A water truck will be maintained on site by the CONTRACTOR as necessary or as directed by the OWNER. Applicable environmental regulations for dust prevention shall be strictly enforced.

PART 7 SUBMITTALS DURING CONSTRUCTION

7.1 GENERAL

- A. Requirements in this section are in addition to any specific requirements for submittals specified in other sections of these Contract Documents. The CONTRACTOR is required to provide a submittal log at the pre-construction conference.
- B. Submittals to the ENGINEER shall be addressed to:
 - 1. Attn: Jim Bouquet, P.E., Director of Engineering
3140 Flagler Avenue
Key West, Florida 33040

- C. Submitted data shall be fully sufficient in detail for determination of compliance with the Contract Documents.
- D. Review, acceptance, or approval of substitutions, or equal, schedules, shop drawings, lists of materials, and procedures submitted or requested by the CONTRACTOR shall not add to the Contract amount and all additional costs which may result there from shall be solely the obligation of the CONTRACTOR.
- E. It shall not be the responsibility of the OWNER to provide Engineering or other services to protect the CONTRACTOR from additional costs accruing from such approvals.
- F. No equipment or material for which listings, drawings, or descriptive material is required shall be installed until the ENGINEER has on hand copies of such approved lists and the appropriately stamped final shop drawings.
- G. The review of drawings by the ENGINEER will be limited to general design requirements only and shall in no way relieve the CONTRACTOR from responsibility for errors or omissions contained therein.
- H. Submittals will be acted upon by the ENGINEER as promptly as possible and returned to the CONTRACTOR not later than 10 working days.
- I. A sample of requirements for submittals include, but may not be limited to:
 - 1. Sheeting piling.
 - 2. Source and specification of asphalt
 - 3. Requirements for storage and protection prior to installation.
 - 4. Filter Fabric
 - 5. Maintenance of Traffic
 - 6. Subbase and base course material (source, gradation, proctor)
 - 7. Schedule of Values
 - 8. Bonds, Certificate of Insurance, Right-of-Way permit, etc.
 - 7. Schedule of work including the methodology, construction sequence, hurricane plan and location of approved staging area.
- J. The submittals shall include satisfactory identification of items, units and assemblies in relation to the specification section number and the system or equipment identification or tag number shown on the drawings or as provided in the applicable specification section.
- K. Should the CONTRACTOR propose any item on his shop drawings or incorporate an item into the work and that item should subsequently prove to be defective or otherwise unsatisfactory, (regardless of the ENGINEER's preliminary review), the CONTRACTOR shall, at his own expense replace the item with another item that will perform satisfactorily.

7.1.5 SUBMITTALS

Submittals shall be provided within 15 days of Notice to Proceed.

7.2 RECORD DRAWINGS

A. The CONTRACTOR shall submit AutoCAD as-built drawings certified by a Licensed Surveyor; on a jump drive and two (2) on paper. These 11 x 17 hardcopies Drawings must be submitted before final completion and payment for work can be certified.

B. As-Built Drawing Standards

All supplied data collections, as-builts, drawings and files to be compatible with esri ArcGIS 10.2.2 Software. The current computing environment consists of:

Microsoft SQL Server - Windows 7/Server 2008 - ESRI GIS Platform

Interfaces and Integrations:

The proposed mobile asset data collection solution will need to interface or integrate with these existing platforms. - Arc Collector-ArcGIS Online - ArcMap 10.2

Contact the City of Key West GIS Department (305-809-3721) with questions or concerns on whether your files meet this request.

PART 8 PAYMENT

GENERAL

A. Payment for the work in this section will be included as part of the applicable lump sum prices stated in the Proposal.

END OF SECTION

ENVIRONMENTAL PROTECTION

PART 1 – GENERAL

1.01 RELATED DOCUMENTS:

- A. Drawings and general provisions of Contract, including General and Supplementary Conditions and other Division-1 Specification Sections, apply to this Section.

1.02 DESCRIPTION OF WORK:

- A. Contractor shall be responsible for conducting all work in such a manner that any and all environmental impacts or damages not specifically authorized by the contract and its controlling State and Federal permits are avoided. Should accidental or incidental damages occur, CONTRACTOR shall be responsible for all corrective measures at CONTRACTOR'S expense. CONTRACTOR shall save and hold harmless the CITY from all such violations. CONTRACTOR shall adhere to the following sections at a minimum in order to avoid such environmental damages. CONTRACTOR shall be responsible for all actions and compliance of any SUBCONTRACTORS to CONTRACTOR.

- B. PERMITS

CONTRACTOR shall comply with all conditions of the state and federal permits.

- C. ENVIRONMENTAL DAMAGE

CONTRACTOR shall immediately notify Engineer and City of any environmental damages or violations, which may occur during project mobilization/demobilization and construction. Work must cease until Project Manager comes to site to assess damage.

1.03 LOCAL SITE CONDITIONS:

- A. CONTRACTOR shall secure the work area limits from public access. CONTRACTOR shall cordon off resources within the work area that are to be protected. CONTRACTOR shall be responsible for the replacement or repair of any damaged resources.
- B. At no time shall the CONTRACTOR be permitted to excavate, place fill on, traverse in any way, or place or store any equipment or material on wetlands outside the area designated for construction.
- C. CONTRACTOR shall avoid, contain, and control all other potential damages to the local resources including but not limited to fuel, oil, or other chemical or solid waste in the form of leaks, spills, or fugitive materials and trash. In the event of an impact of this type, CONTRACTOR shall take corrective actions immediately.

D. CONTRACTOR shall supply sanitary facilities at the worksite.

1.04 ENVIRONMENTAL PROTECTION PLAN:

A. Within 10 calendar days after the date of Notice of Award and prior to the Notice to Proceed to the CONTRACTOR, the CONTRACTOR shall submit in writing an Environmental Protection Plan to the ENGINEER. The Notice to Proceed will not be issued until the Environmental Protection Plan is reviewed and approved by the ENGINEER. Approval of the CONTRACTOR'S plan will not relieve the CONTRACTOR of his responsibility for adequate and continuing control of pollutants and other environmental protection measures. The Environmental Protection Plan shall include but not be limited to the following:

- (1) Methods for protection of features and habitats to be preserved within authorized work areas. The CONTRACTOR shall prepare a listing of methods to protect resources needing protection in and around work area, i.e., all landscape features, air and water quality, fish and wildlife, soil, historical, archeological and cultural resources.
- (2) Procedures to be implemented to provide the required environmental protection and to comply with the applicable permits, laws and regulations. The CONTRACTOR shall provide written assurance that immediate corrective action will be taken to correct pollution of the environment due to accident, natural causes or failure to follow the procedures set out in accordance with the Environmental Protection Plan.
- (3) Drawings showing locations of any proposed temporary material storage areas, structures, sanitary facilities, and stockpiles of excess or spoil materials.
- (4) A statement as to the person who shall be responsible for implementation of the Environmental Protection Plan. The CONTRACTOR personnel responsible shall report directly to the CONTRACTOR'S top management and shall have the authority to act for the Contractor in all environmental protection matters.
- (5) A statement acknowledging that the CONTRACTOR shall be responsible for environmental protection, including all of the CONTRACTOR'S personnel and SUBCONTRACTORS.
- (6) The Environmental Protection Plan shall be dated and endorsed by the individual of top management in charge of the construction.

1.05 PRECONSTRUCTION CONFERENCE:

A. At the pre-construction conference the Contractor shall present his proposed plans and schedules for construction of the project in accordance with the requirements of this section. The schedule shall be based on any analysis of project conditions and shall be in written form. The plan and schedule shall specifically indicate the

sequence of site prep, rock delivery and storage, construction of environmental protection control features, placement of the rock, the cleanup, and proposed project problem resolution remedies to achieve final acceptance of the project by the City. It shall also include proposed methods to prevent pollution of waters as the result of construction operations. The Contractor shall also outline his proposed methods of controlling and preventing pollution on haul roads, and areas used for disposal of waste materials from the project.

No work shall be started until the aforementioned plans and schedules have been accepted by the City. The Contractor will be responsible for accomplishment of the work in accordance with the accepted plans and schedules. The City may approve changes made necessary by unforeseen circumstances, which are beyond the control of the Contractor.

1.06 SUPERSEDING REQUIREMENTS:

In the event of differences between these requirements and pollution control laws, rules or regulations of other State, Federal, or local agencies, the more restrictive laws, rules, or regulations shall apply.

PART 2 – PRODUCTS (Not Used)

PART 3 – EXECUTION

3.01 TURBIDITY:

- A. The CONTRACTOR shall control and confine turbidity to the immediate work area. This shall consist of installing, maintaining, and removing turbidity barriers necessary to contain turbidity that may occur as a result of sheet pile and rip rap installation and must adhere to all permit conditions and as shown on Drawings. This may entail the deployment of turbidity barriers around isolated areas of concern. Such areas will be identified by the City and barriers will be put in place prior to the commencement of any work that could impact the area of concern. The type barrier used, the deployment and maintenance of the barrier will be such as to minimize dispersion of turbid waters from the construction site. Alternate methods or materials may be approved by the Engineer provided that compliance with applicable permit conditions and State water quality standards are maintained.

3.02 EXTENT OF FUGITIVE MATERIALS:

- A. General. CONTRACTOR shall control all fugitive materials including trash, chemicals, lubricants, oils, gas, debris, and delivered material as noted above. Fugitive materials as applied herein shall include all materials at the pier site, the water or along the transit route. In the event of a fugitive materials event CONTRACTOR shall take immediate corrective actions.

- B. The Contractor shall take sufficient precautions to prevent pollution of waters and wetlands, with fuels, oils, bitumens, calcium, chloride, or other harmful materials (in accordance with local, State and Federal Requirements). Also, he shall conduct and schedule his operations so as to avoid or otherwise minimize pollution or siltation of such waters and wetlands, and to avoid damage or interference to marine plants and organisms.

3.03 TRANSIT:

- A. Materials shall be delivered to the site in sealed trucks. The CONTRACTOR is responsible for assuring that such trucks do not leak or spill materials onto the public rights of way of the CITY or upon other non-designated properties. CONTRACTOR is responsible for assuring that the size and weight of such loaded trucks do not exceed the load bearing capacity of all substrata along the transit route including curbs, inlet or manhole covers, roads, sidewalks and underground utilities. Any trucks deemed unacceptable by the City will not remain on the project.

3.05 MAINTENANCE:

- A. General. The Contractor shall, at his expense, provide routine maintenance of permanent and temporary water pollution and turbidity control features until the project is completed and accepted.

PART 4 PROTECTION OF AIR QUALITY

- A. The air pollution likely to occur due to construction operations shall be minimized by wetting down bare soils during windy periods, requiring the use of properly operating combustion emission control devices on construction vehicles and equipment used by CONTRACTORS, and by encouraging the shutdown of motorized equipment not actually in use.
- B. Trash burning will not be permitted on the construction site. All trash must be carried and disposed off-site daily. It shall not be disposed of in City trash receptacles.

PART 5 CONSTRUCTION NOISE CONTROL

5.1 GENERAL

- A. The CONTRACTOR shall conduct all his work, use appropriate construction methods and equipment, and furnish and install acoustical barriers, all as necessary so that no noise emanating from the process or any related tool or equipment will exceed legal noise levels, as set forth in the Code of Ordinances, City of Key West, Florida.

5.2 MITIGATION OF CONSTRUCTION NOISE IMPACT

- A. The CONTRACTOR shall submit to the ENGINEER his plans to mitigate the construction noise impacts and to comply with the noise criteria specified herein, including the method of construction, the equipment to be used, and acoustical treatments if necessary.
- B. The CONTRACTOR shall only use equipment in good condition with the approved noise and environmental controls (mufflers) or it will be rejected from the site.

PART 6 PAYMENT

6.1 GENERAL

- A. Payment for the work in this section is incidental to the contract.

END OF SECTION

FIELD ENGINEERING

PART 1 - GENERAL

1.1 DESCRIPTION:

A. Work Included:

1. Provide field-engineering services required for the Project, including but not limited to survey work required in execution of the Work.

B. Related Work:

1. General and Supplementary Conditions of the Contract.
2. General Requirements.
3. Drawing

1.2 QUALITY ASSURANCE:

- A. Qualifications of Surveyor or Engineer: Professional Engineer and/or Surveyor currently licensed in the State of Florida.

1.3 SUBMITTALS:

- A. Submit name and address of proposed Surveyor and/or Contractor's Engineer to the City.
- B. Upon request of the City's Engineer, submit documentation to verify accuracy of field engineering work.
- C. Submit certificates signed by the Surveyor or Engineer certifying that elevations and locations of the work of this Project are in conformance, or non-conformance, with the Contract Documents.

PART 2 – MATERIALS (not used)

PART 3 - EXECUTION

3.1 EXAMINATION AND PREPARATION OF SITE

- A. Before starting operations, Contractor shall examine site of work to acquaint himself with conditions to be encountered.
- B. Compare actual site with drawings and specifications.
- C. Report discrepancies affecting work or cost thereof to the City.

- D. Verify exact locations of sewers, water mains, gas mains, above or below ground electrical wires and conduits and structures which may interfere with work.
- E. No extra compensation will be allowed for any extra work made necessary due to conditions or obstacles encountered during progress of work, which could have been determined by examination of site or by contacting Owners of utilities, pipelines and conduits before starting operations.
- F. Comply with State law concerning Sunshine State One Call of Florida, State Statute Title 33, Chapter 556.

3.2 LINES AND GRADES

- A. Prior to staking out work, Contractor shall verify established base line, benchmarks, and control points provided.
- B. Contractor shall furnish and maintain lines and grades.
- C. Contractor shall take immediate steps to correct errors or inconsistencies in lines and grades of work to be in conformity with Contract Documents.
- D. Contractor shall be fully responsible for accuracy of lines and grades of work and control and checking and immediate correction of it.

3.3 RESTORATION

- A. Items to remain which are disturbed, damaged, or removed when performing required work or for convenience of Contractor or to expedite his operations shall be restored, repaired, reinstalled, or replaced with new work and refinished, as appropriate, so as to be left in as good condition as existed before work commenced and such restoration shall be considered incidental to the work.
- B. Any sidewalks or pavement replaced or installed shall meet ADA requirements.
- C. Existing items to be altered, extended, salvaged, or relocated and reused, if found to be defective in any way, shall be reported to the City before items are disturbed.
- D. Materials and workmanship used in restoring work shall conform in type and quality to original existing construction.

3.4 PAYMENT

- A. Payment for work specified in this section is considered incidental to the contract.

END OF SECTION

CONTRACT CLOSEOUT

PART 1 – GENERAL

1.1 REQUIREMENTS

- A. Contract completion includes substantial completion, final inspection after completion, final cleaning, contractor's closeout submittals, and final adjustment of accounts.

1.2 SUBSTANTIAL COMPLETION

- A. When Contractor considers work has reached substantial completion for the work, they shall submit to the ENGINEER the following:
 - 1. Written notice that the work is substantially complete in accordance with Contract Documents.
 - 2. A list of items yet to be completed or corrected and explanations thereof.
- B. Within a reasonable time upon receipt of such notice, the ENGINEER will make an inspection review, if necessary, to determine the status of completion.
- C. Should the ENGINEER determine that the work is not substantially complete:
 - 1. The ENGINEER will promptly notify the Contractor in writing, giving the reasons thereof.
 - 2. Contractor shall remedy the deficiencies in the work and send a second written notice of Substantial Completion to the ENGINEER.
 - 3. Upon receipt of the second notice, the ENGINEER will inspect the work.
- D. When the ENGINEER finds that the work is substantially complete, they will issue a Certificate of Substantial Completion with a tentative list of items to be completed or corrected before final inspection.

1.3 FINAL INSPECTION AFTER COMPLETION

- A. When Contractor considers the work complete with all minor deficiencies completed or corrected, he shall submit written certification that:
 - 1. Contract Document requirements have been met.
 - 2. Work has been inspected for compliance with Contract Documents.

3. Work has been completed in accordance with Contract Documents.
 4. All minor deficiencies have been corrected or completed and the Work is ready for final inspection.
 5. Project record documents are complete and submitted.
- B. Within a reasonable time upon receipt of such certification, the ENGINEER will make an inspection to verify the status of completion.
- C. Should the ENGINEER determine that the work is incomplete or defective:
1. The ENGINEER will promptly notify the Contractor in writing, listing the incomplete or defective work.
 2. Contractor shall remedy the deficiencies in the work and send a second written certification to the ENGINEER that the work is complete.
 3. Upon receipt of the second certification, the ENGINEER will review the Work.
- D. When the ENGINEER determines that the work is acceptable under the Contract Documents, the Contractor shall provide all closeout submittals.

1.4 FINAL CLEANING

- A. Execute final cleaning prior to final inspection.
- B. Clean site; sweep paved areas, rake clean other surfaces.
- C. Remove waste and surplus materials, rubbish, and construction facilities from the Project and from the site.

1.5 CONTRACTOR'S CLOSEOUT SUBMITTALS

- A. Project Record Documents
 1. At Contract Closeout, submit documents with transmittal letter containing date, project title, Contractor's name and address, list of documents, and signature of Contractor.
 2. Changes made by Field Order or by Change Order.
- B. Evidence of payment and Release of Liens.

1.6 FINAL ADJUSTMENT OF ACCOUNTS

- A. Submit a final statement of accounting to the ENGINEER.
- B. Statement shall reflect all adjustments to the Contract Sum.
 - 1. The original Contract sum.
 - 2. Additions and deductions resulting from:
 - a. Previous change orders or written amendment.
 - b. Allowances
 - c. Unit prices
 - d. Deductions for uncorrected work.
 - e. Deductions for liquidated damages
 - f. Other adjustments
 - 3. Total contract sum as adjusted
 - 4. Previous payments
 - 5. Sum remaining due

1.7 FINAL AS-BUILT OR RECORD DRAWINGS

- A. All supplied data collections, as-builts, drawings and files to be compatible with esri ArcGIS 10.2.2 Software. The OWNER's current computing environment consists of *Microsoft SQL Server - Windows 7/Server 2008 - ESRI GIS Platform.*

PART 2 - PRODUCTS (not used)

PART 3 - EXECUTION (not used)

END OF SECTION

PART 5

**GEOTECHNICAL REPORT, SFWMD PERMIT &
DESIGN DRAWING C-1**

April 9, 2014

PEREZ ENGINEERING & DEVELOPMENT, INC.
1010 Kennedy Drive, Suite 201
Key West, Florida 33040

Attention: Mr. Allen E. Perez, P.E.
President

Re: Report of Geotechnical Engineering Services
Donald Avenue – Roadway Distress Evaluation
Key West, Florida
PSI Project No. 0397-676

Dear Mr. Perez:

Professional Service Industries, Inc. (PSI) has completed a geotechnical engineering study in connection with the noted project. Our services were provided in general accordance with PSI Proposal No. P0-397-110219, dated November 18, 2013. Authorization to proceed was provided by means of a signed agreement of our proposal by Mr. Perez dated, February 7, 2014. This report provides an overview of the work completed by us in connection with the study, along with our evaluation of the pavement distress and recommendations for remediation/restoration.

1.0 BACKGROUND

The subject site is located at the intersection of Donald Avenue and 16th Terrace in Key West, Florida. Based on our site visits, it is our understanding that the roadway has undergone significant distress in the form of pavement subsidence. A site vicinity map identifying the project location with respect to existing streets and features is presented on **Sheet 1** of the **Appendix**. Photographs from our site visit are presented in **Sheet 2** of the **Appendix**.

The purpose of our work was to evaluate the cause of distress and to provide possible recommendations for remedial activities. The distress appeared to be in the form of localized subsidence of the roadway. In addition, we observed numerous cracks in the asphalt pavement. We also noticed the presence of utilities in this area.

If any of the noted information is incorrect or has changed, please notify PSI so that we may amend the contents of this report, if appropriate.

2.0 FIELD EXPLORATION AND SUBSURFACE CONDITIONS

To evaluate the subsurface conditions at the distress area, we drilled/sampled two Standard Penetration Test (SPT) borings at the roadway intersection. SPT boring B-1 was performed within a relatively intact portion of the asphalt pavement to a depth of 15 feet below grade, while, SPT boring B-2 was advanced to a depth of 18 feet below grade within an area that showed significant pavement distress. The approximate locations at which the two borings were drilled are shown on **Sheet 3** of the **Appendix**.

At location B-1, the surficial asphalt cover was underlain by 4 feet of granular fill material (comprising limerock and fine sand), followed by a 4 foot thick soft compressible stratum of silty sand and organics that persisted to a depth of 8 feet below grade (the silty sand and/or organic soils will be hereafter referred to as “compressible stratum”). In contrast, at location B-2, the surficial asphalt cover was underlain by 6 feet of granular fill material, followed by a 10 foot thick compressible stratum that persisted to a depth of 16 feet below grade.

At both locations, the compressible stratum was underlain by a natural limestone formation that persisted to the termination depth of the explorations at 15 feet (B-1) and 18 feet (B-2) below grade.

The compressible stratum had moisture contents ranging from 36 to 360 percent with the percentage organic matter by dry weight of 33 and 42 percent. Additionally, the percentage of fines passing the number 200 sieve in the silty sand stratum was 49 percent.

The groundwater table was observed in the borings at depths of 1.0 and 1.7 feet below grade at the time of drilling. The difference in the water level is primarily a result in changes in the ground surface elevation between the boring locations.

It should be noted that groundwater levels fluctuate daily due to tidal changes and seasonally in response to rainfall and the infiltration rate of the soil. Therefore, at a time of the year different from the time of drilling, there is a possibility of a change in the recorded levels. We estimate that during the peak of the wet hydroperiod, with rainfall and recharge at a maximum, groundwater levels at the site could be at or even above the ground surface. Throughout the year, the groundwater table at the site will closely relate to the water levels in the adjoining lake.

We recommend that the contractor determine the actual groundwater levels at the time of construction to assess groundwater impact on his construction procedure.

Please refer to the individual boring logs presented in the **Appendix** for details on the subsurface conditions observed at the specific exploration locations.

3.0 EVALUATION AND RECOMMENDATIONS

3.1 PAVEMENT RECOMMENDATIONS

Based on the results of our field exploration, it appears that the portions of the asphalt pavement showing greater signs of distress also correspond to area with thicker/deeper compressible stratum.

The compressible stratum encountered at the site may continue to have adverse impacts to the serviceability of the paved surface areas, if left in place. If left in place, we estimate that the compressible stratum will continue to undergo settlement on the order of two inches (assumes that the pavement grades will be adjusted/raised less than six inches). Options to be considered for the pavement remediation/restoration of the site include:

- Option 1: Reconstruct the distressed asphalt pavement, leaving the compressible stratum in place after heavy surface proof-rolling and accept the risk of continued long-term settlement/creep as a maintenance issue.
- Option 2: Reconstruct the distressed asphalt pavement, leaving the compressible stratum in place and using a geosynthetic reinforcing material to reduce the effects of post construction long-term settlement/creep. In this option, settlement risk will also have to be accepted and dealt with, but on a less frequent maintenance basis.

Due to the depth of the compressible stratum, its excavation followed by the placement/compaction of structural fill was not considered as a viable option. Option 1 would be the least costly alternative up front, however, additional future costs should be anticipated as a result of accelerated maintenance during the design life of the facility. With Option 2, the geosynthetic reinforcement would incur up-front costs but will most likely reduce the economic impact associated with maintenance in connection with these aspects of the proposed development.

For Option 2, we recommend utilizing a geosynthetic material such as Tensar BX-1200 or its material equivalent. The geosynthetic should be placed at the bottom of the base course layer with a minimum overlap of two feet between adjacent rolls. Additionally, the geosynthetic should extend five feet beyond the horizontal limits of the major distress, where practical.

Based on our experience with similar projects and our understanding of the traffic loads, we suggest the pavement section noted in **Table A** below be considered for the remediation/restoration area.

Table A – Pavement Thickness Suggestion (Conventional Approach)

Material	Minimum Thickness (inches)
Asphaltic Concrete	2
Base (Minimum LBR = 100, 98% Compaction)	6
For Option 2, utilize a geogrid such Tensar BX-1200 or its material equivalent	

The base course materials in the pavements should consist of limerock having a minimum Limerock Bearing Ratio (LBR) of 100. Base materials should meet the requirements presented in the latest revisions of the Florida Department of Transportation "Specifications for Road and Bridge Construction", Section 911 (limestone). The base course should be compacted to at least 98 percent of the material's maximum dry density (ASTM D-1557).

It is possible that the depending on the period of work the ground water table could impact the pavement base construction. In which case, the use of a "black base" instead of a conventional base course is considered acceptable. However, a high temperature geogrid, such as Mirafi BXG-12 or its material equivalent will have to be utilized in conjunction with the black base, as the properties of conventional geogrid materials are altered at high temperatures such as during asphalt placement. The pavement thickness suggested for this alternative is tabulated in **Table B** below.

Table B – Pavement Thickness Suggestion (Black Base Approach)

Material	Minimum Thickness (inches)
Asphaltic Concrete	2
Black Base	6
For Option 2, utilize a geogrid on which asphalt can be directly applied such as a Mirafi BXG-12 or its material equivalent	

Actual pavement section thickness should be verified by the design civil engineer based on traffic loads, volume and the owners design life requirements.

Site preparation recommendations for the various pavement options are presented in **Section 4.0** of the report.

3.2 PIPE BEDDING

We recommend that the bottom of any new utility trench excavations be over-excavated a minimum depth of 6 inches. Depending on the nature/condition of the materials at the pipe invert, it may be necessary to locally increase the thickness of the overexcavation. Granular pipe bedding should then be placed in order to provide a positive contact with the contour of the utility pipe to promote uniform bearing for the full length of the pipe. The bedding material should consist of crushed stone (pea gravel) or No. 7 aggregate with not less than 95 percent passing the ½ inch and not less than 95 percent retained on a U.S. Standard No. 4 sieve. Alternatively, the use of FDOT 57 Stone is also considered acceptable. The pipe bedding material should be stabilized so it is firm and unyielding prior to placement of the pipes. The entire pipe/pipe bedding envelope should be wrapped with a filter fabric such as a Mirafi FW 404 or an approved equivalent.

4.0 SITE PREPARATION

Based on the results of our field exploration, we anticipate site preparation procedures to include the steps listed below. All work should be carried out in accordance with current regulatory criteria with the site preparation work and construction activities being carried out with care so as not to impact the adjacent existing construction.

1. The contractor should be cognizant that the groundwater levels at the site are relatively shallow and in addition influenced by tidal fluctuations. The contractor should take this into consideration in scheduling/carrying out their field work.
2. The work area should correspond to the portion of the pavement showing the most significant distress (as highlighted on Sheet 3), plus, five feet beyond, where practical. The purpose of extending beyond the distressed area is to create a “bridge” between the distressed and the relatively intact pavement areas, thereby reducing long-term differential settlement which would otherwise create an uneven surface.
3. The location of any existing underground utility lines within the construction area should be established. In addition, these utilities should be evaluated to establish their current condition and suitability for continued use. Abandoned or unserviceable utilities should be removed or grouted to reduce the possibility of subsurface erosion that could result in future settlement and pavement distress.
4. Site preparation for the proposed development should include removing the asphalt pavement. Following which, the roadway grades should be cut to a level corresponding to 8 inches below the finished pavement grades. All unwanted ground cover should be completely removed from the site and properly disposed of. This work should be carried out in accordance with current regulatory criteria.
5. The exposed subgrade should be proof-rolled. Due to the proximity of the water table, we recommend that the proof-rolling be performed using a backhoe with a fully loaded bucket. The use of heavier equipment operating under a vibratory mode may cause the groundwater table to pipe and soften/wet the working subgrade. Any area of the exposed surface that deflects excessively under the weight of the compaction equipment should be leveled with material similar to that utilized for the base course (noted in **Section 3.1**). Density testing will not be required on the surface being proof-rolled. However, it should be compacted to a stable and unyielding condition.
6. Upon completion of proof-rolling, the geogrid and base/black base material should be placed. The geogrid type should be carefully selected based on the use of conventional base material or black base.
7. Groundwater control may be required at this site for either excavation dewatering or removal of temporarily perched water from a rain event. Such water can be controlled by pumping from sumps located in ditches or pits. Groundwater should be maintained at least one foot below the bottom of any excavation made during construction operations, or, at least two feet below the surface of any compaction operations. The dewatering operations should be carried out with care especially if the compressible soils are present below adjacent facilities.

8. It is mandated by federal regulations that all excavations, whether they be utility trenches, basement excavations or footing excavations, be constructed in accordance with OSHA guidelines. It is our understanding that these regulations are being strictly enforced and if they are not closely followed, the owner and the contractor could be liable for substantial penalties.

5.0 REPORT LIMITATIONS

Our professional services have been performed, findings obtained, and recommendations prepared in accordance with generally accepted geotechnical engineering principles and practices at the time of this report. This company is not responsible for the conclusions, opinions or recommendations made by others based on this data. No other warranties are implied or expressed. After the plans and specifications are complete, it is recommended that PSI be provided the opportunity to review the final design and specifications, in order to verify that the earthwork and foundation recommendations are properly interpreted and implemented. At that time, it may be necessary to submit supplemental recommendations.

The scope of our services did not include an environmental assessment for the presence or absence of hazardous or toxic materials in the soil and groundwater. Any statements in this report regarding odors, staining of soils, or other unusual conditions observed are strictly for the information of our client.

This report has been prepared for the exclusive use of the Perez Engineering & Development, Inc. for the pavement rehabilitation of Donald Avenue at the intersection of 16th Terrace in Key West, Florida.

6.0 CLOSURE

We trust this letter is adequate for your current needs; however, should you have any questions or should additional information be required, please do not hesitate to contact our office at (305) 471-7725.

Respectfully submitted,

Professional Service Industries, Inc.

Certificate of Authorization No: 3684



Gustavo A. Silva
Project Manager



Ian Kinnear, P.E.
Chief Engineer
FL License No. 32614



Dhuruva (Dru) Badri, P.E.
Department Manager
FL License No. 68718

cc: Addressee (3 and PDF)
File (1 and PDF)

APPENDIX

Sheet 1: Site Vicinity Map
Sheet 2: Site Photographs
Sheet 3: Boring Location Plan
Boring Logs

APPENDIX

SITE VICINITY MAP



GEOTECHNICAL ENGINEERING SERVICES
Donald Avenue - Roadway Distress Evaluation
Key West, Florida

DATE: 3/24/2014

DRAWN: JAC

SHEET No.: 1

PSI PROJECT No.: 0397-676

CHKD.: DB

psi Information
To Build On
Engineering • Consulting • Testing

SITE PHOTOGRAPHS



GEOTECHNICAL ENGINEERING SERVICES
Donald Avenue - Roadway Distress Evaluation
Key West, Florida

DATE: 3/24/2014

DRAWN: JAC

SHEET No.: 2

PSI PROJECT No.: 0397-676

CHKD.: DB

psi Information
To Build On
Engineering • Consulting • Testing

BORING LOCATION PLAN



GEOTECHNICAL ENGINEERING SERVICES
Donald Avenue - Roadway Distress Evaluation
Key West, Florida

DATE: 3/24/2014

DRAWN: JAC

CHKD:: DB

psi Information
To Build On
Engineering • Consulting • Testing

SHEET No.: 3

PSI PROJECT No.: 0397-676



Professional Service Industries, Inc.
 7950 N.W. 64th Street
 Miami, FL 33166
 Telephone: (305) 471-7725
 Fax: (305) 593-1915

LOG OF BORING B-1

Sheet 1 of 1

PSI Job No.: 0397-676
 Project: Donald Ave-Roadway Distress Evaluation
 Location: Key West, Florida

Drilling Method: SPT
 Sampling Method: SS
 Hammer Type: Automatic
 Boring Location: Refer to Sheet 3

WATER LEVELS	
▽ While Drilling	1.7 feet
▽ Upon Completion	1.7 feet
▽ Delay	N/A

Elevation (feet)	Depth, (feet)	Graphic Log	Sample Type	Sample No.	Recovery (inches)	Station: N/A Offset: N/A	MATERIAL DESCRIPTION	USCS Classification	SPT Blows per 6-inch (SS)	STANDARD PENETRATION TEST DATA		Additional Remarks
										N in blows/ft	Moisture, %	
0	0	Asphalt										
	1	Light Brown/Gray LIMEROCK with Fine Sand		1				GP	21-12-8-6 N=20			
	2			2				GP	5-6-3-2 N=9			
	5	Light Brown/Gray Silty Fine SAND with Traces of Rock		3				SM	2-1-1-1 N=2			
		Natural Moisture Content = 36% Percent Passing No. 200 Sieve = 49%										
		Brown/Gray PEAT with Fine Sand		4					1- (W.O.H.) N=W.O.H.			
		Natural Moisture Content = 203% Organic Content = 33%										
		Light Brown/Gray LIMESTONE wit Fine Sand		5					18-(50/4") N=50/4"			
	10											
				6					38-(50/4") N=50/4"			
	15											

Completion Depth: 15.0 ft	Sample Types:	Shelby Tube	Latitude:
Date Boring Started: 3/13/14	Auger Cutting	Hand Auger	Longitude:
Date Boring Completed: 3/13/14	Split-Spoon	Calif. Sampler	Drill Rig: CME-55
Logged By: P.W.	Rock Core	Texas Cone	Remarks:
Drilling Contractor: PSI, Inc.			

The stratification lines represent approximate boundaries. The transition may be gradual.



Professional Service Industries, Inc.
 7950 N.W. 64th Street
 Miami, FL 33166
 Telephone: (305) 471-7725
 Fax: (305) 593-1915

LOG OF BORING B-2

Sheet 1 of 1

PSI Job No.: 0397-676
 Project: Donald Ave-Roadway Distress Evaluation
 Location: Key West, Florida

Drilling Method: SPT
 Sampling Method: SS
 Hammer Type: Automatic
 Boring Location: Refer to Sheet 3

WATER LEVELS	
▽ While Drilling	1.0 feet
▽ Upon Completion	1.0 feet
▽ Delay	N/A

Elevation (feet)	Depth, (feet)	Graphic Log	Sample Type	Sample No.	Recovery (inches)	Station: N/A Offset: N/A	MATERIAL DESCRIPTION	USCS Classification	SPT Blows per 6-inch (SS)	Moisture, %	STANDARD PENETRATION TEST DATA		Additional Remarks
											N in blows/ft	Moisture	
0							Asphalt						
				1			Light Brown/Gray LIMEROCK with Fine Sand		19-11-11-13 N=22				
				2				GP	15-8-5-5 N=13				
	5			3					5-6-3-3 N=9				
				4			Brown/Gray Silty PEAT Natural Moisture Content = 360% Organic Content = 42%		2-2-2-2 N=4				
				5					3-3-3-3 N=6				
	10			6					2-2-1-1 N=3				
				7					2-2-2-2 N=4				
				8					2-1-2-2 N=3				
	15			2			Light Brown/Gray LIMESTONE wit Fine Sand		3-4-4-5 N=8				

Completion Depth: 18.0 ft	Sample Types:	Shelby Tube	Latitude:
Date Boring Started: 3/13/14	Auger Cutting	Hand Auger	Longitude:
Date Boring Completed: 3/13/14	Split-Spoon	Calif. Sampler	Drill Rig: CME-55
Logged By: P.W.	Rock Core	Texas Cone	Remarks:
Drilling Contractor: PSI, Inc.			

The stratification lines represent approximate boundaries. The transition may be gradual.

James Bouquet

From: Phil Frank <terramar@bellsouth.net>
Sent: Thursday, March 05, 2015 2:42 PM
To: Carman, Heather
Subject: Re: Undeliverable: RE: City of Key West - Permit 44-00377-P & SFWMD 2007 096 CO ERP

Heather,

This is exactly what we are doing, and thanks for coordinating and clarifying!

Thank You.

Philip A. Frank, Ph.D.
Terramar Environmental Services, Inc.
1241 Crane Boulevard
Sugarloaf Key, Florida 33042
(305) 393-4200 terramar@bellsouth.net

On Mar 5, 2015, at 1:36 PM, Carman, Heather <hcarman@sfwmd.gov> wrote:

We discussed today and yes, as long as you are doing maintenance activities to stabilize the road (i.e. rip rap placement), culvert pipe sizes will remain the same, and you are doing mangrove trimming (not alteration/removal), then this work can be carried out without any type of a permit modification.

From: Phil Frank [<mailto:terramar@bellsouth.net>]
Sent: Tuesday, March 03, 2015 12:34 PM
To: Carman, Heather
Subject: RE: Undeliverable: RE: City of Key West - Permit 44-00377-P & SFWMD 2007 096 CO ERP

Ok, hopefully they will agree and we can do this little thing ASAP. They were at the October meeting where this was discussed, so it should be good.

We just got our task order signed by the City to do the big picture overview / permit mod, so that will be coming along. But in the meantime, the road is failing !!

Please keep me posted.
Thanks,
Philip A. Frank, Ph.D.
Terramar Environmental Services, Inc.
1241 Crane Boulevard
Sugarloaf Key, Florida 33042
(305) 393-4200 terramar@bellsouth.net

From: Carman, Heather [<mailto:hcarman@sfwmd.gov>]
Sent: Tuesday, March 03, 2015 11:53 AM



**SOUTH FLORIDA WATER MANAGEMENT DISTRICT
ENVIRONMENTAL RESOURCE PERMIT NO. 44-00378-P**

DATE ISSUED: JUNE 14, 2007

FORM 80145
Rev. 08/95

PERMITTEE: KEY WEST CITY OF
(FUTURE STORMWATER IMPROVEMENT PROJECT
525 ANGELA STREET, P O BOX 1409
KEY WEST, FL 33040

PROJECT DESCRIPTION: IMPROVEMENTS AND MAINTENANCE TO STORMWATER DRAINAGE FEATURES OVER 2.39 ACRES AT FIVE LOCATIONS KNOWN AS THE JOSE MARTI, POINCIANA/DONALD, PATTERSON SITE, WINN-DIXIE, AND LINDA SITES.

PROJECT LOCATION: MONROE COUNTY, SECTION 33,34 TWP 67S RGE 25E
SECTION 4,5 TWP 68S RGE 25E

PERMIT DURATION: See Special Condition No:1. See attached Rule 40E-4.321, Florida Administrative Code.

This Permit is issued pursuant to Application No. 070426-5, dated April 16, 2007. Permittee agrees to hold and save the South Florida Water Management District and its successors harmless from any and all damages, claims or liabilities which may arise by reason of the construction, operation, maintenance or use of activities authorized by this Permit. This Permit is issued under the provisions of Chapter 373, Part IV Florida Statutes (F.S.), and the Operating Agreement Concerning Regulation Under Part IV, Chapter 373 F.S., between South Florida Water Management District and the Department of Environmental Protection. Issuance of this Permit constitutes certification of compliance with state water quality standards where necessary pursuant to Section 401, Public Law 92-500, 33 USC Section 1341, unless this Permit is issued pursuant to the net improvement provisions of Subsections 373.414(1)(b), F.S., or as otherwise stated herein.

This Permit may be transferred pursuant to the appropriate provisions of Chapter 373, F.S. and Sections 40E-1.6107(1) and (2), and 40E-4.351(1), (2), and (4), Florida Administrative Code (F.A.C.). This Permit may be revoked, suspended, or modified at any time pursuant to the appropriate provisions of Chapter 373, F.S. and Sections 40E-4.351(1), (2), and (4), F.A.C.

This Permit shall be subject to the General Conditions set forth in Rule 40E-4.381, F.A.C., unless waived or modified by the Governing Board. The Application, and the Environmental Resource Permit Staff Review Summary of the Application, including all conditions, and all plans and specifications incorporated by reference, are a part of this Permit. All activities authorized by this Permit shall be implemented as set forth in the plans, specifications, and performance criteria as set forth and incorporated in the Environmental Resource Permit Staff Review Summary. Within 30 days after completion of construction of the permitted activity, the Permittee shall submit a written statement of completion and certification by a registered professional engineer or other appropriate individual, pursuant to the appropriate provisions of Chapter 373, F.S. and Sections 40E-4.361 and 40E-4.381, F.A.C.

In the event the property is sold or otherwise conveyed, the Permittee will remain liable for compliance with this Permit until transfer is approved by the District pursuant to Rule 40E-1.6107, F.A.C.

SPECIAL AND GENERAL CONDITIONS ARE AS FOLLOWS:

SEE PAGES 2 - 3 OF 6 (15 SPECIAL CONDITIONS).

SEE PAGES 4 - 6 OF 6 (19 GENERAL CONDITIONS).

SOUTH FLORIDA WATER MANAGEMENT
DISTRICT, BY ITS GOVERNING BOARD

On ORIGINAL SIGNED BY:

By ELIZABETH VEGUILLA
DEPUTY CLERK

SPECIAL CONDITIONS

1. The construction phase of this permit shall expire on June 14, 2012.
2. Operation of the surface water management system shall be the responsibility of the permittee.
3. The permittee shall be responsible for the correction of any erosion, shoaling or water quality problems that result from the construction or operation of the surface water management system.
4. Measures shall be taken during construction to insure that sedimentation and/or turbidity violations do not occur in the receiving water.
5. The District reserves the right to require that additional water quality treatment methods be incorporated into the drainage system if such measures are shown to be necessary.
6. Facilities other than those stated herein shall not be constructed without an approved modification of this permit.
7. A stable, permanent and accessible elevation reference shall be established on or within one hundred (100) feet of all permitted discharge structures no later than the submission of the certification report. The location of the elevation reference must be noted on or with the certification report.
8. The permittee shall provide routine maintenance of all of the components of the surface water management system in order to remove all trapped sediments/debris. All materials shall be properly disposed of as required by law. Failure to properly maintain the system may result in adverse flooding conditions.
9. This permit is issued based on the applicant's submitted information which reasonably demonstrates that adverse water resource related impacts will not be caused by the completed permit activity. Should any adverse impacts caused by the completed surface water management system occur, the District will require the permittee to provide appropriate mitigation to the District or other impacted party. The District will require the permittee to modify the surface water management system, if necessary, to eliminate the cause of the adverse impacts.
10. Pursuant to an Emergency Order of the Governing Board of the District, applications for water use permits for dewatering associated with the construction of the surface water management facilities proposed with this application will be considered on a case by case basis, and may or may not be issued prior to the Governing Board rescinding or modifying the Order. In addition, no irrigation with previously unallocated water may be conducted prior to the Governing Board rescinding or modifying the Order.
11. The permittee shall instruct all personnel associated with the project of the potential presence of manatees and the need to avoid collisions with manatees. All construction personnel are responsible for observing water-related activities for the presence of manatee(s).

The permittee shall advise all construction personnel that there are civil and criminal penalties for harming, harassing, or killing manatees which are protected under the Marine Mammal Protection Act of 1972, The Endangered Species Act of 1973, and the Florida Manatee Sanctuary Act.

Siltation barriers shall be made of material in which manatees cannot become entangled, are properly secured, and are regularly monitored to avoid manatee entrapment. Barriers must not block manatee entry to or exist from essential habitat.

All vessels associated with the construction project shall operate at "no wake/idle" speeds at all times while in the construction area and while in water where the draft of the vessel provides less than a four-foot clearance from the bottom. All vessels will follow routes of deep water whenever possible.

If manatee(s) are seen within 100 yards of the active daily construction/dredging operation or vessel movement, all appropriate precautions shall be implemented to ensure protection of the manatee. These precautions shall include the operation of all moving equipment no closer than 50 feet of a manatee. Operation of any equipment closer than 50 feet to a manatee shall necessitate immediate shutdown of that equipment. Activities will not resume until the manatee(s)

has departed the project area of its own volition.

Any collision with and/or injury to a manatee shall be reported immediately to the FWC Hotline at 1-888-404-FWCC. Collision and/or injury should also be reported to the U.S. Fish and Wildlife Service in Jacksonville (1-904-232-2580) for north Florida or Vero Beach (1-772-562-3909) in south Florida.

Temporary signs concerning manatees shall be posted prior to and during all construction/dredging activities. All signs are to be removed by the permittee upon completion of the project. A sign measuring at least 3 ft. by 4 ft. which reads Caution: Manatee Area will be posted in a location prominently visible to water related construction crews. A second sign should be posted if vessels are associated with the construction, and should be placed visible to the vessel operator. The second sign should be at least 8 1/2" by 11" which reads Caution: Manatee Habitat. Idle speed is required if operating a vessel in the construction area. All equipment must be shutdown if a manatee comes within 50 feet of operation. Collision and/or injury should also be reported to the U.S. Fish and Wildlife Service in Jacksonville (1-904-232-2580) for north Florida or Vero Beach (1-772-562-3909) in south Florida.

12. The following exhibits for the permit are incorporated by reference herein and are located in the permit file:

Exhibit No. 2.06 Consent Agreement Number SFWMD 2007 096 CO ERP

13. Silt fencing shall be installed at the limits of construction to protect all of the preserve areas from silt and sediment deposition during the construction of the project. A floating turbidity barrier shall be installed during the construction of the final discharge structure into the adjacent canal/water body. The silt fencing and the turbidity barrier shall be installed in accordance with "Florida Land Development Manual" Chapter 6 "Stormwater and Erosion and Sediment Control Best Management Practices for Developing Areas" and Exhibit Numbers 2.01 through 2.06. The sediment controls shall be installed prior to the commencement of any clearing or construction and the installation must be inspected by the District's Environmental Resource Compliance staff. The silt fencing and turbidity barriers shall remain in place and be maintained in good functional condition until all adjacent construction activities have been completed and all fill slopes have been stabilized. Upon completion of the project and the stabilization of the fill, the permittee shall contact the District's Environmental Resource Compliance staff to inspect the site and approve the removal of the silt fencing and turbidity barriers.
14. The permittee shall comply with applicable state water quality standards including:
- a)62-302.500 - Minimum criteria for all surface waters at all places and all times;
 - b)52-302.510 - Surface waters: general criteria
 - c)62-302.560 - Class III waters; recreation, propagation and maintenance of a healthy, well balanced population of fish and wildlife;
 - d)62-302.600 - Classified waters.
15. Weighted turbidity screens or other such turbidity control measures shall be utilized during construction. The selected turbidity control measures shall be weighted to extend to the bottom of the waterway and shall surround the construction/work areas.

GENERAL CONDITIONS

1. All activities authorized by this permit shall be implemented as set forth in the plans, specifications and performance criteria as approved by this permit. Any deviation from the permitted activity and the conditions for undertaking that activity shall constitute a violation of this permit and Part IV, Chapter 373. F.S.
2. This permit or a copy thereof, complete with all conditions, attachments, exhibits, and modifications shall be kept at the work site of the permitted activity. The complete permit shall be available for review at the work site upon request by District staff. The permittee shall require the contractor to review the complete permit prior to commencement of the activity authorized by this permit.
3. Activities approved by this permit shall be conducted in a manner which does not cause violations of State water quality standards. The permittee shall implement best management practices for erosion and pollution control to prevent violation of State water quality standards. Temporary erosion control shall be implemented prior to and during construction, and permanent control measures shall be completed within 7 days of any construction activity. Turbidity barriers shall be installed and maintained at all locations where the possibility of transferring suspended solids into the receiving waterbody exists due to the permitted work. Turbidity barriers shall remain in place at all locations until construction is completed and soils are stabilized and vegetation has been established. All practices shall be in accordance with the guidelines and specifications described in Chapter 6 of the Florida Land Development Manual; A Guide to Sound Land and Water Management (Department of Environmental Regulation, 1988), incorporated by reference in Rule 40E-4.091, F.A.C. unless a project-specific erosion and sediment control plan is approved as part of the permit. Thereafter the permittee shall be responsible for the removal of the barriers. The permittee shall correct any erosion or shoaling that causes adverse impacts to the water resources.
4. The permittee shall notify the District of the anticipated construction start date within 30 days of the date that this permit is issued. At least 48 hours prior to commencement of activity authorized by this permit, the permittee shall submit to the District an Environmental Resource Permit Construction Commencement Notice Form Number 0960 indicating the actual start date and the expected construction completion date.
5. When the duration of construction will exceed one year, the permittee shall submit construction status reports to the District on an annual basis utilizing an annual status report form. Status report forms shall be submitted the following June of each year.
6. Within 30 days after completion of construction of the permitted activity, the permittee shall submit a written statement of completion and certification by a professional engineer or other individual authorized by law, utilizing the supplied Environmental Resource/Surface Water Management Permit Construction Completion/Certification Form Number 0881A, or Environmental Resource/Surface Water Management Permit Construction Completion Certification - For Projects Permitted prior to October 3, 1995 Form No. 0881B, incorporated by reference in Rule 40E-1.659, F.A.C. The statement of completion and certification shall be based on onsite observation of construction or review of as-built drawings for the purpose of determining if the work was completed in compliance with permitted plans and specifications. This submittal shall serve to notify the District that the system is ready for inspection. Additionally, if deviation from the approved drawings are discovered during the certification process, the certification must be accompanied by a copy of the approved permit drawings with deviations noted. Both the original and revised specifications must be clearly shown. The plans must be clearly labeled as "as-built" or "record" drawings. All surveyed dimensions and elevations shall be certified by a registered surveyor.
7. The operation phase of this permit shall not become effective: until the permittee has complied with the requirements of condition (6) above, and submitted a request for conversion of Environmental Resource Permit from Construction Phase to Operation Phase, Form No. 0920; the District determines the system to be in compliance with the permitted plans and specifications; and the entity approved by the District in accordance with Sections 9.0 and 10.0 of the Basis of Review for Environmental Resource Permit Applications within the South Florida Water Management District, accepts responsibility for operation and maintenance of the system. The permit shall not be transferred to such approved operation and maintenance entity until the operation phase of the permit becomes effective. Following inspection and approval of the permitted system by the District, the permittee shall initiate transfer of the permit to the approved

responsible operating entity if different from the permittee. Until the permit is transferred pursuant to Section 40E-1.6107, F.A.C., the permittee shall be liable for compliance with the terms of the permit.

8. Each phase or independent portion of the permitted system must be completed in accordance with the permitted plans and permit conditions prior to the initiation of the permitted use of site infrastructure located within the area served by that portion or phase of the system. Each phase or independent portion of the system must be completed in accordance with the permitted plans and permit conditions prior to transfer of responsibility for operation and maintenance of the phase or portion of the system to a local government or other responsible entity.
9. For those systems that will be operated or maintained by an entity that will require an easement or deed restriction in order to enable that entity to operate or maintain the system in conformance with this permit, such easement or deed restriction must be recorded in the public records and submitted to the District along with any other final operation and maintenance documents required by Sections 9.0 and 10.0 of the Basis of Review for Environmental Resource Permit applications within the South Florida Water Management District, prior to lot or units sales or prior to the completion of the system, whichever comes first. Other documents concerning the establishment and authority of the operating entity must be filed with the Secretary of State, county or municipal entities. Final operation and maintenance documents must be received by the District when maintenance and operation of the system is accepted by the local government entity. Failure to submit the appropriate final documents will result in the permittee remaining liable for carrying out maintenance and operation of the permitted system and any other permit conditions.
10. Should any other regulatory agency require changes to the permitted system, the permittee shall notify the District in writing of the changes prior to implementation so that a determination can be made whether a permit modification is required.
11. This permit does not eliminate the necessity to obtain any required federal, state, local and special district authorizations prior to the start of any activity approved by this permit. This permit does not convey to the permittee or create in the permittee any property right, or any interest in real property, nor does it authorize any entrance upon or activities on property which is not owned or controlled by the permittee, or convey any rights or privileges other than those specified in the permit and Chapter 40E-4 or Chapter 40E-40, F.A.C..
12. The permittee is hereby advised that Section 253.77, F.S. states that a person may not commence any excavation, construction, or other activity involving the use of sovereign or other lands of the State, the title to which is vested in the Board of Trustees of the Internal Improvement Trust Fund without obtaining the required lease, license, easement, or other form of consent authorizing the proposed use. Therefore, the permittee is responsible for obtaining any necessary authorizations from the Board of Trustees prior to commencing activity on sovereignty lands or other state-owned lands.
13. The permittee must obtain a Water Use permit prior to construction dewatering, unless the work qualifies for a general permit pursuant to Subsection 40E-20.302(3), F.A.C., also known as the "No Notice" Rule.
14. The permittee shall hold and save the District harmless from any and all damages, claims, or liabilities which may arise by reason of the construction, alteration, operation, maintenance, removal, abandonment or use of any system authorized by the permit.
15. Any delineation of the extent of a wetland or other surface water submitted as part of the permit application, including plans or other supporting documentation, shall not be considered binding, unless a specific condition of this permit or a formal determination under Section 373.421(2), F.S., provides otherwise.
16. The permittee shall notify the District in writing within 30 days of any sale, conveyance, or other transfer of ownership or control of a permitted system or the real property on which the permitted system is located. All transfers of ownership or transfers of a permit are subject to the requirements of Rules 40E-1.6105 and 40E-1.6107, F.A.C.. The permittee transferring the permit shall remain liable for corrective actions that may be required as a result of any violations prior to the sale, conveyance or other transfer of the system.
17. Upon reasonable notice to the permittee, District authorized staff with proper identification shall have permission to enter, inspect, sample and test the system to insure conformity with the plans and specifications approved by the permit.

18. If historical or archaeological artifacts are discovered at any time on the project site, the permittee shall immediately notify the appropriate District service center.
19. The permittee shall immediately notify the District in writing of any previously submitted information that is later discovered to be inaccurate.

ENVIRONMENTAL RESOURCE PERMITS CHAPTER 40E-4 (01/07)

40E-4.321 Duration of Permits.

(1) Unless revoked or otherwise modified the duration of an environmental resource permit issued under this chapter or Chapter 40E-40, F.A.C., is as follows:

(a) For a conceptual approval, two years from the date of issuance or the date specified as a condition of the permit, unless within that period an application for an individual or standard general permit is filed for any portion of the project. If an application for an environmental resource permit is filed, then the conceptual approval remains valid until final action is taken on the environmental resource permit application. If the application is granted, then the conceptual approval is valid for an additional two years from the date of issuance of the permit. Conceptual approvals which have no individual or standard general environmental resource permit applications filed for a period of two years shall expire automatically at the end of the two year period.

(b) For a conceptual approval filed concurrently with a development of regional impact (DRJ) application for development approval (ADA) and a local government comprehensive plan amendment, the duration of the conceptual approval shall be two years from whichever one of the following occurs at the latest date:

1. The effective date of the local government's comprehensive plan amendment,
2. The effective date of the local government development order,
3. The date on which the District issues the conceptual approval, or 4. The date on which the

District issues a final order pertaining to the resolution of any Section 120.57, F.S., administrative proceeding or other legal appeals.

(c) For an individual or standard general environmental resource permit, the construction phase authorizing construction, removal, alteration or abandonment of a system shall expire five years from the date of issuance or such amount of time as made a condition of the permit.

(d) For an individual or standard general environmental resource permit, the operational phase of the permit is perpetual for operation and maintenance.

(e) For a noticed general permit issued pursuant to Chapter 40E-400, F.A.C., five years from the date the notice of intent to use the permit is provided to the District.

(2)(a) Unless prescribed by special permit condition, permits expire automatically according to the timeframes indicated in this rule. If application for extension is made by electronic mail at the District's e-Permitting website or in writing pursuant to subsection (3), the permit shall remain in full force and effect until:

1. The Governing Board takes action on an application for extension of an individual permit, or
2. Staff takes action on an application for extension of a standard general permit.

(b) Installation of the project outfall structure shall not constitute a vesting of the permit.

(3) The permit extension shall be issued provided that a permittee files a written request with the District showing good cause prior to the expiration of the permit. For the purpose of this rule, good cause shall mean a set of extenuating circumstances outside of the control of the permittee. Requests for extensions, which shall include documentation of the extenuating circumstances and how they have delayed this project, will not be accepted more than 180 days prior to the expiration date.

(4) Substantial modifications to Conceptual Approvals will extend the duration of the Conceptual Approval for two years from the date of issuance of the modification. For the purposes of this section, the term "substantial modification" shall mean a modification which is reasonably expected to lead to substantially different water resource or environmental impacts which require a detailed review.

(5) Substantial modifications to individual or standard general environmental resource permits issued pursuant to a permit application extend the duration of the permit for three years from the date of issuance of the modification. Individual or standard general environmental resource permit modifications do not extend the duration of a conceptual approval.

(6) Permit modifications issued pursuant to paragraph 40E-4.331(2)(b), F.A.C. (letter modifications) do not extend the duration of the permit.

(7) Failure to complete construction or alteration of the surface water management system and obtain operation phase approval from the District within the permit duration shall require a new permit authorization in order to continue construction unless a permit extension is granted.

Specific Authority 373.044, 373.113, 668.003, 668.004, 668.50 FS. Law Implemented 373.413, 373.416, 373.419, 373.426, 668.003, 668.004, 668.50 FS. History-New 9-3-81, Amended 1-31-82, 12-1-82, Formerly 16K-4.07(4), Amended 7-1-86, 4-20-94, 10-3-95, 5-28-00, 10-1-06.

EXHIBIT 2.02B



 **SITE MAP**



G. M. SELBY Inc.

6999 N WATERWAY DR.
 MIAMI, FL 33155
 TEL : (305) 282-0715
 FAX : (305) 282-0724

THIS DRAWING IS COPYRIGHTED AND IS THE SOLE PROPERTY OF G.M. SELBY & ASSOCIATES, INC. IF IS PRODUCED FOR USE BY THE CITY OF KEY WEST. REPRODUCTION OR OTHER USE OF THIS DRAWING OR THE INFORMATION CONTAINED HEREIN WITHOUT THE WRITTEN PERMISSION OF G.M. SELBY & ASSOCIATES, INC. IS PROHIBITED. ALL RIGHTS RESERVED. 1007

G.M. SELBY and KWC 240290
 DRAWN BY: F.C. DATE: 03-06-07
 CHECKED BY:
 DESIGNER: GERALD ZADKOFF
 LICENSE NO.: CIVIL PE# 44206 FL

G. Selby

REVISIONS		
NO.	DATE	DESCRIPTION

POINCIANA DONALD DRAINAGE

SHEET TITLE:
SITE MAP

SHEET NO:
C-1

EXHIBIT 2.02C

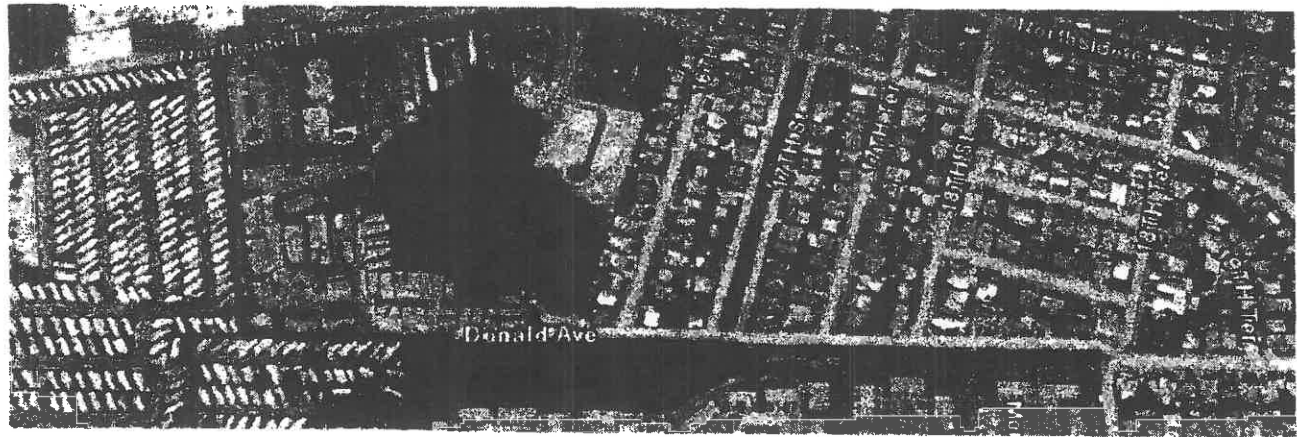
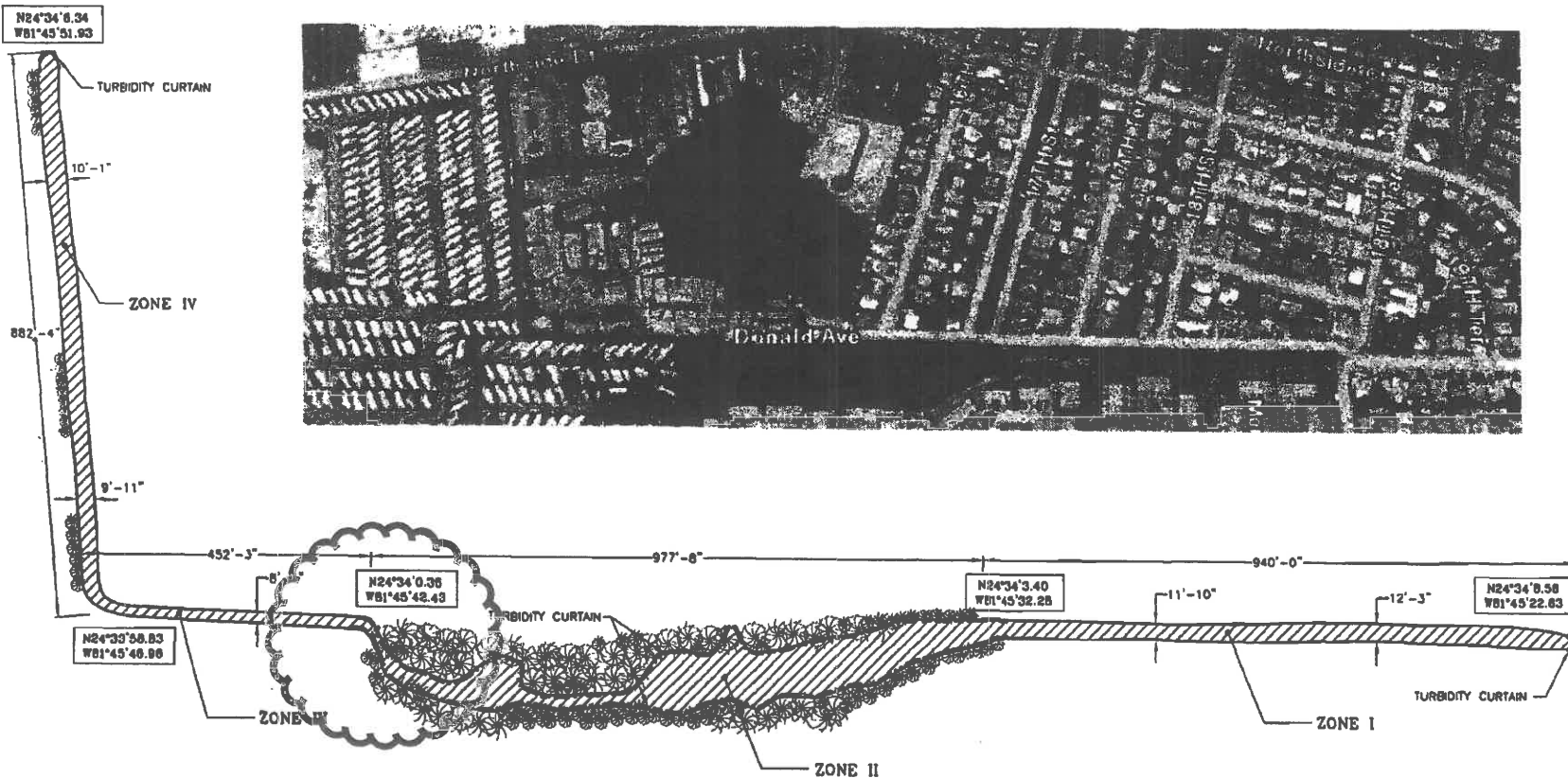

SITE PLAN

TOTAL VOLUME OF MATERIAL TO BE DREDGED- 5074 CuYd

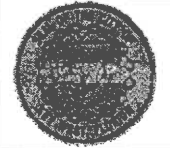

G. M. SELBY Inc.

5990 N. WATERWAY DR.
MIAMI, FL 33155
TEL. : (305) 282-0715
FAX : (305) 282-0724

THIS DRAWING IS COPYRIGHTED AND IS THE SOLE PROPERTY OF G.M. SELBY & ASSOCIATES, INC. IT IS PRODUCED FOR USE BY THE CITY OF KEY WEST. REPRODUCTION OR OTHER USE OF THIS DRAWING OR THE INFORMATION CONTAINED HEREIN WITHOUT THE WRITTEN PERMISSION OF G.M. SELBY & ASSOCIATES, INC. IS PROHIBITED. ALL RIGHTS RESERVED, 2007

S.E. MAP NO. RWC240290
DRAWN BY: T.C. DATE: 03-06-07

DESIGNED BY: GERALD ZADKOFF
LICENSE NO.: CIVIL PE# 64206 FL

G.M. Selby

REVISIONS	
NO.	DESCRIPTION

POINCIANA DONALD DRAINAGE

SHEET TITLE:
SITE PLAN

SHEET NO:
C-2

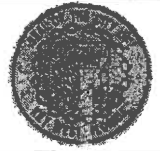

G. M. SELBY Inc.

6900 N. WATERWAY DR.
MIAMI, FL 33155
TEL : (305) 282-0719
FAX : (305) 282-0724

THIS DRAWING IS COPYRIGHTED AND IS THE SOLE PROPERTY OF G.M. SELBY & ASSOCIATES, INC. IT IS PRODUCED FOR USE BY THE CITY OF MIAMI. REPRODUCTION OR OTHER USE OF THIS DRAWING OR THE INFORMATION CONTAINED HEREIN WITHOUT THE WRITTEN PERMISSION OF G.M. SELBY & ASSOCIATES, INC. IS PROHIBITED. ALL RIGHTS RESERVED. ©2007

G.M. SELBY NO. RWC240280
ISSUED BY: F.C. DATE: 03-08-07

DESIGNED BY: GERALD ZACHOFF
LICENSE NO.: CIVIL PE# 44206 FL
RBRU

REVISIONS	
NO.	DATE DESCRIPTION

POINCIANA DONALD DRAINAGE

SHEET TITLE:
CHANNEL DETAIL

SHEET NO:
C-3

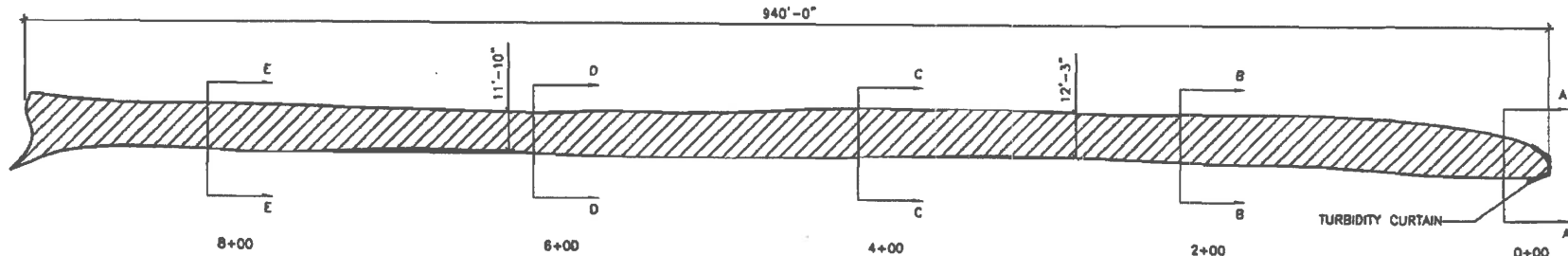

CHANNEL TOP VIEW - ZONE I

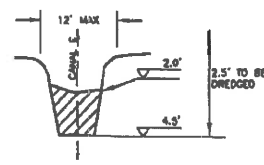

SECTION 'E-E'
5000 CF=185.18 CuYd

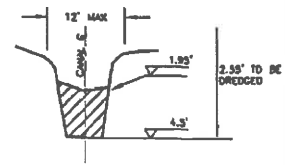

SECTION 'D-D'
4080 CF=151.11 CuYd

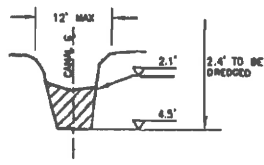

SECTION 'C-C'
3840 CF=142.22 CuYd

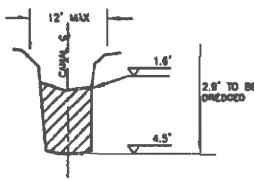

SECTION 'B-B'
5220 CF=193.33 CuYd

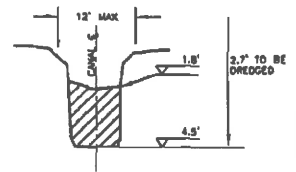

SECTION 'A-A'
3024 CF=112.00 CuYd

TOTAL VOLUME OF MATERIAL TO BE DREDGED = 783.84 CuYd

NOTE:
DREDGE ALL OPEN AREAS TO A DEPTH OF 4.5 FEET AT LOW TIDE.
DREDGE FOR ELEVATION -4.3' NGVD AT MLW.

TURBIDITY CURTAIN TO BE PLACED IN FRONT OF ANY VEGETATION (MANGROVES). IT MUST BE IN PLACE AT ALL TIME DURING ANY WORK, AT THE SITE.

EXHIBIT 2.02D

EXHIBIT 2.02 E

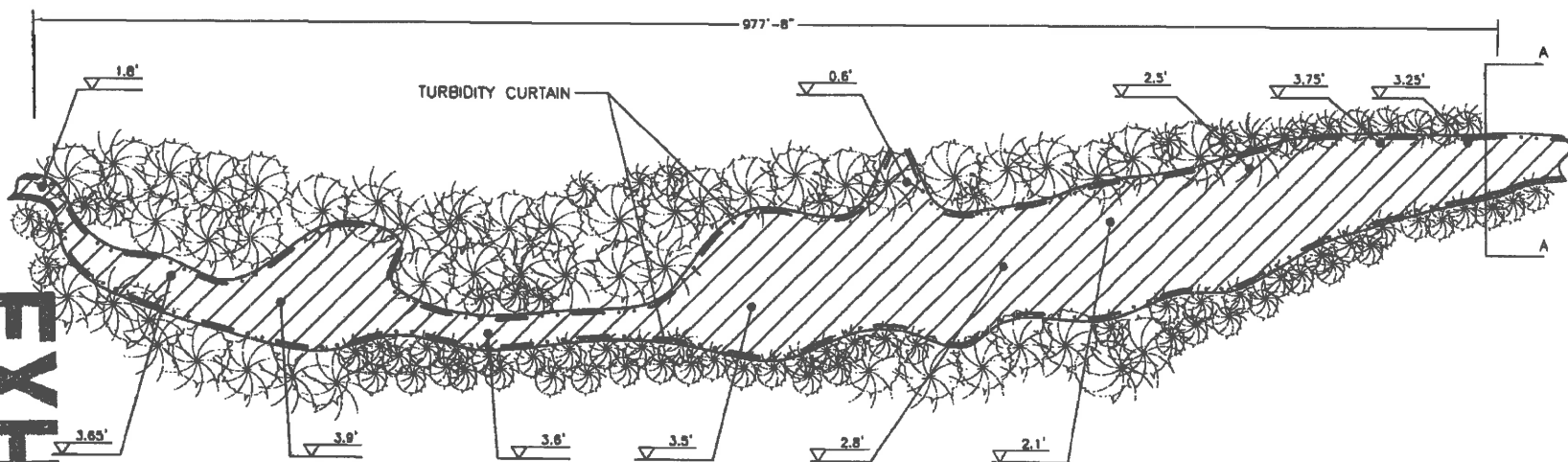

CHANNEL TOP VIEW - ZONE II

NOTE:
 DREDGE ALL OPEN AREAS TO A DEPTH OF 4.5 FEET AT LOW TIDE.
 DREDGE FOR ELEVATION -4.3' NGVD AT MLW.

 TURBIDITY CURTAIN TO BE PLACED IN FRONT OF ANY VEGETATION (MANGROVES). IT MUST BE IN PLACE AT ALL TIME DURING ANY WORK, AT THE SITE.

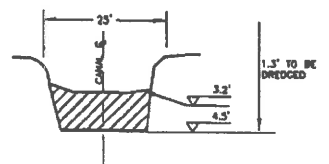

SECTION 'A-A'

TOTAL VOLUME OF MATERIAL TO BE DREDGED- 3356 Cu yd



G. M. SELBY Inc.

6000 N. WATERWAY DR.
 MIAMI, FL 33155
 TEL.: (305) 282-0715
 FAX.: (305) 282-0724

THIS DRAWING IS COPYRIGHTED AND IS THE SOLE PROPERTY OF G.M. SELBY & ASSOCIATES, INC. IT IS PRODUCED FOR USE BY THE CITY OF KEY WEST. REPRODUCTION OR OTHER USE OF THIS DRAWING OR THE INFORMATION CONTAINED HEREIN WITHOUT THE WRITTEN PERMISSION OF G.M. SELBY & ASSOCIATES, INC. IS PROHIBITED. ALL RIGHTS RESERVED. 4/2007

G.M. SELBY No. KWC240290
 DRAWN BY: F.C. DATE: 03-08-07
 CHECKED BY: GERALD ZADKOFF
 LICENSE NO.: CML PE# 44208 FL
 EML

REVISIONS	
NO.	DATE DESCRIPTION

POINCIANA
 DONALD
 DRAINAGE

SHEET TITLE:
 CHANNEL DETAIL

SHEET NO:
C-4

EXHIBIT 2.02 F

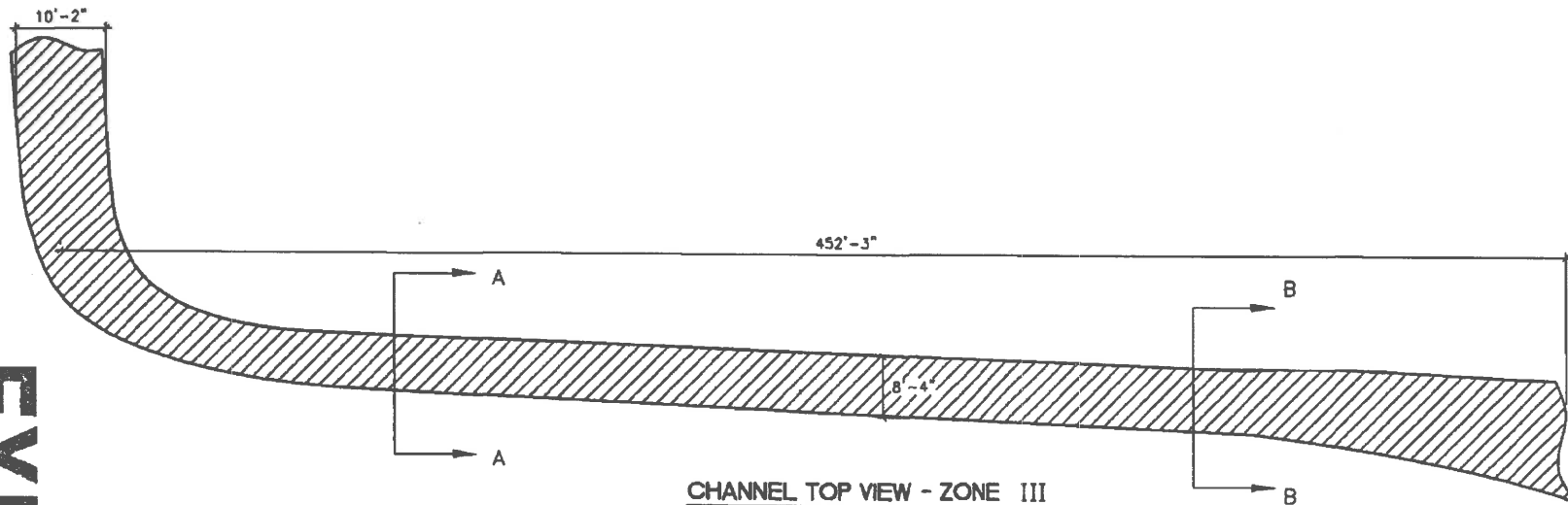

TOTAL VOLUME OF MATERIAL TO BE DREDGED - 418 Cuyd

NOTE:
 DREDGE ALL OPEN AREAS TO A DEPTH OF 4.5 FEET AT LOW TIDE.
 DREDGE FOR ELEVATION -4.3' NGVD AT MLW.

TURBIDITY CURTAIN TO BE PLACED IN FRONT OF ANY VEGETATION (MANGROVES). IT MUST BE IN PLACE AT ALL TIME DURING ANY WORK, AT THE SITE.

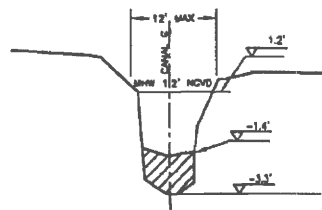

SECTION "A-A"
 N24°33.99'
 W81°45.73'

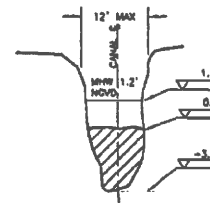

SECTION "B-B"
 N24°34.003'
 W81°45.723'

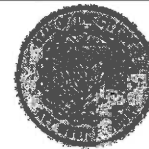

G. M. SELBY Inc.

6998 N. WATERWAY DR.
 MIAMI, FL 33155
 TEL : (305) 282-0715
 FAX : (305) 282-0724

THIS DRAWING IS COPYRIGHTED AND IS THE SOLE PROPERTY OF G.M. SELBY & ASSOCIATES, INC. IT IS PRODUCED FOR USE BY THE CITY OF KEY WEST. REPRODUCTION OR OTHER USE OF THIS DRAWING OR THE INFORMATION CONTAINED HEREIN WITHOUT THE WRITTEN PERMISSION OF G.M. SELBY & ASSOCIATES, INC. IS PROHIBITED. ALL RIGHTS RESERVED. ©2007

G.M. SELBY INC. EWC240290
 DRAWN BY: F.C. DATE: 03-08-07
 CHECKED BY:
 DESIGNER: GERALD ZADKOFF
 LICENSE NO.: CIVIL PE# 44206 FL

Handwritten signature/initials

NO.	DATE	REVISIONS DESCRIPTION

PONCIANA DONALD DRAINAGE

SHEET TITLE:
CHANNEL DETAIL

SHEET NO:
C-5

EXHIBIT 2.02 G

TOTAL VOLUME OF MATERIAL
TO BE DREDGED - 518.32 CuYd

NOTE:
DREDGE ALL OPEN AREAS TO A DEPTH
OF 4.5 FEET AT LOW TIDE.
DREDGE FOR ELEVATION -4.3' NGVD
AT MLW.

TURBIDITY CURTAIN TO BE PLACED IN
FRONT OF ANY VEGETATION (MANGROVES).
IT MUST BE IN PLACE AT ALL TIME
DURING ANY WORK, AT THE SITE.

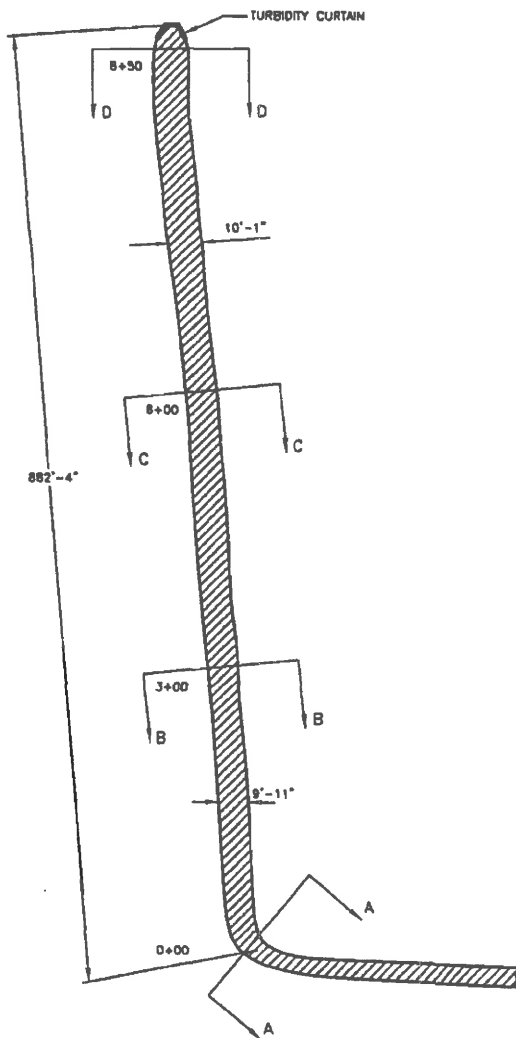

CHANNEL TOP VIEW - ZONE IV

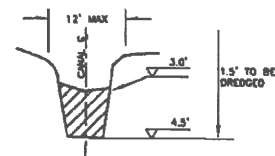

SECTION 'D-D'

2244.6 CF=63.133 CuYd

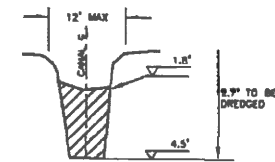

SECTION 'C-C'

6885 CF=255.000 CuYd

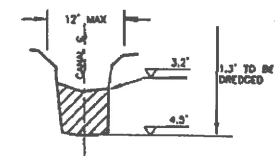

SECTION 'B-B'

3315 CF=122.778 CuYd

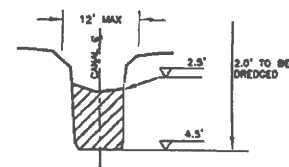

SECTION 'A-A'

1550 CF=57.407 CuYd

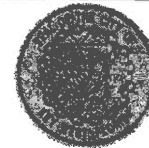

G. M. SELBY Inc.

6999 N. WATERWAY DR.
MIAMI, FL 33153
TEL : (305) 282-0715
FAX : (305) 282-0724

THIS DRAWING IS COPYRIGHTED AND IS THE SOLE PROPERTY OF G.M. SELBY & ASSOCIATES, INC. IT IS PRODUCED FOR USE BY THE CITY OF KEY WEST. REPRODUCTION OR OTHER USE OF THIS DRAWING OR THE INFORMATION CONTAINED HEREIN WITHOUT THE WRITTEN PERMISSION OF G.M. SELBY & ASSOCIATES, INC. IS PROHIBITED. ALL RIGHTS RESERVED. © 2007

D.L. SELBY NO. KWC240230
DRAWN BY F.C. DATE 03-06-07

CHECKED BY
LARRY M. CAYL, PEJ 44208 FL
REVISIONS

NO.	DATE	DESCRIPTION

**POINCIANA
DONALD
DRAINAGE**

SHEET TITLE:
CHANNEL DETAIL

SHEET NO:
C-6

EXHIBIT
2.02 H

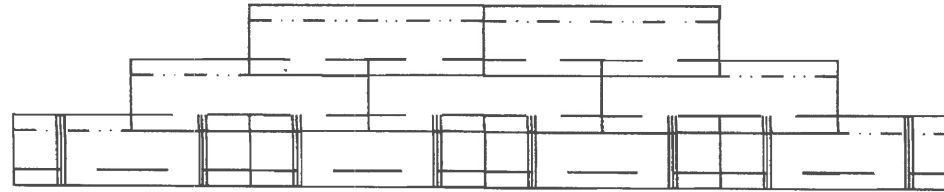
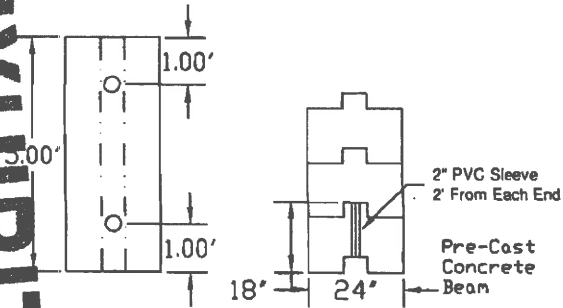

NOTE: #8 Rebar Imbedment
12' Min Into Cap Rock

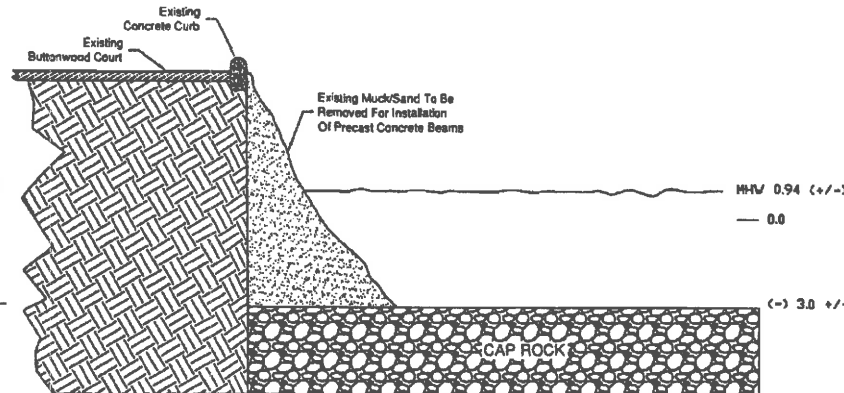
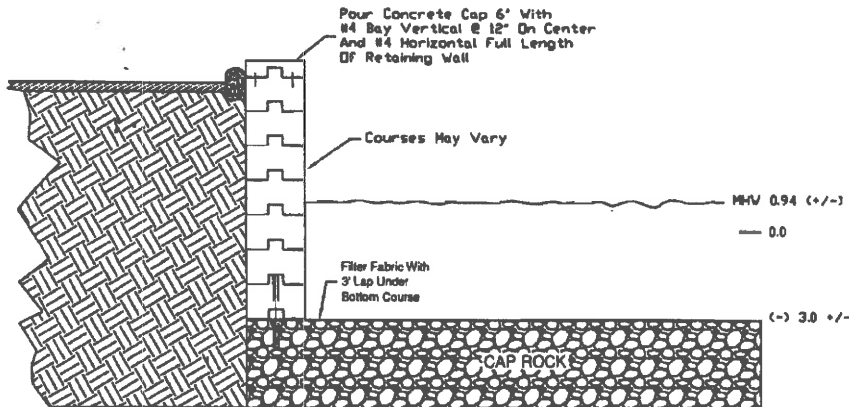

LINEAR ft=453' X 2 EMBANKMENTS

NOTE:
TURBIDITY CURTAIN TO BE PLACED IN
FRONT OF ANY VEGETATION (MANGROVES).
IT MUST BE IN PLACE AT ALL TIME
DURING ANY WORK, AT THE SITE.

**EROSION CONTROL STRUCTURE ZONE III
OF THE POINCIANA/DONALD CANAL**

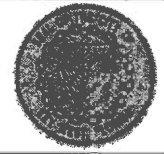

G. M. SELBY Inc.

6998 N. WATERWAY DR.
MIAMI, FL 33155
TEL : (305) 282-0715
FAX : (305) 282-0724

THIS DRAWING IS COPYRIGHTED AND IS THE SOLE PROPERTY OF G.M. SELBY & ASSOCIATES, INC. IT IS PRODUCED FOR USE BY THE CITY OF KEY WEST. REPRODUCTION OR OTHER USE OF THIS DRAWING OR THE INFORMATION CONTAINED HEREIN WITHOUT THE WRITTEN PERMISSION OF G.M. SELBY & ASSOCIATES, INC. IS PROHIBITED. ALL RIGHTS RESERVED. #2007

G.M. SELBY NO. KWC240290
DRAWN BY F.C. / DATE 03-08-07
CHECKED BY
ENGINEER GERALD ZADROFF
LICENSE NO. CYR. P.E. / 44208 FL

Handwritten signature

REVISIONS	
NO.	DATE / DESCRIPTION

POINCIANA DONALD DRAINAGE

SHEET TITLE:
EROSION CONTROL STRUCTURE

SHEET NO:
C-7

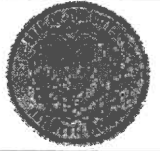

6999 N. WATERWAY DR.
MIAMI, FL 33155
TEL : (305) 262-0715
FAX : (305) 262-0724

THIS DRAWING IS COPYRIGHTED AND IS THE SOLE PROPERTY OF G.M. SELBY & ASSOCIATES, INC. IT IS PRODUCED FOR USE BY THE CITY OF MIAMI. REPRODUCTION OR OTHER USE OF THIS DRAWING OR THE INFORMATION CONTAINED HEREIN WITHOUT THE WRITTEN PERMISSION OF G.M. SELBY & ASSOCIATES, INC. IS PROHIBITED. ALL RIGHTS RESERVED. 4/2007

G.M. SELBY No. KWC240290
shown on F.C. 1-010 03-06-07
checked by
designed by GERALD ZADROFF
LICENSED MECHANICAL ENGINEER 44208 FL
SEAL

REVISIONS		
NO.	DATE	DESCRIPTION

**POINCIANA
DONALD
DRAINAGE**

SHEET TITLE:
TURBIDITY BARRIER

SHEET NO:
C-8

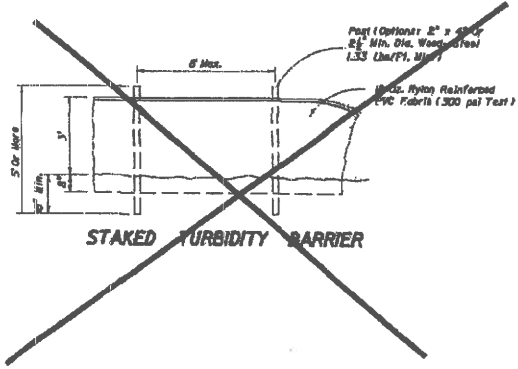

STAKED TURBIDITY BARRIER

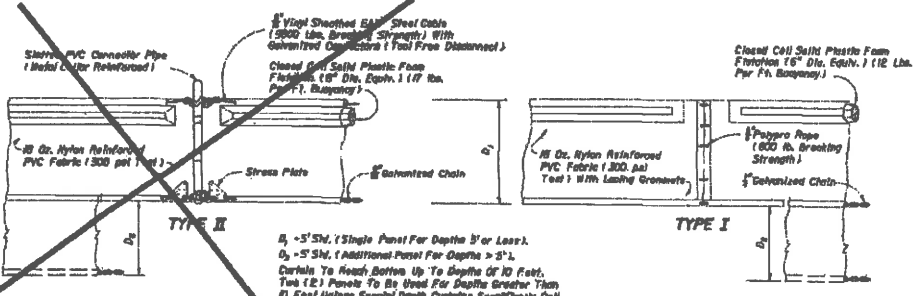

TYPE II
4' - 5' SH. (Single Panel For Depth 3' or Less).
0' - 5' SH. (Additional Panel For Depth > 3').
Curtain To Reach Bottom Up To Depth Of 10 Feet.
Two (2) Panels To Be Used For Depth Greater Than
10 Feet Unless Special Depth Curtains Specifically Call
For In The Plans Or As Determined By The Engineer.

NOTICE: COMPONENTS OF TYPES I AND II MAY BE SIMILAR OR IDENTICAL TO PROPRIETARY DESIGNS. ANY INFRINGEMENT ON THE PROPRIETARY RIGHTS OF THE DESIGNER SHALL BE THE SOLE RESPONSIBILITY OF THE USER. SUBSTITUTIONS FOR TYPES I AND II SHALL BE AS APPROVED BY THE ENGINEER.

FLOATING TURBIDITY BARRIERS

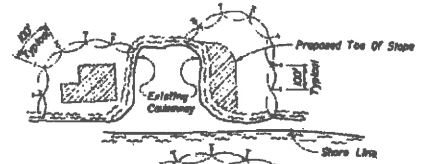

- LEGEND**
- Pile Locations
 - ▨ Dredge Or Fill Area
 - Mooring Buoy w/Anchor
 - Anchor
 - Barrier Movement Due To Current Action

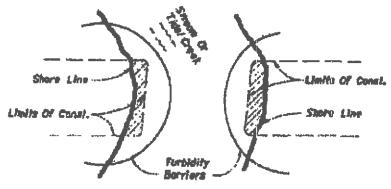
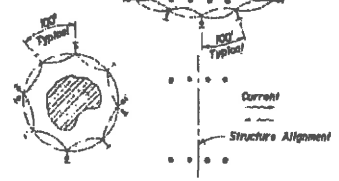

- NOTES:**
1. Turbidity barriers are to be used in all permanent bodies of water regardless of water depth.
 2. Number and spacing of anchors dependent on current velocities.
 3. Deployment of barrier around pile locations may vary to accommodate construction operations.
 4. Navigation may require accumulation barrier during construction operations.
 5. For additional information see Section 104 of the Standard Specifications.

Note:
Turbidity barriers for flowing streams and tidal creeks may be either floating, or staked types or any combination of types that will suit site conditions and meet erosion control and water quality requirements. The barrier type(s) will be of the Contractor's option unless otherwise specified in the plans, however payment will be under the pay items established in the plans for Floating Turbidity Barrier and/or Staked Turbidity Barrier. Panels in staked turbidity barriers to be installed in vertical position unless otherwise directed by the Engineer.

- GENERAL NOTES**
1. Floating turbidity barriers are to be paid for under the contract unit price for Floating Turbidity Barrier, LP.
 2. Staked turbidity barriers are to be paid for under the contract unit price for Staked Turbidity Barrier, LP.
 3. Turbidity Curtains to be staged as work progresses, and to contain any silt generated from all construction activity.

TURBIDITY BARRIER APPLICATIONS

EXHIBIT 2.021

EXHIBIT 2.025

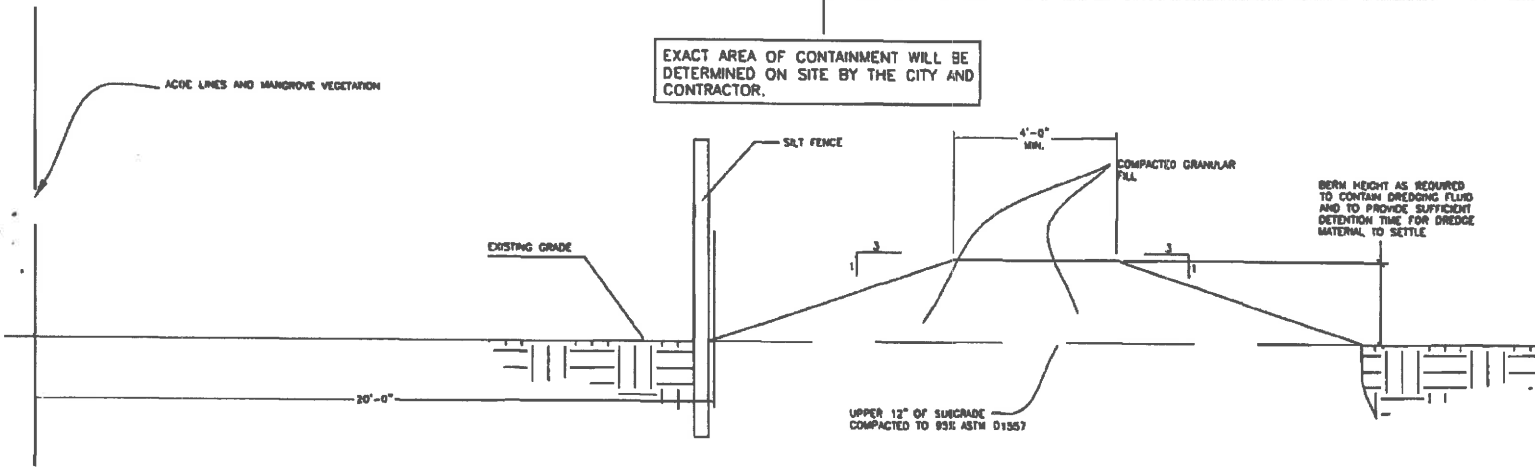
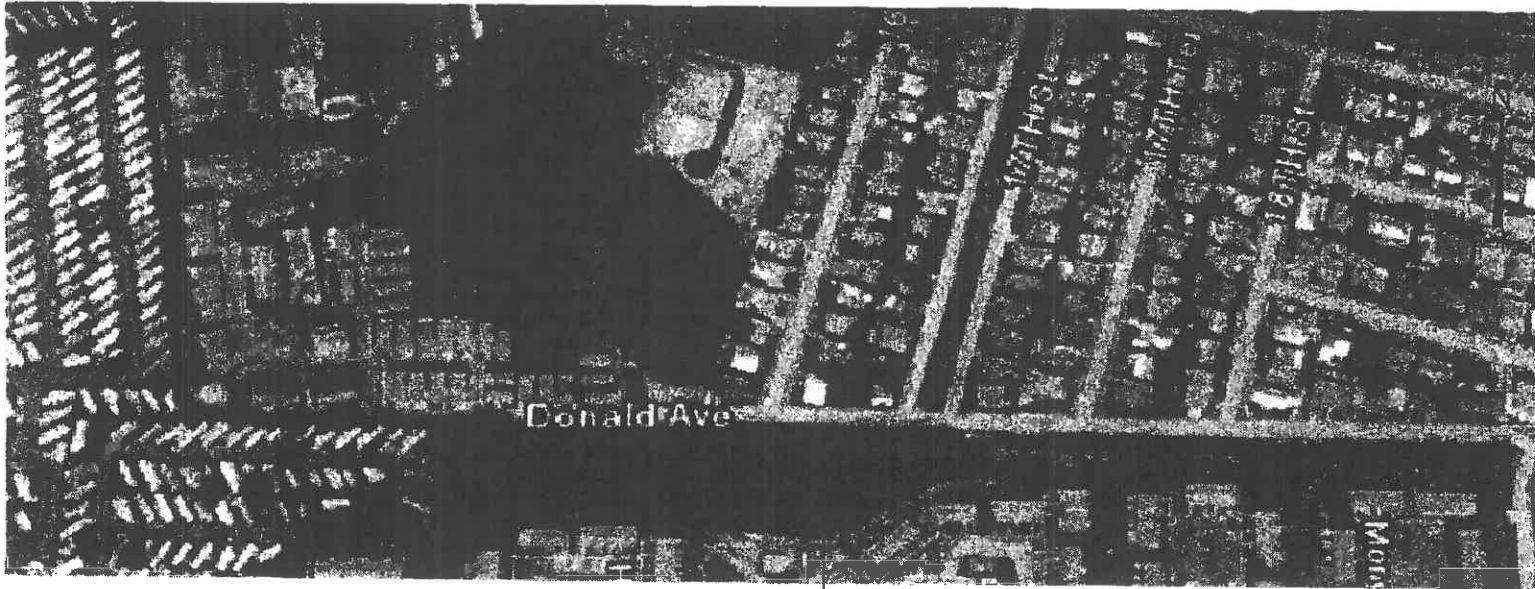

EXACT AREA OF CONTAINMENT WILL BE DETERMINED ON SITE BY THE CITY AND CONTRACTOR.

**TYPICAL SPOIL AREA
CONTAINMENT BERM**

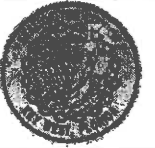

G. M. SELBY Inc.

6999 N. WATERWAY DR.
MIAMI, FL 33135
TEL : (305) 262-0715
FAX : (305) 262-0724

THIS DRAWING IS COPYRIGHTED AND IS THE SOLE PROPERTY OF G.M. SELBY & ASSOCIATES, INC. IF IT IS PRODUCED FOR USE BY THE CITY OF MIAMI, REPRODUCTION OR OTHER USE OF THIS DRAWING OR THE INFORMATION CONTAINED HEREIN WITHOUT THE WRITTEN PERMISSION OF G.M. SELBY & ASSOCIATES, INC. IS PROHIBITED. ALL RIGHTS RESERVED. 2007

G.M. SELBY Job: RWC240290
Drawn by: F.C. Date: 03-06-07
Checked by:
Designed: GERALD ZADKOFF
License No. CIVIL PE 44208 FL
Scale:

REVISIONS	
NO.	DESCRIPTION

**PONCIANA
DONALD
DRAINAGE**

SHEET TITLE:
**SPOIL CONTAINMENT
AREA**

SHEET NO:
C-9

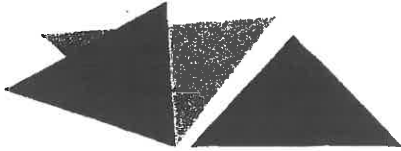

G.M. SELBY, Inc.

ENVIRONMENTAL ASSESSMENT
FOR THE
POINCIANA/DONALD DRAINAGE SITE



EXHIBIT 2.02 K

PREPARED FOR THE CITY OF KEY WEST

MARCH 2007

SCOPE

The primary responsibility of governmental agencies is to their citizens, and their health and safety. After the devastating hurricane season of 2005, the City of Key West became acutely aware of its drainage problems. Standing water, especially in the tropical climate of Key West, is a well-known breeding ground for diseases and their vectors. Standing water also impairs the City's ability to provide emergency services to its citizens. The City of Key West has proposed several projects to relieve its city-wide drainage problems. Below, is one of the proposed projects. Project plans call for the improvement and continuing maintenance of existing drainageways.

- 1- Poinciana Donald Drainage- The project plans for the Donald canal call for the improvement and continuing maintenance of the existing drainageway through the restoration of approximately three-thousand, two-hundred, and fifty-one (3251) feet of total drainage channel length, with a width not to exceed thirteen (13) feet, and depth not to exceed four (4) feet.

The Donald canal drains into the Poinciana stormwater detention pond. The project plans for the Poinciana stormwater detention pond call for the improvement and continuing maintenance of the existing stormwater detention pond by dredging the existing open water area of the stormwater detention pond to a depth not to exceed four (4) feet, six (6) inches. Existing mangroves are to remain.

Location

The Donald Avenue canal and Poinciana stormwater detention pond from Northside Drive to Nineteenth Street. 24°34'2.37"N; 81°45'36.45"W.

Existing Features

The Poinciana Donald Drainage site was visited on March 4, 2007. The hydrology of the site was not readily apparent. Water from Poinciana Donald drainage detention pond may ultimately connect with the City of Key West Salt Ponds Park via drainage along Seventeenth St., or directly to the Atlantic Ocean via drainage along Donald Avenue.

EXHIBIT 2.02 L

The existing vegetation at the Poinciana detention pond shoreline appeared to be dominated by red mangrove (*Rhizophora mangle*). Black mangrove (*Avicennia germinans*), white mangrove (*Laguncularia racemosa*), and Brazilian Pepper (*Schinus terebinthifolius*) were also observed. Except for heavy growth of green alga, the unconsolidated nature of the bottom in both the canal and pond allowed for little benthic growth. However, green algae, (*acetabularia* sp.), and blue crab (*Callinectes* sp.) were observed. The above indicates that the canal and stormwater detention pond are tidally influenced. All existing mangroves are to remain.

Environmental Impacts

The project plans for the Donald canal call for the improvement and continuing maintenance of the existing drainageway through the restoration of approximately three-thousand, two-hundred, and fifty-one (3251) feet of total drainage channel length, with a width not to exceed thirteen (13) feet, and depth not to exceed four (4) feet.

The Donald canal drains into the Poinciana stormwater detention pond. The project plans for the Poinciana stormwater detention pond call for the improvement and continuing maintenance of the existing stormwater detention pond by dredging the existing open water area of the stormwater detention pond to a depth not to exceed four (4) feet, six (6) inches. All existing mangroves are to remain.

An estimated four-hundred and fifteen and fifty-six hundredths (415.56) cubic yards of material will be dredged from the Donald canal. An estimated four-thousand three-hundred and fifty-six (4356) cubic yards of material will be dredged from the Poinciana pond. There should be no, or limited temporary damage, to the mangroves at the Poinciana Donald Drainage site. All existing mangroves are to remain.

Continuing and on-going maintenance will include trimming of mangrove roots and limbs that encroach into the drainageway impeding the flow of stormwater. Periodic maintenance to remove debris and maintain the depth of drainageway may also impact mangroves.

EXHIBIT 2.02M

Recommendations

Plans should specify turbidity screens that go across the canals, crossing screens should be as close to the work as possible, and move upstream as the work does. Outfalls and culverts should be closed-off during construction.

Ripraping along the shore edge and mangrove margin in the Poinciana pond will define the maintenance area within the main drainage channel, and may slow the rate of mangrove growth out into it. Riprap will provide some habitat in the pond, and may help reduce turbidity in the pond.

EXHIBIT 2.02 N



Photograph 6: Poinciana Donald Drainageway

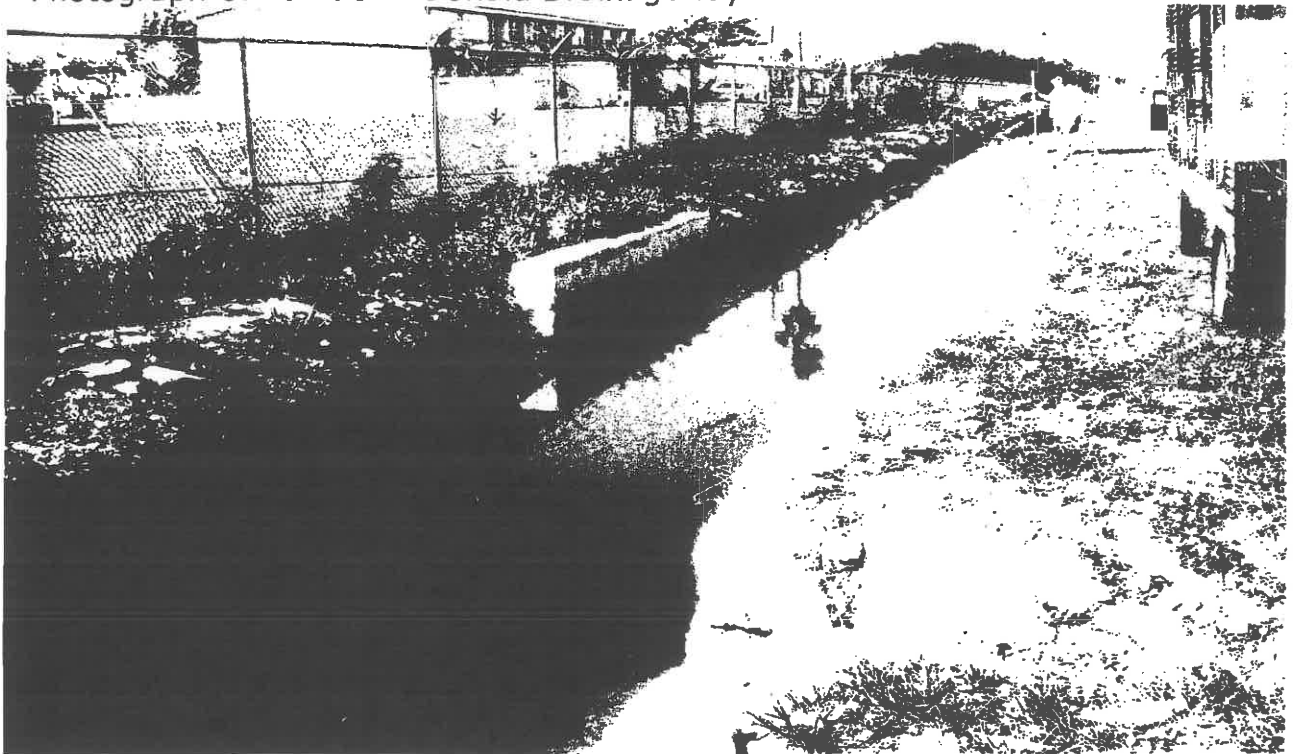

Photograph 7: Poinciana Donald Drainageway

EXHIBIT 2.020

BEFORE THE GOVERNING BOARD OF THE
SOUTH FLORIDA WATER MANAGEMENT DISTRICT

RECEIVED
DISTRICT CLERK'S OFFICE

APR 19 2007 2:27 PM

SOUTH FLORIDA
WATER MANAGEMENT DISTRICT

SOUTH FLORIDA WATER MANAGEMENT
DISTRICT, a public corporation,

Complainant,

vs.

City of Key West,
Respondent

ORDER NO.

SFWMD 2007 096 CO ERP

CONSENT AGREEMENT

This Consent Agreement is entered into between the Complainant, **SOUTH FLORIDA WATER MANAGEMENT DISTRICT** ("District") and the Respondent, City of Key West ("Respondent") by mutual consent, without trial or adjudication of any issue of fact or law.

FINDINGS OF FACT

The District and Respondent stipulate to the following Findings of Fact:

1. The District is a public corporation of the State of Florida existing by virtue of Chapter 25270, Laws of Florida, 1949, and operating pursuant to Chapter 373, Fla. Stat., and Title 40E, Fla. Admin. Code, as a multipurpose water management district with its principal office at 3301 Gun Club Road, West Palm Beach, FL 33406.

2. Respondent, City of Key West is a Florida Municipal Corporation, whose business mailing address for the purpose of this consent agreement is PO Box 1409, 525 Angela Street, Key West, Florida 33040.

3. On July 27, 2006, District staff became aware of a newspaper article indicating that the City of Key West was dredging mangroves in a pond at the intersection of Jose Marti Drive and North Roosevelt Boulevard. An aerial inspection by District staff on July 28, 2006, confirmed that significant dredging, including mangrove removal, was taking place on the north and west sides of the pond.

4. This dredging activity was not authorized by an Environmental Resource Permit as required under Sections 373.413 and 373.414 of the Florida Statutes, and Rule 40E-4 of the Florida Administrative Code.

5. On July 28, 2006, the District notified the City and forwarded a Cease and Desist Notice (Exhibit A) requiring the City to stop any further dredging. The City stopped dredging soon thereafter.

6. Respondent indicated to District staff that they had cleared and dredged the mangrove wetlands at the Jose Marti location for emergency maintenance of the City storm water system due to potential on-coming hurricanes. Respondent also volunteered to the District that it had recently done similar dredging of mangrove and salt marsh wetlands for emergency storm water maintenance along the Donald Avenue area. The work at the Donald Avenue area was also done without authorization of an Environmental Resource Permit. The area impacted at the Jose Marti location was 0.341 acres, and the area impacted at Donald Avenue location was 0.870 acres. The properties are more particularly depicted on the location map attached as Exhibit B.

7. On August 11, 2006, District staff met on-site at the properties listed above with City of Key West officials and their consultants; U.S. Army Corps of Engineers (USACE); Florida Department of Environmental Protection; and Department of Community Affairs to assess the impacts and to discuss resolution of the violation. Included with the resolution of this violation was a proposal to develop a comprehensive mitigation and in-kind enhancement program to compensate for the impacts and proposed future impacts for the purpose of stormwater system management.

8. Since the August 11, 2006, meeting the Respondent and the District have met several times to negotiate settlement of this matter. The Respondent has prepared an Impact Assessment and Mitigation Plan, herein referenced as "the Plan" (Exhibit C) that, if successfully implemented, off-sets the impacts described above with an enhancement and restoration project at the abandoned Hawk Missile Base Site. Successful implementation of this enhancement and restoration project will also provide additional up front mitigation for future storm water projects that have wetland impacts.

9. Respondent is also proposing, in lieu of civil penalties, to construct, monitor and maintain a Western Salt Pond Enhancement Project. This Project is described in the Plan (Exhibit C). The Project should result in overall habitat improvements to over 136 acres of wetlands in the western Key West Salt Ponds .

ULTIMATE FACTS AND CONCLUSIONS OF LAW

10. The District alleges that the Respondent violated the District's rules by performing activities on the Property without prior issuance of an environmental resource permit pursuant to Chapter 373, Fla. Stat. and Chapter 40E-4, Fla. Admin. Code., which prohibit the construction and operation of any works without first satisfying the criteria of the District through the permitting process.

11. Pursuant to Sections 373.413, and 373.414, Fla. Stat., and the implementing regulations found in Title 40E, Fla. Admin. Code, the District is authorized to require permits for construction, alteration and/or operation of surface water management systems, including activities which impact wetlands. In the issuance of construction permits, the District is authorized to impose reasonable conditions necessary to assure the activities will not be harmful to the water resources of the District. As to issuance of operation permits, the District is authorized by Section 373.416, Fla. Stat., to impose reasonable conditions necessary to assure that the operation or maintenance of any surface water management system will not be inconsistent with the overall objectives of the District.

12. The District may enforce its permits and orders pursuant to Chapters 373 and 120, Fla. Stat., by maintenance of appropriate actions and may recover a civil penalty for each offense in an amount not to exceed Ten Thousand Dollars (\$10,000.00) per offense, with each date during which such violation occurs constituting a separate offense. The District may further recover investigative costs, court costs and reasonable attorney's fees.

13. Without admitting liability, the Respondent has provided the District with reasonable assurances of good faith by entering into a Consent Agreement with the District in return for the District not initiating judicial or enforcement action for the alleged unpermitted activities described above. The Respondent agrees that all factual and legal matters alleged herein or agreed to herein or which provide the basis for this Consent Agreement (including all terms, provisions and matters referred to in the "Findings of Fact" and/or "Ultimate Facts" and "Conclusions of Law" sections) shall not be contested in any subsequent legal proceeding(s) which may be brought to enforce the terms of this Consent Agreement.

14. The District is authorized to enter into agreements pursuant to Section 373.083, Fla. Stat.

15. The Governing Board has authorized the Executive Director, or her designee, to execute this Consent Agreement.

THEREFORE, having reached a resolution of this matter, the District and the Respondent mutually agree and it is ordered that:

ORDER

20. Respondent shall start construction of the restoration project for the Hawk Missile Restoration Project within six months of the effective date of this Consent Agreement and then complete the balance of the project (Exhibit C) within twelve months from the project start date. All construction must be completed no later than 18 months of the effective date of this Consent Agreement. The construction of the restoration and enhancement project shall be as set forth in the Plan (Exhibit C).

21. Respondent shall submit two certified copies of the recorded conservation easement or other similar restrictive covenant for the mitigation area at the former Hawk Missile Base site within one (1) year of the effective of this Consent Agreement

22. A monitoring program shall be implemented for the Hawk Missile Site Restoration project. The monitoring program shall extend for a period of 5 years with annual reports submitted to District staff. Respondent shall maintain and monitor the created/restored wetlands for a period of five (5) years from the approval date of construction completion by District staff. Maintenance shall be conducted for a period of five (5) years to ensure that the created/restored area is free from exotic vegetation immediately following a maintenance activity and that exotic and other nuisance species constitute no more than 5% total cover between maintenance activities. At the end of the 5-year monitoring program, the mitigation areas to be planted with red mangroves shall contain an 80% survival of mangroves. The detailed monitoring plan for this site is described in the Plan (Exhibit C) incorporated by reference in this settlement agreement. The Respondent shall perpetually manage the Hawk Missile Site Restoration project to ensure the maintenance of vegetative cover with desirable wetland vegetation and to further ensure that exotic and nuisance vegetation as defined by Florida EPPC does not exceed 5% of the total vegetative cover.

23. In lieu of civil penalties, Respondent shall construct the West Salt Ponds Project and shall maintenance dredge the Riviera Canal. This construction and dredging shall be completed as set forth in the Plan (Exhibit C). The West Salt Ponds Project shall be completed before June 1, 2003. The maintenance dredging of the Riviera Canal shall be completed before May 1, 2009.

24. A monitoring program shall be implemented for the Western Salt Ponds Enhancement Project that shall extend for a period of 5 years with annual reports submitted to District staff. Respondent shall maintain and monitor the hydrologically enhanced wetlands for a period of five (5) years from the approval date of construction completion by District staff. This monitoring program will document tidal flow at and between the inflow points and the Salt Ponds and will compare pre- and post-construction conditions to demonstrate that no adverse erosion or decrease in submerged habitat has occurred as a result of the construction of the improved tidal connections. The detailed monitoring plan for this site is described in the Plan (Exhibit C) incorporated by reference in this settlement agreement.

25. Respondent is authorized to construct the Future Emergency Mitigation Sites identified in the Plan (Exhibit C). However, Respondent shall submit an ERP application for these sites and all other known future storm water working sites (including the Jose Marti and Donald Avenue sites) that require ERPs within 6 months of the effective date of this Consent Agreement. Respondent shall obtain an ERP for these sites within one year of the effective date of this Consent Agreement. Future regular maintenance of these sites will remain exempt from permitting as per Florida Administrative Code Rule 40E-4.051 (2) provided the maintenance dredging of these canals are returned to the original permitted design specifications or to a depth of no more than five (5) feet below mean low water. Provided that the Respondent maintains these canals at a minimum frequency of every five (5) years to ensure the maintenance of the designed conveyance, no additional mitigation (beyond that which is required in this Consent Agreement) will be required.

26. Respondent agrees to maintain the flow-way connecting the Riviera Canal and the West Salt Ponds, at least every five (5) years.

27. In the event the Respondent fails to satisfy the requirements as set forth in paragraphs 20 through 26 above, Respondent agrees to pay to the District \$500.00 for each day of non-compliance, except as provided in paragraph 33 herein. Prior to initiating any action for such non-compliance, the District shall notify the Respondent of the alleged deficiency and permit the Respondent a reasonable time to comply.

28. Respondent shall, upon reasonable notice and during regular working hours, grant District representatives, along with any vehicles and equipment, who present appropriate credentials, access to the premises for the purpose of sampling, photographing, videotaping, monitoring and/or determining compliance with the terms of this Consent Agreement, Chapter 373, Fla. Stat., and/or the Rules of the District.

29. Respondent shall, in settlement of the allegations alleged in this Consent Agreement, pay the District's reasonable investigative costs and attorneys' fees in the amount of five thousand dollars (\$5,000.00) which total amount shall be paid by cashier's check or money order and tendered to the District via U.S. Mail or hand-delivery at the following address: **South Florida Water Management District, 3301 Gun Club Road, Post Office Box 24680, West Palm Beach, FL 33416-4680, Attn: Lisandra Jones, Environmental Resource Regulation Division, Environmental Resource Compliance Department** within thirty (30) days from the date of the effective date of this Consent Agreement. Respondent agrees that these amounts are reasonable and shall not contest them in any subsequent action regarding this Consent Agreement.

30. This Consent Agreement shall not constitute an admission of liability on the Respondent's behalf.

GENERAL PROVISIONS

31. The District hereby expressly reserves the right to petition for judicial enforcement of the terms of this Consent Agreement. In such event, the Respondent and its successors and/or assigns in interest shall not contest or deny any fact, legal conclusion, or any other matter or fact set forth in this Consent Agreement, including the Findings of Fact, Ultimate Facts and Conclusions of Law set forth herein. If the District successfully petitions or sues for enforcement of this Consent Agreement, the Respondent, its heirs, successors and/or assigns hereby agree to and shall pay all attorneys' fees, (including, but not limited to, the fair market value of in house counsel fees, as if performed by outside or private counsel, court costs and any other damages sustained by the District). In addition, the District hereby expressly reserves the right to initiate appropriate legal action to prevent or prohibit the future violation of applicable statutes or the rules promulgated thereunder, or to alleviate an immediate serious danger to the public health, safety or welfare.

32. Failure to comply with this Consent Agreement shall constitute a violation of Chapter 373, Fla. Stat., and enforcement proceedings may be brought in any appropriate administrative or judicial forum.

33. If any event occurs which causes delay or reasonable likelihood of delay, in complying with the requirements or deadlines of this Consent Agreement, the Respondent shall have the burden of proving that the delay was or will be caused by circumstances

beyond the control of the Respondent, nor shall the failure of a contractor, subcontractor, material man, or other agent (collectively referred to as contractor) to whom responsibility for performance is delegated to meet contractually imposed deadlines be a cause beyond the contractor's control. Upon occurrence of an event causing delay, or upon becoming aware of a potential for delay, the Respondent shall notify the District orally within 24 hours or by the next working day and shall, within seven days of oral notification to the District, notify the District in writing of the anticipated length and cause of the delay, the measures taken or to be taking to prevent or minimize the delay, and the timetable by which the Respondent intends to implement these measures. If the parties can agree that the delay or anticipated delay has been or will be caused by circumstance beyond the reasonable control of the Respondent, the time for performance hereunder shall be extended for a period equal to the agreed delay resulting from such circumstances. Such agreement shall adopt all reasonable measures necessary to avoid or minimize delay. Failure of the Respondent to comply with the notice requirements of this paragraph in a timely manner shall constitute a waiver of the Respondent's right to request an extension of time for compliance with the requirements or deadlines in this Consent Agreement.

34. This Consent Agreement shall take effect after adoption by and execution on behalf of the Governing Board of the District, when the Consent Agreement is filed with and acknowledged by the Clerk of the District immediately thereafter, and shall remain in full force and effect until its terms and conditions are completed to the satisfaction of the District. The requirements of this Consent Agreement shall bind and inure to the benefit of the successors and assigns of the Respondent, except as modified by the parties hereto. In addition, prior to any sale, transfer, conveyance or lease of the Property, the

Respondent shall provide a copy of this Consent Agreement to any prospective successor in interest. Additionally, the Respondent shall provide notification to the District of the sale, transfer or conveyance of the Property.

35. Respondent hereby waives the right to request an administrative hearing on the terms of this Consent Agreement under Sections 120.569 and 120.57, Fla. Stat., and its right to appeal this Consent Agreement pursuant to Section 120.68 Fla. Stat.

36. Entry of this Consent Agreement does not relieve the Respondent of the need to comply with all applicable federal, state or local laws, regulation or ordinances, including any District permitting requirements. Also, the Consent Agreement does not give the Respondent the authority to conduct any activities on the Property which are under District jurisdiction without first obtaining District authority.

37. Respondent is fully aware that a violation of the terms of this Consent Agreement may subject the Respondent to judicial imposition of damages, civil penalties up to Ten Thousand Dollars (\$10,000.00) per offense per day, costs and criminal penalties.

38. Persons who are not parties to this Consent Agreement, but whose substantial interests maybe affected by this Consent Agreement, may have a right to petition this Consent Agreement. A notice of rights is attached and incorporated as Exhibit E.

39. This Consent Agreement is a final order from the District, pursuant to Section 120.52(7), F.S., and is final and effective on the date filed with the Clerk of the District unless a petition for administrative hearing is filed in accordance with Chapter 120;

F.S., or any other applicable state law. Upon the timely filing of a petition, the Consent Agreement will not be effective until further order from the District.

ORDER NO. SFWMD 2007 096 CO ERP

DONE AND SO ORDERED at West Palm Beach, Palm Beach County, Florida, this

12TH day of APRIL, 2007.

**SOUTH FLORIDA WATER MANAGEMENT DISTRICT
BY ITS GOVERNING BOARD**

BY: *Terrie Bates*
Terrie Bates, Assistant Deputy Executive Director

ATTEST:

BY: *Jackie McGorty*
Assistant Secretary

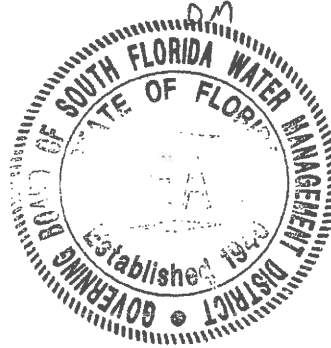

RESPONDENT

BY: *[Signature]*
Authorized Representative
City of Key West

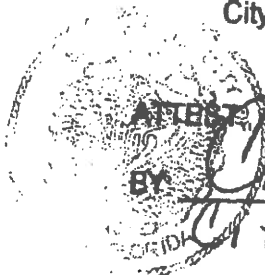

ATTEST:
BY: *Cheryl Smith*
City Clerk



SOUTH FLORIDA WATER MANAGEMENT DISTRICT

3301 Gun Club Road, West Palm Beach, Florida 33406 • (561) 686-8800 • FL WATS 1-800-432-2045 • TDD (561) 697-2574
Mailing Address: P.O. Box 24680, West Palm Beach, FL 33416-4680 • www.sfwmd.gov

CON 24-06-04
6181

July 28, 2006

Mr. Julio Avel, City Manager
City of Key West
525 Angela Street
Key West, Florida 33040

Dear Mr. Avel:

Hand Delivered:

Received by: Irma Borda (Irma Borda)

*Date: August 1, 2006 2:48 PM
+ TIME*

CEASE AND DESIST NOTICE

**Subject: Construction Without a Permit,
Alteration of Wetlands
Dewatering without a Permit
Key West Police Department Mangrove Wetlands
Monroe County
Sec. 31/Twp.68S/Rge.25E**

Recent field inspections by District staff indicate that you have violated Sections 373.413, and 373.4211 Fla. Stat. and Rules 40E-4.041, 40E-2, Fla. Admin. Code, at the above referenced property through the construction of "works" without permit authorization from the South Florida Water Management District. The "works" on this project include, but are not limited to the dredging and removal of mangrove wetlands. Furthermore, District staff observed that you were conducting dewatering without the necessary permit authorization.

You are directed to immediately cease all construction activities in violation of Sections 373.413 and 373.4211 Fla. Stat. and Rule 40E-4.041, Fla. Admin. Code, as described above. The District will seek civil penalties and recovery of staff investigative costs as a result of this violation.

EXHIBIT A

GOVERNING BOARD

Kevin McCarty, Chair
Irela M. Bagué, Vice-Chair
Miya Burt-Stewart

Alice J. Carlson
Michael Collins
Nicolás J. Gutiérrez, Jr., Esq.

Lennart E. Lindahl, P.E.
Harkley R. Thornton
Malcolm S. Wade, Jr.

EXECUTIVE OFFICE

Carol Ann Wehler, Executive Director

Key West Police Department Mangrove Wetlands

July 28, 2006

Page 2

Please be advised that the District is authorized under Section 373.129, **Fla. Stat.**, to seek civil penalties of up to Ten Thousand Dollars (\$10,000.00) per day per offense and to recover costs such as staff investigative time and attorney fees. Furthermore, the District will seek injunctive relief from the court to immediately stop all work should further construction activity occur.

You are directed to respond in writing within seven (7) days of receipt of this correspondence regarding your intentions in this matter. Should you have any questions, please contact me at (561) 682-2153.

Sincerely,

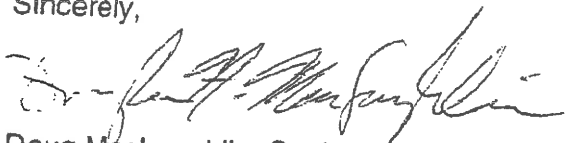

Doug MacLaughlin, Senior Regulatory Supervisor
Environmental Resource Compliance Department

SM

RS/sm

CERTIFIED MAIL NO. 7003 3110 0004 9936 7502

c: Office of Counsel

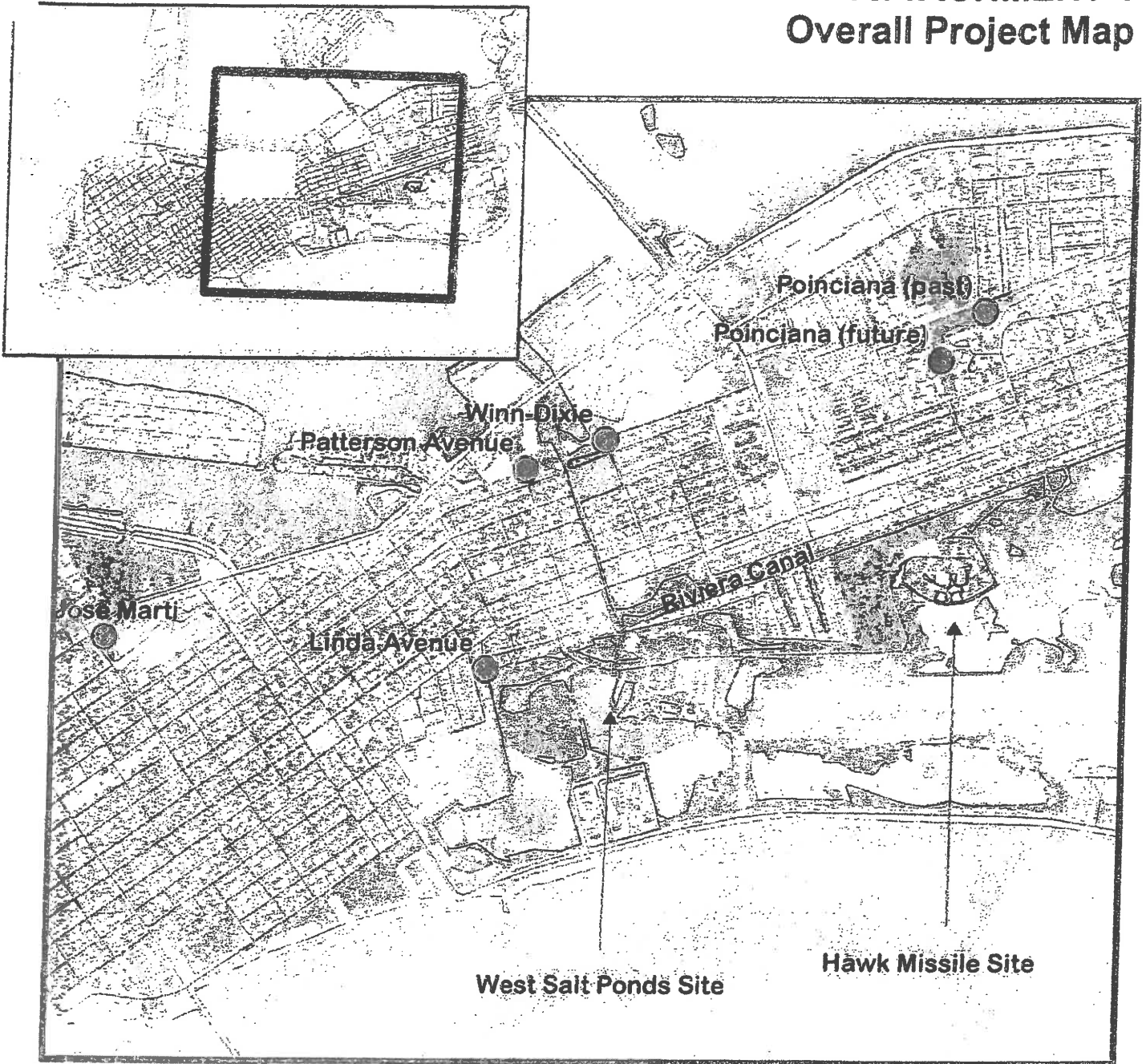

ATTACHMENT 1 Overall Project Map



Source: Monroe county aerial photograph 2003
Adapted by SWC 1/4/07

Legend

Affect Areas

-  Affected Areas
-  Future Emergency Sites
-  West Salt Ponds Project



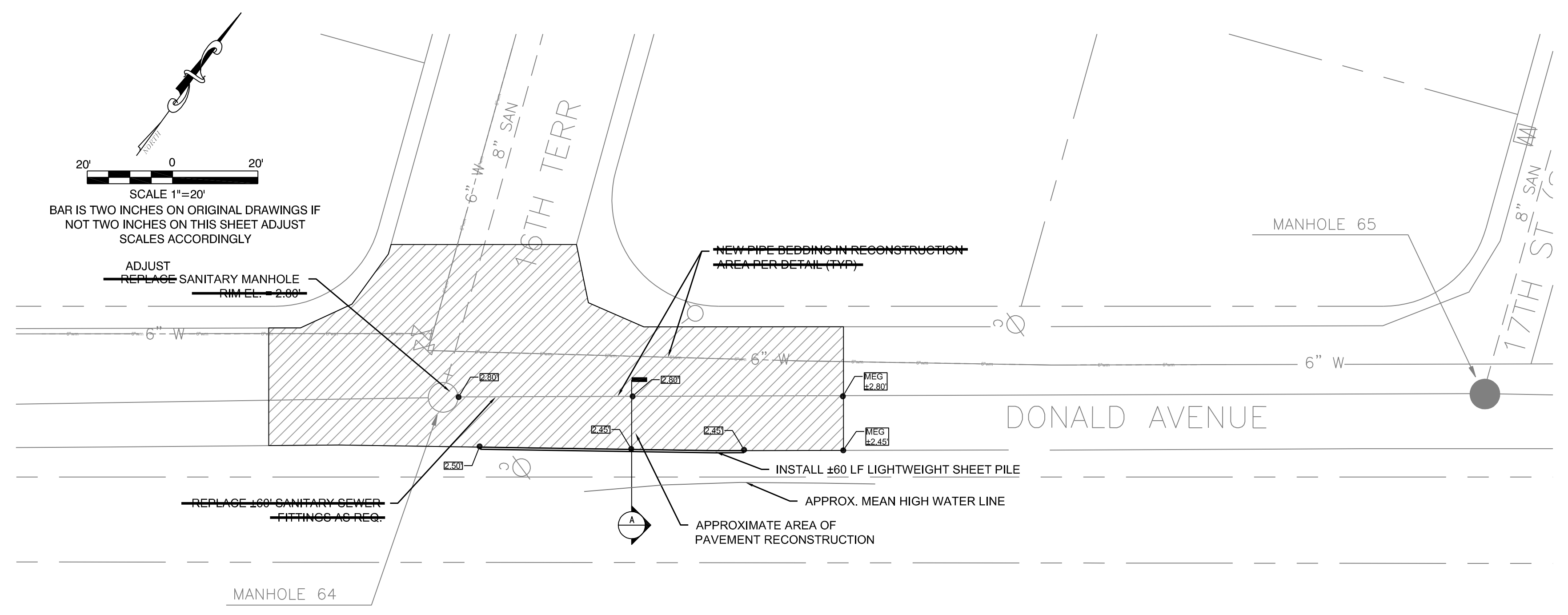

LOCATION MAP
N.T.S.

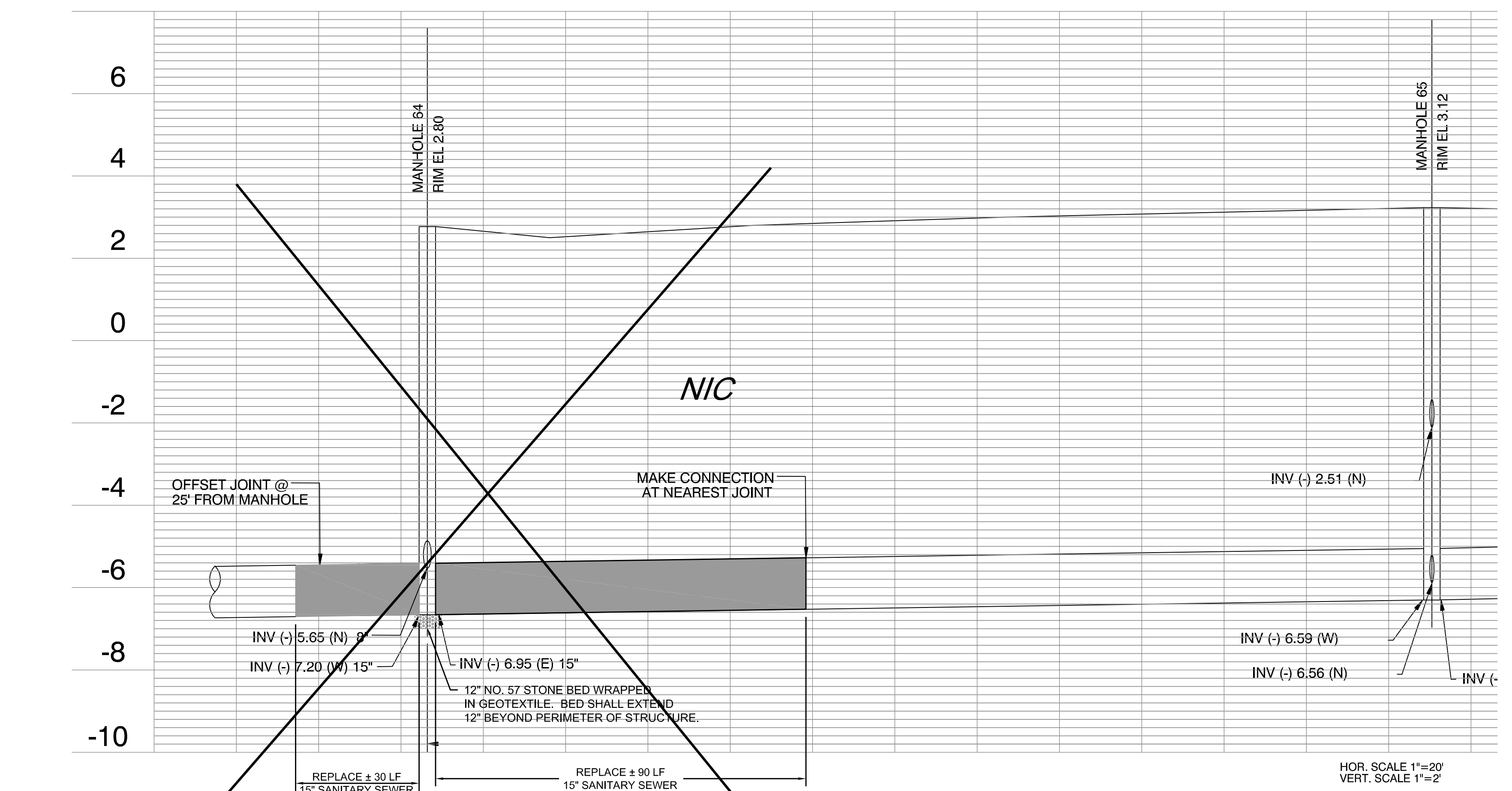

GENERAL NOTES

- THE CONTRACTOR SHALL REVIEW ALL DRAWINGS AND SPECIFICATIONS AND ADVISE THE ENGINEER OF ANY CONFLICTS OF REPRESENTATION BETWEEN DRAWINGS AND/OR SPECIFICATIONS PRIOR TO COMMENCING WITH CONSTRUCTION.
- THE CONTRACTOR SHALL FIELD-VERIFY EXISTING CONDITIONS PRIOR TO PERFORMING ANY WORK UNDER THIS CONTRACT AND NOTIFY THE ENGINEER IN WRITING OF ANY DIFFERENCES BEFORE COMMENCING WITH ANY CONSTRUCTION.
- THE LOCATIONS, SIZES, AND ELEVATIONS OF EXISTING UTILITIES AS SHOWN ARE APPROXIMATE. THE CONTRACTOR SHALL COORDINATE WITH THE ENGINEER TO OBTAIN ANY AVAILABLE RECORD DRAWINGS AND SHALL DETERMINE THE EXACT LOCATION AND ELEVATION IN THE FIELD. THE CONTRACTOR SHALL ANTICIPATE THAT SCANNING AND EXCAVATION USING LIGHT EQUIPMENT AND HAND METHODS WILL BE NECESSARY IN AREAS NEAR EXISTING UTILITIES AND STRUCTURES TO AVOID DAMAGING THESE FACILITIES. THE CONTRACTOR SHALL CONTACT BELLSOUTH, THE LOCAL TELEPHONE COMPANY AND COMCAST, THE LOCAL CABLE TV PROVIDER TO VERIFY THE LOCATION OF BURIED TELEPHONE AND CABLE TV UTILITIES. NONE HAVE BEEN INDICATED ON THE DRAWINGS. CALL 1-800-432-4770 BEFORE DIGGING OR TRENCHING OPERATIONS BEGIN. CONTRACTOR SHALL ALSO CONTACT CITY OF KEY LARGO / MONROE COUNTY PUBLIC WORKS OFFICE TO LOCATE SECONDARY ELECTRIC LINES.
- THE CONTRACTOR SHALL DETERMINE THE EXACT LOCATION AND ELEVATION IN THE FIELD PRIOR TO INSTALLING ANY NEW WORK THAT CROSSES OR CONNECTS TO EXISTING UTILITY SYSTEMS. LOCATIONS OF NEW UTILITIES SHALL BE ADJUSTED IN A MANNER APPROVED BY THE ENGINEER TO AVOID CONFLICTS. DAMAGES TO UTILITIES RESULTING FROM THE CONTRACTOR'S OPERATIONS SHALL BE REPAIRED BY THE CONTRACTOR AT NO COST TO THE CLIENT.
- ALL EXCAVATION, TRENCHING, SHEETING, SHORING AND BRACING SHALL BE INSTALLED AS REQUIRED IN ACCORDANCE WITH LOCAL, STATE, AND FEDERAL REGULATIONS, INCLUDING OSHA (29 CFR 1926).
- ALL ITEMS INDICATED TO BE REMOVED OR DEMOLISHED SHALL BE REVIEWED WITH THE DEVELOPER TO DETERMINE IF THE ITEM IS TO BE PROPERTY OF THE CONTRACTOR. ALL ITEMS SHALL BE REMOVED AND DISPOSED OF IN ACCORDANCE WITH ALL LOCAL, STATE, AND FEDERAL REGULATIONS, UNLESS OTHERWISE NOTED. NO SALVAGE VALUE IS EXPRESSED OR IMPLIED BY THESE CONTRACT DOCUMENTS FOR ANY ITEMS TO BE REMOVED OR DEMOLISHED.
- THE CONTRACTOR SHALL BE RESPONSIBLE FOR THE SECURITY OF THE CONTRACTOR'S EQUIPMENT, MATERIALS, AND PERSONNEL, AND SHALL PROVIDE ADEQUATE BARRIERS TO PREVENT RISK TO OTHERS FROM THE CONTRACTOR'S ACTIVITIES.
- WHERE ACTUAL DIMENSIONS AND SIZES ARE PROVIDED IN THE DRAWINGS, THEY SHALL TAKE PRECEDENCE OVER SCALED DIMENSIONS. LARGE SCALE DRAWINGS SHALL TAKE PRECEDENCE OVER SMALL SCALE DRAWINGS.
- THE CONTRACTOR SHALL SEQUENCE HIS OPERATIONS SUCH THAT ORANGE MESH SAFETY FENCING IS PROVIDED ALONG ALL AREAS BEING TRENCHED AND NO TRENCH IS LEFT OPEN AT THE END OF THE WORK DAY.
- NO CONNECTIONS FOR THE PURPOSE OF OBTAINING WATER SUPPLY DURING CONSTRUCTION SHALL BE MADE TO ANY FIRE HYDRANT OR BLOW-OFF STRUCTURE WITH OUT FIRST OBTAINING A CONSTRUCTION METER FROM THE FLORIDA KEYS AQUEDUCT AUTHORITY.
- IF UNSATISFACTORY MATERIAL FOR ADEQUATE BEARING IS ENCOUNTERED AT THE NORMAL SUBGRADE, THE UNSATISFACTORY MATERIAL SHALL BE REMOVED AND REPLACED WITH SUITABLE FOUNDATION STABILIZATION MATERIAL AS SPECIFIED.
- IN GENERAL, EXISTING STRUCTURES AND UTILITIES ARE NOTED AS EXISTING AND/OR SHOWN IN LIGHT LINE WEIGHT. NEW CONSTRUCTION IS SHOWN IN HEAVY LINE WEIGHT.
- BASE MAP INFORMATION WAS COMPILED FROM CITY OF KEY WEST AS-BUILT DRAWINGS.
- ALL FIELD LAYOUT AND SURVEYING FOR CONSTRUCTION OF THIS PROJECT SHALL BE PROVIDED BY THE CONTRACTOR AT HIS EXPENSE, UNDER THE DIRECTION OF A FLORIDA LICENSED PROFESSIONAL LAND SURVEYOR.

NEW CONSTRUCTION NOTES

- IT IS THE CONTRACTOR'S RESPONSIBILITY DURING CONSTRUCTION OF NEW UTILITIES TO ANTICIPATE AND PLAN FOR CROSSINGS OF NEW AND EXISTING UTILITIES AND SUBSURFACE FEATURES.
 - ALL SANITARY SEWER LINES SHALL BE CONSTRUCTED TO GRADES AS INDICATED.
 - IF ANY GRAY UTILITIES ARE DISCOVERED TO CONFLICT WITH GRADES FOR NEW SANITARY SEWER LINES, SHALL BE IMMEDIATELY BROUGHT TO THE ATTENTION OF THE ENGINEER. POSSIBLE SOLUTIONS FOR HORIZONTAL AND VERTICAL ADJUSTMENT.
 - POTABLE WATER LINES, ELECTRICAL, COMMUNICATIONS, AND CABLE TV DISTRIBUTION SHALL REQUIRE RELOCATION AS NECESSARY TO ACCOMMODATE NEW SANITARY SEWER LINES. THE CONTRACTOR SHALL REFER TO THE CONSTRUCTION DRAWINGS AND SPECIFICATIONS FOR SEPARATION REQUIREMENTS BETWEEN INDIVIDUAL UTILITIES. BOTH HORIZONTAL AND THE VERTICAL SEPARATION REQUIREMENTS SHALL BE MAINTAINED IN THE VERTICALLY, AND SPECIAL TREATMENT REQUIREMENTS FOR UTILITY INSTALLATION, INCLUDING ADJUSTMENTS OF EXISTING UTILITIES.
- THE CONTRACTOR SHALL ASSUME ADJUSTMENTS OF EXISTING UTILITIES WILL BE REQUIRED AT ALL UTILITY CROSSINGS SHOWN ON THE DRAWINGS, INCLUDING ALL UTILITIES OF UNKNOWN DEPTH INDICATED IN THE PROFILES. THIS INCLUDES LABOR, EQUIPMENT, AND MATERIALS, INCLUDING FITTINGS AND APPURTENANCES.
- WHERE NEW SANITARY SEWER MAINS ARE PLACED CLOSER THAN 6- FEET HORIZONTALLY TO AN EXISTING WATER MAIN, THE CONTRACTOR SHALL ENCASE (SURROUND) THE SANITARY SEWER MAIN IN 6-INCHES OF CONCRETE.
- PROVIDE CONTRACTION JOINTS AT 12' O.C. MAX. JOINT PATTERNS IN PAVEMENTS AND SIDEWALKS SHALL BE GENERALLY SQUARE. AT CURBS PROVIDE FULL DEPTH EXPANSION JOINTS AT 10' FT. O.C. MAX. AND AT LOCATIONS WHERE STRAIGHT CURBS CHANGE DIRECTIONS. AT SIDEWALKS PROVIDE WEAKENED PLANE CONTRACTION JOINTS NOT MORE THAN 5'-0" MAX. AND EXPANSION JOINTS AT 20'-FT. O.C. MAX (TOOL ALL EDGES). INSTALL SELF-LEVELING SEALANT AT ALL ISOLATION/EXPANSION JOINTS.

NIC - NOT IN CONTRACT

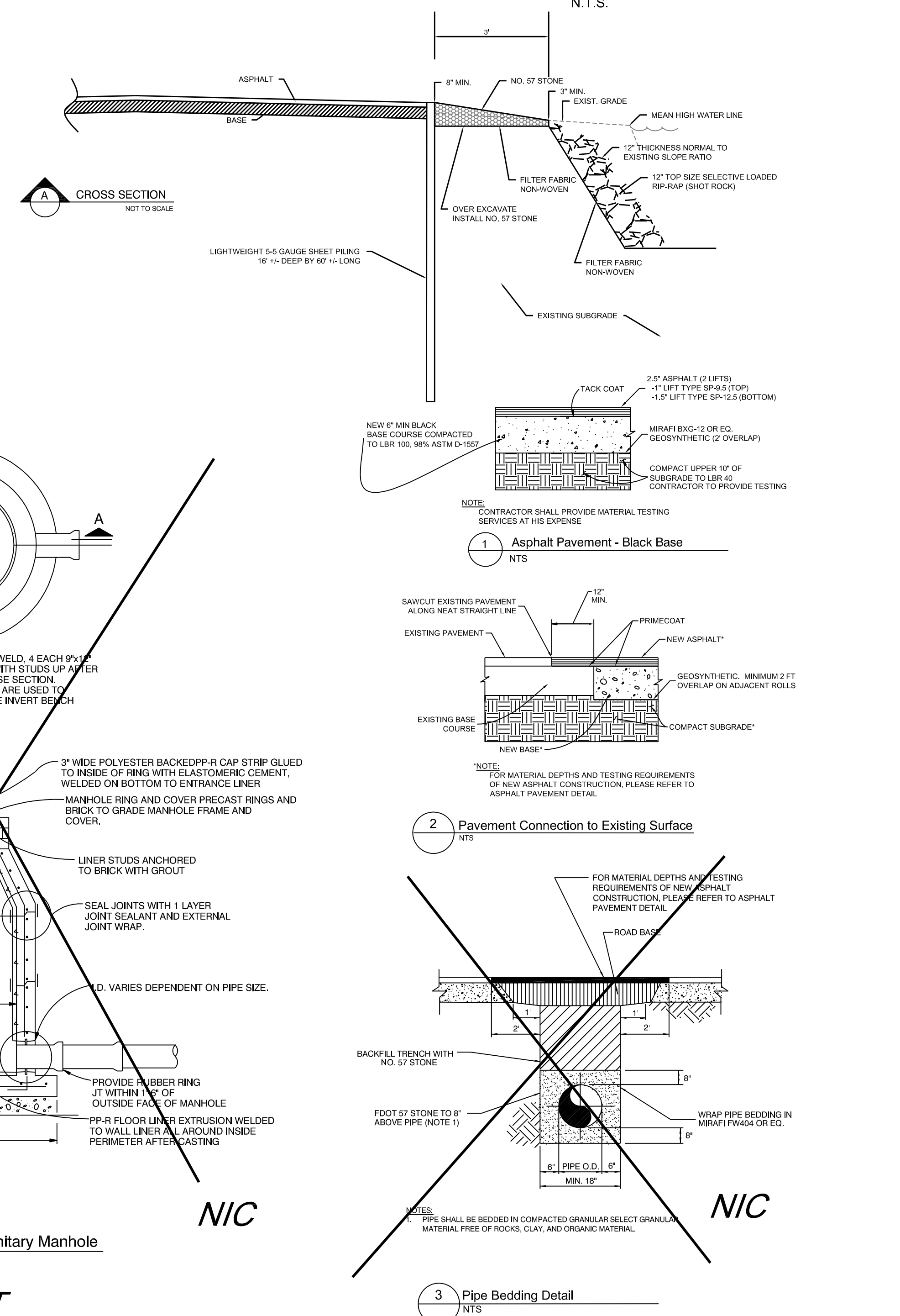

CIVIL ENGINEERING • REGULATORY PERMITTING • CONSTRUCTION MANAGEMENT

PEREZ ENGINEERING & DEVELOPMENT, INC.

KEY WEST OFFICE
1010 EAST KENNEDY DRIVE, SUITE 201
KEY WEST, FLORIDA 33040
TEL: (305) 239-5440 FAX: (305) 239-0243

ALLEN E. PEREZ, P.E.
Florida P.E. NO. 51468
March 16, 2015

ORIGINAL: APRIL 2014

REVISIONS:

1	
2	
3	
4	
5	
6	

PAVEMENT RECONSTRUCTION
16TH STREET & DONALD AVENUE
KEY WEST, FL 33040

CITY OF KEY WEST
P.O. BOX 1408
KEY WEST, FL 33041

JOB NO. 141019
DRAWN BGO
DESIGNED AEP
CHECKED AEP
QC
SHEET C-1