

CONTRACT DOCUMENTS FOR:

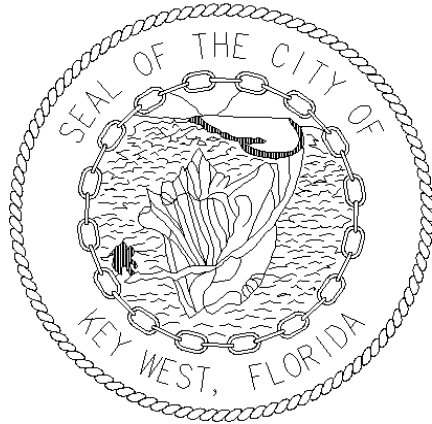

ITB # 17-023
EFFLUENT PUMP FP-3-1 CONTROL
AND VFD REPLACEMENT
PROJECT #SE35031701

September 2018

MAYOR: CRAIG CATES

COMMISSIONERS:

RICHARD PAYNE

BILLY WARDLOW

JIMMY WEEKLEY

CLAYTON LOPEZ

SAM KAUFMAN

MARGARET ROMERO

PREPARED BY:
City Of Key West
Engineering Services

TABLE OF CONTENTS

		<u>Pages</u>
<u>PART 1—BIDDING REQUIREMENTS</u>		
00 41 13	Proposal.....	1- 8
00 43 16	Anti-Kickback Affidavit	1- 1
00 43 17	Florida Statues, on Public Entity Crimes	1- 3
00 43 18	Indemnification	1- 1
00 43 19	Equal Benefits for Domestic Partnership Affidavit	1- 1
00 43 22	Local Vendor Certification	1- 2
 <u>PART 2—CONTRACTING REQUIREMENTS</u>		
<u>CONTRACTING FORMS</u>		
00 52 13	Contract.....	1- 2
 <u>PROJECT FORMS</u>		
00 61 13.13	Florida Performance Bond	1- 3
00 61 13.16	Florida Payment Bond	1- 2
 <u>CONDITIONS OF THE CONTRACT</u>		
00 72 00	General Conditions	1- 18
00 73 00	Supplementary Conditions.....	1- 10
 <u>PART 3—SPECIFICATIONS</u>		
<u>DIVISION 1—GENERAL REQUIREMENTS</u>		
01 01 00	General Requirements.....	1- 7
01 11 00	Scope of Work	1- 2
01 29 00	Payment Procedures.....	1- 3
01 31 19	Project Meetings	1- 2
01 32 00	Progress Schedules.....	1- 6
01 33 00	Submittals	1- 9
	Supplement 1, Transmittal of Contractor's Submittal.....	1- 1
01 42 13	Abbreviations	1- 3
01 43 33	Manufacturers' Field Services	1- 4
	Supplement 1, Manufacturer's Certificate of Compliance	1- 1
	Supplement 2, Manufacturer's Certificate of Proper Installation.....	1- 1
01 50 00	Construction Facilities and Temporary Controls.....	1- 3
01 61 00	Common Product Requirements	1- 6
01 77 00	Contract Closeout.....	1- 3
01 78 23	Operation and Maintenance Data.....	1- 7
	Supplement 1, Maintenance Summary Form.....	1- 2

Pages

01 91 14	Equipment Testing and Facility Startup	1-	5
	Supplement 1, Unit Process Startup Form	1-	1
	Supplement 2, Facility Performance Demonstration/ Certification Form.....	1-	1

DIVISIONS 2 THROUGH 25 (NOT USED)

DIVISION 26—ELECTRICAL

26 05 01	Electrical	1-	30
	Supplement 1, Figure 1: Example Arc Flash Label	1-	1
26 08 00	Commissioning of Electrical Systems	1-	13
26 29 23	Variable-Frequency Motor Controller Installation	1-	4

DIVISIONS 27 THROUGH 39 (NOT USED)

DIVISION 40— PROCESS INTEGRATION

40 90 01	Instrumentation and Control for Process Systems	1-	38
	Supplement 1, Loop Specifications	1-	10
	Supplement 2, I/O List.....	1-	2
	Supplement 3, PLC and Network Components List.....	1-	1
	Supplement 4, Control Panel Schedule.....	1-	1
	Supplement 5, Instrument Calibration Sheet	1-	2
	Supplement 6, Performance Acceptance Test Sheet.....	1-	2

DIVISIONS 41 THROUGH 49 (NOT USED)

PART 4—DRAWINGS

001-G-001	GENERAL ABBREVIATIONS
001-G-002	ELECTRICAL LEGEND 1 OF 2
001-G-003	ELECTRICAL LEGEND 2 OF 2
001-G-004	INSTRUMENTATION & CONTROLS LEGEND 1 OF 2
001-G-005	INSTRUMENTATION & CONTROLS LEGEND 2 OF 2
005-E-201	ELECTRICAL SITE PLAN AND DUCT BANK SECTION
008-N-601	INSTRUMENTATION AND CONTROLS P&ID EFFLUENT PUMPS
008-N-602	INSTRUMENTATION AND CONTROLS BLOCK DIAGRAM
010-E-201	ELECTRICAL OPERATIONS BUILDING DEMOLITION, PARTIAL AND ENLARGED FLOOR PLAN
010-E-501	ELECTRICAL CONTROL DIAGRAMS
010-E-502	ELECTRICAL RISER DIAGRAM

END OF SECTION

PART 1

BIDDING REQUIREMENTS

NOTE TO BIDDER: Use preferably BLACK ink for completing this Proposal form.

PROPOSAL

To: The City of Key West
Address: 1300 White Street, Key West, Florida 33040
Project Title: EFFLUENT PUMP FP-3-1 CONTROL AND VFD REPLACEMENT

Bidder's contact person for additional information on this Proposal:

Company Name: _____

Contact Name & Telephone #: _____

Email Address: _____

BIDDER'S DECLARATION AND UNDERSTANDING

The undersigned, hereinafter called the Bidder, declares that the only persons or parties interested in this Proposal are those named herein, that this Proposal is, in all respects, fair and without fraud, that it is made without collusion with any official of the Owner, and that the Proposal is made without any connection or collusion with any person submitting another Proposal on this Contract.

The Bidder further declares that he has carefully examined the Contract Documents for the construction of the project, that he has personally inspected the site, that he has satisfied himself as to the quantities involved, including materials and equipment, and conditions of work involved, including the fact that the description of the quantities of work and materials, as included herein, is brief and is intended only to indicate the general nature of the work and to identify the said quantities with the detailed requirements of the Contract Documents, and that this Proposal is made according to the provisions and under the terms of the Contract Documents, which Documents are hereby made a part of this Proposal.

CONTRACT EXECUTION AND BONDS

The Bidder agrees that if this Proposal is accepted, he will, within 10 days, not including Sundays and legal holidays, after Notice of Award, sign the Contract in the form annexed hereto, and will at that time, deliver to the Owner examples of the Performance Bond and Payment Bond required herein, and evidence of holding required licenses and certificates, and will, to the extent of his Proposal, furnish all machinery, tools, apparatus, and other means of construction and do the work and furnish all the materials necessary to complete all work as specified or indicated in the Contract Documents.

START OF CONSTRUCTION AND CONTRACT COMPLETION TIME

The Bidder further agrees to begin work within 14 calendar days after the date of the Notice to Proceed and to complete the project, in all respects within 180 calendar days after the date of the Notice to Proceed.

LIQUIDATED DAMAGES

In the event the Bidder is awarded the Contract and shall fail to complete the work within the time limit or extended time limit agreed upon, as more particularly set forth in the Contract Documents, liquidated damages shall be paid to the Owner at the rate of \$3,000.00 per day for all work awarded until the work has been satisfactorily completed as provided by the Contract Documents. Sundays and legal holidays shall be excluded in determining days in default.

ADDENDA

The Bidder hereby acknowledges that he has received Addenda No's. _____, _____, _____, _____, _____, _____, _____, _____, _____, _____, _____, _____ (Bidder shall insert No. of each Addendum received) and agrees that all addenda issued are hereby made part of the Contract Documents, and the Bidder further agrees that his Proposal(s) includes all impacts resulting from said addenda.

SALES AND USE TAXES

The Bidder agrees that all federal, state, and local sales and use taxes are included in the stated bid prices for the work.

LUMP SUM ITEMS

The Bidder further proposes to accept as full payment for the work proposed herein the amounts computed under the provisions of the Contract Documents and based on the following lump sum amounts. The Bidder agrees that the lump sum represent a true measure of the labor and materials required to perform the work, including all allowances for overhead and profit for each type and unit of work called for in these Contract Documents. Bidders shall include in their lump sum bid the cost to provide Builder's Risk insurance in accordance with 34.E. of the General Conditions including payment of any deductible.

APPROVED PROCESS INSTRUMENTATION CONTROL CONTRACTOR

The Bidder acknowledges that the PIC Contractors listed below are the only PIC Contractors approved for work under this Contract:

1. C & C Controls
2. Newport Integration
3. HTS Controls

BASE BID

1. **Mobilization and Demobilization** (In no case shall the amount bid for this item exceed 5% of the Total Base Bid Amount. Should the amount entered for this item exceed 5%, Owner will reduce it to the maximum allowed amount to determine the correct Total Base Bid amount.)

1 LS \$ _____

2. **Effluent Pump FP-3-1 Control**

1 LS \$ _____

3. **VFD Installation**

1 LS \$ _____

4. **Unforeseen Conditions Allowance** (only to be used with Owner’s written directive, Building Permit and Art in Public Places Fees to be paid for through allowance)

1 LS \$30,000.00 _____

TOTAL OF BASE BID ITEMS 1 THROUGH 4 LISTED ABOVE:

Total of Base Bid Lump Sum Items 1 - 4 \$ _____

_____ Dollars & _____ Cents
(amount written in words)

PROPOSAL CONTINUES ON NEXT PAGE

The Bidder shall submit a Schedule of Values with the Proposal. Schedule of Values shall be broken down by bid items listed in the draft AIA 702 Continuation Sheet in PART 8 of the PROJECT MANUAL and will be used as a basis for payment.

Contractor is responsible for providing a dollar amount for each item listed on the Schedule of Values and that total shall match the amount on the Proposal Lump Sum. The Bidder will be considered non-responsive if Schedule of Values is not complete and or not included in Bid Package.

Payment for materials and equipment authorized by the Owner in a written Change Order but not listed in the above Proposal will be provided at the suppliers invoice plus 10 %.

List items to be performed by CONTRACTOR's own forces and the estimated percent of the Total Lump Sum Base Bid.

(Use additional sheets if necessary.)

SUBCONTRACTORS

The Bidder further proposes that the following subcontracting firms or businesses will be awarded subcontracts for the following portions of the work in the event that the Bidder is awarded the Contract:

Name

Trade	Percent of Total Base Bid
-------	---------------------------

Street	City	State	Zip
--------	------	-------	-----

Name

Trade	Percent of Total Base Bid
-------	---------------------------

Street	City	State	Zip
--------	------	-------	-----

Name

Trade	Percent of Total Base Bid
-------	---------------------------

Street	City	State	Zip
--------	------	-------	-----

Name

Trade	Percent of Total Base Bid
-------	---------------------------

Street	City	State	Zip
--------	------	-------	-----

Name

Trade	Percent of Total Base Bid
-------	---------------------------

Street	City	State	Zip
--------	------	-------	-----

SURETY

_____ whose address is

_____, _____, _____, _____
Street City State Zip

BIDDER

The name of the Bidder submitting this Proposal is

_____ doing business at

_____, _____, _____, _____
Street City State Zip

which is the address to which all communications concerned with this Proposal and with the Contract shall be sent.

The names of the principal officers of the corporation submitting this Proposal, or of the partnership, or of all persons interested in this Proposal as principals are as follows:

_____	_____
_____	_____
_____	_____
_____	_____
_____	_____

If Sole Proprietor or Partnership

IN WITNESS hereto the undersigned has set his (its) hand this _____ day of _____ 2018.

Signature of Bidder

Title

If Corporation

IN WITNESS WHEREOF the undersigned corporation has caused this instrument to be executed and its seal affixed by its duly authorized officers this _____ day of _____ 2018.

(SEAL)

Name of Corporation

By _____

Title _____

Attest _____

SWORN STATEMENT UNDER SECTION 287.133(3)(A)
FLORIDA STATUTES, ON PUBLIC ENTITY CRIMES

THIS FORM MUST BE SIGNED IN THE PRESENCE OF A NOTARY PUBLIC OR OTHER OFFICER AUTHORIZED TO ADMINISTER OATHS.

1. This sworn statement is submitted with Bid or Proposal for _____

2. This sworn statement is submitted by _____
(name of entity submitting sworn statement)

whose business address is _____

and (if applicable) its Federal Employer Identification Number (FEIN) is _____

(If the entity has no FEIN, include the Social Security Number of the individual signing this sworn statement _____

3. My name is _____
(please print name of individual signing)

and my relationship to the entity named above is _____

4. I understand that a “public entity crime” as defined in Paragraph 287.133(1)(g), Florida Statutes, means a violation of any state or federal law by a person with respect to and directly related to the transaction of business with any public entity or with an agency or political subdivision of any other state or with the United States, including but not limited to, any bid or contract for goods or services to be provided to any public or an agency or political subdivision of any other state or of the United States and involving antitrust, fraud, theft, bribery, collusion, racketeering, conspiracy, material misrepresentation.

5. I understand that “convicted” or “conviction” as defined in Paragraph 287.133(1)(b), Florida Statutes, means a finding of guilt or a conviction of a public entity crime, with or without an adjudication guilt, in any federal or state trial court of record relating to charges brought by indictment information after July 1, 1989, as a result of a jury verdict, nonjury trial, or entry of a plea of guilty or nolo contendere.

6. I understand that an “affiliate” as defined in Paragraph 287.133(1)(a), Florida Statutes, means
- a. A predecessor or successor of a person convicted of a public entity crime; or
 - b. An entity under the control of any natural person who is active in the management of the entity and who has been convicted of a public entity crime. The term “affiliate” includes those officers, directors, executives, partners, shareholders, employees, members, and agents who are active in the management of an affiliate. The ownership by one person of shares constituting controlling interest in another person, or a pooling of equipment or income among persons when not for fair market value under an arm’s length agreement, shall be a prima facie case that one person controls another person. A person who knowingly enters into a joint venture with a person who has been convicted of a public entity crime in Florida during the preceding 36 months shall be considered an affiliate.
7. I understand that a “person” as defined in Paragraph 287.133(1)(8), Florida Statutes, means any natural person or entity organized under the laws of any state or of the United States with the legal power to enter into a binding contract and which bids or applies to bid on contracts for the provision of goods or services let by a public entity, or which otherwise transacts or applies to transact business with public entity. The term “person” includes those officers, directors, executives, partners, shareholders, employees, members, and agents who are active in management of an entity.
8. Based on information and belief, the statement which I have marked below is true in relation to the entity submitting this sworn statement. (Please indicate which statement applies).

____ Neither the entity submitting this sworn statement, nor any officers, directors, executives, partners, shareholders, employees, members, or agents who are active in management of the entity, nor any affiliate of the entity have been charged with and convicted of a public entity crime subsequent to July 1, 1989, AND (Please indicate which additional statement applies.)

____ There has been a proceeding concerning the conviction before a hearing of the State of Florida, Division of Administrative Hearings. The final order entered by the hearing officer did not place the person or affiliate on the convicted vendor list. (Please attach a copy of the final order.)

____ The person or affiliate was placed on the convicted vendor list. There has been a subsequent proceeding before a hearing officer of the State of

Florida, Division of Administrative Hearings. The final order entered by the hearing officer determined that it was in the public interest to remove the person or affiliate from the convicted vendor list. (Please attach a copy of the final order.)

_____The person or affiliate has not been put on the convicted vendor list. (Please describe any action taken by or pending with the Department of General Services.)

(signature)

(date)

STATE OF _____

COUNTY OF _____

PERSONALLY APPEARED BEFORE ME, the undersigned authority,

_____ who, after first being sworn by me, affixed his/her
(name of individual signing)

signature in the space provided above on this _____ day of _____, 2018.

My commission expires:

NOTARY PUBLIC

INDEMNIFICATION

To the fullest extent permitted by law, the CONTRACTOR expressly agrees to indemnify and hold harmless the City of Key West, their officers, directors, agents, and employees (herein called the "indemnitees") from liabilities, damages, losses and costs, including, but not limited to, reasonable attorney's fees and court costs, such legal expenses to include costs incurred in establishing the indemnification and other rights agreed to in this Paragraph, to persons or property, to the extent caused by the negligence, recklessness, or intentional wrongful misconduct of the CONTRACTOR, its Subcontractors or persons employed or utilized by them in the performance of the Contract. Claims by indemnitees for indemnification shall be limited to the amount of CONTRACTOR's insurance or \$1 million per occurrence, whichever is greater. The parties acknowledge that the amount of the indemnity required hereunder bears a reasonable commercial relationship to the Contract and it is part of the project specifications or the bid documents, if any.

The indemnification obligations under the Contract shall not be restricted in any way by any limitation on the amount or type of damages, compensation, or benefits payable by or for the CONTRACTOR under workers' compensation acts, disability benefits acts, or other employee benefits acts, and shall extend to and include any actions brought by or in the name of any employee of the CONTRACTOR or of any third party to whom CONTRACTOR may subcontract a part or all of the Work. This indemnification shall continue beyond the date of completion of the work.

CONTRACTOR: _____

SEAL:

Address

Signature

Print Name

Title

Date

EQUAL BENEFITS FOR DOMESTIC PARTNERS AFFIDAVIT

STATE OF _____)
: SS
COUNTY OF _____)

I, the undersigned, hereby duly sworn, depose and say that the firm of _____ provides benefits to domestic partners of its employees on the same basis as it provides benefits to employees' spouses per City of Key West Ordinance Sec. 2-799.

By:

Sworn and subscribed before me this _____ day of _____, 2018.

NOTARY PUBLIC, State of _____ at Large

My Commission Expires: _____

LOCAL VENDOR CERTIFICATION PURSUANT TO CKW ORDINANCE 09-22
SECTION 2-798

The undersigned, as a duly authorized representative of the vendor listed herein, certifies to the best of his/her knowledge and belief, that the vendor meets the definition of a "Local Business." For purposes of this section, "local business" shall mean a business which:

- a. Principle address as registered with the FL Department of State located within 30 miles of the boundaries of the city, listed with the chief licensing official as having a business tax receipt with its principle address within 30 miles of the boundaries of the city for at least one year immediately prior to the issuance of the solicitation.
- b. Maintains a workforce of at least 50 percent of its employees from the city or within 30 miles of its boundaries.
- c. Having paid all current license taxes and any other fees due the city at least 24 hours prior to the publication of the call for bids or request for proposals.
 - Not a local vendor pursuant to Ordinance 09-22 Section 2-798
 - Qualifies as a local vendor pursuant to Ordinance 09-22 Section 2-798

If you qualify, please complete the following in support of the self-certification & submit copies of your County and City business licenses. Failure to provide the information requested will result in denial of certification as a local business.

Business Name _____ Phone: _____

Current Local Address: _____ Fax: _____
(P.O. Box numbers may not be used to establish status)

Length of time at this address: _____ Date: _____

Signature of Authorized Representative

STATE OF _____ COUNTY OF _____

691623A.GN1

The foregoing instrument was acknowledged before me this ____ day of _____, 2018.

By _____, of _____
(Name of officer or agent, title of officer or agent) (Name of corporation acknowledging)

or has produced identification _____ as identification
(Type of identification)

Return Completed form with Supporting documents to: City of Key West Purchasing

Signature of Notary

Print, Type or Stamp Name of Notary

Title or Rank

PART 2

CONTRACTING REQUIREMENTS

CONTRACT

This Contract made and entered into this _____ day of _____ 2018,

by and between the City of Key West, hereinafter called the "Owner", and _____

_____ hereinafter called the "Contractor";

WITNESSETH:

The Contractor, in consideration of the sum to be paid him by the Owner and of the covenants and agreements herein contained, hereby agrees at his own proper cost and expense to do all the work and furnish all the materials (VFD Owner furnished), tools, labor, and all appliances, machinery, and appurtenances for ITB #17-023 EFFLUENT PUMP FP-3-1 CONTROL AND VFD REPLACEMENT, Key West, Florida to the extent of the Proposal made by the Contractor, dated the _____ day of _____ 2018, all in full compliance with the Contract Documents referred to herein.

The CONTRACT DOCUMENTS, including the signed copy of the PROPOSAL, CONTRACT FORMS, PERFORMANCE & PAYMENT BONDS AND SCOPE OF WORK.

In consideration of the performance of the work as set forth in these Contract Documents, the Owner agrees to pay to the Contractor the amount bid in the Proposal as adjusted in accordance with the Contract Documents, or as otherwise herein provided, and to make such payments in the manner and at the times provided in the Contract Documents.

The Contractor agrees to complete the work within one hundred fifty (180) days and to accept as full payment hereunder the amounts computed as determined by the Contract Documents and based on the said BID.

The Contractor agrees to remedy all defects appearing in the work or developing in the materials furnished and the workmanship performed under this Contract during the warranty period after the date of final acceptance of the work by the Owner, and further agrees to indemnify and save the Owner harmless from any costs encountered in remedying such defects.

It is agreed that the Contract, based upon the BID, shall be fully complete within the stated number of consecutive calendar days from the date the Notice to Proceed is issued.

In the event the Contractor fails to complete the work within the time limit or extended time limit agreed upon, as more particularly set forth in the Contract Documents, liquidated damages shall be paid at a rate of \$3,000.00 per day. Sundays and legal holidays shall be included in determining days in default.

691623A.GN1

This contract will automatically expire upon completion of the project. Contractors warranty obligations remain in effect.

IN WITNESS WHEREOF, we, the parties hereto, each herewith subscribe the same this

_____ day of _____, A.D., 2018.

CITY OF KEY WEST

By _____ Attest _____

Title _____

CONTRACTOR

By _____ Attest _____

Title _____

(Seal)

APPROVED AS TO FORM

Attorney for Owner

* * * *

FLORIDA PERFORMANCE BOND

BOND NO. _____

AMOUNT: \$ _____

KNOW ALL MEN BY THESE PRESENTS, that in accordance with Florida Statutes Section 255.05 _____

with offices at _____ hereinafter called the CONTRACTOR (Principal), and

_____ with offices at _____ a corporation duly organized and existing under and by virtue of the laws of the State of Florida, hereinafter called the SURETY, and authorized to transact business within the State of Florida, as SURETY, are held and firmly bound unto the **CITY OF KEY WEST**, hereinafter called the CITY (Obligee), in the sum of:

_____ DOLLARS (\$ _____), lawful money of the United States of America, for the payment of which, well and truly be made to the CITY, the CONTRACTOR and the SURETY bind themselves and each of their heirs, executors, administrators, successors, and assigns, jointly and severally, firmly by these presents as follows:

THE CONDITION OF THE ABOVE OBLIGATION IS SUCH THAT:

WHEREAS, the CONTRACTOR has executed and entered into a certain Contract for **ITB #17-023 Effluent Pump FP-3-1 Control and VFD Replacement** attached hereto, with the CITY, dated _____, 2018, to furnish at his own cost, charges, and expense all the necessary materials, equipment, and/or labor in strict and express accordance with said Contract and the Contract Documents as defined therein, all of which is made a part of said Contract by certain terms and conditions in said Contract more particularly mentioned, which Contract, consisting of the various Contract Documents is made a part of this Bond as fully and completely as if said Contract Documents were set forth herein;

NOW THEREFORE, the conditions of this obligation are such that if the above bounden CONTRACTOR:

1. Shall in all respects comply with the terms and conditions of said Contract and his obligation there under, including the Contract Documents (which include the scope of work and conditions as prepared by the CITY, invitation to bid, instructions to bidders, the CONTRACTOR'S bid as accepted by the above CITY, the bid and contract performance and payment bonds, and all addenda, if any, issued prior to the opening of bids), being made a part of this bond by reference, at the times and in the manner prescribed in the contract; and
2. Promptly makes payments to all claimants, as defined in Section 255.05(1), Florida Statutes, supplying PRINCIPAL with labor, materials, or supplies, used directly or indirectly by PRINCIPAL in the prosecution of the work provided for in the contract; and
3. Pays CITY all losses, costs, expenses, damages, attorney's fees, including appellate proceedings, injury or loss of whatever kind and however arising including, without limitation, delay damages to which said CITY may be subject by reason of any wrongdoing, misconduct, want of care or skill, negligence, failure of performance, breach, failure to petition within the prescribed time, or default, including patent infringements, on the part of said CONTRACTOR, his agents or employees, in the execution or performance of said Contract; and
4. Performs the guarantee of all work and materials furnished under the contract for the time specified in the contract, then this obligation shall be void; otherwise, to remain in full force and effect for the term of said Contract.

AND, the said Surety for value received, hereby stipulates and agrees that no change involving any extension of time, or addition to the terms of the Contract Documents, or to the work to be performed, or materials to be furnished there under shall affect said obligation of said Surety on this Bond, and the said Surety does hereby waive notice of any such changes, extension of time, alterations, or additions of the terms of the Contract Documents, or to the work.

Any action instituted by a claimant under this bond for payment must be in accordance with the notice and time limitation provisions in Section 255.05(2), Florida Statutes.

IN WITNESS WHEREOF, the above parties bonded together have executed this instrument this _____ day of _____, 2018, the name and corporate seal of each corporate party being hereto affixed and those presents duly signed by its undersigned representative, pursuant to authority of its governing body.

CONTRACTOR

(SEAL)

By: _____

Attest: _____

SURETY

(SEAL)

By: _____

Attest: _____

FLORIDA PAYMENT BOND

BOND NO. _____

AMOUNT: \$ _____

KNOW ALL MEN BY THESE PRESENTS, that in accordance with Florida Statutes Section 255.05, _____

with offices at _____ hereinafter called the CONTRACTOR, (Principal), and

_____ with offices at _____

a corporation duly organized and existing under and by virtue of the laws of the State of _____, hereinafter called the SURETY, and authorized to transact business within the State of Florida, as SURETY, are held and firmly bound unto CITY OF KEY WEST, hereinafter called the City (Obligee), in the sum of:

_____ DOLLARS (_____), lawful money of the United States of America, for the payment of which, well and truly be made to the CITY, and the CONTRACTOR and the SURETY bind themselves and each of their heirs, executors, administrators, successors, and assigns, jointly and severally, firmly by these presents as follows:

THE CONDITION OF THE ABOVE OBLIGATION IS SUCH THAT:

WHEREAS, the CONTRACTOR has executed and entered into a certain Contract for **ITB #17-023 EFFLUENT PUMP FP-3-1 CONTROL AND VFD REPLACEMENT** attached hereto, with the CITY, dated _____, 2018, to furnish at his own cost, charges, and expense the necessary materials, equipment, and/or labor in strict and express accordance with said Contract and the plans, drawings (if any), and specifications prepared by the CITY, all of which is made a part of said Contract by certain terms and conditions in said Contract more particularly mentioned, which Contract, consisting of the various Contract Documents specifically mentioned herein and relative hereto, is made a part of this Bond as fully and completely as if said Contract Documents were set forth herein.

NOW THEREFORE, the conditions of this obligation are such that if the above bounden CONTRACTOR shall in all respects comply with the terms and conditions of said Contract and his obligation thereunder, including the Contract Documents, which include Scope of work and conditions prepared by the CITY, invitation to bid, instructions to bidders, the

CONTRACTOR’S bid as accepted by the CITY, the bid and contract and payment bonds, and all addenda, if any, issued prior to the opening of bids), and further that if said CONTRACTOR shall promptly make payments to all persons supplying materials, equipment, and/or labor, used directly

or indirectly by said CONTRACTOR or subcontractors in the prosecution of the work for said contract is accordance with Florida Statutes, Section 255.05 or Section 713.23, then this obligation shall be void; otherwise to remain in full force and effect for the term of said contract, including and all guarantee periods as specifically mentioned in said Contract Documents.

AND, the said SURETY for value received, hereby stipulates and agrees that no change involving any extension of time, or addition to the terms of the Contract or to the work to be performed, or materials to be furnished thereunder, or in the Contract Documents and specifications accompanying the said contract shall affect said obligation of said SURETY on this Bond, and the said SURETY does hereby waive notice of any such changes, extension of time, alternations, or additions of the terms of the Contract, or to the work, to the Contract Documents, or to the specifications.

Claimant shall give written notice to the CONTRACTOR and the SURETY as required by Section 255.05 or Section 713.23, Florida Statutes. Any action instituted against the CONTRACTOR or SURETY under this bond for payment must be in accordance with the notice and time limitation provisions in Section 255.05(2) or Section 713.23, Florida Statutes.

IN WITNESS WHEREOF, the above parties bounded together have executed this instrument

this _____ day of _____, 2018, the name and corporate seal of each corporate party being hereto affixed and those presents duly signed by its undersigned representative, pursuant to authority of its governing body.

CONTRACTOR

(SEAL)

By: _____

Attest: _____

SURETY

(SEAL)

By: _____

Attest: _____

GENERAL CONDITIONS
CONTENTS

Article

DEFINITIONS

1. AS APPROVED
2. AS SHOWN, AND AS INDICATED
3. BIDDER
4. CONTRACT DOCUMENTS
5. CONTRACTOR
6. CONTRACT COMPLETION
7. DAYS
8. DRAWINGS
9. ENGINEER
10. NOTICE
11. OR EQUAL
12. OWNER
13. PLANS
14. SPECIFICATIONS
15. NOTICE TO PROCEED
16. SUBSTANTIAL COMPLETION
17. WORK

CONTRACT DOCUMENTS

18. INTENT OF CONTRACT DOCUMENTS
19. DISCREPANCIES AND OMISSIONS
20. CHANGES IN THE WORK
21. EXAMINATION AND VERIFICATION
OF CONTRACT DOCUMENTS
22. DOCUMENTS TO BE KEPT
ON THE JOBSITE
23. ADDITIONAL CONTRACT
DOCUMENTS
24. OWNERSHIP OF CONTRACT
DOCUMENTS

THE ENGINEER

25. AUTHORITY OF THE ENGINEER
26. DUTIES AND RESPONSIBILITIES
OF THE ENGINEER
27. LIMITATIONS ON ENGINEER'S
RESPONSIBILITIES
28. REJECTED WORK
29. LINES AND GRADES
30. SUBMITTALS
31. DETAIL DRAWINGS AND INSTRUCTIONS

THE CONTRACTOR AND HIS EMPLOYEES

32. CONTRACTOR, AN INDEPENDENT AGENT

33. SUBCONTRACTING
34. INSURANCE AND LIABILITY
 - A. GENERAL
 - B. CONTRACTOR AND SUB-
CONTRACTOR INSURANCE
 - C. COMPENSATION AND EMPLOYER'S
LIABILITY INSURANCE
 - D. GENERAL LIABILITY INSURANCE
(INCLUDING AUTOMOBILE)
 - E. BUILDER'S RISK ALL RISK
INSURANCE
 - F. NO PERSONAL LIABILITY OF PUBLIC
OFFICIALS
35. INDEMNITY
36. EXCLUSION OF CONTRACTOR CLAIMS
37. TAXES AND CHARGES
38. REQUIREMENTS OF STATE LAW FOR
PUBLIC WORKS PROJECTS
39. CODES, ORDINANCES, PERMITS,
AND LICENSES
40. SUPERINTENDENCE
41. RECEPTION OF ENGINEER'S
COMMUNICATIONS
42. SAFETY
43. PROTECTION OF WORK AND PROPERTY
44. RESPONSIBILITY OF CONTRACTOR TO ACT
IN AN EMERGENCY
45. MATERIALS AND APPLIANCES
46. CONTRACTORS' AND MANUFACTURERS'
COMPLIANCE WITH STATE SAFETY,
OSHA AND OTHER CODE REQUIREMENTS
47. SUBSTITUTION OF MATERIALS
48. TESTS, SAMPLES, AND OBSERVATIONS
49. ROYALTIES AND PATENT
50. CONTRACTOR'S RIGHT TO
TERMINATE CONTRACT
51. CORRECTION OF DEFECTIVE WORK
DURING WARRANTY PERIOD

PROGRESS OF THE WORK

52. BEGINNING OF THE WORK
53. SCHEDULES AND PROGRESS REPORTS
54. PROSECUTION OF THE WORK
55. OWNER'S RIGHT TO RETAIN
IMPERFECT WORK
56. OWNER'S RIGHT TO DO WORK
57. OWNER'S RIGHT TO TRANSFER
EMPLOYMENT
58. DELAYS AND EXTENSION OF TIME
59. DIFFERING SITE CONDITION

Article

- 60. LIQUIDATED DAMAGES
- 61. OTHER CONTRACTS
- 62. USE OF PREMISES
- 63. SUBSTANTIAL COMPLETION DATE
- 64. PERFORMANCE TESTING
- 65. OWNER'S USE OF PORTION OF THE WORK
- 66. CUTTING AND PATCHING
- 67. CLEANING UP

PAYMENT

- 68. CHANGE ORDERS
 - A. UNIT PRICE
 - B. LUMP SUM
 - C. COST REIMBURSEMENT
WORK
- 69. PARTIAL PAYMENTS
 - A. GENERAL
 - B. ESTIMATE
 - C. DEDUCTION FROM ESTIMATE
 - D. QUALIFICATIONS FOR
PARTIAL PAYMENT FOR
MATERIALS DELIVERED
 - E. PAYMENT
- 70. CLAIMS FOR EXTRA WORK
- 71. RELEASE OF LIENS OR CLAIMS
- 72. FINAL PAYMENT
- 73. NO WAIVER OF RIGHTS
- 74. ACCEPTANCE OF FINAL PAYMENT
CONSTITUTES RELEASE

DEFINITIONS

Whenever in the Contract Documents the following terms are used, the intent and meaning shall be interpreted as follows:

1. AS APPROVED

The words “as approved”, unless otherwise qualified, shall be understood to be followed by the words “by the ENGINEER for conformance with the Contract Document”.

2. AS SHOWN, AND AS INDICATED

The words “as shown” and “as Indicated” shall be understood to be followed by the words “on the Drawings”.

3. BIDDER

The person or persons, partnership, firm, or corporation submitting a Proposal for the work contemplated.

4. CONTRACT DOCUMENTS

The “Contract Documents” consist of the Bidding Requirements, Contract Forms, Conditions of the Contract, Specifications, Drawings, all modifications thereof incorporated into the Documents before their execution, Change Orders, and all other requirements incorporated by specific reference thereto. These form the Contract.

5. CONTRACTOR

The person or persons, partnership, firm, or corporation who enters into the Contract awarded him by the OWNER.

6. CONTRACT COMPLETION

The “Contract Completion” is the date the OWNER accepts the entire work as being in compliance with the Contract Documents, or formally waives nonconforming work to extent of nonconformity, and issues the final payment in accordance with the requirements set forth in Article, “Final Payment” of these General Conditions.

7. DAYS

Unless otherwise specifically stated, the term “days” will be understood to mean calendar days. Business day or working day means any day other than Saturday, Sunday, or legal holiday.

8. DRAWINGS

The term “Drawings” refers to the official Drawings, Profiles, cross sections, elevations, details, and other working drawings and supplementary drawings, or reproductions thereof, signed by the ENGINEER, which shows the location, character, dimensions, and details of the work to be performed. Drawings may either be bound in the same book as the balance of the Contract Documents, or bound in separate sets, and are a part of the Contract Documents, regardless of the method of binding.

9. ENGINEER

The person or organization identified as such in the Contract Documents. The Term “ENGINEER” means ENGINEER or his authorized representative.

10. NOTICE

The term “notice” or the requirement to notify, as used in the Contract Documents or applicable state or federal statutes, shall signify a written communication delivered in person or by registered mail to the individual, or to a member of the firm, or to an officer of the corporation for whom it is intended. Certified or registered mail shall be addressed to the last business address known to him who gives the notice.

11. OR EQUAL

The term “or equal” shall be understood to indicate that the “equal” Product is equivalent to or better than the Product named in function, performance, reliability, quality, and general configuration. Determination of equality in reference to the Project design requirements will be made by the ENGINEER. Such equal Products shall not be purchased or installed by the CONTRACTOR without written authorization.

12. OWNER

The person, organization, or public body identified as such in the Contract Documents.

13. PLANS (See Drawings)

14. SPECIFICATIONS

The term “Specifications” refers to those portions of the Contract Documents consisting of written technical descriptions of materials, equipment, construction systems, standards, and workmanship as applied to the work and certain

administrative details applicable thereto. Where standard specifications, such as those of ASTM, AASHTO, etc., have been referred to, the applicable portions of such standard specifications shall become a part of these Contract Documents. If referenced specifications conflict with specifications contained herein, the requirements contained herein shall prevail.

15. NOTICE TO PROCEED

A written notice given by the OWNER to the CONTRACTOR (with a copy to the ENGINEER) fixing the date on which the Contract time will commence to run and on which the CONTRACTOR shall start to perform his obligation under the Contract Documents. The Notice to Proceed will be given within 30 days following the execution of the Contract by the OWNER.

16. SUBSTANTIAL COMPLETION

“Substantial Completion” shall be that degree of completion of the Project or a defined portion of the Project, as evidenced by the ENGINEER’s written notice of Substantial Completion, sufficient to Provide the OWNER, at his discretion, the full-time use of the Project or defined portion of the Project for the purposes for which it was intended. “Substantial Completion” of an operating facility shall be that degree of completion that has Provided a minimum of 7 continuous days of successful, trouble-free, operation, which period shall begin after all performance and acceptance testing has been successfully demonstrated to the ENGINEER. All equipment contained in the work, plus all other components necessary to enable the OWNER to operate the facility in a manner that was intended, shall be complete on the substantial completion date.

17. WORK

The word “work” within these Contract Documents shall include all material, labor, tools, and all appliances, machinery, transportation, and appurtenances necessary to perform and complete the Contract, and such additional items not specifically indicated or described which can be reasonably inferred as belonging to the item described or indicated and as required by good Practice to Provide a complete and satisfactory system or structure. As used herein, “Provide” shall be understood to mean “furnish and install, complete in-place”.

CONTRACT DOCUMENTS

18. INTENT OF CONTRACT DOCUMENTS

The Contract Documents are complementary, and what is called for by one shall be as binding as if called for by all. The intent of the Documents is to describe a functionally complete Project (or part thereof) to be constructed in accordance with the Contract Documents. Any work, materials, or equipment that

may reasonably be inferred from the Contract Documents as being required to produce the intended result shall be supplied whether or not specifically called for. When words which have a well-known technical or trade meaning are used to describe work, materials, or equipment, such words shall be interpreted in accordance with that meaning.

Reference to standard specifications, manuals, or codes of any technical society, organization or association, or to the laws or regulations of any governmental authority, whether such reference be specific or by implication, shall mean the latest standard specification, manual, code or laws or regulations in effect on the first published date of the Invitation to Bid, except as may be otherwise specifically stated. However, no Provision of any referenced standard specification, manual or code (whether or not specifically incorporated by reference in the Contract Documents) shall be effective to change the duties and responsibilities of OWNER, CONTRACTOR, or ENGINEER, or any of their consultants, agents, or employees from those set forth in the Contract Documents, nor shall it be effective to assign to ENGINEER, or any ENGINEER’s consultants, agents, or employees, any duty or authority to supervise or direct the furnishing or performance of the work or any duty or authority to undertake responsibility contrary to the Provisions of Article LIMITATIONS ON ENGINEER’S RESPONSIBILITIES.

19. DISCREPANCIES AND OMISSIONS

Any discrepancies or omissions found in the Contract Documents shall be reported to the ENGINEER immediately. The ENGINEER will clarify discrepancies or omissions, in writing, within a reasonable time.

In resolving inconsistencies among two or more sections of the Contract Documents, Precedence shall be given in the following order:

- A. CONTRACT
- B. PROPOSAL
- C. SUPPLEMENTARY CONDITIONS
- D. INVITATION TO BID
- E. INSTRUCTIONS TO BIDDERS
- F. GENERAL CONDITIONS
- G. SPECIFICATIONS
- H. DRAWINGS

Addenda shall take Precedence over all sections referenced therein. Figure dimensions on Drawings shall take precedence over scale dimensions. Detailed Drawings shall take precedence over general Drawings.

20. CHANGES IN THE WORK

The OWNER, without notice to the Sureties and without invalidating the Contract, may order changes in the work within

the general scope of the Contract by altering, adding to, or deducting from the work, the Contract being adjusted accordingly. All such work shall be executed under the conditions of the original Contract, except as specifically adjusted at the time of ordering such change.

In giving instructions, the ENGINEER may order minor changes in the work not involving extra cost and not inconsistent with the purposes of the Project, but otherwise, except in an emergency endangering life and Property, additions or deductions from the work shall be performed only in pursuance of an approved Change Order from the OWNER, countersigned by the ENGINEER.

If the work is reduced by alterations, such action shall not constitute a claim for damages based on loss of anticipated Profits.

21. EXAMINATION AND VERIFICATION OF CONTRACT DOCUMENTS

The CONTRACTOR shall thoroughly examine and become familiar with all of the various parts of these Contract Documents and determine the nature and location of the work, the general and local conditions, and all other matters, which can in any way affect the work under this Contract. Failure to make an examination necessary for this determination shall not release the CONTRACTOR from the obligations of this Contract. No verbal agreement or conversation with any officer, agent, or employee of the OWNER or with the ENGINEER either before or after the execution of this Contract shall affect or modify any of the terms or obligations herein contained.

22. DOCUMENTS TO BE KEPT ON THE JOBSITE

The CONTRACTOR shall keep one copy of the Contract Documents on the job- site, in good order, available to the ENGINEER and to his representatives.

The CONTRACTOR shall maintain on a daily basis at the jobsite, and make available to the ENGINEER on request, one current record set of the Drawings which have been accurately marked to indicate all modifications in the completed work that differ from the design information shown on the Drawings. Upon Substantial completion of the work, the CONTRACTOR shall give the ENGINEER one complete set of these marked up record Drawings.

23. ADDITIONAL CONTRACT DOCUMENTS

Copies of Contract Documents or Drawings may be obtained on request from the ENGINEER and by paying the actual cost of reproducing the Contract Documents or Drawings.

24. OWNERSHIP OF CONTRACT DOCUMENTS

All portions of the Contract Documents, and copies thereof furnished by the ENGINEER are instruments of service for this Project. They are not to be used on other work and are to be returned to the ENGINEER on request at the completion of the work. Any reuse of these materials without specific written verification or adaptation by the ENGINEER will be at the risk of the user and without liability or legal expense to the ENGINEER. Such user shall hold the ENGINEER harmless from any and all damages, including reasonable attorneys' fees, from any and all claims arising from any such reuse. Any such verification and adaptation shall entitle the ENGINEER to further compensation at rates to be agreed upon by the user and the ENGINEER.

THE ENGINEER

25. AUTHORITY OF THE ENGINEER

The ENGINEER will be the OWNER's representative during the construction period. His authority and responsibility will be limited to the Provisions set forth in these Contract Documents. The ENGINEER will have the Authority to reject work that does not conform to the Contract Documents. However, neither the ENGINEER's authority to act under this Provision, nor any decision made by him in good faith either to exercise or not to exercise such authority, shall give rise to any duty or responsibility of the ENGINEER to the CONTRACTOR, any SUBCONTRACTOR, their respective Sureties, any of their agents or employees, or any other person performing any of the work.

26. DUTIES AND RESPONSIBILITIES OF THE ENGINEER

The ENGINEER will make visits to the site at intervals appropriate to the various stages of construction to observe the Progress and quality of the work and to determine, in general, if the work is proceeding in accordance with the intent of the Contract Documents. He will not make comprehensive or continuous review or observation to check quality or quantity of the work, and he will not be responsible for construction means, methods, techniques, sequences, or Procedures, or for safety Precautions and Programs in connection with the work. Visits and observations made by the ENGINEER shall not relieve the CONTRACTOR of his obligation to conduct comprehensive inspections of the work and to furnish materials and perform acceptable work, and to provide adequate safety Precautions, in conformance with the intent of the Contract.

The ENGINEER will make recommendations to the OWNER, in writing, on all claims of the OWNER or the CONTRACTOR arising from interpretation or execution of the Contract Documents. Such recommendations will be of factual and/or technical nature, and will not include the legal interpretation of

the Contract Documents. Any necessary legal interpretation of the Contract Document will be made by the OWNER. Such recommendation shall be necessary before the CONTRACTOR can receive additional money under the terms of the Contract. Changes in work ordered by the ENGINEER shall be made in compliance with Article CHANGES IN THE WORK.

One or more Project representatives may be assigned to observe the work. It is understood that such Project representatives shall have the authority to issue notice of nonconformance and make decisions within the limitations of the authority of the ENGINEER. The CONTRACTOR shall furnish all reasonable assistance required by the ENGINEER or Project representatives for Proper observation of the work. The above-mentioned Project representatives shall not relieve the CONTRACTOR of his obligations to conduct comprehensive inspections of the work and to furnish materials and perform acceptable work, and to provide adequate safety Precautions, in conformance with the intent of the Contract.

27. LIMITATIONS ON ENGINEER'S RESPONSIBILITIES

ENGINEER will not be responsible for CONTRACTOR's means, methods, techniques, sequences, or Procedures of construction, or the safety Precautions and Programs incident thereto, and ENGINEER will not be responsible for CONTRACTOR's failure to perform or furnish the work in accordance with the Contract Documents.

ENGINEER will not be responsible for the acts or omissions of CONTRACTOR or of any SUBCONTRACTOR, any supplier, or of any other person or organization performing or furnishing any of the work.

Whenever in the Contract Documents the terms "as ordered", "as directed", "as required", "as allowed", "as approved", or terms of like effect or import are used, or the adjectives "reasonable", "suitable", "acceptable", "Proper", or "satisfactory", or adjectives of like effect or import are used to describe a requirement, direction, review or judgment of ENGINEER as to the work, it is intended that such requirement, direction, review or judgment will be solely to evaluate the work for compliance with the Contract Documents (unless there is a specific statement indicating otherwise). The use of any such term or adjective shall not be effective to assign to ENGINEER any duty or authority to supervise or direct the furnishing or performance of the work or any duty or authority to undertake responsibility contrary to the Provisions of this Article.

28. REJECTED WORK

Any defective work or nonconforming materials or equipment that may be discovered at any time prior to expiration of the warranty period shall be removed and replaced by work which shall conform to the Provisions of the Contract Documents.

Any material condemned or rejected shall be removed at once from the Project site.

Failure on the part of the ENGINEER to condemn or reject bad or inferior work or to note nonconforming materials or equipment on CONTRACTOR submittals shall not be construed to imply acceptance of such work. The OWNER shall reserve and retain all of its rights and remedies at law against the CONTRACTOR and its Surety for correction of any and all latent defects discovered after the guarantee period.

29. LINES AND GRADES

Lines and grades shall be established as provided in the supplementary conditions. All stakes, marks, and other reference information shall be carefully preserved by the CONTRACTOR, and in case of their careless or unnecessary destruction or removal by him or his employees, such stakes, marks, and other information shall be replaced at the CONTRACTOR's expense.

30. SUBMITTALS

After checking and verifying all field measurements and after complying with applicable Procedures specified in Division I, GENERAL REQUIREMENTS, CONTRACTOR shall submit to ENGINEER, in accordance with the schedule for submittals for review, shop drawings, electrical diagrams, and catalog cuts for fabricated items and manufactured items (including mechanical and electrical equipment), which shall bear a stamp or specific written indication that CONTRACTOR has satisfied CONTRACTOR's responsibilities under the Contract Documents with respect to the review of the submittal. All submittals shall be identified as ENGINEER may require. The data shown shall be complete with respect to quantities, dimensions specified, performance and design criteria, materials, and similar data to enable ENGINEER to review the information. CONTRACTOR shall also submit to ENGINEER for review, with such Promptness as to cause no delay in work, all samples required by the Contract Documents. All samples shall have been checked by and accompanied by a specific written indication that CONTRACTOR has satisfied CONTRACTOR's responsibilities under the Contract Documents with respect to the review of the submission and shall be identified clearly as to material, supplier, pertinent data such as catalog numbers and the use for which intended.

Before submission of each submittal, CONTRACTOR shall have determined and verified all quantities, dimensions, specified performance criteria, installation requirements, materials, catalog numbers, and similar data with respect thereto and reviewed or coordinated each submittal with other submittals and with the requirements of the work and the Contract Documents.

At the time of each submission, CONTRACTOR shall give ENGINEER specific written notice of each variation that the submittal may have from the requirements of the Contract Documents, and, in addition, shall cause a specific notation to be made on each shop drawing submitted to ENGINEER for review and approval of each variation.

ENGINEER will review submittals with reasonable Promptness, but ENGINEER's review will be only for conformance with the design concept of the Project and for compliance with the information given in the Contract Documents and shall not extend to means, methods, techniques, sequences, or Procedures of construction (except where a specific means, method, technique, sequence, or Procedure of construction is indicated in or required by the Contract Documents) or to safety Precautions or Programs incident thereto. The review of a separate item as such will not indicate review of the assembly in which the item functions. CONTRACTOR shall make corrections required by ENGINEER, and shall return the required number of corrected copies of shop drawings and submit as required new samples for review. CONTRACTOR shall direct specific attention in writing to revisions other than the corrections called for by ENGINEER on Previous submittals.

ENGINEER's review of submittals shall not relieve CONTRACTOR from the responsibility for any variation from the requirements of the Contract Documents unless CONTRACTOR has in writing called ENGINEER's attention to each such variation at the time of submission and ENGINEER has given written approval of each such variation by a specific written notation thereof incorporated therein or accompanying the shop drawing or sample approval; nor will any approval by ENGINEER relieve CONTRACTOR from responsibility for errors or omissions in the shop drawings or from responsibility for having complied with the Provisions herein.

Where a shop drawing or sample is required by the specifications, any related work performed Prior to ENGINEER's review and approval of the pertinent submission shall be at the sole expense and responsibility of the CONTRACTOR.

31. DETAIL DRAWINGS AND INSTRUCTIONS

The ENGINEER will furnish, with reasonable Promptness, additional instructions by means of Drawings or otherwise, if, in the ENGINEER's opinion, such are required for the Proper execution of the work. All such Drawings and instructions will be consistent with the Contract Documents, true developments thereof, and reasonably inferable there from.

THE CONTRACTOR AND HIS EMPLOYEES

32. CONTRACTOR, AN INDEPENDENT AGENT

The CONTRACTOR shall independently perform all work under this Contract and shall not be considered as an agent of the OWNER or of the ENGINEER, nor shall the CONTRACTOR's SUBCONTRACTORS or employees be subagents of the OWNER or of the ENGINEER.

A. ASSIGNMENT OF CONTRACT

Assignment of any part or the whole of this Contract shall be subject to review and approval of the City Commission.

33. SUBCONTRACTING

Unless modified in the Supplementary Conditions, within 10 days after the execution of the Contract, the CONTRACTOR shall submit to the ENGINEER the names of all SUBCONTRACTORS Proposed for the work, including the names of any SUBCONTRACTORS that were submitted with the Proposal. The CONTRACTOR shall not employ any SUBCONTRACTORS to which the OWNER may object to as lacking capability to properly perform work of the type and scope anticipated.

The CONTRACTOR is as fully responsible to the OWNER for the acts and omissions of his SUBCONTRACTORS and of persons either directly or indirectly employed by them as he is for the acts and omissions of persons directly employed by him.

Nothing contained in the Contract Documents shall create any contractual relationship between any SUBCONTRACTOR and the OWNER or ENGINEER.

34. INSURANCE AND LIABILITY

A. GENERAL

The CONTRACTOR shall provide (from insurance companies acceptable to the OWNER) the insurance coverage designated hereinafter and pay all costs before commencing work under this Contract. The CONTRACTOR shall furnish the OWNER with certificates of insurance specified herein showing the type, amount class of operations covered, effective dates, and date of expiration of policies, and containing substantially the following statement:

"The insurance covered by this certificate shall not be canceled or materially altered, except after 30 days' written notice has been received by the OWNER."

In case of the breach of any Provision of this Article, the OWNER, at his option, may take out and maintain, at the expense of the CONTRACTOR, such insurance as the OWNER may deem Proper and may deduct the cost of such

insurance from any monies which may be due or become due to the CONTRACTOR under this Contract.

B. CONTRACTOR AND SUBCONTRACTOR INSURANCE

The CONTRACTOR shall not commence work under this Contract until he has obtained all the insurance required hereunder and such insurance has been reviewed by the OWNER, nor shall the CONTRACTOR allow any SUBCONTRACTOR to commence work on his subcontract until insurance specified below has been obtained. Review of the insurance by the OWNER shall not relieve or decrease the liability of the CONTRACTOR hereunder.

C. COMPENSATION AND EMPLOYER'S LIABILITY INSURANCE

The CONTRACTOR shall maintain during the life of this Contract the statutory amount of Workmen's Compensation Insurance, in addition, Employer's Liability Insurance in an amount as specified in the Supplementary Conditions, for each occurrence, for all of his employees to be engaged in work on the Project under this Contract. In case any such work is subcontracted, the CONTRACTOR shall require the SUBCONTRACTOR to provide similar Workmen's Compensation and Employer's Liability Insurance for all of the SUBCONTRACTOR's employees to be engaged in such work.

D. GENERAL LIABILITY INSURANCE (INCLUDING AUTOMOBILE)

The CONTRACTOR shall maintain during the life of this Contract such general liability, completed operations and Products liability, and automobile liability insurance as will Provide coverage for claims for damages for personal injury, including accidental death, as well as for claims for Property damage, which may arise directly or indirectly from performance of the work under this Contract. The general liability policy shall include contractual liability assumed by the CONTRACTOR under Article **INDEMNITY**. Coverage for Property damage shall be on a "broad form" basis with no exclusions for "X, C & U". The amount of insurance to be provided shall be as specified in the Supplementary Conditions.

In the event any work under this Contract is performed by a SUBCONTRACTOR, the CONTRACTOR shall be responsible for any liability directly or indirectly arising out of the work performed by the SUBCONTRACTOR; to the extent such liability is not covered by the SUBCONTRACTOR's insurance.

The OWNER and ENGINEER, their officers, agents, and employees shall be named as Additional Insured's on the CONTRACTOR's and any SUBCONTRACTOR's general

liability and automobile liability insurance policies for any claims arising out of work performed under this Contract.

E. BUILDERS RISK ALL RISK INSURANCE

Unless otherwise modified in the Supplementary Conditions, the CONTRACTOR shall secure and maintain during the life of this Contract, Builders Risk All Risk Insurance coverage in an amount equal to the full value of the facilities under construction. Such insurance shall include coverage for earthquake, landslide, flood, collapse, loss due to the results of faulty workmanship or design, and all other normally covered risks, and shall provide for losses to be paid to the CONTRACTOR, OWNER, and ENGINEER as their interests may appear.

The OWNER and ENGINEER, their officers, agents, and employees shall be named as additional insured's on the CONTRACTOR's and any SUBCONTRACTOR's Builders Risk All Risk insurance policies for any claims arising out of work performed under this Contract.

This insurance shall include a waiver of subrogation as to the ENGINEER, the OWNER, the CONTRACTOR, and their respective officers, agents, employees and SUBCONTRACTORS.

F. NO PERSONAL LIABILITY OF PUBLIC OFFICIALS

In carrying out any of the Provisions hereof in exercising any authority granted by the Contract, there will be no personal liability upon any public official.

35. INDEMNITY

To the maximum extent permitted by law, the CONTRACTOR shall indemnify and defend the OWNER and the ENGINEER, and their officers, employees, agents, and sub-consultants, from all claims and losses, including attorney's fees and litigation costs arising out of Property losses or health, safety, personal injury, or death claims by the CONTRACTOR, its SUBCONTRACTORS of any tier, and their employees, agents, or invitees regardless of the fault, breach of Contract, or negligence of the OWNER or ENGINEER, excepting only such claims or losses that have been adjudicated to have been caused solely by the negligence of the OWNER or the ENGINEER and regardless of whether or not the CONTRACTOR is or can be named a party in a litigation.

36. EXCLUSION OF CONTRACTOR CLAIMS

In performing its obligations, the ENGINEER and its consultants may cause expense for the CONTRACTOR or its SUBCONTRACTORS and equipment or material suppliers.

However, those parties and their sureties shall maintain no direct action against the ENGINEER, its officers, employees, agents, and consultants for any claim arising out of, in connection with, or resulting from the engineering services performed or required to be performed.

37. TAXES AND CHARGES

The CONTRACTOR shall withhold and pay any and all sales and use taxes and all withholding taxes, whether State or Federal, and pay all Social Security charges and also all State Unemployment Compensation charges, and pay or cause to be withheld, as the case may be, any and all taxes, charges, or fees or sums whatsoever, which are now or may hereafter be required to be paid or withheld under any laws.

38. REQUIREMENTS OF STATE LAW FOR PUBLIC WORKS PROJECTS

When the Contract Documents concern public works of the state or any county, municipality, or political subdivision created by its laws, the applicable statutes shall apply. All parties to this Contract shall determine the contents of all applicable statutes and comply with their Provisions throughout the performance of the Contract.

39. CODES, ORDINANCES, PERMITS AND LICENSES

The CONTRACTOR shall keep himself fully informed of all local codes and ordinances, as well as state and federal laws, which in any manner affect the work herein specified. The CONTRACTOR shall at all times comply with said codes and ordinances, laws, and regulations, and Protect and indemnify the OWNER, the ENGINEER and their respective employees, and its officers and agents against any claim or liability arising from or based on the violation of any such laws, ordinances, or regulations. All permits, licenses and inspection fees necessary for Prosecution and completion of the work shall be secured and paid for by the CONTRACTOR, unless otherwise specified.

40. SUPERINTENDENCE

The CONTRACTOR shall keep at the project site, competent supervisory personnel. The CONTRACTOR shall designate, in writing, before starting work, a Project superintendent who shall be an employee of the CONTRACTOR and shall have complete authority to represent and to act for the CONTRACTOR. ENGINEER shall be notified in writing prior to any change in superintendent assignment. The CONTRACTOR shall give efficient supervision to the work, using his best skill and attention. The CONTRACTOR shall be solely responsible for all construction means, methods, techniques, and Procedures, and for providing adequate safety Precautions and coordinating all portions of the work under the Contract. It is specifically

understood and agreed that the ENGINEER, its employees and agents, shall not have control or charge of and shall not be responsible for the construction means, methods, techniques, Procedures, or for providing adequate safety Precautions in connection with the work under Contract.

41. RECEPTION OF ENGINEER'S COMMUNICATIONS

The superintendent shall receive for the CONTRACTOR all communications from the ENGINEER. Communications of major importance will be confirmed in writing upon request from the CONTRACTOR.

The ENGINEER may schedule Project meetings for the purposes of discussing and resolving matters concerning the various elements of the work. Time and place for these meetings and the names of persons required to be Present shall be as determined by the ENGINEER. CONTRACTOR shall comply with these attendance requirements and shall also require his SUBCONTRACTORS to comply.

42. SAFETY

The CONTRACTOR shall be solely and completely responsible for conditions of the jobsite, including safety of all persons (including employees) and Property during performance of the work. This requirement shall apply continuously and not be limited to normal working hours. Safety Provisions shall conform to U.S. Department of Labor (OSHA), and all other applicable federal, state, county, and local laws, ordinances, codes, and regulations. Where any of these are in conflict, the more stringent requirement shall be followed. The CONTRACTOR's failure to thoroughly familiarize himself with the aforementioned safety Provisions shall not relieve him from compliance with the obligations and penalties set forth therein.

The CONTRACTOR shall develop and maintain for the duration of this Contract, a safety Program that will effectively incorporate and implement all required safety Provisions. The CONTRACTOR shall appoint an employee who is qualified and authorized to supervise and enforce compliance with the safety Program. The duty of the ENGINEER to conduct construction review of the work does not include review or approval of the adequacy of the CONTRACTOR's safety Program, safety supervisor, or any safety measures taken in, on, or near the construction site. The CONTRACTOR, as a part of his safety Program, shall maintain at his office or other well-known place at the jobsite, safety equipment applicable to the work as Prescribed by the aforementioned authorities, all articles necessary for giving first-aid to the injured, and shall establish the Procedure for the immediate removal to a hospital or a doctor's care of persons (including employees) who may be injured on the jobsite.

If death or serious injuries or serious damages are caused, the accident shall be reported immediately by telephone or messenger to both the ENGINEER and the OWNER. In addition, the CONTRACTOR must promptly report in writing to the ENGINEER all accidents whatsoever arising out of, or in connection with, the performance of the work whether on, or adjacent to, the site, giving full details and statements of witnesses.

If a claim is made by anyone against the CONTRACTOR or any SUBCONTRACTOR on account of any accident, the CONTRACTOR shall promptly report the facts in writing to the ENGINEER, giving full details of the claim.

43. PROTECTION OF WORK AND PROPERTY

The CONTRACTOR shall at all times safely guard and Protect from damage the OWNER's Property, adjacent Property, and his own work from injury or loss in connection with this Contract. All facilities required for Protection by federal, state, or municipal laws and regulations and local conditions must be provided and maintained.

The CONTRACTOR shall Protect his work and materials from damage due to the nature of the work, the elements, carelessness of other CONTRACTORS, or from any cause whatever until the completion and acceptance of the work. All loss or damages arising out of the nature of the work to be done under these Contract Documents, or from any unforeseen obstruction or defects which may be encountered in the Prosecution of the work, or from the action of the elements, shall be sustained by the CONTRACTOR.

44. RESPONSIBILITY OF CONTRACTOR TO ACT IN AN EMERGENCY

In case of an emergency which threatens loss or injury of Property, and/or safety of life, the CONTRACTOR shall act, without previous instructions from the OWNER or ENGINEER, as the situation may warrant. The CONTRACTOR shall notify the ENGINEER thereof immediately thereafter. Any claim for compensation by the CONTRACTOR, together with substantiating documents in regard to expense, shall be submitted to the OWNER through the ENGINEER and the amount of compensation shall be determined by agreement.

45. MATERIALS AND APPLIANCES

Unless otherwise stipulated, the CONTRACTOR shall Provide and pay for all materials, labor, water, tools, equipment, heat, light, fuel, power, transportation, construction equipment and machinery, appliances, telephone, sanitary facilities, temporary facilities and other facilities and incidentals necessary for the execution and completion of the work.

Unless otherwise specified, all materials shall be new, and both workmanship and materials shall be of good quality. The CONTRACTOR shall, if required, furnish satisfactory evidence as to the kind and quality of materials.

In selecting and/or approving equipment for installation in the Project, the OWNER and ENGINEER assume no responsibility for injury or claims resulting from failure of the equipment to comply with applicable federal, state, and local safety codes or requirements, or the safety requirements of a recognized agency, or failure due to faulty design concepts, or defective workmanship and materials.

46. CONTRACTORS' AND MANUFACTURERS' COMPLIANCE WITH STATE SAFETY, OSHA, AND OTHER CODE REQUIREMENTS

The completed work shall include all necessary permanent safety devices, such as machinery guards and similar ordinary safety items required by the state and federal (OSHA) industrial authorities and applicable local and national codes. Further, any features of the work subject to such safety regulations shall be fabricated, furnished, and installed (including OWNER-furnished equipment) in compliance with these requirements. CONTRACTORS and manufacturers of equipment shall be held responsible for compliance with the requirements included herein. CONTRACTORS shall notify all equipment suppliers and SUBCONTRACTORS of the Provisions of this Article.

47. SUBSTITUTION OF MATERIALS

Except for OWNER-selected equipment items, and items where no substitution is clearly specified, whenever any material, article, device, Product, fixture, form, type of construction, or Process is indicated or specified by patent or Proprietary name, by name of manufacturer, or by catalog number, such specifications shall be deemed to be used for the purpose of establishing a standard of quality and facilitating the description of the material or Process desired. This Procedure is not to be construed as eliminating from competition other Products of equal or better quality by other manufacturers where fully suitable in design, and shall be deemed to be followed by the words "or equal". The CONTRACTOR may, in such cases, submit complete data to the ENGINEER for consideration of another material, type, or Process that shall be substantially equal in every respect to that so indicated or specified. Substitute materials shall not be used unless approved in writing. The ENGINEER will be the sole judge of the substituted article or material.

48. TESTS, SAMPLES, AND OBSERVATIONS

The CONTRACTOR shall furnish, without extra charge, the necessary test pieces and samples, including facilities and labor for obtaining the same, as requested by the ENGINEER. When required, the CONTRACTOR shall furnish certificates of tests

of materials and equipment made at the point of manufacture by a recognized testing laboratory.

The OWNER, ENGINEER, and authorized government agents, and their representatives shall at all times be Provided safe access to the work wherever it is in Preparation or Progress, and the CONTRACTOR shall Provide facilities for such access and for observations, including maintenance of temporary and permanent access.

If the Specifications, laws, ordinances, or any public authority require any work, to be specially tested or approved, the CONTRACTOR shall give timely notice of its readiness for observations. If any work should be covered up without approval or consent of the ENGINEER, it shall, if required by the ENGINEER, be uncovered for examination at the CONTRACTOR's expense.

Reexamination of questioned work may be ordered by the ENGINEER, and, if so ordered, the work shall be uncovered by the CONTRACTOR. If such work is found to be in accordance with the Contract Documents, the OWNER will pay the cost of uncovering, exposure, observation, inspection, testing and reconstruction. If such work is found to be not in accordance with the Contract Documents, the CONTRACTOR shall correct the defective work, and the cost of reexamination and correction of the defective work shall be paid by the CONTRACTOR.

49. ROYALTIES AND PATENTS

The CONTRACTOR shall pay all royalty and licenses fees, unless otherwise specified. The CONTRACTOR shall defend all suits or claims for infringement of any patent rights and shall save the OWNER and the ENGINEER harmless from any and all loss, including reasonable attorneys' fees, on account thereof.

50. CONTRACTOR'S RIGHT TO TERMINATE CONTRACT

If the work should be stopped under an order of any court or other public authority for a period of more than 3 months, through no act or fault of the CONTRACTOR, its SUBCONTRACTORS, or respective employees or if the ENGINEER should fail to make recommendation for payment to the OWNER or return payment request to CONTRACTOR for revision within 30 days after it is due, or if the OWNER should fail to pay the CONTRACTOR within 30 days after time specified in Article PARTIAL PAYMENTS, any sum recommended by the ENGINEER, then the CONTRACTOR may, upon 15 days' written notice to the OWNER and the ENGINEER, stop work or terminate this Contract and recover from the OWNER payment for all acceptable work performed and reasonable termination expenses, unless said default has been remedied.

51. CORRECTION OF DEFECTIVE WORK DURING WARRANTY PERIOD

The CONTRACTOR hereby agrees to make, at his own expense, all repairs or replacements necessitated by defects in materials or workmanship, Provided under terms of this Contract, and pay for any damage to other works resulting from such defects, which become evident within 2 years after the date of final acceptance of the work or within 2 years after the date of substantial completion established by the ENGINEER for specified items of equipment, or within such longer period as may be Prescribed by law or by the terms of any applicable special guarantee required by the Contract Documents. Unremedied defects identified for correction during the warranty period but remaining after its expiration shall be considered as part of the obligations of the warranty. Defects in material, workmanship, or equipment which are remedied as a result of obligations of the warranty shall subject the remedied portion of the work to an extended warranty period of 2 years after the defect has been remedied.

The CONTRACTOR further assumes responsibility for a similar guarantee for all work and materials provided by SUBCONTRACTORS or manufacturers of packaged equipment components. The effective date for the start of the guarantee or warranty period for equipment qualifying as substantially complete is defined in Article SUBSTANTIAL COMPLETION, AND Article SUBSTANTIAL COMPLETION DATE, in these General Conditions.

The CONTRACTOR also agrees to hold the OWNER and the ENGINEER harmless from liability of any kind arising from damage due to said defects. The CONTRACTOR shall make all repairs and replacements promptly upon receipt of written order for same from the OWNER. If the CONTRACTOR fails to make the repairs and replacements promptly, or in an emergency where delay would cause serious risk, or loss, or damage, the OWNER may have the defective work corrected or the rejected work removed and replaced, and the CONTRACTOR and his Surety shall be liable for the cost thereof.

PROGRESS OF THE WORK

52. BEGINNING OF THE WORK

Following execution of the Contract, the CONTRACTOR shall meet with the OWNER and ENGINEER relative to his arrangements for prosecuting the work.

53. SCHEDULES AND PROGRESS REPORTS

Prior to starting the construction, the CONTRACTOR shall Prepare and submit to the ENGINEER, a Progress schedule showing the dates on which each part or division of the work is expected to be started and finished, and a Preliminary schedule

for submittals. The Progress schedule for submittals shall be brought up to date and submitted to the ENGINEER at the end of each month or at such other times the ENGINEER may request.

The CONTRACTOR shall forward to the ENGINEER, at the end of each month, an itemized report of the delivery status of major and critical items of purchased equipment and material, including shop drawings and the status of shop and field fabricated work. These Progress reports shall indicate the date of the purchase order, the current percentage of completion, estimated delivery, and cause of delay, if any.

If the completion of any part of the work or the delivery of materials is behind the submitted Progress schedule, the CONTRACTOR shall submit in writing a plan acceptable to the OWNER and ENGINEER for bringing the work up to schedule.

The OWNER shall have the right to withhold Progress payments for the work if the CONTRACTOR fails to update and submit the Progress schedule and reports as specified.

54. PROSECUTION OF THE WORK

It is expressly understood and agreed that the time of beginning, rate of Progress, and time of completion of the work are the essence of this Contract. The work shall be prosecuted at such time, and in or on such part or parts of the Project as may be required, to complete the Project as contemplated in the Contract Documents and the Progress schedule.

If the CONTRACTOR desires to carry on work at night or outside the regular hours, he shall give timely notice to the ENGINEER to allow satisfactory arrangements to be made for observing the work in Progress.

55. OWNER'S RIGHT TO RETAIN IMPERFECT WORK

If any part or portion of the work completed under this Contract shall Prove defective and not in accordance with the Drawings and Specifications, and if the imperfection in the same shall not be of sufficient magnitude or importance as to make the work dangerous or unsuitable, or if the removal of such work will create conditions which are dangerous or undesirable, the OWNER shall have the right and authority to retain such work but will make such deductions in the final payment therefore as may be just and reasonable.

56. OWNER'S RIGHT TO DO WORK

Should the CONTRACTOR neglect to Prosecute the work in conformance with the Contract Documents or neglect or refuse at his own cost to remove and replace work rejected by the ENGINEER, then the OWNER may notify the Surety of the condition, and after 10 days' written notice to the

CONTRACTOR and the Surety, or without notice if an emergency or danger to the work or public exists, and without Prejudice to any other right which the OWNER may have under Contract, or otherwise, take over that portion of the work which has been improperly or non timely executed, and make good the deficiencies and deduct the cost thereof from the payments then or thereafter due the CONTRACTOR.

57. OWNER'S RIGHT TO TRANSFER EMPLOYMENT

If the CONTRACTOR should abandon the work or if he should persistently or repeatedly refuse or should fail to make prompt payment to SUBCONTRACTORS for material or labor, or to persistently disregard laws, ordinances, or to prosecute the work in conformance with the Contract Documents, or otherwise be guilty of a substantial violation of any Provision of the Contract or any laws or ordinance, then the OWNER may, without Prejudice to any other right or remedy, and after giving the CONTRACTOR and Surety 10 days' written notice, transfer the employment for said work from the CONTRACTOR to the Surety. Upon receipt of such notice, such Surety shall enter upon the Premises and take possession of all materials, tools, and appliances thereon for the purpose of completing the work included under this contract and employ by Contract or otherwise, any qualified person or persons to finish the work and Provide the materials therefore, in accordance with the Contract Documents, without termination of the continuing full force and effect of this contract. In case of such transfer of employment to such Surety, the Surety shall be paid in its own name on estimates according to the terms hereof without any right of the CONTRACTOR to make any claim for the same or any part thereof.

If, after the furnishing of said written notice to the Surety, the CONTRACTOR and the Surety still fail to make reasonable Progress on the performance of the work, the OWNER may terminate the employment of the CONTRACTOR and take possession of the Premises and of all materials, tools, and appliances thereon and finish the work by whatever method he may deem expedient and charge the cost thereof to the CONTRACTOR and the Surety. In such case, the CONTRACTOR shall not be entitled to receive any further payment until the work is finished. If the expense of completing the Contract, including compensation for additional managerial and administrative services, shall exceed such unpaid balance, the CONTRACTOR and the Surety shall pay the difference to the OWNER.

58. DELAYS AND EXTENSION OF TIME

If the CONTRACTOR is delayed in the Progress of the work by any act or neglect of the OWNER or the ENGINEER, or by any separate CONTRACTOR employed by the OWNER, or by strikes, lockouts, fire, adverse weather conditions not reasonably anticipated, or acts of Nature, and if the

CONTRACTOR, within 48 hours of the start of the occurrence, gives written notice to the OWNER of the cause of the potential delay and estimate of the possible time extension involved, and within 10 days after the cause of the delay has been remedied, the CONTRACTOR gives written notice to the OWNER of any actual time extension requested as a result of the aforementioned occurrence, then the Contract time may be extended by change order for such reasonable time as the ENGINEER determines. It is agreed that no claim shall be made or allowed for any damages, loss, or expense which may arise out of any delay caused by the above referenced acts or occurrences other than claims for the appropriate extension of time. No extension of time will be granted to the CONTRACTOR for delays occurring to parts of the work that have no measurable impact on the completion of the total work under this Contract. No extension of time will be considered for weather conditions reasonably anticipated for the area in which the work is being performed. Reasonably anticipated weather conditions will be based on official records of monthly Precipitation and other historical data. Adverse weather conditions, if determined to be of a severity that would impact Progress of the work, may be considered as cause for an extension of Contract completion time.

Delays in delivery of equipment or material purchased by the CONTRACTOR or his SUBCONTRACTORS, including OWNER-selected equipment shall not be considered as a just cause for delay, unless the OWNER determines that for good cause the delay is beyond the control of the CONTRACTOR. The CONTRACTOR shall be fully responsible for the timely ordering, scheduling, complete the work is the per-diem rate, as stipulated in the Proposal. The said amount is hereby agreed upon as a reasonable estimate of the costs, which may be accrued by the OWNER after the expiration of the time of completion. It is expressly understood and agreed that this amount is not to be considered in the nature of a penalty, but as liquidated damages which have accrued against the CONTRACTOR. The OWNER shall have the right to deduct such damages from any amount due, or that may become due the CONTRACTOR, or the amount of such damages shall be due and collectible from the CONTRACTOR or Surety.

59. DIFFERING SITE CONDITIONS

The CONTRACTOR shall promptly, and before the conditions are disturbed, give a written notice to the OWNER and ENGINEER of:

- A. subsurface or latent physical conditions at the site which differ materially from those indicated in this contract,
- B. unknown physical conditions at the site, of an unusual nature, which differ materially from those ordinarily encountered and generally recognized as inherent in work of the character provided for in the Contract.

The ENGINEER will investigate the site conditions promptly after receiving the notice. If the conditions do materially so differ and cause an increase or decrease in the CONTRACTOR's cost of, or the time required for, performing any part of the work under this Contract, whether or not changed as a result of the conditions, and equitable adjustment shall be made under this Article and the Contract modified in writing accordingly.

No request by the CONTRACTOR for an equitable adjustment to the Contract under this Article will be allowed, unless the CONTRACTOR has given the written notice required; Provided that the time prescribed above for giving written notice may be extended by the OWNER.

No request by the CONTRACTOR for an equitable adjustment to the Contract for differing site conditions will be allowed if made after final payment under this Contract.

60. LIQUIDATED DAMAGES

Should the CONTRACTOR fail to complete the work, or any part thereof, in the time agreed upon in the Contract or within such extra time as may have been allowed for delays by extensions granted as Provided in the Contract, the CONTRACTOR shall reimburse the OWNER for the additional expense and damage for each calendar day, Sundays and legal holidays included, that the Contract remains uncompleted after the Contract completion date. It is agreed that the amount of such additional expense and damage incurred by reason of failure to complete the work is the per-diem rate, as stipulated in the Proposal. The said amount is hereby agreed upon as a reasonable estimate of the costs which may be accrued by the OWNER after the expiration of the time of completion. It is expressly understood and agreed that this amount is not to be considered in the nature of a penalty, but as liquidated damages which have accrued against the CONTRACTOR. The OWNER shall have the right to deduct such damages from any amount due, or that may become due the CONTRACTOR, or the amount of such damages shall be due and collectible from the CONTRACTOR or Surety.

61. OTHER CONTRACTS

The OWNER reserves the right to let other Contracts in connection with the work. The CONTRACTOR shall afford other CONTRACTORS reasonable opportunity for the introduction and storage of their materials and the execution of their work and shall properly connect and coordinate his work with theirs.

If any part of the work under this Contract depends for Proper execution or results upon the work of any other CONTRACTOR, utility service company or OWNER, the CONTRACTOR shall inspect and Promptly report to the ENGINEER in writing any patent or apparent defects to

deficiencies in such work that render it unsuitable for such Proper execution and results. The CONTRACTOR's failure to so report shall constitute and acceptance of the work by others as being fit and Proper for integration with work under this Contract, except for latent or nonapparent defects and deficiencies in the work.

62. USE OF PREMISES

The CONTRACTOR shall confine his equipment, the storage of materials and the operation of his workers to limits shown on the Drawings or indicated by law, ordinances, permits, or directions of the ENGINEER, and shall not unreasonably encumber the Premises with his materials. The CONTRACTOR shall provide, at his own expense, the necessary rights-of-way and access to the work, which may be required outside the limits of the OWNER's Property and shall furnish the ENGINEER copies of permits and agreements for use of the Property outside that provided by the OWNER.

The CONTRACTOR shall not load nor permit any part of the structure to be loaded in any manner that will endanger the structure, nor shall CONTRACTOR subject any part of the work or adjacent Property to stresses or Pressures that will endanger it.

63. SUBSTANTIAL COMPLETION DATE

The ENGINEER may issue a written notice of substantial completion for the purpose of establishing the starting date for specific equipment guarantees, and to establish the date that the OWNER will assume the responsibility for the cost of operating such equipment. Said notice shall not be considered as final acceptance of any portion of the work or relieve the CONTRACTOR from completing the remaining work within the specified time and in full compliance with the Contract Documents. See SUBSTANTIAL COMPLETION under DEFINITIONS of these General Conditions.

64. PERFORMANCE TESTING

Operating equipment and systems shall be performance tested in the Presence of the ENGINEER to demonstrate compliance with the specified requirements. Performance testing shall be conducted under the specified design operating conditions or under such simulated operating conditions as recommended or approved by the ENGINEER. Schedule such testing with the ENGINEER at least one week in advance of the planned date for testing.

65. OWNER'S USE OF PORTIONS OF THE WORK

Following issuance of the written notice of Substantial Completion, the OWNER may initiate operation of the facility. Such use shall not be considered as final acceptance of any

portion of the work, nor shall such use be considered as cause for an extension of the Contract completion time, unless authorized by a Change Order issued by the OWNER.

66. CUTTING AND PATCHING

The CONTRACTOR shall do all cutting, fitting, or patching of his work that may be required to make its several parts come together Properly and fit it to receive or be received by work of other CONTRACTORS shown upon or reasonably implied by the Drawings.

67. CLEANING UP

The CONTRACTOR shall, at all times, keep Property on which work is in Progress and the adjacent Property free from accumulations of waste material or rubbish caused by employees or by the work. Upon completion of the construction, the CONTRACTOR shall remove all temporary structures, rubbish, and waste materials resulting from his operations.

PAYMENT

68. PAYMENT FOR CHANGE ORDERS

The OWNER's request for quotations on alterations to the work shall not be considered authorization to proceed with the work expediting, delivery, and installation of all equipment and materials. Within a reasonable period after the CONTRACTOR submits to the OWNER a written request for an extension of time, the ENGINEER will Present his written opinion to the OWNER as to whether an extension of time is justified, and, if so, his recommendation as to the number of days for time extension. The OWNER will make the final decision on all requests for extension of time.

Prior to the issuance of a formal Change Order, nor shall such request justify any delay in existing work. Quotations for alterations to the work shall include substantiating documentation with an itemized breakdown of CONTRACTOR and SUBCONTRACTOR costs, including labor, material, rentals, approved services, overhead, and profit. OWNER may require detailed cost data in order to substantiate the reasonableness of the proposed costs.

Any compensation paid in conjunction with the terms of a Change Order shall comprise total compensation due the CONTRACTOR for the work or alteration defined in the Change Order. By signing the Change Order, the CONTRACTOR acknowledges that the stipulated compensation includes payment for the work or alteration plus all payment for the interruption of schedules, extended overhead, delay, or any other impact claim or ripple effect, and by such signing specifically waives any reservation or claim for additional compensation in respect to the subject Change Order.

At the OWNER's option, payment or credit for any alterations covered by a Change Order shall be determined by one or a combination of the methods set forth in A, B, or C below, as applicable:

A. UNIT PRICES

Those unit Prices stipulated in the Proposal shall be utilized where they are applicable. In the event the Change Order results in a change in the original quantity that is materially and significantly different from the original bid quantity, a new unit Price shall be negotiated upon demand of either party. Unit Prices for new items included in the Change Order shall be negotiated and mutually agreed upon.

B. LUMP SUM

A total lump sum for the work negotiated and mutually acceptable to the CONTRACTOR and the OWNER. Lump sum quotations for modifications to the work shall include substantiating documentation with an itemized breakdown of CONTRACTOR and SUBCONTRACTOR costs, including labor, material, rentals, approved services, overhead, and Profit, all calculated as specified under "C" below.

C. COST REIMBURSEMENT WORK

The term "cost reimbursement" shall be understood to mean that payment for the work will be made on a time and expense basis, that is, on an accounting of the CONTRACTOR's forces, materials, equipment, and other items of cost as required and used to do the work.

If the method of payment cannot be agreed upon Prior to the beginning of the work, and the OWNER directs by written Change Order that the work be done on a cost reimbursement basis, then the CONTRACTOR shall furnish labor, and furnish and install equipment and materials necessary to complete the work in a satisfactory manner and within a reasonable period of time. For the work performed, payment will be made for the documented actual cost of the following:

1. Labor including foremen for those hours they are assigned and participating in the cost reimbursement work (actual payroll cost, including wages, fringe benefits as established by negotiated labor agreements, labor insurance, and labor taxes as established by law). No other fixed labor burdens will be considered, unless approved in writing by the OWNER.
2. Material delivered and used on the designated work, including sales tax, if paid by the CONTRACTOR or his SUBCONTRACTOR.
3. Rental or equivalent rental cost of equipment, including necessary transportation for items having a value in excess of \$100. Rental or equivalent rental cost will be allowed for only those days or

hours during which the equipment is in actual use. Rental and transportation allowances shall not exceed the current rental rates prevailing in the locality. The rentals allowed for equipment will, in all cases, be understood to cover all fuel, supplies, repairs, and renewals, and no further allowances will be made for those items, unless specific agreement to that effect is made.

4. Additional bond, as required and approved by the OWNER.
5. Additional insurance (other than labor insurance) as required and approved by the OWNER.

In addition to items 1 through 5 above, an added fixed fee for general overhead and Profit shall be negotiated and allowed for the CONTRACTOR (or approved SUBCONTRACTOR) actually executing the Cost Reimbursement work.

An additional fixed fee shall be negotiated and allowed the CONTRACTOR for the administrative handling of portions of the work that are executed by an approved SUBCONTRACTOR. No additional fixed fee will be allowed for the administrative handling of work executed by a SUBCONTRACTOR of a SUBCONTRACTOR, unless by written permission from the OWNER.

The added fixed fees shall be considered to be full compensation, covering the cost of general supervision, overhead, Profit, and any other general expense. The CONTRACTOR's records shall make clear distinction between the direct costs of work paid for on a cost reimbursement basis and the costs of other work. The CONTRACTOR shall furnish the ENGINEER report sheets in duplicate of each day's cost reimbursement work no later than the working day following the performance of said work. The daily report sheets shall itemize the materials used, and shall cover the direct cost of labor and the charges for equipment rental, whether furnished by the CONTRACTOR, SUBCONTRACTOR or other forces. The daily report sheets shall provide names or identifications and classifications of workers, the hourly rate of pay and hours worked, and also the size, type, and identification number of equipment and hours operated.

Material charges shall be substantiated by valid copies of vendors' invoices. Such invoices shall be submitted with the daily report sheets, or, if not available, they shall be submitted with subsequent daily report sheets. Said daily report sheets shall be signed by the CONTRACTOR or his authorized agent.

The OWNER reserves the right to furnish such materials and equipment as he deems expedient and the CONTRACTOR shall have no claim for profit or added fees on the cost of such materials and equipment. To receive partial payments and final payment for cost reimbursement work, the CONTRACTOR shall submit to the ENGINEER, detailed and complete documented verification of the CONTRACTOR's and any of

his SUBCONTRACTORS' actual costs involved in the cost reimbursement work. Such costs shall be submitted within 30 days after said work has been performed.

69. PARTIAL PAYMENTS

A. GENERAL

Nothing in this Article shall be construed to affect the right, hereby reserved, to reject the whole or any part of the aforesaid work, should such work be later found not to comply with the Provisions of the Contract Documents. All estimated quantities of work for which partial payments have been made are subject to review and correction on the final estimate. Payment by the OWNER and acceptance by the CONTRACTOR of partial payments based on periodic estimates of quantities of work performed shall not, in any way, constitute acceptance of the estimated quantities used as a basis for computing the amounts of the partial payments.

B. ESTIMATE

At least 30 days before each Progress payment falls due, as specified in the Supplementary Conditions, the CONTRACTOR shall submit to the ENGINEER a detailed estimate of the amount earned during the Preceding month for the separate portions of the work, and request payment. As used in this Article, the words "amount earned" means the value, on the date of the estimate for partial payment, of the work completed in accordance with the Contract Documents, and the value of approved materials delivered to the Project site suitable stored and Protected Prior to incorporation into the work.

ENGINEER will, within 7 days after receipt of each request for payment, either indicate in writing a recommendation of payment and present the request to OWNER, or return the request to CONTRACTOR indicating in writing ENGINEER's reasons for refusing to recommend payment. In the latter case, CONTRACTOR may, within 7 days, make the necessary corrections and resubmit the request.

ENGINEER may refuse to recommend the whole or any part of any payment if, in his opinion, it would be incorrect to make such representations to OWNER. ENGINEER may also refuse to recommend any such payment, or, because of subsequently discovered evidence or the results of subsequent inspections or tests, nullify any such payment previously recommended to such an extent as may be necessary in ENGINEER's opinion to protect the OWNER from loss because:

1. The work is defective, or completed work has been damaged requiring correction or replacement;
2. Written claims have been made against OWNER or Liens have been filed in connection with the work;

3. The Contract Price has been reduced because of Change Orders;
4. OWNER has been required to correct defective work or complete the work in accordance with Article OWNER'S RIGHT TO DO WORK;
5. Of CONTRACTOR's unsatisfactory Prosecution of the work in accordance with the Contract Documents; or
6. CONTRACTOR's failure to make payment to SUBCONTRACTORS or for labor, materials, or equipment.

C. DEDUCTION FROM ESTIMATE

Unless modified in the Supplementary Conditions, deductions from the estimate will be as described below:

1. The OWNER will deduct from the estimate, and retain as part security, 10 percent of the amount earned for work satisfactorily completed. A deduction and retainage of 10 percent will be made on the estimated amount earned for approved items of material delivered to and properly stored at the jobsite but not incorporated into the work. When the work is 50 percent complete, the OWNER may reduce the retainage to 5 percent of the dollar value of all work satisfactorily completed to date provided the CONTRACTOR is making satisfactory progress and there is no specific cause for a greater retainage. The OWNER may reinstate the retainage up to 10 percent if the OWNER determines, at his discretion, that the CONTRACTOR is not making satisfactory progress or where there is other specific cause for such withholding.

D. QUALIFICATION FOR PARTIAL PAYMENT FOR MATERIALS DELIVERED

Unless modified in the Supplementary Conditions, qualification for partial payment for materials delivered but not yet incorporated into the work shall be as described below:

1. Materials, as used herein, shall be considered to be those items which are fabricated and manufactured material and equipment. No consideration shall be given to individual purchases of less than \$200 for any one item.
2. To receive partial payment for materials delivered to the site, but not incorporated in the work, it shall be necessary for the CONTRACTOR to include a list of such materials on the Partial Payment Request. At his sole discretion, the ENGINEER may approve items

for which partial payment is to be made. Partial payment shall be based on the CONTRACTOR's actual cost for the materials as evidenced by invoices from the supplier. Proper storage and Protection shall be provided by the CONTRACTOR, and as approved by the ENGINEER. Final payment shall be made only for materials actually incorporated in the work and, upon acceptance of the work, all materials remaining for which advance payments had been made shall revert to the CONTRACTOR, unless otherwise agreed, and partial payments made for these items shall be deducted from the final payment for the work.

3. CONTRACTOR warrants and guarantees that title to all work, materials, and equipment covered by any Application for Payment, whether incorporated in the Project or not, will pass to OWNER at the time of payment free and clear of all liens, claims, security interests, and encumbrances.
4. If requested by the ENGINEER, the CONTRACTOR shall provide, with subsequent pay requests, invoices receipted by the supplier showing payment in full has been made.

E. PAYMENT

After deducting the retainage and the amount of all previous partial payments made to the CONTRACTOR from the amount earned, the amount due will be made payable to the CONTRACTOR. Recommendations for payment received by the OWNER less than 9 days Prior to the scheduled day for payment will not be Processed or paid until the following month.

70. CLAIMS FOR EXTRA WORK

In any case where the CONTRACTOR deems additional time or compensation will become due him under this Contract for circumstances other than those defined in Article DELAYS AND EXTENSION OF TIME, the CONTRACTOR shall notify the ENGINEER, in writing, of his intention to make claim for such time or compensation before he begins the work on which he bases the claim, in order that such matters may be settled, if possible, or other appropriate action taken. The notice of claim shall be in duplicate, in writing, and shall state the circumstances and the reasons for the claim, but need not state the amount. If such notification is not given or if the ENGINEER is not afforded proper facilities by the CONTRACTOR for keeping strict account of actual cost, then the CONTRACTOR hereby agrees to waive the claim for such additional time or compensation. Such notice by the CONTRACTOR, and fact that the ENGINEER has kept account of the cost as aforesaid, shall not in any way be construed as proving the validity of the claim.

No extension of time will be granted to the CONTRACTOR for delays resulting from extra work that have no measurable impact on the completion of the total work under this Contract. Claims for additional time or compensation shall be made in itemized detail and submitted, in writing, to the OWNER and ENGINEER within 10 days following completion of that portion of the work for which the CONTRACTOR bases his claim. Failure to make the claim for additional compensation in the manner and within the time specified above shall constitute waiver of that claim. In case the claim is found to be just, it shall be allowed and paid for as provided in Article PAYMENT FOR CHANGE ORDERS.

71. RELEASE OF LIENS OR CLAIMS

The CONTRACTOR shall indemnify and hold harmless the OWNER from all claims for labor and materials furnished under this Contract. Prior to the final payment, the CONTRACTOR shall furnish to the OWNER, as part of his final payment request, a certification that all of the CONTRACTOR's obligations on the project have been satisfied and that all monetary claims and indebtedness have been paid. The CONTRACTOR shall furnish complete and legal effective releases or waivers, satisfactory to the OWNER, of all liens arising out of or filed in connection with the work.

72. FINAL PAYMENT

Upon completion of all the work under this Contract, the CONTRACTOR shall notify the ENGINEER, in writing, that he has completed his part of the Contract and shall request final payment. Upon receipt of such notice the ENGINEER will inspect and, if acceptable, submit to the OWNER his recommendation as to acceptance of the completed work and as to the final estimate of the amount due the CONTRACTOR. Upon approval of this final estimate by the OWNER and compliance by the CONTRACTOR with Provisions in Article **RELEASE OF LIENS OR CLAIMS**, and other Provisions as may be applicable, the OWNER shall pay to the CONTRACTOR all monies due him under the Provisions of these Contract Documents.

73. NO WAIVER OF RIGHTS

Neither the inspection by the OWNER, through the ENGINEER or any of his employees, nor any order by the OWNER for payment of money, nor any payment for, or acceptance of, the whole or any part of the work by the OWNER or ENGINEER, nor any extension of time, nor any possession taken by the OWNER or its employees, shall operate as a waiver of any Provision of this Contract, or any power herein reserved to the OWNER, or any right to damages herein Provided, nor shall any waiver of any breach in this Contract be held to be a waiver of any other or subsequent breach. Acceptance or final payment shall not be final and conclusive with regards to latent

defects, fraud, or such gross mistakes as may amount to fraud, or as regards the OWNER's rights under the warranty.

**74. ACCEPTANCE OF FINAL PAYMENT
CONSTITUTES RELEASE**

The acceptance by the CONTRACTOR of the final payment shall release the OWNER and the ENGINEER, as representatives of the OWNER, from all claims and all liability to the CONTRACTOR for all things done or furnished in connection with the work, and every act of the OWNER and others relating to or arising out of the work except claims Previously made in writing and still unsettled. No payment, however, final or otherwise, shall operate to release the CONTRACTOR or his Sureties from obligations under this Contract and the Performance Bond, Payment Bond, and other bonds and warranties, as herein provided.

SUPPLEMENTARY CONDITIONS

The General Conditions are hereby revised as follows:

ARTICLE 9 "ENGINEER"

Delete Article "ENGINEER" in its entirety and substitute the following:

The person or organization identified as such in the Contract Documents. The Term "ENGINEER" means ARCHITECT or his authorized representative.

ARTICLE 34 "INSURANCE & LIABILITY"

Delete Article 34 "INSURANCE & LIABILITY" (A), (B), (C), and (D) in their entirety and substitute the following:

Contractor shall maintain limits no less than those stated below:

CONTRACTOR is to secure, pay for, and file with the City of Key West, prior to commencing any work under the Contract, all certificates for workers' compensation, public liability, and property damage liability insurance, and such other insurance coverages as may be required by specifications and addenda thereto, in at least the following minimum amounts with specification amounts to prevail if greater than minimum amounts indicated. Notwithstanding any other provision of the Contract, the CONTRACTOR shall provide the minimum limits of liability insurance coverage as follows:

Auto Liability	\$1,000,000	Combined Single Limit
General Liability	\$1,000,000	Aggregate (Per Project)
	\$1,000,000	Products Aggregate
	\$1,000,000	Any One Occurrence
	\$1,000,000	Personal Injury
	\$ 300,000	Fire Damage/Legal

CONTRACTOR shall furnish an original Certificate of Insurance indicating, and such policy providing coverage to, City of Key West named as an additional insured on a PRIMARY and NON-CONTRIBUTORY basis utilizing an ISO standard endorsement at least as broad as CG 2010 (11/85) or its equivalent, (combination of CG 20 10 07 04 and CG 20 37 07 04, providing coverage for completed operations, is acceptable) including a waiver of subrogation clause in favor of City of Key West on all policies. CONTRACTOR will maintain the General Liability and Umbrella Liability insurance coverages summarized above with coverage continuing in full force including the additional insured endorsement until at least 3 years beyond completion and delivery of the work contracted herein.

Notwithstanding any other provision of the Contract, the CONTRACTOR shall maintain complete workers' compensation coverage for each and every employee, principal, officer,

representative, or agent of the CONTRACTOR who is performing any labor, services, or material under the Contract. Further, CONTRACTOR shall additionally maintain the following minimum limits of coverage:

Bodily Injury Each Accident	\$1,000,000
Bodily Injury by Disease Each Employee	\$1,000,000
Bodily Injury by Disease Policy Limit	\$1,000,000

CONTRACTOR's insurance policies shall be endorsed to give 30 days written notice to the City of Key West in the event of cancellation or material change, using form CG 02 24, or its equivalent.

Certificates of Insurance submitted to the City of Key West will not be accepted without copies of the endorsements being requested. This includes additional insured endorsements, cancellation/material change notice endorsements, and waivers of subrogation. Copies of USL&H Act and Jones Act endorsements will also be required if necessary. PLEASE ADVISE YOUR INSURANCE AGENT ACCORDINGLY.

CONTRACTOR will comply with any and all safety regulations required by any agency or regulatory body including but not limited to OSHA. CONTRACTOR will notify City of Key West immediately by telephone at (305) 809-3963 any accident or injury to anyone that occurs on the jobsite and is related to any of the work being performed by the CONTRACTOR.

Add the following Article:

G. SURETY AND INSURER QUALIFICATIONS

All bonds, insurance contracts, and certificates of insurance shall be either executed by or countersigned by a licensed resident agent of the Surety or insurance company, having his place of business in the State of Florida, and in all ways complying with the insurance laws of the State of Florida. Further, the said Surety or Insurance Company shall be duly licensed and qualified to do business in the State of Florida. If requested, Contractor shall Provide Proof of Florida Licensure for all insurance companies. The City of Key West and CH2M HILL shall be named as Additional Insured on the insurance certificates.

ARTICLE 35 "INDEMNITY"

Delete Article 35 "INDEMNITY" in its entirety and substitute the following:

INDEMNITY

To the fullest extent permitted by law, the CONTRACTOR expressly agrees to indemnify and hold harmless the City of Key West, their officers, directors, agents, and employees (herein called the "indemnitees") from liabilities, damages, losses and costs, including, but not limited to, reasonable attorney's fees and court costs, such legal expenses to include costs incurred in establishing the indemnification and other rights agreed to in this Paragraph, to persons or property, to the extent caused by the negligence, recklessness, or intentional wrongful misconduct of the CONTRACTOR, its Subcontractors or persons employed or utilized by them in the performance of the Contract. Claims by indemnitees for indemnification shall be limited to the amount of CONTRACTOR's insurance or \$1 million per occurrence, whichever is greater. The parties acknowledge that the amount of the indemnity required hereunder bears a reasonable commercial relationship to the Contract and it is part of the project specifications or the bid documents, if any.

The indemnification obligations under the Contract shall not be restricted in any way by any limitation on the amount or type of damages, compensation, or benefits payable by or for the CONTRACTOR under workers' compensation acts, disability benefits acts, or other employee benefits acts, and shall extend to and include any actions brought by or in the name of any employee of the CONTRACTOR or of any third party to whom CONTRACTOR may subcontract a part or all of the Work. This indemnification shall continue beyond the date of completion of the work.

ARTICLE 39 "CODES, ORDINANCES, PERMITS, AND LICENSES"

Add the following:

A. PERMIT FOR WORK WITHIN LOCAL RIGHTS-OF-WAY

The Contractor shall obtain from the City of Key West the necessary permits for work within the rights-of-way. The Contractor shall abide by all regulations and conditions, including maintenance of traffic.

B. NOISE ORDINANCE

City of Key West has a noise ordinance that allows working hours between 8:00 AM to 7:00 PM, Monday through Friday. No work should be performed during weekends or City Holidays, State Holidays and National Holidays. Any construction operations outside these hours and these days will require a variance from the City of Key West Commission.

D. "LICENSES"

THE BIDDER MUST BE A LICENSED CONTRACTOR BY THE STATE OF FLORIDA AND SUBMIT PROOF OF SUCH WITH THE BID.

1. Within 10 days of Notice of Award, the successful Bidder must represent that he holds all applicable, county, and City of Key West licenses and permits required to do business as a contractor with respect to the work described in the Contract Documents.
2. Further, the successful Bidder must, within 10 days of Notice of Award, furnish documentation showing that, as a minimum, he has complied with the provisions of Chapter 18 of the Code of Ordinances of the City of Key West in order to enter into the Agreement contained in the Contract Documents.
3. Specifically, within 10 days after Notice of Award, the successful Bidder must demonstrate that he holds, as a minimum, the following licenses and certificates:
 - a.) City of Key West Tax License Receipt;
 - b.) A valid Certificate of Competency issued by the Chief Building Official of Key West, Florida
 - c.) A valid occupational license issued by the City of Key West, Florida.

E. WORK DURING HOLIDAYS

There shall be no work during City Holidays, State Holidays and National Holidays. Any construction operations during these days shall be approved by the City of Key West.

ARTICLE 42 "SAFETY"

Add the following sub article:

OCCUPATIONAL SAFETY AND HEALTH

The Contractor shall observe and comply with all applicable local, state, and federal occupational safety and health regulations during the prosecution of work under this Contract. In addition, full compliance by the Contractor with the U.S. Department of Labor's Occupational Safety and Health Standards, as established in Public Law 91-596, will be required under the terms of this Contract.

ARTICLE 43 "PROTECTION OF WORK AND PROPERTY"

Add the following Article:

HISTORIC PRESERVATION

The Contractor shall comply with Florida's Archives and Historic Act (Florida Statutes, Chapter 267) and the regulations of the local historic preservation board as applicable and protect against the potential loss or destruction of significant historical or archaeological data, sites, and properties in connection with the project.

ARTICLE 57 "OWNERS RIGHT TO TRANSFER EMPLOYMENT"

Add the following Article:

TERMINATION FOR CONVENIENCE AND RIGHT OF SUSPENSION

- A. Owner shall have the right to terminate this Contract without cause by written notice of Termination to the Contractor. In the event of such termination for convenience, the Contractor's recovery against the Owner shall be limited to that portion of the Contract amount earned through the date of termination, together with any retainage withheld and reasonable termination expenses incurred. Contractor shall not be entitled to any other or further recovery against the Owner, including, but not limited to, damages or any anticipated profit on portions of the Work not performed.
- B. The Owner shall have the right to suspend all or any portions of the Work upon giving the Contractor prior written notice of such suspension. If all or any portion of the Work is so suspended, the Contractor shall be entitled to reasonable costs, expenses and time extension associated with the suspension.

ARTICLE 60 "LIQUIDATED DAMAGES"

Delete Article "LIQUIDATED DAMAGES" in its entirety and substitute the following:
LIQUIDATED DAMAGES

Should the Contractor fail to complete the work or any part thereof in the time agreed upon in the Contract Documents or within such extra time as may have been allowed for delays by extensions granted as provided in the Contract, the Contractor shall reimburse the Owner for the additional expense and damage for each calendar day, Sundays and legal holidays included, that project outlined in Contract Documents remains uncompleted after the completion date. Liquidated damages shall be assessed. It is agreed that the amount of such additional expense and damage incurred by reason of failure to complete the work is the per diem rate as stipulated in the Proposal. The said amount is hereby agreed upon as a reasonable estimate

of the costs which may be accrued by the Owner after the expiration of the time of completion. It is expressly understood and agreed that this amount is not to be considered in the nature of a penalty but as liquidated damages, which have accrued against the Contractor. The Owner shall have the right to deduct such damages from any amount due or that may become due the Contractor or the amount of such damages shall be due and collectible from the Contractor or Surety.

ARTICLE 69 "PARTIAL PAYMENTS"

Delete the first paragraph of Article "PARTIAL PAYMENTS" and substitute the following:

No more than once each month the Contractor shall submit to the Engineer a detailed estimate of the amount earned during the preceding month for the separate portions of the work and all Contractor field data along with payment request. As used in this Article the words "amount earned" means the value, on the date of the estimate, for partial payment of the work completed in accordance with the Contract Documents and the value of approved materials delivered to the project site suitably stored and protected prior to incorporation into the work.

ARTICLE 69 "PARTIAL PAYMENTS"

Add the following:

Payment will be made by the Owner to the Contractor within 40 days receipt of the written recommendation of payment from the Engineer.

ARTICLE 69 "PARTIAL PAYMENTS"

Delete Subarticle C "DEDUCTION FROM ESTIMATE" in its entirety and substitute the following:

DEDUCTION FROM ESTIMATE

The OWNER will deduct from the estimate, and retain as part security, 10 percent of the amount earned for work satisfactorily completed. A deduction and retainage of 10 percent will be made on the estimated amount earned for approved items of material delivered to and properly stored at the jobsite but not incorporated into the work. When the work is 90 percent complete, the OWNER may reduce the retainage to 5 percent of the dollar value of all work satisfactorily completed to date provided the CONTRACTOR is making satisfactory progress and there is no specific cause for a greater retainage. The OWNER may reinstate the retainage up to 10 percent if the OWNER determines, at his discretion, that the CONTRACTOR is not making satisfactory progress or where there is other specific cause for such withholding.

ARTICLE 69 "PARTIAL PAYMENTS"

Delete Subarticle E "PAYMENT" in its entirety and substitute the following:

PAYMENT

After deducting the retainage and the amount of all previous partial payments made to the Contractor from the amount earned the amount due will be made payable to the Contractor. Recommendations for payment received by the Owner less than 40 days prior to the scheduled day for payment will not be processed or paid until the following month.

The OWNER will withhold progress payments until the Contractor has satisfied the above conditions.

ARTICLE 72 "FINAL PAYMENT"

Delete Article "FINAL PAYMENT" in its entirety and substitute the following:

FINAL PAYMENT

Upon completion of the work the Contractor shall notify the Engineer, in writing, that he has completed it and shall request final payment. The Contractor shall be responsible for keeping an accurate and detailed record of his actual construction. Upon completion of construction and before final acceptance and payment the Contractor shall furnish the Engineer as-built drawings of his construction. Upon receipt of a request for final payment and the as-built drawings the Engineer will inspect and, if acceptable, submit to the Owner his recommendation as to acceptance of the completed work and as to the final estimate of the amount due the Contractor. Upon approval of this final estimate by the Owner and compliance by the Contractor with provisions in Article RELEASE OF LIENS OR CLAIMS, and other provisions as may be applicable, the Owner shall pay to the Contractor all monies due him under the provisions of these Contract Documents.

ARTICLE 72 "FINAL PAYMENT"

Add the following;

A. Acceptance and Final Payment.

Whenever the Contractor has completely performed the work provided for under the Contract and the Engineer has performed a final inspection and made final acceptance and subject to the terms of the Engineer will prepare a final estimate showing the value of the work as soon as the Engineer makes the necessary measurements and computations. The Engineer will correct all prior estimates and payments in the final estimate and payment. The OWNER will pay the estimate, less any sums that the OWNER may have deducted or retained under the provisions of the Contract, as soon as practicable after final acceptance of the work, provided the Contractor has met the requirements of (1) through (6) below.

- 1 The Contractor has agreed in writing to accept the balance due or refund the overpayment, as determined by the OWNER, as full settlement of his account under the Contract and of all claims in connection therewith, or the Contractor, accepted the balance due or refunded the overpayment, as determined by the OWNER, with the stipulation that his acceptance of such payment or the making of such refund does not constitute any bar, admission, or estoppel, or have any effect as to those payments in dispute or the subject of a pending claim between the Contractor and the OWNER. To receive payment based on a FINAL PAYMENT CERTIFICATE, The Contractor further agrees, by submitting a FINAL PAYMENT CERTIFICATE that any pending or future arbitration claim or suit is limited to those particulars, including the itemized amounts, defined in the original FINAL PAYMENT CERTIFICATE , and that he will commence with any such arbitration claim or suit within 15 calendar days from and after the time of final PAYMENT of the work and that his failure to file a formal claim within this period constitutes his full acceptance of the Engineer's final estimate and payment. The overpayment refund check from the Contractor, if required, will be considered a part of any Acceptance Letter executed.
- 2 The Contractor has properly maintained the project, as specified hereinbefore.
- 3 The Contractor has furnished a sworn affidavit to the effect that the Contractor has paid all bills and no suits are pending (other than those exceptions listed, if any) in connection with work performed under the Contract and that the Contractor has not offered or made any gift or gratuity to, or made any financial transaction of any nature with, any employee of the OWNER in the performance of the Contract.
- 4 The surety on the contract bond consents, by completion of their portion of the affidavit and surety release subsequent to the Contractor's completion of his portion, to final payment to the Contractor and agrees that the making of such payment does not relieve the surety of any of its obligations under the bond.

- 5 The Contractor has furnished all required mill tests and analysis reports to the Engineer.
- 6 Final record drawings will be required before final payment can be made. Final record drawings shall be signed and sealed by a Professional Engineer and/or Surveyor currently licensed in the State of Florida. Record drawing file format shall be compatible with the City's GIS system.

The City is requesting that all supplied data collections, as-builts, drawings, and files to be compatible with ESRI ArcGIS 10.3 Software as these are the solutions that work within its current computing environment. If there are any questions or concerns on whether your files meet this request, please contact the City GIS department at (305) 809-3721.

The current computing environment consists of:

- Microsoft SQL Server
- Windows 10/Server 2008
- ESRI GIS Platform

The City uses a number of software applications critical to its core operation and mission. The proposed mobile asset data collection solution will need to interface or integrate with these existing platforms.

- Arc Collector
- ArcGIS Online
- ArcMap 10.3

ADD ARTICLE 75 RESPONSIBILITY OF CONTRACTOR TO ACT IN AN EMERGENCY

- A. The city shall pay no additional compensation for hurricane and or any other acts of nature.
- B. **CLEANUP PROCEDURES FOR HURRICANE WARNINGS AND HURRICANE WATCH.** In the event the owner or National Oceanographic and Atmospheric Administration (NOAA) issues a Tropical Storm Watch or a Hurricane Watch for the Keys, the Engineer will contact the Contractor informing him that the Watch has been established. Within four (4) hours of the notice the Contractor shall provide the Engineer with a written plan and schedule describing how and when the Contractor will remove all unnecessary items from the work area and tie down all necessary supplies and barricades in the event a Tropical Storm Warning or a Hurricane Warning is issued. The Contractor shall remove all unnecessary items from work areas and shall tie down all movable objects (under 200 lbs.) The Engineer will determine "necessary" items. The Owner shall not be liable for any financial hardship or delays caused as a result of demobilization or remobilization of work due to the above.

ADD ARTICLE 76 CITY OF KEY WEST LICENSES, PERMITS AND FEES

- A. Pursuant to the Public Proposal Disclosure Act, there are a number of licenses, permits, and/or fees a Contractor REQUIRED BY THE CITY OF KEY WEST before or during construction by virtue of this construction as part of the Contract. **Payment of these licenses, permits and/or fees is the responsibility of the Contractor unless specifically excluded.** The Contractor shall verify each required license, permit, or fee before submitting the Proposal.

* * * * *

PART 3

SPECIFICATIONS

**SECTION 01 01 00
GENERAL REQUIREMENTS**

PART 1 PROJECT DESCRIPTION

1.01 GENERAL

- A. A brief description of the Work is stated in the Scope of Work. To determine the full scope of the Project or any particular part of the Project, coordinate the applicable information in the several parts of these Contract Documents.
- B. The Work under this Contract shall be performed by the Contractor as required by the Owner. Work will be authorized in the form of a Notice to Proceed issued to the Contractor. The Contractor shall complete all Work in the Contract within the number of calendar days stipulated in the Contract unless an extension in the time of completion is granted by the Engineer, as stated in the Instructions to Bidders. Upon completion of the Work and compliance with applicable provisions in the Contract Documents, the Contractor will receive final payment for all Work done.
- C. The following additional information, though not all-inclusive, is given to assist contractors in their evaluation of the Work required to meet the Project objectives.
- D. This Project will provide Owner with new control for Effluent Pump FP-3-1 and an installed replacement VFD (Owner furnished).
- E. The Contractor shall become familiar with the existing operating conditions of the Owner's effluent pumping system and take such into consideration in planning and scheduling Work. No extra claims shall be made for Work required to achieve conditions beyond those obtainable under normal operation of the existing sanitary facilities necessary to accomplish the Work.

PART 2 SEQUENCE OF OPERATIONS

2.01 SCHEDULING

- A. General:
 - 1. Submit estimated progress schedule and preliminary schedule of submittals in duplicate to Engineer. Updated progress schedules and submittal schedules shall be submitted with each partial pay request.
 - 2. Revise and resubmit as specified, and identify all changes made from previous schedule submittal.

B. Construction Schedule:

1. Within 10 days following approval of the Shop Drawings and after establishment of equipment delivery dates the Contractor shall provide a bar chart analysis of the required construction Work for the Project. All activities should be shown along with the required time to do the Work in a proper and continuous sequence of operation and without delays.
2. Show complete sequence of construction by activity, identifying Work of separate stages, and other logically grouped activities. Indicate dates for early and late start, early and late finish, float, and duration.
3. Any contingency within the schedule (i.e., a difference in time between the Project's early completion and required Contract completion date) and the float in the overall Project schedule will belong to the Project and not to the parties to the Contract. Contractor shall not sequester shared float through such strategies as extending duration estimates to consume available float time, extensive crew/resource sequencing, etc.
4. Provide a workable plan for monitoring the progress of all elements of the Work, establish the critical elements of Work, and forecast potential problems in maintaining the specified completion dates.

C. Schedule of Submittals:

1. Schedule of Submittals: Indicate submittals required by Specification section number with brief description, starting and completion dates for respective submittal preparation, and submittal review by Engineer.
2. Indicate product manufacture and delivery dates.

D. Plan the Work and carry it out with minimum interference to the operation of the existing facilities. Prior to starting the Work, confer with the Engineer and Owner's representative to develop an approved Work schedule which will permit the facilities to function normally as practical. It may be necessary to do certain parts of the construction Work outside normal working hours in order to avoid undesirable conditions. The Contractor shall do this Work at such times, and at no additional cost to the Owner. Do not make connections between existing Work and new Work until necessary inspection and tests have been completed on the new Work and it is found to conform in all respects to the requirements of the Contract Documents.

E. No Work shall be started until the Contractor has received approved shop Drawings, established material/delivery dates for all equipment, and received approval of the construction schedule from the Engineer. The Contractor shall have sufficient manpower, equipment, and material to complete the Project. No Work shall commence without express consent of the Engineer.

2.02 COORDINATION

- A. Contractors shall cooperate in the coordination of their separate activities in a manner that will provide the least interference with the Owner's operations and other contractors and utility companies working in the area, and in the interfacing and connection of the separate elements of the overall Project Work.
- B. If any difficulty or dispute should arise in the accomplishment of the above, the problem shall be brought immediately to the attention of the Engineer.
- C. All contractors working on the Site are subject to this requirement for cooperation and all shall abide by the Engineer's decision in resolving Project coordination problems without additional cost to the Owner.

2.03 SHUTDOWN OF EXISTING OPERATIONS OR UTILITIES

- A. Continuous operation of the Owner's existing wastewater effluent pumping system is of critical importance.
- B. Contractor will need to keep the wastewater effluent pumping system in operation during construction.
- C. Any Work that requires the temporary shutdown of any existing operations shall be planned in detail with appropriate scheduling of the Work and coordinated with the Owner, and Engineer. Advance notice shall be given in order that the Owner, and Engineer may witness the shutdown, and startup. The temporary shutdown must be approved by the Owner.
- D. All materials and equipment (including emergency equipment) necessary to expedite the shutdown shall be on hand prior to the shutdown of existing services.

2.04 OPERATION OF EXISTING SYSTEM PROHIBITED

- A. At no time undertake to close or open valves or take any other action which would affect the operation of the existing system, except as specifically required by the Drawings and Specifications and after approval is granted by the Owner or Facility Owner. Request approval 5 working days in advance of the time that interruption of the existing system is required.

PART 3 SITE CONDITIONS

3.01 SITE INVESTIGATION AND REPRESENTATION

- A. The Contractor acknowledges satisfaction as to the general nature and location of the Work, the general and local conditions, particularly those bearing upon availability of transportation, availability of labor, electric power, or similar physical conditions, the character of equipment and facilities needed preliminary to and during the prosecution of the Work, and all other matters which can in any way affect the Work or the cost thereof under this Contract.
- B. Failure by the Contractor to become acquainted with the physical conditions and all the available information will not relieve the Contractor from responsibility for properly estimating the difficulty or cost of successfully performing the Work.
- C. The Contractor warrants that as a result of examination and investigation of all the aforesaid data, the Contractor can perform the Work in a good and workmanlike manner and to the satisfaction of the Owner. The Owner assumes no responsibility for any representations made by any of its officers or agents during or prior to the execution of this Contract, unless (1) such representations are expressly stated in the Contract, and (2) the Contract expressly provides that the responsibility therefore is assumed by the Owner.

PART 4 TEMPORARY CONSTRUCTION UTILITIES AND FACILITIES

4.01 TEMPORARY WATER

- A. The Contractor shall make his own arrangements to obtain suitable water and shall pay all costs.

4.02 SANITARY FACILITIES

- A. The Contractor shall provide and maintain sanitary facilities for his employees and his subcontractors that will comply with the regulations of the local and state departments of health and as directed by the Engineer.

4.03 STORAGE OF MATERIALS

- A. Materials shall be stored based on manufacturer's instructions including pre- and post-storage meggering as to ensure the preservation of their quality and fitness for the Work. When considered necessary they shall be placed on wooden platforms or other hard, clean surfaces, and not on the ground. Stored materials shall be located so as to facilitate prompt inspection. Private property shall not be used for storage purposes without the written permission of the Owner or lessee.

- B. Delicate instruments and materials subject to vandalism shall be placed under locked cover and, if necessary, provided with temperature control as recommended by the manufacturer.

PART 5 SALVAGE OF MATERIALS

5.01 MATERIAL TO BE SALVAGED

- A. Materials to be salvaged include: NONE.

PART 6 SAFETY AND CONVENIENCE

6.01 SAFETY EQUIPMENT

- A. During construction, the Contractor shall construct and at all times maintain satisfactory and substantial temporary, barricades, as applicable, at all openings, obstructions, or other hazards in streets, sidewalks, floors, roofs, and walkways.

6.02 ACCIDENT REPORTS

- A. In addition, the Contractor must promptly report in writing to the Engineer all accidents whatsoever arising out of, or in connection with, the performance of the Work whether on, or adjacent to, the Site, giving full details and statements of witnesses. If death or serious injuries or serious damages are caused, the accident shall be reported immediately by telephone or messenger to the Engineer.
- B. If a claim is made by anyone against the contractor or any subcontractor on account of any accident, the Contractor shall promptly report the facts in writing to the Engineer, giving full details of the claim.

6.03 SAFE ACCESS BY FEDERAL, STATE, AND LOCAL GOVERNMENT OFFICIALS

- A. Authorized representatives of the state, federal, or local governmental agencies, shall at all times have safe access to the Work, and the Contractor shall provide proper facilities for such access and inspection.

6.04 PROTECTION OF PROPERTY

- A. Protect stored materials located adjacent to the proposed Work.
- B. The Contractor shall identify and isolate his Work zone in such a manner as to exclude all personnel not employed by him, the Engineer, and the Owner.

6.05 FIRE PREVENTION AND PROTECTION

- A. The Contractor shall perform all Work in a fire-safe manner. He shall supply and maintain on the Site adequate fire-fighting equipment capable of extinguishing incipient fires. The Contractor shall comply with applicable federal, state, and local fire-prevention regulations. Where these regulations do not apply, applicable parts of the National Fire Prevention Standard for Safeguarding Building Construction Operations (NFPA No. 241) shall be followed.

6.06 CLEANUP PROCEDURES FOR HURRICANE WARNINGS AND HURRICANE WATCHES

- A. In the event that the National Oceanographic and Atmospheric Administration (NOAA), issues a hurricane watch for the Florida Keys, the Engineer will contact the Contractor informing him that the watch has been established within 4 hours of the notice. The Contractor shall implement the approved plan and schedule describing how and when the Contractor will remove all unnecessary items from the Work area and tie down all remaining supplies and barricades in the event that a hurricane warning is issued. If a warning is issued, the Contractor shall remove all unnecessary items from the Work area(s) and shall tie down all movable (under 200 pounds) objects. The Engineer will determine “necessary” items. The Owner will not be liable for any financial hardship or delays caused as a result of demobilization or remobilization due to the above.

PART 7 PRESERVATION, RESTORATION, AND CLEANUP

7.01 SITE RESTORATION AND CLEANUP

- A. At all times during the Work, keep the premises clean and orderly, and upon completion of the Work, repair all damage caused by equipment and leave the Project free of rubbish or excess materials of any kind.

PART 8 SUBMITTALS DURING CONSTRUCTION

8.01 RECORD DRAWINGS

- A. The Contractor shall maintain a complete set of record Drawings to show any items which differ from those shown on Drawings. Such Drawings shall be updated daily and submitted each month with the partial pay request. Final record Drawings will be required before substantial completion can be certified and final payment can be made.
- B. The Contractor shall keep the Engineer apprised on a weekly basis, by providing Drawing mark-ups of the items that differ.

PART 9 PRE- AND POST-CONSTRUCTION VIDEO RECORDINGS

9.01 GENERAL

- A. The Contractor shall provide color videos showing the pre-construction Site, and the post-construction Site. The videos shall be in digital (DVD) format, the video shall indicate on the DVD the date, job title, and brief description of the video and location where the video was taken. Video shall be subject to review and approval by Engineer. Two copies of the video DVD (including the original) shall be delivered to the Engineer as follows:
1. A video shall be taken of the preconstruction conditions, as well as all storage and staging areas.
 2. A video shall be taken of the post-construction conditions.
- B. The Following shall be Included with the Video Documentation:
1. Coverage is required within and adjacent to the storage, and staging areas where the Work is being constructed.
 2. Certification as to date Work done and by whom.
 3. All videos shall be keyed to the construction Drawings.
- C. Pre-Construction and Post-Construction on Videos shall be Submitted as Follows:
1. Pre-construction videos shall be presented to the Owner at the pre-construction conference.
 2. Post-construction videos shall be submitted prior to final Project closeout. This submittal is contingent to final payment.

END OF SECTION

SCOPE OF WORK**PART 1 - SCOPE OF WORK**

1.1 DESCRIPTION

- A. Work Included: The design and furnishing of all materials, equipment and labor for the construction/implementation of EFFLUENT PUMP EF-3-1 CONTROL AND INSTALLATION OF OWNER FURNISHED VFD REPLACEMENT and all necessary appurtenances and record drawings, surveys, and incidental work to provide a complete and serviceable project identified as:

EFFLUENT PUMP FP-3-1- CONTROL AND VFD REPLACEMENT

- B. Related requirements in other parts of the Contract Documents: General and Supplementary Conditions of the Contract for Construction.
- C. Contractor's Duties:
1. In addition to provisions stipulated in other portions of the Contract Documents, the Contractor shall:
 - a. Secure permits as necessary for proper execution and completion of the work.
 - b. Obtain Access passes for all personnel working on this project from the US Navy at the Commercial Gate on Boca Chia Key.
- D. The Contractor shall be totally responsible for all permits required and shall ensure that construction complies with all applicable local, state, and federal codes.
- E. The Contractor shall provide an experienced, qualified, and competent Superintendent to oversee the Work and perform quality assurance inspections. Prior to starting construction, the proposed Superintendent's qualifications shall be submitted in writing to the City for approval. The approved Superintendent shall be expected to remain for the duration of the Project, unless the City or Engineer deem him/her inadequate and requests his/her removal or the Contractor cannot continue his services to the Project for a reason or reasons that shall be communicated in writing to the City.
- F. A replacement Superintendent shall be required to follow the same approval process as required for the original. The Superintendent shall provide to the City Inspector Construction Reports for each day of construction, the reports shall be in English, legible, and signed. Contractor shall provide PDF copies monthly. Reports shall include quantity control checks done daily.

- G. It shall be the Contractor's responsibility to request approval for entrance to the site for work on Saturdays, Sundays, holiday, and weekday hours other than 7:00 AM until 7:00 PM. No construction can commence before 8:00 AM on weekdays.
- H. The Contractor shall provide material safety data sheets (2 copies) for chemicals, paints, coatings and materials used on-site prior to initiation of work.

1.2 CONTRACTOR'S USE OF PREMISES

- A. Work shall be scheduled as to not interfere with on-going area activities.
- B. Coordinate use of premises and requirements for security under direction of City.
- C. This is a smoke free construction zone. **NO SMOKING PERMITTED WITHIN CONSTRUCTION ZONE.**
- D. Assume full responsibility for the protection and safekeeping of products, under this Contract, stored on the Site.
- E. Obtain and pay for the use of additional storage or work areas needed for operation.
- F. Contractor shall provide drinking water and toilet facilities for construction personnel; The City will not provide.

1.3 MAINTENANCE OF EXISTING UTILITIES OPERATION

- A. Provide at least three weeks' notice prior to interruption of services for temporary or permanent connections.
- B. Keep interruption of utility services, and utility outages during disconnection, moving, and reconnection to a minimum.
- C. The Contractor is to coordinate all connections with plant personnel to minimize downtime and interruption of treatment.

1.4 OWNER SUPPLIED EQUIPMENT

- A. Owner will supply the following equipment to the Contractor for installation:
 - a. Variable Frequency Drive unit per specification 26 29 23 VFD Motor Controller.
- B. Contractor to provide labor, material, equipment, tools, consumable supplies, and incidentals not specifically required by the contract between Owner and Supplier but required to provide a complete and operable product.

END OF SECTION

SECTION 01 29 00
PAYMENT PROCEDURES

PART 1 GENERAL

1.01 SUBMITTALS

- A. Informational Submittals:
 - 1. Schedule of Values: Submit on Contractor's standard form.
 - 2. Schedule of Estimated Progress Payments:
 - a. Submit with initially acceptable Schedule of Values.
 - b. Submit adjustments thereto with Application for Payment.
 - 3. Application for Payment.
 - 4. Final Application for Payment.

1.02 ALLOWANCES

- A. Consult with Engineer in selection of products or services. Obtain proposals from Suppliers and offer recommendations.
- B. Allowances will be administered in accordance with the Bid Form.
- C. Submit, with application for payment, invoice showing date of purchase, from whom the purchase was made, the date of delivery of the product or service, and the price, including delivery to the Site and applicable taxes.

1.03 SCHEDULE OF VALUES

- A. Prepare a separate Schedule of Values for each schedule of the Work under the Agreement.
- B. Upon request of Engineer, provide documentation to support the accuracy of the Schedule of Values.
- C. Lump Sum Work:
 - 1. Reflect specified contingency allowances and alternates, as applicable.
 - 2. List bonds and insurance premiums, mobilization, demobilization, preliminary and detailed progress schedule preparation, equipment testing, facility startup, and contract closeout separately.
- D. An unbalanced or front-end loaded schedule will not be acceptable.
- E. Summation of the complete Schedule of Values representing all the Work shall equal the Contract Price.

1.04 SCHEDULE OF ESTIMATED PROGRESS PAYMENTS

- A. Show estimated payment requests throughout Contract Times aggregating initial Contract Price.
- B. Base estimated progress payments on initially acceptable progress schedule. Adjust to reflect subsequent adjustments in progress schedule and Contract Price as reflected by modifications to the Contract Documents.

1.05 APPLICATION FOR PAYMENT

- A. Transmittal Summary Form: Attach one Summary Form with each detailed Application for Payment for each schedule and include Request for Payment of Materials and Equipment on Hand as applicable. Execute certification by authorized officer of Contractor.
- B. Use detailed Application for Payment Form provided by Owner.
- C. Provide separate form for each schedule as applicable.
- D. Include accepted Schedule of Values for each schedule or portion of lump sum Work and the unit price breakdown for the Work to be paid on a unit priced basis.
- E. Include separate line item for each Change Order and Work Change Directive executed prior to date of submission. Provide further breakdown of such as requested by Engineer.
- F. Preparation:
 - 1. Round values to nearest dollar.
 - 2. Submit Application for Payment, including a Transmittal Summary Form and detailed Application for Payment Form(s) for each schedule as applicable, a listing of materials on hand for each schedule as applicable, and such supporting data as may be requested by Engineer.

1.06 PAYMENT

- A. Payment for all Lump Sum Work shown or specified in Contract Documents is included in the Contract Price. Payment will be based on a percentage complete basis for each line item of the accepted Schedule of Values.

1.07 NONPAYMENT FOR REJECTED OR UNUSED PRODUCTS**A. Payment will not be made for following:**

1. Loading, hauling, and disposing of rejected material.
2. Quantities of material wasted or disposed of in manner not called for under Contract Documents.
3. Rejected loads of material, including material rejected after it has been placed by reason of failure of Contractor to conform to provisions of Contract Documents.
4. Material not unloaded from transporting vehicle.
5. Defective Work not accepted by Owner.
6. Material remaining on hand after completion of Work.

1.08 PARTIAL PAYMENT FOR STORED MATERIALS AND EQUIPMENT

- A. **Partial Payment:** No partial payments will be made for materials and equipment delivered or stored unless Shop Drawings and preliminary operation and maintenance data is acceptable to Engineer.
- B. **Final Payment:** Will be made only for products incorporated in Work; remaining products, for which partial payments have been made, shall revert to Contractor unless otherwise agreed, and partial payments made for those items will be deducted from final payment.

PART 2 PRODUCTS (NOT USED)**PART 3 EXECUTION (NOT USED)****END OF SECTION**

SECTION 01 31 19
PROJECT MEETINGS

PART 1 GENERAL

1.01 GENERAL

- A. Owner will schedule physical arrangements for meetings throughout progress of Work, prepare meeting agenda with regular participant input and distribute with written notice of each meeting, preside at meetings, record minutes to include significant proceedings and decisions, and reproduce and distribute copies of minutes within 5 days after each meeting to participants and parties affected by meeting decisions.

1.02 PRECONSTRUCTION CONFERENCE

- A. Contractor shall be prepared to discuss the following subjects, as a minimum:
1. Required schedules (Preliminary Construction Schedule, Schedule of Values, Submittal).
 2. Status of Bonds and insurance.
 3. Sequencing of critical path work items.
 4. Progress payment procedures.
 5. Project changes and clarification procedures.
 6. Use of site, access, office and storage areas, security and temporary facilities.
 7. Major product delivery and priorities.
 8. Contractor's safety plan and representative.
 9. Preliminary Hurricane Evaluation Plan.
- B. Attendees will Include:
1. Owner's representatives.
 2. Contractor's office representative.
 3. Contractor's resident superintendent.
 4. Contractor's quality control representative.
 5. Subcontractors' representatives whom Contractor may desire or Engineer may request to attend.
 6. Engineer's representatives.
 7. Others as appropriate.

1.03 PROGRESS MEETINGS

- A. Owner will schedule regular progress meetings at Site, conducted monthly to review Work progress, progress schedule, Shop Drawing and Sample submissions schedule, Application for Payment, contract modifications, and other matters needing discussion and resolution.

B. Attendees will Include:

1. Owner's representative(s), as appropriate.
2. Contractor, Subcontractors, and Suppliers, as appropriate.
3. Engineer's representative(s).
4. Others as appropriate.

1.04 QUALITY CONTROL AND COORDINATION MEETINGS

A. Scheduled by Owner on regular basis and as necessary to review test and inspection reports, and other matters relating to quality control of Work and work of other contractors.

B. Attendees will Include:

1. Contractor.
2. Contractor's designated quality control representative.
3. Subcontractors and Suppliers, as necessary.
4. Engineer's representatives.

1.05 PREINSTALLATION MEETINGS

A. When required in individual Specification sections, convene at Site prior to commencing Work of that section.

B. Require attendance of entities directly affecting, or affected by, Work of that section.

C. Notify Engineer 4 days in advance of meeting date.

D. Provide suggested agenda to Engineer to include reviewing conditions of installation, preparation and installation or application procedures, and coordination with related Work and work of others.

1.06 OTHER MEETINGS

A. In accordance with Contract Documents and as may be required by Owner and Engineer.

PART 2 PRODUCTS (NOT USED)

PART 3 EXECUTION (NOT USED)

END OF SECTION

**SECTION 01 32 00
PROGRESS SCHEDULES**

PART 1 GENERAL

1.01 SUBMITTALS

- A. Preliminary Progress Schedule: Submit within time specified in paragraph 53 of the General Conditions.
- B. Detailed Progress Schedule: Submit initial Detailed Progress Schedule within 30 days after Effective Date of the Agreement.
- C. Submit with Each Progress Schedule Submission:
 - 1. Contractor's certification that progress schedule submission is the actual schedule being utilized for execution of the Work.
 - 2. Progress Schedule: Four legible copies.
 - 3. Narrative Progress Report: Same number of copies as specified for Progress Schedule.
- D. Prior to final payment, submit a final Updated Progress Schedule.

1.02 PRELIMINARY PROGRESS SCHEDULE

- A. In addition to basic requirements outlined in General Conditions, show a detailed schedule, beginning with Notice to Proceed, for minimum duration of 120 days, and a summary of balance of Project through Final Completion.
- B. Show activities including, but not limited to the following:
 - 1. Notice to Proceed.
 - 2. Permits.
 - 3. Submittals, with review time.
 - 4. Early procurement activities for long lead equipment and materials.
 - 5. Initial site work.
 - 6. Earthwork.
 - 7. Specified Work sequences and construction constraints.
 - 8. Contract Milestone and Completion Dates.
 - 9. Owner-furnished products delivery dates or ranges of dates.
 - 10. Major structural, mechanical, equipment, electrical, architectural, and instrumentation and control Work.
 - 11. System startup summary.
 - 12. Project close-out summary.
 - 13. Demobilization summary.

- C. Update Preliminary Progress Schedule monthly; as part of progress payment process. Failure to do so may cause Owner to withhold all or part of the monthly progress payment until the Preliminary Progress Schedule is updated in a manner acceptable to Engineer.
- D. Format: In accordance with Article Progress Schedule - Bar Chart.
- E. Detailed progress schedule.
- F. In addition to requirements of General Conditions, submit Detailed Progress Schedule beginning with Notice to Proceed and continuing through Final Completion.
- G. Show the duration and sequences of activities required for complete performance of the Work reflecting means and methods chosen by Contractor.
- H. When accepted by Engineer, Detailed Progress Schedule will replace Preliminary Progress Schedule and become Baseline Schedule. Subsequent revisions will be considered as Updated Progress Schedules.
- I. Update monthly to reflect actual progress and occurrences to date, including weather delays.

1.03 PROGRESS SCHEDULE - BAR CHART

- A. General: Comprehensive bar chart schedule, generally as outlined in Associated General Contractors of America (AGC) Publication No. 1107.1, "Construction Planning and Scheduling, latest edition. If a conflict occurs between the AGC publication and this specification, this specification shall govern.
- B. Format:
 - 1. Unless otherwise approved, white paper, 11-inch by 17-inch sheet size.
 - 2. Title Block: Show name of project and Owner, date submitted, revision or update number, and name of scheduler.
 - 3. Identify horizontally, across the top of the schedule, the time frame by year, month, and day.
 - 4. Identify each activity with a unique number and a brief description of the Work associated with that activity.
 - 5. Legend: Describe standard and special symbols used.

- C. Contents: Identify, in chronological order, those activities reasonably required to complete the Work, including as applicable, but not limited to:
1. Obtaining permits, submittals for early product procurement and long lead time items.
 2. Mobilization and other preliminary activities.
 3. Initial site work.
 4. Specified Work sequences, constraints, and Milestones, including Substantial Completion date(s) Subcontract Work.
 5. Major equipment design, fabrication, factory testing, and delivery dates.
 6. Equipment Work.
 7. Mechanical Work.
 8. Electrical Work.
 9. Instrumentation and control Work.
 10. Other important Work for each major facility.
 11. Equipment and system startup and test activities.
 12. Project closeout and cleanup.
 13. Demobilization.

1.04 PROGRESS OF THE WORK

- A. Updated Progress Schedule shall reflect:
1. Progress of Work to within 5 working days prior to submission.
 2. Approved changes in Work scope and activities modified since submission.
 3. Delays in Submittals or resubmittals, deliveries, or Work.
 4. Adjusted or modified sequences of Work.
 5. Other identifiable changes.
 6. Revised projections of progress and completion.
 7. Report of changed logic.
- B. Produce detailed sub-schedules during Project, upon request of Owner or Engineer, to further define critical portions of the Work such as facility shutdowns, etc.
- C. If Contractor fails to complete activity by its latest scheduled completion date and this failure is anticipated to extend Contract Times (or Milestones), Contractor shall, within 7 days of such failure, submit a written statement as to how Contractor intends to correct nonperformance and return to acceptable current progress schedule. Actions by Contractor to complete Work within Contract Times (or Milestones) will not be justification for adjustment to Contract Price or Contract Times.

- D. Owner may order Contractor to increase labor force or working hours if Contractor fails to:
 - 1. Complete a Milestone activity by its completion date.
 - 2. Satisfactorily execute Work as necessary to prevent delay to overall completion of Project, at no additional cost to Owner.

1.05 NARRATIVE PROGRESS REPORT

- A. Format:
 - 1. Organize same as Progress Schedule.
 - 2. Identify, on a cover letter, reporting period, date submitted, and name of author of report.
- B. Contents:
 - 1. Number of days worked over the period, work force on hand, construction equipment on hand (including utility vehicles such as pickup trucks, maintenance vehicles, stake trucks, etc.).
 - 2. General progress of Work, including a listing of activities started and completed over the reporting period, mobilization/demobilization of subcontractors, and major milestones achieved.
 - 3. Contractor's plan for management of site (e.g., lay down and staging areas, construction traffic, etc.), utilization of construction equipment, buildup of trade labor, and identification of potential Contract changes.
 - 4. Identification of new activities and sequences as a result of executed Contract changes.
 - 5. Documentation of weather conditions over the reporting period, and any resulting impacts to the work.
 - 6. Description of actual or potential delays, including related causes, and the steps taken or anticipated to mitigate their impact.
 - 7. Changes to activity logic.
 - 8. Changes to the critical path.
 - 9. Identification of, and accompanying reason for, any activities added or deleted since the last report.
 - 10. Steps taken to recover the schedule from Contractor-caused delays.

1.06 SCHEDULE ACCEPTANCE

- A. Engineer's acceptance will demonstrate agreement that the proposed schedule conforms with requirements of Contract including, but not limited to, the following:
 - 1. Contract Times, including Final Completion and all intermediate Milestones are within the specified times.
 - 2. Specified Work sequences and constraints are shown as specified.

3. Complete Scope of Work is included.
4. Specified Owner furnished Equipment or Material arrival dates, or range of dates, are included.
5. Access restrictions are accurately reflected.
6. Start-up and testing times are as specified.
7. Training time is as specified.
8. Level of detail is as specified herein.
9. Submittal submission and review times are as specified.
10. Duration of activities are reasonable.
11. Sequencing is reasonable and does not include preferential logic contrary to the contingency/float sharing clauses of this Specification.
12. Meets all administrative requirements of Contract Documents.
13. Updated schedules reflect actual dates and duration of Work performed.

B. Preliminary Progress Schedule Review Disposition:

1. Accepted.
2. Rejected as Noted:
 - a. Make requested corrections; resubmit within 10 days.
 - b. Until acceptable to Engineer as the Baseline Progress Schedule, continue the review and revision process, during which time Contractor shall update the schedule on a monthly basis to reflect actual progress and occurrences to date.

C. Detailed Progress Schedule:

1. Accepted.
2. Rejected as Noted:
 - a. Make requested corrections; resubmit within 10 days.
 - b. Until acceptable to Engineer as the Baseline Progress Schedule, continue the review and revision process.

D. Narrative Report: All changes to activity duration and sequences, including the addition or deletion of activities subsequent to Engineer's acceptance of the Baseline Progress Schedule, shall be delineated in the Narrative Report current with the proposed Updated Progress Schedule.

1.07 ADJUSTMENT OF CONTRACT TIMES

- A. Reference General Conditions.
- B. Evaluation and reconciliation of Adjustments of Contract Times shall be based on the Updated Progress Schedule at the time of proposed adjustment or claimed delay.

C. Schedule Contingency:

1. Contingency, when used in the context of the Progress Schedule, is time between Contractor's proposed Completion Time and Contract Completion Time.
2. Contingency included in Progress Schedule is a Project resource available to both Contractor and Owner to meet Contract Milestones and Contract Times. Use of Schedule contingency shall be shared to the proportionate benefit of both parties.
3. Use of schedule contingency suppression techniques such as preferential sequencing and extended activity times are prohibited.
4. Pursuant to Contingency sharing provisions of this Specification, no time extensions will be granted, nor will delay damages be paid until a delay occurs which (i) consumes all available contingency time, and (ii) extends Work beyond the Contract Completion date.

D. Claims Based on Contract Times:

1. Where Engineer has not yet rendered formal decision on Contractor's claim for adjustment of Contract Times, and parties are unable to agree as to amount of adjustment to be reflected in progress schedule, Contractor shall reflect an interim adjustment in the progress schedule as acceptable to Engineer.
2. It is understood and agreed that such interim acceptance will not be binding on either Contractor or Owner, and will be made only for the purpose of continuing to schedule Work until such time as formal decision has been rendered as to an adjustment, if any, of the Contract Times.
3. Contractor shall revise progress schedule prepared thereafter in accordance with Engineer's formal decision.

PART 2 PRODUCTS (NOT USED)

PART 3 EXECUTION (NOT USED)

END OF SECTION

SECTION 01 33 00
SUBMITTALS

PART 1 GENERAL

1.01 GENERAL

- A. Inquiries: Direct to Engineer regarding procedure, purpose, or extent of Submittal.
- B. Timeliness: Schedule and make submissions in accordance with requirements of individual Specification sections and in such sequence as to cause no delay in Work or in Work of other contractors.
- C. Identification of Submittals:
 - 1. Complete, sign, and transmit with each Submittal package, one Transmittal of Contractor's Submittal Form attached at end of this Section.
 - 2. Identify each Submittal with the following numbering and tracking system:
 - a. Sequentially number each Submittal.
 - b. Resubmission of a Submittal will have original number with sequential alphabetic suffix.
 - 3. Format: Orderly, indexed with labeled tab dividers.
 - 4. Show date of submission.
 - 5. Show Project title and Owner's contract identification and contract number.
 - 6. Show names of Contractor, Subcontractor or Supplier, and manufacturer as appropriate.
 - 7. Identify, as applicable, Contract Document section and paragraph to which Submittal applies.
 - 8. Identify Submittal type; submit only one type in each Submittal package.
 - 9. Identify and indicate each deviation or variation from Contract Documents.
- D. Resubmissions: Clearly identify each correction or change made.
- E. Incomplete Submittal Submissions:
 - 1. Engineer will return entire Submittal for Contractor's revision/correction and resubmission.
 - 2. Submittals which do not clearly bear Contractor's specific written indication of Contractor review and approval of Submittal or which are transmitted with an unsigned or uncertified submission form or as may otherwise be required will be returned to Contractor unreviewed.

- F. Nonspecified Submissions: Submissions not required under these Contract Documents and not shown on submissions will not be reviewed and will be returned to Contractor.
- G. Engineer's Review: Engineer will act upon Contractor's Submittal and transmit response to Contractor not later than 20 working days after receipt, unless otherwise specified. Resubmittals will be subject to same review time.
- H. Schedule Delays:
 - 1. No adjustment of Contract Times or Price will be allowed due to Engineer's review of Submittals, unless all of the following criteria are met:
 - a. Contractor has notified Engineer in writing that timely review of Submittal in question is critical to progress of Work, and has received Engineer's written acceptance to reflect such on current accepted submissions and progress schedule. Written agreement by the Engineer to reduce Submittal review time will be made only for unusual and Contractor-justified reasons. Acceptance of a progress schedule containing Submittal review times less than specified or less than agreed to in writing by Engineer will not constitute Engineer's acceptance of review times.
 - b. Engineer has failed to review and return first submission of a Submittal within agreed time indicated on current accepted schedule of submissions or, if no time is indicated thereon, within 30 days after receipt.
 - c. Contractor demonstrates that delay in progress of Work is directly attributable to Engineer's failure to return Submittal within time indicated and accepted by Engineer.
 - 2. No adjustment of Contract Times or Price will be allowed due to delays in progress of Work caused by rejection and subsequent resubmission of Submittals, including multiple resubmissions.

1.02 SHOP DRAWINGS AND SAMPLES

- A. Copies:
 - 1. Shop Drawings and Product Data: Submit four copies, plus whatever the Contractor requires to be returned, maximum eight.
 - 2. Samples: Two, unless otherwise specified in individual Specification sections.

3. Electronic Submittals: Contractor may be required to submit all documents electronically. If so the following will be followed:
 - a. Each submittal shall be an electronic file in Adobe Acrobat Portable Document Format (PDF). Use the latest version available at the time of execution of the Contract Documents. Electronic files which contain more than ten (10) pages in Adobe Acrobat format shall contain internal book-marking from an index page to major sections of the document. PDF files shall be set to open “Bookmarks and Page” view. General information shall be added to each PDF file, including Title, Subject, Author, and Keywords.
 - b. The PDF files shall be set up to print legibly at either 8-1/2-inch by 11-inch, 11-inch by 17-inch or 22-inch by 34-inch.
 - c. New electronic files shall be required for each submittal.
 - d. Each electronic file shall also include a copy of the Submittal Transmittal Form and completed Submittal Checklist.
 - e. Submittals shall be transmitted by uploading the PDF file of the submittal to the project SharePoint site. Submittal review comments will be transmitted back to the Subcontractor electronically via the project SharePoint site as well.
 - f. Subcontractor shall provide authorization to reproduce and/or distribute each file as many times as necessary for the Project.
 - g. Subcontractor shall include all costs for preparation and transmittal of electronic submittals in its bid, including all resubmittals and final record copies.
 - h. Final Record Copies: After all initial and resubmittal information has been approved, consolidate all information and responses to comments into one conformed record copy. Provide one electronic copy of the conformed record copy to CH2M HILL to verify incorporation of previously submitted data. Hard copies, number as required herein, that exactly match the final conformed electronic copy of the submittal will be submitted to CH2M HILL within 30 days of approval of the electronic copy.
- B. General: Submit to Engineer as required by individual Specification sections.
- C. Identify and Indicate:
1. Pertinent Drawing sheet(s) and detail number(s), products, units and assemblies, and system or equipment identification or tag numbers.
 2. Critical field dimensions and relationships to other critical features of Work.
 3. Samples: Source, location, date taken, and by whom.
 4. Each deviation or variation from Contract Documents.
 5. Proper storage and maintenance requirements.

- D. Design Data: When specified, provide Project-specific information as required and as necessary to clearly show calculations, dimensions, logic and assumptions, and referenced standards and codes upon which design is based.
- E. Foreign Manufacturers: When proposed, include following additional information:
 - 1. Names and addresses of at least two companies closest to Project that maintain technical service representatives.
 - 2. Complete inventory of spare parts and accessories for each piece of equipment.
- F. Preparation:
 - 1. Format: Whenever possible, schedule for and combine Shop Drawings and Samples required for submission in each Specification section or division into a single Submittal package. Also combine product data for like items into a single Submittal package.
 - 2. Present in a clear and thorough manner and of sufficient detail to show kind, size, arrangement, and function of components, materials, and devices and compliance with Contract Documents. Identify details by reference to sheet and detail, and schedule or room numbers shown on Drawings.
 - 3. Reproducible Copy:
 - a. Preferred Minimum Sheet Size: 8-1/2- by 11-inch and 11- by 17-inch pages, suitable for photocopying.
 - b. Larger than 11- by 17-Inch Sheets: 22-inch by 34-inch preferred, mylar or sepias suitable for copying in a blueprint machine.
 - 4. Piping Systems: Drawn to scale.
 - 5. Product Data: Clearly mark each copy to identify pertinent products or models and show performance characteristics and capacities, dimensions and clearances required, wiring or piping diagrams and controls, and external connections, anchorage, and supports required.
 - 6. Equipment and Component Titles: Identical to title shown on Drawings.
 - 7. Manufacturer's Standard Schematic Drawings and Diagrams as Follows:
 - a. Modify to delete information that is not applicable to Work.
 - b. Supplement standard information to provide information specifically applicable to Work.
- G. Shop Drawing Disposition: Engineer will review, mark, and stamp as appropriate and distribute marked-up copies as noted:
 - 1. Approved as Submitted (for Incorporation in Work):
 - a. Two copies furnished Owner.
 - b. One copy furnished Resident Project Representative.
 - c. One copy retained in Engineer's file.

- d. Remaining copies returned to Contractor appropriately annotated.
 - e. Contractor may begin to implement activities to incorporate specific product(s) or Work covered by Submittal.
2. Approved as Noted (for Incorporation in Work):
- a. Two copies furnished Owner.
 - b. One copy furnished Resident Project Representative.
 - c. One copy retained in Engineer's file.
 - d. Remaining copies returned to Contractor appropriately annotated.
 - e. Contractor may begin to implement activities to incorporate product(s) or Work covered by Submittal, in accordance with Engineer's notations.
3. Disapproved:
- a. One copy furnished Resident Project Representative.
 - b. One copy retained in Engineer's file.
 - c. Remaining copies returned to Contractor appropriately annotated.
 - d. Contractor shall make corrections or develop replacement and resubmit (in same manner and quantity as specified for original submission).
 - e. Submittal is not approved.
4. Incomplete:
- a. One copy furnished Resident Project Representative.
 - b. One copy retained in Engineer's file.
 - c. Remaining copies returned to Contractor appropriately annotated.
 - d. Contractor shall complete and resubmit or submit missing portions.
 - e. Submittal is not approved.

H. Sample Disposition: Same as Shop Drawing disposition; samples will not be returned.

1.03 ADMINISTRATIVE SUBMITTALS

- A. Copies: Submit four.
- B. Description: Submittals that are not Shop Drawings or Samples, or that do not reflect quality of product or method of construction. May include, but not limited to those Submittals identified below.
- C. Applications for Payment (and Cash Allowance Data and Values): Meet requirements of Section 01 29 00, Payment Procedures.
- D. Progress Reports and Quantity Charts: As may be required in Section 01 32 00, Progress Schedules.

- E. Hurricane Evaluation Plan: The Contractor shall prepare the Engineer with a written plan and schedule describing how and when the Contractor will remove all unnecessary items from the work area and tie down all remaining supplies and barricades in the event that a hurricane warning is issued, identifying gussets in particular. If a warning is issued, the Contractor shall remove all unnecessary items from the work area(s) and will tie down all movable (under 200 pounds) objects. The Owner shall not be liable for any financial hardship or delays caused as a result of demobilization or remobilization due to the above.

- F. Schedules:
 - 1. Progress Schedule(s): Meet the requirements of Section 01 32 00, Progress Schedules.
 - 2. Schedule of Values: Meet requirements of Section 01 29 00, Payment Procedures.
 - 3. Schedule of Submittal Submissions:
 - a. Prepare and submit, preliminary list of submissions grouped by Contract Document article/paragraph number or Specification section number, with identification, numbering and tracking system as specified under Paragraph Identification of Submittals and as approved by Engineer.
 - b. Include Only the Following Required Submissions:
 - 1) Shop Drawings and Samples.
 - 2) Training plans.
 - 3) Test procedures.
 - 4) Operation and maintenance manuals.
 - 5) Record documents.
 - 6) Specifically required certificates, warranties, and service agreements.
 - c. Coordinate with progress schedule and prepare submissions to show for each Submittal, at a minimum, the following:
 - 1) Estimated submission date to Engineer.
 - 2) Specifically requested and clearly identified Engineer review time if shorter than that set forth herein, with justification for such request and critical dates Submittals will be needed from Engineer.
 - 3) For first 6-month period from the date the Contract Times commence or following any update or adjustment of the submissions, the estimated submission date shall be week, month, and year; for submissions beyond 6-month time period, show closest month and year.

- d. Submit to Engineer Monthly:
 - 1) Updated list if changes have occurred. Otherwise, submit a written communication confirming existing list.
 - 2) Adjusted submissions reflecting submission activity planned for forthcoming 6-month time period and beyond. Coordinate with progress schedule updates.

- G. Submittals Required by Laws, Regulations, and Governing Agencies:
 - 1. Submit promptly notifications, reports, certifications, payrolls, and otherwise as may be required, directly to the applicable federal, state, or local governing agency or their representative.
 - 2. Transmit to Engineer for Owner's records one copy of correspondence and transmittals (to include enclosures and attachments) between Contractor and governing agency.

- H. Disposition: Engineer will review, stamp, and indicate requirements for resubmission or acceptance on Submittal as follows:
 - 1. Accepted:
 - a. Acceptance will indicate that Submittal conforms to intent of Contract Documents as to form and substance.
 - b. Contractor may proceed to perform Submittal related Work.
 - c. One copy furnished Owner.
 - d. One copy furnished Resident Project Representative.
 - e. One copy retained in Engineer's file.
 - f. Remaining copies returned to Contractor appropriately annotated.
 - 2. Rejected as Noted:
 - a. One copy retained in Engineer's file.
 - b. Remaining copies returned to Contractor appropriately annotated.
 - c. Contractor shall revise/correct or develop replacement and resubmit.

1.04 QUALITY CONTROL SUBMITTALS

- A. Certificates: Certificates of Successful Testing or Inspection: Submit when testing or inspection is required by Laws and Regulations or governing agency or specified in the individual Specification sections.

- B. Statements of Qualification: Evidence of qualification, certification, or registration. As required in these Contract Documents to verify qualifications of professional land surveyors, engineers, materials testing laboratories, specialty Subcontractors, trades, specialists, consultants, installers, and other professionals. Reference Article 1.01.A.51 of Supplementary Conditions for the definition of Specialist.

- C. Field Samples: Provide as required by individual Specifications and as may be required by Engineer during progress of Work.
- D. Written Test Reports of Each Test and Inspection: As a minimum, include the following:
 - 1. Date of test and date issued, Project title and number, testing laboratory name, address, and telephone number, and name and signature of laboratory inspector.
 - 2. Date and time of sampling or inspection and record of temperature and weather conditions.
 - 3. Identification of product and Specification section, location of Sample, test or inspection in the Project, type of inspection or test with referenced standard or code, certified results of test.
 - 4. Compliance with Contract Documents, and identifying corrective action necessary to bring materials and equipment into compliance.
 - 5. Provide an interpretation of test results, when requested by Engineer.
- E. Disposition: Engineer will review, stamp, and indicate requirements for resubmission or acceptance on Submittal as follows:
 - 1. Accepted:
 - a. Acceptance will indicate that Submittal conforms to intent of Contract Documents as to form and substance.
 - b. Contractor may proceed to perform Submittal related Work.
 - c. One copy furnished Owner.
 - d. One copy furnished Resident Project Representative.
 - e. One copy retained in Engineer's file.
 - f. Remaining copies returned to Contractor appropriately annotated.
 - 2. Rejected as Noted:
 - a. One copy retained in Engineer's file.
 - b. Remaining copies returned to Contractor appropriately annotated.
 - c. Contractor shall revise/correct or develop replacement and resubmit.

1.05 CONTRACT CLOSEOUT SUBMITTALS

- A. General: In accordance with Section 01 77 00, Contract Closeout.
- B. Disposition: Engineer will review, stamp, and indicate requirements for resubmission or acceptance on Submittal as follows:
 - 1. Accepted:
 - a. Acceptance will indicate that Submittal conforms to intent of Contract Documents as to form and substance.
 - b. Contractor may proceed to perform Submittal related Work.
 - c. One copy furnished Owner.

- d. One copy furnished Resident Project Representative.
 - e. One copy retained in Engineer's file.
 - f. Remaining copies returned to Contractor appropriately annotated.
2. Rejected as Noted:
- a. One copy retained in Engineer's file.
 - b. Remaining copies returned to Contractor appropriately annotated.
 - c. Contractor shall revise/correct or develop replacement and resubmit.

1.06 SUPPLEMENTS

- A. The supplement listed below, following “END OF SECTION,” is part of this Specification.

1. Transmittal of Contractor's Submittal.

PART 2 PRODUCTS (NOT USED)

PART 3 EXECUTION (NOT USED)

END OF SECTION

CH2M HILL

TRANSMITTAL OF CONTRACTOR'S SUBMITTAL
(ATTACH TO EACH SUBMITTAL)

DATE: _____

TO: _____

Submittal No.: _____

New Submittal Resubmittal

Previous Submittal No.: _____

Project: _____

Project No.: _____

Specification Section No.: _____

FROM: _____

(Cover only one section with each transmittal)

Contractor

Schedule Date of Submittal: _____

SUBMITTAL TYPE: Shop Drawing
 Quality Control

Administrative
 Contract Closeout

Sample
 "Or-Equal"/Substitute

The following items are hereby submitted:

Number of Copies	Description of Item Submitted (Type, Size, Model Number, Etc.)	Spec. Para. No.	Drawing or Brochure Number	Contains Variation to Contract	
				No	Yes

Contractor hereby certifies that (i) Contractor has complied with the requirements of Contract Documents in preparation, review, and submission of designated Submittal and (ii) the Submittal is complete and in accordance with the Contract Documents and requirements of laws and regulations and governing agencies.

By: _____

Contractor (Authorized Signature)

SECTION 01 42 13
ABBREVIATIONS

PART 1 GENERAL

1.01 REFERENCE TO STANDARDS AND SPECIFICATIONS OF TECHNICAL SOCIETIES

- A. Reference to standards and specifications of technical societies and reporting and resolving discrepancies associated therewith shall be as provided in the General Conditions, and as may otherwise be required herein and in the individual Specification sections.
- B. Work specified by reference to the published standard or specification of a government agency, technical association, trade association, professional society or institute, testing agency, or other organization shall meet the requirements or surpass the minimum standards of quality for materials and workmanship established by the designated standard or specification.
- C. Where so specified, products or workmanship shall also meet or exceed the additional prescriptive or performance requirements included within the Contract Documents to establish a higher or more stringent standard of quality than that required by the referenced standard.
- D. Where two or more standards are specified to establish quality, the product and workmanship shall meet or exceed the requirements of the most stringent.
- E. Where both a standard and a brand name are specified for a product in the Contract Documents, the proprietary product named shall meet or exceed the requirements of the specified reference standard.
- F. Copies of Standards and Specifications of Technical Societies:
 - 1. Copies of applicable referenced standards have not been bound in these Contract Documents.
 - 2. Where copies of standards are needed by the Contractor, obtain a copy or copies directly from the publication source and maintain in an orderly manner at the site as Work site records, available to the Contractor's personnel, Subcontractors, Owner, and Engineer.

1.02 ABBREVIATIONS

A. Abbreviations for trade organizations and government agencies: Following is a list of construction industry organizations and government agencies to which references may be made in the Contract Documents, with abbreviations used.

1. AA Aluminum Association
2. AFBMA Anti-Friction Bearing Manufacturers' Association
3. AGMA American Gear Manufacturers' Association
4. ANSI American National Standards Institute
5. APWA American Public Works Association
6. ASA American Standards Association
7. ASCE American Society of Civil Engineers
8. ASNT American Society for Nondestructive Testing
9. ASME American Society of Mechanical Engineers
10. ASTM American Society for Testing and Materials
11. AWS American Welding Society
12. AWWA American Water Works Association
13. BHMA Builders Hardware Manufacturers' Association
14. CGA Compressed Gas Association
15. CS Commercial Standard
16. CSI Construction Specifications Institute
17. EJCDC Engineers Joint Contract Documents' Committee
18. ETL Engineering Test Laboratories
19. FCC Federal Communications Commission
20. FM Factory Mutual
21. Fed. Spec. Federal Specifications
22. FS Federal Specification
23. ICBO International Conference of Building Officials
24. ICEA Insulated Cable Engineers' Association
25. IEEE Institute of Electrical and Electronics Engineers, Inc.
26. IES Illuminating Engineering Society
27. IFI Industrial Fasteners Institute
28. ISA Instrument Society of America
29. ISO Insurance Service Office
30. Mil. Sp. Military Specification or MIL
31. MS Military Specifications
32. NEC National Electrical Code
33. NECA National Electrical Contractor's Association
34. NEMA National Electrical Manufacturers' Association
35. NESC National Electric Safety Code
36. NFPA National Fire Protection Association
37. NSFTL National Sanitation Foundation Testing Laboratory
38. NSPE National Society of Professional Engineers

- 39. OSHA Occupational Safety and Health Act (both Federal and State)
- 40. PS Product Standards Section-U.S. Department of Commerce
- 41. UBC Uniform Building Code
- 42. UFC Uniform Fire Code
- 43. UL Underwriters Laboratories Inc.
- 44. UMC Uniform Mechanical Code
- 45. US U.S. Bureau of Standards
- 46. USBR U.S. Bureau of Reclamation

PART 2 PRODUCTS (NOT USED)

PART 3 EXECUTION (NOT USED)

END OF SECTION

SECTION 01 43 33
MANUFACTURERS' FIELD SERVICES

PART 1 GENERAL

1.01 DEFINITIONS

- A. Person-Day: One person for 8 hours within regular Contractor working hours.

1.02 SUBMITTALS

- A. Informational Submittals:

1. Training Schedule: Submit, in accordance with requirements of this specification, not less than 21 days prior to start of equipment installation and revise as necessary for acceptance.
2. Lesson Plan: Submit, in accordance with requirements of this specification, proposed lesson plan not less than 21 days prior to scheduled training and revise as necessary for acceptance.

1.03 QUALIFICATION OF MANUFACTURER'S REPRESENTATIVE

- A. Authorized representative of the manufacturer, factory trained, and experienced in the technical applications, installation, operation, and maintenance of respective equipment, subsystem, or system, with full authority by the equipment manufacturer to issue the certifications required of the manufacturer. Additional qualifications may be specified elsewhere.
- B. Representative subject to acceptance by Owner. No substitute representatives will be allowed unless prior written approval by such has been given.
- C. Contractor to coordinate with Owner for Manufacturer's Field Services for Owner furnished equipment.

PART 2 PRODUCTS (NOT USED)

PART 3 EXECUTION

3.01 FULFILLMENT OF SPECIFIED MINIMUM SERVICES

- A. Furnish manufacturers' services when required by an individual specification section, to meet the requirements of this section.
- B. Where time is necessary in excess of that stated in the Specifications for manufacturers' services, or when a minimum time is not specified, the time required to perform the specified services shall be considered incidental.

- C. Schedule manufacturer' services to avoid conflict with other onsite testing or other manufacturers' onsite services.
- D. Determine, before scheduling services, that all conditions necessary to allow successful testing have been met.
- E. Only those days of service approved by Engineer will be credited to fulfill the specified minimum services.
- F. When specified in individual specification sections, manufacturer's onsite services shall include:
 - 1. Assistance during product (system, subsystem, or component) installation to include observation, guidance, instruction of Contractor's assembly, erection, installation or application procedures.
 - 2. Inspection, checking, and adjustment as required for product (system, subsystem, or component) to function as warranted by manufacturer and necessary to furnish Manufacturer's Certificate of Proper Installation.
 - 3. Providing, on a daily basis, copies of all manufacturers' representatives' field notes and data to Owner.
 - 4. Revisiting the Site as required to correct problems and until installation and operation are acceptable to Engineer.
 - 5. Resolution of assembly or installation problems attributable to, or associated with, respective manufacturer's products and systems.
 - 6. Assistance during functional and performance testing, and facility startup and evaluation.
 - 7. Training of Owner's personnel in the operation and maintenance of respective product as required.
 - 8. Additional requirements may be specified elsewhere.

3.02 MANUFACTURER'S CERTIFICATE OF COMPLIANCE

- A. When so specified, a Manufacturer's Certificate of Compliance, a copy of which is attached to this section, shall be completed in full, signed by the entity supplying the product, material, or service, and submitted prior to shipment of product or material or the execution of the services.
- B. Engineer may permit use of certain materials or assemblies prior to sampling and testing if accompanied by accepted certification of compliance.
- C. Such form shall certify that the proposed product, material, or service complies with that specified. Attach supporting reference data, affidavits, and certifications as appropriate.
- D. May reflect recent or previous test results on material or product, if acceptable to Engineer.

3.03 MANUFACTURER'S CERTIFICATE OF PROPER INSTALLATION

- A. When so specified, a Manufacturer's Certificate of Proper Installation form, a copy of which is attached to this section, shall be completed and signed by the equipment manufacturer's representative.
- B. Such form shall certify that the signing party is a duly authorized representative of the manufacturer, is empowered by the manufacturer to inspect, approve, and operate their equipment and is authorized to make recommendations required to assure that the equipment is complete and operational.

3.04 TRAINING

- A. General:
 - 1. Furnish manufacturers' representatives for detailed classroom and hands-on training to Owner's personnel on operation and maintenance of specified product (system, subsystem, component) and as may be required in applicable Specifications.
 - 2. Furnish trained, articulate personnel to coordinate and expedite training, to be present during training coordination meetings with Owner, and familiar with operation and maintenance manual information specified in Section 01 78 23, Operation and Maintenance Data.
 - 3. Manufacturer's representative shall be familiar with facility operation and maintenance requirements as well as with specified equipment.
 - 4. Furnish complete training materials, to include operation and maintenance data, to be retained by each trainee.
- B. Training Schedule:
 - 1. List specified equipment and systems that require training services and show:
 - a. Respective manufacturer.
 - b. Estimated dates for installation completion.
 - c. Estimated training dates.
 - 2. Allow for multiple sessions when several shifts are involved.
 - 3. Adjust schedule to ensure training of appropriate personnel as deemed necessary by Owner, and to allow full participation by manufacturers' representatives. Adjust schedule for interruptions in operability of equipment.
 - 4. Coordinate with Section 01 32 00, Progress Schedule and Section 01 91 14, Equipment Testing and Facility Startup.

- C. Lesson Plan: When manufacturer or vendor training of Owner personnel is specified, prepare a lesson plan for each required course containing the following minimum information:
 - 1. Title and objectives.
 - 2. Recommended attendees (e.g., managers, engineers, operators, maintenance).
 - 3. Course description, outline of course content, and estimated class duration.
 - 4. Format (e.g., lecture, self-study, demonstration, hands-on).
 - 5. Instruction materials and equipment requirements.
 - 6. Resumes of instructors providing the training.

- D. Pre-startup Training:
 - 1. Coordinate training sessions with Owner's operating personnel and manufacturers' representatives, and with submission of operation and maintenance manuals in accordance with Section 01 78 23, Operation and Maintenance Data.
 - 2. Complete at least 14 days prior to beginning of facility startup.

- E. Post-startup Training: If required in Specifications, furnish and coordinate training of Owner's operating personnel by respective manufacturer's representatives.

3.05 SUPPLEMENTS

- A. The supplements listed below, following "End of Section", are part of this Specification.
 - 1. Form: Manufacturer's Certificate of Compliance.
 - 2. Form: Manufacturer's Certificate of Proper Installation.

END OF SECTION

MANUFACTURER'S CERTIFICATE OF COMPLIANCE

OWNER: _____

PRODUCT, MATERIAL, OR SERVICE
SUBMITTED:

PROJECT NAME: _____

PROJECT NO: _____

Comments: _____

I hereby certify that the above-referenced product, material, or service called for by the contract for the named project will be furnished in accordance with all applicable requirements. I further certify that the product, material, or service are of the quality specified and conform in all respects with the contract requirements, and are in the quantity shown.

Date of Execution: _____, 20__

Manufacturer: _____

Manufacturer's Authorized Representative (*print*): _____

(Authorized Signature)

MANUFACTURER’S CERTIFICATE OF PROPER INSTALLATION

OWNER: _____ EQPT SERIAL NO: _____

EQPT TAG NO: _____ EQPT/SYSTEM: _____

PROJECT NO: _____ SPEC. SECTION: _____

I hereby certify that the above-referenced equipment/system has been:

(Check Applicable)

- Installed in accordance with Manufacturer’s recommendations.
- Inspected, checked, and adjusted.
- Serviced with proper initial lubricants.
- Electrical and mechanical connections meet quality and safety standards.
- All applicable safety equipment has been properly installed.
- Functional tests.
- System has been performance tested, and meets or exceeds specified performance requirements. (When complete system of one manufacturer)

Note: Attach any performance test documentation from manufacturer.

Comments: _____

I, the undersigned Manufacturer’s Representative, hereby certify that I am (i) a duly authorized representative of the manufacturer, (ii) empowered by the manufacturer to inspect, approve, and operate his equipment and (iii) authorized to make recommendations required to assure that the equipment furnished by the manufacturer is complete and operational, except as may be otherwise indicated herein. I further certify that all information contained herein is true and accurate.

Date: _____, 20__

Manufacturer: _____

By Manufacturer’s Authorized Representative: _____
(Authorized Signature)

SECTION 01 50 00
CONSTRUCTION FACILITIES AND TEMPORARY CONTROLS

PART 1 GENERAL

1.01 REFERENCES

- A. The following is a list of standards which may be referenced in this Section:
1. American Association of Nurserymen: American Standards for Nursery Stock.
 2. U.S. Weather Bureau, "Rainfall-Frequency Atlas of the U.S. for Durations From 30 Minutes to 24 Hours and Return Periods From 1 to 100 Years."
 3. U.S. Department of Agriculture, "Urban Hydrology for Small Watersheds."
 4. Federal Emergency Management Agency.
 5. NFPA, National Fire Prevention Standard for Safeguarding Building Construction Operations.

1.02 SUBMITTALS

- A. Administrative Submittals: Copies of permits and approvals for construction as required by Laws and Regulations and governing agencies.

1.03 MOBILIZATION

- A. Mobilization shall Include, but Not be Limited to, these Principal Items:
1. Obtaining required permits.
 2. Providing onsite sanitary facilities and potable water facilities as specified and as required by Laws and Regulations, and governing agencies.
 3. Arranging for and erection of Contractor's work and storage yard.
 4. Posting OSHA required notices and establishing safety programs and procedures.
 5. Having Contractor's superintendent at site full time.
- B. Areas designated for Contractor's temporary facilities shall be coordinated with Engineer and City.

PART 2 PRODUCTS

PART 3 EXECUTION

3.01 TEMPORARY UTILITIES

- A. Fire Protection: Furnish and maintain on site adequate firefighting equipment capable of extinguishing incipient fires. Comply with applicable parts of the National Fire Prevention Standard for Safeguarding Building Construction Operations (NFPA No. 241).
- B. Cooling and Ventilating:
 - 1. Provide as required to maintain adequate environmental conditions to facilitate progress of the Work, to meet specified minimum conditions for the installation of materials, and to protect materials, equipment, and finishes from damage due to temperature or humidity.
 - 2. Provide adequate forced air ventilation of enclosed areas to cure installed materials, to dispense humidity, and to prevent hazardous accumulations of dust, fumes, vapors, or gases.
 - 3. Pay all costs of installation, maintenance, operation, removal, and fuel consumed.

3.02 TEMPORARY ELECTRIC POWER

- A. The Owner will provide temporary power for construction.

3.03 SAFETY REQUIREMENTS FOR TEMPORARY ELECTRIC POWER

- A. Temporary electric power installation shall meet the construction safety requirements of OSHA, state and other governing agencies.

3.04 TEMPORARY WATER

- A. The Contractor shall make his own arrangements to obtain suitable water and shall pay all costs.

3.05 SANITARY FACILITIES

- A. The Contractor shall provide and maintain sanitary facilities for his employees and his subcontractors that will comply with the regulations of the local and state departments of health and as directed by the Engineer.

3.06 PROTECTION OF WORK AND PROPERTY

- A. Site Security: Reference the General Conditions.
- B. Barricades and Lights:
 - 1. Provide as necessary to prevent unauthorized entry to construction areas as required to ensure public safety and the safety of Contractor's employees, other employer's employees, and others who may be affected by the Work.
 - 2. Provide to protect existing facilities from potential damage.
 - 3. Locate to enable access by facility operators.

3.07 TEMPORARY CONTROLS

- A. Air Pollution Control:
 - 1. Minimize air pollution from construction operations.
 - 2. Burning of waste materials, rubbish, or other debris will not be permitted on or adjacent to Site.

3.08 PARKING AREAS

- A. Contractor's vehicle parking shall be limited to designated areas. If additional parking is required, Contractor shall submit parking plan, and coordinate with Owner and Engineer.
- B. Control Vehicular parking to preclude interference with public traffic or parking, access by emergency vehicles, Owner's operations, or construction operations. No parking along roadways shall be allowed.

3.09 CLEANING DURING CONSTRUCTION

- A. In accordance with General Conditions, as may be specified in Specification sections, and as required herein.
- B. Provide approved containers for collection and disposal of waste materials, debris, and rubbish. At least at weekly intervals, dispose of such waste materials, debris, and rubbish offsite.

END OF SECTION

SECTION 01 61 00
COMMON PRODUCT REQUIREMENTS

PART 1 GENERAL

1.01 DEFINITIONS

A. Products:

1. New items for incorporation in the Work, whether purchased by Contractor or Owner for the Project, or taken from previously purchased stock, and may also include existing materials or components required for reuse.
2. Includes the terms material, equipment, machinery, components, subsystem, system, hardware, software, and terms of similar intent and is not intended to change meaning of such other terms used in Contract Documents, as those terms are self-explanatory and have well recognized meanings in construction industry.
3. Items identified by manufacturer's product name, including make or model designation, indicated in manufacturer's published product literature, that is current as of the date of the Contract Documents.

1.02 ENVIRONMENTAL REQUIREMENTS

- A. Altitude: Provide materials and equipment suitable for installation and operation under rated conditions at 10 feet above sea level.
- B. Provide equipment and devices installed outdoors or in unheated enclosures capable of continuous operation within an ambient temperature range of 20 degrees F to 105 degrees F.

1.03 PREPARATION FOR SHIPMENT

- A. When practical, factory assemble products. Mark or tag separate parts and assemblies to facilitate field assembly. Cover machined and unpainted parts that may be damaged by the elements with strippable protective coating.
- B. Package products to facilitate handling and protect from damage during shipping, handling, and storage. Mark or tag outside of each package or crate to indicate its purchase order number, bill of lading number, contents by name, name of Project and Contractor, equipment number, and approximate weight. Include complete packing list and bill of materials with each shipment.

- C. Extra Materials, Special Tools, Test Equipment, and Expendables:
 - 1. Furnish as required by individual Specifications.
 - 2. Schedule:
 - a. Ensure that shipment and delivery occurs concurrent with shipment of associated equipment.
 - b. Transfer to Owner shall occur immediately subsequent to Contractor's acceptance of equipment from Supplier.
 - 3. Packaging and Shipment:
 - a. Package and ship extra materials and special tools to avoid damage during long term storage in original cartons insofar as possible, or in appropriately sized, hinged-cover, wood, plastic, or metal box.
 - b. Prominently displayed on each package, the following:
 - 1) Manufacturer's part nomenclature and number, consistent with Operation and Maintenance Manual identification system.
 - 2) Applicable equipment description.
 - 3) Quantity of parts in package.
 - 4) Equipment manufacturer.
 - 4. Deliver materials to Site.
 - 5. Notify Construction Manager upon arrival for transfer of materials.
 - 6. Replace extra materials and special tools found to be damaged or otherwise inoperable at time of transfer to Owner.
- D. Request a minimum 7-day advance notice of shipment from manufacturer.
- E. Factory Test Results: Reviewed and accepted by Engineer before product shipment as required in individual Specification sections.

1.04 DELIVERY AND INSPECTION

- A. Deliver products in accordance with accepted current Progress Schedule and coordinate to avoid conflict with the Work and conditions at Site. Deliver anchor bolts and templates sufficiently early to permit setting prior to placement of structural concrete.
- B. Deliver products in undamaged condition, in manufacturer's original container or packaging, with identifying labels intact and legible. Include on label, date of manufacture and shelf life, where applicable.
- C. Unload products in accordance with manufacturer's instructions for unloading or as specified. Record receipt of products at Site. Promptly inspect for completeness and evidence of damage during shipment.

- D. Remove damaged products from Site and expedite delivery of identical new undamaged products, and remedy incomplete or lost products to provide that specified, so as not to delay progress of the Work.

1.05 HANDLING, STORAGE, AND PROTECTION

- A. Handle and store products in accordance with manufacturer's written instructions and in a manner to prevent damage. Store in approved storage yards or sheds provided in accordance with Section 01 50 00, Construction Facilities and Temporary Controls. Provide manufacturer's recommended maintenance during storage, installation, and until products are accepted for use by Owner.
- B. Manufacturer's instructions for material requiring special handling, storage, or protection shall be provided prior to delivery of material.
- C. Arrange storage in a manner to provide easy access for inspection. Make periodic inspections of stored products to assure that products are maintained under specified conditions, and free from damage or deterioration. Keep running account of products in storage to facilitate inspection and to estimate progress payments for products delivered, but not installed in the Work.
- D. Store electrical, instrumentation, and control products, and equipment with bearings in weather-tight structures maintained above 60 degrees F. Protect electrical, instrumentation, and control products, and insulate against moisture, water, and dust damage. Connect and operate continuously space heaters furnished in electrical equipment.
- E. Store fabricated products above ground on blocking or skids, and prevent soiling or staining. Store loose granular materials in well-drained area on solid surface to prevent mixing with foreign matter. Cover products that are subject to deterioration with impervious sheet coverings; provide adequate ventilation to avoid condensation.
- F. Store finished products that are ready for installation in dry and well-ventilated areas. Do not subject to extreme changes in temperature or humidity.
- G. After installation, provide coverings to protect products from damage due to traffic and construction operations. Remove coverings when no longer needed.
- H. Hazardous Materials: Prevent contamination of personnel, storage area, and Site. Meet requirements of product specification, codes, and manufacturer's instructions.

PART 2 PRODUCTS

2.01 GENERAL

- A. Provide manufacturer's standard materials suitable for service conditions, unless otherwise specified in the individual Specifications.
- B. Where product specifications include a named manufacturer, with or without model number, and also include performance requirements, named manufacturer's products must meet the performance specifications.
- C. Like items of products furnished and installed in the Work shall be end products of one manufacturer and of the same series or family of models to achieve standardization for appearance, operation and maintenance, spare parts and replacement, manufacturer's services, and implement same or similar process instrumentation and control functions in same or similar manner.
- D. Equipment, Components, Systems, and Subsystems: Design and manufacture with due regard for health and safety of operation, maintenance, and accessibility, durability of parts, and shall comply with applicable OSHA, state, and local health and safety regulations.
- E. Regulatory Requirement: Coating materials shall meet federal, state, and local requirements limiting the emission of volatile organic compounds and for worker exposure.
- F. Authority Having Jurisdiction (AHJ):
 - 1. Provide the Work in accordance with NFPA 70, National Electrical Code (NEC). Where required by the AHJ, material and equipment shall be labeled or listed by a nationally recognized testing laboratory or other organization acceptable to the AHJ in order to provide a basis for approval under NEC.
 - 2. Materials and equipment manufactured within the scope of standards published by Underwriters Laboratories, Inc. shall conform to those standards and shall have an applied UL listing mark.
- G. Equipment Finish:
 - 1. Provide manufacturer's standard finish and color, except where specific color is indicated.
 - 2. If manufacturer has no standard color, provide equipment with gray finish as approved by Owner.

- H. Special Tools and Accessories: Furnish to Owner, upon acceptance of equipment, all accessories required to place each item of equipment in full operation. These accessory items include, but are not limited to, adequate oil and grease (as required for first lubrication of equipment after field testing), light bulbs, fuses, hydrant wrenches, valve keys, hand wheels, chain operators, special tools, and other spare parts as required for maintenance.
- I. Lubricant: Provide initial lubricant recommended by equipment manufacturer in sufficient quantity to fill lubricant reservoirs and to replace consumption during testing, startup, and operation until final acceptance by Owner.

2.02 FABRICATION AND MANUFACTURE

A. General:

1. Manufacture parts to U.S.A. standard sizes and gauges.
2. Two or more items of the same type shall be identical, by the same manufacturer, and interchangeable.
3. Design structural members for anticipated shock and vibratory loads.
4. Use 1/4-inch minimum thickness for steel that will be submerged, wholly or partially, during normal operation.
5. Modify standard products as necessary to meet performance Specifications.

2.03 SOURCE QUALITY CONTROL

- A. Calibration Instruments: Bear the seal of a reputable laboratory certifying instrument has been calibrated within the previous 12 months to a standard endorsed by the National Institute of Standards and Technology (NIST).
- B. Factory Tests: Perform in accordance with accepted test procedures and document successful completion.

PART 3 EXECUTION

3.01 INSPECTION

- A. Inspect materials and equipment for signs of pitting, rust decay, or other deleterious effects of storage. Do not install material or equipment showing such effects. Remove damaged material or equipment from the Site and expedite delivery of identical new material or equipment. Delays to the Work resulting from material or equipment damage that necessitates procurement of new products will be considered delays within Contractor's control.

3.02 INSTALLATION

- A. Equipment Drawings show general locations of equipment, devices, and raceway, unless specifically dimensioned.

691623A.GN1

- B. No shimming between machined surfaces is allowed.
- C. Install the Work in accordance with NECA Standard of Installation, unless otherwise specified.
- D. Repaint painted surfaces that are damaged prior to equipment acceptance.
- E. Do not cut or notch any structural member or building surface without specific approval of Engineer.
- F. Handle, install, connect, clean, condition, and adjust products in accordance with manufacturer's instructions, and as may be specified. Retain a copy of manufacturers' instruction at Site, available for review at all times.

3.03 ADJUSTMENT AND CLEANING

- A. Perform required adjustments, tests, operation checks, and other startup activities.

END OF SECTION

**SECTION 01 77 00
CONTRACT CLOSEOUT**

PART 1 GENERAL

1.01 SUBMITTALS

- A. Quality Control Submittals: Written procedures for maintaining and markup of record documents.
- B. Contract Closeout Submittals: Submit prior to application for final payment.
 - 1. Record Documents: As required in the General Conditions.
 - 2. Approved Shop Drawings and Samples: As required in the General Conditions.
 - 3. Special Bonds, Special Warranties, and Service Agreements.
 - 4. Consent of Surety to Final Payment: As required in the General Conditions.
 - 5. Releases or Waivers of Liens and Claims: As required in the General Conditions.
 - 6. Releases from Agreements.
 - 7. Final Application for Payment: Submit in accordance with procedures and requirements stated in Section 01 29 00, Payment Procedures.
 - 8. Spare Parts and Special Tools: As required by individual Specification sections.

1.02 RECORD DOCUMENTS

- A. Quality Assurance:
 - 1. Furnish qualified and experienced person, whose duty and responsibility shall be to maintain record documents.
 - 2. Accuracy of Records:
 - a. Coordinate changes within record documents, making legible and accurate entries on each sheet of Drawings and other documents where such entry is required to show change.
 - b. Purpose of Project record documents is to document factual information regarding aspects of Work, both concealed and visible, to enable future modification of Work to proceed without lengthy and expensive site measurement, investigation, and examination.
 - 3. Make entries within 24 hours after receipt of information that a change in Work has occurred.

4. Prior to submitting each request for progress payment, request Engineer's review and approval of current status of record documents. Failure to properly maintain, update, and submit record documents may result in a deferral by Engineer to recommend the whole or any part of the Contractor's Application for Payment, either partial or final.
5. Contractor to have a licensed surveyor provide signed and sealed drawing that include the following as an attachment to the Project Record Drawings.
 - a. All supplied data collections, As-Builts, Drawings, files to be compatible with ERSI ArcGIS 10.3 Software. The Owner's current computing environment consists of *Microsoft SQL Server – Windows 10/Server 2008 – ERSI GIS Platform*.
Interfaces and Integrations:
 - 1) The City of Key West uses a number of software applications critical to its core operation and mission. The proposed mobile asset data collection solution will need to interface with these existing platforms: Arc Collector; ArcGIS Online and ArcMap 10.3.
 - 2) Contact City GIS Manager, at 305-809-3721 with software related questions.

PART 2 PRODUCTS (NOT USED)

PART 3 EXECUTION

3.01 MAINTENANCE OF RECORD DOCUMENTS

A. General:

1. Promptly following commencement of Contract Times, secure from Engineer at no cost to Contractor, one complete set of Contract Documents. Drawings will be full size.
2. Delete Engineer title block and seal from all documents.
3. Label or stamp each record document with title, "RECORD DOCUMENTS," in neat large printed letters.
4. Record information concurrently with construction progress and within 24 hours after receipt of information that change has occurred. Do not cover or conceal Work until required information is recorded.

B. Preservation:

1. Maintain documents in a clean, dry, legible condition and in good order. Do not use record documents for construction purposes.
2. Make documents and Samples available at all times for observation by Engineer.

- C. Making Entries on Drawings:
1. Using an erasable colored pencil (not ink or indelible pencil), clearly describe change by graphic line and note as required.
 - a. Color Coding:
 - 1) Green when showing information deleted from Drawings.
 - 2) Red when showing information added to Drawings.
 - 3) Blue and circled in blue to show notes.
 2. Date entries.
 3. Call attention to entry by “cloud” drawn around area or areas affected.
 4. Legibly mark to record actual changes made during construction, including, but not limited to:
 - a. Changes made by Addenda and Field Orders, Work Change Directive, Change Order, Written Amendment, and Engineer's written interpretation and clarification using consistent symbols for each and showing appropriate document tracking number.

3.02 FINAL CLEANING

- A. At completion of Work at each Site or of a part thereof and immediately prior to Contractor's request for certificate of Substantial Completion; or if no certificate is issued, immediately prior to Contractor's notice of completion, clean entire site or parts thereof, as applicable.
1. Leave the Work and adjacent areas affected in a cleaned condition satisfactory to Owner and Engineer.
 2. Remove grease, dirt, dust, paint or plaster splatter, stains, labels, fingerprints, and other foreign materials from exposed surfaces.
 3. Repair, patch, and touchup marred surfaces to specified finish and match adjacent surfaces.
- B. Use only cleaning materials recommended by manufacturer of surfaces to be cleaned.

END OF SECTION

SECTION 01 78 23
OPERATION AND MAINTENANCE DATA

PART 1 GENERAL

1.01 SECTION INCLUDES

- A. Detailed information for the preparation, submission, and Engineer's review of Operations and Maintenance (O&M) Data, as required by individual Specification sections.

1.02 DEFINITIONS

- A. Preliminary Data: Initial and subsequent submissions for Engineer's review.
- B. Final Data: Engineer-accepted data, submitted as specified herein.
- C. Maintenance Operation: As used on Maintenance Summary Form is defined to mean any routine operation required to ensure satisfactory performance and longevity of equipment. Examples of typical maintenance operations are lubrication, belt tensioning, adjustment of pump packing glands, and routine adjustments.

1.03 SEQUENCING AND SCHEDULING

- A. Equipment and System Data:
 - 1. Preliminary Data:
 - a. Do not submit until Shop Drawing for equipment or system has been reviewed and approved by Engineer.
 - b. Submit prior to shipment date.
 - 2. Final Data: Submit Instructional Manual Formatted data not less than 30 days prior to equipment or system field functional testing.
- B. Materials and Finishes Data:
 - 1. Preliminary Data: Submit at least 15 days prior to request for final inspection.
 - 2. Final Data: Submit within 10 days after final inspection.

1.04 DATA FORMAT

- A. Prepare preliminary and final data in the form of an instructional manual.
- B. Instructional Manual Format:
 - 1. Binder: Commercial quality, permanent, three-ring or three-post binders with durable plastic cover.
 - 2. Size: 8-1/2 inches by 11 inches, minimum.
 - 3. Cover: Identify manual with typed or printed title "OPERATION AND MAINTENANCE DATA" and list:
 - a. Project title.
 - b. Designate applicable system, equipment, material, or finish.
 - c. Identity of separate structure as applicable.
 - d. Identify volume number if more than one volume.
 - e. Identity of general subject matter covered in manual.
 - 4. Spine:
 - a. Project title.
 - b. Identify volume number if more than one volume.
 - 5. Title Page:
 - a. Contractor name, address, and telephone number.
 - b. Subcontractor, Supplier, installer, or maintenance contractor's name, address, and telephone number, as appropriate.
 - 1) Identify area of responsibility of each.
 - 2) Provide name and telephone number of local source of supply for parts and replacement.
 - 6. Table of Contents:
 - a. Neatly typewritten and arranged in systematic order with consecutive page numbers.
 - b. Identify each product by product name and other identifying numbers or symbols as set forth in Contract Documents.
 - 7. Paper: 20-pound minimum, white for typed pages.
 - 8. Text: Manufacturer's printed data, or neatly typewritten.
 - 9. Three-hole punch data for binding and composition; arrange printing so that punched holes do not obliterate data.
 - 10. Material shall be suitable for reproduction, with quality equal to original. Photocopying of material will be acceptable, except for material containing photographs.
- C. Data Compilation Format:
 - 1. Compile all Engineer-accepted preliminary O&M data into a hard-copy, hard-bound set.
 - 2. Each set shall consist of the following:
 - a. Binder: Commercial quality, permanent, three-ring or three-post binders with durable plastic cover.

- b. Cover: Identify each volume with typed or printed title “OPERATION AND MAINTENANCE DATA, VOLUME NO. ___ OF ___”, and list:
 - 1) Project title.
 - 2) Contractor’s name, address, and telephone number.
 - 3) If entire volume covers equipment or system provided by one Supplier include the following:
 - a) Identity of general subject matter covered in manual.
 - b) Identity of equipment number and Specification section.
- c. Provide each volume with title page and typed table of contents with consecutive page numbers. Place contents of entire set, identified by volume number, in each binder.
- d. Table of contents neatly typewritten, arranged in a systematic order:
 - 1) Include list of each product, indexed to content of each volume.
 - 2) Designate system or equipment for which it is intended.
 - 3) Identify each product by product name and other identifying numbers or symbols as set forth in Contract Documents.
- e. Section Dividers:
 - 1) Heavy, 80 pound cover weight, tabbed with numbered plastic index tabs.
 - 2) Fly-Leaf:
 - a) For each separate product, or each piece of operating equipment, with typed description of product and major component parts of equipment.
 - b) List with Each Product:
 - (1) Name, address, and telephone number of Subcontractor, Supplier, installer, and maintenance contractor, as appropriate.
 - (2) Identify area of responsibility of each.
 - (3) Provide local source of supply for parts and replacement.
 - c) Identity of separate structure as applicable.
- f. Assemble and bind material, as much as possible, in same order as specified in the Contract Documents.

1.05 SUBMITTALS

A. Informational:

1. Data Outline: Submit two copies of a detailed outline of proposed organization and contents of Final Data prior to preparation of Preliminary Data.

2. Preliminary Data:
 - a. Submit two copies for Engineer's review.
 - b. If data meets conditions of the Contract:
 - 1) One copy will be returned to Contractor.
 - 2) One copy will be forwarded to Resident Project Representative.
 - c. If data does not meet conditions of the Contract:
 - 1) All copies will be returned to Contractor with Engineer's comments (on separate document) for revision.
 - 2) Engineer's comments will be retained in Engineer's file.
 - 3) Resubmit two copies revised in accordance with Engineer's comments.
3. Final Data: Submit two copies in format specified herein and an electronic copy.

1.06 DATA FOR EQUIPMENT AND SYSTEMS

A. Content for Each Unit (or Common Units) and System:

1. Product Data:
 - a. Include only those sheets that are pertinent to specific product.
 - b. Clearly annotate each sheet to:
 - 1) Identify specific product or part installed.
 - 2) Identify data applicable to installation.
 - 3) Delete references to inapplicable information.
 - c. Function, normal operating characteristics, and limiting conditions.
 - d. Performance curves, engineering data, nameplate data, and tests.
 - e. Complete nomenclature and commercial number of replaceable parts.
 - f. Original manufacturer's parts list, illustrations, detailed assembly drawings showing each part with part numbers and sequentially numbered parts list, and diagrams required for maintenance.
 - g. Spare parts ordering instructions.
 - h. Where applicable, identify installed spares and other provisions for future work (e.g., reserved panel space, unused components, wiring, terminals).
2. As-installed, color-coded piping diagrams.
3. Charts of valve tag numbers, with the location and function of each valve.
4. Drawings: Supplement product data with Drawings as necessary to clearly illustrate:
 - a. Format:
 - 1) Provide reinforced, punched, binder tab; bind in with text.
 - 2) Reduced to 8-1/2 inches by 11 inches, or 11 inches by 17 inches folded to 8-1/2 inches by 11 inches.

- 3) Where reduction is impractical, fold and place in 8-1/2-inch by 11-inch envelopes bound in text.
- 4) Identify Specification section and product on Drawings and envelopes.
- b. Relations of component parts of equipment and systems.
- c. Control and flow diagrams.
- d. Coordinate drawings with Project record documents to assure correct illustration of completed installation.
5. Instructions and Procedures: Within text, as required to supplement product data.
 - a. Format:
 - 1) Organize in consistent format under separate heading for each different procedure.
 - 2) Provide logical sequence of instructions for each procedure.
 - 3) Provide information sheet for Owner's personnel, including:
 - a) Proper procedures in event of failure.
 - b) Instances that might affect validity of guarantee or Bond.
 - b. Installation Instructions: Including alignment, adjusting, calibrating, and checking.
 - c. Operating Procedures:
 - 1) Startup, break-in, routine, and normal operating instructions.
 - 2) Test procedures and results of factory tests where required.
 - 3) Regulation, control, stopping, and emergency instructions.
 - 4) Description of operation sequence by control manufacturer.
 - 5) Shutdown instructions for both short and extended duration.
 - 6) Summer and winter operating instructions, as applicable.
 - 7) Safety precautions.
 - 8) Special operating instructions.
 - d. Maintenance and Overhaul Procedures:
 - 1) Routine maintenance.
 - 2) Guide to troubleshooting.
 - 3) Disassembly, removal, repair, reinstallation, and re-assembly.
6. Guarantee, Bond, and Service Agreement: In accordance with Section 01 77 00, Contract Closeout.

B. Content for Each Electric or Electronic Item or System:

1. Description of Unit and Component Parts:
 - a. Function, normal operating characteristics, and limiting conditions.
 - b. Performance curves, engineering data, nameplate data, and tests.
 - c. Complete nomenclature and commercial number of replaceable parts.
 - d. Interconnection wiring diagrams, including control and lighting systems.

2. Circuit Directories of Panelboards.
3. Electrical service.
4. Control requirements and interfaces.
5. Communication requirements and interfaces.
6. List of electrical relay settings, and control and alarm contact settings.
7. Electrical interconnection wiring diagram, including as applicable, single-line, three-line, schematic and internal wiring, and external interconnection wiring.
8. As-installed control diagrams by control manufacturer.
9. Operating Procedures:
 - a. Routine and normal operating instructions.
 - b. Startup and shutdown sequences, normal and emergency.
 - c. Safety precautions.
 - d. Special operating instructions.
10. Maintenance Procedures:
 - a. Routine maintenance.
 - b. Guide to troubleshooting.
 - c. Adjustment and checking.
 - d. List of relay settings, control and alarm contact settings.
11. Manufacturer's printed operating and maintenance instructions.
12. List of original manufacturer's spare parts, manufacturer's current prices, and recommended quantities to be maintained in storage.

C. Maintenance Summary:

1. Compile individual Maintenance Summary for each applicable equipment item, respective unit or system, and for components or sub-units.
2. Format:
 - a. Use Maintenance Summary Form bound with this section or electronic facsimile of such.
 - b. Each Maintenance Summary may take as many pages as required.
 - c. Use only 8-1/2-inch by 11-inch size paper.
 - d. Complete using typewriter or electronic printing.
3. Include detailed lubrication instructions and diagrams showing points to be greased or oiled; recommend type, grade, and temperature range of lubricants and frequency of lubrication.
4. Recommended Spare Parts:
 - a. Data to be consistent with manufacturer's Bill of Materials/Parts List furnished in O&M manuals.
 - b. "Unit" is the unit of measure for ordering the part.
 - c. "Quantity" is the number of units recommended.
 - d. "Unit Cost" is the current purchase price.

1.07 DATA FOR MATERIALS AND FINISHES

A. Content for Architectural Products, Applied Materials, and Finishes:

1. Manufacturer's data, giving full information on products:
 - a. Catalog number, size, and composition.
 - b. Color and texture designations.
 - c. Information required for reordering special-manufactured products.
2. Instructions for Care and Maintenance:
 - a. Manufacturer's recommendation for types of cleaning agents and methods.
 - b. Cautions against cleaning agents and methods that are detrimental to product.
 - c. Recommended schedule for cleaning and maintenance.

B. Content for Moisture Protection and Weather Exposed Products:

1. Manufacturer's data, giving full information on products:
 - a. Applicable standards.
 - b. Chemical composition.
 - c. Details of installation.
2. Instructions for inspection, maintenance, and repair.

1.08 SUPPLEMENTS

A. The supplement listed below, following "End of Section," is part of this Specification.

1. Form: Maintenance Summary Form.

PART 2 PRODUCTS (NOT USED)**PART 3 EXECUTION (NOT USED)****END OF SECTION**

MAINTENANCE SUMMARY FORM

PROJECT: _____ CONTRACT NO.: _____

1. EQUIPMENT ITEM _____

2. MANUFACTURER _____

3. EQUIPMENT/TAG NUMBER(S) _____

4. WEIGHT OF INDIVIDUAL COMPONENTS (OVER 100 POUNDS) _____

5. NAMEPLATE DATA (hp, voltage, speed, etc.) _____

6. MANUFACTURER'S LOCAL REPRESENTATIVE _____

a. Name _____ Telephone No. _____

b. Address _____

7. MAINTENANCE REQUIREMENTS

Maintenance Operation Comments	Frequency	Lubricant (If Applicable)
List briefly each maintenance operation required and refer to specific information in manufacturer's standard maintenance manual, if applicable. (Reference to manufacturer's catalog or sales literature is not acceptable.)	List required frequency of each maintenance operation.	Refer by symbol to lubricant required.

8. LUBRICANT LIST

Reference Symbol	Shell	Exxon Mobile	Chevron Texaco	BP Amoco	Or Equal
List symbols used in No. 7 above.	List equivalent lubricants, as distributed by each manufacturer for the specific use recommended.				

9. RECOMMENDED SPARE PARTS FOR OWNER’S INVENTORY.

Part No.	Description	Unit	Quantity	Unit Cost

Note: Identify parts provided by this Contract with two asterisks.

SECTION 01 91 14
EQUIPMENT TESTING AND FACILITY STARTUP

PART 1 GENERAL

1.01 DEFINITIONS

- A. Facility: Entire Project, or an agreed-upon portion, including all of its unit processes.
- B. Functional Test: Test or tests in presence of Engineer and Owner to demonstrate that installed equipment meets manufacturer's installation, calibration, and adjustment requirements and other requirements as specified.
- C. Performance Test: Test or tests performed after any required functional test in presence of Engineer and Owner to demonstrate and confirm individual equipment meets performance requirements specified in individual sections.
- D. Unit Process: As used in this section, a unit process is a portion of the facility that performs a specific process function, such as pump station and generator.
- E. Facility Performance Demonstration:
 - 1. A demonstration, conducted by Contractor, with assistance of Owner, to demonstrate and document the performance of the entire operating facility, both manually and automatically (if required), based on criteria developed in conjunction with Owner and as accepted by Engineer.
 - 2. Such demonstration is for the purposes of (i) verifying to Owner entire facility performs as a whole, and (ii) documenting performance characteristics of completed facility for Owner's records. Neither the demonstration nor the evaluation is intended in any way to make performance of a unit process or entire facility the responsibility of Contractor, unless such performance is otherwise specified.

1.02 SUBMITTALS

- A. Informational Submittals:
 - 1. Facility Startup and Performance Demonstration Plan.
 - 2. Functional and performance test results.
 - 3. Completed Unit Process Startup Form for each unit process.
 - 4. Completed Facility Performance Demonstration/Certification Form.

1.03 FACILITY STARTUP AND PERFORMANCE DEMONSTRATION PLAN

- A. Develop a written plan, in conjunction with Owner's operations personnel; to include the following:
 - 1. Step-by-step instructions for startup of each unit process and the complete facility.
 - 2. Unit Process Startup Form (sample attached), to minimally include the following:
 - a. Description of the unit process, including equipment numbers/nomenclature of each item of equipment and all included devices.
 - b. Detailed procedure for startup of the unit process, including valves to be opened/closed, order of equipment startup, etc.
 - c. Startup requirements for each unit process, including water, power, chemicals, etc.
 - d. Space for evaluation comments.
 - 3. Facility Performance Demonstration/Certification Form (sample attached), to minimally include the following:
 - a. Description of unit processes included in the facility startup.
 - b. Sequence of unit process startup to achieve facility startup.
 - c. Description of computerized operations, if any, included in the facility.
 - d. Contractor certification facility is capable of performing its intended function(s), including fully automatic operation.
 - e. Signature spaces for Contractor and Engineer.

PART 2 PRODUCTS (NOT USED)

PART 3 EXECUTION

3.01 GENERAL

- A. Facility Startup Meetings: Schedule, in accordance with requirements of Section 01 31 19, Project Meetings, to discuss test schedule, test methods, materials, chemicals and liquids required, facilities operations interface, and Owner involvement.
- B. Contractor's Testing and Startup Representative:
 - 1. Designate and furnish one or more personnel to coordinate and expedite testing and facility startup.
 - 2. Representative(s) shall be present during startup meetings and shall be available at all times during testing and startup.

- C. Provide test equipment and other materials and equipment required for testing and startup.
- D. Provide Subcontractor and equipment manufacturers' staff adequate to prevent delays. Schedule ongoing work so as not to interfere with or delay testing and startup.
- E. Owner will: Operate process units and facility with support of Contractor.

3.02 EQUIPMENT TESTING

A. Preparation:

1. Complete installation before testing.
2. Furnish qualified manufacturers' representatives, when required by individual Specification sections.
3. Obtain and submit from equipment manufacturer's representative Manufacturer's Certificate of Proper Installation Form, in accordance with Section 01 43 33, Manufacturers' Field Services, when required by individual Specification sections.
4. Equipment Test Report Form: Provide written test report for each item of equipment to be tested, to include the minimum information:
 - a. Owner/Project Name.
 - b. Equipment or item tested.
 - c. Date and time of test.
 - d. Type of test performed (Functional or Performance).
 - e. Test method.
 - f. Test conditions.
 - g. Test results.
 - h. Signature spaces for Contractor and Engineer as witness.
5. Cleaning and Checking: Prior to beginning functional testing:
 - a. Calibrate testing equipment in accordance with manufacturer's instructions.
 - b. Inspect and clean equipment, and devices, to ensure they are free of foreign material.
 - c. Check power supply to electric-powered equipment for correct voltage.
6. Ready-to-test determination will be by Engineer based at least on the following:
 - a. Acceptable Operation and Maintenance Data.
 - b. Notification by Contractor of equipment readiness for testing.
 - c. Receipt of Manufacturer's Certificate of Proper Installation, if so specified.
 - d. Adequate completion of work adjacent to, or interfacing with, equipment to be tested.

- e. Availability and acceptability of manufacturer's representative, when specified, to assist in testing of respective equipment.
- f. Satisfactory fulfillment of other specified manufacturer's responsibilities.
- g. Equipment and electrical tagging complete.
- h. Delivery of all spare parts and special tools.

B. Functional Testing:

- 1. Conduct as specified in individual Specification sections.
- 2. Notify Owner and Engineer in writing at least 10 days prior to scheduled date of testing.
- 3. Prepare Equipment Test Report summarizing test method and results.
- 4. When, in Engineer's opinion, equipment meets functional requirements specified, such equipment will be accepted for purposes of advancing to performance testing phase, if so required by individual Specification sections. Such acceptance will be evidenced by Engineer/Owner's signature as witness on Equipment Test Report.

C. Performance Testing:

- 1. Conduct as specified in individual Specification sections.
- 2. Notify Engineer and Owner in writing at least 10 days prior to scheduled date of test.
- 3. Performance testing shall not commence until equipment has been accepted by Engineer as having satisfied functional test requirements specified.
- 4. Type of fluid, gas, or solid for testing shall be as specified.
- 5. Unless otherwise indicated, furnish labor, materials, and supplies for conducting the test and taking samples and performance measurements.
- 6. Prepare Equipment Test Report summarizing test method and results.
- 7. When, in Engineer's opinion, equipment meets performance requirements specified, such equipment will be accepted as to conforming to Contract requirements. Such acceptance will be evidenced by Engineer's signature on Equipment Test Report.

3.03 STARTUP OF UNIT PROCESSES

- A. Prior to unit process startup, equipment within unit process shall be accepted by Engineer as having met functional and performance testing requirements specified.
- B. Startup sequencing of unit processes shall be as chosen by Contractor to meet schedule requirements.
- C. Make adjustments, repairs, and corrections necessary to complete unit process startup.

- D. Startup shall be considered complete when, in opinion of Engineer, unit process has operated in manner intended for 5 continuous days without significant interruption. This period is in addition to functional or performance test periods specified elsewhere.
- E. Significant Interruption: May include any of the following events:
 - 1. Failure of Contractor to provide and maintain qualified onsite startup personnel as scheduled.
 - 2. Failure to meet specified functional operation for more than 2 consecutive hours.
 - 3. Failure of any critical equipment or unit process that is not satisfactorily corrected within 5 hours after failure.
 - 4. Failure of any noncritical equipment or unit process that is not satisfactorily corrected within 8 hours after failure.
 - 5. As determined by Engineer.
- F. A significant interruption will require startup then in progress to be stopped. After corrections are made, startup test period to start from beginning again.

3.04 FACILITY PERFORMANCE DEMONSTRATION

- A. When, in the opinion of Engineer, startup of all unit processes has been achieved, sequence each unit process to the point that facility is operational.
- B. Demonstrate proper operation of required interfaces within and between individual unit processes.
- C. After facility is operating, complete performance testing of equipment and systems not previously tested.
- D. Document, as defined in Facility Startup and Performance Demonstration Plan, the performance of the facility.
- E. Certify, on the Facility Performance Demonstration/Certification Form, that facility is capable of performing its intended function(s), including fully automatic operation.

3.05 SUPPLEMENTS

- A. Supplements listed below, following “End of Section,” are a part of this Specification:
 - 1. Unit Process Startup Form.
 - 2. Facility Performance Demonstration/Certification Form.

END OF SECTION

UNIT PROCESS STARTUP FORM

OWNER: _____ **PROJECT:** _____

Unit Process Description: (Include description and equipment number of all equipment and devices):

Startup Procedure (Describe procedure for sequential startup and evaluation, including valves to be opened/closed, order of equipment startup, etc.):

Startup Requirements (Water, power, chemicals, etc.): _____

Evaluation Comments: _____

FACILITY PERFORMANCE DEMONSTRATION/CERTIFICATION FORM

OWNER: _____ **PROJECT:** _____

Unit Processes Description (List unit processes involved in facility startup):

Unit Processes Startup Sequence (Describe sequence for startup, including computerized operations, if any):

Contractor Certification that Facility is capable of performing its intended function(s), including fully automatic operation:

Contractor: _____ **Date:** _____, 20__

Engineer: _____ **Date:** _____, 20__

(Authorized Signature)

SECTION 26 05 01
ELECTRICAL

PART 1 GENERAL

1.01 RELATED SECTIONS

- A. Requirements specified within this section apply to Division 26, Electrical. Work specified herein shall be performed as if specified in the individual sections. Coordinate all sections and drawings as one contract document.

1.02 REFERENCES

- A. The following is a list of standards which may be referenced in this section:
1. ASTM International (ASTM):
 - a. A167, Standard Specification for Stainless and Heat-Resisting Chromium-Nickel Steel Plate, Sheet, and Strip.
 - b. A240/A240M, Standard Specification for Heat-Resisting Chromium and Chromium-Nickel Stainless Steel Plate, Sheet, and Strip for Pressure Vessels.
 - c. A1011/A1011M, Standard Specification for Steel, Sheet and Strip, Hot-Rolled, Carbon, Structural, High-Strength Low-Alloy and High-Strength Low-Alloy with Improved Formability.
 - d. B8, Standard Specification for Concentric-Lay-Stranded Copper Conductors, Hard, Medium-Hard, or Soft.
 - e. C857, Standard Practice for Minimum Structural Design Loading for Underground Precast Concrete Utility Structures.
 2. Electronic Industries Association (EIA/TIA): 569, Commercial Building Standard for Telecommunications Pathways and Spaces.
 3. Federal Specifications (FS):
 - a. W-C-596, Connector, Electrical, Power, General Specification for.
 - b. W-S-896, Switch, Toggle (Toggle and Lock), Flush Mounted (General Specification).
 4. Institute of Electrical and Electronics Engineers, Inc. (IEEE):
 - a. C62.41, Recommended Practice on Surge Voltages in Low-Voltage AC Power Circuits.
 - b. PC62.41.1, Draft Guide on the Surge Environment in Low-Voltage (1,000 V and less) AC Power Circuits.
 - c. 112, Standard Test Procedure for Polyphase Induction Motors and Generators.
 - d. 114, Standard Test Procedures for Single-Phase Induction Motors.
 5. International Electrical Testing Association (NETA): ATS, Acceptance Testing Specifications for Electrical Power Distribution Equipment and Systems.

6. National Electrical Contractor's Association, Inc. (NECA): 1, Standard Practices for Good Workmanship in Electrical Contracting.
7. National Electrical Manufacturers Association (NEMA):
 - a. C80.1, Rigid Steel Conduit-Zinc Coated.
 - b. C80.3, Electrical Metallic Tubing-Zinc Coated.
 - c. C80.6, Intermediate Metal Conduit-Zinc Coated (IMC).
 - d. 250, Enclosures for Electrical Equipment (1,000 Volts Maximum).
 - e. CC1, Electrical Power Connectors for Substations.
 - f. ICS 1, Industrial Control and Systems: General Requirements.
 - g. ICS 2, Industrial Control and Systems: Controllers, Contactors, and Overload Relays Rated Not More Than 2,000 Volts AC or 750 Volts DC.
 - h. ICS 2.3, Industrial Control and Systems: Instructions for the Handling, Installation, Operation and Maintenance of Motor Control Centers.
 - i. MG 1, Motors and Generators.
 - j. PB 1, Panelboards.
 - k. RN 1, Polyvinyl Chloride (PVC) Externally Coated Galvanized Rigid Steel Conduit and Intermediate Metal Conduit.
 - l. ST 20, Dry Type Transformers for General Applications.
 - m. TC 2, Electrical Polyvinyl Chloride (PVC) Tubing and Conduit.
 - n. TC 3, PVC Fittings for Use with Rigid PVC Conduit and Tubing.
 - o. WC 57, Instrumentation Cables and Thermocouple Wire.
 - p. WC 70, Standard for Non-Shielded Power Cables Rated 2000 V or Less for the Distribution of Electrical Energy.
 - q. WD 1, General Color Requirements for Wiring Devices.
8. National Fire Protection Association (NFPA): 70, National Electrical Code (NEC).
9. Underwriters Laboratories, Inc. (UL):
 - a. 1, Flexible Metal Conduit.
 - b. 6, Electrical Rigid Metal Conduit—Steel.
 - c. 13, Power-Limited Circuit Cables.
 - d. 44, Thermoset Insulated Wires and Cables.
 - e. 62, Flexible Cord and Fixture Wire.
 - f. 67, Panelboards.
 - g. 98, Enclosed and Dead-Front Switches.
 - h. 198C, High Interrupting Capacity Fuses, Current Limiting Types.
 - i. 198E, Class R Fuses.
 - j. 360, Liquid-Tight Flexible Steel Conduit.
 - k. 486A, Wire Connectors and Soldering Lugs for Use with Copper Conductors.
 - l. 486C, Splicing Wire Connectors.
 - m. 489, Molded-Case Circuit Breakers, Molded-Case Switches, and Circuit Breaker Enclosures.
 - n. 508, Industrial Control Equipment.

- o. 510, Polyvinyl Chloride, Polyethylene and Rubber Insulating Tape.
- p. 514B, Fittings for Cable and Conduit.
- q. 674, Electric Motors And Generators for use in Division 1 Hazardous (Classified) Locations.
- r. 854, Service-Entrance Cables.
- s. 1059, Terminal Blocks.
- t. 1561, Dry-Type General Purpose and Power Transformers.
- u. 2111, Overheating Protection for Motors.

1.03 SUMMARY OF WORK

- A. A summary of major tasks for the Lump Sum Base Bid are outlined below. However, all work shown on the drawings and specified herein for each bid item must be completed to provide a completely operational and refurbished FP-3-1. Work shall include all related SCADA, Controls, inputs and outputs discrete and analogs. A mandatory pre-bid meeting will be held at the project location to be determined (TBD) and will take place within two weeks of the bid date; all perspective contractors who wish to submit bids shall be required to attend the mandatory pre-bid meeting.
- B. The successful Contractor shall visit the site prior to beginning, work review entire scope of work and conduct a workshop with the Owner and Owners representative where the contractor will submit a plan for the replacement of components in FP-3-1 and all associated wiring and accessories. The focus of the workshop shall be on the continued operational concerns of all critical systems currently controlled by FP-3-1.
- C. Contractor shall be required to include at their expense RS 5000 programming software and complete all associated programming to match all existing input and out logic. Control logic 5000.
- D. Contractor to install one Allen-Bradley Variable Frequency Drive (VFD) with one Power Flex 755 AC Drive as specified in Specification Section 26 29 23, Variable-Frequency Motor Controller Installation, and as noted on the Drawings. The new drive unit shall consist of the interior inverter unit with all control and power components matching the requirements of the existing VFD as well as the power and control requirements for one 600 Horsepower (hp), 3 Phase 480V ac effluent pump motor. VFD shall be provided to owner for installation in existing cabinets and shall be crated for storage as recommended by the manufacturer. Contractor shall furnish a complete submittal that includes a shop drawing and operations and maintenance manual. VFD shall include manufacturer's standard warranty.

1.04 LUMP SUM SCOPE OF WORK

- A. The following scope of work shall be included in the Contractors lump sum base bid and shall include all materials and labor for a complete and operational system. Contractor shall include all items necessary to complete installation and commissioning of all new components and associated wiring of effluent control panel FP-3-1.
1. Replace existing PLC and all input and output analog and discrete apparatus in FP-3-1 with new components as shown on drawings.
 2. Install PVC Coated rigid steel conduit fittings and hangers.
 3. Install Terminal Junction Boxes as shown on drawings.
 4. Install Cat 6 loop as shown on Drawings.
 5. Reprogram main SCADA screen to match new Panel View supplied and installed under this Contract.
 6. Reconnection and commissioning of all existing input and out puts contained in FP-3-1 and all associated effluent control and instrumentation.
 7. All Associated programming.
 8. Disconnect and reconnect all input and outputs currently installed in FP-3-1.
 9. Replace existing FP-3 PLC with new PLC and HMI as manufactured by Allen Bradley systems including all or the following components:
 - a. Reconnect existing FP-3-1 Annunciator and all associated signals.
 - b. Interface all existing FP-3-1A signals with FP-3-1 new screens and graphics.
 10. Install VFD as specified above and in Specification Section 26 29 23, Variable-Frequency Motor Controller Installation including all shipping, handling, and storage as needed to transfer the new VFD to Owner for installation by others.
- B. General:
1. Perform all electrical testing required to ensure safe and operational system.
 2. Dispose of existing equipment to be removed in this contract per Owner's instructions.

1.05 CONSTRUCTION SEQUENCING GUIDELINES

- A. General: Construction sequencing is extremely important for this Project. All waste water treatment processes must remain operational during the replacement and modifications to be carried out as shown and specified.

1.06 DEFINITIONS

- A. AHJ: Authority Having Jurisdiction.
- B. MCOV: Maximum Allowable Continuous Operating Voltage.
- C. SPD: Surge Protection Device.

1.07 SUBMITTALS

- A. Action Submittals:
 - 1. Provide manufacturers' data for the following:
 - a. All FP-3-1 Components including all equipment and components included in these documents.
 - b. Raceway.
 - c. Trapeze Hangers.
 - d. Terminal Junction Boxes.
 - e. Conductors.
 - f. Cat 6.
 - g. VFD as specified elsewhere in these contract documents including all details, Shop Drawings, and components proposed.
 - h. Shop drawing of proposed conductor extensions, raceway and Junction boxes reflecting actual field dimensions.
 - i. Construction sequence plan including detail narrative of contractors approach to the installation of all components, equipment including the proposed testing and start up process and procedure.
 - 2. Terminal blocks.
 - 3. Support and framing channels.
 - 4. Manufacturer's Literature:
 - a. PVC-coated rigid galvanized steel conduit, submittal to include copy of manufacturer's warranty.
 - b. Conduit fittings.
 - c. Large junction and pull boxes.
 - d. Terminal junction boxes.
 - 5. Equipment and machinery proposed for bending metal conduit.
 - 6. Conduit Layout: Provide plans and section showing arrangement, proposed routing, trapez hangers and fastener locations for all new conduit to be installed.
 - 7. Conductors, cable, and accessories.
 - 8. Grounding materials.
 - 9. Main circuit breaker.
 - 10. Arc flash warning labels.

B. Informational Submittals:

1. Field test reports.
2. Signed permits indicating Work is acceptable to regulatory authorities having jurisdiction.

1.08 QUALITY ASSURANCE

- A. Provide the Work in accordance with NFPA 70. Where required by Authority Having Jurisdiction (AHJ), material and equipment shall be labeled or listed by a nationally recognized testing laboratory or other organization acceptable to the AHJ, in order to provide a basis for approval under the NEC.
- B. Materials and equipment manufactured within the scope of standards published by Underwriters Laboratories Inc. shall conform to those standards and shall have an applied UL listing mark or label.
- C. Provide materials and equipment acceptable to AHJ for Class, Division, and Group of hazardous area indicated.
- D. Terminations for Conductors shall be done by Journeyman Electrician with current credentials.

1.09 APPROVAL BY AUTHORITY HAVING JURISDICTION

- A. Provide the Work in accordance with current edition of NFPA 70, National Electrical Code (NEC). Where required by the Authority Having Jurisdiction (AHJ), material and equipment shall be labeled or listed by a Nationally Recognized Testing Laboratory (NRTL) or other organization acceptable to the AHJ, in order to provide a basis for approval under the NEC.
- B. Materials and equipment manufactured within the scope of standards published by Underwriters Laboratories, Inc. shall conform to those standards and shall have the appropriate listing mark or label by a NRTL.

1.10 ENVIRONMENTAL CONDITIONS

- A. The room where FP-3-1 and proposed VFD's are to be installed in a conditioned space however all other locations shall be considered corrosive, and wet locations.

1.11 ARC FLASH STUDY

- A. Perform arc flash study in accordance with NFPA 70E, OSHA 29 CFR, Part 1910 Subpart S, and IEEE 1584.

- B. Base Calculation:
1. For each major part of electrical power system, determine the following:
 - a. Flash hazard protection boundary.
 - b. Limited approach boundary.
 - c. Restricted approach boundary.
 - d. Prohibited approach boundary.
 - e. Incident energy level.
 - f. Personal protection equipment (PPE) hazard/risk category.
 - g. Type of PPE required.
- C. Produce arc flash warning labels that list items in Paragraph Base Calculation and the following additional items.
1. Bus name.
 2. Bus voltage.
- D. Produce bus detail sheets that list items in Paragraph Base Calculation and the following additional items:
1. Bus name.
 2. Upstream protective device name, type, and settings.
 3. Bus line-to-line voltage.
- E. Produce arc flash evaluation summary sheet listing the following additional items:
1. Bus name.
 2. Upstream protective device name, type, settings.
 3. Bus line-to-line voltage.
 4. Bus bolted fault.
 5. Protective device bolted fault current.
 6. Arcing fault current.
 7. Protective device trip/delay time.
 8. Breaker opening time.
 9. Solidly grounded column.
 10. Equipment type.
 11. Gap.
 12. Arc flash boundary.
 13. Working distance.
 14. Incident energy.
 15. Required protective fire rated clothing type and class.
- F. Analyze short circuit, protective device coordination, and arc flash calculations and highlight equipment that is determined to be underrated or causes incident energy values greater than 8 cal/cm^2 . Propose approaches to reduce energy levels.

- G. Prepare report summarizing arc flash study with conclusions and recommendations which may affect integrity of electric power distribution system. As a minimum, include the following:
1. Equipment manufacturer's information used to prepare study.
 2. Assumptions made during study.
 3. Reduced copy of one-line drawing; 11 inches by 17 inches maximum.
 4. Arc flash evaluations summary spreadsheet.
 5. Bus detail sheets.
 6. Arc flash warning labels printed in color on adhesive backed labels.

1.12 QUALIFICATIONS

- A. PVC-Coated, Rigid Steel Conduit Installer: Must be certified by conduit manufacturer as having received minimum 2 hours of training on installation procedures and manufacturer's on-site verification that the proper equipment for bending, threading, and installation of PVC-coated steel conduit is at the site. The manufacturer shall inspect all repairs to the coating and provide the Owner with written assurance that all repairs have been completed in a manner that will maintain the integrity of the factory coating.

PART 2 PRODUCTS

2.01 GENERAL

- A. Products shall comply with all applicable provisions of NFPA 70.
- B. Like Items of Equipment: End products of one manufacturer in order to achieve standardization for appearance, operation, maintenance, spare parts, and manufacturer's service.
- C. Hazardous Areas: Products shall be acceptable to the regulatory authority having jurisdiction and in accordance with NFPA 70 (NEC) for the class, division or zone, and group of hazardous area indicated.
- D. Equipment Finish: Manufacturer's standard finish color, except where specific color is indicated.
- E. Material and equipment installed in heated and ventilated areas shall be capable of continuous operation at their specified ratings within an ambient temperature range of 40 degrees F to 104 degrees F.
- F. Materials and equipment installed outdoors shall be capable of continuous operation at their specified rating within the ambient temperature range stated in Section 01 61 00, Common Product Requirements.

2.02 JUNCTION AND PULL BOXES

- A. Conduit Bodies Used as Junction Boxes: As specified under Article Conduit and Fittings.
- B. Large Stainless Steel Box:
 - 1. NEMA 250 Type 4X.
 - 2. Box: 14-gauge, ASTM A240/A240M, Type 316 stainless.
 - 3. Cover: Hinged with hand-operated latches.
 - 4. Hardware and Machine Screws: ASTM A167, Type 316 stainless steel.
 - 5. Manufacturers:
 - 6. Terminals and factory back plate painted white
 - a. Hoffman Engineering Co.
 - b. Robroy Industries.
 - c. Wiegman.
 - 7. Conduit and fasteners shall be Type 316 stainless steel 1-5/8 minimum unistrut and 3/8 minimum in stainless steel all thread and hardware.

2.03 TERMINAL BLOCKS

- A. UL 486E and UL 1059.
- B. Size components to allow insertion of necessary wire sizes.
- C. Capable of termination of control circuits entering or leaving equipment, panels, or boxes.
- D. Screw clamp compression, dead front barrier type, with current bar providing direct contact with wire between compression screw and yoke.
- E. Yoke, current bar, and clamping screw of high strength and high conductivity metal.
- F. Yoke shall guide all strands of wire into terminal.
- G. Current bar shall ensure vibration-proof connection.
- H. Terminals:
 - 1. Capable of wire connections without special preparation other than stripping.
 - 2. Capable of jumper installation with no loss of terminal or rail space.
 - 3. Individual, rail mounted.
- I. Marking system, allowing use of preprinted or field-marked tags.

- J. Manufacturers:
 - 1. Weidmuller, Inc.
 - 2. Ideal.
 - 3. Electrovert USA Corp.

2.04 SUPPORT AND FRAMING CHANNELS

- A. PVC Coated Framing Channel: Carbon steel framing channel with 40-mil polyvinyl chloride coating.
- B. Stainless Steel Framing Channel: Rolled, ASTM A167, Type 316 stainless steel, 12-gauge minimum.
- C. Extruded Aluminum Framing Channel:
 - 1. Material: Extruded from Type 6063-T6 aluminum alloy.
 - 2. Fittings fabricated from Alloy 5052-H32.
- D. Manufacturers:
 - 1. B-Line Systems, Inc.
 - 2. Unistrut Corp.
 - 3. Aickinstrut.

2.05 CONDUIT AND FITTINGS

- A. PVC-Coated Rigid Galvanized Steel Conduit for all applications:
 - 1. Meet requirements of NEMA RN 1.
 - 2. Material:
 - a. Meet requirements of NEMA C80.1 and UL 6.
 - b. Exterior Finish: PVC coating, 40 mils nominal thickness, bond to metal shall have tensile strength greater than PVC.
 - c. Interior finish: Urethane coating, 2 mils nominal thickness.
 - 3. Threads: Hot-dipped galvanized and factory coated with urethane.
 - 4. Bendable without damage to either interior or exterior coating.
 - 5. Robroy brands Perma-Cote, Plasti-Bond, and KorKap, no substitutions allowed.
- B. Fittings:
 - 1. Provide bushings, grounding bushings, conduit hubs, conduit bodies, couplings, unions, conduit sealing fittings, drain seals, drain/breather fittings, expansion fittings, and cable sealing fittings, as applicable.
 - 2. PVC-Coated Rigid Galvanized Steel Conduit:
 - a. Meet requirements of UL 514B.
 - b. Fittings: Rigid galvanized steel type, PVC-coated by conduit manufacturer.

- c. Conduit Bodies: Cast metal hot-dipped galvanized or urethane finish. Cover shall be of same material as conduit body. PVC-coated by conduit manufacturer.
 - d. Finish: 40-mil PVC exterior, 2-mil urethane interior.
 - e. Overlapping pressure sealing sleeves.
 - f. Conduit Hangers, Attachments, and Accessories: PVC-coated.
 - g. Manufacturers:
 - 1) Robroy Industries.
 - 2) Ocal.
 - h. Expansion Fitting Manufacturer and Product: Ocal; Ocal-Blue XJG.
3. Flexible Metal, Liquid-Tight Conduit:
- a. Metal insulated throat connectors with integral nylon or plastic bushing rated for 105 degrees C.
 - b. Insulated throat and sealing O-rings.

2.06 CONDUIT ACCESSORIES

A. Identification Devices:

- 1. Raceway Tags:
 - a. Material: Permanent, nonferrous metal.
 - b. Shape: Round.
 - c. Raceway Designation: Pressure stamped, embossed, or engraved.
 - d. Tags relying on adhesives or taped-on markers not permitted.

B. Raceway Band:

- 1. Slip-on Type:
 - a. Provide heat-shrinkable, black, medium-wall polyolefin tubing with factory-applied adhesive/sealant. Select product size based upon raceway outside diameter.
 - b. Manufacturer and Product: 3M; Type IMCSN, medium wall cable sleeve.
- 2. Wrap-around Type:
 - a. Provide 4-inch width, 20-mil thickness, nonprinted black PVC corrosion protection tape with primer.
 - b. Manufacturer and Product: 3M; Type Scotchrap 51 with Scotchrap Pipe Primer.

2.07 CONDUCTORS AND CABLES

A. Conductors 600 Volts and Below:

- 1. Conform to applicable requirements of NEMA WC70, WC 71, WC 72, and WC 74.

- 2. Conductor Type:
 - a. 120- and 277-Volt Lighting, No. 10 AWG and Smaller: Solid copper.
 - b. 120-Volt Receptacle Circuits, No. 10 AWG and Smaller: Solid copper.
 - c. All Other Circuits: Stranded copper.
- 3. Insulation:
 - a. Type XHHW.
 - b. Type THHN/THWN-2, for field wiring.

B. Type 1, Multiconductor Control Cable:

- 1. Conductors:
 - a. No. 14 AWG, seven-strand copper.
 - b. Insulation: 15-mil PVC with 4-mil nylon.
 - c. UL 1581 listed as Type THHN/THWN rated VW-1.
 - d. Conductor group bound with spiral wrap of barrier tape.
 - e. Color Code: In accordance with ICEA S-58-679, Method 1, Table 2.
- 2. Cable: Passes the ICEA T-29-520 210,000 Btu per hour Vertical Tray Flame Test.
- 3. Cable Sizes:

No. of Conductors	Max. Outside Diameter (Inches)	Jacket Thickness (Mils)
3	0.41	45
5	0.48	45
7	0.52	45
12	0.72	60
19	0.83	60
25	1.00	60
37	1.15	80

- 4. Manufacturers:
 - a. Okonite Co.
 - b. Southwire.

C. Type 3, No. 16 AWG, Twisted, Shielded Pair, Instrumentation Cable: Single pair, designed for noise rejection for process control, computer, or data log applications meeting NEMA WC 57 requirements.

- 1. Outer Jacket: 45-mil nominal thickness.
- 2. Individual Pair Shield: 1.35-mil, double-faced aluminum/synthetic polymer overlapped to provide 100 percent coverage.

3. Dimension: 0.31-inch nominal OD.
4. Conductors:
 - a. Bare soft annealed copper, Class B, seven-strand concentric, meeting requirements of ASTM B8.
 - b. 20 AWG, seven-strand tinned copper drain wire.
 - c. Insulation: 15-mil nominal PVC.
 - d. Jacket: 4-mil nominal nylon.
 - e. Color Code: Pair conductors, black and red.
5. Manufacturers:
 - a. Okonite Co.
 - b. Alpha Wire Corp.
 - c. Belden.

D. CAT6 E Cable, 4 pair:

1. 100 Ohm FTP Fire retardant UL Listed.
2. LSOH outer jacket.
3. Synthetic Water repellent.
4. Shielding Polyester AL tape.
5. Insulation triple coat with 515 mm design.
6. Tinned Copper conductor.
7. IEEE 802 IEEE802.5 performance.
8. Insulation: Fire Retardant IEC.
9. UL 1581 listed as Type THHN/THWN rated VW-1.
10. Conductor group bound with spiral wrap of barrier tape.
11. Color Code: In accordance with ICEA S-58-679, Method 1, Table 2.

E. Manufacturers:

1. CAT6 Belden or equal.
2. South Wire for THHN/THWN.
3. Manufacturers standard for internal control panel.

F. Accessories:

1. Tape:
 - a. General Purpose, Flame Retardant: 7 mils, vinyl plastic, Scotch Brand 33, rated for 90 degrees C minimum, meeting requirements of UL 510.
 - b. Flame Retardant, Cold and Weather Resistant: 8.5 mils, vinyl plastic, Scotch Brand 88.
 - c. Arc and Fireproofing:
 - 1) 30 mils, elastomer.
 - 2) Manufacturers and Products:
 - a) 3M; Scotch Brand 77, with Scotch Brand 69 glass cloth tape binder.
 - b) Plymount; Plyarc 53, with Plyglas 77 glass cloth tape binder.

G. Identification Devices:

1. Sleeve:
 - a. Permanent, PVC, yellow or white, with legible machine-printed black markings.
 - b. Manufacturers and Products:
 - 1) Raychem; Type D-SCE or ZH-SCE.
 - 2) Brady, Type 3PS.
2. Heat Bond Marker:
 - a. Transparent thermoplastic heat bonding film with acrylic pressure sensitive adhesive.
 - b. Self-laminating protective shield over text.
 - c. Machine printed black text.
 - d. Manufacturer and Product: 3M Co.; Type SCS-HB.
3. Marker Plate: Nylon, with legible designations permanently hot stamped on plate.
4. Tie-On Cable Marker Tags:
 - a. Chemical-resistant white tag.
 - b. Size: 1/2 inch by 2 inches.
 - c. Manufacturer and Product: Raychem; Type CM-SCE.
5. Grounding Conductor: Permanent green heat-shrink sleeve, 2-inch minimum.
6. Connectors and Terminations:
 - a. Nylon, Self-Insulated Crimp Connectors:
 - 1) Manufacturers and Products:
 - a) Thomas & Betts; Sta-Kon.
 - b) Burndy; Insulug.
 - c) ILSCO.
7. Self-Insulated, Freespring Wire Connector (Wire Nuts):
 - a. Plated steel, square wire springs.
 - b. UL Standard 486C.
 - c. Manufacturers and Products:
 - 1) Thomas & Betts.
 - 2) Ideal; Twister.

H. Cable Lugs:

- a. In accordance with NEMA CC 1.
- b. Rated 600 volts of same material as conductor metal.
- c. Uninsulated Crimp Connectors and Terminators:
 - 1) Suitable for use with 75 degrees C wire at full NFPA 70, 75 degrees C ampacity.
 - 2) Manufacturers and Products:
 - a) Thomas & Betts; Color-Keyed.
 - b) Burndy; Hydent.
 - c) ILSCO.

- d. Uninsulated, Bolted, Two-Way Connectors and Terminators:
 - 1) Manufacturers and Products:
 - a) Thomas & Betts; Locktite.
 - b) Burndy; Quiklug.
 - c) ILSCO.

I. Cable Ties:

- 1. Nylon, adjustable, self-locking, and reusable.
- 2. Manufacturer and Product: Thomas & Betts; TY-RAP.

J. Heat Shrinkable Insulation:

- 1. Thermally stabilized, crosslinked polyolefin.
- 2. Manufacturer and Product: Thomas & Betts; SHRINK-KON.

2.08 CIRCUIT BREAKER, INDIVIDUAL, 0 TO 600 VOLTS

- A. UL 489 listed for use at location of installation.
- B. Minimum Interrupt Rating: 42,000 amps rms symmetrical at 480 volts.
- C. Thermal-magnetic, quick-make, quick-break, indicating type showing ON/OFF and TRIPPED indicating positions of operating handle.
- D. Suitable for use with 75 degrees C wire at full NFPA 70, 75 degrees C ampacity.
- E. Locking: Provisions for padlocking handle.
- F. Enclosure: As shown.
- G. Interlock: Enclosure and switch shall interlock to prevent opening cover with breaker in the ON position.
- H. Exterior Finish:
 - 1. In accordance with manufacturer's recommendations.
 - 2. Color: White.
- I. Manufacturers:
 - 1. Square D.
 - 2. Eaton.

2.09 NAMEPLATES

- A. Material: Laminated plastic.
- B. Attachment Screws: Stainless steel.
- C. Color: White. Engraved to a black core.
- D. Letter Height:
 - 1. Pushbuttons/Selector Switches: 1/8 inch.
 - 2. Other Electrical Equipment: ¼ inch.

2.10 SIGNS AND LABELS

- A. Sign size, lettering, and color shall be in accordance with NEMA Z535.4.

2.11 ARC FLASH WARNING LABELS

- A. Printed in multicolor on adhesive backed labels. An example label is located following end of section in Figure 1.

PART 3 EXECUTION

3.01 GENERAL

- A. Install materials and equipment in accordance with manufacturer's instructions and recommendations.
- B. Install materials and equipment in hazardous areas in a manner acceptable to regulatory authority having jurisdiction for the class, division, and group of hazardous areas shown.
- C. Electrical Drawings show general locations of equipment, devices, and raceways, unless specifically dimensioned. Contractor shall be responsible for actual location of equipment and devices and for proper routing and support of raceways, subject to approval of Engineer.
- D. Check approximate locations of raceways and other electrical system components shown on Drawings for conflicts with openings, structural members, and components of other systems and equipment having fixed locations. In the event of conflicts, notify Engineer in writing.
- E. Install work in accordance with NECA Standard of Installation, unless otherwise specified.
- F. Keep openings in boxes and equipment closed during construction.

- G. Lay out work carefully in advance. Do not cut or notch any structural member without specific approval of Engineer. Carefully perform cutting, channeling, chasing, or drilling of platform, walls, paving, or other surfaces required for the installation, support, or anchorage of conduit, raceways, or other electrical materials and equipment. Following such work, restore surfaces to original condition.
- H. Realign equipment not properly aligned and correct unlevelness.
- I. Properly anchor electrical equipment found to be inadequately anchored.
- J. Tighten accessible bolted connections, including wiring connections, with calibrated torque wrench/screw driver to manufacturer's recommendations, or as otherwise specified in NETA ATS.
- K. Clean contaminated surfaces with cleaning solvents as recommended by manufacturer.
- L. Provide proper lubrication of applicable moving parts.
- M. Electrical Enclosures:
 1. Remove foreign material and moisture from enclosure interior.
 2. Vacuum and wipe clean enclosure interior.
 3. Remove corrosion found on metal surfaces.
 4. Repair or replace, as determined by Engineer door and panel sections having dented surfaces.
 5. Repair or replace, as determined by Engineer poor fitting doors and panel sections.
 6. Repair or replace improperly operating latching, locking, or interlocking devices.
 7. Replace missing or damaged hardware.

3.02 COMBINING CIRCUITS INTO COMMON RACEWAY

- A. Drawings show each homerun circuit to be provided. Do not combine power or control circuits into common raceways without prior authorization of Engineer.

3.03 DEMOLITION

- A. General Demolition:
 1. Where shown, de-energize and disconnect nonelectrical equipment for removal by others.
 2. Where shown, de-energize, disconnect, and remove electrical equipment.

3. Remove affected circuits and raceways back to serving panelboard or control panel. Where affected circuits are consolidated with others, remove raceways back to first shared conduit or box. Where underground or embedded raceways are to be abandoned, remove raceway to 1 inch below surface of structure or 12 inches belowgrade and restore existing surface.

3.04 CLEANING AND TOUCHUP PAINTING

- A. Cleaning: Throughout the Work, clean interior and exterior of devices and equipment by removing debris and vacuuming.
- B. Touchup Paint:
 1. Touchup scratches, scrapes and chips on exterior and interior surfaces of devices and equipment with finish matching type, color, and consistency and type of surface of original finish.
 2. If extensive damage is done to equipment paint surfaces, refinish entire equipment in a manner that provides a finish equal to or better than factory finish, that meets requirements of Specification, and is acceptable to Engineer.

3.05 PROTECTION FOLLOWING INSTALLATION

- A. Protect materials and equipment from corrosion, physical damage, and effects of moisture on insulation.
- B. Cap conduit runs during construction with manufactured seals.
- C. Close openings in boxes or equipment during construction.
- D. Energize space heaters furnished with equipment.

3.06 JUNCTION AND PULL BOXES

- A. Install where shown and where necessary to terminate, tap-off, or redirect multiple conduit runs.
- B. Install pull boxes where necessary in raceway system to facilitate conductor installation.
- C. Use conduit bodies as junction and pull boxes where no splices are required and their use is allowed by applicable codes.
- D. Installed boxes shall be accessible.
- E. Do not install on finished surfaces.

- F. Install plumb and level.
- G. Support boxes independently of conduit by attachment to building structure or structural member.
- H. Mounting Hardware: Stainless steel.
- I. Location/Type:
 - 1. Outdoor: NEMA 250, Type 4X, stainless steel.
 - 2. Underground Conduit: Direct-buried.

3.07 SUPPORT AND FRAMING CHANNELS

- A. Install where required for mounting and supporting electrical equipment and raceway systems.
- B. Channel Type - Outdoor: PVC coated, stainless steel or rigid aluminum.
- C. Treat PVC coated carbon steel channel cut ends prior to installation with cold galvanizing process, and PVC patch.

3.08 CONDUIT AND FITTINGS

- A. Conduit and Tubing sizes shown are based on the use of copper conductors.
- B. All installed Work shall comply with NECA Installation Standards.
- C. Crushed or deformed raceways not permitted.
- D. Maintain raceway entirely free of obstructions and moisture.
- E. Immediately after installation, plug or cap raceway ends with watertight and dust-tight seals until time for pulling in conductors.
- F. Sealing Fittings: Provide drain seal in vertical raceways where condensate may collect above sealing fitting.
- G. Avoid moisture traps where possible. When unavoidable in exposed conduit runs, provide junction box and drain fitting at conduit low point.
- H. Group raceways installed in same area.
- I. Proximity to Heated Piping: Install raceways minimum 12 inches from parallel runs.
- J. Follow structural surface contours when installing exposed raceways. Avoid obstruction of passageways.

- K. Run exposed raceways parallel or perpendicular to walls, structural members, or intersections of vertical planes.
- L. Block Walls: Do not install raceways in same horizontal course or vertical cell with reinforcing steel.
- M. Install watertight fittings in outdoor, underground, or wet locations.
- N. Paint threads and cut ends, before assembly of fittings, galvanized conduit, PVC-coated galvanized conduit, or IMC installed in exposed or damp locations with zinc-rich paint or liquid galvanizing compound.
- O. Metal conduit shall be reamed, burrs removed, and cleaned before installation of conductors, wires, or cables.
- P. Do not install raceways in concrete equipment pads, foundations, or beams.
- Q. Install conduits for fiber optic cables, telephone cables, and Category 5e and 6 data cables in strict conformance with the requirements of EIA/TIA 569-A. Conduit Application:
 - 1. Diameter:
 - a. Minimum Trade Size: 3/4 inch.
 - b. Material: PVC-coated rigid galvanized steel.
- R. Connections:
 - 1. For dry type transformers, instrumentation, and other equipment where flexible connection is required to minimize vibration:
 - a. Flexible metal, liquid-tight conduit.
 - b. Length: 18 inches minimum, 60 inches maximum, sufficient to allow movement or adjustment of equipment.
 - 2. Outdoor areas, process areas exposed to moisture, and areas required to be oiltight and dust-tight: Flexible metal, liquid-tight conduit.
- S. Penetrations:
 - 1. Make at right angles, unless otherwise shown.
 - 2. Notching or penetration of structural members, including footings and beams, not permitted.
 - 3. Apply heat shrinkable tubing or single layer of wraparound duct band to metallic conduit protruding through concrete floor slabs to a point 2 inches above and 2 inches below concrete surface.
 - 4. Concrete Walls, Floors, or Ceilings (Aboveground): Provide nonshrink grout dry-pack, or use watertight seal device.

5. Entering Structures:
 - a. General: Seal raceway at the first box or outlet with oakum or expandable plastic compound to prevent the entrance of gases or liquids from one area to another.

T. Support:

1. Support from structural members only, at intervals not exceeding NFPA 70 requirements, and in any case not exceeding 8 feet. Do not support from piping, pipe supports, or other raceways.
2. Multiple Adjacent Raceways: Provide ceiling trapeze. For trapeze-supported conduit, allow 10 percent extra space for future conduit.
3. Application/Type of Conduit Strap:
 - a. PVC-Coated Rigid Steel Conduit: PVC-coated metal or stainless steel.
4. Provide and attach wall brackets, strap hangers, or ceiling trapeze as follows:
 - a. Wood: Wood screws.
 - b. Hollow Masonry Units: Toggle bolts.
 - c. Concrete or Brick: Expansion shields, or threaded studs driven in by powder charge, with lock washers and nuts.
 - d. Steelwork: Machine screws.
 - e. Location/Type of Hardware: Stainless steel.

U. Bends:

1. Install concealed raceways with a minimum of bends in the shortest practical distance.
2. Make bends and offsets of longest practical radius.
3. Install with symmetrical bends or cast metal fittings.
4. Avoid field-made bends and offsets, but where necessary, make with acceptable hickey or bending machine. Do not heat metal raceways to facilitate bending.
5. Make bends in parallel or banked runs from same center or centerline with same radius so that bends are parallel.
6. Factory elbows may be installed in parallel or banked raceways if there is change in plane of run and raceways are same size.
7. Flexible Conduit: Do not make bends that exceed allowable conductor bending radius of cable to be installed or that significantly restricts conduit flexibility.

V. PVC-Coated Rigid Steel Conduit:

1. Install in accordance with manufacturer's instructions.
2. All tools and equipment used in the cutting, bending, threading, and installation of PVC-coated rigid steel conduit shall be designed to limit damage to the PVC coating.
3. Provide PVC boot to cover all exposed threading.

W. Termination at Enclosures:

1. Cast Metal Enclosure: Provide manufacturer's premolded insulating sleeve inside metallic conduit terminating in threaded hubs.
2. Nonmetallic, Cabinets, and Enclosures: Terminate conduit in threaded conduit hubs, maintaining enclosure integrity.
3. Sheet Metal Boxes, Cabinets, and Enclosures:
 - a. PVC-Coated Rigid Galvanized Steel Conduit: Provide PVC-coated, liquid-tight, metallic connector.
4. Free-Standing Enclosures: Terminate metal conduit entering bottom with grounding bushing; provide a grounding jumper extending to equipment ground bus or grounding pad.

X. Underground Raceways:

1. Grade: Maintain minimum grade of 4 inches in 100 feet, either from one manhole, handhole, or pull box to the next, or from a high point between them, depending on surface contour.
2. Cover: Maintain minimum 2-foot cover above conduit, unless otherwise shown.
3. Make routing changes as necessary to avoid obstructions or conflicts.
4. Couplings: In multiple conduit runs, stagger so couplings in adjacent runs are not in same transverse line.
5. Union type fittings not permitted.
6. Spacers:
 - a. Provide preformed, nonmetallic spacers, designed for such purpose, to secure and separate parallel conduit runs in a trench.
 - b. Install at intervals not greater than that specified in NFPA 70 for support of the type conduit used, but in no case greater than 10 feet.
7. Support conduit so as to prevent bending or displacement during backfilling.
8. Installation with Other Piping Systems:
 - a. Crossings: Maintain minimum 12-inch vertical separation.
 - b. Parallel Runs: Maintain minimum 12-inch separation.
 - c. Installation over valves or couplings not permitted.
9. Metallic Raceway Coating: Along entire length, coat with raceway coating.

Y. Empty Raceways:

1. Provide permanent, removable cap over each end.
2. Provide nylon pull cord.
3. Identify, as specified in Article Identification Devices, with waterproof tags attached to pull cord at each end, and at intermediate pull point.

Z. Identification Devices:

1. Raceway Tags:
 - a. Identify origin and destination.
 - b. Install at each terminus, near midpoint, and at minimum intervals of every 50 feet of exposed raceway, whether in ceiling space or surface mounted.
 - c. Provide corrosion-resistant wire for attachment.
2. Warning Tape: Install approximately 18 inches above underground or concrete-encased raceways. Align parallel to, and within 12 inches of, centerline of runs.

AA. Raceway Band:

1. Install wherever metallic conduit emerges from concrete slabs. Not required with PVC-coated RGS conduit. Center band at slab surface and install according to manufacturer's instructions.
 - a. Slip-on Type: Clean conduit surface at installation location. Cut tubing to 4-inch minimum lengths and slip onto raceway prior to slab placement and termination of conduit. Heat-shrink onto conduit.
 - b. Wrap-around Type: Use where slip-on access to conduit is not possible. Clean conduit surface at installation location. Apply primer. Apply wraps to provide two layers of tape. Neatly finish tape end to prevent unraveling.

3.09 PROTECTION OF INSTALLED WORK

- A. Protect products from effects of moisture, corrosion, and physical damage during construction.
- B. Provide and maintain manufactured watertight and dust-tight seals over all conduit openings during construction.
- C. Touchup painted conduit threads after assembly to cover nicks or scars.
- D. Touchup coating damage to PVC-coated conduit with patching compound approved by manufacturer. Compound shall be kept refrigerated according to manufacturers' instructions until time of use.

3.10 CONDUCTORS AND CABLES

- A. Conductor storage, handling, and installation shall be in accordance with manufacturer's recommendations.
- B. Do not exceed manufacturer's recommendations for maximum pulling tensions and minimum bending radii. Conductor and cable sizing shown is based on copper conductors, unless noted otherwise.
- C. Tighten screws and terminal bolts in accordance with UL 486A-486B.
- D. Cable Lugs: Provide with correct number of holes, bolt size, and center-to-center spacing as required by equipment terminals.
- E. Bundling: Where single conductors and cables in manholes, handholes, vaults, cable trays, and other indicated locations are not wrapped together by some other means, bundle conductors from each conduit throughout their exposed length with cable ties placed at intervals not exceeding 12 inches on-center.
- F. Ream, remove burrs, and clear interior of installed conduit before pulling wires or cables.
- G. Conduit system shall be complete prior to drawing conductors. Lubricate prior to pulling into conduit. Lubrication type shall be as approved by conductor manufacturer.
- H. Terminate all conductors and cables, unless otherwise shown.
- I. Do not splice conductors, unless specifically indicated or approved by Engineer.
- J. Bundling: Where single conductors and cables in manholes, handholes, vaults, cable trays, and other indicated locations are not wrapped together by some other means, bundle conductors from each conduit throughout their exposed length with cable ties placed at intervals not exceeding 12 inches.
- K. Wiring within Equipment and Local Control Panels: Remove surplus wire, dress, bundle, and secure.
- L. Power Conductor Color Coding:
 - 1. No. 6 AWG and Larger: Apply general purpose, flame retardant tape at each end, and at accessible locations wrapped at least six full overlapping turns, covering an area 1-1/2 to 2 inches wide.
 - 2. No. 8 AWG and Smaller: Provide colored conductors.
 - 3. Colors:
 - a. Neutral Wire:
 - 1) White; 120/240 and 120/208 volt systems.
 - 2) Gray; 277/480 volt systems.

- b. Live Wires, 120/240-Volt, Single-Phase System: Black, red.
- c. Live Wires, 120/208-Volt, Three-Phase System: Black, red, or blue.
- d. Live Wires, 277/480-Volt, Three-Phase System: Brown, orange, or yellow.
- e. Ground Wire: Green.

M. Circuit Identification:

- 1. Circuits Appearing in Circuit Schedules: Identify power, instrumentation, and control conductor circuits, using circuit schedule designations, at each termination and in accessible locations such as manholes, handholes, panels, switchboards, motor control centers, pull boxes, and terminal boxes.
- 2. Circuits Not Appearing in Circuit Schedules: Assign circuit name based on device or equipment at load end of circuit. Where this would result in same name being assigned to more than one circuit, add number or letter to each otherwise identical circuit name to make it unique.
- 3. Method: Identify with sleeves. Taped-on markers or tags relying on adhesives not permitted.

N. Connections and Terminations:

- 1. Install wire nuts only on solid conductors.
- 2. Install nylon self-insulated crimp connectors and terminators for instrumentation and control circuit conductors.
- 3. Tape insulate all uninsulated connections.
- 4. Install crimp connectors and compression lugs with tools approved by connector manufacturer.

3.11 CONDUCTORS 600 VOLTS AND BELOW

A. Do not splice conductors, unless specifically approved by Engineer.

B. Connections and Terminations:

- 1. Install nylon self-insulated crimp connectors and terminators for instrumentation and control, circuit conductors.
- 2. Install self-insulated, set screw wire connectors for two-way connection of power circuit conductors 12 AWG and smaller.
- 3. Install uninsulated crimp connectors and terminators for instrumentation, control, and power circuit conductors 4 AWG through 2/0 AWG.
- 4. Install uninsulated, bolted, two-way connectors and terminators for power circuit conductors 3/0 AWG and larger.
- 5. Install uninsulated terminators bolted together on motor circuit conductors 10 AWG and larger.

6. Place no more than one conductor in any single-barrel pressure connection.
 7. Install crimp connectors with tools approved by connector manufacturer.
 8. Install terminals and connectors acceptable for type of material used.
 9. Compression Lugs:
 - a. Attach with a tool specifically designed for purpose. Tool shall provide complete, controlled crimp and shall not release until crimp is complete.
 - b. Do not use plier type crimpers.
- C. Do not use soldered mechanical joints.
- D. Splices and Terminations:
1. Insulate all uninsulated connections.
 2. Indoors: Use general purpose, flame retardant tape or single wall heat shrink.
 3. Outdoors, Dry Locations: Use flame retardant, cold- and weather-resistant tape or single wall heat shrink.
 4. Below Grade and Wet or Damp Locations: Use dual wall heat shrink.
- E. Cap spare conductors with UL listed end caps.
- F. Cabinets, Panels, and Motor Control Centers:
1. Remove surplus wire, bridle and secure.
 2. Where conductors pass through openings or over edges in sheet metal, remove burrs, chamfer edges, and install bushings and protective strips of insulating material to protect the conductors.
- G. Control and Instrumentation Wiring:
1. Where terminals provided will accept such lugs, terminate control and instrumentation wiring, except solid thermocouple leads, with insulated, locking-fork compression lugs.
 2. Terminate with methods consistent with terminals provided, and in accordance with terminal manufacturer's instructions.
 3. Locate splices in readily accessible cabinets or junction boxes using terminal strips.
 4. Cable Protection:
 - a. Under Infinite Access Floors: May install without bundling.
 - b. All Other Areas: Install individual wires, pairs, or triads in flex conduit under floor or grouped into bundles at least 1/2 inch in diameter.
 - c. Maintain integrity of shielding of instrumentation cables.

- d. Ensure grounds do not occur because of damage to jacket over the shield.
- H. Extra Conductor Length: For conductors to be connected by others, install minimum 6 feet of extra conductor in freestanding panels and minimum 2 feet in other assemblies.
- I. Communications Tests: Contractor shall coordinate with Plant technicians to ensure proper communications have been established between FP-3-1 and Plant SCADA SYSTEM.

3.12 GROUNDING

- A. Grounding shall be in compliance with NFPA 70 and as shown.
- B. Ground electrical service neutral at service entrance equipment to supplementary grounding electrodes.
- C. Ground each separately derived system neutral to nearest effectively grounded building structural steel member or separate grounding electrode.
- D. Bond together system neutrals, service equipment enclosures, exposed noncurrent-carrying metal parts of electrical equipment, metal raceways, ground conductor in raceways and cables, receptacle ground connections, and metal piping systems.
- E. Shielded Instrumentation Cables:
 - 1. Ground shield to ground bus at power supply for analog signal.
 - 2. Expose shield minimum 1 inch at termination to field instrument and apply heat shrink tube.
 - 3. Do not ground instrumentation cable shield at more than one point.
- F. Equipment Grounding Conductors: Provide in all conduits containing power conductors and control circuits above 50 volts.
- G. Visual and Mechanical Inspection:
 - 1. Equipment and circuit grounds in pump control panel and RTU assemblies for proper connection and tightness.
 - 2. Ground bus connections in pump control panel and RTU assemblies for proper termination and tightness.
 - 3. Effective transformer core and equipment grounding.
 - 4. Accessible connections to grounding electrodes for proper fit and tightness.
 - 5. Accessible exothermic-weld grounding connections to verify that molds were fully filled and proper bonding was obtained.

3.13 FIELD QUALITY CONTROL

- A. Tests shall be performed in accordance with the requirements of Section 01 91 14, Equipment Testing and Facility Startup.
- B. General:
 - 1. Test equipment shall have an operating accuracy equal to, or greater than, requirements established by NETA ATS.
 - 2. Test instrument calibration shall be in accordance with NETA ATS.
 - 3. Perform inspection and electrical tests after equipment has been installed.
 - 4. Perform tests with apparatus de-energized whenever feasible.
 - 5. Inspection and electrical tests on energized equipment are to be:
 - a. Scheduled with Owner prior to de-energization.
 - b. Minimized to avoid extended period of interruption.
- C. Tests and inspection shall establish that:
 - 1. Electrical equipment is operational within industry and manufacturer's tolerances.
 - 2. Installation operates properly.
 - 3. Equipment is suitable for energization.
 - 4. Installation conforms to requirements of Contract Documents and NFPA 70.
- D. Perform inspection and testing in accordance with NETA ATS, industry standards, and manufacturer's recommendations.
- E. Adjust mechanisms and moving parts for free mechanical movement.
- F. Verify nameplate data for conformance to Contract Documents.
- G. Realign equipment not properly aligned and correct unlevelness.
- H. Properly anchor electrical equipment found to be inadequately anchored.
- I. Tighten accessible bolted connections, including wiring connections, with calibrated torque wrench to manufacturer's recommendations, or as otherwise specified.
- J. Clean contaminated surfaces with cleaning solvents as recommended by manufacturer.
- K. Provide proper lubrication of applicable moving parts.

- L. Investigate and repair or replace:
 - 1. Electrical items that fail tests.
 - 2. Active components not operating in accordance with manufacturer's instructions.
 - 3. Damaged electrical equipment.

- M. Electrical Enclosures:
 - 1. Remove foreign material and moisture from enclosure interior.
 - 2. Vacuum and wipe clean enclosure interior.
 - 3. Remove corrosion found on metal surfaces.
 - 4. Repair or replace, as determined by Engineer, door and panel sections having damaged surfaces.
 - 5. Replace missing or damaged hardware.

- N. Provide certified test report(s) documenting the successful completion of specified testing. Include field test measurement data.

- O. Test the following equipment and materials: Grounding electrodes.

- P. Controls:
 - 1. Test control and signal wiring for proper termination and function.
 - 2. Test local control panels and other control devices for proper terminations, configuration and settings, and functions.
 - 3. Demonstrate control, monitoring, and indication functions in presence of Owner and Engineer.

3.14 NAMEPLATES, SIGNS, AND LABELS

- A. Labels shall be 2 in letters laminated plastic white letters black background with stainless steel fasteners.

- B. Arc Flash Protection Warning Signs and Labels:
 - 1. Field mark Main Circuit Breaker, Automatic Transfer Switch, Pump Control Panel, Generator Circuit Breaker/Control Panel and Mini Power Center to warn qualified persons of potential arc-flash hazards. Locate marking so to be clearly visible to persons before working on energized equipment.
 - 2. Calculate arc flash boundary and energy in accordance with NFPA 70E and IEEE 1584. Determine level of personnel protective equipment (PPE) required. Warning label on equipment shall include flash hazard boundary, energy level, PPE level and description, shock hazard, bolted fault current, and equipment name.

3. Use available short circuit current obtained from the electrical utility (KEYS Energy).

C. Equipment Nameplates:

1. Provide a nameplate to label electrical equipment including Main Circuit Breaker, Pump Control Panel, terminal junction boxes, and control stations.
2. Pump Control Panel, nameplate shall include equipment designation, service voltage, and phases.
3. Terminal junction box nameplates shall include equipment designation.
4. Pump Control Panel and control station nameplates shall include name and number of equipment powered or controlled by that device.
5. Provide a nameplate to label electrical equipment including terminal junction boxes, switches and control stations.
6. Nameplates required for FP-3-1, FP-3-1A, TJB FP3-1 to SCADA, confirm with Owner prior to procuring or installing labels.

3.15 SUPPLEMENTS

- A. The supplement listed below, following “End of Section,” is a part of this Specification:

1. Figure 1: Example Arc Flash Label.

END OF SECTION

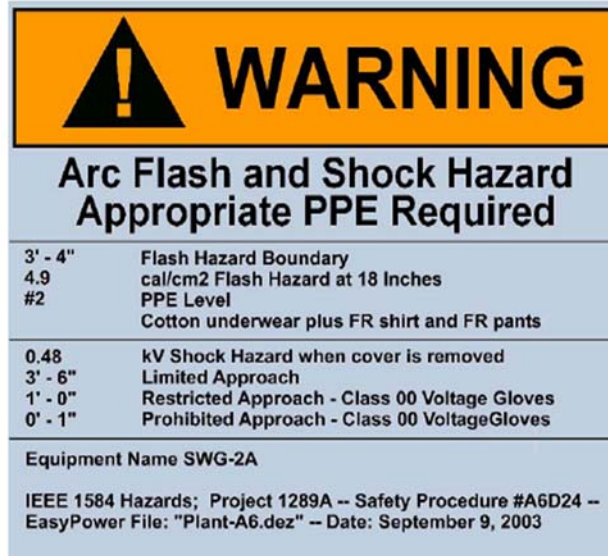

Figure 1
Example Arc Flash Label

SECTION 26 08 00
COMMISSIONING OF ELECTRICAL SYSTEMS

PART 1 GENERAL

1.01 REFERENCES

- A. The following is a list of standards which may be referenced in this section:
1. ASTM International (ASTM):
 - a. D877, Standard Test Method for Dielectric Breakdown Voltage of Insulating Liquids Using Disk Electrodes.
 - b. D923, Standard Practice for Sampling Electrical Insulating Liquids.
 - c. D924, Standard Test Method for Dissipation Factor (or Power Factor) and Relative Permittivity (Dielectric Constant) of Electrical Insulating Liquids.
 - d. D971, Standard Test Method for Interfacial Tension of Oil Against Water by the Ring Method.
 - e. D974, Standard Test Method for Acid and Base Number by Color-Indicator Titration.
 - f. D1298, Standard Test Method for Density, Relative Density (Specific Gravity), or API Gravity of Crude Petroleum and Liquid Petroleum Products by Hydrometer Method.
 - g. D1500, Standard Test Method for ASTM Color of Petroleum Products (ASTM Color Scale).
 - h. D1524, Standard Test Method for Visual Examination of Used Electrical Insulating Oils of Petroleum Origin in the Field.
 - i. D1533, Standard Test Method for Water in Insulating Liquids by Coulometric Karl Fischer Titration.
 - j. D1816, Standard Test Method for Dielectric Breakdown Voltage of Insulating Oils of Petroleum Origin Using VDE Electrodes.
 2. Institute of Electrical and Electronics Engineers (IEEE):
 - a. 43, Recommended Practice for Testing Insulating Resistance of Rotating Machinery.
 - b. 48, Standard Test Procedures and Requirements for Alternating-Current Cable Terminators Used on Shielded Cables Having Laminated Insulation Rated 2.5 kV through 765 kV or Extruded Insulation Rated 2.5kV through 500kV.
 - c. 81, Guide for Measuring Earth Resistivity, Ground Impedance, and Earth Surface Potentials of a Ground System.
 - d. 95, Recommended Practice for Insulation Testing of AC Electric Machinery (2300V and Above) with High Direct Voltage.
 - e. 386, Standard for Separable Insulated Connector Systems for Power Distribution Systems Above 600V.

- f. 400, Guide for Field Testing and Evaluation of the Insulation of Shielded Power Cable Systems.
 - g. 450, Recommended Practice for Maintenance, Testing, and Replacement of Vented Lead-Acid Batteries for Stationary Applications.
 - h. C2, National Electrical Safety Code.
 - i. C37.20.1, Standard for Metal-Enclosed Low Voltage Power Circuit Breaker Switchgear.
 - j. C37.20.2, Standard for Metal-Clad Switchgear.
 - k. C37.20.3, Standard for Metal-Enclosed Interrupter Switchgear.
 - l. C37.23, Standard for Metal-Enclosed Bus.
 - m. C62.33, Standard Test Specifications for Varistor Surge-Protective Devices.
- 3. Insulated Cable Engineers Association (ICEA):
 - a. S-93-639, 5-46 kV Shielded Power Cables for Use in the Transmission and Distribution of Electric Energy.
 - b. S-94-649, Concentric Neutral Cables Rated 5 through 46 kV.
 - c. S-97-682, Standard for Utility Shielded Power Cables Rated 5 through 46 kV.
 - 4. National Electrical Manufacturers Association (NEMA):
 - a. AB 4, Guidelines for Inspection and Preventive Maintenance of Molded Case Circuit Breakers Used in Commercial and Industrial Applications.
 - b. PB 2, Deadfront Distribution Switchboards.
 - c. WC 74, 5-46 kV Shielded Power Cable for Use in the Transmission and Distribution of Electric Energy.
 - 5. InterNational Electrical Testing Association (NETA): ATS, Acceptance Testing Specifications for Electrical Power Distribution Equipment and Systems.
 - 6. National Fire Protection Association (NFPA):
 - a. 70, National Electrical Code (NEC).
 - b. 70B, Recommended Practice for Electrical Equipment Maintenance.
 - c. 70E, Standard for Electrical Safety in the Workplace.
 - d. 101, Life Safety Code.
 - 7. National Institute for Certification in Engineering Technologies (NICET).
 - 8. Occupational Safety and Health Administration (OSHA): CFR 29, Part 1910, Occupational Safety and Health Standards.

1.02 SUBMITTALS

A. Informational Submittals:

1. Submit 30 days prior to performing inspections or tests:
 - a. Schedule for performing inspection and tests.
 - b. List of references to be used for each test.
 - c. Sample copy of equipment and materials inspection form(s).
 - d. Sample copy of individual device test form.
 - e. Sample copy of individual system test form.
2. Energization Plan: Prior to initial energization of electrical distribution equipment; include the following:
 - a. Owner's representative sign-off form for complete and accurate arc flash labeling and proper protective device settings for equipment to be energized.
 - b. Staged sequence of initial energization of electrical equipment.
 - c. Lock-Out-Tag-Out plan for each stage of the progressive energization.
 - d. Barricading, signage, and communication plan notifying personnel of newly energized equipment.
3. Submit test or inspection reports and certificates for each electrical item tested within 30 days after completion of test:
4. Operation and Maintenance Data:
 - a. In accordance with Section 01 78 23, Operation and Maintenance Data.
 - b. After test or inspection reports and certificates have been reviewed by Engineer and returned, insert a copy of each in Operation and Maintenance Manual.
5. Programmable Settings: At completion of Performance Demonstration Test, submit final hardcopy printout and electronic files on compact disc of as-left setpoints, programs, and device configuration files for:
 - a. Protective relays.
 - b. Intelligent overload relays.
 - c. Variable frequency drives.
 - d. Power metering devices.
 - e. Uninterruptible power supplies.
 - f. Electrical communications modules.

1.03 QUALITY ASSURANCE

A. Testing Firm Qualifications:

1. Corporately and financially independent organization functioning as an unbiased testing authority.
2. Professionally independent of manufacturers, suppliers, and installers of electrical equipment and systems being tested.

3. Employer of engineers and technicians regularly engaged in testing and inspecting of electrical equipment, installations, and systems.
 4. Supervising engineer accredited as Certified Electrical Test Technologist by NICET or NETA and having a minimum of 5 years' testing experience on similar projects.
 5. Technicians certified by NICET or NETA.
 6. Assistants and apprentices assigned to Project at ratio not to exceed two certified to one noncertified assistant or apprentice.
 7. Registered Professional Engineer to provide comprehensive Project report outlining services performed, results of such services, recommendations, actions taken, and opinions.
 8. In compliance with OSHA CFR 29, Part 1910.7 criteria for accreditation of testing laboratories or a full member company of NETA.
- B. Test equipment shall have an operating accuracy equal to or greater than requirements established by NETA ATS.
- C. Test instrument calibration shall be in accordance with NETA ATS.

1.04 SEQUENCING AND SCHEDULING

- A. Perform inspection and electrical tests after equipment listed herein has been installed.
- B. Perform tests with apparatus de-energized whenever feasible.
- C. Inspection and electrical tests on energized equipment shall be:
 1. Scheduled with Owner prior to de-energization.
 2. Minimized to avoid extended period of interruption to the operating plant equipment.
- D. Notify Owner at least 48 hours prior to performing tests on energized electrical equipment.

PART 2 PRODUCTS (NOT USED)

PART 3 EXECUTION

3.01 GENERAL

- A. Perform tests in accordance with requirements of Section 01 91 14, Equipment Testing and Facility Startup.

- B. Tests and inspections shall establish:
 - 1. Electrical equipment is operational within industry and manufacturer's tolerances and standards.
 - 2. Installation operates properly.
 - 3. Equipment is suitable for energization.
 - 4. Installation conforms to requirements of Contract Documents and NFPA 70, NFPA 70E, NFPA 101, and IEEE C2.
- C. Perform inspection and testing in accordance with NETA ATS, industry standards, and manufacturer's recommendations.
- D. Configure, program, set, test, and calibrate protective relays, circuit breakers, fuses, power monitoring meters, and other applicable devices in accordance with values established by short circuit and coordination studies.
- E. Adjust mechanisms and moving parts of equipment for free mechanical movement.
- F. Adjust and set electromechanical electronic relays and sensors to correspond to operating conditions, or as recommended by manufacturer.
- G. Verify nameplate data for conformance to Contract Documents and approved Submittals.
- H. Realign equipment not properly aligned and correct unlevelness.
- I. Properly anchor electrical equipment found to be inadequately anchored.
- J. Tighten accessible bolted connections, including wiring connections, with calibrated torque wrench/screw driver to manufacturer's recommendations, or as otherwise specified in NETA ATS.
- K. Clean contaminated surfaces with cleaning solvents as recommended by manufacturer.
- L. Provide proper lubrication of applicable moving parts.
- M. Inform Engineer of working clearances not in accordance with NFPA 70.
- N. Investigate and repair or replace:
 - 1. Electrical items that fail tests.
 - 2. Active components not operating in accordance with manufacturer's instructions.
 - 3. Damaged electrical equipment.
- O. Electrical Enclosures:

1. Remove foreign material and moisture from enclosure interior.
2. Vacuum and wipe clean enclosure interior.
3. Remove corrosion found on metal surfaces.
4. Repair or replace, as determined by Engineer door and panel sections having dented surfaces.
5. Repair or replace, as determined by Engineer poor fitting doors and panel sections.
6. Repair or replace improperly operating latching, locking, or interlocking devices.
7. Replace missing or damaged hardware.
8. Finish:
 - a. Provide matching paint and touch up scratches and mars.
 - b. If required because of extensive damage, as determined by Engineer, refinish entire assembly.

- P. Replace fuses and circuit breakers that do not conform to size and type required by the Contract Documents or approved Submittals.

3.02 CHECKOUT AND STARTUP

A. Voltage Field Test:

1. Check voltage at point of termination of power company supply system to Project when installation is essentially complete and is in operation.
2. Check voltage amplitude and balance between phases for loaded and unloaded conditions.
3. Record supply voltage (all three phases simultaneously on same graph) for 24 hours during normal working day.
 - a. Submit Voltage Field Test Report within 5 days of test.
4. Unbalance Corrections:
 - a. Make written request to power company to correct condition if balance (as defined by NEMA) exceeds 1 percent, or if voltage varies throughout the day and from loaded to unloaded condition more than plus or minus 4 percent of nominal.
 - b. Obtain written certification from responsible power company official that voltage variations and unbalance are within their normal standards if corrections are not made.

B. Equipment Line Current Tests:

1. Check line current in each phase for each piece of equipment.
2. Make line current check after power company has made final adjustments to supply voltage magnitude or balance.
3. If phase current for a piece of equipment is above rated nameplate current, prepare Equipment Line Phase Current Report that identifies cause of problem and corrective action taken.

3.03 LOW VOLTAGE CABLES, 600 VOLTS MAXIMUM

A. Visual and Mechanical Inspection:

1. Inspect each individual exposed power cable No. 6 and larger for:
 - a. Physical damage.
 - b. Proper connections in accordance with single-line diagram.
 - c. Cable bends not in conformance with manufacturer's minimum allowable bending radius where applicable.
 - d. Color coding conformance with specification.
 - e. Proper circuit identification.
2. Mechanical Connections For:
 - a. Proper lug type for conductor material.
 - b. Proper lug installation.
 - c. Bolt torque level in accordance with NETA ATS, Table 100.12, unless otherwise specified by manufacturer.
3. Shielded Instrumentation Cables For:
 - a. Proper shield grounding.
 - b. Proper terminations.
 - c. Proper circuit identification.
4. Control Cables For:
 - a. Proper termination.
 - b. Proper circuit identification.
5. Cables Terminated Through Window Type CTs: Verify neutrals and grounds are terminated for correct operation of protective devices.

B. Electrical Tests for Conductors No. 6 and Larger:

1. Insulation Resistance Tests:
 - a. Utilize 1,000-volt dc megohmmeter for 600-volt insulated conductors and 500-volt dc megohmmeter for 300-volt insulated conductors.
 - b. Test each conductor with respect to ground and to adjacent conductors for 1 minute.
 - c. Evaluate ohmic values by comparison with conductors of same length and type.
 - d. Investigate values less than 50 megohms.
2. Continuity test by ohmmeter method to ensure proper cable connections.

C. Low-voltage cable tests may be performed by installer in lieu of independent testing firm.

3.04 MOLDED AND INSULATED CASE CIRCUIT BREAKERS

A. General: Inspection and testing limited to circuit breakers rated 70 amperes and larger and to motor circuit protector breakers rated 50 amperes and larger.

B. Visual and Mechanical Inspection:

1. Proper mounting.
2. Proper conductor size.
3. Feeder designation according to nameplate and one-line diagram.
4. Cracked casings.
5. Connection bolt torque level in accordance with NETA ATS, Table 100.12.
6. Operate breaker to verify smooth operation.
7. Compare frame size and trip setting with circuit breaker schedules or one-line diagram.
8. Verify that terminals are suitable for 75 degrees C rated insulated conductors.

C. Electrical Tests:

1. Insulation Resistance Tests:
 - a. Utilize 1,000-volt dc megohmmeter for 480-volt and 600-volt circuit breakers and 500-volt dc megohmmeter for 240-volt circuit breakers.
 - b. Pole-to-pole and pole-to-ground with breaker contacts opened for 1 minute.
 - c. Pole-to-pole and pole-to-ground with breaker contacts closed for 1 minute.
 - d. Test values to comply with NETA ATS, Table 100.1.
2. Contact Resistance Tests:
 - a. Contact resistance in microhms across each pole.
 - b. Investigate deviation of 50 percent or more from adjacent poles and similar breakers.
3. Primary Current Injection Test to Verify:
 - a. Long-time minimum pickup and delay.
 - b. Short-time pickup and delay.
 - c. Ground fault pickup and delay.
 - d. Instantaneous pickup by run-up or pulse method.
 - e. Trip characteristics of adjustable trip breakers shall be within manufacturer's published time-current characteristic tolerance band, including adjustment factors.
 - f. Trip times shall be within limits established by NEMA AB 4, Table 5-3. Alternatively, use NETA ATS, Table 100.7.
 - g. Instantaneous pickup value shall be within values established by NEMA AB 4, Table 5-4. Alternatively, use NETA ATS, Table 100.8.

3.05 LOW VOLTAGE POWER CIRCUIT BREAKERS

A. Visual and Mechanical Inspection:

1. Proper mounting, cell fit, and element alignment.
2. Proper operation of racking interlocks.
3. Check for damaged arc chutes.
4. Proper contact condition.
5. Bolt torque level in accordance with NETA ATS, Table 100.12.
6. Perform mechanical operational and contact alignment tests in accordance with manufacturer's instructions.
7. Check operation of closing and tripping functions of trip devices by activating ground fault relays, undervoltage shunt relays, and other auxiliary protective devices.
8. Verify primary and secondary contact wipe, gap setting, and other dimensions vital to breaker operation are correct.
9. Check charging motor, motor brushes, associated mechanism, and limit switches for proper operation and condition.
10. Check operation of electrically operated breakers in accordance with manufacturer's instructions.
11. Check for adequate lubrication on contact, moving, and sliding surfaces.

B. Electrical Tests:

1. Insulation Resistance Tests:
 - a. Utilize 1,000-volt dc megohmmeter for 480-volt and 600-volt circuit breakers.
 - b. Pole-to-pole and pole-to-ground with breaker contacts opened for 1 minute.
 - c. Pole-to-pole and pole-to-ground with breaker contacts closed for 1 minute.
 - d. Test values to comply with NETA ATS, Table 100.1.
2. Contact Resistance Tests:
 - a. Contact resistance in microhms across each pole.
 - b. Investigate deviation of 50 percent or more from adjacent poles and similar breakers.
3. Primary Current Injection Test to Verify:
 - a. Long-time minimum pickup and delay.
 - b. Short-time pickup and delay.
 - c. Ground fault pickup and delay.
 - d. Instantaneous pickup by run-up or pulse method.
 - e. Trip characteristic when adjusted to setting sheet parameters shall be within manufacturer's published time-current tolerance band.

3.06 PROTECTIVE RELAYS

A. Visual and Mechanical Inspection:

1. Visually check each relay for:
 - a. Tight cover gasket and proper seal.

- b. Unbroken cover glass.
 - c. Condition of spiral spring and contacts.
 - d. Disc clearance.
 - e. Condition of case shorting contacts if present.
2. Mechanically check each relay for:
 - a. Freedom of movement.
 - b. Proper travel and alignment.
 3. Verify each relay:
 - a. Complies with Contract Documents, approved Submittal, and application.
 - b. Is set in accordance with recommended settings from Coordination Study.

B. Electrical Tests:

1. Insulation resistance test on each circuit to frame, except for solid state devices.
2. Test on nominal recommended setting for:
 - a. Pickup parameters on each operating element.
 - b. Timing at three points on time-current curve.
 - c. Pickup target and seal-in units.
 - d. Special tests as required to check operation of restraint, directional, and other elements in accordance with manufacturer's instruction manual.
3. Phase angle and magnitude contribution tests on differential and directional relays after energization to vectorially verify proper polarity and connections.
4. Current Injection Tests:
 - a. For entire current circuit in each section.
 - b. Secondary injection for current flow of 1 ampere.
 - c. Test current at each device.

3.07 INSTRUMENT TRANSFORMERS

A. Visual and Mechanical Inspection:

1. Visually check current, potential, and control transformers for:
 - a. Cracked insulation.
 - b. Broken leads or defective wiring.
 - c. Proper connections.
 - d. Adequate clearances between primary and secondary circuit wiring.
2. Verify Mechanically:
 - a. Grounding and shorting connections have good contact.
 - b. Withdrawal mechanism and grounding operation, when applicable, operate properly.

3. Verify proper primary and secondary fuse sizes for potential transformers.

B. Electrical Tests:

1. Current Transformer Tests:
 - a. Insulation resistance test of transformer and wiring-to-ground at 1,000 volts dc for 30 seconds.
 - b. Polarity test.
2. Potential Transformer Tests:
 - a. Insulation resistance test at test voltages in accordance with NETA ATS, Table 100.9, for 1 minute on:
 - 1) Winding-to-winding.
 - 2) Winding-to-ground.
 - b. Polarity test to verify polarity marks or H1-X1 relationship as applicable.
3. Insulation resistance measurement on instrument transformer shall not be less than that shown in NETA ATS, Table 100.5.

3.08 METERING

A. Visual and Mechanical Inspection:

1. Verify meter connections in accordance with appropriate diagrams.
2. Verify meter multipliers.
3. Verify meter types and scales conform to Contract Documents.
4. Check calibration of meters at cardinal points.
5. Check calibration of electrical transducers.

3.09 GROUNDING SYSTEMS

A. Visual and Mechanical Inspection:

1. Equipment and circuit grounds in motor control center, adjustable frequency drive panel, panelboard, switchboard, and switchgear assemblies for proper connection and tightness.
2. Ground bus connections in motor control center, panelboard, switchboard, and switchgear assemblies for proper termination and tightness.
3. Effective transformer core and equipment grounding.
4. Accessible connections to grounding electrodes for proper fit and tightness.
5. Accessible exothermic-weld grounding connections to verify that molds were fully filled and proper bonding was obtained.

B. Electrical Tests:

1. Computer-Based Grounding Multimeter:
 - a. In accordance with IEEE 81, Section 8.2.2.7 for measurement of each building's or structure's main ground system's resistance.
 - b. Main ground electrode system resistance to ground to be no greater than 1 ohm(s).
2. Fall-of-Potential Test:
 - a. In accordance with IEEE 81, Section 8.2.2.4 for measurement of ground resistance between main ground system, equipment frames, and system neutral and derived neutral points.
 - b. Equipment ground resistance shall not exceed main ground system resistance by 0.50 ohm.

3.10 GROUND FAULT SYSTEMS

A. Inspection and testing limited to:

1. Zero sequence grounding systems.
2. Residual ground fault systems.

B. Visual and Manual Inspection:

1. Neutral main bonding connection to ensure:
 - a. Zero sequence sensing system is grounded ahead of neutral disconnect link.
 - b. Ground strap sensing system is grounded through sensing device.
 - c. Neutral ground conductor is solidly grounded.
2. Verify control power has adequate capacity for system.
3. Manually operate monitor panels for:
 - a. Trip test.
 - b. No trip test.
 - c. Nonautomatic rest.
4. Zero sequence system for symmetrical alignment of core balance transformers about current carrying conductors.
5. Relay check for pickup and time under simulated ground fault conditions.
6. Verify nameplate identification by device operation.

C. Electrical Tests:

1. Test system neutral insulation resistance with neutral ground link removed; minimum 1 megohm.
2. Determine relay pickup by primary current injection at the sensor. Relay pickup current within plus or minus 10 percent of device dial or fixed setting.
3. Test relay timing by injecting 300 percent of pick-up current or as specified by manufacturer. Relay operating time in accordance with manufacturer's time-current characteristic curves.

4. Test system operation at 55 percent rated control voltage, if applicable.
5. Test zone interlock system by simultaneous sensor current injection and monitoring zone blocking functions.

END OF SECTION

SECTION 26 29 23
VARIABLE-FREQUENCY MOTOR CONTROLLER INSTALLATION

PART 1 GENERAL

1.01 SUMMARY

- A. The Variable Frequency Drive (VFD) system shall contain all components required to meet the performance, protection, safety and certification criteria of this specification. All existing control functions shall be retained VFD must contain sufficient power lead connection points sized for existing line and load conductors and buss bars. VFD's shall further contain enough input and output (I/O) control points to terminate all existing discrete and analog functions as well as provisions for 20 percent spare capacity.

- B. All work in this section shall be under the oversight of Rockwell Automation Field Service Engineer.

1.02 DEFINITIONS

- A. Terms that may be used in this section:
 - 1. VFD: Adjustable frequency drive.
 - 2. CMOS: Complementary metal oxide semiconductor.
 - 3. CSI: Current source inverter.
 - 4. EMU: Energy monitoring unit.
 - 5. GTO: Gate turn-off thyristor.
 - 6. MPR: Motor protection relay.
 - 7. MTBF: Mean time between failure.
 - 8. PWM: Pulse width modulation.
 - 9. ROM: Read only memory.
 - 10. RTD: Resistance temperature detector.
 - 11. RTU: Remote Telemetry Unit.
 - 12. Rated Load: Load specified for equipment.
 - 13. Rated Speed: Nominal rated (100 percent) speed specified for equipment.
 - 14. TDD: Total demand distortion.
 - 15. THD: Total harmonic distortion.
 - 16. TTL: Transistor logic.

1.03 SYSTEM DESCRIPTION

A. This Specification Covers:

1. VFD 2 modification to existing controls, and testing of new discrete signals connecting to an existing Adjustable Frequency Drive package for existing Effluent Pump No. 2 (P-6-2-2). The control section for the VFD was originally installed in 1996. The power section of this VFD was installed in 2015. and has the following criteria: 60 hp, 460V with harmonic filter, located in a ventilated UL Type 1 enclosure.
2. VFD-1 including installation, testing, and commissioning of the new VFD-1 power section, modification to existing controls, and testing of new discrete signals connecting to an existing Adjustable Frequency Drive for existing Effluent Pump No. 1 (P-6-2-1). This VFD was originally installed in 1997 and has the following criteria: 600 hp, 460V with harmonic filter in a ventilated UL Type 1 enclosure.

B. Performance Requirements: This Specification covers, installation, testing and commissioning of VFDs.

1.04 SUBMITTALS

A. Informational Submittals: Field Functional and performance testing reports.

1.05 QUALITY ASSURANCE

A. Pre-installation Meeting:

1. As a minimum, an onsite coordination meeting between the Contractor, Equipment supplier, the Engineer, and the Owner shall be held prior to the uncrating and installation of any equipment.
2. Additional coordination meeting may be required by Engineer or Owner at no additional cost to the Owner to ensure proper procedures are being followed.

1.06 DELIVERY, STORAGE, AND HANDLING

- A. Contractor shall store the equipment in a clean and dry space at an ambient temperature range of -25 °C to 55 °C (-13 °F to 130 °F).
- B. The Contractor shall protect the units from dirt, water, construction debris and traffic.

PART 2 PRODUCTS

2.01 GENERAL

- A. The Contractor shall provide electrical components in accordance with Division 26, Electrical, for a complete, functioning system

PART 3 EXECUTION

3.01 INSTALLATION

- A. Install in accordance with manufacturer's printed instructions.
- B. Modify existing controls per control diagrams.

3.02 FIELD QUALITY CONTROL

- A. The Contractor, in conjunction with Equipment Supplier, shall provide field functional and performance testing as described below.
- B. Functional Test:
 - 1. Conduct on each controller.
 - 2. Inspect controller for electrical supply termination connections, interconnections, proper installation, and quiet operation.
 - 3. Vibration Test:
 - a. Complete assembly, consisting of motor, load, and flexible shafting, connected and in normal operation shall not develop amplitudes of vibration exceeding limits recommended by HIS.
 - b. Where loads and drives are separated by intermediate flexible shafting, measure vibration both at top motor bearing and at two points on top pump bearing, 90 degrees apart.
 - 4. Record test data for report.
- C. Performance Test:
 - 1. Conduct on each controller.
 - 2. Perform under actual or approved simulated operating conditions.
 - 3. Test for continuous 24-hour period without malfunction.
 - 4. Demonstrate performance by operating continuous period while varying application load, as input conditions allow, to verify system performance.

5. With load connected to normal utility source, measure the following to show parameters within specified limits:
 - a. Total and individual current harmonic distortion, up to and including 35th harmonic, at the input terminals of pump control panel, under following load conditions:
 - 1) AFDs running at full load and half load.
 - 2) Half of specified AFDs running at full load and half load.
 - b. Power factor at input side of each drive. Documented verification that power factor is maintained at 95 percent as speed of drive goes down from 100 percent to 33 percent.
 - c. THD at the input terminals of pump control panel under following conditions:
 - 1) AFDs running at full load and half load.
 - 2) Half of specified AFDs running at full load and half load.
 6. With load connected to standby power source, measure the following to show parameters within specified limits:
 - a. Total and individual current harmonic distortion, up to and including 35th harmonic, at the input terminals of pump control panel CP-1 with drives running at:
 - 1) Full load.
 - 2) Half load.
 - b. THD at location at the input terminals of pump control panel with drives running at:
 - 1) Full load.
 - 2) Half load.
 7. Record test data for report.
- D. Test Equipment (Manufacturer):
1. Use Dranetz, Model No. 626-PA, harmonic distortion monitor and Series 626 disturbance analyzer or equivalent instrument to document results.
 2. Provide diagnostic plug-in test card complete with instructions, multiposition selector switch, and meters or built-in diagnostic control panel or ROM-based processor for monitoring ac, dc, and digital signals to assist in troubleshooting and startup of drive.

END OF SECTION

SECTION 40 90 01
INSTRUMENTATION AND CONTROL FOR PROCESS SYSTEMS

PART 1 GENERAL

1.01 REFERENCES

A. The following is a list of standards which may be referenced in this section:

1. ASTM International (ASTM):
 - a. A182, Standard Specification for Forged or Rolled Alloy-Steel Pipe Flanges, Forged Fittings, and Valves and Parts for High-Temperature Service.
 - b. A276, Standard Specification for Stainless and Heat-Resisting Steel Bars and Shapes.
 - c. A312, Standard Specification for Seamless and Welded Austenitic Stainless Steel Pipes.
 - d. B32, Standard Specification for Solder Metal.
 - e. B88, Standard Specification for Seamless Copper Water Tube.
2. International Society of Automation (ISA):
 - a. S5.1, Instrumentation Symbols and Identification (NRC ADOPTED).
 - b. PR12.6, Installation of Intrinsically Safe Systems for Hazardous (Classified) Locations.
 - c. S5.4, Standard Instrument Loop Diagrams.
 - d. S20, Specification Forms for Process Measurement and Control Instruments, Primary Elements and Control Valves.
 - e. S50.1, Compatibility of Analog Signals for Electronic Industrial Process Instruments.
3. National Electrical Manufacturers Association (NEMA):
 - a. 250, Enclosures for Electrical Equipment (1,000 Volts Maximum).
 - b. ICS 1, General Standards for Industrial Control and Systems.
4. National Institute of Standards and Technology (NIST).
5. NSF International (NSF):
 - a. NSF/ANSI 61, Drinking Water System Components - Health Effects.
 - b. NSF/ANSI 372, Drinking Water System Components - Lead Content.
6. Underwriters Laboratory, Inc. (UL): 508A, Standard for Safety, Industrial Control Panels.

1.02 SUMMARY

A. Work Includes:

1. Engineering, furnishing, installing, calibrating, adjusting, testing, documenting, starting up, and Owner training for complete Process Instrumentation and Control (PIC) for plant.
2. Major parts are:
 - a. One freestanding control panel with programmable logic controller and panel mount human machine interface.
 - b. Modifications to existing Plant Control System human machine interface (HMI), FactoryTalk SE. Provide all necessary changes to incorporate the processes monitored and controlled by the PLC in FP-3-1. Confirm exact software version prior to programming.
 - c. Modifications to existing historian. Provide all necessary changes to incorporate the processes monitored and controlled by the PLC in FP-3-1.
 - d. Configuration of the new Ethernet switch in TJB-1.
 - e. Attend and provide documentation for a minimum of three HMI and PLC Software Design meetings with the PIC Contractor, Engineer and the Owner.
 - f. Standard Software:
 - 1) PLC: Standard software not provided as part of this Contract.
 - 2) New Panel Mount HMI at FP-3-1: Runtime license for PanelView Plus provided by the PICS Contractor.
 - 3) Existing Plant Control System HMI: FactoryTalk View SE standard software is existing.
 - 4) Existing Historian: Historian standard software is existing.
 - g. Applications Software (Programming):
 - 1) PLC: Provided by PICS Contractor.
 - 2) New Panel Mount HMI: Provided by the PICS Contractor.
 - 3) Modifications to Existing Plant Control System HMI: Provided by the PICS Contractor.
 - 4) Modifications to Existing Historian: Provided by the PICS Contractor.

1.03 DEFINITIONS

A. Abbreviations:

1. FDT: Factory Demonstration Test.
2. LCP: Local Control Panel.
3. MCC: Motor Control Center.
4. PAT: Performance Acceptance Test.
5. PIC: Process Instrumentation and Control.

6. PLC: Programmable Logic Controller.
- B. Rising/Falling: Terms used to define actions of discrete devices about their setpoints.
1. Rising: Contacts close when an increasing process variable rises through setpoint.
 2. Falling: Contacts close when a decreasing process variable falls through setpoint.
- C. Signal Types:
1. Analog Signals, Current Type:
 - a. 4 mA to 20 mA dc signals conforming to ISA S50.1.
 - b. Unless otherwise indicated for specific PIC Subsystem components, use the following ISA 50.1 options:
 - 1) Transmitter Type: Number 2, two-wire.
 - 2) Transmitter Load Resistance Capacity: Class L.
 - 3) Fully isolated transmitters and receivers.
 2. Analog Signals, Voltage Type: 1 to 5 volts dc within panels where a common high precision dropping resistor is used.
 3. Discrete signals, two-state logic signals using dc or 120V ac sources as indicated.
 4. Pulse Frequency Signals:
 - a. Direct current pulses whose repetition rate is linearly proportional to process variable.
 - b. Pulses generated by contact closures or solid state switches as indicated.
 - c. Power source less than 30V dc.
 5. Special Signals: Other types of signals used to transmit analog and digital information between field elements, transmitters, receivers, controllers, and digital devices.
- D. Standard Software: Software packages that are independent of Project on which they are used. Standard software includes system software, supervisory control, and data acquisition (SCADA) software.
1. System Software: Application independent (non-project specific) software developed by digital equipment manufacturers and software companies. Includes, but is not limited to, operating systems; network support, programming languages (C, C++, Visual C++, BASIC, Visual Basic, etc.); Office Suites (word processor, spreadsheet, database, etc.); e-mail; security (firewall, antivirus; spam, spyware, etc.) debugging aids; and diagnostics.

2. SCADA Software: Software packages independent of specific process control project on which they are used. Includes, but is not limited to, providing configuring and run-time capability for, data acquisition (I/O driver, OPC servers, etc.), monitoring, alarming, human-machine interface, supervisory control, data collection, data retrieval, trending, report generation, control, and diagnostics.
 3. Controller Programming Software: Software packages for the configuring of PLCs, RTUs, DCUs, and fieldbus devices.
- E. Application Software (Programming): Software to provide functions unique to this Project and that are not provided by standard software alone, including but not limited to:
1. Configuring databases, tables, displays, historians, reports, parameter lists, ladder logic, function block, and control strategies required to implement functions unique to this Project.
 2. Programming, including HMI and PLC, in any programming or scripting language.
- F. Instrument Tag Numbers:
1. A shorthand tag number notation is used in the Loop Specifications. For example: AI-1-2(2)(3)[pH].

Notation	Explanation
AI	ISA designator for Analysis Indicator.
1	Unit process number.
2	Loop number.
(2)	First unit number; number of same component types in a given loop; -1 and -2 in this example.
(3)	Second unit number; number of same component types with same first unit number in a given loop; -1, -2, and -3 in this example.
[pH]	Same notation shown at 2 o'clock position on ISA circle symbol on P&ID.

2. In this example, AI-1-12(2)(3)[pH] is shorthand for:

AI-1-12-1-1[pH], AI-1-12-1-2[pH], AI-1-12-1-3[pH]
 AI-1-12-2-1[pH], AI-1-12-2-2[pH], AI-1-12-2-3[pH]

1.04 SUBMITTALS

A. Action Submittals:

1. General:
 - a. Shop Drawings, full-scaled details, wiring diagrams, catalog cuts, and descriptive literature.
 - b. Identify proposed items and options. Identify installed spares and other provisions for future work (for example, reserved panel space; unused components, wiring, and terminals).
 - c. Legends and Abbreviation Lists: Complete definition of symbols and abbreviations used on this Project (for example, engineering units, flow streams, instruments, structures, and other process items used in nameplates, legends, and data sheets).
 - d. Submittal Format:
 - 1) Hard Copy: Required for all submittals.
 - 2) Electronic Copies: Required, unless otherwise noted for specific items.
 - a) Manufacturers' Standard Documents: Adobe Acrobat PDF.
 - b) Documents created specifically for Project:
 - (1) Text and Graphics: Microsoft Word.
 - (2) Lists: Microsoft Excel, unless otherwise noted for specific items.
 - (3) Drawings: MicroStation or AutoCAD.
2. Bill of Materials: List of required equipment.
 - a. Group equipment items as follows:
 - 1) I&C Components: By component identification code.
 - 2) Other Equipment: By equipment type.
 - b. Data Included:
 - 1) Equipment tag number.
 - 2) Description.
 - 3) Manufacturer, complete model number, and all options not defined by model number.
 - 4) Quantity supplied.
 - 5) Component identification code where applicable.
3. Catalog Cuts: I&C Components, Electrical Devices, and Mechanical Devices:
 - a. Catalog information, mark to identify proposed items and options.
 - b. Descriptive literature.
 - c. External power and signal connections.
 - d. Scaled drawings showing exterior dimensions and locations of electrical and mechanical interfaces.
4. Component Data Sheets: Data sheets for I&C components.
 - a. Format and Level of Detail: In accordance with ISA-S20.

- b. Include component type identification code and tag number on data sheet.
 - c. Specific features and configuration data for each component:
 - 1) Location or service.
 - 2) Manufacturer and complete model number.
 - 3) Size and scale range.
 - 4) Setpoints.
 - 5) Materials of construction.
 - 6) Options included.
 - d. Name, address, and telephone number of manufacturer's local office, representative, distributor, or service facility.
5. Sizing and Selection Calculations:
- a. Primary Elements: Complete calculations plus process data used. Example, for flow elements, minimum and maximum values, permanent head loss, and assumptions made.
 - b. Controlling, Computing and Function Generating Modules: Actual scaling factors with units and how they were computed.
6. Panel Construction Drawings:
- a. Scale Drawings: Show dimensions and location of panel mounted devices, doors, louvers, and subpanels, internal and external.
 - b. Panel Legend: List front of panel devices by tag numbers, nameplate inscriptions, service legends, and annunciator inscriptions.
 - c. Bill of Materials: List devices mounted within panel that are not listed in panel legend. Include tag number, description, manufacturer, and model number.
 - d. Construction Details: NEMA rating, materials, material thickness, structural stiffeners and brackets, lifting lugs, mounting brackets and tabs, door hinges and latches, and welding and other connection callouts and details.
 - e. Construction Notes: Finishes, wire color schemes, wire ratings, wire and terminal block, numbering and labeling scheme.
7. Panel Control Diagrams: For discrete control and power circuits.
- a. Diagram Type: Ladder diagrams include devices, related to discrete functions that are mounted in or on the panel and that require electrical connections. Show unique rung numbers on left side of each rung.
 - b. Item Identification: Identify each item with attributes listed.
 - 1) Wires: Wire number and color. Cable number if part of multiconductor cable.
 - 2) Terminals: Location (enclosure number, terminal junction box number, or MCC number), terminal strip number, and terminal block number.
 - 3) Discrete Components:
 - a) Tag number, terminal numbers, and location ("FIELD", enclosure number, or MCC number).

- b) Switching action (open or close on rising or falling process variable), setpoint value and units, and process variable description (for example, Sump Level High).
 - 4) Relay Coils:
 - a) Tag number and its function.
 - b) On right side of run where coil is located, list contact location by ladder number and sheet number. Underline normally closed contacts.
 - 5) Relay Contacts: Coil tag number, function, and coil location (ladder rung number and sheet number).
- c. Show each circuit individually. No “typical” diagrams or “typical” wire lists will be permitted.
- d. Ground wires, surge protectors, and connections.
- e. Circuit Names: Show names corresponding to Circuit and Raceway Schedule for circuits entering and leaving a panel. Refer to Division 26, Electrical.
- 8. Panel Wiring Diagrams: Show point-to-point and terminal-to-terminal wiring within panel.
- 9. Loop Diagrams: Individual wiring diagram for each analog or pulse frequency loop.
 - a. Conform to the minimum requirements of ISA S5.4.
 - b. Under Paragraph 5.3 of ISA S5.4, include the information listed under subparagraphs 2 and 6.
 - c. Drawing Size: Individual 11-inch by 17-inch sheet for each loop.
 - d. Divide each loop diagram into areas for panel face, back-of-panel, and field.
 - e. Show:
 - 1) Terminal numbers, location of dc power supply, and location of common dropping resistors.
 - 2) Switching contacts in analog loops and output contacts of analog devices. Reference specific control diagrams where functions of these contacts are shown.
 - 3) Tabular summary on each diagram:
 - a) Transmitting Instruments: Output capability.
 - b) Receiving Instruments: Input impedance.
 - c) Loop Wiring Impedance: Estimate based on wire sizes and lengths shown.
 - d) Total loop impedance.
 - e) Reserve output capacity.
 - 4) Circuit and raceway schedule names.
- 10. Interconnecting Wiring Diagrams:
 - a. Diagrams, device designations, and symbols in accordance with NEMA ICS 1.
 - b. Diagrams shall bear electrical Subcontractor’s signature attesting diagrams have been coordinated with Division 26, Electrical.

- c. Show:
 - 1) Electrical connections between equipment, consoles, panels, terminal junction boxes, and field mounted components.
 - 2) Component and panel terminal board identification numbers, and external wire and cable numbers.
 - 3) Circuit names matching Circuit and Raceway Schedule.
 - 4) Intermediate terminations between field elements and panels (for example, to terminal junction boxes and pull boxes).
 - 5) Pull boxes.
- 11. Panel Power Requirements and Heat Dissipation: For control panels tabulate and summarize:
 - a. Required voltages, currents, and phases(s). Include calculations and list assumptions.
 - 1) Include calculations and sizing for 24V dc power supplies.
 - 2) Include calculations and sizing for uninterruptible power supply.
 - b. Maximum heat dissipations Btu per hour. Include calculations and list assumptions.
 - c. Maximum permissible internal temperature based on operating range of internal components.
 - d. Computed maximum internal temperature. Include calculations and list assumptions. Include the impacts of internal heat generation, solar radiation and shielding.
 - e. Use the ambient parameters listed in this section for the applicable service condition.
- 12. Installation Details: Include modifications or further details required to adequately define installation of I&C components.
- 13. List of spares, expendables, test equipment and tools.
- 14. Applications Software (Programming) Submittals:
 - a. Includes draft and final submittals.
 - b. Draft Submittal: Submit prior to the first HMI and PLC Software Design meeting.
 - c. Final Submittal: Submit after the second HMI and PLC Software Design meeting.
 - d. Content:
 - 1) Control narrative detailing all control functions including all software functions, software switches, alarms, failures, resets, etc.
 - 2) Draft graphics including, but not limited to, draft overview screens, draft motor faceplates, draft control faceplates, draft analog faceplate, alarm summary, and trend screen. Also include the proposed objects (pumps, analog displays, etc) and planned color schemes (including On/Off colors, alarm colors, etc).

15. Applications Software (Programming) Documentation:
 - a. PLC documentation in electronic (i.e viewable in programming software package) and hard copy PDF format.
 - b. Backup of HMI application submitted in native HMI software (i.e. backup of development application as well as runtime application).
 - c. For each device, include program listings and function block diagrams, as appropriate, showing:
 - 1) Functional blocks or modules used.
 - 2) Configuration, calibration, and tuning parameters.
 - 3) Descriptive annotations.
 16. Additional Equipment Recommended: List of, and descriptive literature for, additional spares, expendables, test equipment and tools recommended. Include unit prices and total costs as specified in Section 01 29 00, Payment Procedures.
- B. Informational Submittals: For PIC equipment, provide Manufacturer's Certificate of Proper Installation and readiness for operation.
1. Owner Training Plan. Reference Section 01 43 33, Manufacturers' Field Services.
 2. Operation and Maintenance (O&M) Manuals: In accordance with Section 01 78 23, Operation and Maintenance Data, unless otherwise specified in this section.
 - a. Content and Format:
 - 1) Complete sets O&M manuals.
 - 2) Sufficient detail to allow operation, removal, installation, adjustment, calibration, maintenance and purchasing replacements for each PIC component.
 - 3) Final versions of Legend and Abbreviation Lists.
 - 4) Manual format in accordance with Section 01 78 23, Operation and Maintenance Data.
 - b. Include:
 - 1) Process and Instrumentation Diagrams: One reproducible copy of revised P&ID to reflect as-built PIC design.
 - 2) Refer to paragraph Shop Drawings for the following items:
 - a) Bill of Materials.
 - b) Catalog Cuts.
 - c) Component Data Sheets.
 - d) Panel Control Diagrams.
 - e) Panel Wiring Diagrams, one reproducible copy.
 - f) Panel Plumbing Diagrams, one reproducible copy.
 - g) Loop Diagrams, one reproducible copy.
 - h) Interconnecting Wiring Diagrams, one reproducible copy.
 - i) Application Software Documentation.

- 3) Device O&M manuals for components, electrical devices, and mechanical devices include:
 - a) Operations procedures.
 - b) Installation requirements and procedures.
 - c) Maintenance requirements and procedures.
 - d) Troubleshooting procedures.
 - e) Calibration procedures.
 - f) Internal schematic and wiring diagrams.
 - g) Component Calibration Sheets from field quality control calibrations.
 - 4) List of spares, expendables, test equipment and tools provided.
 - 5) List of additional spares, expendables, test equipment and tools recommended.
3. Testing Related Submittals:
- a. Factory Demonstration Test:
 - 1) Preliminary Test Procedures: Outline of proposed tests, forms, and checklists.
 - 2) Final Test Procedures:
 - a) Proposed test procedures, forms, and checklists.
 - b) Capacity, Timing, and Simulation: Describe simulation and monitoring methods used to demonstrate compliance with capacity and timing requirements.
 - 3) Test Documentation: Copy of signed off test results.
 - b. Functional Test:
 - 1) Preliminary Test Procedures: Outline of proposed tests, forms, and checklists.
 - 2) Final Test Procedures: Proposed test procedures, forms, and checklists.
 - 3) Test Documentation:
 - a) Copy of signed-off test results.
 - b) Completed component calibration sheets.
 - 4) Performance Test:
 - a) Preliminary Test Procedures: Outline of proposed tests, forms, and checklists.
 - b) Final Test Procedures: Proposed test procedures, forms, and checklists.
 - c) Test Documentation: Copy of signed-off test results.

1.05 QUALITY ASSURANCE

- A. Calibration Instruments: Each instrument used for calibrating PIC equipment shall bear the seal of a reputable laboratory certifying that instrument has been calibrated within the previous 12 months to a standard endorsed by the NIST.

B. Coordination Meetings:

1. In accordance with Division 1, General Requirements.
2. Location: Owner's Facility.
3. Attended By: Engineer, Owner, and Contractor.
4. Minimum of two are required. Specific dates will be established in Progress Schedule.
5. First Meeting: Within 36 days after Notice to Proceed.

C. HMI and PLC Software Design Meetings:

1. In accordance with Division 1, General Requirements.
2. Location: Owner's Facility.
3. Attended By: Engineer, Owner, and Contractor.
4. Minimum of three are required. Specific dates will be established in Progress Schedule.
5. Purpose Meeting 1: To discuss Applications Software (Programming).
6. The Applications Software (programming) Draft Submittal shall be submitted after the first meeting.
7. Purpose Meeting 2: Applications Software (programming) Draft Submittal.
8. The Applications Software (programming) Final Submittal shall be submitted after the second meeting.
9. Purpose Meeting 3: Applications Software (programming) Final Submittal.

1.06 DELIVERY, STORAGE, AND HANDLING

- A. Provide Site and warehouse storage facilities for PIC equipment.
- B. Prior to shipment, include corrosive-inhibitive vapor capsules in shipping containers, and related equipment as recommended by the capsule manufacturer.
- C. Prior to installation, store items in dry indoor locations. Provide heating in storage areas for items subject to corrosion under damp conditions.
- D. Cover panels and other elements that are exposed to dusty construction environments.

1.07 ENVIRONMENTAL REQUIREMENTS

- A. Standard Environmental Requirements: Unless otherwise noted, design equipment for continuous operation in these environments:
 1. Freestanding Panel and Consoles:
 - a. Inside, Air Conditioned: NEMA 12.

- b. Inside: NEMA 12.
 - c. Outside (Non-hazardous): NEMA 4X.
 - 2. Smaller Panels and Assemblies (that are not Freestanding):
 - a. Inside, Air Conditioned: NEMA 12.
 - b. All Other Locations (Non-hazardous): NEMA 4X.
 - 3. Field Elements: Outside.

- B. Environmental Design Requirements: Following defines the types of environments referred to in the above.
 - 1. Inside, Air Conditioned:
 - a. Temperature:
 - 1) Normal: 60 to 80 degrees F.
 - 2) With Up to 4-Hour HVAC System Interruptions: 40 to 105 degrees F.
 - b. Relative Humidity:
 - 1) Normal: 10 percent (winter) to 70 percent (summer).
 - 2) With Up to 4-Hour HVAC System Interruption: 10 to 100 percent.
 - c. NEC Classification: Nonhazardous.
 - 2. Inside:
 - a. Temperature: 20 to 104 degrees F.
 - b. Relative Humidity: 10 to 100 percent.
 - c. NEC Classification: Nonhazardous.
 - 3. Inside, Corrosive:
 - a. Temperature: 20 to 104 degrees F.
 - b. Relative Humidity: 10 to 100 percent.
 - c. Corrosive Environment: Hydrogen sulfide gas.
 - d. NEC Classification: Nonhazardous.
 - 4. Outside:
 - a. Temperature: 50 to 104 degrees F.
 - b. Relative Humidity: 10 to 95 percent noncondensing, rain.
 - c. NEC Classification: As shown on Electrical Drawings.
 - 5. Outside, Corrosive:
 - a. Temperature: 50 to 104 degrees F.
 - b. Relative Humidity: 10 to 95 percent noncondensing, rain.
 - c. Corrosive Environment: Sea air.
 - d. NEC Classification: As shown on Electrical Drawings.

1.08 SEQUENCING AND SCHEDULING

- A. Activity Completion: The following is a list of key activities and their completion criteria:
 - 1. Shop Drawing Reviews by Engineer: Reviewed and approved.
 - 2. SCADA Applications Software Development Prerequisite: HMI and PLC Standards meetings with the Owner.

3. Factory Demonstration Test Prerequisite:
 - a. Associated test procedures Submittals completed.
 - b. HMI and PLC Software Design Meeting completed.
 - c. Shop Drawings Approved.
4. Training Prerequisite: Associated training plan Submittal completed.
5. PLC and HMI Configuration Training Session 1 Prerequisite:
 - a. PLC and HMI software Shop Drawings approved.
 - b. FDT completed.
6. Control Panel Shipped to Site:
 - a. General Prerequisites:
 - 1) Approval of PIC Shop Drawings and preliminary operation and maintenance data.
 - 2) FDT completed.
7. PLC and HMI Applications Software Installation Prerequisite:
 - a. PLC and HMI software Shop Drawings approved.
 - b. FDT Completed.
8. Performance Test Prerequisite:
 - a. Factory Test completed.
 - b. Control panel shipped to and installed at Site.
 - c. PLC and HMI applications software installation complete.
 - d. Facility started up.

PART 2 PRODUCTS

2.01 GENERAL

- A. PIC functions as shown on Drawings and as required for each loop. Furnish equipment items as required. Furnish all materials, equipment, and software, necessary to effect required system and loop performance.
- B. First Named Manufacturer: PIC design is based on first named manufacturers of equipment and materials.
 1. If an item is proposed from other than first named manufacturer, obtain approval from Engineer for such changes in accordance with Article Submittals.
 2. If using proposed item requires other changes, provide work and equipment to implement these changes. Changes that may be required include, but are not limited to: different installation, wiring, raceway, enclosures, connections, isolators, intrinsically safe barriers, software, and accessories.
- C. Like Equipment Items:
 1. Use products of one manufacturer and of the same series or family of models to achieve standardization for appearance, operation, maintenance, spare parts, and manufacturer's services.

2. Implement all same or similar functions in same or similar manner. For example, control logic, sequence controls, and display layouts.

2.02 LOOP SPECIFICATIONS

- A. Location: Article Supplements.
- B. Organization: By loop process.
- C. Functional Requirements for Control Loops:
 1. Shown on Drawings, in Panel Control Diagrams, and Process and Instrumentation Diagrams (P&ID). P&ID format and symbols are in accordance with ISA S5.1, except as specified or shown on Drawings.
 2. Supplemented by Loop Specifications.

2.03 PROGRAMMABLE LOGIC CONTROLLERS, FIELD BUS, AND NETWORK, COMPONENTS

- A. Reference PLC and Network Components List in Article Supplements.
- B. Cables: Provide all cables for interconnecting PLC components both inside and individual panels and between panels or remote devices.

2.04 PLC I/O

- A. Physical I/O points are shown on P&IDs. Physical I/O points are included in the Input/Output List which is listed in the PLC Input/Output List referenced in Article Supplements.
- B. Spare I/O: Wire all spare I/O to terminal blocks and surge suppressors so that it is ready for field termination.
- C. Separate Output Modules for Parallel Controlled Modules: Unless otherwise noted or shown, provide separate discrete and analog modules for parallel controlled equipment. For instance if there are a total of three pumps in a pump station, separate the pump I/O across two modules. Wire two pumps to one module and the third to a second module.
- D. Interposing Relays:
 1. Provide an interposing relay in the circuit for each Discrete Output (DO). Provide relays with the following features:
 - a. Coil Voltage: 120V ac.
 - b. Contact Rating: 10A at 28V dc or 120V ac.
 2. Installed Spare Interposing Relays: Provide spare interposing relays for the spare DO points.

2.05 NAMEPLATES AND TAGS

- A. Panel Nameplates: Enclosure identification located on the enclosure face.
 - 1. Location and Inscription: As shown.
 - 2. Materials: Laminated plastic attached to panel with stainless steel screws.
 - 3. Letters: 1/2-inch white on black background, unless otherwise noted.
- B. Component Nameplates—Panel Face: Component identification located on panel face under or near component.
 - 1. Location and Inscription: As shown.
 - 2. Materials: Laminated plastic attached to panel with stainless steel screws.
 - 3. Letters: 3/16-inch white on black background, unless otherwise noted.
- C. Component Nameplates—Back of Panel: Component identification located on or near component inside of enclosure.
 - 1. Inscription: Component tag number.
 - 2. Materials: Adhesive backed, laminated plastic.
 - 3. Letters: 3/16-inch white on black background, unless otherwise noted.
- D. Legend Plates for Panel Mounted Pushbuttons, Lights, and Switches.
 - 1. Inscription: Refer to:
 - a. Table under paragraph Standard Pushbutton Colors and Inscriptions.
 - b. Table under paragraph Standard Light Colors and Inscriptions.
 - c. P&IDs in Drawings.
 - 2. Materials: Stainless steel, keyed legend plates. Secured to panel by mounting nut for pushbutton, light, or switch.
 - 3. Letters: Black on gray or white background.
- E. Service Legends: Component identification nameplate located on face of component.
 - 1. Inscription: As shown.
 - 2. Materials: Adhesive backed, laminated plastic.
 - 3. Letters: 3/16-inch white on black background, unless otherwise noted.
- F. Nametags: Component identification for field devices.
 - 1. Inscription: Component tag number.
 - 2. Materials: 16-gauge, Type 304 stainless steel.
 - 3. Letters: 3/16-inch imposed.

4. Mounting: Affix to component with 16- or 18-gauge stainless steel wire or stainless steel screws.

2.06 MODIFICATIONS TO EXISTING SYSTEMS

- A. Existing Plant Control System HMI is FactoryTalk View SE.
 1. Confirm version with the Owner prior to beginning Applications Software (programming).
 2. Applications software (programming) shall not be started until all HMI and PLC Software Design meetings have been completed and the Applications Software draft and final submittals have been reviewed and approved by the Engineer.
 3. Perform modifications to the existing Plant Control System HMI to incorporate all monitoring and control of the processes monitored and controlled by the PLC in FP-3-1. Modifications shall be consistent with the existing system.
- B. Existing Plant Control System Historian is FactoryTalk Historian SE.
 1. Perform modifications to the existing historian to log data as required in the Loop Specifications in Article Supplements.

2.07 CONFIGURATION OF NETWORK EQUIPMENT

- A. Provide complete configuration and testing of the new Allen Bradley Stratix Ethernet switch. Configuration shall be similar to the configuration of the existing switch in TJB-2.
 1. Obtain the configuration of existing switch in TJB-2.
 2. Configure the new Allen Bradley Stratix Ethernet switch, excluding settings that are specific to that switch such as IP address, similar to the existing switch in TJB-2.
 3. Coordinate IP addresses of all equipment with the Owner.

2.08 ELECTRICAL REQUIREMENTS

- A. In accordance with Division 26, Electrical.
- B. I&C and electrical components, terminals, wires, and enclosures: UL recognized or UL listed.
- C. Wires within Enclosures:
 1. ac Circuits:
 - a. Type: 300-volt, Type MTW stranded copper.
 - b. Size: For current to be carried, but not less than 18 AWG.

2. Analog Signal Circuits:
 - a. Type: 300-volt stranded copper, twisted shielded pairs.
 - b. Size: 18 AWG, minimum.
 3. Other dc Circuits.
 - a. Type: 300-volt, Type MTW stranded copper.
 - b. Size: For current carried, but not less than 18 AWG.
 4. Special Signal Circuits: Use manufacturer's standard cables.
 5. Wire Identification: Numbered and tagged at each termination.
 - a. Wire Tags: Machine printed, heat shrink.
 - b. Manufacturers:
 - 1) Brady PermaSleeve.
 - 2) Tyco Electronics.
- D. Wires entering or leaving enclosures, terminate and identify as follows:
1. Analog and discrete signal, terminate at numbered terminal blocks.
 2. Special signals, terminated using manufacturer's standard connectors.
- E. Terminal Blocks for Enclosures:
1. Quantity:
 - a. Accommodate present and spare indicated needs.
 - b. Wire spare PLC I/O points to terminal blocks.
 - c. One wire per terminal for field wires entering enclosures.
 - d. Maximum of two wires per terminal for 18-WG wire for internal enclosure wiring.
 - e. Spare Terminals: 20 percent of all connected terminals, but not less than 10 per terminal block.
 2. General:
 - a. Connection Type: Screw compression clamp.
 - b. Compression Clamp:
 - 1) Complies with DIN-VDE 0611.
 - 2) Hardened steel clamp with transversal groves that penetrate wire strands providing a vibration-proof connection.
 - 3) Guides strands of wire into terminal.
 - c. Screws: Hardened steel, captive and self-locking.
 - d. Current Bar: Copper or treated brass.
 - e. Insulation:
 - 1) Thermoplastic rated for minus 55 to plus 110 degree C.
 - 2) Two funneled shaped inputs to facilitate wire entry.
 - f. Mounting:
 - 1) Standard DIN rail.
 - 2) Terminal block can be extracted from an assembly without displacing adjacent blocks.
 - 3) End Stops: Minimum of one at each end of rail.

- g. Wire preparation: Stripping only permitted.
 - h. Jumpers: Allow jumper installation without loss of space on terminal or rail.
 - i. Marking System:
 - 1) Terminal number shown on both sides of terminal block
 - 2) Allow use of preprinted and field marked tags.
 - 3) Terminal strip numbers shown on end stops.
 - 4) Mark terminal block and terminal strip numbers as shown on Panel Control Diagrams and Loop Diagrams.
 - 5) Fuse Marking for Fused Terminal Blocks: Fuse voltage and amperage rating shown on top of terminal block.
 - j. Test Plugs: Soldered connections for 18 AWG wire.
 - 1) Pin Diameter: 0.079 inch.
 - 2) Manufacturer and Product:
 - a) Entrelec; Type FC2.
 - b) Weidmuller.
 - c) Allen-Bradley.
3. Terminal Block, General-Purpose:
 - a. Rated Voltage: 600V ac.
 - b. Rated Current: 30 amp.
 - c. Wire Size: 22 AWG to 10 AWG.
 - d. Rated Wire Size: 10 AWG.
 - e. Color: Grey body.
 - f. Spacing: 0.25 inch, maximum.
 - g. Test Sockets: One screw test socket 0.079-inch diameter.
 - h. Manufacturers and Products:
 - 1) Weidmuller; 1020100000 with 0280600000.
 - 2) Entrelec; Type M4/6.T.
 - 3) Phoenix Contact.
 4. Terminal Block, Ground:
 - a. Wire Size: 22 AWG to 12 AWG.
 - b. Rated Wire Size: 12 AWG.
 - c. Color: Green and yellow body.
 - d. Spacing: 0.25 inch, maximum.
 - e. Grounding: Ground terminal blocks electrically grounded to the mounting rail.
 - f. Manufacturers and Products:
 - 1) Weidmuller; 1010100000.
 - 2) Entrelec; Type M4/6.P.
 - 3) Phoenix Contact.
 5. Terminal Block, Blade Disconnect Switch:
 - a. Rated Voltage: 600V ac.
 - b. Rated Current: 10-amp.
 - c. Wire Size: 22 AWG to 12 AWG.
 - d. Rated Wire Size: 12 AWG.

- e. Color: Grey body, orange switch.
- f. Spacing: 0.25 inch, maximum.
- g. Manufacturers and Products:
 - 1) Weidmuller; 7910210000.
 - 2) Entrelec; Type M4/6.SN.T.
 - 3) Phoenix Contact.
- 6. Terminal Block, Diode:
 - a. Rated Voltage: 24V dc.
 - b. Rated Current: 30 ma.
 - c. Wire Size: 16 AWG.
 - d. Manufacturers and Products:
 - 1) Weidmuller.
 - 2) Phoenix Contact ST-IN.
- 7. Terminal Block, Fused, 24V dc:
 - a. Rated Voltage: 600V dc.
 - b. Rated Current: 16-amp.
 - c. Wire Size: 22 AWG to 10 AWG.
 - d. Rated Wire Size: 10 AWG.
 - e. Color: Grey body.
 - f. Fuse: 0.25 inch by 1.25 inches.
 - g. Indication: LED diode 24V dc.
 - h. Spacing: 0.512 inch, maximum.
 - i. Manufacturers and Products:
 - 1) Weidmuller 1880410000.
 - 2) Entrelec; Type M10/13T.SFL.
 - 3) Phoenix Contact.
- 8. Terminal Block, Fused, 120V ac:
 - a. Rated Voltage: 600V ac.
 - b. Rated Current: 25 amps.
 - c. Wire Size: 22 AWG to 10 AWG.
 - d. Rated Wire Size: 10 AWG.
 - e. Color: Gray body.
 - f. Fuse: 0.25 inch by 1.25 inches.
 - g. Indication: Neon lamp, 110V ac.
 - h. Leakage Current: 1.8 mA, maximum.
 - i. Spacing: 0.512 inch, maximum.
 - j. Manufacturer and Product:
 - 1) Entrelec; Type ML10/13.SFL.
 - 2) Weidmuller 1880420000.
 - 3) Phoenix Contact.
- 9. Terminal Block, Fused, 120V ac, High Current:
 - a. Rated Voltage: 600V ac.
 - b. Rated Current: 35 amps.
 - c. Wire Size: 18 AWG to 8 AWG.
 - d. Rated Wire Size: 8 AWG.
 - e. Color: Gray.

- f. Fuse: 13/32 inch by 1.5 inches.
- g. Spacing: 0.95 inch, maximum.
- h. Manufacturer and Product:
 - 1) Entrelec; Type MB10/24.SF.
 - 2) Weidmuller; 7940029428.
 - 3) Phoenix Contact.

F. Grounding of Enclosures:

- 1. Furnish isolated copper grounding bus for signal and shield ground connections.
- 2. Ground bus grounded at a common signal ground point in accordance with National Electrical Code requirements.
- 3. Single Point Ground for Each Analog Loop:
 - a. Locate at dc power supply for loop.
 - b. Use to ground wire shields for loop.
 - c. Group and connect shields in following locations:
 - 1) Locate signal ground at dc power supply for loop.
 - 2) Use to ground wire shields for loop.
- 4. Ground terminal block rails to ground bus.

G. Analog Signal Isolators:

- 1. General:
 - a. Function: Furnish signal isolation for analog signals that are sent from one enclosure to another. Do not wire in series instruments on different panels, cabinets, or enclosures.
 - b. Type:
 - 1) Solid state with external power supply.
 - 2) Three-way isolation of the input signal, output signal, and external power supply.
- 2. Performance:
 - a. Isolation:
 - 1) Three-way isolation between input, output, and power circuits for common mode voltages up to 250V ac, or 354V dc of ground, on a continuous basis.
 - 2) Able to withstand 1,500V ac dielectric strength test for 60 seconds without breakdown.
 - b. Output Ripple: Less than plus or minus 0.1 percent of maximum output span.
 - c. Accuracy: Plus or minus 0.1 percent of output span.
 - d. Ambient Temperature, Operating: Minus 13 degrees F to plus 149 degrees F.
- 3. Features:
 - a. Zero and span trim adjustments using 15-turn potentiometers.
 - b. Calibration independent of load.

- c. Compact dimensions with width less than or equal to 6.2 mm.
- d. Power supply possible through foot element.
- 4. Signal Interface:
 - a. Input:
 - 1) 4 mA to 20 mA dc.
 - 2) Impedance: 50 ohms.
 - b. Output:
 - 1) 4 mA to 20 mA dc.
 - 2) Drives output load impedance up to 500 ohms independent of supply voltage to isolator.
- 5. Enclosure:
 - a. NEMA 1, unless otherwise noted.
 - b. Mounting: DIN Rail, unless otherwise noted.
- 6. Power: 24 V dc.
- 7. Manufacturer:
 - a. Phoenix Contact MINI MCR.
 - b. Weidmuller.
 - c. Or approved equal.

H. Power Distribution within Panels:

- 1. Feeder Circuits:
 - a. One or more 120V ac, 60-Hz feeder circuits as shown on Drawings.
 - b. Make provisions for feeder circuit conduit entry.
 - c. Furnish terminal board for termination of wires.
- 2. Power Panel: Furnish main circuit breaker and a circuit breaker on each individual branch circuit distributed from power panel.
 - a. Locate to provide clear view of and access to breakers when door is open.
 - 1) Breaker Sizes: Coordinate such that fault in branch circuit will blow only branch breaker, but not trip main breaker.
 - a) Branch Circuit Breakers: 15 amps at 250V ac.
 - 2) Provide UL 489 listed breakers.
 - 3) Breaker Manufacturers and Products:
 - a) Square D; Multi 9 Series.
 - b) Allen-Bradley; 1489-A Series.
 - c) Or approved equal.
- 3. Circuit Wiring: P&IDs and Control Diagrams on Drawings show function only. Use following rules for actual circuit wiring:
 - a. Devices on Single Circuit: 20, maximum.
 - b. Multiple Units Performing Parallel Operations: To prevent failure of any single branch circuit from shutting down entire operation, do not group all units on same branch circuit.
 - c. Branch Circuit Loading: 12 amperes continuous, maximum.

- d. Panel Lighting and Service Outlets: Put on separate 15-amp, 120V ac branch circuit.
- e. Provide 120V ac plugmold for panel components with line cords.

I. Signal Distribution:

- 1. Within Panels: 4 mA to 20 mA dc signals may be distributed as 1 to 5V dc.
- 2. Outside Panels: Isolated 4 mA to 20 mA dc only.
- 3. All signal wiring twisted in shielded pairs.

J. Signal Switching:

- 1. Use dry circuit type relays or switches.
- 2. No interruption of 4 mA to 20 mA loops during switching.
- 3. Switching Transients in Associated Signal Circuit:
 - a. 4 mA to 20 mA dc Signals: 0.2 mA, maximum.
 - b. 1 to 5V dc Signals: 0.05V, maximum.

K. Relays:

- 1. General:
 - a. Relay Mounting: Plug-in type socket.
 - b. Relay Enclosure: Furnish dust cover.
 - c. Socket Type: Screw terminal interface with wiring.
 - d. Socket Mounting: Rail.
 - e. Provide holddown clips.
 - f. Temperature Rating: Minus 10 to 140 degrees F.
- 2. Signal Switching Relay:
 - a. Type: Dry circuit.
 - b. Contact Arrangement: 2 Form C contacts.
 - c. Contact Rating: 5 amps at 28V dc or 120V ac.
 - d. Contact Material: Gold or silver.
 - e. Coil Voltage: As noted or shown.
 - f. Coil Power: 0.9 watt (dc), 1.2VA (ac).
 - g. Expected Mechanical Life: 10,000,000 operations.
 - h. Expected Electrical Life at Rated Load: 100,000 operations.
 - i. Indication Type: Neon or LED indicator lamp.
 - j. Seal Type: Hermetically sealed case.
 - k. Manufacturer and Product:
 - 1) Weidmuller; Series RCM.
 - 2) Idec.
 - 3) Allen-Bradley.
- 3. Control Circuit Switching Relay, Nonlatching:
 - a. Type: Compact general purpose plug-in.
 - b. Contact Arrangement: 3 Form C contacts.
 - c. Contact Rating: 10A at 28V dc or 120V ac, and 6.6A at 240V ac.

- d. Contact Material: Silver cadmium oxide alloy.
 - e. Coil Voltage: As noted or shown.
 - f. Coil Power: 1.8 watts (dc), 2.7VA (ac).
 - g. Expected Mechanical Life: 10,000,000 operations.
 - h. Expected Electrical Life at Rated Load: 100,000 operations.
 - i. Indication Type: Neon or LED indicator lamp.
 - j. Push-to-test button.
 - k. Manufacturer and Product:
 - 1) Weidmuller; Riderseries II.
 - 2) Idec.
 - 3) Allen-Bradley.
4. Control Circuit Switching Relay, Latching:
- a. Type: Dual coil magnetic latching relay.
 - b. Contact Arrangement: 2 Form C contacts.
 - c. Contact Rating: 10A at 28V dc or 120V ac.
 - d. Contact Material: Silver cadmium oxide alloy.
 - e. Coil Voltage: As noted or shown.
 - f. Coil Power: 2.7 watts (dc), 5.3VA (ac).
 - g. Expected Mechanical Life: 5,000,000 operations.
 - h. Expected Electrical Life at Rated Load: 500,000 operations.
 - i. Manufacturer and Product:
 - 1) Allen-Bradley.
 - 2) Potter and Brumfield; Series KUL.
 - 3) IDEC; Series RR2KP.
5. Control Circuit Switching Relay, Time Delay:
- a. Type: Adjustable time delay relay.
 - b. Contact Arrangement: 2 Form C contacts.
 - c. Contact Rating: 10A at 30V dc or 277V ac.
 - d. Contact Material: Silver cadmium oxide alloy.
 - e. Coil Voltage: As noted or shown.
 - f. Operating Temperature: Minus 10 degrees C to 55 degrees C.
 - g. Repeatability: Plus or minus 2 percent.
 - h. Delay Time Range: Select range such that time delay set point fall between 20 percent to 80 percent of range.
 - i. Time Delay Set Point: As noted or shown.
 - j. Mode of Operation: As noted or shown.
 - k. Adjustment Type: Integral potentiometer with knob external to dust cover.
 - l. Manufacturer and Products:
 - 1) Weidmuller; 8647700000.
 - 2) Idec.
 - 3) Tyco/Agastat.

L. Power Supplies:

1. Furnish as required to power instruments requiring external dc power, including two-wire transmitters and dc relays. Provide dual power supplies with diode auctioneered outputs.
2. Connect in redundant 2N or N+1 configuration, where N is the number of power supplies required.
3. Convert 120V ac, 60-Hz power to dc power of appropriate voltage(s) with sufficient voltage regulation and ripple control to assure that instruments being supplied can operate within their required tolerances.
4. Provide output over voltage and over current protective devices to:
 - a. Protect instruments from damage due to power supply failure.
 - b. Protect power supply from damage due to external failure.
5. Enclosures: NEMA 1/IP20.
6. UL 508 Listed.
7. Mount such that dissipated heat does not adversely affect other components.
8. Fuses:
 - a. Purpose:
 - 1) For each dc supply line to each individual two-wire transmitter.
 - 2) For each dc branch circuit.
 - b. Type: Indicating.
 - c. Mount so fuses can be easily seen and replaced.
9. Provide same manufacturer for Power Supply and 24V dc UPS systems.
10. Manufacturers:
 - a. Phoenix Contact; Quint SFB with Redundancy Diode Module.
 - b. PULS; Dimension Series with Redundancy Diode Module.
 - c. Sola; SDN-C series with Redundancy Module.
 - d. Or approved equal.

M. Internal Panel Lights for Freestanding Panels:

1. Type: Switched LED lighting package.
2. Quantity: One light for every 4 feet of panel width.
3. Life Expectancy: Minimum 60,000 hours at 68 degrees F.
4. Mounting: Inside and in the top of back-of-panel area.
5. Manufacturer and Product: Hoffman PaneLite series, or equal.

N. Service Outlets for Freestanding Panels:

1. Type: Three-wire, 120-volt; 15-ampere, ampere, GFCI duplex receptacles. Provide non-GFCI receptacles for panels fed from GFI breakers.

2. Quantity:
 - a. Panels 4 Feet Wide and Smaller: One.
 - b. Panels Larger than 4 Feet Wide: One for every 4 feet of panel width, two minimum per panel.
 3. Mounting: DIN Rail mounted evenly spaced along back of panel area.
- O. Internal Panel Lights and Service Outlets for Smaller Panels:
1. Internal Panel Light: Switched LED lighting package.
 2. Service Outlet: Breaker protected 120-volt, 15-amp, GFCI duplex receptacle. Provide non-GFCI receptacles for panels fed from GFI breakers.
 3. Manufacturer and Product: Hoffman PaneLite series, or equal.
- P. Standard Pushbutton Colors and Inscriptions: Use following color code and inscriptions for pushbuttons.

Tag Function	Inscription(s)	Color
OO	ON OFF	Black Black
OC	OPEN CLOSE	Black Black
OCA	OPEN CLOSE AUTO	Black Black Black
OOA	ON OFF AUTO	Black Black Black
MA	MANUAL AUTO	Black Black
SS	START STOP	Black Black
RESET	RESET	Black
EMERGENCY STOP	EMERGENCY STOP	Red

- a. Lettering Color:
 - 1) Black on white and yellow buttons.
 - 2) White on black, red, and green buttons.

- Q. Standard Light Colors and Inscriptions: Use following color code and inscriptions for service legends and lens colors for indicating lights.

Tag Function	Inscription(s)	Color
ON	ON	Red
OFF	OFF	Green
OPEN	OPEN	Red
CLOSED	CLOSED	Green
LOW	LOW	Red
FAIL	FAIL	Amber
HIGH	HIGH	Amber
AUTO	AUTO	White
MANUAL	MANUAL	Yellow
LOCAL	LOCAL	White
REMOTE	REMOTE	Yellow

1. Lettering Color:
 - a. Black on white and amber lenses.
 - b. White on red and green lenses.

2.09 ELECTRICAL TRANSIENT PROTECTION

A. General:

1. Function: Protect elements of PIC against damage due to electrical transients induced in interconnecting lines by lightning and nearby electrical systems.
2. Implementation: Provide, install, coordinate, and inspect grounding of surge suppressors at:
 - a. Connection of ac power to PIC equipment including panels, consoles assemblies, and field mounted analog transmitters and receivers.
 - b. At the field and panel, console, or assembly connection of signal circuits that have portions of the circuit extending outside of a protective building.
3. Construction: First-stage high energy metal oxide varistor and second-stage bipolar silicon avalanche device separated by series impedance. Includes grounding wire, stud, or terminal.
4. Response: 5 nanoseconds maximum.
5. Recovery: Automatic.
6. Temperature Range: Minus 20 degrees C to plus 85 degrees C.

B. Suppressors on 120V ac Power Supply Connections:

1. Occurrences: Tested and rated for a minimum of 50 occurrences of IEEE 587 Category B test waveform.
2. First-Stage Clamping Voltage: 350 volts or less.
3. Second-Stage Clamping Voltage: 210 volts or less.
4. Continuous Operation: Power supplies for one four-wire transmitter or receiver: 5 amps minimum at 130V ac. All other applications: 30 amps minimum at 130V ac.

C. Suppressors on Analog Signal Lines:

1. Test Waveform: Linear 8 microsecond rise in current from 0 amps to a peak current value followed by an exponential decay of current reaching one half the peak value in 20 microseconds.
2. Surge Rating: Tested and rated for 50 occurrences of 2,000-amp peak test waveform.
 - a. dc Clamping Voltage: 20 to 40 percent above operating voltage for circuit.
 - b. dc Clamping Voltage Tolerance: Less than plus or minus 10 percent.
 - c. Maximum Loop Resistance: 18 ohms per conductor.

D. Manufacturer and Products:

1. Type 2 (SS2): Analog Signals Lines (Panel Mounted):
 - a. Phoenix Contact; PT 1x2-24DC-ST (2856032).
 - b. Emerson Edco SRA64.
2. 120V ac Lines:
 - a. Phoenix Contact; PT 2-PE/S-120AC/FM (2856812).
 - b. Emerson Edco HSP-121.
3. Type 3 (SS3): Field Mounted at Two-Wire Instruments: Encapsulated in stainless steel pipe nipples.
 - a. Phoenix Contact; S-PT-EX-24DC-1/2" (2800035).
 - b. Emerson Edco SS64 series.
4. Type 4 (SS4): Field Mounted at Four-Wire Instruments: With 120V ac outlet, ac circuit breaker, and 10-ohm resistors on signal lines, all in enclosure.
 - a. Enclosure:
 - 1) NEMA 7 Type 316 stainless steel with door.
 - 2) Maximum Size: 12 inches by 12 inches by 8 inches deep.
 - b. Emerson Edco; SLAC series or Phoenix Contact equal.
5. Discrete Signal Lines: Phoenix Contact.

E. Installation and Grounding of Suppressors: As shown. See Surge Suppressor Installation Details. Grounding equipment, installation of grounding equipment, and terminations for field mounted devices are provided under Division 26, Electrical.

2.10 EXPENDABLES

<u>Item</u>	<u>Quantity</u>
Corrosion-inhibiting vapor capsules	Manufacturer's recommended 2-year supply

2.11 FABRICATION

A. General:

1. Panels with external dimensions and instruments arrangement as shown on Drawings.
2. Panel Construction and Interior Wiring: In accordance with the National Electrical Code, state and local codes, NEMA, ANSI, UL, and ICECA.
3. Fabricate panels, install instruments, wire, and plumb, at the PIC factory.
4. Electrical Work: In accordance with Division 26, Electrical.

B. Factory Assembly: Assemble panels at the manufacturer's factory. No fabrication other than correction of minor defects or minor transit damage shall be done on panels at Site.

C. UL Listing Mark for Enclosures: Mark stating "Listed Enclosed Industrial Control Panel" per UL 508A.

D. Wiring Within PIC Panels:

1. Restrain by plastic ties or ducts or metal raceways.
2. Hinge Wiring: Secure at each end so that bending or twisting will be around longitudinal axis of wire. Protect bend area with sleeve.
3. Arrange wiring neatly, cut to proper length, and remove surplus wire.
4. Abrasion protection for wire bundles which pass through holes or across edges of sheet metal.
5. Connections to Screw Type Terminals:
 - a. Locking-fork-tongue or ring-tongue lugs.
 - b. Use manufacturer's recommended tool with required sized anvil to make crimp lug terminations.
 - c. Wires terminated in a crimp lug, maximum of one.
 - d. Lugs installed on a screw terminal, maximum of two.
6. Connections to Compression Clamp Type Terminals:
 - a. Strip, prepare, and install wires in accordance with terminal manufacturer's recommendations.
 - b. Wires installed in a compression screw and clamp, maximum of one for field wires entering enclosure, otherwise maximum of two.

7. Splicing and tapping of wires, allowed only at device terminals or terminal blocks.
 8. Terminate 24V dc and analog signal circuits on separate terminal block from ac circuit terminal blocks.
 9. Separate analog and dc circuits by at least 6 inches from ac power and control wiring, except at unavoidable crossover points and at device terminations.
 10. Arrange wiring to allow access for testing, removal, and maintenance of circuits and components.
 11. Plastic Wire Ducts Fill: Do not exceed manufacturer's recommendation.
- E. Temperature Control:
1. Freestanding Panels:
 - a. Nonventilated Panels: Size to adequately dissipate heat from equipment mounted inside panel or on panel.
 - b. Ventilated Panels: Not acceptable for this project.
- F. Freestanding Panel Construction:
1. Materials: Sheet steel, unless otherwise shown on Drawings with minimum thickness of 10-gauge, unless otherwise noted.
 2. Panel Fronts:
 - a. Fabricated from a single piece of sheet steel, unless otherwise shown on Drawings.
 - b. No seams or bolt heads visible when viewed from front.
 - c. Panel Cutouts: Smoothly finished with rounded edges.
 - d. Stiffeners: Steel angle or plate stiffeners or both on back of panel face to prevent panel deflection under instrument loading or operation.
 3. Internal Framework:
 - a. Structural steel for instrument support and panel bracing.
 - b. Permit panel lifting without racking or distortion.
 4. Lifting rings to allow simple, safe rigging and lifting of panel during installation.
 5. Adjacent Panels: Securely bolted together so front faces are parallel.
 6. Doors: Full height, fully gasketed access doors where shown on Drawings.
 - a. Latches: Three-point, NEMA 4X.
 - b. Handles: "D" ring, foldable type.
 - c. Hinges: Full length, continuous, piano type, steel hinges with stainless steel pins.
 - d. Front Access Doors.

G. Non-freestanding Panel Construction:

1. Based on environmental design requirements required and referenced in Article Environmental Requirements, provide the following:
 - a. For panels listed as inside, air conditioned:
 - 1) Enclosure Type: NEMA 12 in accordance with NEMA 250.
 - 2) Materials: Steel.
 - b. For all other panels:
 - 1) Enclosure Type: NEMA 4X in accordance with NEMA 250.
 - 2) Materials: Type 316 stainless steel.
2. Metal Thickness: 14-gauge, minimum.
3. Doors:
 - a. Rubber-gasketed with continuous hinge.
 - b. Stainless steel lockable quick-release clamps.
4. Manufacturers:
 - a. Hoffman Engineering Co.
 - b. Rittal.

H. Factory Finishing:

1. Enclosures:
 - a. Stainless Steel and Aluminum: Not painted.
 - b. Nonmetallic Panels: Not painted.
 - c. Steel Panels:
 - 1) Sand panel and remove mill scale, rust, grease, and oil.
 - 2) Fill imperfections and sand smooth.
 - 3) Paint panel interior and exterior with one coat of epoxy coating metal primer, two finish coats of two-component type epoxy enamel.
 - 4) Sand surfaces lightly between coats.
 - 5) Dry Film Thickness: 3 mils, minimum.
 - 6) Color: Manufacturer's Standard.
2. Manufacturer's standard finish color, except where specific color is indicated. If manufacturer has no standard color, finish equipment with light gray color.

2.12 CORROSION PROTECTION

- A. Corrosion-Inhibiting Vapor Capsule Manufacturers: Provide manufacturer's recommended 2-year supply:
1. Northern Instruments; Model Zerust VC.
 2. Hoffmann Engineering Co; Model A-HCI.

2.13 SOURCE QUALITY CONTROL

A. General:

1. Engineer may actively participate in many of the tests.
2. Engineer reserves right to test or retest specified functions.
3. Engineer's decision will be final regarding acceptability and completeness of testing.
4. Procedures, Forms, and Checklists:
 - a. Except for Unwitnessed Factory Test, conduct tests in accordance with, and documented on, Engineer accepted procedures, forms, and checklists.
 - b. Describe each test item to be performed.
 - c. Have space after each test item description for sign off by appropriate party after satisfactory completion.
5. Required Test Documentation: Test procedures, forms, and checklists signed by Engineer and Contractor.
6. Conducting Tests:
 - a. Provide special testing materials and equipment.
 - b. Wherever possible, perform tests using actual process variables, equipment, and data.
 - c. If not practical to test with real process variables, equipment, and data provide suitable means of simulation.
 - d. Define simulation techniques in test procedures.
 - e. Test Format: Cause and effect.
 - 1) Person conducting test initiates an input (cause).
 - 2) Specific test requirement is satisfied if correct result (effect), occurs.

B. Unwitnessed Factory Test:

1. Scope: Inspect and test PIC to ensure it is operational, ready for FDT.
2. Location: PIC System Integrator's facility.
3. Integrated Test:
 - a. Interconnect and test PIC, except for primary elements and smaller panels.
 - b. Exercise and test functions.
 - c. Provide stand-alone testing of smaller panels.
 - d. Simulate inputs and outputs for primary elements, final control elements, and panels excluded from test.

C. Factory Demonstration Tests (FDT):

1. Notify Engineer of test schedule 4 weeks prior to start of test.
2. Scope:
 - a. Test entire PIC, with exception of primary elements, final control elements, and certain smaller panels, to demonstrate it is operational.

- b. Test all PIC supplied panels.
3. Location: PIC System Integrator's facility.
4. Correctness of wiring from panel field terminals to PLC system input/output points and to panel components.
 - a. Simulate each discrete signal at terminal strip.
 - b. Simulate correctness of each analog signal using current source.
5. Operation of communications between PLCs and remote I/O and between PLCs and computers.
6. Operation of communications between the PLC system.
7. Loop-Specific Functions: Demonstrate functions shown on P&IDs, control diagrams, and loop specifications:
 - a. One of each type function; for example, if there are filter backwash sequence control for several identical filters, demonstrate controls for one filter.
 - b. One of each type of function in each panel; for example, but not limited to annunciator operation, controller operation, and recorder operation.
 - c. All required and shown functions for 100 percent of loops.
8. Non-loop-Specific Functions:
 - a. Capacity: Demonstrate that PIC systems have required spare capacity for expansion. Include tests for both storage capacity and processing capacity.
 - b. Timing: Include tests for timing requirements.
 - c. Diagnostics: Demonstrate online and offline diagnostic tests and procedures.
9. Correct deficiencies found and complete prior to shipment to Site.
10. Failed Tests:
 - a. Repeat and witnessed by Engineer.
 - b. With approval of Engineer, certain tests may be conducted by PIC System Integrator and witnessed by Engineer as part of Functional Test.
11. Make following documentation available to Engineer at test site both before and during FDT:
 - a. Drawings, Specifications, Addenda, and Change Orders.
 - b. Master copy of FDT procedures.
 - c. List of equipment to be tested including make, model, and serial number.
 - d. Approved hardware Shop Drawings for equipment being tested.
 - e. Approved preliminary software documentation Submittal.
12. Daily Schedule for FDT:
 - a. Begin each day with meeting to review day's test schedule.
 - b. End each day with each meeting to review day's test results and to review or revise next day's test schedule.

PART 3 EXECUTION

3.01 EXAMINATION

- A. For equipment not provided by PIC, but that directly interfaces with the PIC, verify the following conditions:
1. Proper installation.
 2. Calibration and adjustment of positioners and I/P transducers.
 3. Correct control action.
 4. Switch settings and dead bands.
 5. Opening and closing speeds and travel stops.
 6. Input and output signals.

3.02 INSTALLATION

- A. Material and Equipment Installation: Retain a copy of manufacturers' instructions at Site, available for review at all times.
- B. Electrical Wiring: As specified in Division 26, Electrical.
- C. Mechanical Systems:
1. Drawings for PIC Mechanical Systems are diagrammatic and not intended to specifically define element locations or piping and tubing run lengths. Base materials and installations on field measurements.
 2. Copper and Stainless Steel Tubing Support: Continuously supported by an aluminum tubing raceway system.
 3. Plastic Tubing Supports: Except as shown on Drawings, provide continuous support in conduits or by aluminum tubing raceway system.
 4. Install tubing conduit for plastic tubing and tubing raceways parallel with, or at right angles to, structural members of buildings. Make vertical runs straight and plumb.
 5. Tubing and Conduit Bends:
 - a. Tool-formed without flattening, and all of same radius.
 - b. Bend Radius: Equal to or larger than conduit and tubing manufacturer's recommended minimum bend radius.
 - c. Slope instrument connection tubing in accordance with installation details.
 - d. Do not run liquid filled instrument tubing immediately over or within a 3-foot plan view clearance of electrical panels, motor starters, or mechanical mounting panel without additional protection. Where tubing must be located in these zones, shield electrical device to prevent water access to electrical equipment.
 - e. Straighten coiled tubing by unrolling on flat surface. Do not pull to straighten.
 - f. Cut tubing square with sharp tubing cutter. Deburr cuts and remove chips. Do not gouge or scratch surface of tubing.

- g. Blow debris from inside of tubing.
 - h. Make up and install fittings in accordance with manufacturer's recommendations. Verify makeup of tube fittings with manufacturer's inspection gauge.
 - i. Use lubricating compound or TFE tape on stainless steel threads to prevent seizing or galling.
 - j. Run tubing to allow, for example, clear access to doors, controls, and control panels; and to allow for easy removal of equipment.
 - k. Provide separate support for components in tubing runs.
 - l. Supply expansion loops and use adapters at pipe, valve, or component connections for proper orientation of fitting.
 - m. Keep tubing and conduit runs at least 12 inches from hot pipes.
 - n. Locate and install tubing raceways in accordance with manufacturer's recommendations. Locate tubing to prevent spillage, overflow, or dirt from above.
 - o. Securely attach tubing raceways to building structural members.
6. Enclosure Lifting Rings: Remove rings following installation and plug holes.

D. Removal or Relocation of Materials and Equipment:

- 1. Remove from Site materials that were part of the existing facility but are no longer used, unless otherwise directed by Engineer to deliver to Owner.
- 2. Repair affected surfaces to conform to type, quality, and finish of surrounding surface.

3.03 FIELD FINISHING

- A. Refer to Section 09 90 00, Painting and Coating.

3.04 FIELD QUALITY CONTROL

A. Startup and Testing Team:

- 1. Thoroughly inspect installation, termination, and adjustment for components and systems.
- 2. Complete onsite tests.
- 3. Complete onsite training.
- 4. Provide startup assistance.

B. Operational Readiness Inspections and Calibrations: Prior to startup, inspect and test to ensure that entire PIC is ready for operation.

- 1. Loop/Component Inspections and Calibrations:
 - a. Check PIC for proper installation, calibration, and adjustment on a loop-by-loop and component-by-component basis.

- b. Prepare component calibration sheet for each active component (except simple hand switches, lights, gauges, and similar items).
 - 1) Project name.
 - 2) Loop number.
 - 3) Component tag number.
 - 4) Component code number.
 - 5) Manufacturer for elements.
 - 6) Model number/serial number.
 - 7) Summary of functional requirements, for example:
 - a) Indicators and recorders, scale and chart ranges.
 - b) Transmitters/converters, input and output ranges.
 - c) Computing elements' function.
 - d) Controllers, action (direct/reverse) and control modes (PID).
 - e) Switching elements, unit range, differential (fixed/adjustable), reset (auto/manual).
 - 8) Calibrations, for example:
 - a) Analog Devices: Actual inputs and outputs at 0, 10, 50, and 100 percent of span, rising and falling.
 - b) Discrete Devices: Actual trip points and reset points.
 - c) Controllers: Mode settings (PID).
 - 9) Space for comments.
 - c. These inspections and calibrations will be spot checked by Engineer.
- C. Performance Acceptance Tests (PAT): These are the activities that Section 01 91 14, Equipment Testing and Facility Startup, refers to as Performance Testing.
- 1. General:
 - a. Test all PIC elements to demonstrate that PIC satisfies all requirements.
 - b. Test Format: Cause and effect.
 - 1) Person conducting test initiates an input (cause).
 - 2) Specific test requirement is satisfied if correct result (effect) occurs.
 - c. Procedures, Forms, and Checklists:
 - 1) Conduct tests in accordance with, and documented on, Engineer accepted procedures, forms, and checklists.
 - 2) Describe each test item to be performed.
 - 3) Have space after each test item description for sign off by appropriate party after satisfactory completion.
 - d. Required Test Documentation: Test procedures, forms, and checklists. All signed by Engineer and Contractor.

- e. Conducting Tests:
 - 1) Provide special testing materials, equipment, and software.
 - 2) Wherever possible, perform tests using actual process variables, equipment, and data.
 - 3) If it is not practical to test with real process variables, equipment, and data, provide suitable means of simulation.
 - 4) Define simulation techniques in test procedures.
 - f. Coordinate PIC testing with Owner and affected Subcontractors.
 - 1) Excessive Test Witnessing: Refer to Supplementary Conditions.
2. Test Requirements:
- a. Once facility has been started up and is operating, perform a witnessed PAT on complete PIC to demonstrate that it is operating as required. Demonstrate each required function on a paragraph-by-paragraph and loop-by-loop basis.
 - b. Perform local and manual tests for each loop before proceeding to remote and automatic modes.
 - c. Where possible, verify test results using visual confirmation of process equipment and actual process variable. Unless otherwise directed, exercise and observe devices supplied by others, as needed to verify correct signals to and from such devices and to confirm overall system functionality. Test verification by means of disconnecting wires or measuring signal levels is acceptable only where direct operation of plant equipment is not possible.
 - d. Make updated versions of documentation required for PAT available to Engineer at Site, both before and during tests.
 - e. Make one copy of O&M manuals available to Engineer at the Site both before and during testing.
 - f. Refer to referenced examples of PAT procedures and forms in Article Supplements.

3.05 TRAINING

A. General:

- 1. Provide an integrated training program to meet specific needs of Owner's personnel.
- 2. Include training sessions, classroom and field, for managers, engineers, operators, and maintenance personnel.
- 3. Provide instruction on two working shift(s) as needed to accommodate the Owner's personnel schedule.
- 4. Owner reserves the right to make and reuse video tapes of training sessions.

B. Operations and Maintenance Training:

1. Include a review of O&M manuals and survey of spares, expendables, and test equipment.
2. Use equipment similar to that provided or currently owned by Owner.
3. Provide training suitable for instrument technicians with at least a 2-year associate engineering or technical degree, or equivalent education and experience in electronics or instrumentation.

C. Operations Training:

1. Training Session Duration: One 8-hour instructor days.
2. Number of Training Sessions: Two.
3. Location: Site.
4. Content: Conduct training on loop-by-loop basis.
 - a. Loop Functions: Understanding of loop functions, including interlocks for each loop.
 - b. Loop Operation: For example, adjusting process variable setpoints, AUTO/MANUAL control transfer, AUTO and MANUAL control, annunciator acknowledgement and resetting.
 - c. Interfaces with other control systems.

D. Maintenance Training:

1. Training Session Duration: One 8-hour instructor days.
2. Number of Training Sessions: Two.
3. Location: Project Site.
4. Content: Provide training for each type of component and function provided.
 - a. Loop Functions: Understanding details of each loop and how they function.
 - b. Component calibration.
 - c. Adjustments: For example, controller tuning constants, current switch trip points, and similar items.
 - d. Troubleshooting and diagnosis for components.
 - e. Replacing lamps, chart paper, fuses.
 - f. Component removal and replacement.
 - g. Periodic maintenance.

3.06 CLEANING/ADJUSTING

- A. Repair affected surfaces to conform to type, quality, and finish of surrounding surface.
- B. Cleaning:
 1. Prior to closing system using tubing, clear tubing of interior moisture and debris.

2. Upon completion of Work, remove materials, scraps, and debris from interior and exterior of equipment.

3.07 PROTECTION

- A. Protect enclosures and other equipment containing electrical, instrumentation and control devices, including spare parts, from corrosion through the use of corrosion-inhibiting vapor capsules.
- B. Periodically replace capsules in accordance with capsule manufacturer's recommendations. Replace capsules just prior to Final Payment and Acceptance.

3.08 SUPPLEMENTS

- A. Supplements listed below, following "End of Section," are part of this Specification.
 1. Loop Specifications.
 2. Input/Output List.
 3. PLC and Network Components List.
 4. Control Panel Schedule.
 5. Instrument Calibration Sheet: Provides detailed information on each instrument (except simple hand switches, lights, and similar items).
 6. Performance Acceptance Test Sheet: Describes the PAT for a given loop. The format is mostly free form.
 - a. Lists the requirements of the loop.
 - b. Briefly describes the test.
 - c. Cites expected results.
 - d. Provides space for check off by witness.

END OF SECTION

LOOP SPECIFICATIONS

The Loop Specifications are divided into the following sections:

- **Definitions**

This Section defines basic functions and other terms used in subsequent sections (Global Functions, Modular Functions, and Unit Processes).

- **Global Functions**

Global functions are required for all applicable variables and are not listed in the Unit Process Loop Specifications.

- **Modular Functions**

Modular functions are included by reference in the subsequent Unit Process Loop Specifications.

- **Loop Specifications**

Loop Specifications are included for each site type and include extensive references to Function Definitions and Modular Functions.

DEFINITIONS

LOCAL vs REMOTE

Most devices (e.g. motors, gates, valves) can be controlled from two locations: at the device and at the control system HMI. External to the PLC, a hand switch is provided to either control the device 'locally' or to control the device remotely via at the HMI. The PLC will not attempt to control any device that is in the LOCAL position. When in REMOTE, the device will be controlled through the PLC.

IN SERVICE vs OUT OF SERVICE

A device can be flagged as In Service or Out of Service from the HMI. The purpose of the flag would be to notify other personal who may be viewing the graphics that the particular device is not available for operation. This is not a replacement for proper lock out/tag out procedures. A device can only be placed In Service or taken Out of Service by an operator.

When a device is flagged as being Out of Service, all alarms associated with the device will be masked until the device is placed back In Service.

REMOTE AUTO vs REMOTE MANUAL

When a device is in REMOTE, it can be operated in either Manual or Auto modes. Remote Manual mode means that the operator has taken control of the device and the process. When in Remote Auto mode, the PLC will control the device based on the automatic logic.

VARIABLE

Any signal (discrete, analog, or pulse frequency), (input, output, or calculated). Pulse frequency signals are a type of analog signal. Provide the same processing and functions for pulse frequency signals as are provided for analog signals.

DISPLAY (Tag)

- Display all variables on the Human Machine Interface (HMI). Display status for discrete variables such as ON/OFF/FAIL status for motors and OPEN/CLOSE/FAIL status for valves. Display value for analog variables such as process variables, set points, drive speeds, and valve positions. To prevent clutter and to ease operation, some displayed variables will not normally appear on displays but will be accessible through easily identifiable point-and-click targets. Runtime counters are an example of variables that might not normally appear.

PRESENT

A discrete signal is present when the contact producing the input is closed.

TRUE

A condition is true when it exists. The open/closed state of a discrete signal representing that condition will depend on the configuration of the device producing the discrete signal.

ALARM

Indicate the alarm condition on appropriate HMI displays, and add to the HMI alarm summary display. Upon acknowledgement, indicate the alarm condition on appropriate HMI displays and the alarm summary display. Remove acknowledged alarms from the alarm summary once they are cleared.

Log alarm occurrence, acknowledgement, and clearance in the alarm log file.

ON (RUNNING)

The equipment or adjustable speed motor is ON when the equipment or motor drive ON status contact is closed. A constant speed motor is ON when a motor normally open auxiliary motor contact (M-Contact) from the motor is closed.

TREND

At intervals appropriate for the variable being trended, place the current value of analog variable, along with a time and date stamp, into a historical trend file for that variable. Display the trend on selectable HMI screens with appropriate scaling and units.

CLOSE FAIL

A valve is commanded-to-close, but is not confirmed closed within a preset time. Unless otherwise noted, a valve is confirmed closed by receiving Closed limit switch contact from the valve.

POSITION FAIL

A modulating valve is commanded to a set point position, but the valve is not confirmed to be within a preset percentage of set point within a preset time.

OPEN FAIL

A valve is commanded-to-open, but is not confirmed open within a preset time. Unless otherwise noted, a valve is confirmed open by receiving OPEN limit switch contact from the valve.

RUN FAIL

A motor is commanded-to-run, but is not confirmed running within a preset time. Unless otherwise noted, running is confirmed by receiving an ON status M-contact from the motor's starter.

START

Issue a maintained Run command.

STOP

Cease the maintained Run command.

TOTALIZE

Integrate flow type variable with respect to time. Unless otherwise noted, includes password protected operator reset that sets the totalized value to zero.

ELAPSED RUN TIME

Calculate the total time (in tenths of an hour) that a motor or piece of equipment has been in operation. For equipment and constant speed motors, use starter M-contacts to detect when the equipment or motor is running. For adjustable speed motors, use ON status contacts from the drive that close when the drive is in operation. For valves, calculate the time that the valve is open. Unless otherwise noted, include password protected operator reset that sets elapsed run times to zero.

CYCLE COUNT

Count the number of cycles a piece of equipment, valve, or motor undergoes. For equipment and motors, one cycle is defined as the transition from OFF to ON. For valves, one cycle is defined as the transition from CLOSED to OPEN.

TWO MODE FEEDBACK CONTROL

Maintain a process variable at a set point value by means of feedback control of a control variable such as pump speed or valve position using both proportional and integral action. During startup tune the loop by adjusting proportional band and integral time settings. Provide a set point Deviation Alarm that is activated when the process variable deviates by more than x percent from set point for a sustained time. Provide password protected access to tuning parameters such as proportional band and reset rate.

Parameters Defined in the Specific Unit Process Control Narratives Include:

Process Variable.

Process Variable Set Point.

Controlled Device.

Set Point Deviation Alarm Set Point.

GLOBAL FUNCTIONS

PLC AND HMI TAGS

Match existing

IN SERVICE/OUT OF SERVICE

In the PLC, provide for operator control to put a piece of equipment IN SERVICE or OUT OF SERVICE. Disable equipment alarms when the piece of equipment is out of service.

IN SERVICE (REMOTE-AUTOMATIC) Control

Automatically sequence equipment that is IN SERVICE and in REMOTE-AUTO in accordance with these loop specifications.

BUMPLESS TRANSFER

Configure all “software” REMOTE Manual/Auto switches to provide “bumpless transfer.”

1. Manual to Auto Transition:
 - a. Once the transition occurs, immediately start the device if the Auto Mode so commands.
 - b. For modulating devices, initially maintain the last manual control variable output value on transition to Auto. After the transition, enable the automatic control algorithm to commence incrementally from the final manual value.

3. Auto to Manual Transition:
 - a. If a device has been running in Auto, configure so it continues to run once placed in Manual.
 - b. If a device has not been running in Auto, configure so it does not run once placed in Manual.
 - c. If an adjustable speed device has been running at a certain speed in Auto, configure so it runs at the same speed once placed in Manual.
 - d. For all modulating devices, maintain the last analog control variable output value on transition to Manual.

DISPLAY (Tag)

Display all discrete signals and all analog variables. Display all variables at the HMI. For those discrete signals identified as field alarms as well as software derived alarms, implement ALARM functions.

ADJUSTABLE PARAMETER ACCESS

Provide password protected display (Operator Access) of and entry/modification of all adjustable parameters including, but not limited to, set points, tuning coefficients (for example proportional and integral), timer presets, and alarm trip points. Users logged in as Guest shall have read-only access to all parameters.

Present these parameters in an efficient easily navigated format. Provide adequate information to allow the facility maintenance staff to easily identify each variable. The intent is to allow the maintenance staff to tune facility performance and operation without having to alter the PLC program.

NUISANCE ALARM SUPPRESSION

Provide nuisance alarm suppression by conditioning alarm signals. For example disable all but selected alarms when power is off. Under normal operation, include startup delays, momentary excursion delays, and contact bounce delays. Suppress dysfunctional alarms during and immediately following power outages.

RUN FAIL ALARM

Provide run fail alarms for each motor. Upon motor run fail, remove the run command.

FAIL ALARM

Provide fail alarms for each fail condition. Upon fail, remove the run command.

OPEN FAIL ALARM

Provide open fail alarms for each nonmodulating valve with OPEN status confirmation. Upon open fail, remove the open command.

CLOSE FAIL ALARM

Provide close fail alarms for each nonmodulating valve with CLOSED status confirmation. Upon close fail, remove the close command.

POSITION FAIL ALARM

Provide position fail alarms for each modulating valve with position feedback.

TOTALIZERS

Provide totalizers for all flow type variables (flow, chemical feed rate, etc.).

ELAPSED RUN TIME INDICATORS

Provide daily, monthly and yearly elapsed run time counters for each motor and electrical equipment including valves. For valves, calculate elapsed run time when in the open position.

For pump stations with multiple pumps, calculate the total time (in tenths of an hour) that two motors have been in operation simultaneously. Calculate and display daily run time, monthly run time and yearly run time.

Increment counters after each tenth of an hour of operation. Maintain a nonresettable 99,999 hour cumulative counter that rolls over to zero after 99,999 hours. Indicate runtime counters on appropriate HMI displays. Perform all logic in the PLC.

ALTERNATION BASED ON RUN TIME

Separate from the elapsed run time indicators, provide run time indicators for the elapsed time that a piece of equipment has been running. Provide for operator reset of the alternation run time for each piece of equipment.

The Lead/Lag assignment of equipment is determined by the equipment with the least runtime alternation. If a piece of equipment is failed or is not available and is called to run as part of the auto sequence, the next available piece of equipment should automatically start.

CYCLE COUNTERS

Provide cycle counters for each motor and electrical equipment including valves.

Maintain a nonresetable 99,999 start cumulative counter that rolls over to zero after 99,999 counts. Indicate counters on appropriate HMI displays. Start counter logic will be performed in the PLC/RTU.

TREND

As a minimum, trend all analog signals.

MODULAR FUNCTIONS**ANALYSIS ALARM**

ALARM: Concentration, High and Low.

(For above alarm, provide time filter to prevent nuisance alarms.)

FLOW ALARM

ALARM: High and Low Flow.

(For above alarm, provide time filter to prevent nuisance alarms.)

LEVEL ALARM

ALARM: High and Low Level.

PRESSURE ALARM

ALARM: High and Low Pressure.

SPEED ALARM

ALARM: High and Low Speed.

UNIT PROCESS LOOP SPECIFICATIONS

Applicable Global Functions (Above).

Follow Owner color standard when programming the panel mounted HMI as follows:

ON/OPENED – Red

OFF/CLOSED – Green

08-N-601: Effluent Pump Station

For each Effluent Pump X, X=1 and 2 when the respective pump HAND/OFF/AUTO hand switch is in AUTO:

Provide Manual/Auto selector switch:

In Manual, provide START/STOP and manual speed control.

In Auto, control the pumps in an Active-Standby configuration.

In Auto, provide two mode feedback control to maintain constant level in the Effluent Pump Station. Parameters as follows:

Process Variable: Selected Effluent Pump Station Level.

Initial Process Variable Set Point: To be Field Determined

Controlled Devices: Active Pump.

Set Point Deviation Alarm Setpoint: Plus or minus 5 percent.

Deadband: Initial setting, 0.25 feet.

Set the minimum CV output of the PID to the pump minimum speed.

Sequence the Active Pump as follows:

Start the Active Pump when the level rises above an operator adjustable start level setpoint for an operator adjustable time delay (initial setting, 30 seconds). Display the time remaining until the Active Pump stages on. The pump speed shall be adjusted to maintain the Effluent PS level.

Stop the Active Pump when the level falls below an operator adjustable stop level setpoint for an operator adjustable time delay (initial setting, 30 seconds). Display the time remaining until the Active Pump stages off.

Provide bumpless transfer for each pump when going from Auto to Manual and Manual to Auto.

Flow Control

There is a maximum flowrate allowed to a DIW. If the flow to a DIW exceeds 17,000 gpm; place the level control loop to manual and hold the same speed setting. Once the flow goes below 17,000 gpm for a preset time, enable the PID loop again.

Pump Alarming

Generate an alarm and stop the pump if its respective discharge check valve doesn't open after a preset time delay (initial setting, 50 seconds) after the pump has been confirmed running. Manual reset is required for the pump to resume operation.

Abnormal Condition in REMOTE-AUTO: Stop Pumps on low low level (as measured by the active level transmitter). Pumps shall automatically resume operation once the level rises above an operator adjustable low low level reset value.

Generate a flow fail alarm and stop the pump if the pump is running for a preset time and flow (as measured by the active Deep Injection Well flow meter) hasn't risen above a preset rising set point.

Provide a popup for each pump to display all pump alarms. Animate the alarms such that it is clear which alarms are active and which are inactive. On the main process graphic, provide indication that the pump has an active alarm.

Pump Alarm Summary:

Alarm	PLC Pump Action	Reset
Low Low Level Analog	Shutdown Pump running in REMOTE-AUTO	Auto reset when level rises above SP
Discharge Valve Closed Alarm	Shutdown Pump running in REMOTE-MANUAL or REMOTE-AUTO	Manual reset
Pump High Temperature	Shutdown Pump running in REMOTE-MANUAL or REMOTE-AUTO	Manual reset
No Power Available	Shutdown Pump running in REMOTE-MANUAL or REMOTE-AUTO	Auto reset after time delay when power is restored
No Flow	Shutdown Pump running in REMOTE-MANUAL or REMOTE-AUTO	Manual reset

Pump Rotation

Effluent Pump 1 and 2 Alternation: Provide for automatic alternation when a VFD has been running for 24 hours continuous or when both pumps are off in auto.

Level Transmitter Selection

Active Effluent Pump Station Level Transmitter Selection: Provide for operator selection of the active level transmitter to be used in the pump control and alarming. In the case where the active transmitter fails, automatically failover to the other transmitter. Provide a level deviation alarm if the two transmitters differ by more than 5%.

LEVEL ALARM: Active Effluent Level. Initial alarm set points as follows:

Alarm	Set Point (ft)
High-High	7.75, rising
High	7.00, rising
Low	4.00, falling
Low-Low	3.00, falling

08-N-601: Deep Injection Well

FLOW ALARM: Deep Injection 1 Well Flow.

FLOW ALARM: Deep Injection 2 Well Flow.

PRESSURE ALARM: Deep Injection Well 1 Pressure.

PRESSURE ALARM: Deep Injection Well 2 Pressure.

LEVEL ALARM: Monitoring Well Lower Zone Level.

LEVEL ALARM: Monitoring Well Upper Zone Level.

LEVEL ALARM: Monitoring Well Single Zone Level.

For each Deep Injection Well Valve, provide manual control. In Manual, provide open and close control.

The Deep Injection Well Valve that is OPENED is the active well and its flow meter will be used to generate the no flow alarm for the Effluent Pumps.

END OF LOOP SPECIFICATIONS

I/O List											
PLC	Tagname	Description	Type	Function	RACK	Slot	Point	Low	High	Units	NOTES
PLC-3-1	Effluent Pump PLC	ControlLogix			1	0	0				
PLC-3-1	P_6_2_1_sRun	Effluent Pump 1 ON Status	DI	On	1	2	0				
PLC-3-1	P_6_2_1_aFail	Effluent Pump 1 Fail Alarm	DI	Alarm	1	2	1				
PLC-3-1	P_6_2_1_sRem	Effluent Pump 1 In Remote	DI	Remote	1	2	2				
PLC-3-1	P_6_2_1_aTsh	Effluent Pump 1 High Temperature	DI	Alarm	1	2	3				
PLC-3-1	P_6_2_1_sSealWtrRun	Effluent Pump 1 Seal Water Ok	DI	On	1	2	4				
PLC-3-1	FV_3_1_2_sOpnd	Effluent Pump 1 Discharge Valve Opened	DI	Opened	1	2	5				
PLC-3-1	FV_3_1_2_sClsd	Effluent Pump 1 Discharge Valve Closed	DI	Closed	1	2	6				
PLC-3-1	FV_3_1_2_sRem	Effluent Pump 1 Discharge Valve In Remote	DI	Remote	1	2	7				
PLC-3-1	FP_13_2_aAlm	Surge Tank System Fail	DI	Alarm	1	2	8				
PLC-3-1	UPS_3_1_1_aLowBat	UPS Low Battery Alarm	DI	Alarm	1	2	9				
PLC-3-1	UPS_3_1_1_aAlarm	UPS Alarm	DI	Alarm	1	2	10				
PLC-3-1	FV_12_1_1_sOpnd	DIW 1 Valve Opened	DI	Opened	1	2	11				
PLC-3-1	FV_12_1_1_sClsd	DIW 1 Valve Closed	DI	Closed	1	2	12				
PLC-3-1	FV_12_1_1_sRem	DIW 1 Valve In Remote	DI	Remote	1	2	13				
PLC-3-1	Spare	Spare	DI		1	2	14				
PLC-3-1	Spare	Spare	DI		1	2	15				
PLC-3-1	P_6_2_2_sRun	Effluent Pump 2 ON Status	DI	On	1	3	0				
PLC-3-1	P_6_2_2_aFail	Effluent Pump 2 Fail Alarm	DI	Alarm	1	3	1				
PLC-3-1	P_6_2_2_sRem	Effluent Pump 2 In Remote	DI	Remote	1	3	2				
PLC-3-1	P_6_2_2_aTsh	Effluent Pump 2 High Temperature	DI	Alarm	1	3	3				
PLC-3-1	P_6_2_2_sSealWtrRun	Effluent Pump 2 Seal Water Ok	DI	On	1	3	4				
PLC-3-1	FV_3_1_3_sOpnd	Effluent Pump 2 Discharge Valve Opened	DI	Opened	1	3	5				
PLC-3-1	FV_3_1_3_sClsd	Effluent Pump 2 Discharge Valve Closed	DI	Closed	1	3	6				
PLC-3-1	FV_3_1_3_sRem	Effluent Pump 2 Discharge Valve In Remote	DI	Remote	1	3	7				
PLC-3-1	Spare	Spare	DI		1	3	8				
PLC-3-1	FV_12_4_sOpnd	DIW 2 Valve Opened	DI	Opened	1	3	9				
PLC-3-1	FV_12_4_sClsd	DIW 2 Valve Closed	DI	Closed	1	3	10				
PLC-3-1	FV_12_4_sRem	DIW 2 Valve In Remote	DI	Remote	1	3	11				
PLC-3-1	Spare	Spare	DI		1	3	12				
PLC-3-1	FP_3_1_120V ac Power Fail	FP-3-1 120V ac Power Fail	DI	Alarm	1	3	13				
PLC-3-1	Spare	Spare	DI		1	3	14				
PLC-3-1	Spare	Spare	DI		1	3	15				
PLC-3-1	UPS_3_1_2_aLowBat	UPS Low Battery Alarm	DI	Alarm	1	4	0				
PLC-3-1	UPS_3_1_2_aAlarm	UPS Alarm	DI	Alarm	1	4	1				
PLC-3-1	Spare	Spare	DI		1	4	2				
PLC-3-1	Spare	Spare	DI		1	4	3				
PLC-3-1	Spare	Spare	DI		1	4	4				
PLC-3-1	Spare	Spare	DI		1	4	5				
PLC-3-1	Spare	Spare	DI		1	4	6				
PLC-3-1	Spare	Spare	DI		1	4	7				
PLC-3-1	Spare	Spare	DI		1	4	8				
PLC-3-1	Spare	Spare	DI		1	4	9				
PLC-3-1	Spare	Spare	DI		1	4	10				
PLC-3-1	Spare	Spare	DI		1	4	11				
PLC-3-1	Spare	Spare	DI		1	4	12				
PLC-3-1	Spare	Spare	DI		1	4	13				
PLC-3-1	Spare	Spare	DI		1	4	14				

I/O List												
PLC	Tagname	Description	Type	Function	RACK	Slot	Point	Low	High	Units	NOTES	
PLC-3-1	Spare	Spare	DI		1	4	15					
PLC-3-1	P_6_2_1_qRun	Effluent Pump 1 Run Command	DO	Start	1	5	0					
PLC-3-1	P_6_2_2_qRun	Effluent Pump 2 Run Command	DO	Start	1	5	1					
PLC-3-1	FV_12_1_1_qOpn	DIW 1 Valve Open Command	DO	Open	1	5	2					
PLC-3-1	FV_12_1_1_qCls	DIW 1 Valve Close Command	DO	Close	1	5	3					
PLC-3-1	Spare	Spare	DO		1	5	4					
PLC-3-1	Spare	Spare	DO		1	5	5					
PLC-3-1	Spare	Spare	DO		1	5	6					
PLC-3-1	Spare	Spare	DO		1	5	7					
PLC-3-1	Spare	Spare	DO		1	5	8					
PLC-3-1	FV_12_4_qOpn	DIW 2 Valve Open Command	DO	Open	1	5	9					
PLC-3-1	FV_12_4_qCls	DIW 2 Valve Close Command	DO	Close	1	5	10					
PLC-3-1	Spare	Spare	DO		1	5	11					
PLC-3-1	Spare	Spare	DO		1	5	12					
PLC-3-1	Spare	Spare	DO		1	5	13					
PLC-3-1	Spare	Spare	DO		1	5	14					
PLC-3-1	Spare	Spare	DO		1	5	15					
PLC-3-1	P_6_2_1_sSpd	Effluent Pump 1 Speed Feedback	AI	Speed	1	6	0	0	100%			
PLC-3-1	LIT_6_2_1_sPv	Effluent Wetwell Level 1	AI	Level	1	6	2			FT		
PLC-3-1	LUR_12_2_2	Monitoring Well Lower Zone Level	AI	Level	1	6	2	0	75 FT			
PLC-3-1	LUR_12_2_1	Monitoring Well Upper Zone Level	AI	Level	1	6	3	0	100 FT			
PLC-3-1	LUR_12_3	Monitoring Well Single Zone Level	AI	Level	1	6	4	0	50 FT			
PLC-3-1	Spare	Spare	AI		1	6	5					
PLC-3-1	P_6_2_2_sSpd	Effluent Pump 2 Speed Feedback	AI	Speed	1	7	0	0	100%			
PLC-3-1	LIT_6_2_2_sPv	Effluent Wetwell Level 2	AI	Level	1	7	1			FT		
PLC-3-1	FIT_12_4	DIW 2 Flow	AI	Flow	1	7	2	0	14000 GPM			
PLC-3-1	PIT_12_4	DIW 2 Pressure	AI	Pressure	1	7	3	0	100 PSI			
PLC-3-1	Spare	Spare	AI		1	7	4					
PLC-3-1	Spare	Spare	AI		1	7	5					
PLC-3-1	FIT_12_1	DIW 1 Flow	AI	Flow	1	8	0	0	GPM			
PLC-3-1	PIT_12_1	DIW 1 Pressure	AI	Pressure	1	8	1	0	PSI			
PLC-3-1			AI		1	8	2					
PLC-3-1			AI		1	8	3					
PLC-3-1			AI		1	8	4					
PLC-3-1			AI		1	8	5					
PLC-3-1	P_6_2_1_qSpd	Effluent Pump 1 Speed Command	AO	Speed	1	9	0	0	100%			
PLC-3-1	P_6_2_2_qSpd	Effluent Pump 1 Speed Command	AO	Speed	1	9	1					
PLC-3-1	Spare	Spare	AO		1	9	2					
PLC-3-1	Spare	Spare	AO		1	9	3					
PLC-3-1	Spare	Spare	AO		1	9	4					
PLC-3-1	Spare	Spare	AO		1	9	5					

**SUPPLEMENT 3
CITY of KEY WEST WWTP EFFLUENT PUMP REPLACEMENT
PLC AND NETWORK COMPONENTS LIST**

Name	Description	Code	Qty.	Model	Manufacturer	Comments
FP-3-1 Effluent Pump Panel						
PLC-3-1	PLC Rack		1	1756-A13	Allen Bradley	13 Slot ControlLogix Chassis
PLC-3-1	PLC Central Processing Unit		1	1756-L71	Allen Bradley	2 MB user memory
PLC-3-1	PLC Power Supply		1	1756-PA75	Allen Bradley	120V ac input/output power
PLC-3-1	PLC Ethernet Communications Module		1	1756-EN2T	Allen Bradley	10/100 Mbps Ethernet communications; copper
PLC-3-1	PLC Discrete Input Module		3	1756-IA16	Allen Bradley	120V ac; 16 points
PLC-3-1	PLC Discrete Output Module		1	1756-OW16I	Allen Bradley	16 normally open, individually isolated outputs
PLC-3-1	PLC Analog Input Module		3	1756-IF6I	Allen Bradley	6 individually isolated inputs; 4-20 mA
PLC-3-1	PLC Analog Output Module		1	1756-OF6CI	Allen Bradley	6 individually isolated outputs; 4-20mA current
PLC-3-1	PLC Blank Slot Filler		3	1756-N2	Allen Bradley	
PLC-3-1	PLC Terminal Block		As Req'd - 2 minimum	1756-TBCH	Allen Bradley	For discrete output module
PLC-3-1	PLC Terminal Block		As Req'd - 8 minimum	1756-TBNH	Allen Bradley	For discrete input, analog input, analog output modules
OIU-1	Panel Mount HMI		1	2711P-T10C22A9P-B	Allen Bradley	PanelView Plus 7 Touchscreen, color, 10.4-inch, Two ports, 120 VAC input
OIU-1	HMI SD Card		1	1784-SD2	Allen Bradley	2 GB SD Memory Card
UPS-1	Uninterruptible Power Supply		1	SSG3K-1T UA88376-SSG-HW	Falcon	UL508 listed, industrial rated UPS. Rated for minus 4 to 131 degrees Fahrenheit; hot swappable batteries; 3000Kva/2100Watts; 12 year battery life rating; 120V ac input Provide dry relay signal interface module.
BYP-1	External Maintenance Switch		1	MB3K-1T	Falcon	Provide two spare batteries (two for each UPS provided). 120V ac input; UL508 and UL1778 listed
UPS-2	Uninterruptible Power Supply		1	SSG3K-1T UA88376-SSG-HW	Falcon	UL508 listed, industrial rated UPS. Rated for minus 4 to 131 degrees Fahrenheit; hot swappable batteries; 3000Kva/2100Watts; 12 year battery life rating; 120V ac input Provide dry relay signal interface module.
BYP-2	External Maintenance Switch		1	MB3K-1T	Falcon	Provide two spare batteries (two for each UPS provided). 120V ac input; UL508 and UL1778 listed
TJB-1 Effluent Pump Network TJB						
	Ethernet Switch		1	1783-BMS06SL	Allen Bradley	Stratix 5700 switch, managed, (4) 100BASE-T copper & (2) 100BASE-FX fiber SFP slots, lite software
	Power Supply		1	1606-XLP15E	Allen Bradley	Compact 24V dc power supply, 120V ac input
	Uninterruptible Power Supply		1	1606-XLS240-UPS	Allen Bradley	240W UPS
	UPS Battery Assembly		1	1606-XLSBATASSY1	Allen Bradley	7.5Ah Battery Assembly with mounting bracket
	Industrial Zone Enclosure		1	IAZ2424C	Panduit	Fully pre-configured industrial automation enclosure with pre-configured backplane, cable management, and high voltage isolation barrier.

CONTROL PANEL SCHEDULE

DWG	TAG	PANEL DESCRIPTION	NEMA Rating	SIZE (H x W x D)	Options (See P&IDs for Options, unless otherwise noted.)
008-N-601 008-N-602 FP-3-1		Effluent Pump Station PLC Control Panel	12	72" x 60" x 24"	Painted gray steel; dual door; front access Reference 40 90 01 for additional control panel requirements

INSTRUMENT CALIBRATION SHEET

COMPONENT				MANUFACTURER				PROJECT			
Code:		Name:		Number:		Name:		Name:		Name:	
Name:		Model:		Serial #:							
FUNCTIONS											
Indicate? Y / N		RANGE		VALUE		UNITS		COMPUTING FUNCTIONS? Y / N			
		Chart:						Describe:			
Record? Y / N		Scale:									
Transmit/ Convert? Y / N		Input:									
		Output:									
				ANALOG CALIBRATIONS				DISCRETE CALIBRATIONS			
REQUIRED		AS CALIBRATED		REQUIRED		AS CALIBRATED		REQUIRED		AS CALIBRATED	
Input	Indicated	Output	Increasing	Decreasing	Indicated	Output	Input	Reset Pt.	Reset Pt.	Reset Pt.	Note
			Indicated	Indicated	Output	Output		(note rising or falling)	(note rising or falling)		No.
							1.				
							2.				
							3.				
							4.				
							5.				
							6.				
							7.				
CONTROL MODE SETTINGS:		P:	I:	D:							
#	NOTES:										
	Component Calibrated and Ready for Startup										
	By:										
	Date:										
	Tag No.:										

**CH2M HILL INSTRUMENT CALIBRATION SHEET
EXAMPLE - ANALYZER/TRANSMITTER**

Rev.06.05.92

COMPONENT			MANUFACTURER			PROJECT			
Code: A7			Name: Leeds & Northrup			Number: WDC30715.B2			
Name: pH Element & Analyzer/Transmitter			Model: I2429-3-2-1-7			Name: UCOSA AWT PHASE 3			
			Serial #: I1553322						
FUNCTIONS									
Indicate? Y Record? N	RANGE	VALUE	UNITS	COMPUTING FUNCTIONS? N			CONTROL? N		
	Chart:			Describe:			Action? direct / reverse Modes? P / I / D		
Transmit/ Convert? Y	Scale:	I-14	pH units				SWITCH? N		
	Input:	I-14	pH units				Unit Range:		
	Output:	4-20	mA dc				Differential: fixed/adjustable		
				ANALOG CALIBRATIONS		DISCRETE CALIBRATIONS			
Input	REQUIRED Indicated	AS CALIBRATED		Number	REQUIRED		AS CALIBRATED		Note No.
		Increasing Input Indicated	Decreasing Input Indicated		Trip Point	Reset Pt.	Trip Point	Reset Pt.	
1.0	1.0	4.0	4.0	1.	N.A.				
2.3	2.3	5.6	5.5	2.					I.
7.5	7.5	12.0	11.9	3.					
12.7	12.7	18.4	18.3	4.					
14.0	14.0	20.0	20.0	5.					
				6.					
				7.					
CONTROL MODE SETTINGS:			P: N.A.	I:	D:				
#	NOTES:								
	1. Need to recheck low pH calibration solutions.								
Component Calibrated and Ready for Startup									
By: J.D. Sewell									
Date: Jun-6-92									
Tag No.: AIT-12-6[pH]									

CH2M HILL

PERFORMANCE ACCEPTANCE TEST SHEET

Rev.06.05.92

Project Name:		Project No.:	
Demonstration Test(s): For each functional requirement of the loop:			
(a) List and number the requirement. (b) Briefly describe the demonstration test.			
(c) Cite the results that will verify the required performance. (d) Provide space for signoff.			
Forms/Sheets Verified	By	Date	Loop Accepted By Owner
Loop Status Report			By:
Instrument Calibration Sheet			Date:
I&C Valve Calibration Sheet			
Performance Acceptance Test	By	Date	
Performed			
Witnessed			Loop No.:

**CH2M HILL PERFORMANCE ACCEPTANCE TEST SHEET
EXAMPLE**

Project Name: <i>SFO SEWPCP Plant Expansion</i>		Project No.: <i>SFO12345.C1</i>	
Demonstration Test(s): For each functional requirement of the loop: (a) List and number the requirement. (b) Briefly describe the demonstration test. (c) Cite the results that will verify the required performance. (d) Provide space for signoff.			
<i>1. MEASURE EFFLUENT FLOW</i>			
<i>1.a With no flow, water level over weir should be zero and</i>			
<i>FIT indicator should read zero.</i>		<i>Jun-20-92 BDG</i>	
<i>2. FLOW INDICATION AND TRANSMISSION TO LP & CCS</i>			
<i>With flow, water level and FIT indicator should be related by expression</i>			
$Q(\text{MGD}) = 429 \cdot H^{2/3}$ (<i>H</i> = height in inches of water over weir).			
<i>Vary H and observe that following.</i>			
<i>2.a Reading of FIT indicator.</i>		<i>Jun-6-92 BDG</i>	
<i>2.b Reading is transmitted to FI on LP-521-1.</i>		<i>Jun-6-92 BDG</i>	
<i>2.c Reading is transmitted and displayed to CCS.</i>		<i>Jun-6-92 BDG</i>	
<i>H(measured) 0 5 10 15</i>			
<i>Q(computed) 0 47.96 135.7 251.7</i>			
<i>Q(FIT indicator) 0 48.1 137 253</i>			
<i>Q(LI on LP-521-1) 0 48.2 138 254</i>			
<i>Q(display by CCS) 0 48.1 136.2 252.4</i>			
Forms/Sheets Verified		By	Date
Loop Status Report		<i>J.D. Sewell</i>	<i>May-18-92</i>
Instrument Calibration Sheet		<i>J.D. Sewell</i>	<i>May-18-92</i>
I&C Valve Calibration Sheet		<i>N.A.</i>	
Performance Acceptance Test		By	Date
Performed		<i>J. Blow MPSDC Co.</i>	<i>Jun-6-92</i>
Witnessed		<i>B.deGlanville</i>	<i>Jun-6-92</i>
			Loop No.: <i>30-12</i>

PART 4

DRAWINGS

A	ABDN	AC	AC	ACJ	ACST	ACU	AD	ADD	AFD	AFF	AG	AGGR	AHR	AISC	AL (ALUM)	ALKY	ALTN, (ALT)	AM	ANDZ	APPROX	APVD	ARCH	AR	ARV	ASU	ATS	AUTO	AUX	AVG	AVRV	@	B	(B)	BAL	B.C.R.	BD	BF	BFV	BH	BL	BFP	BLDG	BLK	BM	BM	B.O.S.	BOT, (BOTT), B/	BRG	BSP	BV	BVC	C	°C	C-C	CAB	CAR	CATV	CB, C.B.	CB	CC	CCP	CCS	CFM	CHAN, C	CHDPE	CHEM	CI	CIP	CIPS	CJ	CKT	CL	CLD	C.L.F.	CLG	CLO	CLR	CL2	CMP, C.M.P.	CMU	CO	COL	CONC	CONDN	CONN	CONST	CONT	CONTR	COORD	CP	CP-X	CPLG	CPRSR	CPT	CPVC	CR	CRS	CRS	CS	CSATC	CT	CT	CTR	CTR'D	CTSK	CU	CU FT	CU IN	CU YD	CUH	CV	CWR	D	D	DAS	DBA	DBL	DC	DEG	DET	DF	DFM	DHEC	DDI	DI	DIA, O	DIAG	DIP, D.I.P.	DIR	DISCH	DOL	DR	DS	DWG	DWN	E	E	EA	ECC	EE	EF	EF	EFF	EL, ELEV	ELB	EIFS	ELC	ELEC	ENGR	EOG	EOP	E.O.W.	EP	EP	EQ	EQ SP	EQPT, (EQUIP)	ETM	EVC	EW	EXH	EXP	EXP	EXP AB	EXP JT	EX, EXST, (EXIST)	EXT	°F	F, FU	FAI	FC	FCA	FCL2	FCO	FCTY	FD	FDN	FDR	FEXT	FF	FG	FHY	FIG	FL	FLG	FL (FLR)	FLOOR	FLEX	FLH	FLTR	FLOOR	FNSH	FP	FPS	FP-W-X	FR	FRP	FSHS	FT	FTG	FU	FVNR	FVR	FWD	G, GND	GA	GAL	GALV	GB	GC	GFI	GFR	GL	GPD	GPH	GPM	GRTG	GR	GSP	GV	GVL	GWB	GYP	H	HAS	HB	HC	HD	H.D.P.E.	HDR	HDW	HESR	HGL	HGT	HH	HID	HK	HM	HOA	HOR	HORIZ	HP	H.P.	HPS	HR	HRDN	HSS	HV	HVAC	HW	HWL	IC	ID	IE, I.E.	IF	IG	IN	INCAND	INJS	INST	INSTM	INSUL	INV	IP	IRRIG	ITG	IU	IW	J, JB	JAN	JCT	JT	K	KIP	KIT	KSK	KV	KVA	KVAR	KW	L	L	LA	LAB	LAM	LAT	LAV	LB	LB	LB/CU FT	LC	LF	LG	LH	LHR	LLH	LLV	LNTL	LONG	LOS	LP	L.P.	LR	LR	LR	LS	LTG	LT	LWL	LYRS	M&BH	MA	MAS	MATL	MAX	MB	MC	MC	MCC	MECH	MET	MFD	MFR	MGD	MH	MIN	MIR	MISC	MJ	MLO	MMP	M.O.	MP	MPU	MTD	MTS	MTS	MV	MWS	N	N/A	N/C	N/O	N, NEUT	NA	ND	NGS STA	R/W	NO, #	NP	NPT	NS	NTS	O TO O	OA	OC	OC	OCA	OCR	OD	OF	OHW	OL	OO	OOA	OOR	OP	OPER	OPNG	O.R.B.	OSC	OSD	OZ	P	PAV	P.B.	PB	PC	PC	PE	PED	PEP	PF	PG	PH	PI	PJF	PL	PL	PLAS	PLC	PLC-X	PLYWD	PNL	PP	PPL	PRCST	PREFAB	PRES	PRI	PRM	PROJ	PROP	PS	PSF	PSI	PSIG	PT	PT	PTAC	PTD	PV	PVC, P.V.C.	PVI	PVMT	PVT	QT	R (RAD)	RC	RCP, R.C.P.	RCPT	RD	RD	RDCR	RDW	R.E.	REF	REF	REFR	REINF	REQD	RG	RH	RH	RHR	RJ	RL	RLS	RM	ROL	RPM	RS	RST	RTN	RT	RRUB	R/W	RW	S	S	S	S	S	SATC	SC	SCBA	SCC	SCFM	SCH	SCR	SCU	SD	SDMH, S.D.M.H.	SDWK	SDR	SEC	SECT	SED	SEW	SF	SF	SG	SGWB	SH	SH (SHT)	SHA	SHS	SIM	SMH	SOLN	SP	SPA	SPEC, SPECS	SPEC'D.	SPLY	SQ	SQ FT	SQ IN	SR	SS	SS, SST	SSH	SSK	S.S.M.H.	STA	STD	STM	STIF	STIRR	STL	ST	STRUL	STRUCT	SUSP	SV	SYMM	T	T&B	T&G	T/	TAN	TB	TB	TBG	TC	TCAE	TCL2	TDH	TDR	TECH	TEL	TEMP	TF	TFG	THD	THK	THRU	TJB	TL	TO	TOAD	TOAE	T.O.P.	TP	TRANS	TRANSV	TDR	TS	TTD	TU-X	TURB	TYP	U ON	UBC	UH	UR	UVR	V	V	V	V	VB	VC	VCP	VDR	VERT	VIB	VP	VPC	VPI	VPS	VPT	VT	VTR	W	W	W	W	W	WC	WD	WG	WH	WH	WHD	WP	WP	WR	WS	WS	WS	WT	WTP	WTR	WU	WWTP	X	Y	Z	AA	BB	CC	DD	EE	FF	GG	HH	II	JJ	KK	LL	MM	NN	OO	PP	QQ	RR	SS	TT	UU	VV	WW	XX	YY	ZZ	AAA	BBB	CCC	DDD	EEE	FFF	GGG	HHH	III	JJJ	KKK	LLL	MMM	NNN	OOO	PPP	QQQ	RRR	SSS	TTT	UUU	VVV	WWW	XXX	YYY	ZZZ	AAAA	BBBB	CCCC	DDDD	EEEE	FFFF	GGGG	HHHH	IIII	JJJJ	KKKK	LLLL	MMMM	NNNN	OOOO	PPPP	QQQQ	RRRR	SSSS	TTTT	UUUU	VVVV	WWWW	XXXX	YYYY	ZZZZ	AAAAA	BBBBB	CCCCC	DDDDD	EEEEE	FFFFF	GGGGG	HHHHH	IIIII	JJJJJ	KKKKK	LLLLL	MMMMM	NNNNN	OOOOO	PPPPP	QQQQQ	RRRRR	SSSSS	TTTTT	UUUUU	VVVVV	WWWWW	XXXXX	YYYYY	ZZZZZ	AAAAAA	BBBBBB	CCCCCC	DDDDDD	EEEEEE	FFFFFF	GGGGGG	HHHHHH	IIIIII	JJJJJJ	KKKKKK	LLLLLL	MMMMMM	NNNNNN	OOOOOO	PPPPPP	QQQQQQ	RRRRRR	SSSSSS	TTTTTT	UUUUUU	VVVVVV	WWWWWW	XXXXXXXX	YYYYYY	ZZZZZZ	AAAAAAA	BBBBBBB	CCCCCCC	DDDDDDD	EEEEEEE	FFFFFFF	GGGGGGG	HHHHHHH	IIIIIII	JJJJJJJ	KKKKKKK	LLLLLLL	MMMMMMM	NNNNNNN	OOOOOOO	PPPPPPP	QQQQQQQ	RRRRRRR	SSSSSSS	TTTTTTT	UUUUUUU	VVVVVVV	WWWWWWW	XXXXXXXXX	YYYYYYY	ZZZZZZZ	AAAAAAA	BBBBBBB	CCCCCCC	DDDDDDD	EEEEEEE	FFFFFFF	GGGGGGG	HHHHHHH	IIIIIII	JJJJJJJ	KKKKKKK	LLLLLLL	MMMMMMM	NNNNNNN	OOOOOOO	PPPPPPP	QQQQQQQ	RRRRRRR	SSSSSSS	TTTTTTT	UUUUUUU	VVVVVVV	WWWWWWW	XXXXXXXXX	YYYYYYY	ZZZZZZZ	AAAAAAA	BBBBBBB	CCCCCCC	DDDDDDD	EEEEEEE	FFFFFFF	GGGGGGG	HHHHHHH	IIIIIII	JJJJJJJ	KKKKKKK	LLLLLLL	MMMMMMM	NNNNNNN	OOOOOOO	PPPPPPP	QQQQQQQ	RRRRRRR	SSSSSSS	TTTTTTT	UUUUUUU	VVVVVVV	WWWWWWW	XXXXXXXXX	YYYYYYY	ZZZZZZZ	AAAAAAA	BBBBBBB	CCCCCCC	DDDDDDD	EEEEEEE	FFFFFFF	GGGGGGG	HHHHHHH	IIIIIII	JJJJJJJ	KKKKKKK	LLLLLLL	MMMMMMM	NNNNNNN	OOOOOOO	PPPPPPP	QQQQQQQ	RRRRRRR	SSSSSSS	TTTTTTT	UUUUUUU	VVVVVVV	WWWWWWW	XXXXXXXXX	YYYYYYY	ZZZZZZZ	AAAAAAA	BBBBBBB	CCCCCCC	DDDDDDD	EEEEEEE	FFFFFFF	GGGGGGG	HHHHHHH	IIIIIII	JJJJJJJ	KKKKKKK	LLLLLLL	MMMMMMM	NNNNNNN	OOOOOOO	PPPPPPP	QQQQQQQ	RRRRRRR	SSSSSSS	TTTTTTT	UUUUUUU	VVVVVVV	WWWWWWW	XXXXXXXXX	YYYYYYY	ZZZZZZZ	AAAAAAA	BBBBBBB	CCCCCCC	DDDDDDD	EEEEEEE	FFFFFFF	GGGGGGG	HHHHHHH	IIIIIII	JJJJJJJ	KKKKKKK	LLLLLLL	MMMMMMM	NNNNNNN	OOOOOOO	PPPPPPP	QQQQQQQ	RRRRRRR	SSSSSSS	TTTTTTT	UUUUUUU	VVVVVVV	WWWWWWW	XXXXXXXXX	YYYYYYY	ZZZZZZZ	AAAAAAA	BBBBBBB	CCCCCCC	DDDDDDD	EEEEEEE	FFFFFFF	GGGGGGG	HHHHHHH	IIIIIII	JJJJJJJ	KKKKKKK	LLLLLLL	MMMMMMM	NNNNNNN	OOOOOOO	PPPPPPP	QQQQQQQ	RRRRRRR	SSSSSSS	TTTTTTT	UUUUUUU	VVVVVVV	WWWWWWW	XXXXXXXXX	YYYYYYY	ZZZZZZZ	AAAAAAA	BBBBBBB	CCCCCCC	DDDDDDD	EEEEEEE	FFFFFFF	GGGGGGG	HHHHHHH	IIIIIII	JJJJJJJ	KKKKKKK	LLLLLLL	MMMMMMM	NNNNNNN	OOOOOOO	PPPPPPP	QQQQQQQ	RRRRRRR	SSSSSSS	TTTTTTT	UUUUUUU	VVVVVVV	WWWWWWW	XXXXXXXXX	YYYYYYY	ZZZZZZZ	AAAAAAA	BBBBBBB	CCCCCCC	DDDDDDD	EEEEEEE	FFFFFFF	GGGGGGG	HHHHHHH	IIIIIII	JJJJJJJ	KKKKKKK	LLLLLLL	MMMMMMM	NNNNNNN	OOOOOOO	PPPPPPP	QQQQQQQ	RRRRRRR	SSSSSSS	TTTTTTT	UUUUUUU	VVVVVVV	WWWWWWW	XXXXXXXXX	YYYYYYY	ZZZZZZZ	AAAAAAA	BBBBBBB	CCCCCCC	DDDDDDD	EEEEEEE	FFFFFFF	GGGGGGG	HHHHHHH	IIIIIII	JJJJJJJ	KKKKKKK	LLLLLLL	MMMMMMM	NNNNNNN	OOOOOOO	PPPPPPP	QQQQQQQ	RRRRRRR	SSSSSSS	TTTTTTT	UUUUUUU	VVVVVVV	WWWWWWW	XXXXXXXXX	YYYYYYY	ZZZZZZZ	AAAAAAA	BBBBBBB	CCCCCCC	DDDDDDD	EEEEEEE	FFFFFFF	GGGGGGG	HHHHHHH	IIIIIII	JJJJJJJ	KKKKKKK	LLLLLLL	MMMMMMM	NNNNNNN	OOOOOOO	PPPPPPP	QQQQQQQ	RRRRRRR	SSSSSSS	TTTTTTT	UUUUUUU	VVVVVVV	WWWWWWW	XXXXXXXXX	YYYYYYY	ZZZZZZZ	AAAAAAA	BBBBBBB	CCCCCCC	DDDDDDD	EEEEEEE	FFFFFFF	GGGGGGG	HHHHHHH	IIIIIII	JJJJJJJ	KKKKKKK	LLLLLLL	MMMMMMM	NNNNNNN	OOOOOOO	PPPPPPP	QQQQQQQ	RRRRRRR	SSSSSSS	TTTTTTT	UUUUUUU	VVVVVVV	WWWWWWW	XXXXXXXXX	YYYYYYY	ZZZZZZZ	AAAAAAA	BBBBBBB	CCCCCCC	DDDDDDD	EEEEEEE	FFFFFFF	GGGGGGG	HHHHHHH	IIIIIII	JJJJJJJ	KKKKKKK	LLLLLLL	MMMMMMM	NNNNNNN	OOOOOOO	PPPPPPP	QQQQQQQ	RRRRRRR	SSSSSSS	TTTTTTT	UUUUUUU	VVVVVVV	WWWWWWW	XXXXXXXXX	YYYYYYY	ZZZZZZZ	AAAAAAA	BBBBBBB	CCCCCCC	DDDDDDD	EEEEEEE	FFFFFFF	GGGGGGG	HHHHHHH	IIIIIII	JJJJJJJ	KKKKKKK	LLLLLLL	MMMMMMM	NNNNNNN	OOOOOOO	PPPPPPP	QQQQQQQ	RRRRRRR	SSSSSSS	TTTTTTT	UUUUUUU	VVVVVVV	WWWWWWW	XXXXXXXXX	YYYYYYY	ZZZZZZZ	AAAAAAA	BBBBBBB	CCCCCCC	DDDDDDD	EEEEEEE	FFFFFFF	GGGGGGG	HHHHHHH	IIIIIII	JJJJJJJ	KKKKKKK	LLLLLLL	MMMMMMM	NNNNNNN	OOOOOOO	PPPPPPP	QQQQQQQ	RRRRRRR	SSSSSSS	TTTTTTT	UUUUUUU	VVVVVVV	WWWWWWW	XXXXXXXXX	YYYYYYY	ZZZZZZZ	AAAAAAA	BBBBBBB	CCCCCCC	DDDDDDD	EEEEEEE	FFFFFFF	GGGGGGG	HHHHHHH	IIIIIII	JJJJJJJ	KKKKKKK	LLLLLLL	MMMMMMM	NNNNNNN	OOOOOOO	PPPPPPP	QQQQQQQ	RRRRRRR	SSSSSSS	TTTTTTT	UUUUUUU	VVVVVVV	WWWWWWW	XXXXXXXXX	YYYYYYY	ZZZZZZZ	AAAAAAA	BBBBBBB	CCCCCCC	DDDDDDD	EEEEEEE	FFFFFFF	GGGGGGG	HHHHHHH	IIIIIII	JJJJJJJ	KKKKKKK	LLLLLLL	MMMMMMM	NNNNNNN	OOOOOOO	PPPPPPP	QQQQQQQ	RRRRRRR	SSSSSSS	TTTTTTT	UUUUUUU	VVVVVVV	WWWWWWW	XXXXXXXXX	YYYYYYY	ZZZZZZZ	AAAAAAA	BBBBBBB	CCCCCCC	DDDDDDD	EEEEEEE	FFFFFFF	GGGGGGG	HHHHHHH	IIIIIII	JJJJJJJ	KKKKKKK	LLLLLLL	MMMMMMM	NNNNNNN	OOOOOOO	PPPPPPP	QQQQQQQ	RRRRRRR	SSSSSSS	TTTTTTT	UUUUUUU	VVVVVVV	WWWWWWW	XXXXXXXXX	YYYYYYY	ZZZZZZZ	AAAAAAA	BBBBBBB	CCCCCCC	DDDDDDD	EEEEEEE	FFFFFFF	GGGGGGG	HHHHHHH	IIIIIII	JJJJJJJ	KKKKKKK	LLLLLLL	MMMMMMM	NNNNNNN	OOOOOOO	PPPPPPP	QQQQQQQ	RRRRRRR	SSSSSSS	TTTTTTT	UUUUUUU	VVVVVVV	WWWWWWW	XXXXXXXXX	YYYYYYY	ZZZZZZZ	AAAAAAA	BBBBBBB	CCCCCCC	DDDDDDD	EEEEEEE	FFFFFFF	GGGGGGG	HHHHHHH	IIIIIII	JJJJJJJ	KKKKKKK	LLLLLLL	MMMMMMM	NNNNNNN	OOOOOOO	PPPPPPP	QQQQQQQ	RRRRRRR	SSSSSSS	TTTTTTT	UUUUUUU	VVVVVVV	WWWWWWW	XXXXXXXXX	YYYYYYY	ZZZZZZZ	AAAAAAA	BBBBBBB	CCCCCCC	DDDDDDD	EEEEEEE	FFFFFFF	GGGGGGG	HHHHHHH	IIIIIII	JJJJJJJ	KKKKKKK	LLLLLLL	MMMMMMM	NNNNNNN	OOOOOOO	PPPPPPP	QQQQQQQ	RRRRRRR	SSSSSSS	TTTTTTT	UUUUUUU	VVVVVVV	WWWWWWW	XXXXXXXXX	YYYYYYY	ZZZZZZZ	AAAAAAA	BBBBBBB	CCCCCCC	DDDDDDD	EEEEEEE	FFFFFFF	GGGGGGG	HHHHHHH	IIIIIII	JJJJJJJ	KKKKKKK	LLLLLLL	MMMMMMM	NNNNNNN	OOOOOOO	PPPPPPP	QQQQQQQ	RRRRRRR	SSSSSSS	TTTTTTT	UUUUUUU	VVVVVVV	WWWWWWW	XXXXXXXXX	YYYYYYY	ZZZZZZZ	AAAAAAA	BBBBBBB	CCCCCCC	DDDDDDD	EEEEEEE	FFFFFFF	GGGGGGG	HHHHHHH	IIIIIII	JJJJJJJ	KKKKKKK	LLLLLLL	MMMMMMM	NNNNNNN	OOOOOOO	PPPPPPP	QQQQQQQ	RRRRRRR	SSSSSSS	TTTTTTT	UUUUUUU	VVVVVVV	WWWWWWW	XXXXXXXXX	YYYYYYY	ZZZZZZZ	AAAAAAA	BBBBBBB	CCCCCCC	DDDDDDD	EEEEEEE	FFFFFFF	GGGGGGG	HHHHHHH	IIIIIII	JJJJJJJ	KKKKKKK	LLLLLLL	MMMMMMM	NNNNNNN	OOOOOOO	PPPPPPP	QQQQQQQ	RRRRRRR	SSSSSSS	TTTTTTT	UUUUUUU	VVVVVVV	WWWWWWW	XXXXXXXXX	YYYYYYY	ZZZZZZZ	AAAAAAA	BBBBBBB	CCCCCCC	DDDDDDD	EEEEEEE	FFFFFFF	GGGGGGG	HHHHHHH	IIIIIII	JJJJJJJ	KKKKKKK	LLLLLLL	MMMMMMM	NNNNNNN	OOOOOOO	PPPPPPP	QQQQQQQ	RRRRRRR	SSSSSSS	TTTTTTT	UUUUUUU	VVVVVVV	WWWWWWW	XXXXXXXXX	YYYYYYY	ZZZZZZZ	AAAAAAA	BBBBBBB	CCCCCCC	DDDDDDD	EEEEEEE	FFFFFFF	GGGGGGG	HHHHHHH	IIIIIII	JJJJJJJ	KKKKKKK	LLLLLLL	MMMMMMM	NNNNNNN	OOOOOOO	PPPPPPP	QQQQQQQ	RRRRRRR	SSSSSSS	TTTTTTT	UUUUUUU	VVVVVVV	WWWWWWW	XXXXXXXXX	YYYYYYY	ZZZZZZZ	AAAAAAA	BBBBBBB	CCCCCCC	DDDDDDD	EEEEEEE	FFFFFFF	GGGGGGG	HHHHHHH	IIIIIII	JJJJJJJ	KKKKKKK	LLLLLLL	MMMMMMM	NNNNNNN	OOOOOOO	PPPPPPP	QQQQQQQ	RRRRRRR	SSSSSSS	TTTTTTT	UUUUUUU	VVVVVVV	WWWWWWW	XXXXXXXXX	YYYYYYY	ZZZZZZZ	AAAAAAA	BBBBBBB	CCCCCCC	DDDDDDD	EEEEEEE	FFFFFFF	GGGGGGG	HHHHHHH	IIIIIII	JJJJJJJ	KKKKKKK	LLLLLLL	MMMMMMM	NNNNNNN	OOOOOOO	PPPPPPP	QQQQQQQ	RRRRRRR	SSSSSSS	TTTTTTT	UUUUUUU	VVVVVVV	WWWWWWW	XXXXXXXXX	YYYYYYY	ZZZZZZZ	AAAAAAA	BBBBBBB	CCCCCCC	DDDDDDD	EEEEEEE	FFFFFFF	GGGGGGG	HHHHHHH	IIIIIII	JJJJJJJ	KKKKKKK	LLLLLLL	MMMMMMM	NNNNNNN	OOOOOOO	PPPPPPP	QQQQQQQ	RRRRRRR	SSSSSSS	TTTTTTT	UUUUUUU	VVVVVVV	WWWWWWW	XXXXXXXXX	YYYYYYY	ZZZZZZZ	AAAAAAA	BBBBBBB	CCCCCCC	DDDDDDD	EEEEEEE	FFFFFFF	GGGGGGG	HHHHHHH	IIIIIII	JJJJJJJ	KKKKKKK	LLLLLLL	MMMMMMM	NNNNNNN	OOOOOOO	PPPPPPP	QQQQQQQ	RRRRRRR	SSSSSSS	TTTTTTT	UUUUUUU	VVVVVVV	WWWWWWW	XXXXXXXXX	YYYYYYY	ZZZZZZZ	AAAAAAA	BBBBBBB	CCCCCCC	DDDDDDD	EEEEEEE	FFFFFFF	GGGGGGG	HHHHHHH	IIIIIII	JJJJJJJ	KKKKKKK	LLLLLLL	MMMMMMM	NNNNNNN	OOOOOOO	PPPPPPP	QQQQQQQ	RRRRRRR	SSSSSSS	TTTTTTT	UUUUUUU	VVVVVVV	WWWWWWW	XXXXXXXXX	YYYYYYY	ZZZZZZZ	AAAAAAA	BBBBBBB	CCCCCCC	DDDDDDD	EEEEEEE	FFFFFFF	GGGGGGG	HHHHHHH	IIIIIII	JJJJJJJ	KKKKKKK	LLLLLLL	MMMMMMM	NNNNNNN	OOOOOOO	PPPPPPP	QQQQQQQ	RRRRRRR	SSSSSSS	TTTTTTT	UUUUUUU	VVVVVVV	WWWWWWW	XXXXXXXXX	YYYYYYY	ZZZZZZZ	AAAAAAA	BBBBBBB	CCCCCCC	DDDDDDD	EEEEEEE	FFFFFFF	GGGGGGG	HHHHHHH	IIIIIII	JJJJJJJ	KKKKKKK	LLLLLLL	MMMMMMM	NNNNNNN	OOOOOOO	PPPPPPP	QQQQQQQ	RRRRRRR	SSSSSSS	TTTTTTT	UUUUUUU	VVVVVVV	WWWWWWW	XXXXXXXXX	YYYYYYY	ZZZZZZZ	AAAAAAA	BBBBBBB	CCCCCCC	DDDDDDD	EEEEEEE	FFFFFFF	GGGGGGG	HHHHHHH	IIIIIII	JJJJJJJ	KKKKKKK	LLLLLLL	MMMMMMM	NNNNNNN	OOOOOOO	PPPPPPP	QQQQQQQ	RRRRRRR	SSSSSSS	TTTTTTT	UUUUUUU	VVVVVVV	WWWWWWW	XXXXXXXXX	YYYYYYY	ZZZZZZZ	AAAAAAA	BBBBBBB	CCCCCCC	DDDDDDD	EEEEEEE	FFFFFFF	GGGGGGG	HHHHHHH	IIIIIII	JJJJJJJ	KKKKKKK	LLLLLLL	MMMMMMM	NNNNNNN	OOOOOOO	PPPPPPP	QQQQQQQ	RRRRRRR	SSSSSSS	TTTTTTT	UUUUUUU	VVVVVVV	WWWWWWW	XXXXXXXXX	YYYYYYY	ZZZZZZZ	AAAAAAA	BBBBBBB	CCCCCCC	DDDDDDD	EEEEEEE	FFFFFFF	GGGGGGG	HHHHHHH	IIIIIII	JJJJJJJ	KKKKKKK	LLLLLLL	MMMMMMM	NNNNNNN	OOOOOOO	PPPPPPP	QQQQQQQ	RRRRRRR	SSSSSSS	TTTTTTT	UUUUUUU	VVVVVVV	WWWWWWW	XXXXXXXXX	YYYYYYY	ZZZZZZZ	AAAAAAA	BBBBBBB	CCCCCCC	DDDDDDD	EEEEEEE	FFFFFFF	GGGGGGG	HHHHHHH	IIIIIII	JJJJJJJ	KKKKKKK	LLLLLLL	MMMMMMM	NNNNNNN	OOOOOOO	PPPPPPP	QQQQQQQ	RR
---	------	----	----	-----	------	-----	----	-----	-----	-----	----	------	-----	------	-----------	------	-------------	----	------	--------	------	------	----	-----	-----	-----	------	-----	-----	------	---	---	-----	-----	--------	----	----	-----	----	----	-----	------	-----	----	----	--------	-----------------	-----	-----	----	-----	---	----	-----	-----	-----	------	----------	----	----	-----	-----	-----	---------	-------	------	----	-----	------	----	-----	----	-----	--------	-----	-----	-----	-----	-------------	-----	----	-----	------	-------	------	-------	------	-------	-------	----	------	------	-------	-----	------	----	-----	-----	----	-------	----	----	-----	-------	------	----	-------	-------	-------	-----	----	-----	---	---	-----	-----	-----	----	-----	-----	----	-----	------	-----	----	--------	------	-------------	-----	-------	-----	----	----	-----	-----	---	---	----	-----	----	----	----	-----	----------	-----	------	-----	------	------	-----	-----	--------	----	----	----	-------	---------------	-----	-----	----	-----	-----	-----	--------	--------	-------------------	-----	----	-------	-----	----	-----	------	-----	------	----	-----	-----	------	----	----	-----	-----	----	-----	----------	-------	------	-----	------	-------	------	----	-----	--------	----	-----	------	----	-----	----	------	-----	-----	--------	----	-----	------	----	----	-----	-----	----	-----	-----	-----	------	----	-----	----	-----	-----	-----	---	-----	----	----	----	----------	-----	-----	------	-----	-----	----	-----	----	----	-----	-----	-------	----	------	-----	----	------	-----	----	------	----	-----	----	----	----------	----	----	----	--------	------	------	-------	-------	-----	----	-------	-----	----	----	-------	-----	-----	----	---	-----	-----	-----	----	-----	------	----	---	---	----	-----	-----	-----	-----	----	----	----------	----	----	----	----	-----	-----	-----	------	------	-----	----	------	----	----	----	----	-----	----	-----	------	------	----	-----	------	-----	----	----	----	-----	------	-----	-----	-----	-----	----	-----	-----	------	----	-----	-----	------	----	-----	-----	-----	-----	----	-----	---	-----	-----	-----	---------	----	----	---------	-----	-------	----	-----	----	-----	--------	----	----	----	-----	-----	----	----	-----	----	----	-----	-----	----	------	------	--------	-----	-----	----	---	-----	------	----	----	----	----	-----	-----	----	----	----	----	-----	----	----	------	-----	-------	-------	-----	----	-----	-------	--------	------	-----	-----	------	------	----	-----	-----	------	----	----	------	-----	----	-------------	-----	------	-----	----	---------	----	-------------	------	----	----	------	-----	------	-----	-----	------	-------	------	----	----	----	-----	----	----	-----	----	-----	-----	----	-----	-----	----	------	-----	----	---	---	---	---	---	------	----	------	-----	------	-----	-----	-----	----	----------------	------	-----	-----	------	-----	-----	----	----	----	------	----	----------	-----	-----	-----	-----	------	----	-----	-------------	---------	------	----	-------	-------	----	----	---------	-----	-----	----------	-----	-----	-----	------	-------	-----	----	-------	--------	------	----	------	---	-----	-----	----	-----	----	----	-----	----	------	------	-----	-----	------	-----	------	----	-----	-----	-----	------	-----	----	----	------	------	--------	----	-------	--------	-----	----	-----	------	------	-----	------	-----	----	----	-----	---	---	---	---	----	----	-----	-----	------	-----	----	-----	-----	-----	-----	----	-----	---	---	---	---	---	----	----	----	----	----	-----	----	----	----	----	----	----	----	-----	-----	----	------	---	---	---	----	----	----	----	----	----	----	----	----	----	----	----	----	----	----	----	----	----	----	----	----	----	----	----	----	----	-----	-----	-----	-----	-----	-----	-----	-----	-----	-----	-----	-----	-----	-----	-----	-----	-----	-----	-----	-----	-----	-----	-----	-----	-----	-----	------	------	------	------	------	------	------	------	------	------	------	------	------	------	------	------	------	------	------	------	------	------	------	------	------	------	-------	-------	-------	-------	-------	-------	-------	-------	-------	-------	-------	-------	-------	-------	-------	-------	-------	-------	-------	-------	-------	-------	-------	-------	-------	-------	--------	--------	--------	--------	--------	--------	--------	--------	--------	--------	--------	--------	--------	--------	--------	--------	--------	--------	--------	--------	--------	--------	--------	----------	--------	--------	---------	---------	---------	---------	---------	---------	---------	---------	---------	---------	---------	---------	---------	---------	---------	---------	---------	---------	---------	---------	---------	---------	---------	-----------	---------	---------	---------	---------	---------	---------	---------	---------	---------	---------	---------	---------	---------	---------	---------	---------	---------	---------	---------	---------	---------	---------	---------	---------	---------	-----------	---------	---------	---------	---------	---------	---------	---------	---------	---------	---------	---------	---------	---------	---------	---------	---------	---------	---------	---------	---------	---------	---------	---------	---------	---------	-----------	---------	---------	---------	---------	---------	---------	---------	---------	---------	---------	---------	---------	---------	---------	---------	---------	---------	---------	---------	---------	---------	---------	---------	---------	---------	-----------	---------	---------	---------	---------	---------	---------	---------	---------	---------	---------	---------	---------	---------	---------	---------	---------	---------	---------	---------	---------	---------	---------	---------	---------	---------	-----------	---------	---------	---------	---------	---------	---------	---------	---------	---------	---------	---------	---------	---------	---------	---------	---------	---------	---------	---------	---------	---------	---------	---------	---------	---------	-----------	---------	---------	---------	---------	---------	---------	---------	---------	---------	---------	---------	---------	---------	---------	---------	---------	---------	---------	---------	---------	---------	---------	---------	---------	---------	-----------	---------	---------	---------	---------	---------	---------	---------	---------	---------	---------	---------	---------	---------	---------	---------	---------	---------	---------	---------	---------	---------	---------	---------	---------	---------	-----------	---------	---------	---------	---------	---------	---------	---------	---------	---------	---------	---------	---------	---------	---------	---------	---------	---------	---------	---------	---------	---------	---------	---------	---------	---------	-----------	---------	---------	---------	---------	---------	---------	---------	---------	---------	---------	---------	---------	---------	---------	---------	---------	---------	---------	---------	---------	---------	---------	---------	---------	---------	-----------	---------	---------	---------	---------	---------	---------	---------	---------	---------	---------	---------	---------	---------	---------	---------	---------	---------	---------	---------	---------	---------	---------	---------	---------	---------	-----------	---------	---------	---------	---------	---------	---------	---------	---------	---------	---------	---------	---------	---------	---------	---------	---------	---------	---------	---------	---------	---------	---------	---------	---------	---------	-----------	---------	---------	---------	---------	---------	---------	---------	---------	---------	---------	---------	---------	---------	---------	---------	---------	---------	---------	---------	---------	---------	---------	---------	---------	---------	-----------	---------	---------	---------	---------	---------	---------	---------	---------	---------	---------	---------	---------	---------	---------	---------	---------	---------	---------	---------	---------	---------	---------	---------	---------	---------	-----------	---------	---------	---------	---------	---------	---------	---------	---------	---------	---------	---------	---------	---------	---------	---------	---------	---------	---------	---------	---------	---------	---------	---------	---------	---------	-----------	---------	---------	---------	---------	---------	---------	---------	---------	---------	---------	---------	---------	---------	---------	---------	---------	---------	---------	---------	---------	---------	---------	---------	---------	---------	-----------	---------	---------	---------	---------	---------	---------	---------	---------	---------	---------	---------	---------	---------	---------	---------	---------	---------	---------	---------	---------	---------	---------	---------	---------	---------	-----------	---------	---------	---------	---------	---------	---------	---------	---------	---------	---------	---------	---------	---------	---------	---------	---------	---------	---------	---------	---------	---------	---------	---------	---------	---------	-----------	---------	---------	---------	---------	---------	---------	---------	---------	---------	---------	---------	---------	---------	---------	---------	---------	---------	---------	---------	---------	---------	---------	---------	---------	---------	-----------	---------	---------	---------	---------	---------	---------	---------	---------	---------	---------	---------	---------	---------	---------	---------	---------	---------	---------	---------	---------	---------	---------	---------	---------	---------	-----------	---------	---------	---------	---------	---------	---------	---------	---------	---------	---------	---------	---------	---------	---------	---------	---------	---------	---------	---------	---------	---------	---------	---------	---------	---------	-----------	---------	---------	---------	---------	---------	---------	---------	---------	---------	---------	---------	---------	---------	---------	---------	---------	---------	---------	---------	---------	---------	---------	---------	---------	---------	-----------	---------	---------	---------	---------	---------	---------	---------	---------	---------	---------	---------	---------	---------	---------	---------	---------	---------	---------	---------	---------	---------	---------	---------	---------	---------	-----------	---------	---------	---------	---------	---------	---------	---------	---------	---------	---------	---------	---------	---------	---------	---------	---------	---------	---------	---------	---------	---------	---------	---------	---------	---------	-----------	---------	---------	---------	---------	---------	---------	---------	---------	---------	---------	---------	---------	---------	---------	---------	---------	---------	---------	---------	---------	---------	---------	---------	---------	---------	-----------	---------	---------	---------	---------	---------	---------	---------	---------	---------	---------	---------	---------	---------	---------	---------	---------	---------	---------	---------	---------	---------	---------	---------	---------	---------	-----------	---------	---------	---------	---------	---------	---------	---------	---------	---------	---------	---------	---------	---------	---------	---------	---------	---------	---------	---------	---------	---------	---------	---------	---------	---------	-----------	---------	---------	---------	---------	---------	---------	---------	---------	---------	---------	---------	---------	---------	---------	---------	---------	---------	---------	---------	---------	---------	---------	---------	---------	---------	-----------	---------	---------	---------	---------	---------	---------	---------	---------	---------	---------	---------	---------	---------	---------	---------	---------	---------	---------	---------	---------	---------	---------	---------	---------	---------	-----------	---------	---------	---------	---------	---------	---------	---------	---------	---------	---------	---------	---------	---------	---------	---------	---------	---------	---------	---------	---------	---------	---------	---------	---------	---------	-----------	---------	---------	---------	---------	---------	---------	---------	---------	---------	---------	---------	---------	---------	---------	---------	---------	---------	---------	---------	---------	---------	---------	---------	---------	---------	-----------	---------	---------	---------	---------	---------	---------	---------	---------	---------	---------	---------	---------	---------	---------	---------	---------	---------	---------	---------	---------	---------	---------	---------	---------	---------	-----------	---------	---------	---------	---------	---------	---------	---------	---------	---------	---------	---------	---------	---------	---------	---------	---------	---------	---------	---------	---------	---------	---------	---------	---------	---------	-----------	---------	---------	---------	---------	---------	---------	---------	---------	---------	---------	---------	---------	---------	---------	---------	---------	---------	---------	---------	---------	---------	---------	---------	---------	---------	-----------	---------	---------	---------	---------	---------	---------	---------	---------	---------	---------	---------	---------	---------	---------	---------	---------	---------	---------	---------	---------	---------	---------	---------	---------	---------	-----------	---------	---------	---------	---------	---------	---------	---------	---------	---------	---------	---------	---------	---------	---------	---------	---------	---------	---------	---------	---------	---------	---------	---------	---------	---------	-----------	---------	---------	---------	---------	---------	---------	---------	---------	---------	---------	---------	---------	---------	---------	---------	---------	---------	---------	---------	----

SYMBOL	DESCRIPTION
ONE-LINE DIAGRAM	
	DRAWOUT AIR CIRCUIT BREAKER, LOW VOLTAGE
	CIRCUIT BREAKER, THERMAL MAGNETIC TRIP SHOWN, 3 POLE, UNO
	CIRCUIT BREAKER, STATIC TRIP UNIT, SENSOR AMP TRIP AND FRAME RATINGS SHOWN, 3 POLE, UNO
	CIRCUIT BREAKER, MAGNETIC TRIP ONLY, TRIP RATING SHOWN, 3 POLE, UNO
	CIRCUIT BREAKER WITH CURRENT LIMITING FUSES, TRIP AND FUSE RATING INDICATED, 3 POLE, UNO
	FUSED SWITCH, SWITCH AND FUSE CURRENT RATING INDICATED, 3 POLE, UNO
	SWITCH, CURRENT RATING INDICATED, 3 POLE, UNO
	FUSE, CURRENT RATING AND QUANTITY INDICATED
	MAGNETIC STARTER WITH OVERLOAD, NEMA SIZE INDICATED, FVNR UNO
	ELECTRONIC STARTER/SPEED CONTROL RVSS = REDUCED VOLTAGE SOFT STARTER AFD = AC ADJUSTABLE FREQUENCY DRIVE DC = DC ADJUSTABLE SPEED DRIVE RVAT = REDUCED VOLTAGE AUTO TRANSFORMER TYPE RVRT = REDUCED VOLTAGE REACTOR TYPE
	CABLE OR BUS CONNECTION POINT
	KEY INTERLOCK
	AC MOTOR, SQUIRREL CAGE INDUCTION - HORSEPOWER INDICATED
	GENERATOR, KW/KVA RATING SHOWN
	DIGITAL POWER METER (MULTIFUNCTION)
	UTILITY REVENUE METER
	GROUND
	TRANSFORMER, SIZE, VOLTAGE RATINGS, AND PHASE INDICATED
	POTENTIAL TRANSFORMER, VOLTAGE RATING AND QUANTITY INDICATED
	CURRENT TRANSFORMER, RATIO(100:5) AND QUANTITY INDICATED (3)
	CONNECTION POINT TO EQUIPMENT SPECIFIED IN OTHER DIVISIONS, RACEWAY, CONDUCTOR AND CONNECTION IN THIS DIVISION
	TRANSIENT VOLTAGE SURGE SUPPRESSOR
NOTES: 1. THESE ARE STANDARD LEGEND SHEETS. SOME SYMBOLS AND ABBREVIATIONS MAY APPEAR ON THE LEGEND AND NOT ON THE DRAWINGS. 2. FOR ADDITIONAL ABBREVIATIONS OF OTHER DIVISIONS (HVAC, MECHANICAL, AND STRUCTURAL/ARCHITECTURAL) SEE OTHER LEGENDS.	

SYMBOL	DESCRIPTION															
CONTROL DIAGRAM																
	PUSH-BUTTON SWITCH, MOMENTARY CONTACT, NORMALLY OPEN															
	PUSH-BUTTON SWITCH, MOMENTARY CONTACT, NORMALLY CLOSED															
	PUSH BUTTON SWITCH, MAINTAINED CONTACTS WITH MECHANICAL INTERLOCK															
	3 POSITION SELECTOR SWITCH MAINTAINED CONTACT															
	SELECTOR SWITCH - MAINTAINED CONTACT - CHART IDENTIFIES OPERATION WHEN NEEDED FOR CLARITY:															
	<table border="1"> <thead> <tr> <th rowspan="2">CKT</th> <th colspan="3">POSITION</th> </tr> <tr> <th>HAND</th> <th>OFF</th> <th>REMOTE</th> </tr> </thead> <tbody> <tr> <td>1</td> <td>X</td> <td>O</td> <td>O</td> </tr> <tr> <td>2</td> <td>O</td> <td>O</td> <td>X</td> </tr> </tbody> </table> X - CLOSED CONTACT O - OPEN CONTACT	CKT	POSITION			HAND	OFF	REMOTE	1	X	O	O	2	O	O	X
CKT	POSITION															
	HAND	OFF	REMOTE													
1	X	O	O													
2	O	O	X													
	TOGGLE SWITCH, ON-OFF TYPE															
	SELECTOR SWITCH, ON-OFF TYPE															
	MUSHROOM HEAD PUSHBUTTON SWITCH															
	INDICATING LIGHT, PUSH-TO-TEST, LETTER INDICATES COLOR															
	INDICATING LIGHT - LETTER INDICATES COLOR A - AMBER G - GREEN S - STROBE B - BLUE R - RED C - CLEAR W - WHITE															
	ELAPSED TIME METER															
	MOTOR STARTER CONTACTOR COIL															
	CONTROL RELAY, X INDICATES NUMERICAL ORDER IN CIRCUIT															
	TIME DELAY RELAY, X INDICATES NUMERICAL ORDER IN CIRCUIT															
	SOLENOID VALVE, X INDICATES NUMERICAL ORDER IN CIRCUIT															
	CONTACT - NORMALLY OPEN															
	CONTACT - NORMALLY CLOSED															
	REMOTE DEVICE															
	TIME DELAY RELAY CONTACT, NORMALLY OPEN, CLOSES WHEN ENERGIZED AND TIMED OUT															
	TIME DELAY RELAY CONTACT, NORMALLY CLOSED, OPENS WHEN ENERGIZED AND TIMED OUT															
	TIME DELAY RELAY CONTACT, CLOSES WHEN ENERGIZED, OPENS WHEN DE-ENERGIZED AND TIMED OUT															
	TIME DELAY RELAY CONTACT, OPENS WHEN ENERGIZED, CLOSES WHEN DE-ENERGIZED AND TIMED OUT															
	MOTOR SPACE HEATER															
	TERMINAL BLOCK, REMOTE															
	TERMINAL BLOCK, INTERNAL															
	FUSED TERMINAL BLOCK															
	FUSE, RATING INDICATED															
	TRANSFORMER, CONTROL POWER															
	THERMOCOUPLE															

SYMBOL	DESCRIPTION
POWER SYSTEM PLAN	
	CONNECTION POINT TO EQUIPMENT SPECIFIED, RACEWAY, CONDUCTOR, TERMINATION AND CONNECTION IN THIS DIVISION.
	MAJOR ELECTRICAL COMPONENT OR DEVICE - NAME OR IDENTIFYING SYMBOL AS SHOWN.
	PANELBOARD - SURFACE MOUNTED
	PANELBOARD LETTER OR NUMBER FACILITY NUMBER LP - LOW VOLTAGE PANEL DP - DISTRIBUTION PANEL
	PANELBOARD - FLUSH MOUNTED
	TERMINAL JUNCTION BOX
	MOTOR, SQUIRREL CAGE INDUCTION
	GENERATOR, VOLTAGE AND SIZE AS INDICATED.
	HOME RUN - DESTINATION SHOWN
	EXPOSED CONDUIT AND CONDUCTORS*
	CONCEALED CONDUIT AND CONDUCTORS*
NOTE: ALL UNMARKED CONDUIT RUNS CONSIST OF TWO NO. 12, ONE NO. 12 GROUND CONDUCTORS IN 3/4" CONDUIT. RUNS MARKED WITH CROSSHATCHES INDICATE NUMBER OF NO. 12 CONDUCTORS. CROSSHATCH WITH SUBSCRIPT "G" INDICATES GREEN GROUND WIRE.	
	CROSSHATCHES WITH BAR INDICATE NO.10 CONDUCTOR. SIZE CONDUIT ACCORDING TO SPECIFICATIONS AND APPLICABLE CODE.
	CONDUIT AND CONDUCTOR CALLOUT, SEE LEGEND.
	CONDUIT DOWN
	CONDUIT UP
	CONDUIT, STUBBED AND CAPPED
	EXISTING CONDUIT/ DUCT BANK
	CONCRETE ENCASED CONDUIT
	DIRECT BURIED CONDUIT
	FIBER OPTIC CONDUIT
	CONVENIENCE RECEPTACLE - DUPLEX UNLESS NOTED OTHERWISE WP - WEATHERPROOF C - CLOCK HANGER TL - TWIST LOCK CRE - CORROSION RESISTANT GFCI - GROUND FAULT CIRCUIT INTERRUPTER SUBSCRIPT NUMBER AT RECEPTACLE INDICATES CIRCUIT
	TRANSFORMER
	GENERAL CONTROL OR WIRING DEVICE. LETTER SYMBOLS OR ABBREVIATIONS INDICATE TYPE OF DEVICE
	CONTROL STATION, SEE CONTROL DIAGRAMS FOR CONTROL DEVICE(S) REQUIRED.
	NONFUSED DISCONNECT SWITCH, CURRENT RATING INDICATED, 3 POLE
	FUSED DISCONNECT SWITCH, CURRENT RATING INDICATED (60/40, 60=SWITCH RATING / 40=FUSE RATING) 3 POLE
	COMBINATION CIRCUIT BREAKER AND MAGNETIC STARTER, NEMA SIZE INDICATED
GROUND SYSTEM PLAN	
	GROUND ROD
	GROUND ROD IN TEST WELL
	GROUNDING CONDUCTOR, SIZE AS INDICATED
	PIGTAIL FOR CONNECTION TO EQUIPMENT CABINET OR FRAME
	EQUIPMENT GROUND BUS
	EQUIPMENT NEUTRAL BUS

SYMBOL	DESCRIPTION
LIGHTING SYSTEM PLAN	
	LUMINAIRE, SEE SCHEDULE
	LUMINAIRE, SEE SCHEDULE
	LUMINAIRE WITH INTERNAL BATTERY BACKUP, SEE SCHEDULE
	WALL MOUNTED LUMINAIRE, SEE SCHEDULE
	STANDBY LIGHTING UNIT, SURFACE MOUNTED, SEE SCHEDULE
	EXIT LIGHTS - FILLED SECTION INDICATES LIGHTED FACE, ARROW INDICATES EGRESS DIRECTIONAL INDICATORS, XX = FIXTURE NUMBER, SEE SCHEDULE
	SMALL LETTER SUBSCRIPT AT SWITCH AND LUMINAIRE INDICATES SWITCHING. SUBSCRIPT NUMBER AT LUMINAIRE INDICATES CIRCUIT
	WALL SWITCH: 2- DOUBLE POLE P- PILOT LIGHT 3- THREE WAY K- KEY OPERATED 4- FOUR WAY D- DIMMER WP- WEATHERPROOF CRE- CORROSION RESISTANT EX- EXPLOSIONPROOF L- MOMENTARY 3-WAY M- MOTOR RATED MS- MANUAL STARTER WITH OVERLOADS
ABBREVIATIONS	
A	AMPERE, AUTOMATIC
AC	ALTERNATING CURRENT
AFD	ADJUSTABLE FREQUENCY DRIVE
AFF	ABOVE FINISHED FLOOR
ATS	AUTOMATIC TRANSFER SWITCH
BKR	BREAKER
C	CONDUIT, CONTACTOR, CONDUCTOR, CLOSE
CPT	CONTROL POWER TRANSFORMER
CR	CONTROL RELAY
CT	CURRENT TRANSFORMER, CABLE TRAY
DC	DIRECT CURRENT
DP	DISTRIBUTION PANEL
E	EMPTY
F, FU	FUSE
FREQ	FREQUENCY
G	GROUND
GEN	GENERATOR
GFCI	GROUND FAULT CIRCUIT INTERRUPTER
GND	GROUND
HH	HANDHOLE
HOA	HAND-OFF-AUTO
HP	HORSEPOWER
HS	HAND SWITCH
HZ	HERTZ
IC	INTERRUPTING CAPACITY
J, JB	JUNCTION BOX
KA	KILOAMPERES
KV	KILOVOLT
KVA	KILOVOLT AMPERES
KW	KILOWATTS
M	MAGNETIC CONTACTOR COIL, MOTOR, MANUAL
MCC	MOTOR CONTROL CENTER
MH	MANHOLE, METAL HALIDE, MOUNTING HEIGHT
NC	NORMALLY CLOSED
N.O.	NORMALLY OPEN
NTS	NOT TO SCALE
OL	OVERLOAD RELAY
PB	PULL BOX
RGS	RIGID GALVANIZED STEEL CONDUIT
SPD	SURGE PROTECTIVE DEVICE
SS	START STOP
SST	STAINLESS STEEL
SV	SOLENOID VALVE
SWBD	SWITCHBOARD
TYP	TYPICAL
V	VOLTAGE, VOLTS
W	WATTS
WP	WEATHERPROOF
XFMR	TRANSFORMER

3011 SW WILLISTON ROAD
GAINESVILLE, FLORIDA 32608
EB0000072 AAC001982

DAVID C. NICHOLSON PE 60201

SWR SDC
FOR THE EFFLUENT
CITY OF KEY WEST
KEY WEST, FLORIDA

REVISION

NO.	DATE	BY	APVD

DR A. PASTRANA D. NICHOLSON

CHK E. CARRASCO D. NICHOLSON

DSGN

GENERAL
ELECTRICAL LEGEND
1 OF 2

VERIFY SCALE

BAR IS ONE INCH ON ORIGINAL DRAWING.

DATE	FEBRUARY 2018
PROJ	691623
DWG	001-G-002
SHEET	of

ELECTRICAL GENERAL NOTES

- 1 CONDUIT, WIRE AND EQUIPMENT SIZES AND LOCATIONS SHOWN ARE FOR BID BASIS ONLY AND SHALL BE VERIFIED BY THE CONTRACTOR BEFORE CONSTRUCTION. IT IS THE RESPONSIBILITY OF THE CONTRACTOR TO COORDINATE ALL WORK WITH APPROVED SHOP DRAWINGS, WITH THE REQUIREMENTS OF EQUIPMENT PROVIDED, WITH EQUIPMENT FURNISHED BY OWNER FOR INSTALLATION BY CONTRACTOR AND WITH REQUIREMENTS OF OTHER DIVISIONS OF THE CONTRACT AS NECESSARY TO PROVIDE COMPLETE AND WORKING SYSTEMS COMPLYING WITH THE CONTRACT DOCUMENTS. ALL PROPOSED DEVIATIONS FROM CONTRACT DOCUMENTS SHALL BE SUBMITTED AND APPROVED BEFORE EXECUTION OF THE AFFECTED WORK.
- 2 THE TERMS RACEWAY AND CONDUIT ARE USED IN THESE DOCUMENTS TO DENOTE NOT ONLY THE RACEWAY OR CONDUIT ITSELF BUT ALSO ALL JUNCTION BOXES, PULL BOXES, CONDUITS, FITTINGS, CLAMPS, SUPPORTS AND ALL OTHER ITEMS NECESSARY FOR A COMPLETE AND WORKING SYSTEM COMPLYING WITH THE CONTRACT DOCUMENTS.
- 3 NOTES INDICATED AS "REF", "REFERENCE" OR "REFER TO" ARE PROVIDED TO ASSIST IN LOCATING RELATED CONTRACTUAL REQUIREMENTS BUT ARE NOT CONTRACTUAL INSTRUCTIONS THEMSELVES. MISSING, INCORRECT OR INCOMPLETE REFERENCES SHALL HAVE NO EFFECT ON THE REQUIREMENTS OF THE CONTRACT.
- 4 AT ITEMS MARKED MSC (MANUFACTURER SUPPLIED OR SPECIFIED CABLE) CONTRACTOR SHALL DETERMINE REQUIREMENTS FOR, AND PROVIDE, CONDUIT AND CABLE AS REQUIRED BY MANUFACTURER AND IN COMPLIANCE WITH CONTRACT DOCUMENTS.
- 5 EXCEPT AS NOTED BELOW, ALL WIRE AND CABLE, INCLUDING FIBER OPTIC, SHALL BE INSTALLED IN RACEWAY. EXCEPTIONS ARE EQUIPMENT CABLES PROVIDED BY EQUIPMENT MANUFACTURERS AND UL LISTED FOR INSTALLATION OUTSIDE OF CONDUIT, INCLUDING FLOAT SWITCH AND SUBMERSIBLE PUMP CABLES.
- 6 SPARE RUNS OF CONDUCTORS SHALL BE INSULATED/TERMINATED AND LABELED AT BOTH ENDS. SPARE RUNS OF FIBER OPTIC STRANDS SHALL BE LABELED AND TERMINATED AT BOTH ENDS. ALL CONDUCTORS AND FIBERS SHALL BE TESTED AFTER INSTALLATION AND TEST REPORTS SHALL BE SUBMITTED. REPLACE ALL DEFECTIVE MATERIAL; DO NOT SUBMIT TEST REPORTS SHOWING DEFECTS.
- 7 LOCATIONS AND ELEVATIONS OF ELECTRICAL CONNECTIONS, MOTORS, PANEL BOARDS, SWITCH GEAR, TRANSFORMERS, CONTROL CABINETS AND OTHER ITEMS SHOWN ON DOCUMENTS ARE APPROXIMATE ONLY UNLESS DIMENSIONED. COORDINATE EXACT LOCATIONS AND ELEVATIONS WITH REQUIREMENTS OF OTHER DIVISIONS OF THESE DOCUMENTS.
IN AREAS WHERE SPACE AVAILABLE IS LIMITED, P REPAIR DIMENSIONED DRAWINGS SHOWING EXACT PROPOSED LOCATIONS OF EQUIPMENT AND VERIFYING THAT EQUIPMENT PROPOSED FOR USE CAN BE INSTALLED AS SHOWN ON PLANS IN COMPLIANCE WITH NEC AND MANUFACTURER'S REQUIREMENTS. BASE THESE DRAWINGS ON DIMENSIONS OF EQUIPMENT TO BE INSTALLED UNDER THIS CONTRACT WHICH ARE KNOWN TO CONTRACTOR TO BE CORRECT AND NOT SUBJECT TO CHANGE. NOTE DEVIATIONS FROM BID BASIS DRAWINGS AND DISCUSS WITH ENGINEER. SUBMIT THESE DRAWINGS AND RECEIVE APPROVAL BEFORE EXECUTING THE WORK. DO NOT SUBMIT SHOP DRAWINGS FOR EQUIPMENT WHICH IS NOT ACCOMPANIED BY DRAWINGS VERIFYING COMPLIANCE WITH CONTRACT REQUIREMENTS.
- 8 CONTROL (LADDER LOGIC) DIAGRAMS DEPICT FUNCTIONS REQUIRED, MAJOR COMPONENTS AND THEIR INTERCONNECTIONS, BUT ARE NOT INTENDED TO BE COMPLETE WIRING DIAGRAMS. CONTRACTOR SHALL COORDINATE WITH MANUFACTURERS OF EQUIPMENT PROVIDED TO ENSURE THAT ALL MATERIALS AND LABOR ARE PROVIDED WHICH ARE NECESSARY TO SECURE COMPLETE AND WORKING SYSTEMS WITH ALL FUNCTIONS AND COMPONENTS SHOWN ON THE CONTRACT DOCUMENTS, INCLUDING THIS DIVISION CONTRACT AND INSTRUMENTATION AND CONTROL DOCUMENTS.

- 9 GRATINGS, FRAMING, ENCLOSURES OF ELECTRICAL, PROCESS OR CONTROL EQUIPMENT OPERATING ABOVE 150 VOLTS TO GROUND OR OTHER CONDUCTIVE ITEMS INSTALLED, OUTDOORS, WHICH ARE NORMALLY NOT ENERGIZED SHALL BE BONDED TOGETHER TO THE OUTDOOR FACILITY GROUND RING WITH #2/0 MINIMUM TINNED BARE COPPER CONDUCTOR, USING UL LISTED CLAMPS ABOVE GRADE AND CAD WELDS BELOW GRADE. ITEMS SUCH AS STAIRS OR RAILINGS WHICH ARE INSTALLED AS MULTIPLE SECTIONS SHALL BE BONDED TOGETHER WITH TINNED #2/0 COPPER CONDUCTOR OR EQUIVALENT TINNED BRAIDED COPPER STRAP. ALL ITEMS SHALL HAVE TWO GROUND CONNECTIONS WITH DIFFERENT TERMINATION POINTS TO AVOID ISOLATION FROM A GROUND SYSTEM OF ANY ITEM DUE TO DISCONNECTION OF A SINGLE GROUND CONNECTION. CONDUCTIVE ENCLOSURES AND OTHER EXTERIOR METAL COMPONENTS WHICH ARE NOT NORMALLY ENERGIZED, OF INSTRUMENTS AND CONTROLS OPERATING AT OR BELOW 150 VOLTS TO GROUND, SHALL BE CONNECTED TO GROUNDING SYSTEM WITH TWO #6 AWG OR LARGER TINNED COPPER OR GREEN INSULATED GROUNDING CONDUCTORS.
- 10 PROVIDE #10 WIRE INSTEAD OF #12 WIRE FOR ALL 20 AMPERE 120 VOLT OR 208 VOLT CIRCUITS EXCEEDING 150 FEET CONDUIT LENGTH.
- 11 WHERE THE NUMBER OR SIZE OF CONDUCTORS SHOWN TO BE CONNECTED ARE IN EXCESS OF THE CAPACITY OF THE STANDARD TERMINALS OF THE CONNECTED EQUIPMENT, PROVIDE ADDITIONAL TERMINALS, ENCLOSURES, JUNCTION BOXES, PULL SECTIONS, WIRES, CONDUITS AND ALL OTHER MATERIALS AND LABOR AS NECESSARY TO MAKE THE CONNECTIONS SHOWN IN COMPLIANCE WITH THE CONTRACT DOCUMENTS.
- 12 ALL MATERIALS AND EQUIPMENT PROPOSED FOR USE SHALL BE NEW, UNUSED, FREE OF DAMAGE OR DETEIORATION, FULLY RATED AS SPECIFIED AND SCHEDULED IN THE CONTRACT DOCUMENTS AT THE PROJECT ALTITUDE AND MAXIMUM AMBIENT TEMPERATURE.
- 13 PROVIDE ARC FLASH WARNING AND OTHER SIGNS ON VFD CONTROL PANELS AND OTHER EQUIPMENT REQUIRED BY NEC INCLUDING BUT NOT LIMITED TO PARAGRAPH 110.16 FLASH PROTECTION.
- 14 COORDINATE SIZE AND INSTALLATION OF ALL EQUIPMENT WITH EXISTING CONDITIONS AND WORK IN OTHER DIVISIONS OF CONTRACT TO ENSURE COMPLIANCE WITH THE NEC, INCLUDING BUT NOT LIMITED TO PARAGRAPH 110.26 SPACES ABOUT ELECTRICAL EQUIPMENT.
- 15 STANDARD DETAILS INCLUDED IN THESE DOCUMENTS SHALL BE USED WHERE APPLICABLE WHETHER SPECIFICALLY CALLED OUT ON THE PLANS OR NOT. PRACTICES CUSTOMARY TO THE TRADE MAY BE USED ONLY WHERE NO APPLICABLE STANDARD DETAIL CAN BE FOUND IN THESE DOCUMENTS AND WHERE THE CUSTOMARY PRACTICE WILL RESULT IN A COMPLETE AND WORKING SYSTEM IN COMPLIANCE WITH THESE DOCUMENTS.
- 16 REFER TO DOCUMENTS OF OTHER DIVISIONS OF CONTRACT, INCLUDING BUT NOT LIMITED TO PROCESS MECHANICAL FOR LOCATIONS OF PROCESS, INSTRUMENTATION, CONTROL AND OTHER EQUIPMENT REQUIRING ELECTRICAL, FIBER OPTIC OR RACEWAY-ONLY CONNECTIONS TO BE PROVIDED UNDER THIS DIVISION OF CONTRACT. ALL EQUIPMENT LOCATIONS SHOWN ON DRAWINGS IN THIS DIVISION ARE APPROXIMATE ONLY UNLESS DIMENSIONED.
- 17 PROVIDE ADDITIONAL RACEWAY, WIRING AND CONNECTIONS AS NECESSARY FOR MOTOR TEMPERATURE PROTECTIVE DEVICES AND OTHER MOTOR AUXILIARIES WHERE RECOMMENDED BY EQUIPMENT MANUFACTURERS, SHOWN IN CONTROL DIAGRAMS OR ON PLANS OR REQUIRED IN SPECIFICATIONS.
- 18 ALL FABRICATED ASSEMBLIES SUPPORTING ELECTRICAL EQUIPMENT PROVIDED UNDER THIS DIVISION OF CONTRACT SHALL BE UL LISTED INDIVIDUALLY, UL LISTED AS PART OF AN ASSEMBLY OR SHALL BE FABRICATED TO A DESIGN PREPARED BY A STRUCTURAL ENGINEER LICENSED TO PRACTICE IN THE STATE OR OTHERWISE PERMITTED TO PRACTICE ENGINEERING IN THE STATE. WHERE DETAILS IN THIS DIVISION OF THE CONTRACT DOCUMENTS CONTAIN SPECIFIC DIMENSIONS, SIZES, WELD INSTRUCTIONS OR SIMILAR INFORMATION RELATED TO THE STRENGTH OF THE ASSEMBLY, THESE SHALL BE INTERPRETED AS BID-BASIS REQUIREMENTS ONLY AND SHALL BE SUPERCEDED BY THE UL OR ENGINEERING DESIGN REQUIREMENTS ABOVE.
- 19 AT ALL LOCATIONS WHERE CONTRACTOR IS DIRECTED TO CUT OFF CONDUITS THROUGH CONCRETE SLAB AND GROUT CLOSED, CONTRACTOR SHALL FIRST DRILL 1-1/2 INCHES DEEP INTO CONCRETE AND USE NON-SHRINK GROUT TO BACKFILL HOLE FLUSH AND SMOOTH WITH EXISTING CONCRETE SURFACE.
- 20 ALL CONDUCTORS INSTALLED OUTDOORS OR UNDERGROUND, INCLUDING IN DUCT BANK, CONDUIT OR DIRECT BURIED OR IN HANDHOLES OR MANHOLES SHALL BE TRAY RATED CABLE TYPE TC UL LISTED FOR CONTINUOUS SUBMERSION. CABLE SHALL NOT BE SPLICED OR JOINED AND SHALL BE CONTINUOUS BETWEEN SOURCE AND LOAD TERMINATIONS. CONTRACTOR SHALL PROVIDE LARGER CONDUIT IF NECESSARY TO MEET NEC FILL LIMITS FOR CABLE.
21. WHERE UL LISTED AND LABELED MATERIAL OR EQUIPMENT IS REQUIRED BUT IS NOT AVAILABLE FROM A MANUFACTURER NAMED IN THE APPLICABLE SPECIFICATION SECTION OR ON THE DRAWINGS, LISTING AND LABELING BY CSA, ETL OR FM WILL BE ACCEPTABLE UNDER THIS CONTRACT IF ACCEPTABLE TO THE AUTHORITY HAVING JURISDICTION (AH). IT IS THE RESPONSIBILITY OF THE CONTRACTOR TO VERIFY ACCEPTANCE BY THE AH. MATERIAL AND EQUIPMENT WHICH IS UNACCEPTABLE OR OTHERWISE NOT IN COMPLIANCE WITH THE CONTRACT SHALL BE REPLACED AT NO CHANGE IN CONTRACT.

NOTE: CONDUIT SIZES SHOWN ARE FOR EXPOSED CONDUITS. MINIMUM SIZE OF UNDERGROUND CONDUIT SHALL BE 2 INCHES.

CIRCUIT SCHEDULE		
POWER: 1Phase, 2Wire		
CKT ID	CKT AMPS	CONDUIT AND CONDUCTOR SIZE
PA1	15	3/4"C, 2#14, 1#14G
PA2	20	3/4"C, 2#12, 1#12G
PA2A	20	1"C, 4#12, 8#14, 1#12G
PA2B	20	1"C, 4#12, 4#14, 1#12G
PA3	30	3/4"C, 2#10, 1#10G
PA4	40	3/4"C, 2#8, 1#10G
PA5	50	3/4"C, 2#8, 1#10G
PA6	60	1"C, 2#6, 1#8G
PA7	70	1"C, 2#4, 1#8G
PA8	80	1"C, 2#4, 1#8G
PA9	90	1"C, 2#3, 1#8G
PA10	100	1"C, 2#3, 1#8G
PA12	125	1 1/2"C, 2#1, 1#6G
PA15	150	1 1/2"C, 2#1/0, 1#6G
PA20	200	1 1/2"C, 2#3/0, 1#6G
PA22	225	2"C, 2#4/0, 1#4G

CONTROL: DISCRETE	
CKT ID	CONDUIT AND CONDUCTOR SIZE
C1	1"C, WITH MSC (SEE NOTE 1)
C2	3/4"C, 2#14, 1#14G
C3	3/4"C, 3#14, 1#14G
C4	3/4"C, 4#14, 1#14G
C5	3/4"C, 5#14, 1#14G
C6	3/4"C, 6#14, 1#14G
C7	3/4"C, 7#14, 1#14G
C8	3/4"C, 8#14, 1#14G
C10	3/4"C, 10#14, 1#14G
C12	3/4"C, 12#14, 1#14G
C14	3/4"C, 14#14, 1#14G
C16	1"C, 16#14, 1#14G
C18	1"C, 18#14, 1#14G
C20	1"C, 20#14, 1#14G
C24	1"C, 24#14, 1#14G
C28	1 1/2"C, 28#14, 1#14G
C32	1 1/2"C, 32#14, 1#14G
C38	1 1/2"C, 38#14, 1#14G
C40	1 1/2"C, 40#14, 1#14G
C46	1 1/2"C, 46#14, 1#14G
C50	1 1/2"C, 50#14, 1#14G
C60	1 1/2"C, 60#14, 1#14G

CIRCUIT SCHEDULE		
POWER: 1Phase, 3Wire or 3Phase, 3Wire		
CKT ID	CKT AMPS	CONDUIT AND CONDUCTOR SIZE
PB1	15	3/4"C, 3#14, 1#14G
PB2	20	3/4"C, 3#12, 1#12G
PB2A	20	3/4"C, 3#12, 4#14, 1#12G
PB3	30	3/4"C, 3#10, 1#10G
PB3A	30	3/4"C, 3#10, 4#14, 1#10G
PB4	40	3/4"C, 3#8, 1#10G
PB4A	40	3/4"C, 3#8, 4#14, 1#8G
PB5	50	3/4"C, 3#6, 1#10G
PB6	60	1"C, 3#4, 1#8G
PB6A	60	1"C, 3#6, 4#14, 1#8G
PB7	70	1"C, 3#4, 1#8G
PB8	80	1"C, 3#4, 1#8G
PB9	90	1 1/2"C, 3#3, 1#8G
PB10	100	1 1/2"C, 3#2, 1#8G
PB12	125	1 1/2"C, 3#1, 1#6G
PB15	150	1 1/2"C, 3#1/0, 1#6G
PB17	175	2"C, 3#2/0, 1#6G
PB20	200	2"C, 3#3/0, 1#6G
PB22	225	2"C, 3#4/0, 1#4G
PB25	250	2 1/2"C, 3#250KCM, 1#4G
PB30	300	3"C, 3#350KCM, 1#4G
PB35	350	3"C, 3#500KCM, 1#4G
PB40	400	2 SETS: 2"C, 3#3/0, 1#3G
PB45	400	2 SETS: 2"C, 3#4/0, 1#2G
PB50	500	2 SETS: 2 1/2"C, 3#250KCM, 1#2G
PB60	600	2 SETS: 3"C, 3#350KCM, 1#1G
PB76	760	2 SETS: 4"C, 3#500KCM, 1#2/0G
PB80	800	3 SETS: 3"C, 3#350KCM, 1#2/0G
PB90	1000	3 SETS: 3"C, 3#500KCM, 1#2/0G

CIRCUIT SCHEDULE	
CONTROL: ANALOG	
CKT ID	CONDUIT AND CONDUCTOR SIZE
A1	3/4"C, 1 TYPE 3
A2	3/4"C, 2 TYPE 3
A3	1"C, 3 TYPE 3
A4	1"C, 4 TYPE 3
A5	1"C, 5 TYPE 3
A6	1 1/4"C, 6 TYPE 3
A7	1 1/4"C, 7 TYPE 3
A8	1 1/2"C, 8 TYPE 3
A9	1 1/2"C, 9 TYPE 3
A10	1 1/2"C, 10 TYPE 3
A11	1 1/2"C, 11 TYPE 3
A12	2"C 12 TYPE 3
A15	2"C 15 TYPE 3
A16	2"C 16 TYPE 3
A17	2"C 17 TYPE 3
A20	2"C, 20 TYPE 3
A21	2 1/2"C, 21 TYPE 3
A22	2 1/2"C, 22 TYPE 3
A24	3"C, 24 TYPE 3
A25	2"C, 8 TYPE 4

CIRCUIT SCHEDULE		
POWER: 3Phase, 4Wire		
CKT ID	CKT AMPS	CONDUIT AND CONDUCTOR SIZE
PC1	15	3/4"C, 4#14, 1#14G
PC2	20	3/4"C, 4#12, 1#12G
PC3	30	3/4"C, 4#10, 1#10G
PC4	40	3/4"C, 4#8, 1#10G
PC5	50	1"C, 4#8, 1#10G
PC6	60	1"C, 4#6, 1#8G
PC7	70	1 1/4"C, 4#4, 1#8G
PC8	80	1 1/4"C, 4#4, 1#8G
PC9	90	1 1/4"C, 4#3, 1#8G
PC10	100	1 1/4"C, 4#3, 1#8G
PC12	125	1 1/2"C, 4#1, 1#6G
PC15	150	2"C, 4#1/0, 1#6G
PC20	200	2"C, 4#3/0, 1#6G
PC22	225	2 1/2"C, 4#4/0, 1#4G
PC25	250	2 1/2"C, 4#250KCM, 1#4G
PC30	300	3"C, 4#350KCM, 1#2G
PC35	350	3 1/2"C, 4#500KCM, 1#1/0G
PC40	400	2 SETS: 2 1/2"C, 4#3/0, 1#1/0G
PC40A	400	4"C, 4#600KCM, 1#2G
PC50	500	2 SETS: 2 1/2"C, 4#250KCM, 1#4G
PC60	600	2 SETS: 3"C, 4#350KCM, 1#2/0G
PC80	800	3 SETS: 3"C, 4#350KCM, 1#2/0G
PC100	1000	3 SETS: 4"C, 4#500KCM, 1#2/0G
PC160	1600	5 SETS: 4"C, 4#500KCM, 1#3/0G
PC200	2000	6 SETS: 4"C, 4#500KCM, 1#3/0G
PC250	2500	6 SETS: 4"C, 4#600KCM, 1#4/0G
PC300	3000	8 SETS: 4"C, 4#500KCM, 1#4/0G

CIRCUIT SCHEDULE	
FIBER OPTIC CABLE	
CKT ID	CONDUIT AND CONDUCTOR SIZE
[FO]	1"C, 12-STRAND FIBER OPTIC CABLE

GENERAL NOTES:

1. MSC = MANUFACTURER SUPPLIED CABLE. CONTRACTOR SHALL ENSURE SUFFICIENT LENGTH OF CABLE IS FURNISHED PRIOR TO CABLE INSTALLATION. SUFFICIENT LENGTH SHALL BE DEFINED AS WHAT IS REQUIRED TO INSTALL THE CABLE BETWEEN THE DEVICES PLUS 50 FEET OF EXTRA CABLE. CONTRACTOR SHALL COIL UP AND LOCATE THE EXTRA LENGTH OF CABLE IN HANDHOLE OR NEMA 4X STAINLESS STEEL PULLBOX, AS APPLICABLE. SPLICING OF CABLE IS STRICTLY PROHIBITED. MINIMUM SIZE OF CONDUIT AS INDICATED ON DRAWINGS. CONTRACTOR SHALL BE REQUIRED TO FURNISH LARGER SIZE CONDUIT IN ORDER TO INSTALL THE MSC.

3011 SW WILLISTON ROAD
GAINESVILLE, FLORIDA 32608
EBO000072 AAC001982
DAVID C. NICHOLSON PE 60201
SWR SDC
FOR THE EFFLUENT
CITY OF KEY WEST
KEY WEST, FLORIDA

NO. DATE
REVISION
CHKG
APVD

DSGN
E. CARRASCO
A. PASTRANA
D. NICHOLSON

DR
APVD
BY
APVD

REUSE OF DOCUMENTS: THIS DOCUMENT, AND THE IDEAS AND DESIGNS INCORPORATED HEREIN, AS AN INSTRUMENT OF PROFESSIONAL SERVICE, IS THE PROPERTY OF CH2M HILL AND IS NOT TO BE USED, IN WHOLE OR IN PART, FOR ANY OTHER PROJECT WITHOUT THE WRITTEN AUTHORIZATION OF CH2M HILL.

VERIFY SCALE

BAR IS ONE INCH ON ORIGINAL DRAWING.

DATE FEBRUARY 2018

PROJ 691623

DWG 001-G-003

SHEET of

PLOT DATE: 2/5/2018
PLOT TIME: 10:51:56 AM

INSTRUMENT IDENTIFICATION

INSTRUMENT IDENTIFICATION LETTERS TABLE

LETTER	FIRST-LETTER		SUCCEEDING-LETTERS		
	PROCESS OR INITIATING VARIABLE	MODIFIER	READOUT OR PASSIVE FUNCTION	READOUT OR PASSIVE FUNCTION	READOUT OR PASSIVE FUNCTION
A	ANALYSIS (+)		ALARM		
B	BURNER, COMBUSTION		USER'S CHOICE (*)	USER'S CHOICE (*)	USER'S CHOICE (*)
C	USER'S CHOICE (*)			CONTROL	
D	DENSITY (S.G.)	DIFFERENTIAL			
E	VOLTAGE		PRIMARY ELEMENT, SENSOR		
F	FLOW RATE	RATIO (FRACTION)			
G	USER'S CHOICE (*)		GLASS, GAUGE VIEWING DEVICE	GATE	
H	HAND (MANUAL)				HIGH
I	CURRENT (ELECTRICAL)		INDICATE		
J	POWER	SCAN			
K	TIME, TIME SCHEDULE	TIME RATE OF CHANGE		CONTROL STATION	
L	LEVEL		LIGHT (PILOT)		LOW
M	MOTION	MOMENTARY			MIDDLE, INTERMEDIATE
N	TORQUE		USER'S CHOICE (*)	USER'S CHOICE (*)	USER'S CHOICE (*)
O	USER'S CHOICE (*)		ORIFICE, RESTRICTION		
P	PRESSURE, VACUUM		POINT (TEST) CONNECTION		
Q	QUANTITY	INTEGRATE, TOTALIZE			
R	RADIATION		RECORD OR PRINT		
S	SPEED, FREQUENCY	SAFETY		SWITCH	
T	TEMPERATURE			TRANSMIT	
U	MULTI VARIABLE		MULTI FUNCTION	MULTI FUNCTION	MULTI FUNCTION
V	VIBRATION, MECHANICAL ANALYSIS			VALVE, DAMPER, LOUVER	
W	WEIGHT, FORCE		WELL		
X	UNCLASSIFIED (*)	X AXIS	UNCLASSIFIED (*)	UNCLASSIFIED (*)	UNCLASSIFIED (*)
Y	EVENT, STATE OR PRESENCE	Y AXIS		RELAY, COMPUTE, CONVERT	
Z	POSITION	Z AXIS		DRIVE, ACTUATOR, UNCLASSIFIED FINAL CONTROL ELEMENT	

TABLE BASED ON THE INTERNATIONAL SOCIETY OF AUTOMATION (ISA) STANDARD.
 (+) WHEN USED, EXPLANATION IS SHOWN ADJACENT TO INSTRUMENT SYMBOL. SEE ABBREVIATIONS AND LETTER SYMBOLS.
 (*) WHEN USED, DEFINE THE MEANING HERE FOR THE PROJECT.

EXAMPLE SYMBOLS

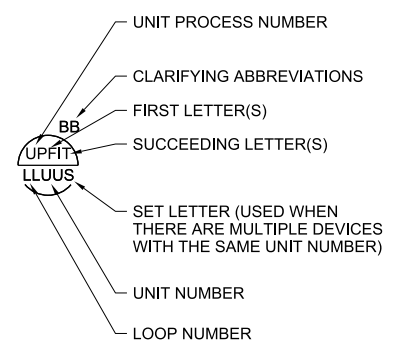

DIGITAL SYSTEM INTERFACES

- ▲ ANALOG INPUT
- ▼ ANALOG OUTPUT
- △_x DISCRETE INPUT
- ▽_x DISCRETE OUTPUT

GENERAL INSTRUMENT OR FUNCTIONAL SYMBOLS

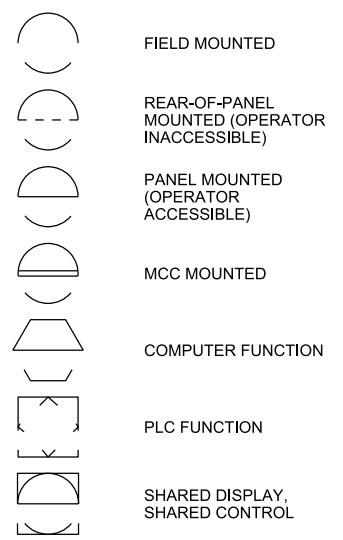

TRANSDUCERS

A	ANALOG	I	CURRENT
D	DIGITAL	P	PNEUMATIC
E	VOLTAGE	PF	PULSE FREQUENCY
F	FREQUENCY	PD	PULSE DURATION
H	HYDRAULIC	R	RESISTANCE

EXAMPLE: CURRENT TO PNEUMATIC TRANSDUCER (BACK OF PANEL, IN A FLOW LOOP)

ACCESSORY DEVICES

A	ALARM
C	CONTROLLER
I	INDICATOR
R	RECORDER
S	SWITCH
T	TRANSMITTER
X	UNCLASSIFIED

EXAMPLE: TRANSMITTER AS AN ACCESSORY TO A FLOW ELEMENT

SPECIAL CASES

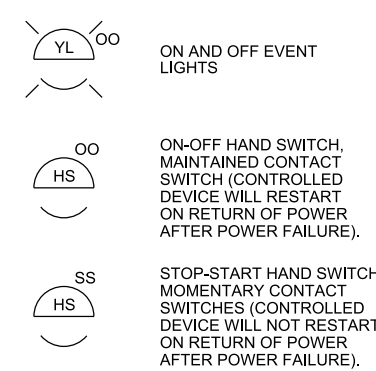

LINE LEGEND

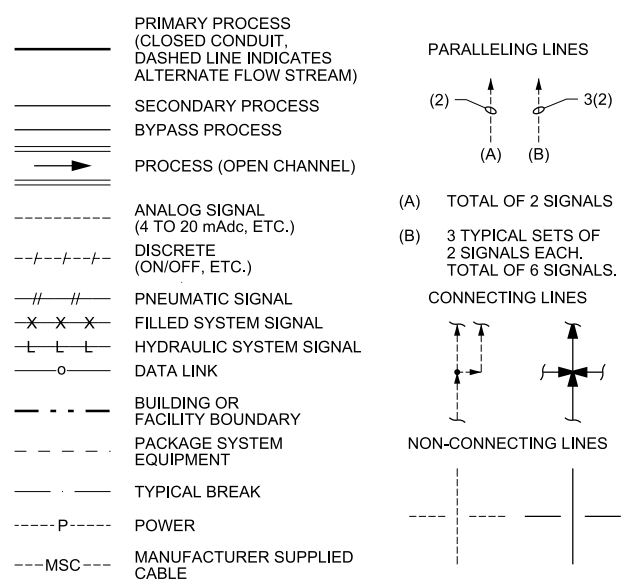

INTERFACE SYMBOLS

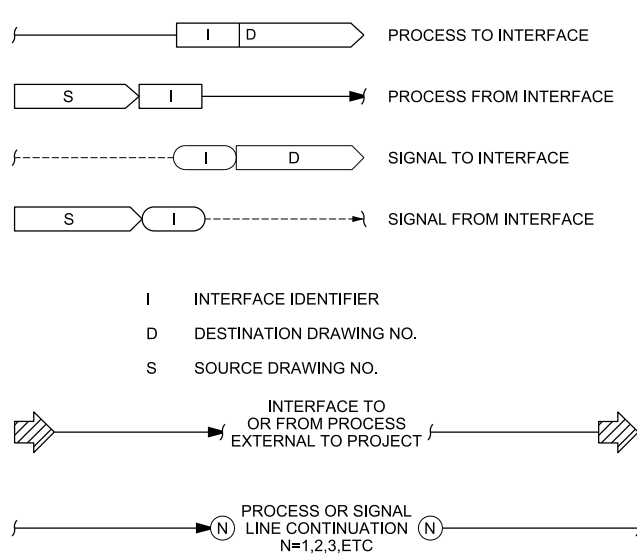

SELF CONTAINED VALVE & EQUIPMENT TAG NUMBERS

W-D-X-Y

W	UNIT PROCESS NUMBER
D	ARV AIR RELEASE VALVE AVRV AIR AND VACUUM RELEASE VALVE E EJECTOR G GATE M MECHANICAL EQUIPMENT P PUMP T TANK
X	LOOP NUMBER
Y	UNIT NUMBER

ABBREVIATIONS & LETTER SYMBOLS

AC	ALTERNATING CURRENT
AM	AUTO-MANUAL
CP-X	CONTROL PANEL NO. X
DC	DIRECT CURRENT
FP-W-X	FIELD PANEL NO. WX (W=UNIT PROCESS NUMBER X= PANEL NUMBER)
HOA	HAND-OFF-AUTO
HOR	HAND-OFF-REMOTE
ISR	INTRINSICALLY SAFE RELAY
LEL	LOWER EXPLOSIVE LIMIT
LR	LOCAL-REMOTE
MA	MANUAL-AUTO
MCC-X	MOTOR CONTROL CENTER NO. X
MSC	MANUFACTURER SUPPLIED CABLE
OC	OPEN-CLOSE(D)
OCA	OPEN-CLOSE-AUTO
OCR	OPEN-CLOSE-REMOTE
OO	ON-OFF
OOA	ON-OFF-AUTO
OOR	ON-OFF-REMOTE
OSC	OPEN-STOP-CLOSE
pH	HYDROGEN ION CONCENTRATION
PLC	PROGRAMMABLE LOGIC CONTROLLER
RIO	REMOTE I/O UNIT
SS	START-STOP
TOC	TOTAL ORGANIC CARBON
TOD	TOTAL OXYGEN DEMAND
TURB	TURBIDITY
VHC	VOLATILE HYDROCARBONS
VIB	VIBRATION
Δ	DIFFERENCE
Σ	SUM
x	MULTIPLY
÷	DIVIDE
F(X)	CHARACTERIZED
X ⁿ	RAISED TO THE Nth POWER
√	SQUARE ROOT
AVG	AVERAGE
1:1	REPEAT OR BOOST
>	SELECT HIGHEST SIGNAL
<	SELECT LOWEST SIGNAL
}	BIAS
%	GAIN OR ATTENUATE

GENERAL NOTES

- COMPONENTS AND PANELS SHOWN WITH A SINGLE ASTERISK (*) ARE TO BE PROVIDED AS PART OF A PACKAGE SYSTEM.
- COMPONENTS AND PANELS SHOWN WITH A DOUBLE ASTERISK (***) ARE TO BE PROVIDED UNDER DIVISION 16, ELECTRICAL.
- THIS IS A STANDARD LEGEND. THEREFORE, NOT ALL OF THIS INFORMATION MAY BE USED ON THE PROJECT.

3011 SW WILLISTON ROAD
 GAINESVILLE, FLORIDA 32608
 EB0000072 AAC001982
 JESSICA R. KNIGHT PE 72430
 SWR SDC
 FOR THE EFFLUENT
 CITY OF KEY WEST
 KEY WEST, FLORIDA

GENERAL
ch2m
 INSTRUMENTATION & CONTROLS
 LEGEND 1 OF 2

VERIFY SCALE	
BAR IS ONE INCH ON ORIGINAL DRAWING.	
DATE	FEBRUARY 2018
PROJ	691623
DWG	001-G-004
SHEET	of

VALVE SYMBOLS

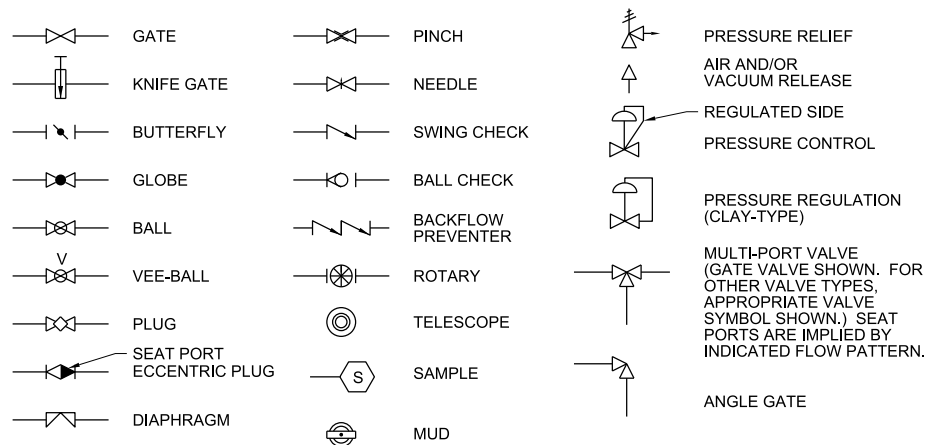

GATE SYMBOLS

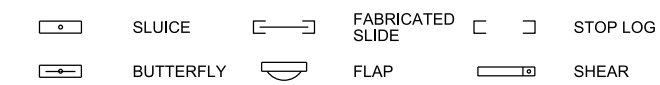

ACTUATOR SYMBOLS

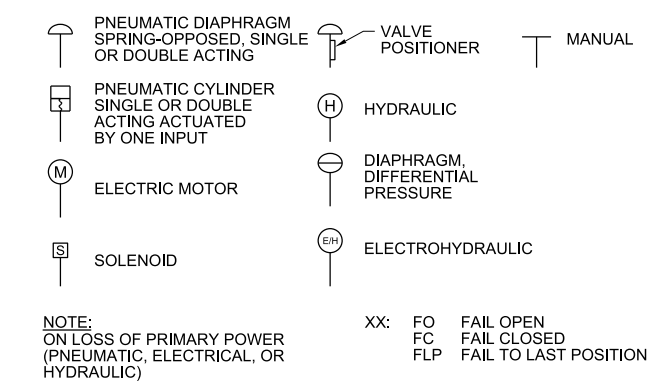

PRIMARY ELEMENT SYMBOLS

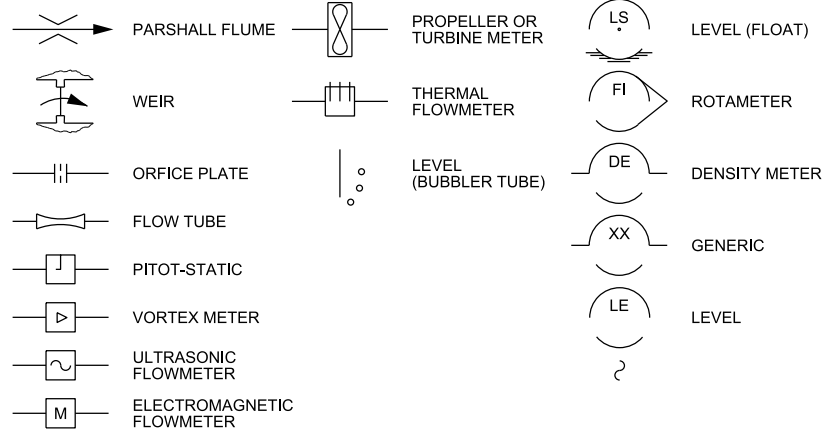

MISCELLANEOUS SYMBOLS

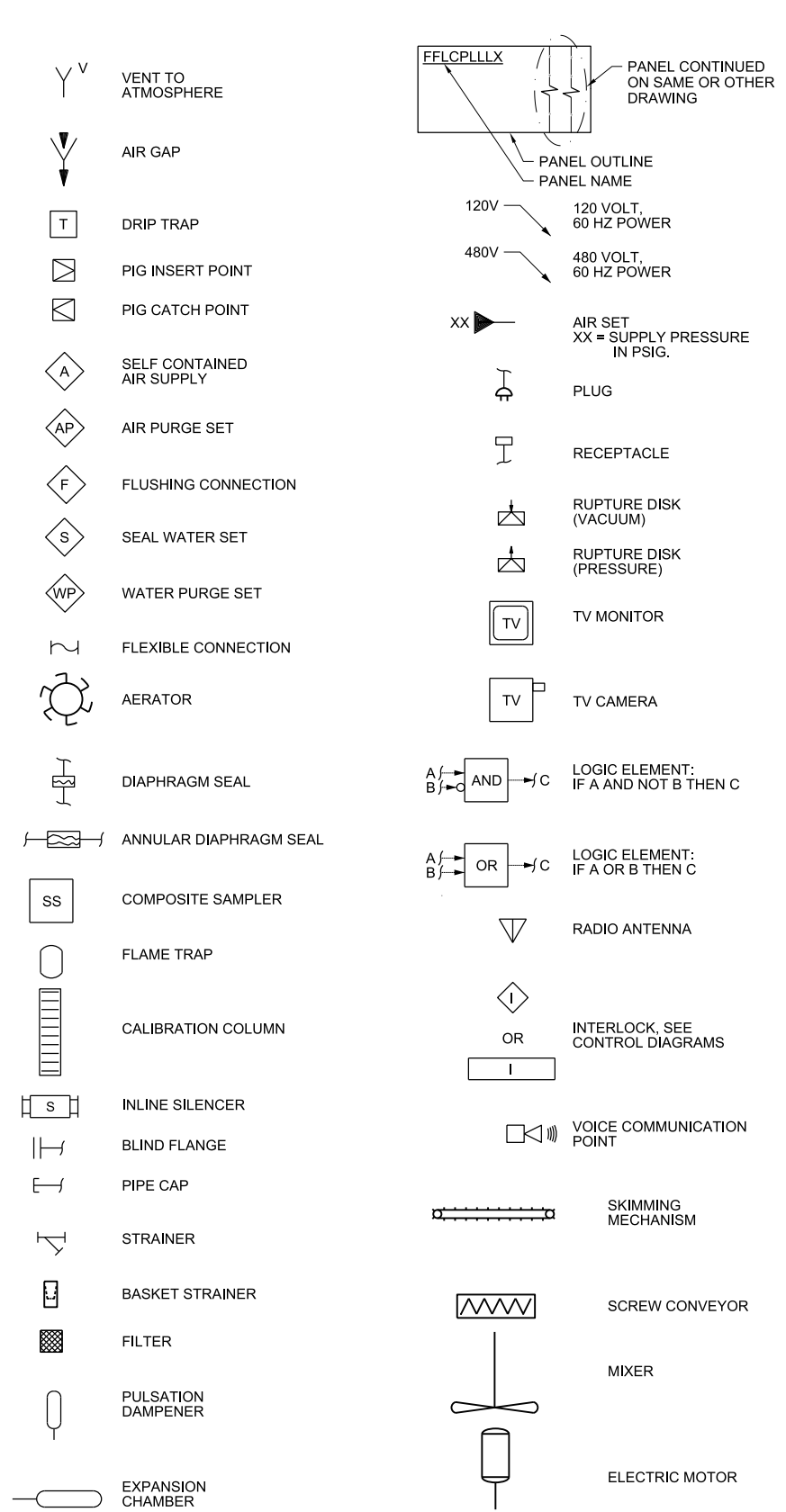

PUMP AND COMPRESSOR SYMBOLS

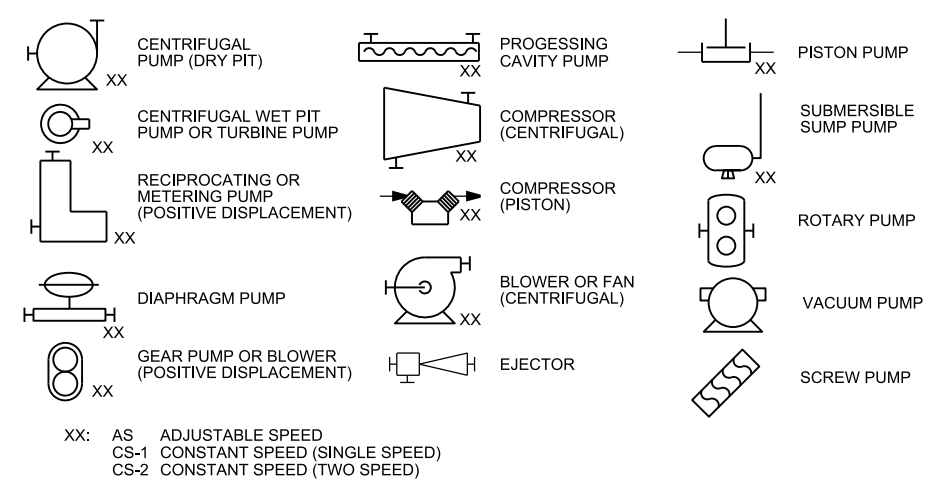

FLOW STREAM IDENTIFICATION

- AHP AIR HIGH PRESSURE
- D DRAIN
- SA SAMPLE
- SE SECONDARY EFFLUENT
- V VENT
- W2 NO. 2 (NON-POTABLE) WATER

<p>3011 SW WILLISTON ROAD GAINESVILLE, FLORIDA 32608 EB0000072 AAC001982</p> <p>JESSICA R. KNIGHT PE 72430</p> <p>SWR SDC FOR THE EFFLUENT CITY OF KEY WEST KEY WEST, FLORIDA</p>		<p>NO. DATE</p> <p>DR</p> <p>REVISION</p> <p>CHK</p> <p>APVD</p> <p>BY APVD</p> <p>J. KNIGHT</p> <p>C. WILSON</p> <p>J. KNIGHT</p>
<p>ch2m</p> <p>GENERAL INSTRUMENTATION & CONTROLS LEGEND 2 OF 2</p>		<p>VERIFY SCALE</p> <p>BAR IS ONE INCH ON ORIGINAL DRAWING.</p> <p>DATE FEBRUARY 2018</p> <p>PROJ 691623</p> <p>DWG 001-G-005</p> <p>SHEET of</p>

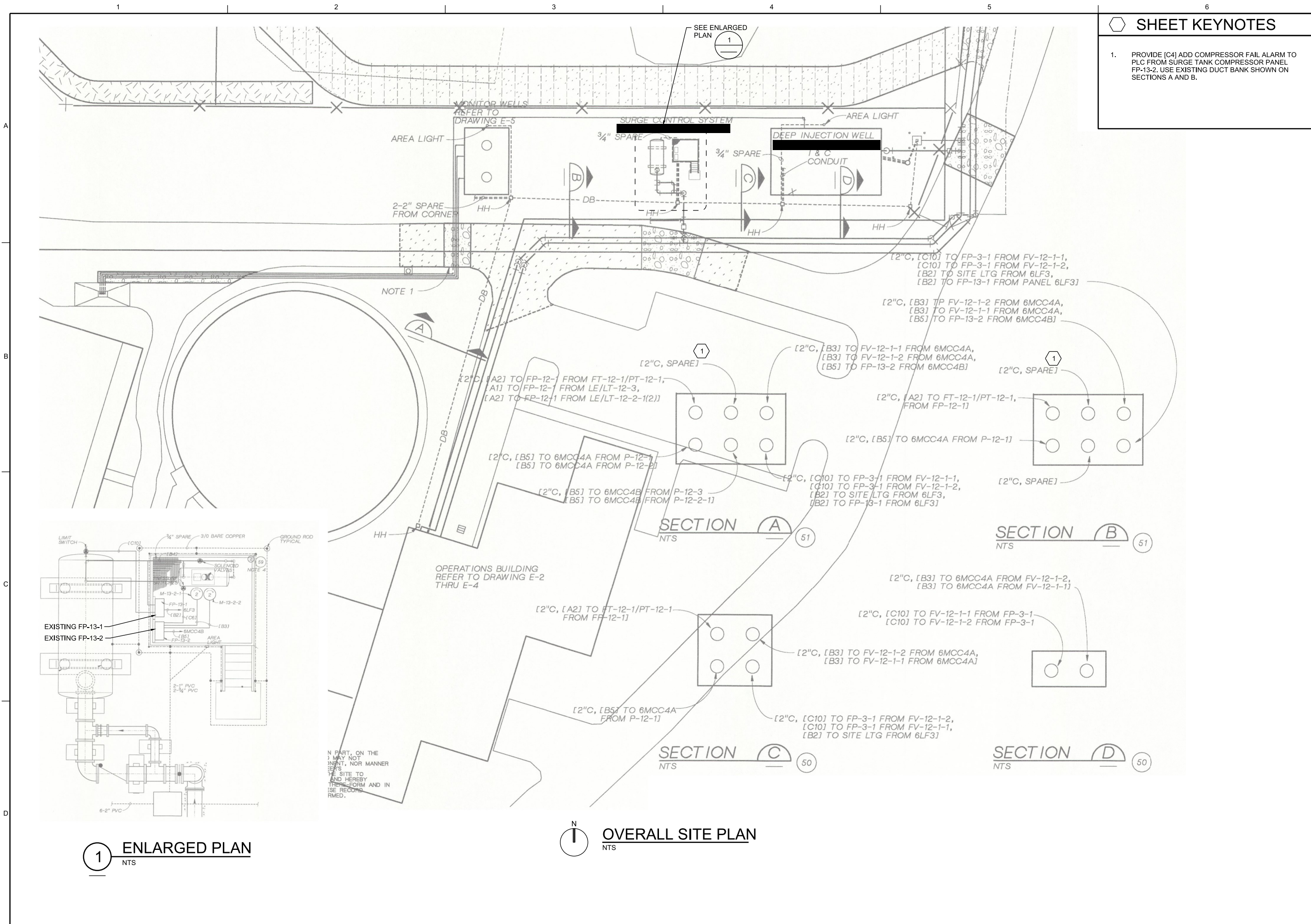

SHEET KEYNOTES

- PROVIDE [C4] ADD COMPRESSOR FAIL ALARM TO PLC FROM SURGE TANK COMPRESSOR PANEL FP-13-2. USE EXISTING DUCT BANK SHOWN ON SECTIONS A AND B.

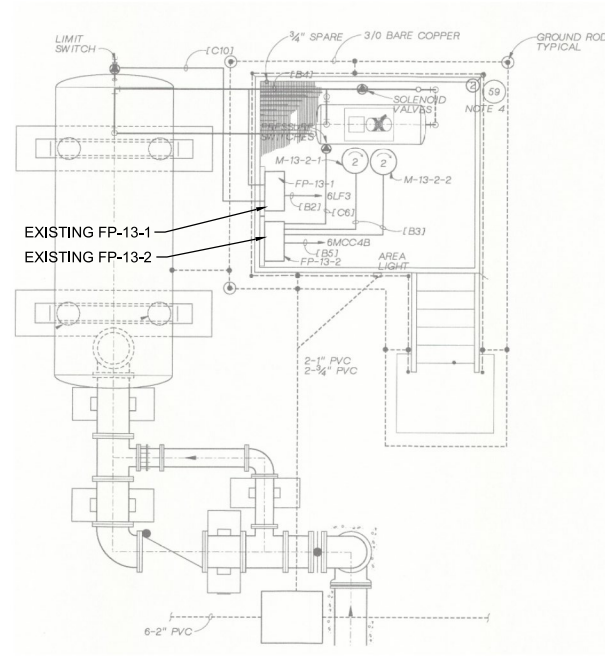

1 ENLARGED PLAN
NTS

OVERALL SITE PLAN
NTS

NO.	DATE	DR	CHK	REVISION	BY	APVD

3011 SW WILLISTON ROAD
GAINESVILLE, FLORIDA 32608
EBO000072 AAC001982

DAVID C. NICHOLSON PE 60201

SWR SDC
FOR THE EFFLUENT
CITY OF KEY WEST
KEY WEST, FLORIDA

ch2m
ELECTRICAL

**SITE PLAN AND
DUCT BANK SECTION**

NTS

VERIFY SCALE
BAR IS ONE INCH ON ORIGINAL DRAWING.
0" 1"

DATE FEBRUARY 2018
PROJ 691623
DWG 005-E-201
SHEET of

DESIGNER: E. CARRASCO
CHECKER: A. PASTRANA
APPROVED: D. NICHOLSON

© CH2M HILL 2017. ALL RIGHTS RESERVED.

BID DOCUMENTS

FP-3-1

A

B

C

D

1

2

3

4

5

6

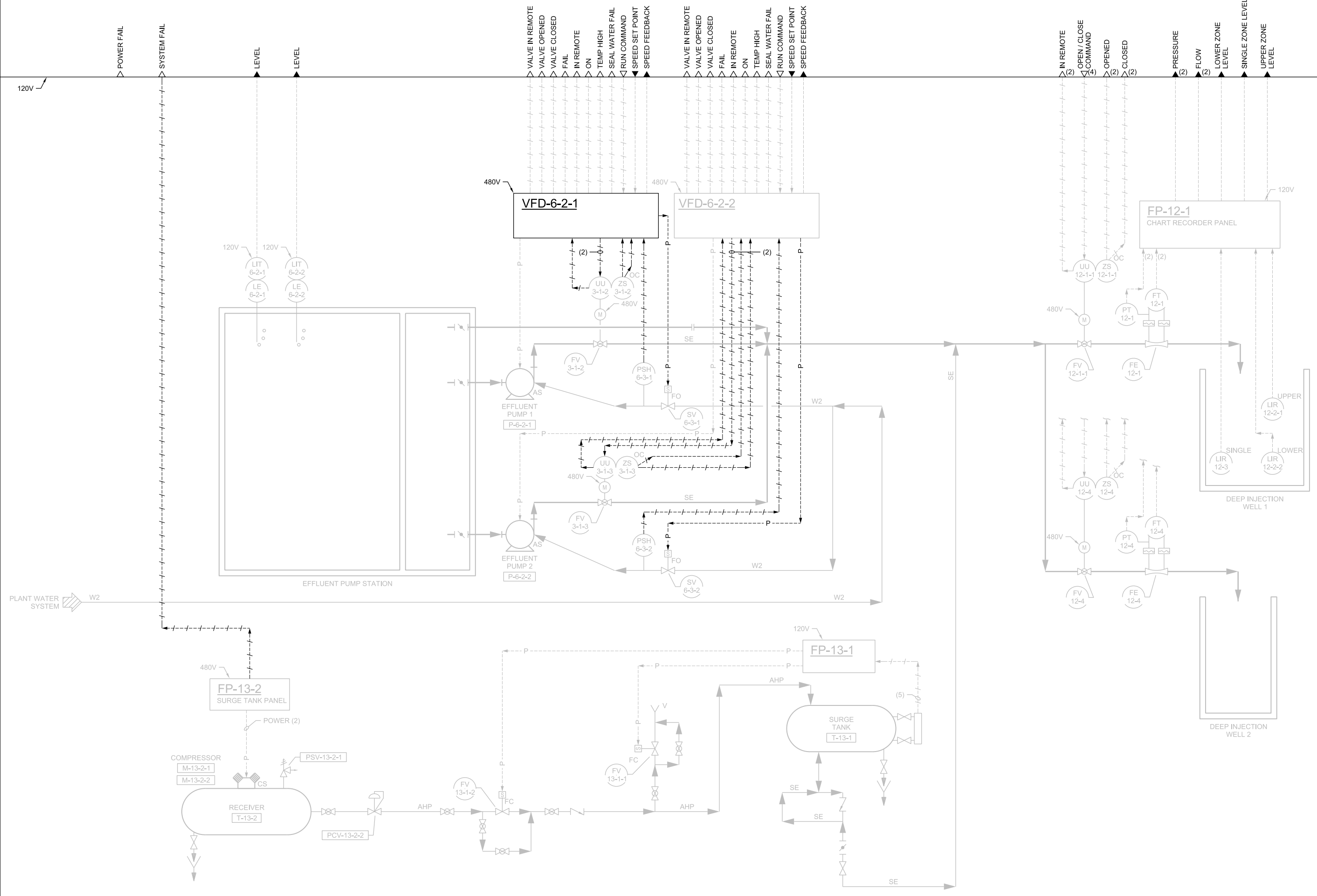

- VALVE IN REMOTE
- VALVE OPENED
- VALVE CLOSED
- FAIL
- IN REMOTE
- ON
- TEMP HIGH
- SEAL WATER FAIL
- RUN COMMAND
- SPEED SET POINT
- SPEED FEEDBACK

- IN REMOTE (2)
- OPEN / CLOSE COMMAND (4)
- OPENED (2)
- CLOSED (2)
- PRESSURE (2)
- FLOW (2)
- LOWER ZONE LEVEL
- SINGLE ZONE LEVEL
- UPPER ZONE LEVEL

<p>3011 SW WILLISTON ROAD GAINESVILLE, FLORIDA 32608 EB0000072 AAC001982</p> <p>JESSICA R. KNIGHT PE 72430</p>		<p>SWR SDC FOR THE EFFLUENT CITY OF KEY WEST KEY WEST, FLORIDA</p>	
<p>ch2m</p>		<p>INSTRUMENTATION & CONTROLS P&ID EFFLUENT PUMPS</p>	
<p>VERIFY SCALE BAR IS ONE INCH ON ORIGINAL DRAWING.</p>			
DATE		FEBRUARY 2018	
PROJ		691623	
DWG		008-N-601	
SHEET		of	

© CH2M HILL 2017. ALL RIGHTS RESERVED.
 J. KNIGHT C. WILSON
 G. MESSER
 DR. REVISION. CHK. APVD. BY. APVD.
 NO. DATE DSGN. J. KNIGHT C. WILSON G. MESSER
 THIS DOCUMENT, AND THE IDEAS AND DESIGNS INCORPORATED HEREIN, AS AN INSTRUMENT OF PROFESSIONAL SERVICE, IS THE PROPERTY OF CH2M HILL AND IS NOT TO BE USED, IN WHOLE OR IN PART, FOR ANY OTHER PROJECT WITHOUT THE WRITTEN AUTHORIZATION OF CH2M HILL.

A

B

C

D

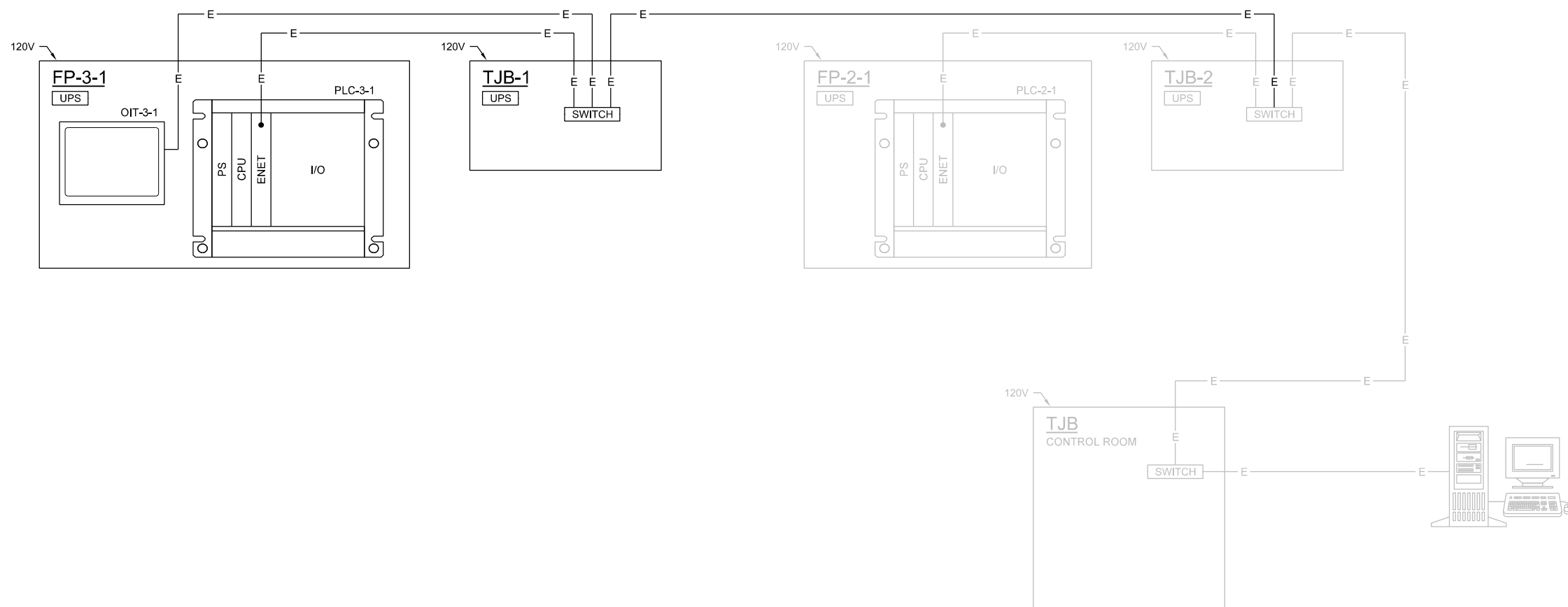

3011 S.W. WILLISTON ROAD
 GAINESVILLE, FLORIDA 32608
 EB0000072 AAC001982
 JESSICA R. KNIGHT PE 72430

SWR SDC
 FOR THE EFFLUENT
 CITY OF KEY WEST
 KEY WEST, FLORIDA

ch2m
 INSTRUMENTATION & CONTROLS
 BLOCK DIAGRAM

VERIFY SCALE BAR IS ONE INCH ON ORIGINAL DRAWING.	
DATE	FEBRUARY 2018
PROJ	691623
DWG	008-N-602
SHEET	of

NO.	DATE	DR	CHK	REVISION	BY	APVD
		J. KNIGHT	G. MESSER			C. WILSON
		DSGN				J. KNIGHT

BID DOCUMENTS

©CH2M HILL 2017. ALL RIGHTS RESERVED.

SHEET KEYNOTES

- PUMPS P-6-2-1 & P-6-2-2 ARE EXISTING. FP-6-3 IS FUTURE. PROVIDE ALL LOGIC IN TRIPLICATE WITH FUTURE FP-6-2-3 OUT OF SEQUENCE BUT READY TO ENABLE.
- NO INTERLOCK IN MANUAL.

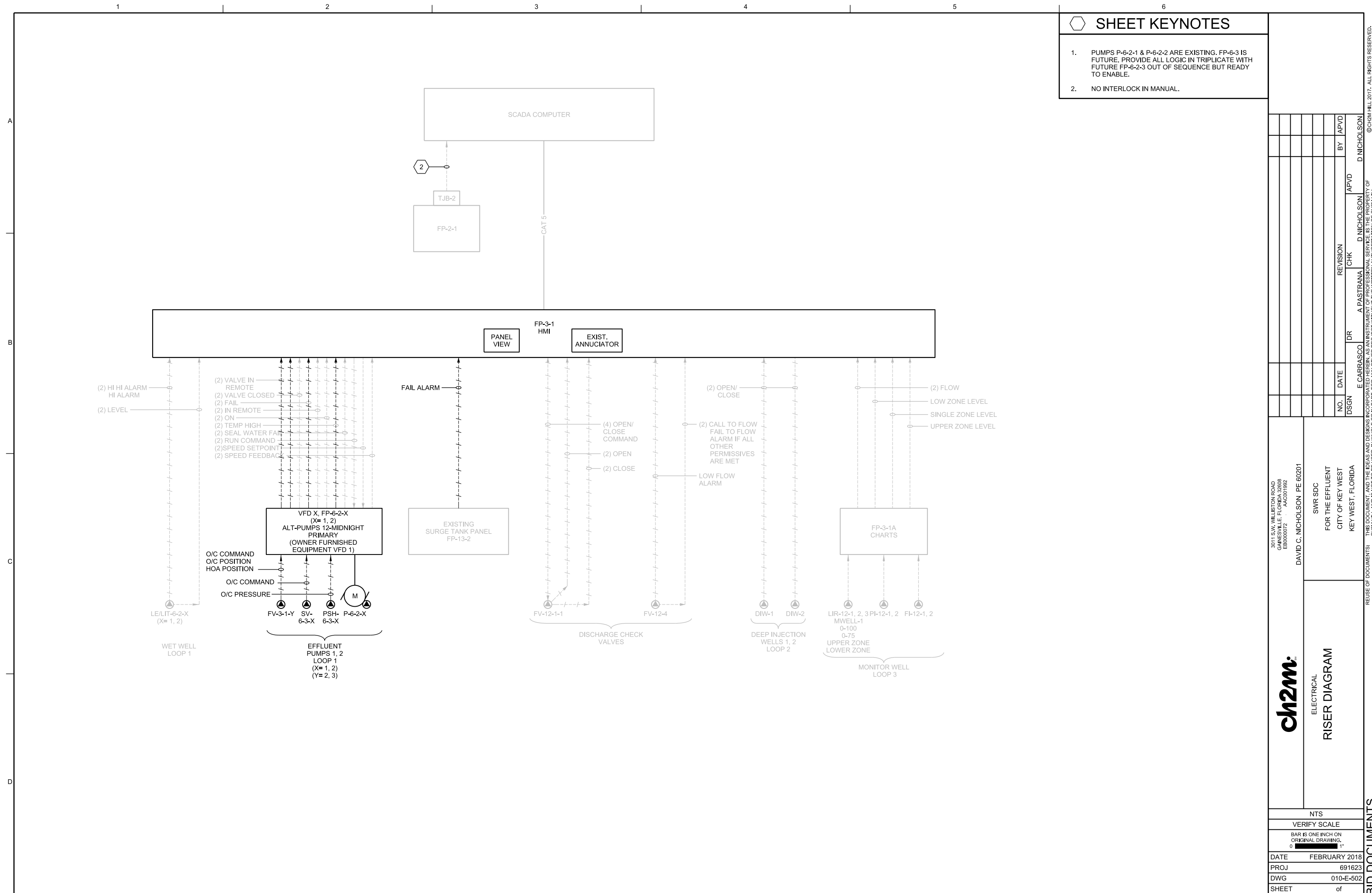

3011 SW WILLISTON ROAD
GAINESVILLE, FLORIDA 32608
EB0000072 AAC001982
DAVID C. NICHOLSON PE 60201

ch2m
ELECTRICAL

RISER DIAGRAM

SWR SDC
FOR THE EFFLUENT
CITY OF KEY WEST
KEY WEST, FLORIDA

DATE	FEBRUARY 2018
PROJ	691623
DWG	010-E-502
SHEET	of

BID DOCUMENTS

REUSE OF DOCUMENTS: THIS DOCUMENT, AND THE IDEAS AND DESIGNS INCORPORATED HEREIN, AS AN INSTRUMENT OF PROFESSIONAL SERVICE, IS THE PROPERTY OF CH2M HILL AND IS NOT TO BE USED, IN WHOLE OR IN PART, FOR ANY OTHER PROJECT WITHOUT THE WRITTEN AUTHORIZATION OF CH2M HILL.

DR E CARRASCO
CHK A PASTRANA
REVISION D NICHOLSON
BY APVD D NICHOLSON

© CH2M HILL 2017. ALL RIGHTS RESERVED.

