



---

### **Staff Report for Item 8a**

**To:** Chairman Bryan Green and Historic Architectural Review  
Commission Members

**From:** Kelly Perkins, MHP  
HARC Assistant Planner

**Meeting Date:** March 22, 2016

**Applicant:** Perez Engineering

**Application Number:** H16-03-0005

**Address:** #323 Whitehead Street

---

### **Description of Work:**

New replacement accessory structure.

### **Site Facts:**

The two accessory structures are located in the interior of this property, known as the Banyan Resort. The accessory structures do not show up in the 1962 Sanborn map or in any historic photographs.

### **Guidelines Cited in Review:**

Outbuildings: Carports, Gazebos, Garages, Sheds, Shelters, & Accessory Structures (Pages 40-41), specifically guidelines 1, 3, and 10.

### **Staff Analysis**

This Certificate of Appropriateness proposes the demolition of two accessory structures that currently serve as a bar and restroom for the Banyan Resort. They are located in the rear of the property. The plan proposes to build one structure in a similar footprint. The frame structure will have lap siding, v-crimp roofing material, ADA accessible path, and large counters for food prep. The structure will be approximately 10 feet, 9 inches tall.

### **Consistency with the Guidelines**

Staff believes the project is consistent with the guidelines in regards to outbuildings. The project will have no impact on any historic structure or any adverse impacts on the historic district.

# APPLICATION

# COMBINATION APPLICATION: FLOODPLAIN, CONSTRUCTION AND HARC

\$50.00 APPLICATION FEE NON-REFUNDABLE



## City of Key West

3140 FLAGLER AVENUE  
KEY WEST, FLORIDA 33040

Phone: 305.809.3956

[www.cityofkeywest-fl.gov](http://www.cityofkeywest-fl.gov)

HARC PERMIT NUMBER		BUILDING PERMIT NUMBER 16-003 00005		INITIAL & DATE	
FLOODPLAIN PERMIT				REVISION #	
FLOOD ZONE	PANEL #	ELEV. L. FL.	SUBSTANTIAL IMPROVEMENT ___ YES ___ NO ___ %		

ADDRESS OF PROPOSED PROJECT:

323 Whitehead Street

# OF UNITS  
1

RE # OR ALTERNATE KEY:

00004550-000100

NAME ON DEED:

Banyan Tree of Key West

PHONE NUMBER  
305-296-7786

OWNER'S MAILING ADDRESS:

323 Whitehead Street

EMAIL  
gm@thebanyanresort.com

Key West, FL 33040

CONTRACTOR COMPANY NAME:

Suncoast Construction, LLC

PHONE NUMBER  
305-923-5556

CONTRACTOR'S CONTACT PERSON:

Jeff Kurkowski

EMAIL  
keysdisease1@msn.com

ARCHITECT / ENGINEER'S NAME:

Perez Engineering & Development

PHONE NUMBER  
305-293-9440

ARCHITECT / ENGINEER'S ADDRESS:

1010 Kennedy Drive, Suite 201

EMAIL  
aperez@perezeng.com

Key West, FL 33040

HARC: PROJECT LOCATED IN HISTORIC DISTRICT OR IS CONTRIBUTING: \_\_\_ YES \_\_\_ NO (SEE PART C FOR HARC APPLICATION.)

CONTRACT PRICE FOR PROJECT OR ESTIMATED TOTAL FOR MAT'L., LABOR & PROFIT:

FLORIDA STATUTE 837.06: WHOEVER KNOWINGLY MAKES A FALSE STATEMENT IN WRITING AND WITH THE INTENT TO MISLEAD A PUBLIC SERVANT IN THE PERFORMANCE OF HIS OR HER OFFICIAL DUTY SHALL BE GUILTY OF A MISDEMEANOR OF THE SECOND DEGREE PUNISHABLE PER SECTION 775.082 OR 775.083.

PROJECT TYPE: \_\_\_ ONE OR TWO FAMILY \_\_\_ MULTI-FAMILY  COMMERCIAL \_\_\_ NEW  REMODEL  
 \_\_\_ CHANGE OF USE / OCCUPANCY \_\_\_ ADDITION \_\_\_ SIGNAGE \_\_\_ WITHIN FLOOD ZONE  
 DEMOLITION \_\_\_ SITE WORK  INTERIOR  EXTERIOR \_\_\_ AFTER-THE-FACT

DETAILED PROJECT DESCRIPTION INCLUDING QUANTITIES, SQUARE FOOTAGE ETC.,

Demolition of non-contributing structures. Replace with ADA compliant restroom & food prep building (+/- 220 SF),  
 and covered bar area (+/- 80 SF). Lap siding to be installed & V-crimp metal roof typical.

I'VE OBTAINED ALL NECESSARY APPROVALS FROM ASSOCIATIONS, GOV'T AGENCIES AND OTHER PARTIES AS APPLICABLE TO COMPLETE THE DESCRIBED PROJECT:	
OWNER PRINT NAME: MEGHAN E. HEAPS	QUALIFIER PRINT NAME:
OWNER SIGNATURE: <i>Meghan E. Heaps</i>	QUALIFIER SIGNATURE:
Notary Signature as to owner: <i>J. E. Sachat</i>	Notary Signature as to qualifier:
STATE OF FLORIDA; COUNTY OF MONROE, SWORN TO AND SCRIBED BEFORE ME THIS <u>26</u> DAY OF <u>January</u> , 20 <u>16</u> .	STATE OF FLORIDA; COUNTY OF MONROE, SWORN TO AND SCRIBED BEFORE ME THIS _____ DAY OF _____, 20_____.
	Oper: KEYWBLD Type: BP Drawer: 1 Date: 2/01/16 50 Receipt no: 9072 2016 300005 * BUILDING PERMITS IDENTIFICATION.
Personally known or produced _____ as identification.	Personally known or produced _____ as identification.

CK CHECK 1.00 \$100.00  
 8369 \$100.00  
 Total tendered \$100.00  
 Total payment \$100.00

**PART B: SUPPLEMENTARY PROJECT DETAILS TO AVOID DELAYS / CALL-BACKS**

PROPERTY STRUCTURES AFFECTED BY PROJECT:  MAIN STRUCTURE  ACCESSORY STRUCTURE  SITE

ACCESSORY STRUCTURES:  GARAGE / CARPORT  DECK  FENCE  OUTBUILDING / SHED

FENCE STRUCTURES:  4 FT.  6 FT. SOLID  6 FT. / TOP 2 FT. 50% OPEN

POOLS:  INGROUND  ABOVE GROUND  SPA / HOT TUB  PRIVATE  PUBLIC  
 PUBLIC POOLS REQUIRE BD. OF HEALTH LICENSE APPLICATION AT TIME OF CITY APPLICATION.  
 PUBLIC POOLS REQUIRE BD. OF HEALTH LICENSE PRIOR TO RECEIVING THE CITY CERTIFICATE OF OCCUPANCY.

ROOFING:  NEW  ROOF-OVER  TEAR-OFF  REPAIR  AWNING  
 5 V METAL  ASPLT. SHGLS.  METAL SHGLS.  BLT. UP  TPO  OTHER

FLORIDA ACCESSIBILITY CODE:  20% OF PROJECT FUNDS INVESTED IN ACCESSIBILITY FEATURES.

SIGNAGE:  # OF SINGLE FACE  # OF DOUBLE FACE  REPLACE SKIN ONLY  BOULEVARD ZONE  
 POLE  WALL  PROJECTING  AWNING  HANGING  WINDOW  
 SQ. FT. OF EACH SIGN FACE: \_\_\_\_\_

SUBCONTRACTORS / SPECIALTY CONTRACTORS SUPPLEMENTARY INFORMATION:

MECHANICAL:  DUCTWORK  COMMERCIAL EXH. HOOD  INTAKE / EXH. FANS  LPG TANKS  
 A / C:  COMPLETE SYSTEM  AIR HANDLER  CONDENSER  MINI-SPLIT

ELECTRICAL:  LIGHTING  RECEPTACLES  HOOK-UP EQUIPMENT  LOW VOLTAGE  
 SERVICE:  OVERHEAD  UNDERGROUND  1 PHASE  3 PHASE \_\_\_\_\_ AMPS

PLUMBING:  ONE SEWER LATERAL PER BLDG.  INGROUND GREASE INTCPTRS.  LPG TANKS

RESTROOMS:  MEN'S  WOMEN'S  UNISEX  ACCESSIBLE

**PART C: HARC APPLICATION FOR A CERTIFICATE OF APPROPRIATENESS**

APPLICATION FEES: PAINTING SINGLE FAMILY: \$10 STAFF APPROVAL: \$50 COMMISSION REVIEW \$100  
 PLEASE ATTACH APPROPRIATE VARIANCES / RESOLUTIONS FROM HARC, PLANNING BOARD OR TREE COMMISSION.  
 ATTENTION: NO BUILDING PERMITS WILL BE ISSUED PRIOR TO HARC APPROVAL.

PLEASE SEND ELECTRONIC SUBMISSIONS TO: [harc@cityofkeywest-fl.gov](mailto:harc@cityofkeywest-fl.gov)  
 INDICATE TYPE OF CERTIFICATE. OF APPROPRIATENESS:  GENERAL  DEMOLITION  SIGN  PAINTING  OTHER

ADDITIONAL INFORMATION: \_\_\_\_\_

PROJECT SPECIFICATIONS: PLEASE PROVIDE PHOTOS OF EXISTING CONDITIONS, PLANS, PRODUCT SAMPLES, TECHNICAL DATA		
ARCHITECTURAL FEATURES TO BE ALTERED:	ORIGINAL MATERIAL:	PROPOSED MATERIAL:

DEMOLITION: PLEASE FILL OUT THE HARC APPENDIX FOR PROPOSED DEMOLITION.

DEMOLITION OF HISTORIC STRUCTURES IS NOT ENCOURAGED BY THE HISTORIC ARCHITECTURAL REVIEW COMMISSION.

SIGNAGE: (SEE PART B)  BUSINESS SIGN  BRAND SIGN  OTHER: \_\_\_\_\_

BUSINESS LICENSE # \_\_\_\_\_ IF FAÇADE MOUNTED, SQ. FT. OF FAÇADE \_\_\_\_\_

SIGN SPECIFICATIONS		
SIGN COPY:	PROPOSED MATERIALS:	SIGNS WITH ILLUMINATION:
		TYPE OF LTG.:
		LTG. LINEAL FTG.:
MAX. HGT. OF FONTS:		COLOR AND TOTAL LUMENS:
IF USING LIGHT FIXTURES PLEASE INDICATE HOW MANY: INCLUDE SPEC. SHEET WITH LOCATIONS AND COLORS.		

OFFICIAL USE ONLY: HARC STAFF OR COMMISSION REVIEW		
<input type="checkbox"/> APPROVED <input type="checkbox"/> NOT APPROVED <input type="checkbox"/> DEFERRED FOR FUTURE CONSIDERATION <input type="checkbox"/> TABLED FOR ADD'L. INFO.		
HARC MEETING DATE:	HARC MEETING DATE:	HARC MEETING DATE:
REASONS OR CONDITIONS:		
STAFF REVIEW COMMENTS:		
HARC PLANNER SIGNATURE AND DATE:		HARC CHAIRPERSON SIGNATURE AND DATE:

**PART D: STATE OF FLORIDA OFFICIAL NOTIFICATIONS AND WARNINGS**

FLORIDA STATUTE 713.135: WARNING TO OWNER: YOUR FAILURE TO RECORD A 'NOTICE OF COMMENCEMENT' MAY RESULT IN YOUR PAYING TWICE FOR IMPROVEMENTS TO YOUR PROPERTY. A NOTICE OF COMMENCEMENT MUST BE RECORDED WITH THE COUNTY RECORDER AND A COPY POSTED ON THE JOB SITE BEFORE THE FIRST INSPECTION. IF YOU INTEND TO OBTAIN FINANCING CONSULT WITH YOUR LENDER OR AN ATTORNEY BEFORE RECORDING A NOTICE.

FLORIDA STATUTE 469: ABESTOS ABATEMENT. AS OWNER / CONTRACTOR / AGENT OF RECORD FOR THE CONSTRUCTION APPLIED FOR IN THIS APPLICATION, I AGREE THAT I WILL COMPLY WITH THE PROVISIONS F. S. 469.003 AND TO NOTIFY THE FLORIDA D. E. P. OF MY INTENT TO DEMOLISH / REMOVE ASBESTOS. IN ADDITION TO THE REQUIREMENTS OF THIS PERMIT APPLICATION, THERE MAY BE DEED RESTRICTIONS AND / OR ADDITIONAL RESTRICTIONS APPLICABLE TO THIS PROPERTY THAT MAY BE FOUND IN THE PUBLIC RECORDS OF MONROE COUNTY AND THERE MAY BE ADDITIONAL PERMITS REQUIRED FROM OTHER GOVERNMENT ENTITIES SUCH AS AQUADUCT AUTHORITY, FLORIDA DEP OR OTHER STATE AGENCIES; ARMY CORPS OF ENGINEERS OR OTHER FEDERAL AGENCIES.

FEDERAL LAW REQUIRES LEAD PAINT ABATEMENT PER THE STANDARDS OF THE USDEP ON STRUCTURES BUILT PRIOR TO 1978.

OFFICIAL USE ONLY BY PLANS EXAMINER OR CHIEF BUILDING OFFICIAL:				CBO OR PL. EXAM. APPROVAL:
HARC FEES:	BLDG. FEES:	FIRE MARSHAL FEE:	IMPACT FEES:	DATE:

*OK with Planning  
- PW  
3-2-14*

# SANBORN MAPS

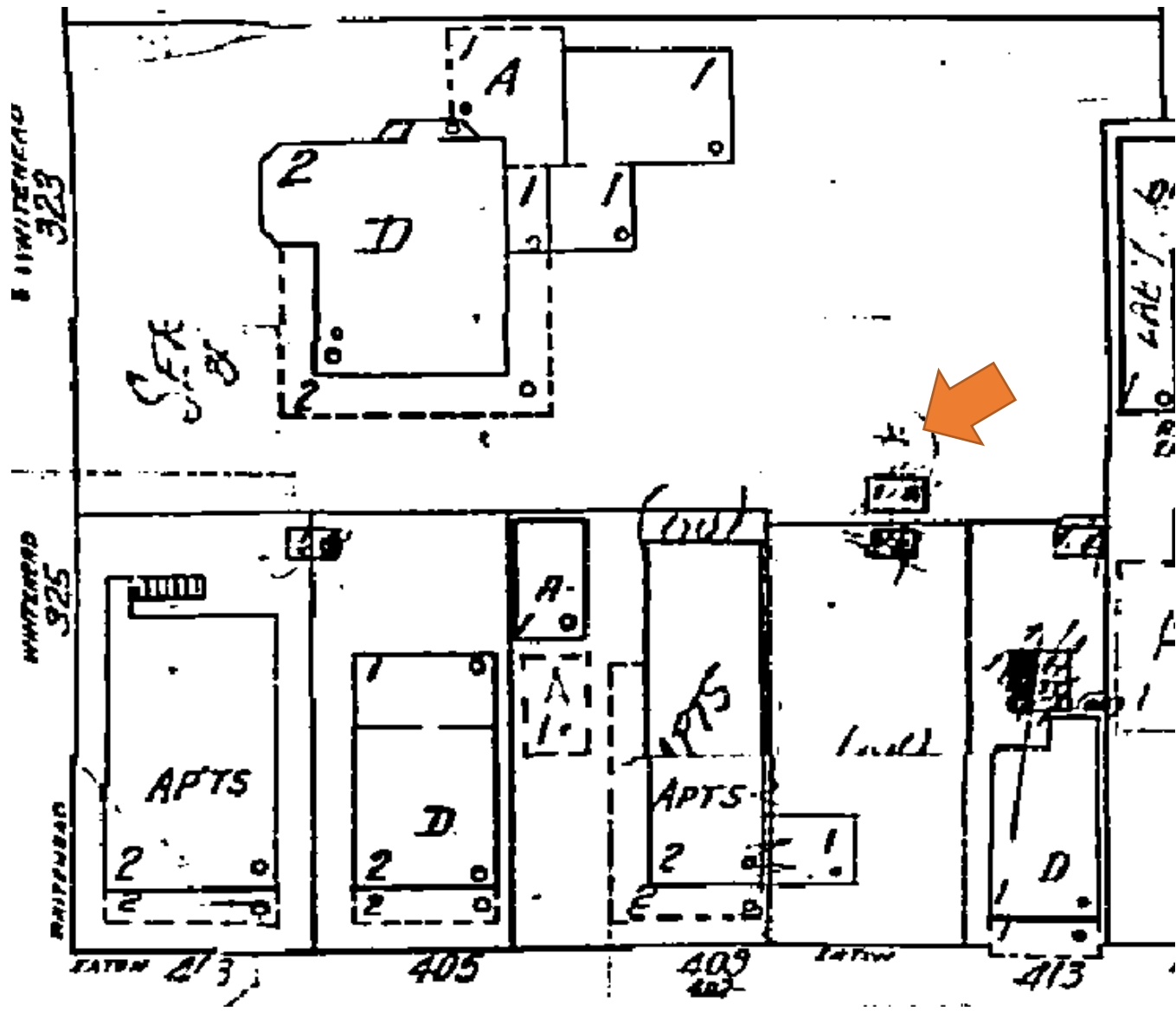

1962 Sanborn Map



# PROJECT PHOTOS



Property Appraiser's Photo, c. 1965. Monroe County Public Library.

323 WHITEHEAD STREET – PICTURES OF EXISTING STRUCTURES



**EXISTING STRUCTURE - FRONT VIEW**



**EXISTING STRUCTURE - REAR VIEW**

323 WHITEHEAD STREET – PICTURES OF EXISTING STRUCTURES



**EXISTING TIKI BAR**



**EXISTING TIKI BAR**

# SURVEY

# Specific Purpose Survey Map to illustrate the location of the Tiki Bar & adjacent accessory building in relation to existing structures located at the Banyan Tree of Key West Condominium

*SPECIFIC PURPOSE SURVEY OF:* In the City of Key West, County of Monroe and State of Florida, being a part of Lot Four (4) of Square Twenty-Five (25) according to William A. Whitehead's map delineated in February A.D. 1829.

*SPECIFIC PURPOSE SURVEY FOR:*

Banyan Tree of Key West Condominium;

I HEREBY CERTIFY that this survey was made under my responsible charge and meets the Standard of Practice as set forth by the Florida Board of Professional Surveyors & Mappers in Chapter 5J-17, Florida Administrative Code, pursuant to Section 472.027, Florida Statutes.

J. LYNN O'FLYNN, INC.

J. Lynn O'Flynn, PSM  
Florida Reg. #6298

February 23, 2016

THIS SURVEY  
IS NOT  
ASSIGNABLE

**NOTES:**

1. The legal description shown hereon was furnished by the client or their agent. This survey does not determine or imply ownership.
2. Underground foundations and utilities were not located.
3. All angles are 90° (Measured & Record) unless otherwise noted.
4. Street address: 323 Whitehead Street, Key West, FL.
5. This survey is not valid without the signature and the original raised seal of a Florida licensed surveyor and mapper.
6. Lands shown hereon were not abstracted for rights-of-way, easements, ownership, or other instruments of record.
7. Bearings are assumed and based on the Northwesternly right of way of Eaton Street as N55°50'30"E.
8. Date of field work: January 30, 2016 and February 22, 2016.
9. Adjoiners are not furnished.

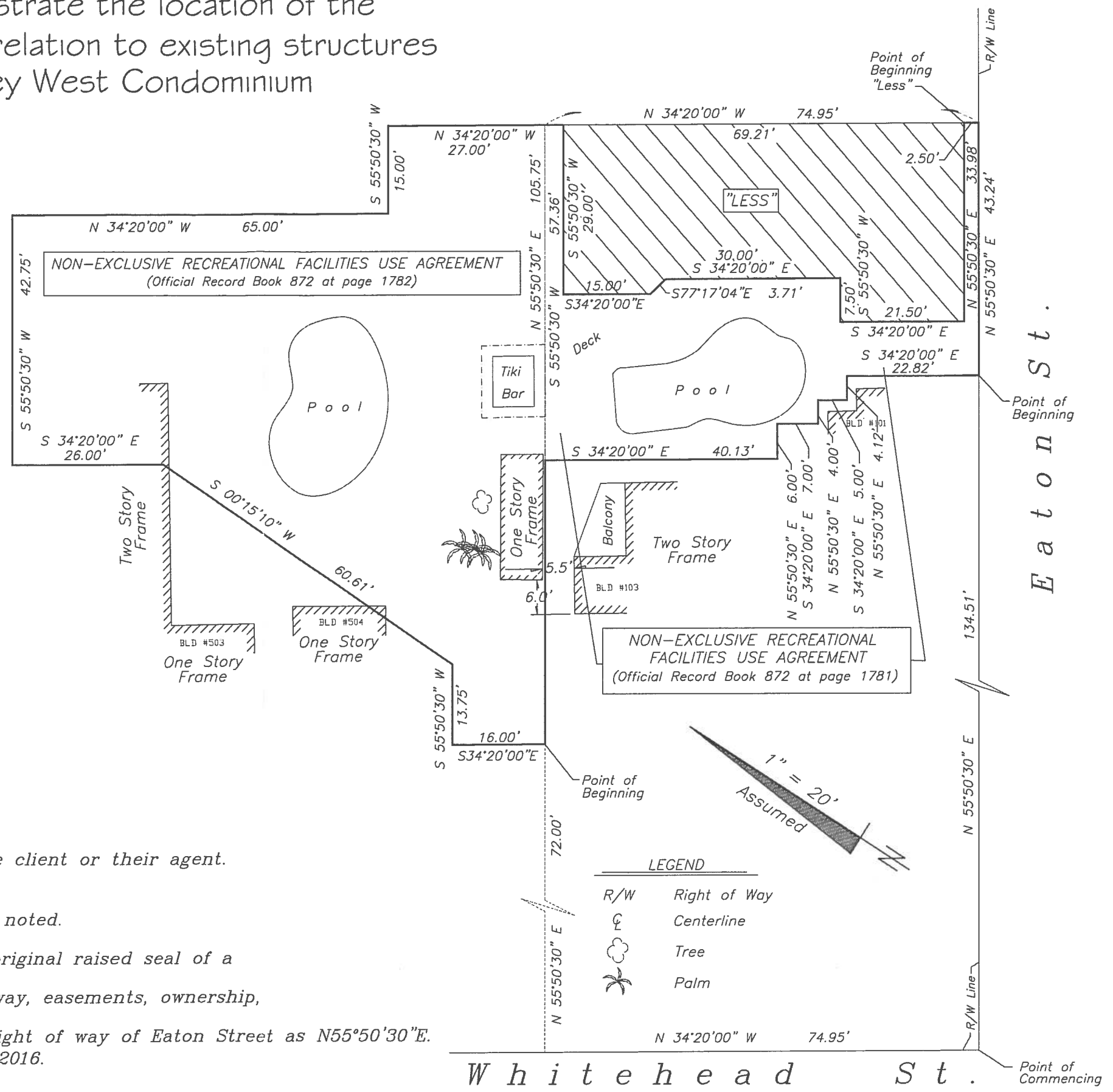

LEGEND

R/W	Right of Way
⊕	Centerline
☁	Tree
🌴	Palm

# PROPOSED DESIGN

### SITE DATA

ZONING DISTRICT: HRO  
 FLOOD ZONE: X  
 F.I.R.M. - COMMUNITY #120168; PANEL #1516; SUFFIX "K"; DATED: 02-18-2005  
 LEGAL DESCRIPTION: PART OF LOT 4, SQUARE 25, ISLAND OF KEY WEST

### DESIGN DATA

THE WORK DEPICTED HEREIN WAS DESIGNED TO MEET THE REQUIREMENTS OF THE FLORIDA BUILDING CODE, 5TH EDITION (2014) AND THE LATEST EDITIONS OF THE FLORIDA MODEL ENERGY CODE, FIRE CODE, LIFE SAFETY CODE AND THE NATIONAL ELECTRIC CODE.

OCCUPANCY CLASSIFICATION: M  
 CONSTRUCTION TYPE: V

THE FOLLOWING LOADINGS WERE USED:  
 WIND LOAD: 180 MPH (ASCE 7-10) EXPOSURE D  
 FLOOR LIVE LOAD: 40 PSF

### INDEX OF DRAWINGS

- T-1 - SITE DATA
- A-1 - FLOOR PLANS / ROOF PLAN
- A-2 - ELEVATIONS
- A-3 - ELEVATIONS

### GENERAL NOTES

1. THESE PLANS ARE FOR THE WORK AT THE LOCATION SO DESIGNATED HEREIN.
2. THE CONTRACTOR SHALL PROVIDE ALL MATERIAL, LABOR, EQUIPMENT AND SUPERVISION NECESSARY TO PROVIDE THE WORK COMPLETE AND READY FOR USE.
3. THERE SHALL BE NO DEVIATION FROM THESE PLANS WITHOUT PRIOR APPROVAL FROM THE ENGINEER OF RECORD.
4. THE CONTRACTOR SHALL VISIT THE SITE AND BECOME FAMILIAR WITH EXISTING CONDITIONS BEFORE BID. CHECK AND VERIFY ALL DIMENSIONS AND CONDITIONS OF THE WORK SITE AND REPORT ANY DISCREPANCIES, DIFFERENCES OR CONDITIONS THAT ARE UNSATISFACTORY OR UNSAFE.
5. NOTIFY THE ENGINEER OF RECORD IMMEDIATELY OF ANY DISCREPANCIES, DIFFERENCES, UNSATISFACTORY OR UNSAFE CONDITIONS. ANY MODIFICATIONS OR CHANGES MADE WITHOUT PRIOR WRITTEN APPROVAL FROM THE OWNER AND ENGINEER OF RECORD SHALL NOT BE ALLOWED. ANY REWORK, RESTORATION OR OTHER IMPACT AS A RESULT OF NOT OBTAINING SUCH PRIOR APPROVAL WILL BE MADE BY THE CONTRACTOR WITHOUT ADDITIONAL COST OR COMPENSATION FROM THE OWNER.
6. THE CONTRACTOR SHALL PROVIDE FOR THE SAFETY, PREVENTION OF INJURY OR OTHER LOSS AT THE JOB TO ALL PERSONS EMPLOYED IN THE WORK, PERSONS VISITING THE WORK AND THE GENERAL PUBLIC. THE CONTRACTOR SHALL ALSO BE RESPONSIBLE FOR THE PREVENTION OF DAMAGE, DUE TO THE WORK, TO MATERIALS OR EQUIPMENT AND OTHER PROPERTY AT THE SITE OR ADJACENT THERETO.
7. NO RESEARCH AS TO THE PRESENCE OF UNDERGROUND UTILITIES HAS BEEN INCLUDED ON OR PERFORMED FOR THIS PROJECT. CONTRACTOR SHALL BE RESPONSIBLE FOR CALLING SUNSHINE UTILITY LOCATE SERVICE PRIOR TO ANY CONSTRUCTION WITHIN ANY PUBLIC RIGHT-OF-WAY OR OTHER AREAS WHERE UNDERGROUND UTILITIES MAY BE PRESENT (I.E. IN AND AROUND UTILITY EASEMENTS, ETC.)
8. THE GENERAL CONTRACTOR SHALL PROVIDE AN ON-SITE DUMPSTER IN A LOCATION COORDINATED WITH THE OWNER FOR THE DISPOSAL OF REMOVED MATERIAL AND CONSTRUCTION DEBRIS. THE DUMPSTER SHALL BE EMPTIED AT APPROPRIATE INTERVALS TO PREVENT OVERFLOW AND UNSIGHTLY CONDITIONS.
9. THE CONTRACTOR SHALL PERFORM ALL WORK IN STRICT CONFORMANCE WITH THE PLANS, FLORIDA BUILDING CODE, FIFTH EDITION (2014) LOCAL CODES AND ORDINANCES, MANUFACTURER RECOMMENDATIONS AND ACCEPTABLE TRADE PRACTICES. ANY CONFLICT BETWEEN THESE REQUIREMENTS AND THE MOST STRINGENT REQUIREMENTS SHALL GOVERN THE WORK.
10. SHOP DRAWINGS OF ALL PREFABRICATED STRUCTURAL FLOOR AND ROOF SYSTEMS AND MECHANICAL SYSTEMS SHALL BEAR THE SEAL OF A FLORIDA PROFESSIONAL ENGINEER AS REQUIRED BY THE FLORIDA BUILDING CODE, FIFTH EDITION (2014), AND SHALL BE SUBMITTED TO THE ENGINEER OF RECORD BY THE CONTRACTOR FOR APPROVAL PRIOR TO FABRICATION AND INSTALLATION.
11. THE CONTRACTOR SHALL NOT SCALE DRAWINGS. ANY INFORMATION THAT THE CONTRACTOR CANNOT OBTAIN FROM DIMENSIONS, DETAIL OR SCHEDULE SHALL BE OBTAINED FROM THE ENGINEER OF RECORD.
12. THE CONTRACTOR SHALL COORDINATE THE WORK OF ALL TRADES TO PREVENT ANY CONFLICTS.
13. THE CONTRACTOR SHALL FURNISH ALL SUBCONTRACTORS WITH A COMPLETE SET OF PLANS. ALL CHANGES SHALL BE NOTED ON THE DRAWINGS AND (2) COMPLETE AS-BUILT SETS SHALL BE DELIVERED TO THE OWNER AFTER COMPLETION OF WORK.

	EXISTING CONDITIONS	PROPOSED CONDITIONS
ZONE	HRO	HRO
BUILDING AREA (BAR & RESTROOM)	305 SF	472 SF
BUILDING HEIGHT ABOVE GRADE	9'-4"	10'-10"

# ACCESSORY STRUCTURE

## 323 WHITEHEAD STREET KEY WEST, FLORIDA

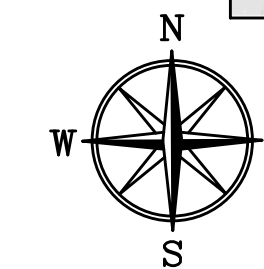

LOCATION MAP

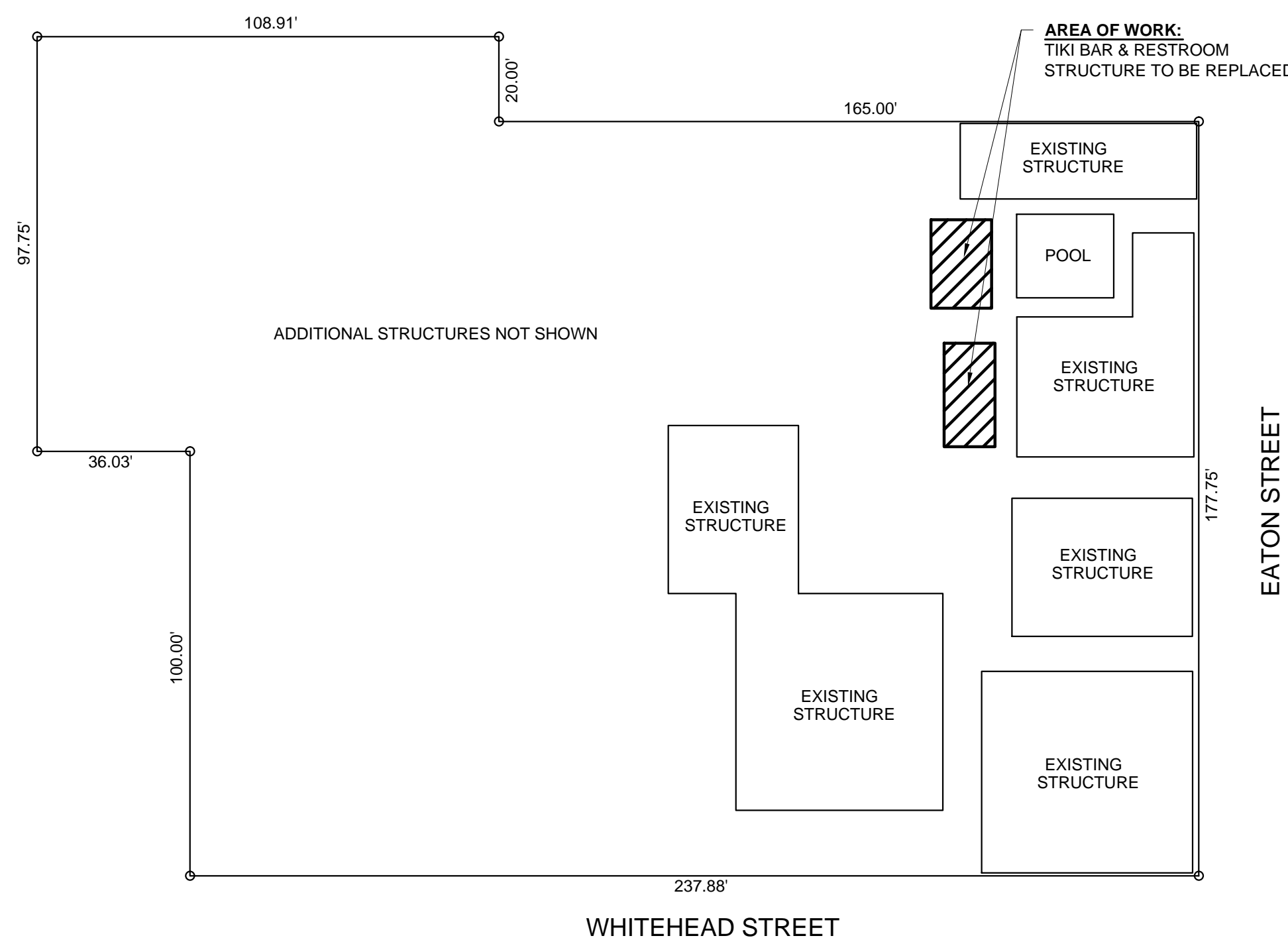

SITE PLAN

SCALE: 1"=30'-0"

CIVIL ENGINEERING • REGULATORY PERMITTING • CONSTRUCTION MANAGEMENT

**PEREZ ENGINEERING & DEVELOPMENT, INC.**

KEY WEST OFFICE  
 1010 EAST WHITEHEAD STREET 201  
 KEY WEST, FLORIDA 33040  
 TEL: (305) 299-9440 FAX: (305) 299-0243

CERTIFICATE OF AUTHORIZATION No. 18579

PAUL R. SEMMES, P.E.  
 Florida P.E. NO. 44137  
 January 29, 2016

REVISIONS:	ORIGINAL:
1	
2	
3	
4	
5	
6	

ACCESSORY STRUCTURE

BANYAN RESORT  
 323 WHITEHEAD STREET  
 KEY WEST, FL 33040

JOB NO.	151068
DRAWN	BGO
DESIGNED	PRS
CHECKED	PRS
QC	
SHEET	



## WOOD AND FRAMING NOTES

- EXCEPT WHERE NOTED OTHERWISE, ALL FRAMING LUMBER SHALL BE SOUTHERN PINE, MC 19%, NO. 2 DENSE, AS GRADED BY THE SOUTHERN PINE INSPECTION BUREAU.
- ALL TIMBER CONSTRUCTION SHALL CONFORM TO THE LATEST EDITION AFTC.
- ALL WOOD SHALL BE PRESSURE TREATED WITH CHEMICALS TO PROTECT FROM INSECTS AND DECAY AS REQUIRED. ALLOW TO DRY AFTER TREATMENT. PROVIDE CONNECTORS AND FASTENERS COMPATIBLE WITH PRESSURE TREATED WOOD FRAMING. PROVIDE SEPARATION BARRIER SUCH AS BUILDING PAPER FOR NON-COMPATIBLE COMPONENTS SUCH AS ALUMINUM WINDOW FRAMES.
- ALL WOOD CONNECTIONS SHALL HAVE SIMPSON STRONG-TIE CO. OR EQUAL CONNECTORS. ALL CONNECTORS SHALL BE INSTALLED WITH MANUFACTURER RECOMMENDED FASTENERS BEFORE LOADING.
- CUTTING AND NOTCHING OF FLOOR JOISTS SHALL CONFORM TO THE FOLLOWING:
  - NOTCH DEPTH IN THE TOP OR BOTTOM OF THE JOISTS AND BEAMS SHALL NOT EXCEED ONE-SIXTH OF THE DEPTH OF THE MEMBER AND SHALL NOT BE LOCATED IN THE MIDDLE ONE-THIRD OF THE SPAN. (INCLUDING BIRDS MOUTH CUTS).
  - NOTCH DEPTH AT THE ENDS OF THE MEMBER SHALL NOT EXCEED ONE-FOURTH THE DEPTH OF THE MEMBER.
  - THE TENSION SIDE OF BEAMS, JOISTS AND RAFTERS OF FOUR INCHES OR GREATER NOMINAL THICKNESS SHALL NOT BE NOTCHED, EXCEPT AT ENDS OF MEMBERS.
  - HOLES BORED OR CUT INTO JOISTS SHALL NOT BE CLOSER THAN TWO INCHES TO THE TOP OF BOTTOM OF THE JOISTS. THE DIAMETER OF THE HOLE SHALL NOT EXCEED ONE-THIRD THE MEMBER DEPTH.
  - PROVIDE SECOND FLOOR JOIST MEMBER, SAME SIZE, UNDER ALL WALLS.
  - HOLES BORED IN BEARING WALL STUDS SHALL NOT EXCEED ONE-THIRD OF STUD.
  - PROVIDE 1X4 PRESSURE TREATED FURRING AT 16" CC FOR ALL TRUSSES THAT WILL HAVE A FINISHED CEILING BELOW UNLESS NOTED OTHERWISE.
  - PROVIDE BLOCKING BETWEEN ALL JOISTS 2 X 6 OR GREATER AT INTERVALS NOT TO EXCEED 8 FEET AND AT ALL SUPPORTS.
  - PROVIDE SOLID BLOCKING AT MID HEIGHT ON CENTER BETWEEN STUDS. (MINIMUM).
  - ALL WALL STUDS SHALL BE SPF NO. 2 DENSE GRADE OR BETTER.
  - SEE PLANS FOR WALL STUD SIZE AND SPACING.
  - ALL STUD BEARING WALLS SHALL BE PROVIDED WITH 2 CONTINUOUS TOP PLATES AND CONTINUOUS BOTTOM PLATES WITH A MINIMUM OF ONE ROW OF HORIZONTAL BRIDGING AT MID-HEIGHT OF WALL UNLESS NOTED OTHERWISE. SPLICES OF TOP PLATE SHALL OCCUR OVER STUD. SPLICES SHALL BE STAGGERED A MINIMUM OF FOUR FEET.
  - HEADER BEAMS OVER ALL FRAMED OPENINGS SHALL BE AS SHOWN BELOW, UNLESS NOTED OTHERWISE.
    - 2 X 6 FOR INTERIOR OPENINGS UP TO 4'-0", (3) 2 X 6 FOR EXTERIOR OPENINGS UP TO 4'-0"
    - 2 X 8 FOR INTERIOR OPENINGS UP TO 6'-0", (3) 2 X 8 FOR EXTERIOR OPENINGS UP TO 6'-0"
    - 2 X 10 FOR INTERIOR OPENINGS UP TO 8'-0", (3) 2 X 10 FOR EXTERIOR OPENINGS UP TO 8'-0"
    - 2 X 12 FOR INTERIOR OPENINGS UP TO 10'-0", (3) 2 X 12 FOR EXTERIOR OPENINGS UP TO 10'-0"
  - EXTERIOR WALL STUDS SHALL BE STRAPPED TO ROOF TRUSSES OR RAFTERS WITH SIMPSON CONNECTORS OR EQUAL. PROVIDE 3 STUDS (MIN.) FOR GIRDER TRUSS AND BEAM BEARING POINTS.
  - WHERE WOOD JOISTS/BEAMS ETC. FRAME INTO OTHER MEMBERS INSTALL SIMPSON "LUS" SERIES GALVANIZED JOIST HANGERS.
  - FIRESTOPPING SHALL BE PROVIDED IN ALL WALLS AND PARTITIONS TO SEAL ALL CONCEALED DRAFT OPENINGS BOTH HORIZONTAL AND VERTICAL AND TO FORM A FIRE BARRIER BETWEEN FLOORS AND BETWEEN THE UPPER FLOOR AND THE ROOF SPACE.
  - FIRESTOPPING SHALL BE INSTALLED IN WOOD FRAME CONSTRUCTION IN THE FOLLOWING LOCATIONS:
    - IN CONCEALED SPACE OF STUD WALLS AND PARTITIONS INCLUDING FURRED SPACES AT CEILING AND FLOOR LEVELS.
    - AT ALL INTERCONNECTIONS BETWEEN CONCEALED VERTICAL AND HORIZONTAL SPACES SUCH AS OCCUR AT SOFFITS, DROP CEILINGS, COVER CEILING, ETC.
    - IN CONCEALED SPACES BETWEEN STAIR STRINGERS AT THE TOP AND BOTTOM OF THE RUN.
    - IN CONCEALED SPACES CREATED BY AN ASSEMBLY OF FLOOR JOISTS. FIRESTOPPING SHALL BE PROVIDED TO THE FULL DEPTH OF THE JOISTS AT THE ENDS AND OVER THE SUPPORTS.
  - FIRESTOPPING SHALL CONSIST OF TWO (2) INCH NOMINAL LUMBER, OR TWO (2) THICKNESS OF ONE (1) INCH NOMINAL LUMBER WITH BROKEN LAP JOISTS, OR ONE (1) THICKNESS OF THREE-FOURTHS (3/4) INCH PLYWOOD WITH JOINTS BACKED BY THREE-FOURTHS (3/4) INCH PLYWOOD, OR OTHER APPROVED MATERIALS.
  - SOLID DECKING SHALL BE TONGUE & GROOVE, SOUTHERN PINE, SELECT GRADE OF 3/4" X 6", NOMINAL SIZE AND PLACED IN A CONTINUOUS RANDOM LAY. THE 3/4" X 6" SHALL BE TOE-NAILED THROUGH THE TONGUE AND FACE-NAILED WITH TWO NAILS PER SUPPORT USING 16D COMMON NAILS.
  - PLYWOOD DECKING SHALL BE IN ACCORDANCE WITH RECOMMENDATIONS OF THE AMERICAN PLYWOOD ASSOCIATION (APA). PLYWOOD SHEATHING SHALL BE APA STRUCTURAL I, IDENTIFIED WITH APA GRADE-TRADEMARK AND SHALL MEET THE REQUIREMENTS OF US PRODUCT STANDARD PS1 OR APA PRP-108. ALL PLYWOOD WITH AN EDGE EXPOSED TO THE EXTERIOR SHALL BE EXTERIOR GRADE. FLOOR DECKING SHALL BE 3/4" MINIMUM AND GLUED AND FASTENED TO FLOOR FRAMING. ROOF DECKING SHALL BE 3/4" MINIMUM AND NAILED WITH 8D NAILS @ 6" IN THE FIELD AND 4" ALONG THE EDGES.

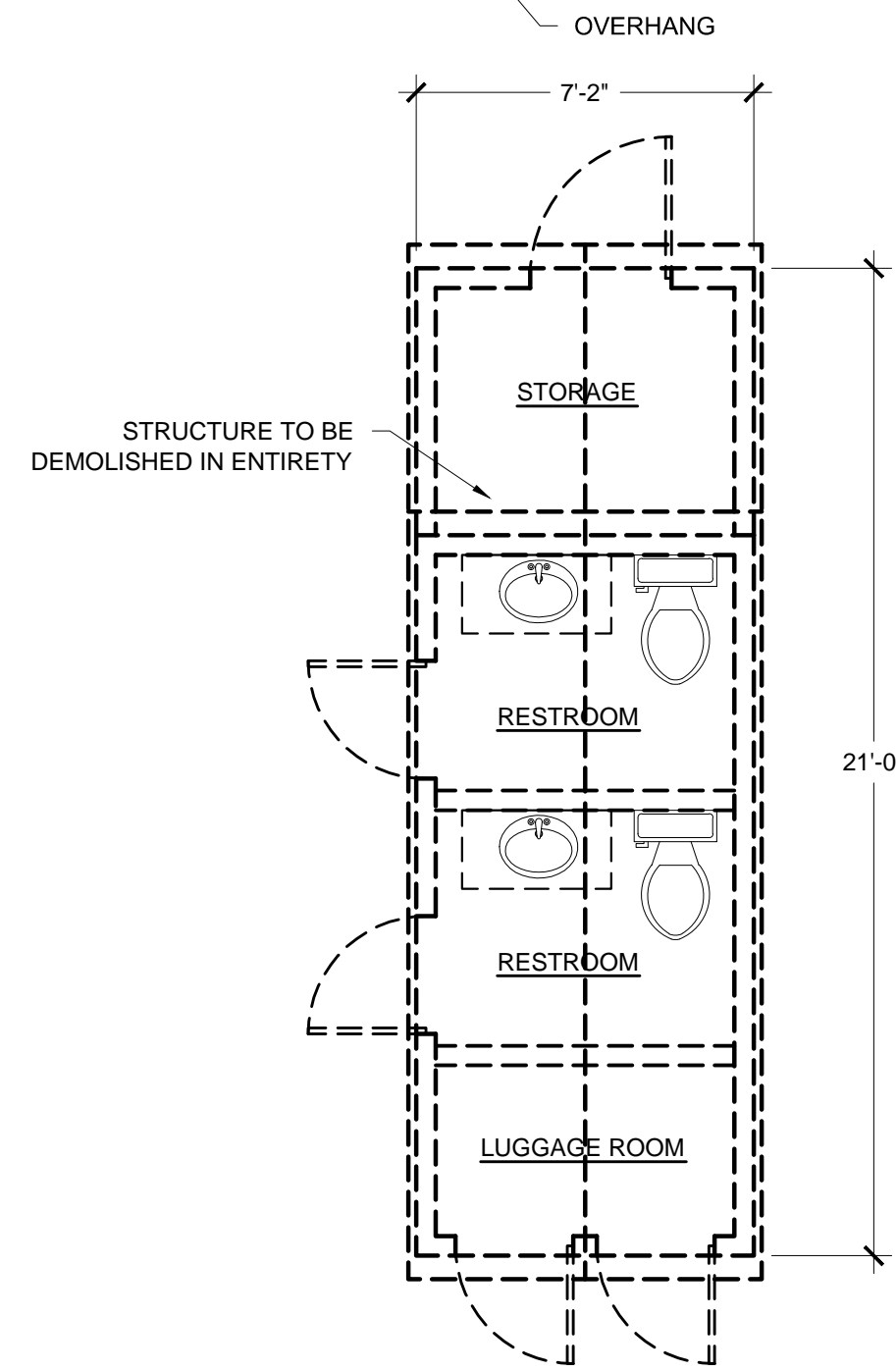
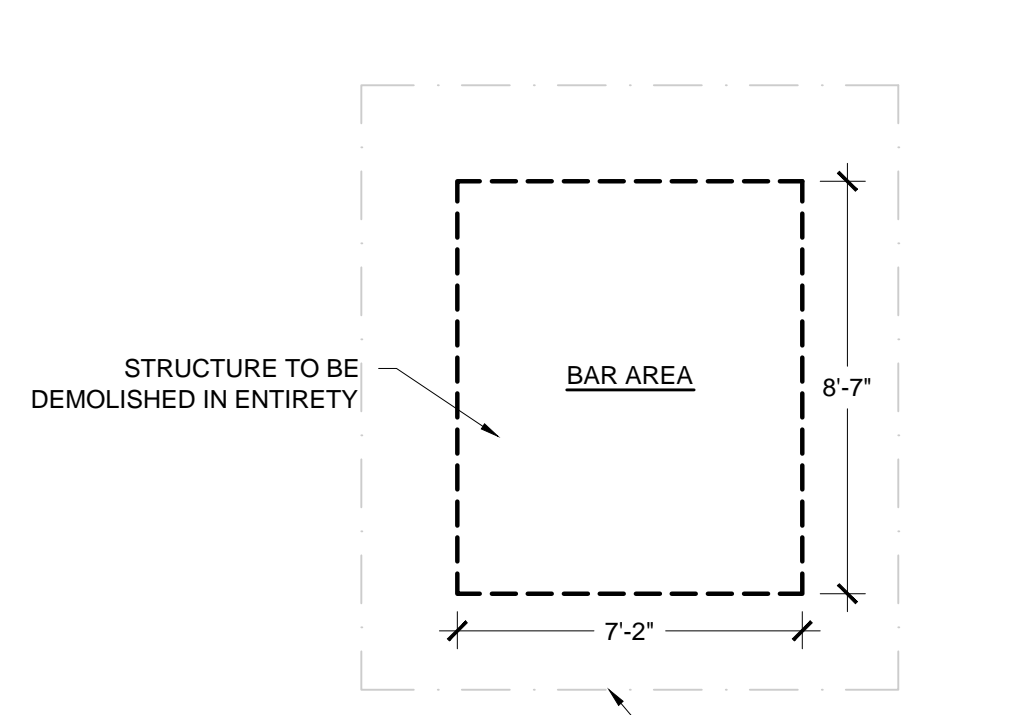

EXISTING FLOOR PLAN

SCALE: 1/4"=1'-0"

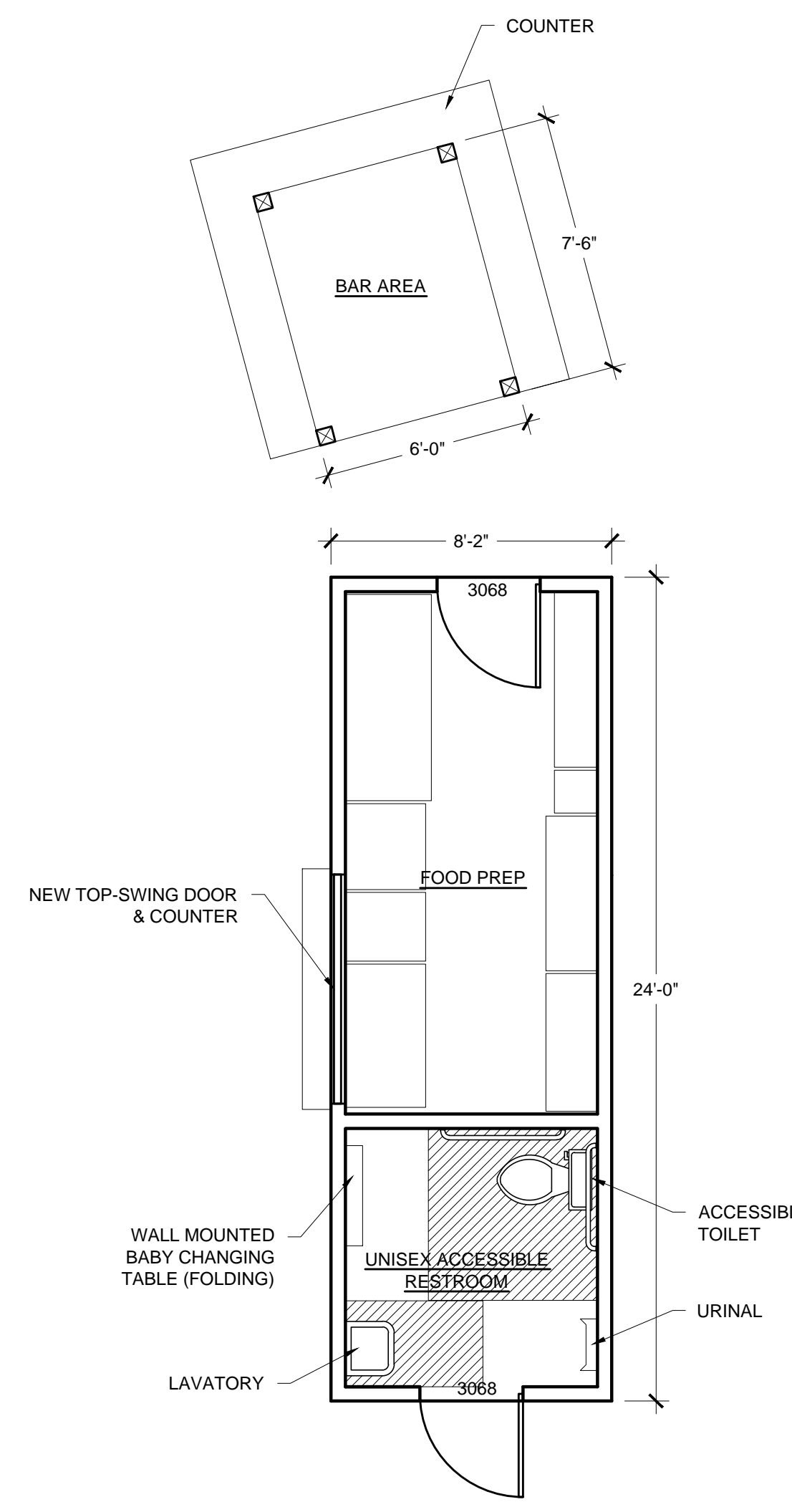

PROPOSED FLOOR PLAN

SCALE: 1/4"=1'-0"

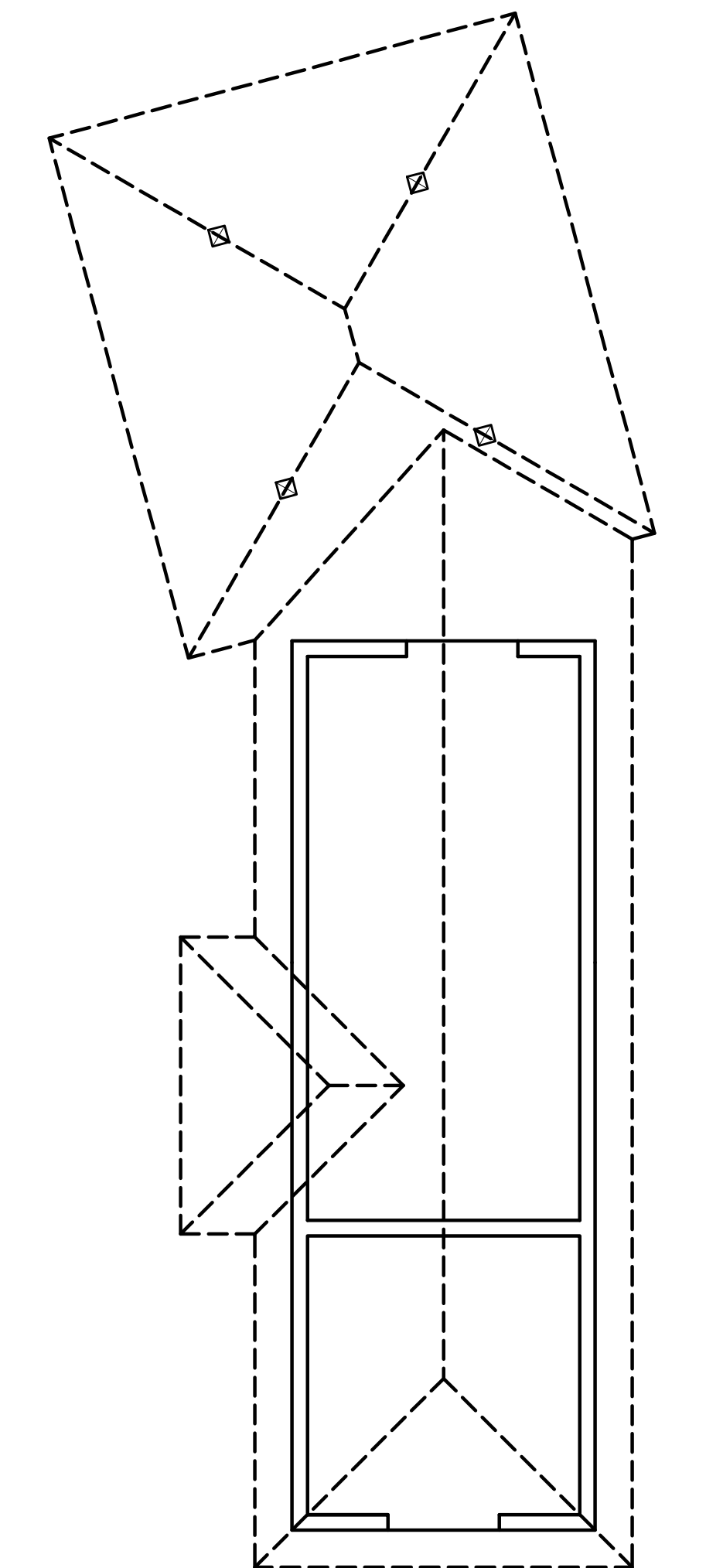

PROPOSED ROOF PLAN

SCALE: 1/4"=1'-0"

## DOOR & WINDOW NOTES

- ALL DOORS AND WINDOWS SHALL BE RATED TO WITHSTAND PRESSURES ASSOCIATED WITH 180 MPH WINDS IN ACCORDANCE WITH ASCE 7-10. DOORS AND WINDOWS SHALL BE MANUFACTURED UNITS DESIGNED AND INSTALLED TO ALLOW A MAXIMUM OF 0.5 CFM INFILTRATION PER LINEAL FOOT OF OPERABLE SASH CRACK AND A MAXIMUM 0.5 CFM PER SF OF EXTERIOR DOOR AREA. UNITS SHALL BE GASKETED, WEATHER-STRIPPED OR OTHERWISE SEALED.
- PROVIDE ONE EGRESS SIZED WINDOW IN EACH BEDROOM UNLESS THERE IS A SECOND EXIT SUCH AS A SLIDING GLASS OR SIDE HINGED DOOR TO THE EXTERIOR. EGRESS WINDOWS SHALL HAVE A SILL HEIGHT OF NOT MORE THAN 44" ABOVE FLOOR LEVEL AND MUST HAVE A MINIMUM NET CLEAR OPENING OF 20" WIDTH AND A NET CLEAR OPENING AREA OF NO LESS THAN 5.7 SF.
- ALL EXTERIOR DOORS SHALL BE SOLID CORE, 1-3/4" THICK, WEATHER-PROOF TYPE. ALL INTERIOR DOORS SHALL BE 1-3/4" THICK. UNITS SHALL BE GLAZED OR RAISED PANEL BOTH SIDES. UNITS SHALL HAVE PATTERNS OR DIVIDED LITES UNLESS OTHERWISE NOTED. UNITS SHALL BE OF THE SIZE AND TYPE INDICATED ON THE DRAWINGS WITH SURFACES PREPARED TO ACCEPT PAINT OR OTHER FINISH AS SPECIFIED. DOORS SHALL MEET NWMA STANDARD TOLERANCES FOR EACH TYPE.
- FURNISH AND INSTALL COMPLETE HARDWARE SETS: SCHLAGE, YALE OR EQUAL, ANSI GRADE 2 OR BETTER FOR HEAVY RESIDENTIAL/MEDIUM COMMERCIAL USE. FINISH AND STYLE TO BE SELECTED BY THE OWNER. ALL EXTERIOR HARDWARE TO BE SALT RESISTANT.
- ALL SLIDING GLASS DOORS AND SHOWER ENCLOSURES SHALL HAVE TEMPERED GLASS.
- WOOD OPERATING AND FIXED WINDOWS SHALL BE EQUIPPED WITH SALT RESISTANT HARDWARE AND REMOVABLE SCREENS. ALL UNITS SHALL BE DOUBLE-GLAZED (UNLESS OTHERWISE NOTED ON THE DRAWINGS) WITH TRUE DIVIDED LITES OR PATTERN INDICATED ON THE DRAWINGS.
- WINDOW UNITS SHALL DISPLAY LABELS INDICATING COMPLIANCE WITH THE STATE OF FLORIDA MODEL ENERGY CODE, SECTION 502.4. FIELD VERIFY ALL DIMENSIONS PRIOR TO FABRICATION.
- PROVIDE CLEAR GLAZING, GASKETED OR OTHERWISE SEALED. PROVIDE SAFETY GLASS AS REQUIRED AND/OR SHOWN ON THE DRAWINGS.
- FASTEN DOOR AND WINDOW FRAMES IN ACCORDANCE WITH MANUFACTURER'S INSTALLATION INSTRUCTIONS AND/OR PRODUCT APPROVAL DETAILS. PROVIDE SEPARATION BARRIER WITH DOOR AND WINDOW FRAMES THAT ARE INSTALLED AGAINST NON-COMPATIBLE PRESSURE-TREATED WOOD FRAMING.

## DEMOLITION NOTES

- PRIOR TO SUBMITTING A BID, VERIFY ALL EXISTING CONDITIONS AND DIMENSIONS ON THE JOB SITE, AND ALSO AFTER AWARD, BUT PRIOR TO THE START OF CONSTRUCTION.
- ALL DEMOLISHED MATERIAL SHALL BECOME THE PROPERTY OF THE CONTRACTOR, UNLESS SPECIFICALLY NOTED OTHERWISE, AND SHALL BE PROPERLY REMOVED FROM THE SITE. COMPLY WITH ALL APPLICABLE LAWS, CODES AND REGULATIONS OF GOVERNMENTAL AGENCIES HAVING JURISDICTION OVER THE PROJECT.
- ALL COST OF DEMOLITION INCLUDING PERMIT FEES, DISPOSAL FEES, ETC. ARE THE RESPONSIBILITY OF THE CONTRACTOR.
- IT IS THE CONTRACTOR'S RESPONSIBILITY TO BE AWARE OF AND TO CONFORM WITH ALL APPLICABLE DEMOLITION AND DISPOSAL CODES, SAFETY REQUIREMENT, AND ENVIRONMENTAL PROTECTION REGULATIONS OF ANY GOVERNMENTAL BODY HAVING JURISDICTION OVER THE WORK.
- PROVIDE SAFETY BARRICADES AS REQUIRED TO PROTECT THE SAFETY OF THE GENERAL PUBLIC AND WORKERS ASSOCIATED WITH THE PROJECT.
- PROVIDE BRACING AND SHORING OF STRUCTURAL MEMBERS DURING CONSTRUCTION. BRACING & SHORING OF STRUCTURAL MEMBERS SHALL BE DESIGNED AND/OR APPROVED BY A PROFESSIONAL ENGINEER.
- DEMOLISHED MATERIAL CLASSIFIED AS CLEAN FILL MAY BE DISTRIBUTED ONSITE WHEN SPECIFICALLY APPROVED BY THE ENGINEER.

REVISIONS:	ORIGINAL:
1	
2	
3	
4	
5	
6	

ACCESSORY STRUCTURE

BANYAN RESORT
323 WHITEHEAD STREET
KEY WEST, FL 33040

JOB NO.	151068
DRAWN	BGO
DESIGNED	PRS
CHECKED	PRS
QC	
SHEET	

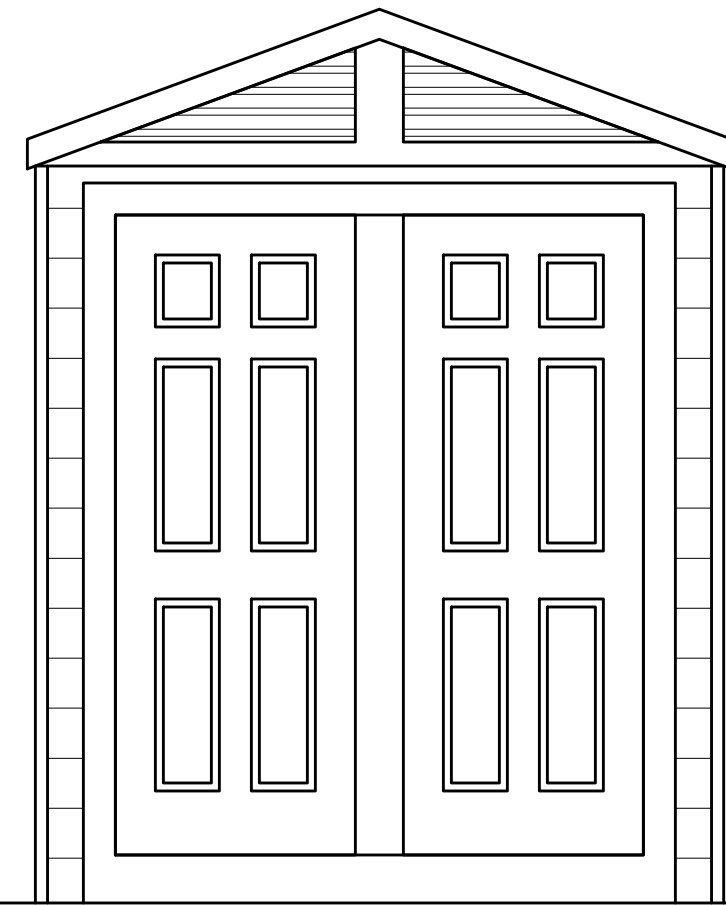

**EXISTING RIGHT SIDE ELEVATION**

SCALE: 1/2"=1'-0"



**EXISTING FRONT ELEVATION**

SCALE: 1/2"=1'-0"

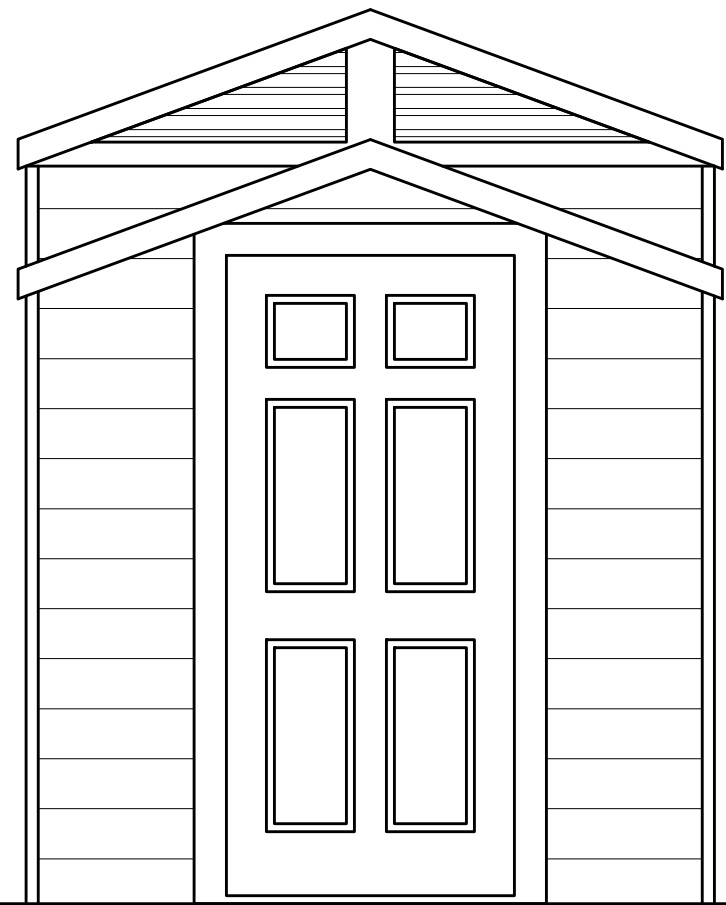

**EXISTING LEFT SIDE ELEVATION**

SCALE: 1/2"=1'-0"

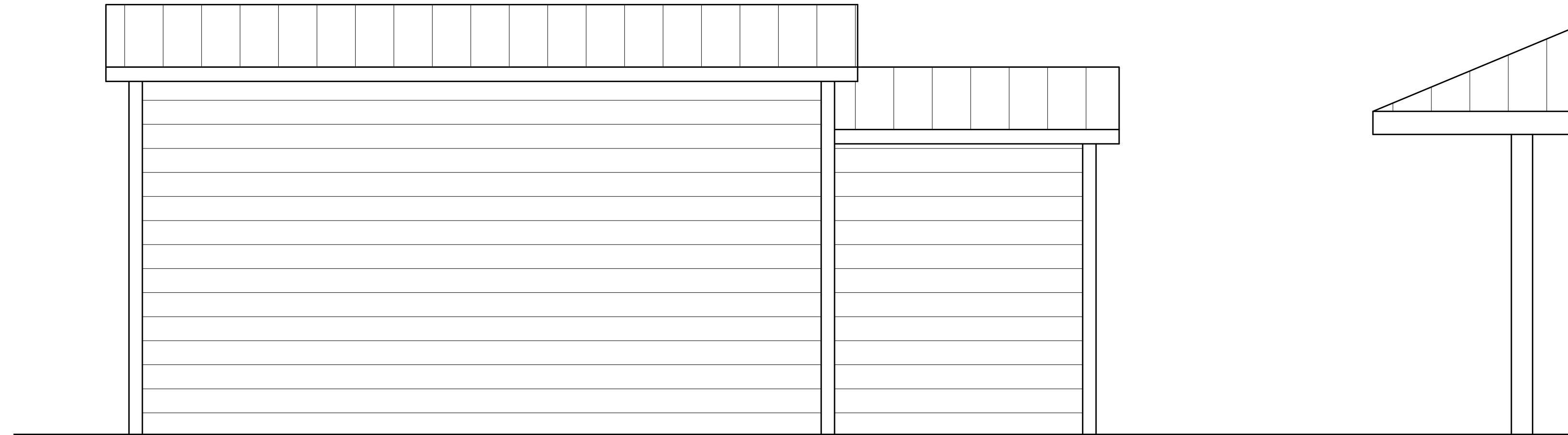

**EXISTING REAR ELEVATION**

SCALE: 1/2"=1'-0"

REVISIONS:	ORIGINAL:
1	
2	
3	
4	
5	
6	

ACCESSORY STRUCTURE

BANYAN RESORT  
 323 WHITEHEAD STREET  
 KEY WEST, FL 33040

JOB NO. 151068  
 DRAWN BGO  
 DESIGNED PRS  
 CHECKED PRS  
 QC  
 SHEET

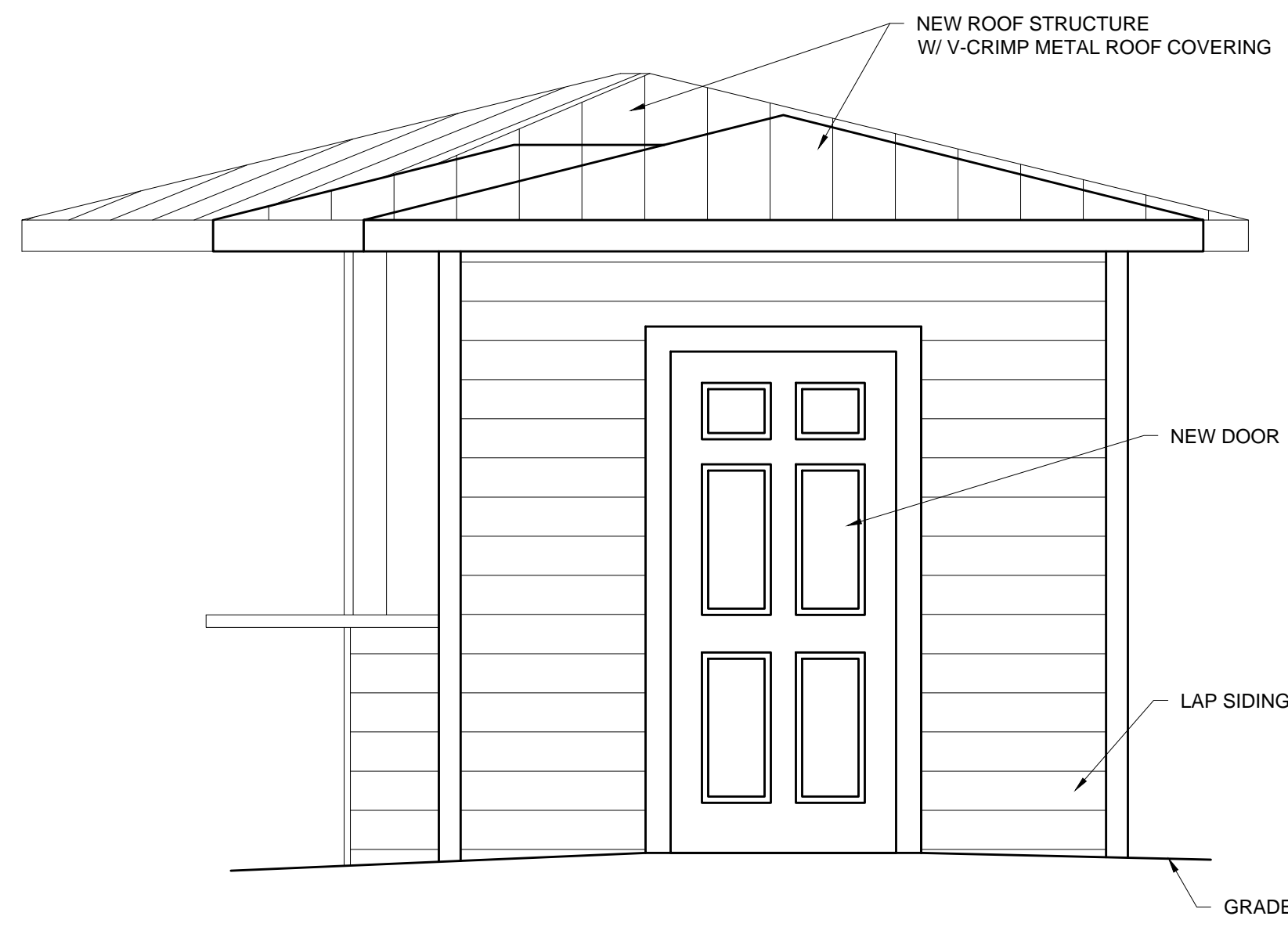

**PROPOSED RIGHT SIDE ELEVATION**

SCALE: 1/2"=1'-0"

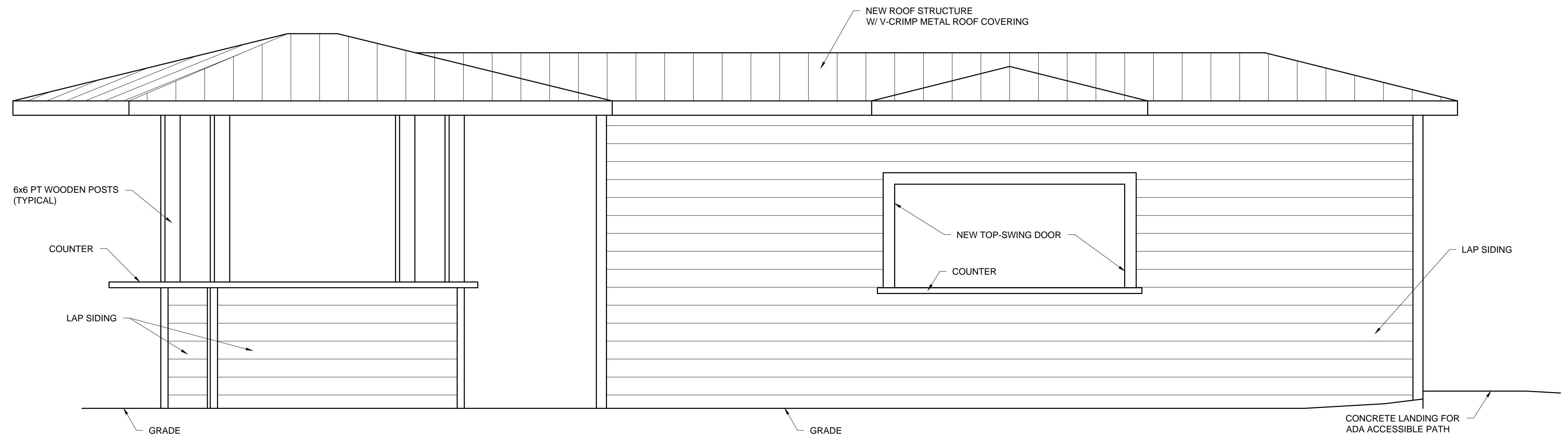

**PROPOSED FRONT ELEVATION**

SCALE: 1/2"=1'-0"

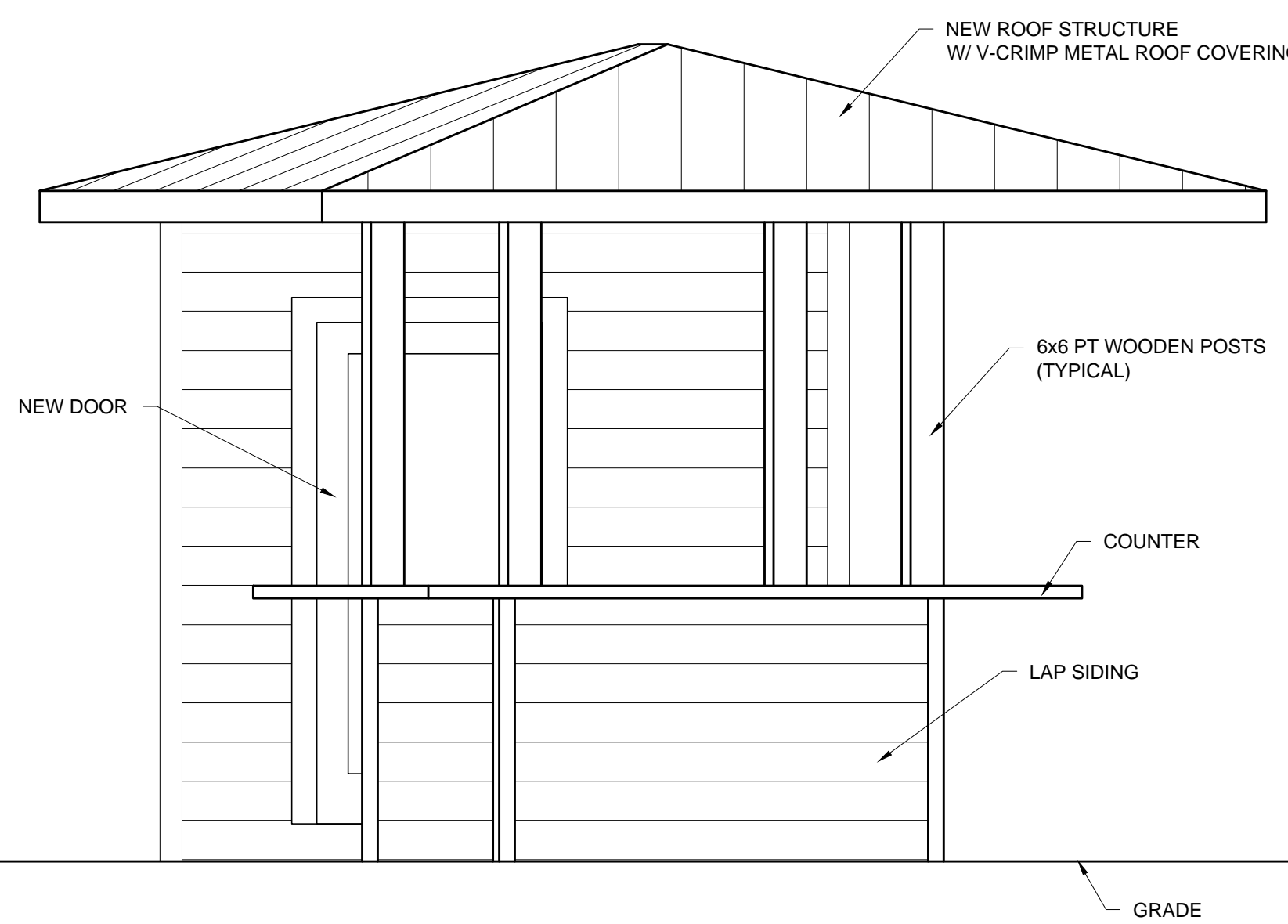

**PROPOSED LEFT SIDE ELEVATION**

SCALE: 1/2"=1'-0"

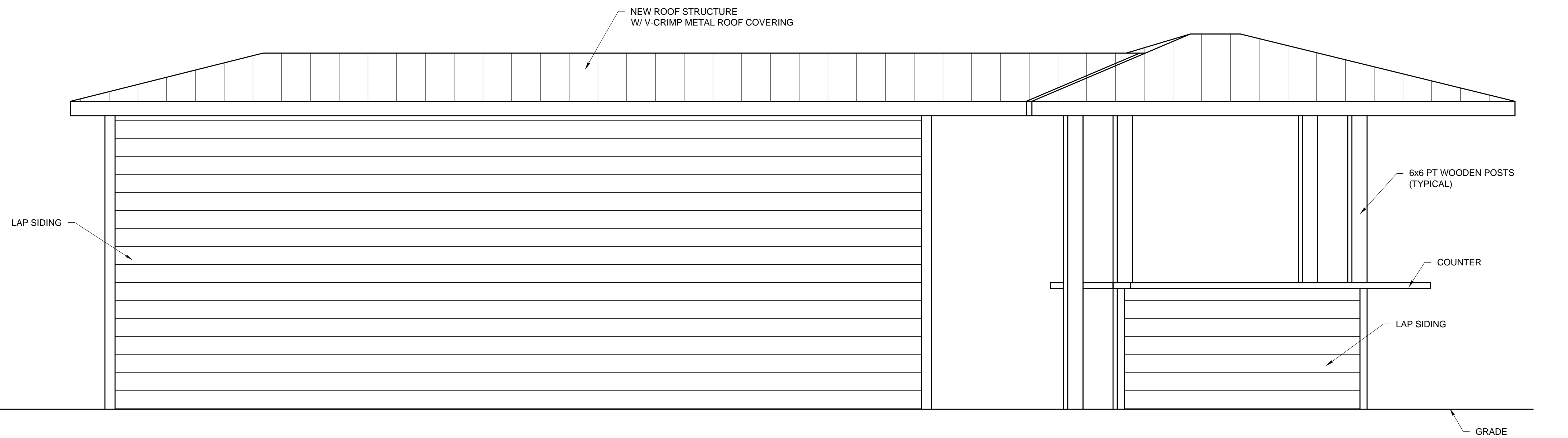

**PROPOSED REAR ELEVATION**

SCALE: 1/2"=1'-0"

REVISIONS:	ORIGINAL:
1	
2	
3	
4	
5	
6	

ACCESSORY STRUCTURE

BANYAN RESORT  
 323 WHITEHEAD STREET  
 KEY WEST, FL 33040

JOB NO.	151068
DRAWN	BGO
DESIGNED	PRS
CHECKED	PRS
QC	
SHEET	

# NOTICING

# Public Meeting Notice

The Historic Architectural Review Commission will hold a public hearing at 5:30 p.m., March 22, 2016 at Old City Hall, 510 Greene Street, Key West, Florida. The purpose of the hearing will be to consider a request for:

**NEW REPLACEMENT ACCESSORY  
STRUCTURE. DEMOLITION OF TWO  
ACCESSORY STRUCTURES.**

**FOR- #323 WHITEHEAD STREET**

**Applicant – Perez Engineering**

**Application #H16-03-0005**

**If you wish to see the application or have any questions, you may visit the Planning Department during regular office hours at 3140 Flagler Avenue, call 305-809-3975 or visit our website at [www.cityofkeywest-fl.gov](http://www.cityofkeywest-fl.gov).**

**THIS NOTICE CAN NOT BE REMOVED FROM THE SITE UNTIL HARC FINAL DETERMINATION**

**ADA ASSISTANCE:** It is the policy of the City of Key West to comply with all requirements of the Americans with Disabilities Act (ADA). Please call the TTY number at 800-955-8771 or 800-955-8770 (Voice) or the ADA Coordinator at 305-809-3731 at least five business days in advance for sign language interpreters, assistive listening devices, or materials in accessible format.

# PROPERTY APPRAISER INFORMATION



**Scott P. Russell, CFA**  
**Property Appraiser**  
**Monroe County, Florida**

Key West (305) 292-3420  
 Marathon (305) 289-2550  
 Plantation Key (305) 852-7130

## Property Record Card -

**Maps are now launching the new map application version.**

**Alternate Key: 8708904 Parcel ID: 00004570-000100**

### Ownership Details

**Mailing Address:**

BANYAN TREE OF KW CONDO AND OWNER ASSOC IN PHASE V  
 323 WHITEHEAD ST  
 KEY WEST, FL 33040-6590

### Property Details

**PC Code:** 05 - TIMESHARES

**Millage Group:** 10KW

**Affordable Housing:** No

**Section-Township-Range:** 06-68-25

**Property Location:** 323 WHITEHEAD ST KEY WEST

**Legal Description:** BANYAN TREE OF KEY WEST PHASE V A TIMESHARE RESORT OR988-1510/1566 OR872-1770/1782 OR1210-781/833AMD OR1210-599/608(CERT) OR1249-1296/97AMD

**Click Map Image to open interactive viewer**





## Land Details

Land Use Code	Frontage	Depth	Land Area
0500 - CO-OP	0	0	1.00 UT

## Misc Improvement Details

Nbr	Type	# Units	Length	Width	Year Built	Roll Year	Grade	Life
1	CON:CONDOMINIUM	1 UT	0	0	1934	1987	1	60

## Appraiser Notes

6/19/01 CHANGING ASSESSMENT AFTER REVIEWING SALES-DP

14-1

REPAIRS COMPLETED IN 2006.

## Building Permits

Bldg Number	Date Issued	Date Completed	Amount	Description	Notes	
09-0992	04/14/2009		3,200	Commercial	REMOVE & REPLACE 100 SF OF CEMENT,100SF WOOD SIDING,200LF OF WOOD TRIM	
10-0172	01/29/2010	12/31/2010	11,000		REPLACE AND INSTALL NEW FILTRATION SYSTEM FOR SPA; RESURFACE SPA AND INSTALL NEW 6 X 6 TILE AND 2 X 6 NON SKID STEP TILE. LEROY ENTERPRISES INC. 305-481-3188.	
10-1394	05/18/2010		72,000		INSTALL A METAL BLAZENMASTER CPVC FIRE SPRINKLER SYSTEM W / APPROX. 58 HEADS.	
10-1395	05/14/2010	05/18/2010	3,585		PROVIDE & INSTALL ONE 4" R.P.D. BACKFLOW PREVENTOR FOR FIRE LINE SYSTEM.	
1	12-1081	06/25/2012	10/30/2012	169,800	Commercial	REVISION OF NEW DECK SPREAD FOOTERS & STEEL REINFORCED CONCRETE PER DRAWINGS



1	13-0540	03/06/2013	03/20/2013	3,038	Commercial	INSTALL APPROX 38SQ FT ADDITIONAL CONCRETE SIDEWALK. INSTALL CUSTOMER PROVIDED DOWN SELF CONTAINED ADA POOL
	14-4211	09/10/2014		6,700		INSTALL MINI SPLIT SYSTEM UP TO 2 TON.
	15-1085	03/25/2015		2,000	Commercial	INSTALL 15 NEW SHOWER VALVES.
	15-1040	03/24/2015		54,500	Commercial	DEMO & REPLACE 14 UNITS - KITCHEN CABINETS, COUNTERTOPS & VANITIES. TILE SHOWERS. REVISION: R/R 1700SF OF WATER DAMAGED DRYWALL & TRIM. TAPE, TRIM, PAINT. INTERIOR ONLY.

## Parcel Value History

Certified Roll Values.

[View Taxes for this Parcel.](#)

Roll Year	Total Bldg Value	Total Misc Improvement Value	Total Land Value	Total Just (Market) Value	Total Assessed Value	School Exempt Value	School Taxable Value
2015	0	1,628,187	1	1,628,188	1,628,188	0	1,628,188
2014	0	1,628,187	1	1,628,188	1,628,188	0	1,628,188
2013	0	1,795,766	1	1,795,767	1,795,767	0	1,795,767
2012	0	1,807,894	1	1,807,895	1,807,895	0	1,807,895
2011	0	1,881,845	1	1,881,846	1,881,846	0	1,881,846
2010	0	1,908,253	1	1,908,254	1,908,254	0	1,908,254
2009	0	2,168,797	1	2,168,798	2,168,798	0	2,168,798
2008	0	2,143,390	1	2,143,391	2,143,391	0	2,143,391
2007	0	2,288,112	1	2,288,113	2,288,113	0	2,288,113
2006	491,115	17,492	297,648	1,489,637	1,489,637	0	1,489,637
2005	509,083	18,052	297,648	1,490,230	1,490,230	0	1,490,230
2004	509,069	18,621	297,648	1,484,420	1,484,420	0	1,484,420
2003	509,069	19,271	297,648	1,506,820	1,506,820	0	1,506,820
2002	509,069	19,955	297,648	1,506,820	1,506,820	0	1,506,820
2001	461,157	20,605	297,648	1,506,820	1,506,820	0	1,506,820
2000	461,157	8,310	297,648	1,500,170	1,500,170	0	1,500,170
1999	461,157	8,572	297,648	1,500,170	1,500,170	0	1,500,170
1998	307,438	8,830	297,648	1,500,170	1,500,170	0	1,500,170
1997	307,438	9,081	297,648	1,484,210	1,484,210	0	1,484,210
1996	279,489	9,351	297,648	1,517,950	1,517,950	0	1,517,950
1995	279,489	9,601	297,648	1,646,961	1,646,961	0	1,646,961
1994	279,489	9,859	297,648	1,646,961	1,646,961	0	1,646,961
1993	279,489	10,122	297,648	1,644,161	1,644,161	0	1,644,161
1992	2,478,080	0	1	2,478,081	2,478,081	0	2,478,081
1991	2,657,320	0	1	2,657,321	2,657,321	0	2,657,321
1990	1,614,949	0	1	1,614,950	1,614,950	0	1,614,950
1989	1,614,949	0	1	1,614,950	1,614,950	0	1,614,950
1988	1,678,249	0	1	1,678,250	1,678,250	0	1,678,250
1987	1,678,249	0	1	1,678,250	1,678,250	0	1,678,250

## Parcel Sales History

NOTE: Sales do not generally show up in our computer system until about two to three months after the date of sale. If a recent sale does not show up in this list, please allow more time for the sale record to be processed. Thank you for your patience and understanding.

There are no sales to display for this parcel.

This page has been visited 143,370 times.

Monroe County Property Appraiser  
Scott P. Russell, CFA  
P.O. Box 1176 Key West, FL 33041-1176