



## Historic Architectural Review Commission Staff Report for Item 8

To: Chairman Haven Burkee and Historic Architectural Review  
Commission Members

From: Enid Torregrosa-Silva, MSHP  
Historic Preservation Planner

Meeting Date: October 26, 2022

Applicant: J. Doug Brown, Owner

Application Number: H2022-0041

Address: 408 Virginia Street

### **Description of Work:**

New two-story porch at rear. Changes of doors and windows on main house. New accessory structure, pool, and site improvements.

### **Site Facts:**

The principal building in the site is listed as a contributing resource to the district. Although the Historic Architectural Survey states that the house was built circa 1892 an analysis of the Sanborn Maps prove that the current structure was built between 1926 and 1948. The Property Appraiser's records show 1938 as the construction year for the two-story frame vernacular house.

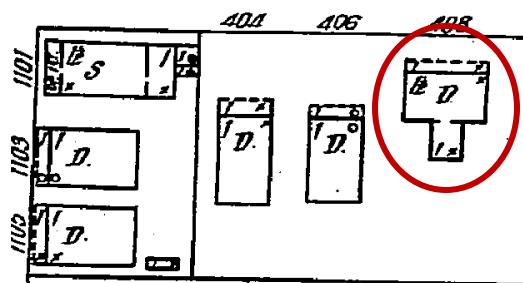

1926 Sanborn Map

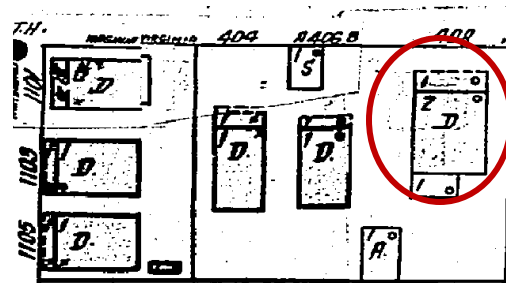

1948 Sanborn Map

The site contains the main house and an accessory structure located on the southwest corner of the lot. Changes to windows, exterior staircase, and front porch are evident alterations to the principal house. The city recognizes two residential units for this site.

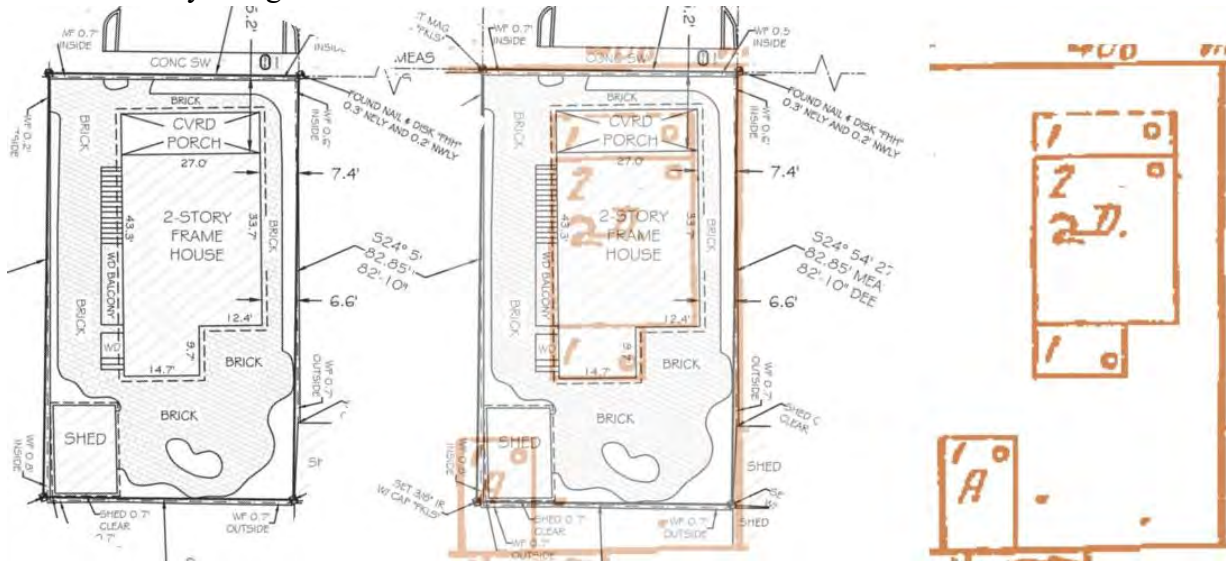

*Current Survey vs. 1962 Sanborn Map*

**Guidelines Cited on Review:**

- Additions (page 37a-k), specifically guidelines 1, 6, 11, 12, 13, 14, 19, and 30.
- New Construction (pages 38a-q), specifically guidelines 1, 2, 6, 11, 20, and 23
- Decks, patios, hot tubs, spas, pools and related equipment (page 39a), specifically first paragraph and guidelines 1 and 3.
- Outbuildings (page 40), specifically guidelines 1, 3, and 9.

**Staff Analysis:**

The Certificate of Appropriateness under review proposes the construction of a two-story rear porch and a small accessory structure. The two-story porch will be lower in height than the main house and will be approximately 24’-3” setback from the rear property line. The existing one-story rear bump-out does not have enough headroom in the interior of the space and will be removed. The plans also include the replacement of the exterior staircase and replacement of rear doors with impact sliders for access to the new porch.

The proposed accessory structure that will replace the existing one will be a one-story frame structure of 64 square feet. The new building will house a half bathroom to be used as accessory for a future pool. The structure will have a low-pitched shed roof, will have hardie board siding and impact metal door. The east wall of the accessory structure will be done with concrete blocks. A pool is proposed at the rear of the site.

**Consistency with Cited Guidelines:**

It is staff’s opinion that the proposed design meets the cited guidelines. The proposed two-story porch will not jeopardize privacy of neighboring properties; the adjacent house on the east side also has a second-floor porch on the rear elevation. The proposed one-story accessory structure

will be located on required setbacks and it will have a small scale in relation to the existing and surrounding accessory structures. The reconstruction of the exterior staircase, pool and brick pavers will meet current regulations.

# APPLICATION

# HARC MAJOR PROJECTS CERTIFICATE OF APPROPRIATENESS

\$400 NON-REFUNDABLE BASE APPLICATION FEE - OTHER FEES MAY BE APPLICABLE



City of Key West

1300 WHITE STREET  
KEY WEST, FLORIDA 33040

HARC COA # <b>HARC 2022-0041</b>	REVISION #	INITIAL & DATE
FLOOD ZONE	ZONING DISTRICT	BLDG PERMIT #

**A PRE-APPLICATION MEETING WITH HARC STAFF IS REQUIRED PRIOR TO SUBMITTAL**

ADDRESS OF PROPOSED PROJECT:

NAME ON DEED:

OWNER'S MAILING ADDRESS:

APPLICANT NAME:

APPLICANT'S ADDRESS:

APPLICANT'S SIGNATURE:

408 VIRGINIA STREET	
J. Douglas Brown - DISCLOF TRUST 6-27-16	PHONE NUMBER 305-295-8308
3636 EAGLE AVE	EMAIL JDB1307@AOL.COM
KEY WEST, FL 33040	
J. DOUG BROWN	PHONE NUMBER 305-295-8308
3636 EAGLE AVE.	EMAIL JDB1307@AOL.COM
Key West, FL 33040	
<i>Jane Douglas Brown</i>	DATE 9-22-22

**ANY PERSON THAT MAKES CHANGES TO AN APPROVED CERTIFICATE OF APPROPRIATENESS MUST SUBMIT A NEW APPLICATION.**

FLORIDA STATUTE 837.06: WHOEVER KNOWINGLY MAKES A FALSE STATEMENT IN WRITING AND WITH THE INTENT TO MISLEAD A PUBLIC SERVANT IN THE PERFORMANCE OF HIS OR HER OFFICIAL DUTY SHALL BE GUILTY OF A MISDEMEANOR OF THE SECOND DEGREE PUNISHABLE PER SECTION 775.082 OR 775.083. THE APPLICANT FURTHER HEREBY ACKNOWLEDGES THAT THE SCOPE OF WORK AS DESCRIBED IN THE APPLICATION SHALL BE THE SCOPE OF WORK THAT IS CONTEMPLATED BY THE APPLICANT AND THE CITY. THE APPLICANT FURTHER STIPULATES THAT SHOULD FURTHER ACTION BE TAKEN BY THE CITY FOR EXCEEDING THE SCOPE OF THE DESCRIPTION OF WORK, AS DESCRIBED HEREIN, AND IF THERE IS CONFLICTING INFORMATION BETWEEN THE DESCRIPTION OF WORK AND THE SUBMITTED PLANS, THE AFOREMENTIONED DESCRIPTION OF WORK SHALL BE CONTROLLING.

PROJECT INCLUDES: REPLACEMENT OF WINDOWS  RELOCATION OF A STRUCTURE  ELEVATION OF A STRUCTURE

PROJECT INVOLVES A CONTRIBUTING STRUCTURE: YES  **NO**  INVOLVES A HISTORIC STRUCTURE: YES  NO

PROJECT INVOLVES A STRUCTURE THAT IS INDIVIDUALLY LISTED ON THE NATIONAL REGISTER: YES  **NO**

**DETAILED PROJECT DESCRIPTION INCLUDING MATERIALS, HEIGHT, DIMENSIONS, SQUARE FOOTAGE, LOCATION, ETC.**

GENERAL: *INSTALL 8'x27' REAR UPPER & LOWER OPEN PORCH ON REAR OF EXISTING BUILDING.*

*INSTALL 10'x20' IN GROUND SWIMMING POOL TO CURRENT CODES*

MAIN BUILDING:

DEMOLITION (PLEASE FILL OUT AND ATTACH DEMOLITION APPENDIX): *DEMO APPROX 10'11" X 16'8 1/2" KITCHEN PROTRUSION*

*DEMO 12'1" X 17'1" SITED IN REAR SETBACK AREA OF LOT*

APPLICATIONS MUST BE SUBMITTED IN PERSON WITH HARD COPIES BY 3PM ON THE SCHEDULED DEADLINE  
 PLEASE SEND AN ELECTRONIC COPY OF ALL DOCUMENTS TO HARC@CITYOFKEYWEST-FL.GOV

ACCESSORY STRUCTURE(S): <i>ERECT 4'X7' OUTDOOR POOL 1/2 BATH.</i>	
<i>2X6 FRAME, HARDIE PANEL SIDING, TPO SINGLE SLOPE ROOF</i>	
PAVERS: <i>CORAL STONE PAVING AROUND POOL &amp; SIDEWALK</i>	FENCES: <i>EXISTING</i>
DECKS: <i>N/A</i>	PAINTING: <i>REPAINT HOUSE EXTERIOR PER HARC GUIDELINES,</i>
SITE (INCLUDING GRADING, FILL, TREES, ETC.):	POOLS (INCLUDING EQUIPMENT):
<i>RELOCATE TWO SMALL CHRISTMAS PALMS FROM REAR YARD CENTER TO SIDEYARD WEST</i>	<i>NEW 10'X20' IN GROUND CONCRETE POOL PUMP, FILTER, HEATER</i>
ACCESSORY EQUIPMENT (GAS, A/C, VENTS, ETC.):	OTHER:
<i>NEW CENTRAL AC UNITS TO REPLACE EXISTING CENTRAL AC UNITS</i>	

OFFICIAL USE ONLY:	HARC COMMISSION REVIEW	EXPIRES ON:
MEETING DATE:	___ APPROVED ___ NOT APPROVED ___ DEFERRED FOR FUTURE CONSIDERATION	INITIAL:
MEETING DATE:	___ APPROVED ___ NOT APPROVED ___ DEFERRED FOR FUTURE CONSIDERATION	INITIAL:
MEETING DATE:	___ APPROVED ___ NOT APPROVED ___ DEFERRED FOR FUTURE CONSIDERATION	INITIAL:
REASONS OR CONDITIONS:		
STAFF REVIEW COMMENTS:		
FIRST READING FOR DEMO:	SECOND READING FOR DEMO:	
HARC STAFF SIGNATURE AND DATE:	HARC CHAIRPERSON SIGNATURE AND DATE:	

**THIS APPLICATION MAY BE REVIEWED BY PLANNING DEPARTMENT STAFF.**

# HARC CERTIFICATE OF APPROPRIATENESS: DEMOLITION APPENDIX



**City of Key West**

1300 White Street  
Key West, Florida 33040

HARC COA # <b>HARC2022-0641</b>	INITIAL & DATE
ZONING DISTRICT	BLDG PERMIT #

ADDRESS OF PROPOSED PROJECT:

**408 VIRGINIA ST. - KEY WEST, FL 33040**

PROPERTY OWNER'S NAME:

**J. DOUGLAS BROWN. DECLARATION OF TRUST DATED 6-27-2016**

APPLICANT NAME:

**J. DOUGLAS BROWN**

I hereby certify I am the owner of record and that the work shall conform to all applicable laws of this jurisdiction. By receiving a Certificate of Appropriateness, I realize that this project will require a Building Permit approval **PRIOR to proceeding with the work outlined above** and that a final inspection is required under this application. I also understand that **any changes to an approved Certificate of Appropriateness must be submitted for review.**

PROPERTY OWNER'S SIGNATURE *J. Douglas Brown* **J. DOUGLAS BROWN** **9-22-22**  
DATE AND PRINT NAME

**DETAILED PROJECT DESCRIPTION OF DEMOLITION**

**DEMOLISH 12'1" X 17'1" SHED AT REAR OF PROPERTY IN SET BACK AREA**  
FRAME CONSTRUCTION, METAL ROOF, NOVELTY SIDING

**DEMOLISH 10'11" X 16'8 1/2" KITCHEN PROJECTION**  
FRAME CONSTRUCTION, METAL ROOF, NOVELTY SIDING

**CRITERIA FOR DEMOLITION OF CONTRIBUTING OR HISTORIC STRUCTURES:**

**Before any Certificate of Appropriateness may be issued for a demolition request, the Historic Architectural Review Commission must find that the following requirements are met (please review and comment on each criterion that applies):**

(1) If the subject of the application is a contributing or historic building or structure, then it should not be demolished unless its condition is irrevocably compromised by extreme deterioration or it does not meet any of the following criteria:

(a) The existing condition of the building or structure is irrevocably compromised by extreme deterioration.

**NO**

(2) Or explain how the building or structure meets the criteria below:

(a) Embodies no distinctive characteristics of a type, period, or method of construction of aesthetic or historic significance in the city and is not a significant and distinguishable building entity whose components may lack individual distinction.

**PER CONVERSATION WITH ENID TORREGROSA, HISTORIC PRESERVATION PLANNER, IN PRE-APP CONFERENCE, THERE APPEARS TO BE NO SIGNIFICANT OR DISTINGUISHABLE CHARACTERISTICS THAT WARRANT ANY CONCERN OF DEMOLITION.**

Nothing in this application is intended to alter the authority of the Building Official to condemn for demolition dangerous buildings, as provided in Section 102-218 of the Land Development Regulations and Chapter 14 of the Code of Ordinances.

(b) Is not specifically associated with events that have made a significant contribution to local, state, or national history.

PER CONVERSATION AND RESEARCH AT KEY WEST LIBRARY ON 9-21-22 WITH DR. COREY MALCOM, LEAD HISTORIAN, THERE IS NO SIGNIFICANT HISTORY ASSOCIATED WITH THIS PROPERTY AT 408 VIRGINIA, KW, FL

(c) Has no significant character, interest, or value as part of the development, heritage, or cultural characteristics of the city, state or nation, and is not associated with the life of a person significant in the past.

NO SIGNIFICANT CHARACTER, INTEREST, OR VALUE ASSOCIATED WITH THIS ADDRESS PER DR. COREY MALCOM

(d) Is not the site of a historic event with significant effect upon society.

NO HISTORIC EVENT PER DR. COREY MALCOM

(e) Does not exemplify the cultural, political, economic, social, or historic heritage of the city.

NO SIGNIFICANCE PER DR. COREY MALCOM

(f) Does not portray the environment in an era of history characterized by a distinctive architectural style.

NO OBVIOUS ARCHITECTURAL STYLE EXHIBITED IN THIS BUILDING OR STRUCTURE

(g) If a part of or related to a square, park, or other distinctive area, nevertheless should not be developed or preserved according to a plan based on the area's historic, cultural, natural, or architectural motif.

N/A

(h) Does not have a unique location or singular physical characteristic which represents an established and familiar visual feature of its neighborhood or of the city, and does not exemplify the best remaining architectural type in a neighborhood.

NO UNIQUE LOCATION



Nothing in this application is intended to alter the authority of the Building Official to condemn for demolition dangerous buildings, as provided in Section 102-218 of the Land Development Regulations and Chapter 14 of the Code of Ordinances.

(i) Has not yielded, and is not likely to yield, information important in history,

NO EVIDENCE OF ANY INFORMATION IMPORTANT TO HISTORY HAS BEEN FOUND REGARDING THIS PROPERTY.

\* CRITERIA FOR DEMOLITION OF NON-CONTRIBUTING OR NON-HISTORIC STRUCTURES:

The following criteria will also be reviewed by the Historic Architectural Review Commission for proposed demolitions. The Commission shall not issue a Certificate of Appropriateness that would result in the following conditions (please review and comment on each criterion that applies):

(1) Removing buildings or structure that are important in defining the overall historic character of a district or neighborhood so that the character is diminished.

REMOVAL OF THIS BUILDING & PROTRUSION WILL HAVE NO NEGATIVE EFFECT ON THE OVERALL HISTORIC CHARACTER OF THIS NEIGHBORHOOD.

(2) Removing historic buildings or structures and thus destroying the historic relationship between buildings or structures and open space.

NO HISTORIC RELATIONSHIP HAS BEEN DISCOVERED BETWEEN BUILDING & PROTRUSION PROPOSED FOR DEMOLITION.

(3) Removing an historic building or structure in a complex; or removing a building façade; or removing a significant later addition that is important in defining the historic character of a site or the surrounding district or neighborhood.

N/A

(4) Removing buildings or structures that would otherwise qualify as contributing.

NON-CONTRIBUTING STRUCTURE

# SANBORN MAPS

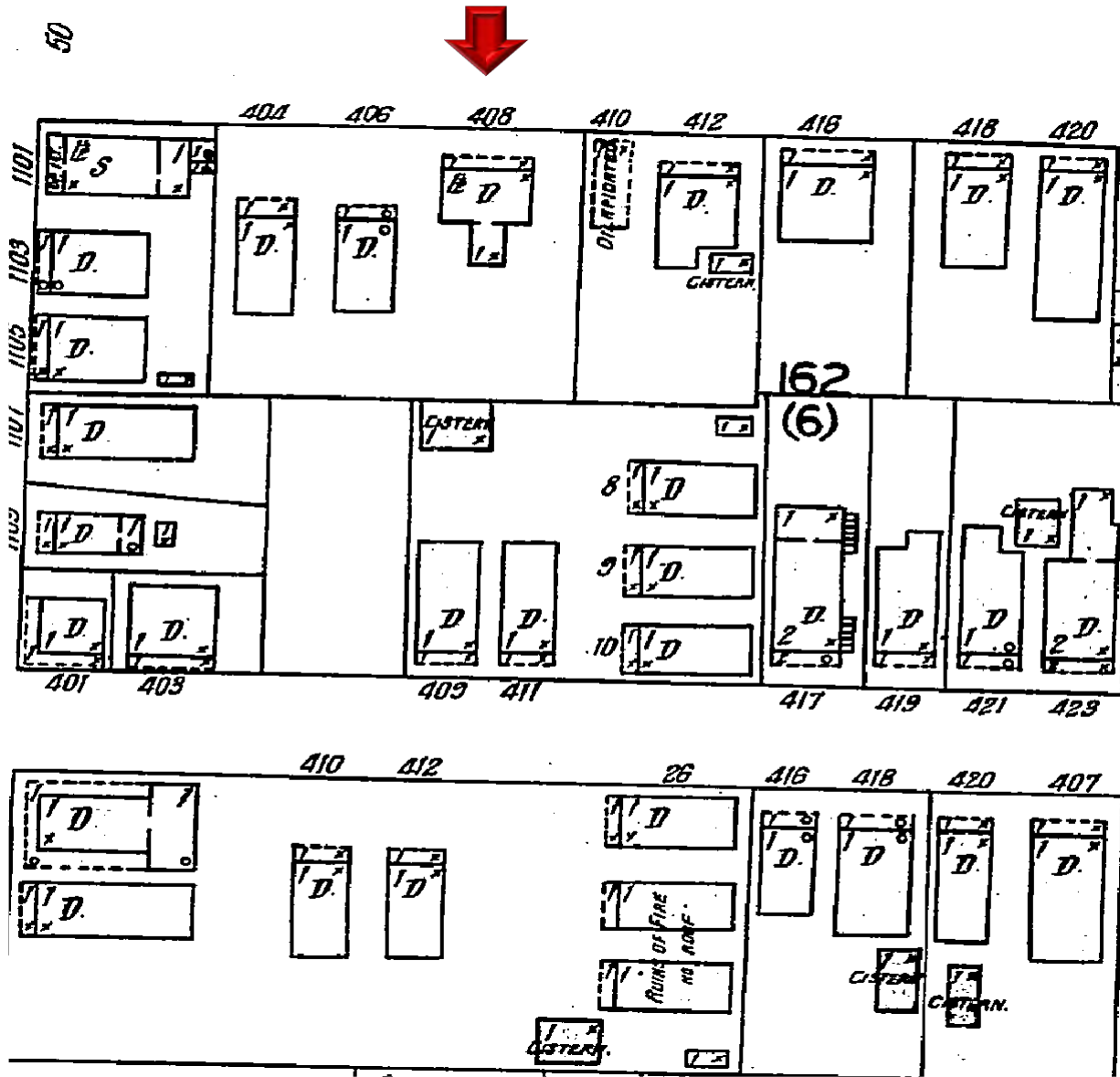

Sanborn Map 1926

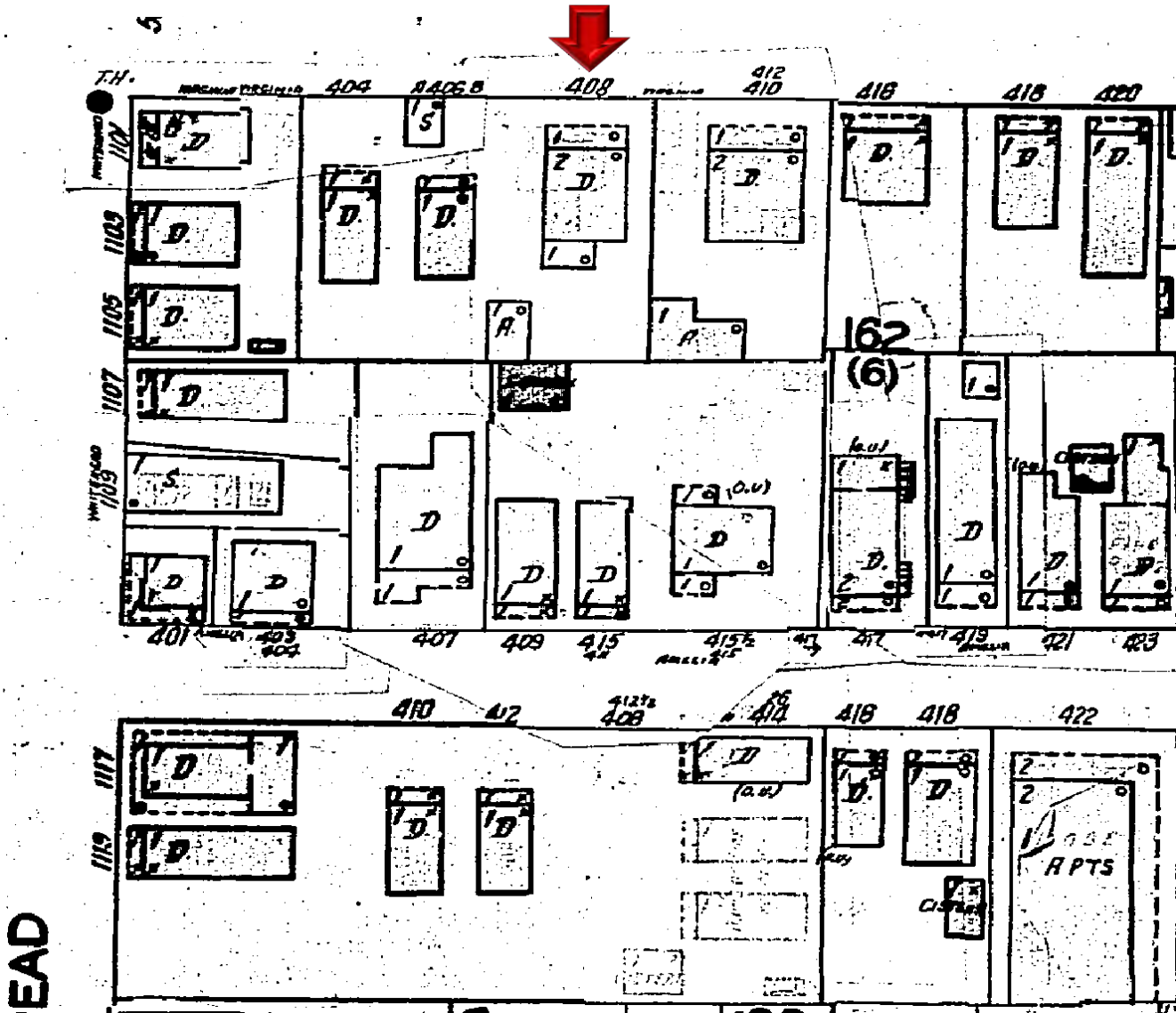

Sanborn Map 1948



# PROJECT PHOTOS



**408 Virginia Street circa 1965. Monroe County Library.**



**408 Virginia Street rear accessory structure in 1970. Monroe County Library.**





408 Virginia – Key West, FL

Two story, upper and lower Duplex structure



West side yard view looking down driveway to rear shed



Rear view showing kitchen protrusion to be removed



Shed built in set-back area to be removed



408 Virginia - Proposed plan to remove approximately 10' 11" x 16' 8 1/2" kitchen projection and replace with approximately an 8' x 27' open porch area on upper and lower levels.

Proposed porch rear edge is 10' INSIDE set-back and 25' from the rear property line

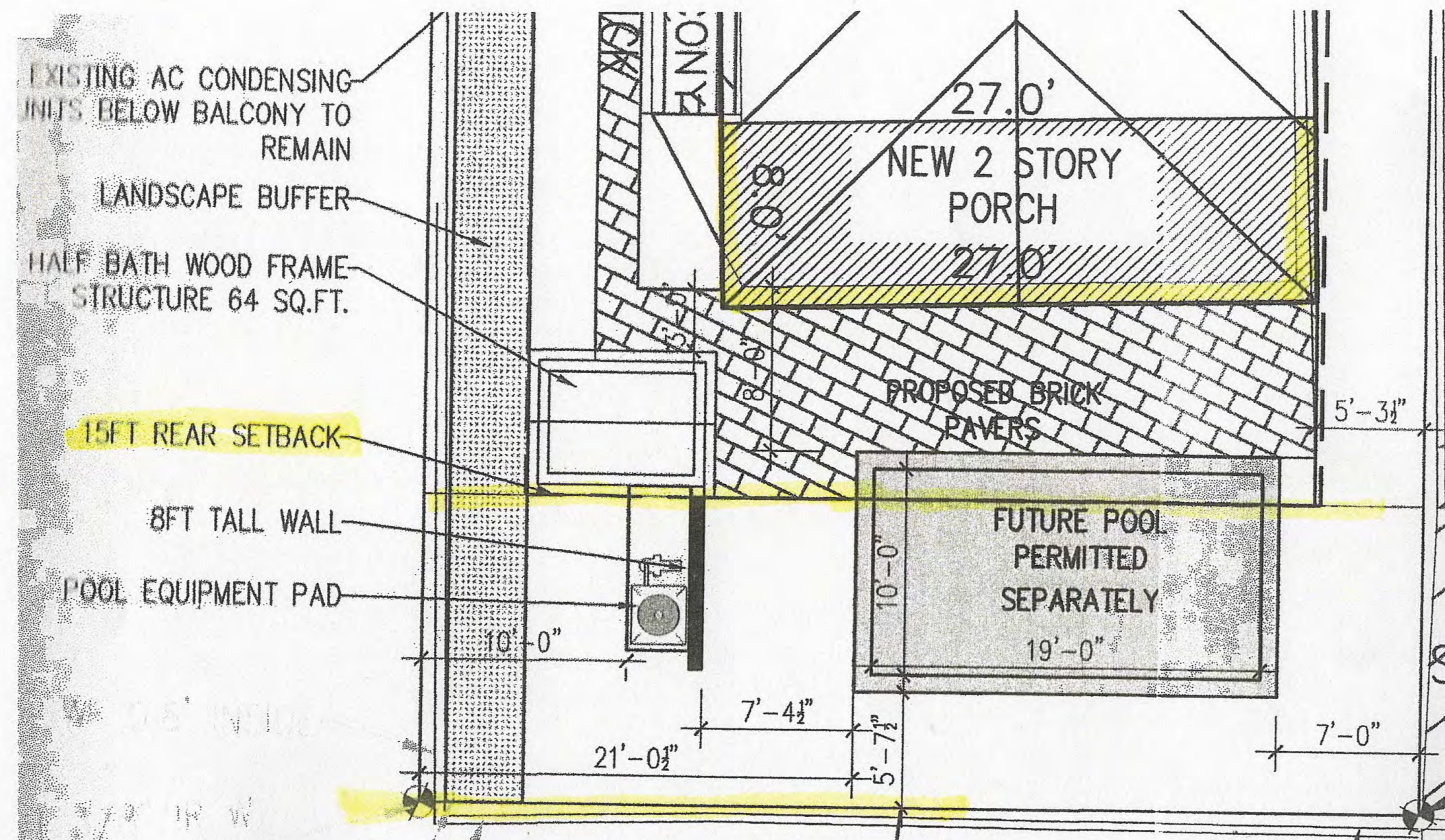



Rear yard view looking from existing rear windows

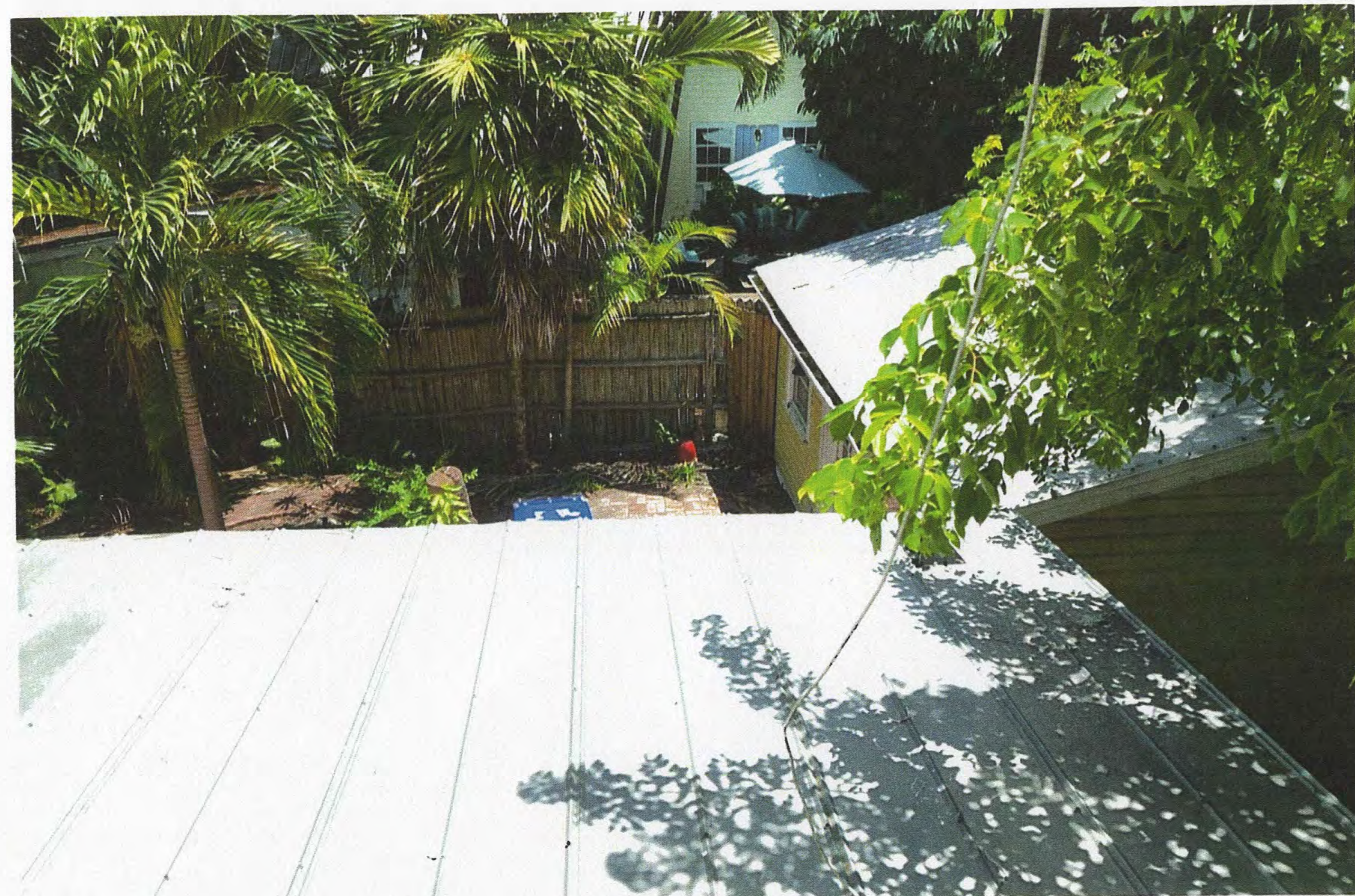

All large significant trees to remain

- 50' Washingtonia Palm
- 35' Bismark Palm
- 25' Travelers Palm Group

(Heights are approximate)





East side neighbor showing upper rear open deck

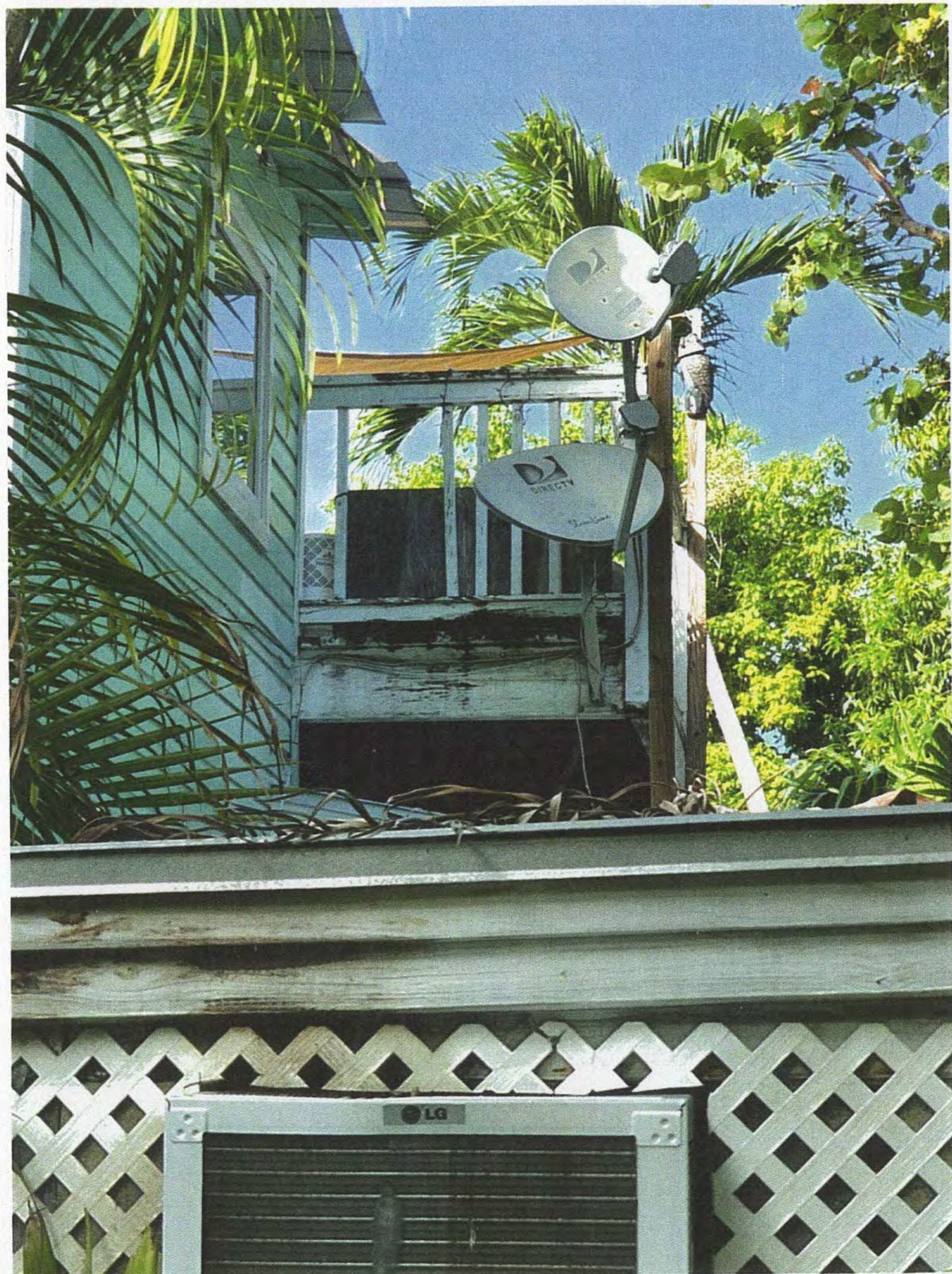

West side Commercial neighbor



# SURVEY

BEARING BASE:  
ALL BEARINGS ARE BASED  
ON N65°00'00"E ASSUMED  
ALONG THE CENTERLINE OF  
VIRGINIA STREET.

ALL ANGLES DEPICTED  
ARE 90 DEGREES UNLESS  
OTHERWISE INDICATED

ALL UNITS ARE SHOWN IN  
U.S. SURVEY FEET

ADDRESS:  
408 VIRGINIA STREET  
KEY WEST, FL 33040

COMMUNITY NO.: 120168  
MAP NO.: 12087C-1516K  
MAP DATE: 02-18-05  
FIRM REVISION DATE: 11-02-16  
FLOOD ZONE: AE # X-SHADED  
ELEVATION: AE-6 # N/A

# MAP OF BOUNDARY SURVEY

## LEGEND

- WATER METER
- SANITARY SEWER CLEAN OUT
- MAILBOX
- WOOD POWER POLE
- CONCRETE POWER POLE

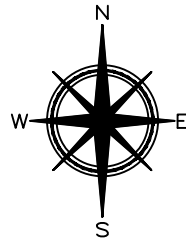

ASSUMED



LOCATION MAP - NTS  
SEC. 06-T685-R25E

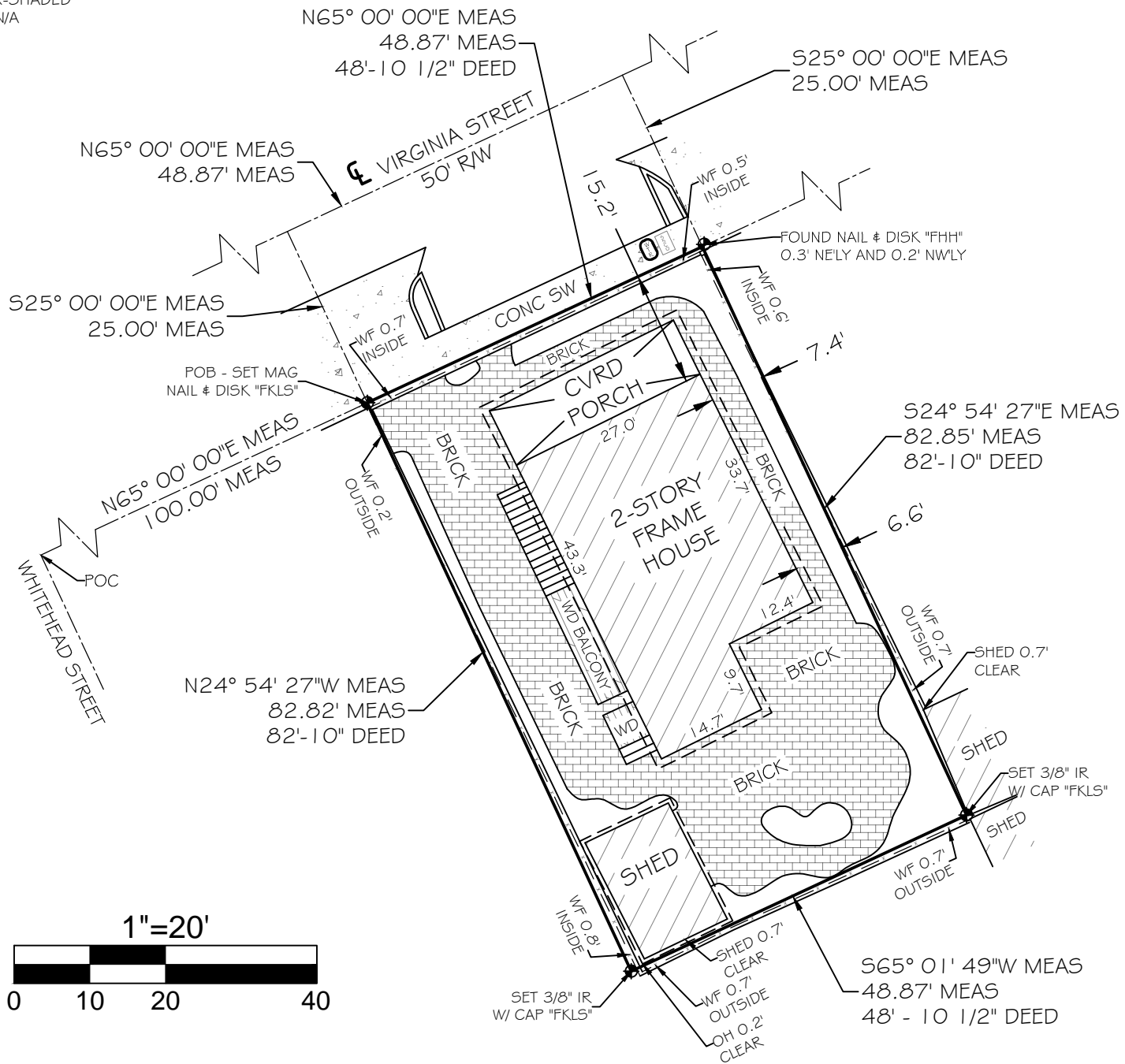

## LEGAL DESCRIPTION -

In subdivision of Lot 3, of Square 6, of a Subdivision of Tract 11 of the Island of Key West according to the map or plat thereof as recorded in Deed Book J, Page 671, Public Records of Monroe County, Florida, and described as follows:  
Commencing at a point on Virginia Street, 100 feet from the corner of Whitehead Street and running thence Northeasterly along Virginia Street 48 feet and 10.5 inches; thence at right angles in a Southeasterly direction 82 feet and 10 inches; thence at right angles in a Southwesterly direction 48 feet and 10.5 inches thence at right angles in a Southwesterly direction 48 feet and 10.5 inches; thence at right angles in a Northwesterly direction 82 feet and 10 inches to the Point of Beginning, being the western half of land conveyed by W.D. Cash and wife to Satpoe Austin by deed recorded in Deed Book L, Page 503 and conveyed to grantor by deed recorded in Official Records Book 152, Page 410, of the Public Records of Monroe County, Florida.

TOTAL AREA = 4,048.19 SQFT ±

## CERTIFIED TO -

J. Douglas Brown;

NOTE: FOUNDATIONS BENEATH THE SURFACE ARE NOT SHOWN. MEASURED DIMENSIONS EQUAL PLATTED OR DESCRIBED DIMENSIONS UNLESS INDICATED OTHERWISE.  
THE FOLLOWING IS A LIST OF ABBREVIATIONS THAT MAY BE FOUND ON THIS SHEET.

- |                                   |  |                                      |
|-----------------------------------|--|--------------------------------------|
| BFP = BACK-FLOW PREVENTER         | GUY = GUY WIRE                                 | POC = POINT OF COMMENCEMENT          |
| BO = BLOW OUT                     | HB = HOSE BIB                                  | PRC = POINT OF REVERSE CURVE         |
| C & G = 2' CONCRETE CURB & GUTTER | IP = IRON PIPE                                 | PRM = PERMANENT REFERENCE MONUMENT   |
| CB = CONCRETE BLOCK               | IR = IRON ROD                                  | PT = POINT OF TANGENT                |
| CBW = CONCRETE BLOCK WALL         | L = ARC LENGTH                                 | R = RADIUS                           |
| CL = CENTERLINE                   | LS = LANDSCAPING                               | RW = RIGHT OF WAY LINE               |
| CLF = CHAINLINK FENCE             | MB = MAILBOX                                   | SSCO = SANITARY SEWER CLEAN-OUT      |
| CM = CONCRETE MONUMENT            | MEAS = MEASURED                                | SW = SIDE WALK                       |
| CONC = CONCRETE                   | MF = METAL FENCE                               | TBM = TEMPORARY BENCHMARK            |
| CPP = CONCRETE POWER POLE         | MHWL = MEAN HIGH WATER LINE                    | TOB = TOP OF BANK                    |
| CVRD = COVERED                    | NGVD = NATIONAL GEODETIC VERTICAL DATUM (1929) | TOS = TOE OF SLOPE                   |
| DELTA = CENTRAL ANGLE             | NTS = NOT TO SCALE                             | TS = TRAFFIC SIGN                    |
| DEASE = DRAINAGE EASEMENT         | OH = ROOF OVERHANG                             | TYP = TYPICAL                        |
| EL = ELEVATION                    | OHW = OVERHEAD WIRES                           | UR = UNREADABLE                      |
| ENCL = ENCLOSURE                  | PC = POINT OF CURVE                            | UE = UTILITY EASEMENT                |
| EP = EDGE OF PAVEMENT             | PM = PARKING METER                             | WD = WOOD DECK                       |
| FF = FINISHED FLOOR ELEVATION     | PCC = POINT OF COMPOUND CURVE                  | WF = WOOD FENCE                      |
| FH = FIRE HYDRANT                 | PCP = PERMANENT CONTROL POINT                  | WL = WOOD LANDING                    |
| FI = FENCE INSIDE                 | PK = PARKER KALON NAIL                         | WM = WATER METER                     |
| FND = FOUND                       | POB = POINT OF BEGINNING                       | WPP = WOOD POWER POLE                |
| FO = FENCE OUTSIDE                | PI = POINT OF INTERSECTION                     | WRACK LINE = LINE OF DEBRIS ON SHORE |
| FOL = FENCE ON LINE               |  | WV = WATER VALVE                     |

NOTE: LEGAL DESCRIPTIONS HAVE BEEN FURNISHED BY THE CLIENT OR HIS/HER REPRESENTATIVE. PUBLIC RECORDS HAVE NOT BEEN RESEARCHED BY THE SURVEYOR TO DETERMINE THE ACCURACY OF THESE DESCRIPTIONS NOR HAVE ADJOINING PROPERTIES BEEN RESEARCHED TO DETERMINE OVERLAPS OR HIATUS. ADDITIONS OR DELETIONS TO SURVEY MAP OR REPORT BY OTHER THAN THE SIGNING PARTY IS PROHIBITED WITHOUT WRITTEN CONSENT OF THE SIGNING PARTY. THE BOLD LINE SHOWN HEREON REPRESENTS THE SURVEYORS OPINION OF THE DEED LINES. THE MEAN HIGH WATER LINE WAS NOT DETERMINED FOR THIS SURVEY, THE APPARENT MEAN HIGH WATER LINE IS SHOWN FOR REFERENCE ONLY.

SCALE:	1"=20'
FIELD WORK DATE	10/4/2021
MAP DATE	11/19/2021
REVISION DATE	XX/XX/XXXX
SHEET	1 OF 1
DRAWN BY:	IDG
JOB NO:	21-452

I HEREBY CERTIFY THAT THIS SURVEY WAS MADE UNDER MY RESPONSIBLE CHARGE AND MEETS THE STANDARDS OF PRACTICE AS SET FORTH BY THE FLORIDA BOARD OF PROFESSIONAL SURVEYORS AND MAPPERS IN CHAPTER 5J-17, FLORIDA ADMINISTRATIVE CODE, PURSUANT TO SECTION 472.027, FLORIDA STATUTES AND COMPLIES WITH CHAPTER 177, FLORIDA STATUTES.

SIGNED

ERIC A. ISAACS, FLSM #6783, PROFESSIONAL SURVEYOR AND MAPPER, LB# 7847

NOT VALID WITHOUT THE SIGNATURE AND THE RAISED SEAL OF A FLORIDA SURVEYOR AND MAPPER



## FLORIDA KEYS LAND SURVEYING

21460 OVERSEAS HWY, SUITE 4  
CUDJOE KEY, FL 33042  
PHONE: (305) 394-3690  
FAX: (305) 509-7373  
EMAIL: FKLSEmail@Gmail.com

# PROPOSED DESIGN

SITE DATA	DESIGN DATA	INDEX OF DRAWINGS	SCOPE OF WORK
SITE ADDRESS: 408 VIRGINIA ST, KEY WEST, FL 33040 RE: 000000000000 ZONING: HM2R FLOOD ZONE: X F.I.R.M.: COMMUNITY 12087C; MAP & PANEL #1516 SUFFIX X; DATE: 02-18-05 SECTION/TOWNSHIP/RANGE: 6-8-25 LEGAL DESCRIPTION: "W/ PT LOT 3 SQ R TR 11 (PT SUBS 2 AND 6) SETBACKS: FRONT 10 FT; SIDE 5 FT; STREET SIDE 7.5 FT REAR 15 FT OCCUPANCY: R-3 RESIDENTIAL SINGLE FAMILY TYPE OF CONSTRUCTION: VII BUILDING RISK CATEGORY: 3	THE WORK DEPICTED HEREIN WAS DESIGNED TO MEET THE REQUIREMENTS OF THE 7TH FLORIDA BUILDING CODE AND THE LATEST EDITIONS (2020) OF THE FLORIDA MODEL ENERGY CODE, FIRE CODE, LIFE SAFETY CODE AND THE NATIONAL ELECTRIC CODE. THE FOLLOWING LOADINGS WERE USED: DESIGN LOADS: ASCE 7-16 WIND LOAD: 180 mph; 3.0 psf; EXPOSURE C; ROOF LIVE LOAD 20 PSF; DEAD LOAD 15 PSF; FLOOR LL 40 PSF; DLCK LL 60 PSF SOIL BEARING CAPACITY ASSUMED 2000 LBS PER SQ.FT. FEMA FLOOD DESIGN PER ASCE 24-14	SHEET A0.0 - SITE PLAN AND SURVEY SHEET A2.0 - EXISTING FLOOR PLAN SHEET A2.1 - EXISTING ELEVATIONS SHEET A2.2 - PROPOSED FLOOR PLAN SHEET A2.3 - PROPOSED ELEVATIONS SHEET S1.0 - STRUCTURAL PLANS SHEET S1.1 - STRUCTURAL DETAILS	INTERIOR REMODEL: 1,810 SF IN TOTAL REMOVE REAR ADDITION OF HOME 189 SF NEW REAR 2 STORY PORCH 8FT X 27FT DEMOLISH REAR SHED BUILD NEW ACCESSORY STRUCTURE OF HALF BATH NEW POOL PERMITTED SEPARATELY STRUCTURAL FLOOR FRAMING PLAN AND REAR PORCH FRAMING PLAN

PROJECT DATA	PROPOSED		EXISTING		REQUIRED		VARIANCE REQUESTED	
	RE NO.	00005440-000000						
SETBACKS:								
FRONT	NO CHANGE	6'-2"	6'-2"	10'	NONE			
STREET SIDE	NO CHANGE	N/A	N/A	7.5'	NONE			
EAST SIDE	NO CHANGE	5'-6"	5'-6"	5'	NONE			
WEST SIDE	NO CHANGE	13'-1 1/2"	13'-1 1/2"	5'	NONE			
REAR	24'-3"	22'-8"	22'-8"	15'	NONE			
LOT SIZE	NO CHANGE	4048.19 SQ.FT.	4048.19 SQ.FT.	4000 SQ.FT.	NONE			
BUILDING COVERAGE	1,506 SQ.FT.	37.2%	1,657 SQ.FT.	40.9%	40% MAX	NONE		
FLOOR AREA	1,835 SQ.FT.	453	2,092 SQ.FT.	516	1.0	NONE		
BUILDING HEIGHT		NO CHANGE		30' MAX	NONE			
IMPERVIOUS AREA	2,275 SQ.FT.	56.1%	3,354 SQ.FT.	82%	60% MAX	NONE		
OPEN SPACE	1,787 SQ.FT.	44.1%	694.19 SQ.FT.	17%	35% MIN	NONE		
REAR YARD COVERAGE	220 SQ.FT.	30.0%	517 SQ.FT.	70.8%	30% MAX	NONE		

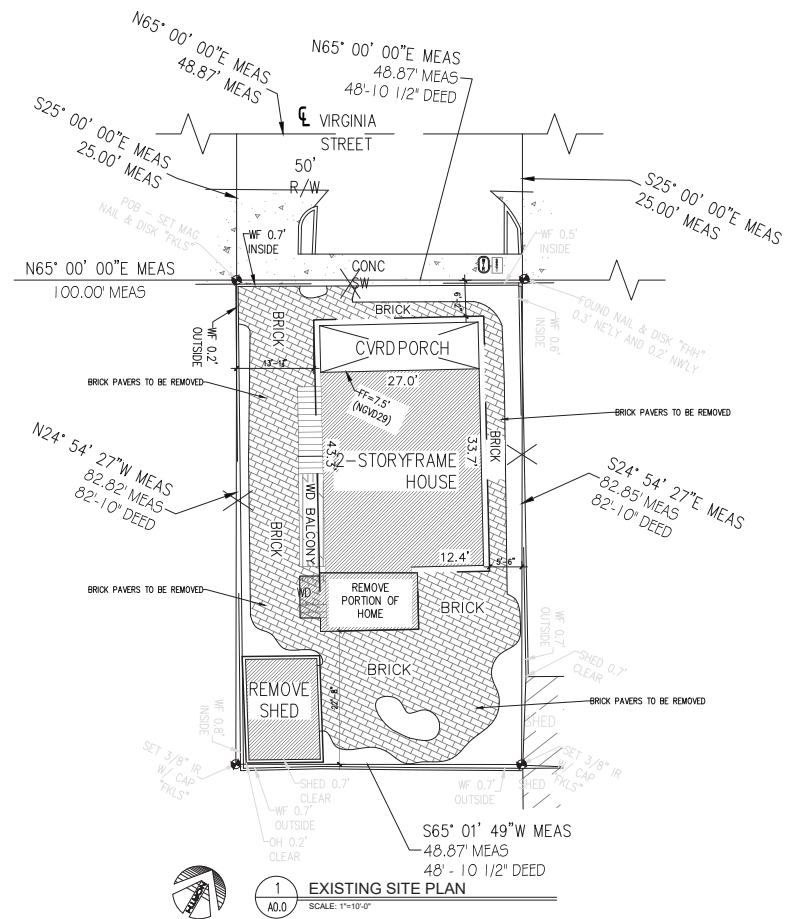
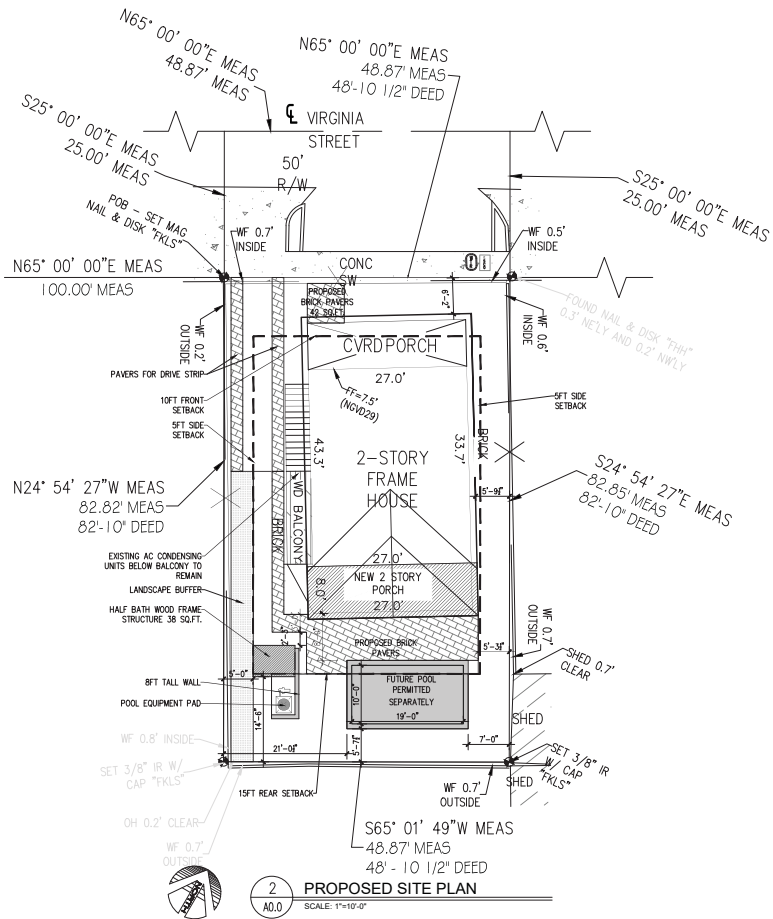

DATE: REV: SET DESCRIPTION

Erica Helen Poole  
 Digitally signed by Erica Helen Poole  
 Date: 2022.09.25 12:55:53 -0400

NOT VALID FOR CONSTRUCTION UNLESS SIGNED AND SEALED BY THE ARCHITECT

ERICA HELEN POOLE - ARCHITECT



**Brown Residence Remodel**  
 408 Virginia Street  
 Key West, FL 33040  
 Brown J Douglas Dec of Trust 6/27/2016  
 3636 Eagle Avenue  
 Key West, FL 33040

SHEET 014

**A**

**0.0**

PROJECT NO: JDB2021  
 DRAWN BY:  
 APPROVED BY:



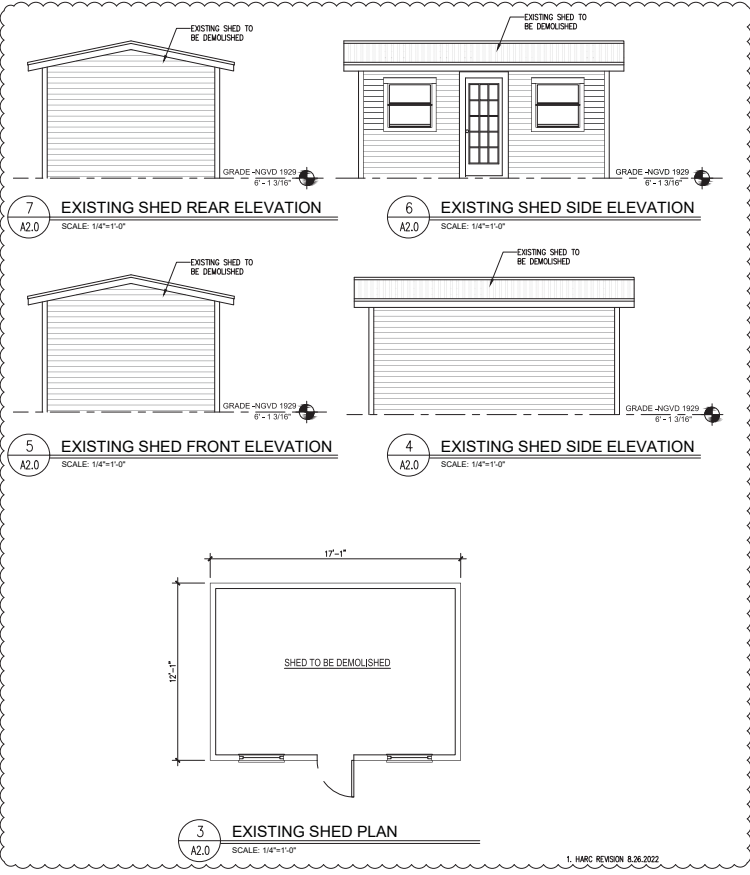

1. HARC REVISION 6.26.2022

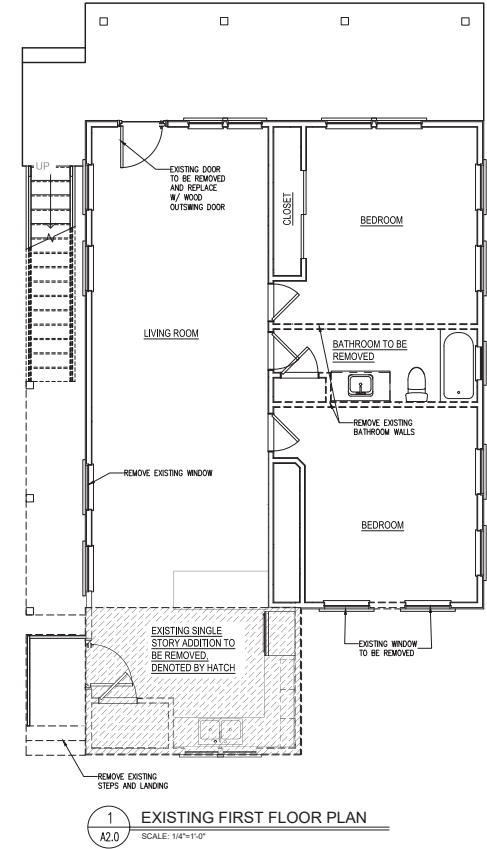
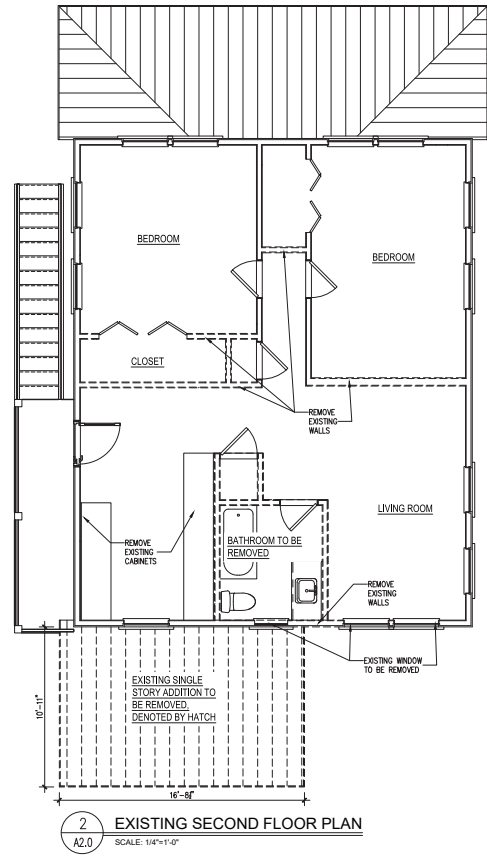

DATE	REV.	SET	DESCRIPTION
6.26.2022	1.		HARC REVISION

Erica Helen Poole  
Digitally signed by Erica Helen Poole  
Date: 2022.09.25 12:55:27 -0400

NOT VALID FOR CONSTRUCTION UNLESS SIGNED AND SEALED BY THE ARCHITECT

ERICA HELEN POOLE - ARCHITECT  
BAR00022



**Brown Residence Remodel**  
408 Virginia Street  
Key West, FL 33040  
Brown J Douglas Dec of Trust 6/27/2016  
3636 Eagle Avenue  
Key West, FL 33040

SHEET 1114

**A**

**2.0**

PROJECT NO: JDB2021  
DRAWN BY:  
APPROVED BY:



4 EXISTING SIDE ELEVATION  
A2.1 SCALE: 1/4"=1'-0"



3 EXISTING REAR ELEVATION  
A2.1 SCALE: 1/4"=1'-0"



2 EXISTING SIDE ELEVATION  
A2.1 SCALE: 1/4"=1'-0"



1 EXISTING FRONT ELEVATION  
A2.1 SCALE: 1/4"=1'-0"

DATE	REV.	DESCRIPTION

Erica Helen Poole  
Digitally signed by Erica Helen Poole  
Date: 2022.09.25 12:53:48 -04'00'

NOT VALID FOR CONSTRUCTION UNLESS SIGNED AND SEALED BY THE ARCHITECT

ERICA HELEN POOLE - ARCHITECT  
FARGO, SD  
SANDBAR DESIGN STUDIO  
SANDBAR DESIGN STUDIO  
3755 CANTON BLVD. #100  
BIRMINGHAM, AL 35202  
WWW.SANDBARDESIGNSTUDIO.COM  
848.858.8585

NAUTILUS  
DRAFTING & DESIGN  
SERVICES  
ADRIANNA PALANCA  
1000 WINDY HILL CT  
SUGAR CREEK, FL 32686

**Brown Residence Remodel**  
408 Virginia Street  
Key West, FL 33040  
Brown v Douglas Dec of Trust 6/27/2016  
3636 Eagle Avenue  
Key West, FL 33040

SHEET  
114  
A  
2.1

PROJECT NO: JDB2021  
DRAWN BY:  
APPROVED BY:

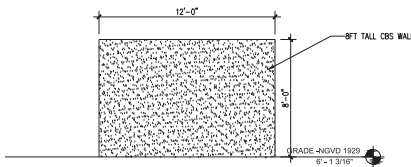

**7 PROPOSED SIDE POOL HOUSE**  
SCALE: 1/4"=1'-0"

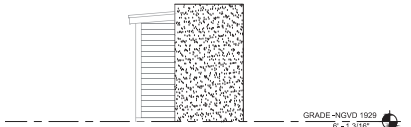

**6 PROPOSED REAR POOL HOUSE**  
SCALE: 1/4"=1'-0"



**5 PROPOSED SIDE POOL HOUSE**  
SCALE: 1/4"=1'-0"

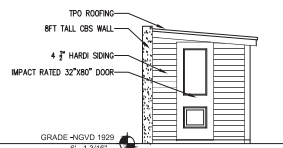

**4 PROPOSED FRONT POOL HOUSE**  
SCALE: 1/4"=1'-0"

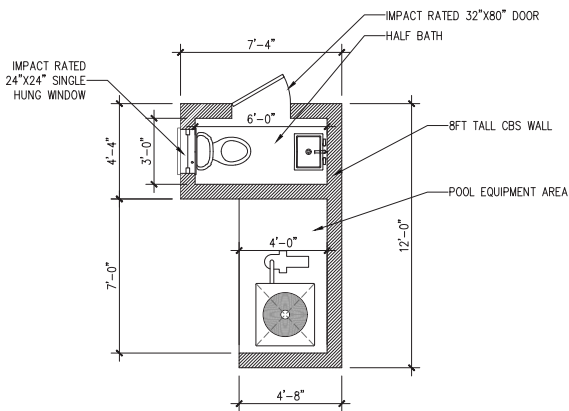

**3 PROPOSED POOL HOUSE**  
SCALE: 3/8"=1'-0"

1, HARC REVISION 8.26.2022

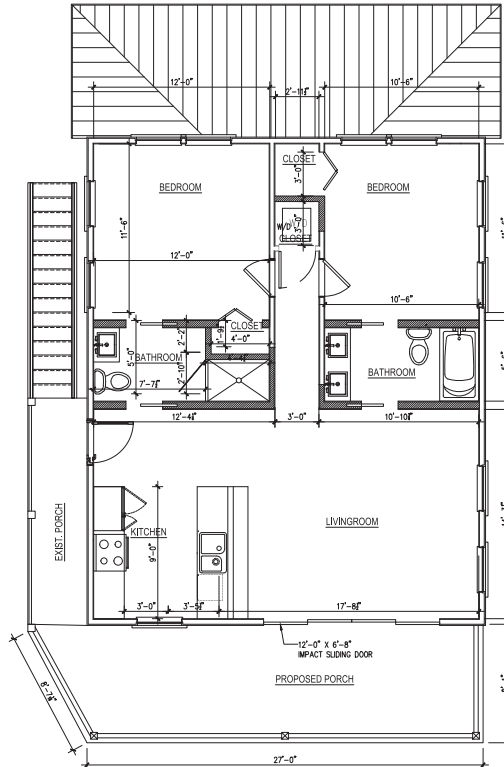

**2 PROPOSED SECOND FLOOR PLAN**  
SCALE: 1/4"=1'-0"

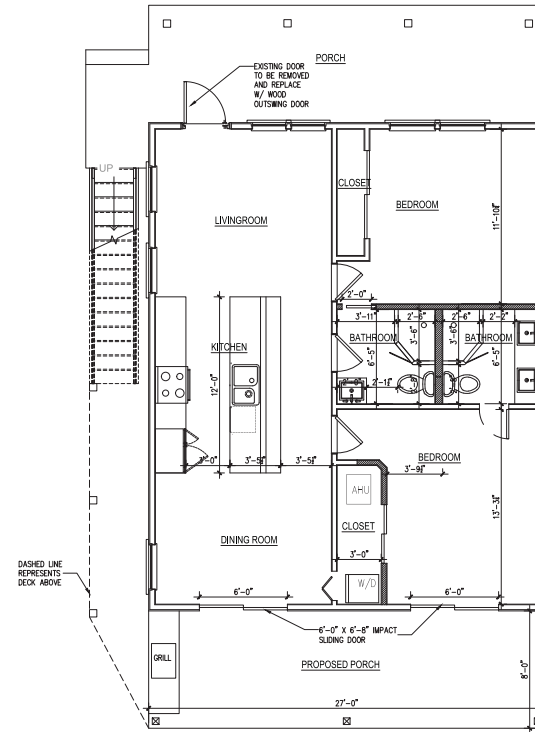

**1 PROPOSED FIRST FLOOR PLAN**  
SCALE: 1/4"=1'-0"

DATE	REV./SET	DESCRIPTION
8.23.2022	2	HARC AND OWNER REVISIONS

Erica Helen Poole  
Digitally signed by Erica Helen Poole  
Date: 2023.09.25 12:56:06 -0400

NOT VALID FOR CONSTRUCTION UNLESS SIGNED AND SEALED BY THE ARCHITECT

ERICA HELEN POOLE - ARCHITECT



**Brown Residence Remodel**  
408 Virginia Street  
Key West, FL 33040  
Brown J Douglas Dec of Trust 6/27/2016  
3636 Eagle Avenue  
Key West, FL 33040

A  
2.2



5 STREET VIEW ELEVATION  
SCALE: 3/16"=1'-0"

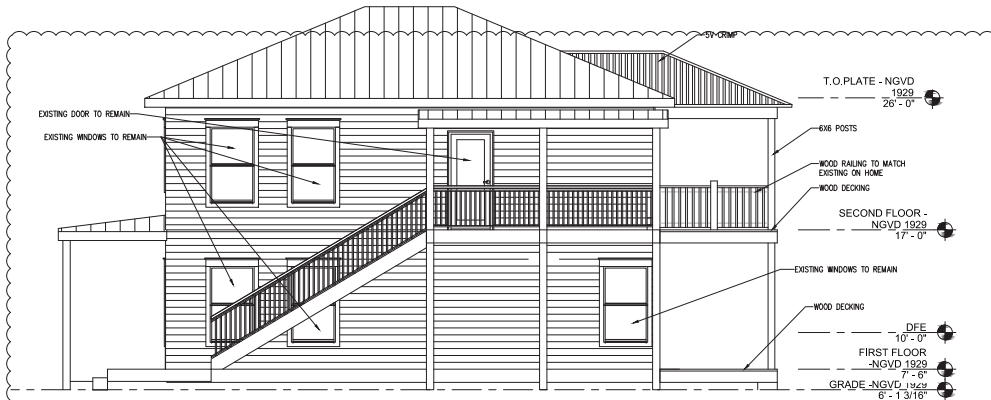

4 PROPOSED SIDE ELEVATION  
SCALE: 1/4"=1'-0"



2 PROPOSED SIDE ELEVATION  
SCALE: 1/4"=1'-0"



3 PROPOSED REAR ELEVATION  
SCALE: 1/4"=1'-0"



1 PROPOSED FRONT ELEVATION  
SCALE: 1/4"=1'-0"

DATE	REV.	DESCRIPTION
8.28.2022	1.	HARC REVISION
9.23.2022	2.	HARC AND OWNER REVISIONS

Erica Helen Poole  
Digitally signed by Erica Helen Poole  
Date: 2022.09.25 12:56:29 -04'00'

NOT VALID FOR CONSTRUCTION UNLESS SIGNED AND SEALED BY THE ARCHITECT

ERICA HELEN POOLE - ARCHITECT  
FARGO, ND  
SANDBAR DESIGN STUDIO  
SANDBAR DESIGN STUDIO  
3915 CHAMBERLAIN AVE  
BIG PINE KEY, FL 32909  
WWW.SANDBARDESIGNSTUDIO.COM  
849.653.8585

NAUTILUS DRAFTING & DESIGN SERVICES  
ASHLEY TALAZO  
1000 WINDY ST  
SUITE 104 KEY, FL 32909

**Brown Residence Remodel**  
408 Virginia Street  
Key West, FL 33040  
Brown J Douglas Dec of Trust 6/27/2016  
3636 Eagle Avenue  
Key West, FL 33040

PROJECT NO: A2.3  
DRAWN BY: JDB  
APPROVED BY: JDB

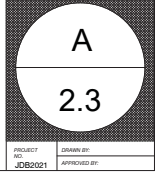

1. HARC REVISION 8.28.2022

PROJECT DATA						
	PROPOSED		EXISTING		REQUIRED	VARIANCE REQUESTED
RE NO.	00005440-000000					
SETBACKS:						
FRONT	NO CHANGE		6'-2"		10'	NONE
STREET SIDE	NO CHANGE		N/A		7.5'	NONE
EAST SIDE	NO CHANGE		5'-6"		5'	NONE
WEST SIDE	NO CHANGE		13'-1 1/2"		5'	NONE
REAR	24'-3"		22'-8"		15'	NONE
LOT SIZE	NO CHANGE		4048.19 SQ.FT.		4000 SQ.FT.	NONE
BUILDING COVERAGE	1,506 SQ.FT.	37.2%	1,657 SQ.FT.	40.9%	40% MAX	NONE
FLOOR AREA	1,835 SQ.FT.	.453	2,092 SQ.FT.	.516	1.0	NONE
BUILDING HEIGHT			NO CHANGE		30' MAX	NONE
IMPERVIOUS AREA	2,275 SQ.FT.	56.1%	3,354 SQ.FT.	82%	60% MAX	NONE
OPEN SPACE	1,787 SQ.FT.	44.1%	694.19 SQ.FT.	17%	35% MIN	NONE
REAR YARD COVERAGE	220 SQ.FT.	30.0%	517 SQ.FT.	70.8%	30% MAX	NONE

The Project Data Chart on our plan shows the major improvements at 408 Virginia bringing the project into total compliance and requiring NO variances.

Our proposal exceeds and improves current code requirements in all areas.

We are excited and proud of the improvements we will be making to this property while maintaining the historical image of our home on this important block of Key West.

# NOTICING

# Public Meeting Notice

The Historic Architectural Review Commission will hold a public meeting at **5:00 p.m., October 26, 2022, at City Hall, 1300 White Street**, Key West, Florida. To view the live feed of the meeting, you can tune in to Comcast channel 77, AT&T Uverse channel 99. If you wish to participate virtually, please contact HARC staff at 305-809-3973. The purpose of the hearing will be to consider a request for:

**NEW TWO-STORY PORCH AT REAR. CHANGES OF DOORS AND WINDOWS ON MAIN HOUSE. NEW ACCESSORY STRUCTURE, POOL, AND SITE IMPROVEMENTS. DEMOLITION OF REAR ONE-STORY ADDITION. DEMOLITION OF ACCESSORY STRUCTURE.**

**#408 VIRGINIA STREET**

**Applicant – J. Doug Brown Application #H2022-0041**

If you wish to see the application or have any questions, you may visit the Planning Department during regular office hours at 1300 White Street, call 305-809-3973 or visit our website at [www.cityofkeywest-fl.gov](http://www.cityofkeywest-fl.gov).

**THIS NOTICE CAN NOT BE REMOVED FROM THE SITE UNTIL HARC FINAL DETERMINATION**

ADA ASSISTANCE: It is the policy of the City of Key West to comply with all requirements of the Americans with Disabilities Act (ADA). Please call the TTY number at 800-955-8771 or 800-955-8770 (Voice) or the ADA Coordinator at 305-809-3811 at least five business days in advance for sign language interpreters, assistive listening devices, or materials in accessible format.

# PROPERTY APPRAISER INFORMATION



**Disclaimer**

The Monroe County Property Appraiser's office maintains data on property within the County solely for the purpose of fulfilling its responsibility to secure a just valuation for ad valorem tax purposes of all property within the County. The Monroe County Property Appraiser's office cannot guarantee its accuracy for any other purpose. Likewise, data provided regarding one tax year may not be applicable in prior or subsequent years. By requesting such data, you hereby understand and agree that the data is intended for ad valorem tax purposes only and should not be relied on for any other purpose.

By continuing into this site you assert that you have read and agree to the above statement.

**Summary**

Parcel ID 00028120-000000  
 Account# 1028894  
 Property ID 1028894  
 Millage Group 11KW  
 Location 408 VIRGINIA St, KEY WEST  
 Address  
 Legal KW PT LOT 3 SQR 6 TR 11 (PT SUBS 2 AND 6) OR152-410/11 OR432-812/13 OR820-312 OR1168-675 OR1170-50 OR1444-1368/70 OR1593-1949 OR1627-1587/88 OR1674-1763 OR1941-360/61 OR3117-1316  
 Description  
 (Note: Not to be used on legal documents.)  
 Neighborhood 6108  
 Property MULTI-FAMILY DUPLEX (0802)  
 Class  
 Subdivision  
 Sec/Twp/Rng 06/68/25  
 Affordable No  
 Housing



**Owner**

[BROWN J DOUGLAS DEC OF TRUST 6/27/2016](#)  
 3636 Eagle Ave  
 Key West FL 33040

**Valuation**

	2022 Working Values	2021 Certified Values	2020 Certified Values	2019 Certified Values
+ Market Improvement Value	\$370,401	\$270,351	\$274,106	\$277,861
+ Market Misc Value	\$5,136	\$5,254	\$5,372	\$5,490
+ Market Land Value	\$752,729	\$570,731	\$523,023	\$504,785
= Just Market Value	<b>\$1,128,266</b>	<b>\$846,336</b>	<b>\$802,501</b>	<b>\$788,136</b>
= Total Assessed Value	<b>\$1,128,266</b>	<b>\$846,336</b>	<b>\$802,501</b>	<b>\$788,136</b>
- School Exempt Value	\$0	\$0	\$0	\$0
= School Taxable Value	<b>\$1,128,266</b>	<b>\$846,336</b>	<b>\$802,501</b>	<b>\$788,136</b>

**Land**

Land Use	Number of Units	Unit Type	Frontage	Depth
MULTI RES DRY (080D)	4,062.00	Square Foot	49	83

**Buildings**

Building ID 2180  
 Style 2 STORY ELEV FOUNDATION  
 Building Type M.F. - R2 / R2  
 Gross Sq Ft 3518  
 Finished Sq Ft 1986  
 Stories 2 Floor  
 Condition GOOD  
 Perimeter 264  
 Functional Obs 0  
 Economic Obs 0  
 Depreciation % 16  
 Interior Walls WALL BD/WD WAL

Exterior Walls ABOVE AVERAGE WOOD  
 Year Built 1938  
 EffectiveYearBuilt 2007  
 Foundation WD CONC PADS  
 Roof Type GABLE/HIP  
 Roof Coverage METAL  
 Flooring Type SFT/HD WD  
 Heating Type FCD/AIR DUCTED  
 Bedrooms 4  
 Full Bathrooms 2  
 Half Bathrooms 0  
 Grade 550  
 Number of Fire Pl 0

Code	Description	Sketch Area	Finished Area	Perimeter
OPX	EXC OPEN PORCH	232	0	0
DUF	FIN DET UTILIT	180	0	0
FLA	FLOOR LIV AREA	1,986	1,986	0
OPU	OP PR UNFIN LL	25	0	0
OUF	OP PRCH FIN UL	40	0	0
PTO	PATIO	1,055	0	0

TOTAL	3,518	1,986	0
-------	-------	-------	---

### Yard Items

Description	Year Built	Roll Year	Quantity	Units	Grade
BRICK PATIO	2001	2002	1	621 SF	2
FENCES	2001	2002	1	180 SF	2
FENCES	2001	2002	1	792 SF	2

### Sales

Sale Date	Sale Price	Instrument	Instrument Number	Deed Book	Deed Page	Sale Qualification	Vacant or Improved
7/30/2021	\$975,000	Warranty Deed	2333500	3117	1316	01 - Qualified	Improved
10/1/2003	\$735,000	Warranty Deed		1941	0360	Q - Qualified	Improved
1/31/2001	\$320,000	Warranty Deed		1674	1763	Q - Qualified	Improved
2/1/1969	\$6,500	Conversion Code		432	812	Q - Qualified	Improved

### Permits

Number	Date Issued	Date Completed	Amount	Permit Type	Notes
04-0955	3/29/2004	11/5/2004	\$250		REPAIR CONCRETE
02-3205	12/5/2002	10/9/2003	\$2,000		NEW DECK & RAILS
02-2577	9/23/2002	10/9/2003	\$6,000		INSTALL PORTABLE SPA
02-1759	8/5/2002	10/9/2003	\$24,790		SEWER,ELECT.REBUILD RAMP
02-495	3/1/2002	10/9/2003	\$600		ELECTRICAL
02-0441	2/26/2002	10/9/2003	\$800		RESIDE UTILITY BLDG
01-3300	1/4/2002	10/9/2003	\$55,800		RENOVATE DOWNSTAIRS
01-2393	6/26/2001	10/26/2001	\$2,600		INSTALL C/AC

### View Tax Info

[View Taxes for this Parcel](#)

Sketches (click to enlarge)

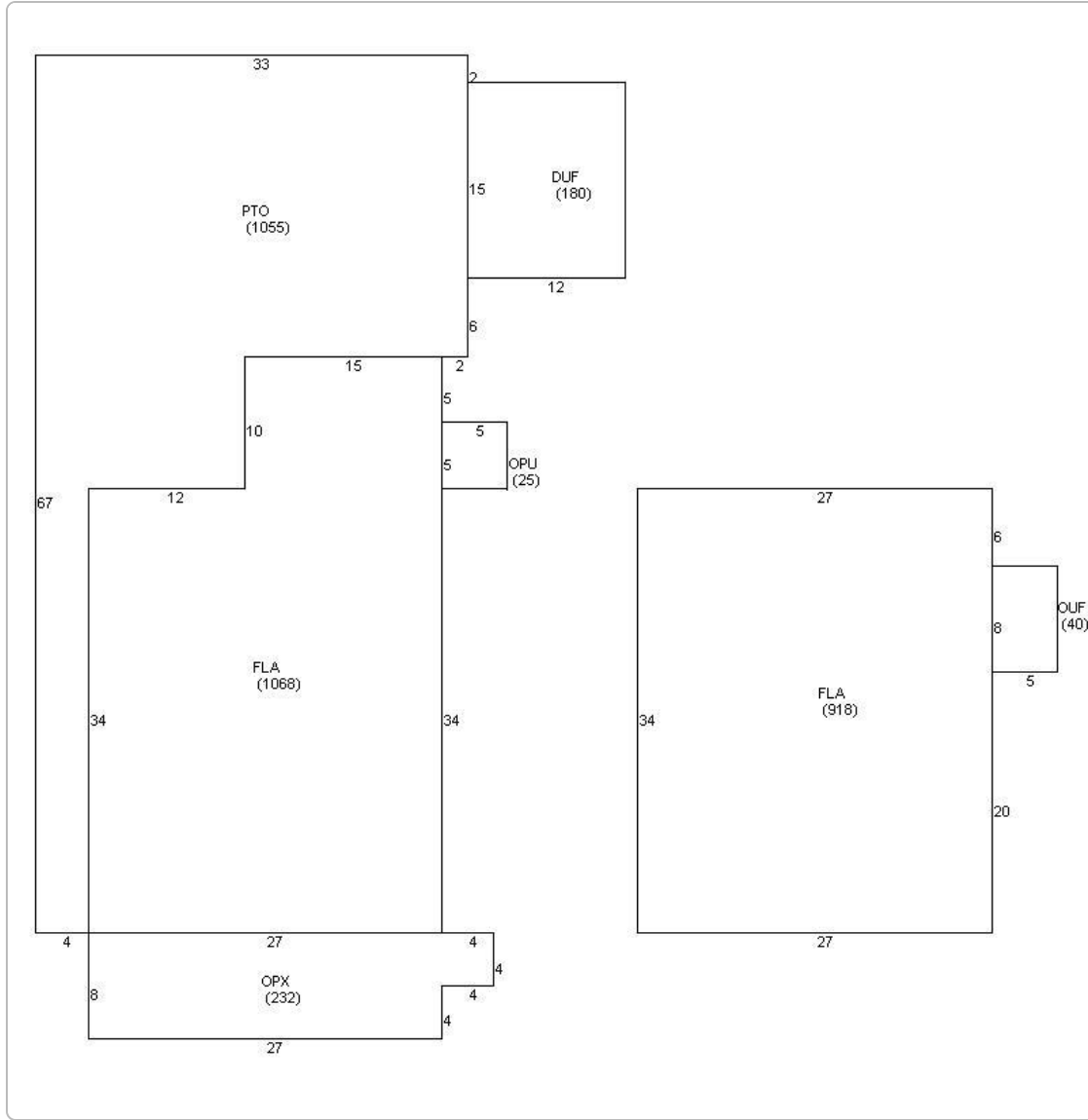

Photos



Map



TRIM Notice

[2022 TRIM Notice \(PDF\)](#)

**2022 Notices Only**

The Monroe County Property Appraiser's office maintains data on property within the County solely for the purpose of fulfilling its responsibility to secure a just valuation for ad valorem tax purposes of all property within the County. The Monroe County Property Appraiser's office cannot guarantee its accuracy for any other purpose. Likewise, data provided regarding one tax year may not be applicable in prior or subsequent years. By requesting such data, you hereby understand and agree that the

[User Privacy Policy](#)  
[GDPR Privacy Notice](#)

Last Data Upload: [10/17/2022, 2:16:11 AM](#)

Developed by  
 Schneider  
GEOSPATIAL

Version 2.3.225