

RESOLUTION NO. 24-024

**A RESOLUTION OF THE CITY COMMISSION OF THE CITY OF KEY WEST (CITY) APPROVING A CHANGE ORDER IN THE AMOUNT OF \$181,614.58 FOR THE ADDITION OF SOLAR PANELS AND RELATED WORK ON FREDERICK DOUGLASS COMMUNITY CENTER PROJECT, UNDER THE CONTRACT AWARDED TO KEYSTAR INC. PER RES #23-193; AUTHORIZING ANY NECESSARY BUDGET TRANSFERS AND AMENDMENTS; AUTHORIZING THE CITY MANAGER TO EXECUTE NECESSARY DOCUMENTS UPON ADVICE AND CONSENT OF THE CITY ATTORNEY; PROVIDING FOR AN EFFECTIVE DATE**

WHEREAS, in Resolution No. 23-193 a contract was awarded to Keystar, Inc. for the Frederick Douglass Community Center Project, in response to ITB #23-005; and

WHEREAS, Keystar, Inc., in conjunction with SALT Energy, and City staff has prepared a proposal which includes upgrading the roof membrane, and installation of a solar energy system to provide sustainable power, and accepting government incentive of up to 30% of costs; and

WHEREAS, the solar system is anticipated to provide annual energy savings of \$7,400 per year, with a return on investment period projected to be 15.05 years; and

WHEREAS, City staff recommends approval of the solar energy change order for the New Frederick Douglass Gym, to support community resilience and climate action; and

NOW, THEREFORE, BE IT RESOLVED BY CITY COMMISSION OF THE CITY OF KEY WEST, AS FOLLOWS:

Section 1: That the attached Change Order in the amount of \$181,614.68 for a Change Order to add Solar Energy and related tasks, under the contract awarded to Keystar, Inc. (ITB 23-005) in Resolution 23-193, is hereby approved.

Section 2: That funds for this change order will be transferred from Bahama Village TIF Fund reserve account #601-5502-555-9800 in the amount of \$181,614.68 to Bahama Village TIF Fund account #601-5502-555-6200 (Project BV55021701) (CRA Bahama Village Capital Improvements). Any necessary budget transfers or amendments are hereby authorized.

Section 3: That the City Manager is authorized to execute documents related to this Change Order, upon the advice and consent of the City Attorney.

Section 4: That this Resolution shall go into effect immediately upon its passage and adoption and authentication by the signature of the Presiding Officer and the Clerk of the Commission.

Passed and adopted by the City Commission at a meeting held this 8th day of February, 2024.

Authenticated by the Presiding Officer and Clerk of the Commission on 8th day of February, 2024.

Filed with the Clerk on February 8, 2024.

Mayor Teri Johnston	<u>Yes</u>
Vice Mayor Sam Kaufman	<u>Yes</u>
Commissioner Lissette Carey	<u>Yes</u>
Commissioner Mary Lou Hoover	<u>Yes</u>
Commissioner Clayton Lopez	<u>Absent</u>
Commissioner Billy Wardlow	<u>Yes</u>
Commissioner Jimmy Weekley	<u>Absent</u>

  
TERI JOHNSTON, MAYOR

ATTEST:

  
KERI O'BRIEN, CITY CLERK



## MEMORANDUM

---

**Date:** February 8, 2024

**To:** Honorable Mayor and Commissioners

**Via:** Albert P. Childress  
City Manager 

**From:** Katie P. Halloran  
Planning Director

**Subject:** **24-5314 Frederick Douglass Community Center – Adding Solar to the Project**

---

### Introduction

This resolution will approve a Change Order for Keystar Inc. to add Solar to the new Frederick Douglass Community Center, in the amount of \$181,614.68, with an expected 30% refund, and to authorize the City Manager to execute the contract and provide any necessary budget transfers/amendments.

### Background

The Frederick Douglass Community Center project was bid with an “Add Alternate for Design-Build Solar Design”, to reflect an existing City Commission directive to review solar power installation options for City projects. Keystar Inc. and SALT Energy worked with the city to determine the best solutions to add a solar energy system to the Community Center project. The current proposal outlines using the high roof of the Main Hall and includes upgrades to the roof membrane to work with the solar panel mounting system to limit the amount of roof penetrations. The system will be 28.2 KW with a 25-year warranty and will supply power to two meters that power the majority of the building. The cost for the solar system is (\$159,120 – 30% government incentive = \$111,384). With annual projected electric bill savings of \$7,400, the City would enjoy a full return on initial investment at 15.05 years. The upgraded roof would be required as an integral part to the solar array mounting system and will carry an additional 10-year warranty for a total 30-year roof warranty. The roof upgrade would cost \$15,746 after the 30% government incentive, to be reimbursed to the city.

SALT Energy will work with the city to monitor the system remotely and provide assistance per the included agreement. The City Facilities Maintenance team can also hire/ train the staff that are needed to

maintain the system and to work with SALT Energy to keep the system running at peak performance. A recommended annual cost of \$800 to \$1,300 should be budgeted each year for labor not covered under warranty.

A 300KW Diesel Generator will be installed and the proposed solar energy system would work with the generator to allow it to run at a lower capacity during a power outage, adding to the resiliency of the building.

The project timeline for resolutions related to solar are as follows:

Resolution 19-328: Solar Panel report for major development of City Buildings.

Resolution 20-028: K2M Amendment 1

Resolution 20-160: K2M Amendment 2

Resolution 22-092 Solar evaluation for the Fredrick Douglass Community Center

Resolution 23-193 Keystar, Inc. Construction Award for \$7,985,927.86

### **Procurement**

Funding for this change order will be transferred from Bahama Village TIF Fund reserve account 601-5502-555-9800 in the amount of \$181,614.68 to Bahama Village TIF Fund account 601-5502-555-6200, Project Number BV55021701, bringing the total contract amount to \$8,167,542.54.

### **Recommendation**

This resolution will approve a Change Order for Keystar Inc. to add Solar to the New Frederick Douglass Community Center, in the amount of \$181,614.68, and to authorize the City Manager to execute the contract and provide any necessary budget transfers/amendments.



**CHANGE ORDER REQUEST SUMMARY BREAKDOWN**

PROJECT: Frederick Douglass Community Center  
 111 Olivia Street  
 Key West, FL 33040

CHANGE ORDER REQUEST #: Eight (8R2)  
 DATE OF ISSUANCE: 12/20/2023

GC PROJECT NO: 23008

OWNER: City of Key West  
 1300 White Street  
 Key West, FL 33040

*We request changes in the Contract Sum and Contract Time for proposed modifications to the Contract Documents as described herein (see description below):*

Description	Subcontractor	Material	Labor	Subcontract/Lump Sum
Provide solar scope of work including upgrade of upper Main Hall roof to Everguard Extreme with 30 year warranty. Includes \$10,000 allowance for GAF roof slip sheets if necessary. Includes micro inverters to split solar between 2 panels PP and TP.				
Solar System	SALT Services			\$ 112,358.00
Split solar between two meters (Panel PP and TP)	SALT Services			\$ 8,642.00
Main Hall roof upgrade to Everguard Extreme 30 year warranty	A Plus Roofing			\$ 17,750.00
Electrical Allowance for solar/tie-in to 400 amp transfer switch	Check Electric			\$ 7,000.00

Subtotal	\$ 145,750.00
General Conditions (6.5%)	\$ 9,473.75
General Requirements (4%)	\$ 5,830.00
Direct Construction Cost	\$ 161,053.75
Indirect Construction Cost	\$ 16,105.38
Fee (10%)	\$ 1,771.59
Bond (1%)	\$ 2,683.96
Insurance (1.5%)	\$ 20,560.93

**Item Total \$ 181,614.68**

Additional days requested: TBD - We reserve our rights in the event this added scope of work impacts the project schedule

## Frederick Douglass Solar Project - Options

### Option 1: 28.2 KW PV feeding the 400 Amp service only (Panel PP)

- Single Meter Connection Cost: \$112k for PV only
- Inverter is 30 KW Sol-Ark hybrid (works with or without batteries)
- Battery Options – up to 3 x 40 kWh increments (120 kWh max)
- 30 KW Inverter Sol-Ark is smallest size, so not cost effective to split system

### Option 2: 28.2 KW PV system split between two meters

- Two Meter Connection Cost: \$121k for PV only
- Use Hybrid Microinverters (also work with or without batteries)
- 4 panels per inverter, 16 total microinverters required
- 17.6 KW PV using 10 microinverters connected to the 400 Amp service (Panel PP)
- 10.6 KW PV using 6 microinverters connected to the 225 Amp service (Panel TP)
- AC Connection can be made directly to each service panel, allowing solar to operate while on generator.
- Battery Options: Up to 64 kWh max (one per solar panel)
- This Battery Option is 60% more expensive per kWh than the Option 1 battery.

- NOTE: If the goal is to avoid selling any energy back to the grid at the highly discounted rate, Option 2 achieves that goal by splitting the solar at an increased cost of \$9 k, whereas Option one must use a battery to achieve that objective, which adds \$48 k of additional cost.



## 430-450W Commercial A-Series Panels

### SunPower® Maxeon® Cell-based Solar Panels

SunPower® Maxeon® cell-based panels maximize energy production and savings by combining industry-leading power, efficiency, and durability with the best warranty available in the market.<sup>1,2</sup>

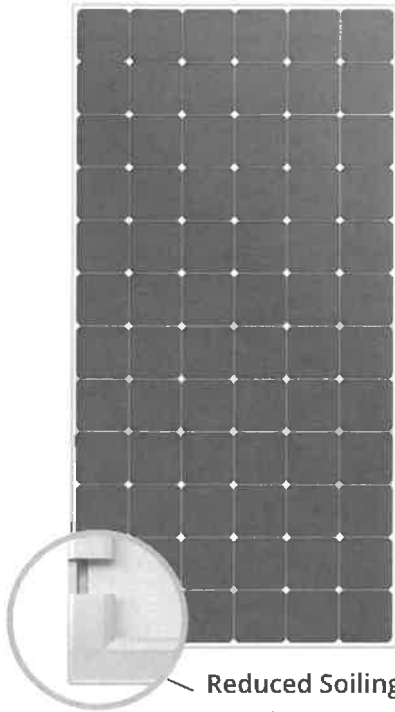

**Reduced Soiling**  
NEW drainage notch improves performance



### Highest Power Density Available

SunPower's new Maxeon® Gen 4 cell is 65% larger than prior generations, delivering the most powerful cell and highest efficiency panel in commercial solar. The result is more power per square meter than any commercially available solar.<sup>2</sup>

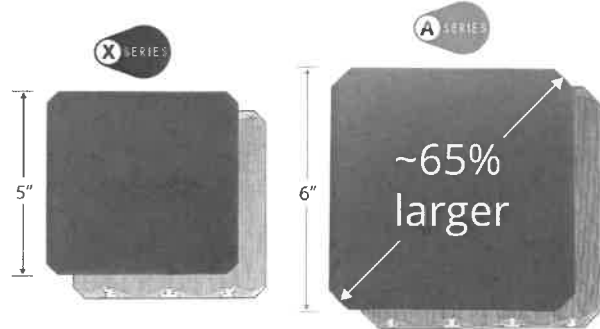

### SUNPOWER MAXEON SOLAR CELL TECHNOLOGY



#### Fundamentally Different. And Better.

- Most powerful cell in commercial solar
- Delivers unmatched reliability<sup>1</sup>
- Patented solid metal foundation prevents breakage and corrosion

#### As sustainable as the energy it produces.

- Ranked #1 in Silicon Valley Toxics Coalition 2015 Solar Scorecard<sup>1</sup>
- Contributes to more LEED categories than conventional panels<sup>2</sup>



### Highest Lifetime Energy and Savings

Designed to deliver 60% more energy in the same space *over* 25 years in real-world conditions like partial shade and high temperatures.<sup>2</sup>

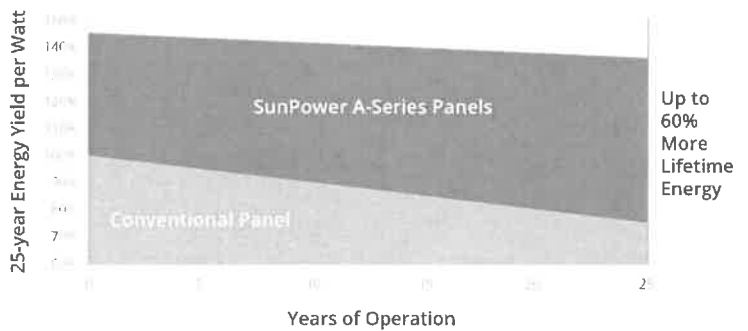

### Best Reliability, Best Warranty

SunPower technology is proven to last and we stand behind our panels with the industry's best 25-year Combined Power, Product and Service Warranty.





## 430-450W Commercial A-Series Panels – Preliminary datasheet

Electrical Data			
	SPR-A450-COM	SPR-A440-COM	SPR-A430-COM
Nominal Power (P <sub>nom</sub> ) <sup>1</sup>	450 W	440 W	430 W
Power Tolerance	+5/0%	+5/0%	+5/0%
Panel Efficiency	22.2%	21.7%	21.2%
Rated Voltage (V <sub>mpp</sub> )	44.0 V	43.4 V	42.7 V
Rated Current (I <sub>mpp</sub> )	10.2 A	10.2 A	10.1 A
Open-Circuit Voltage (V <sub>oc</sub> )	51.9 V	51.6 V	51.2 V
Short-Circuit Current (I <sub>sc</sub> )	11.0 A	10.9 A	10.9 A
Max. System Voltage	1500 V UL		
Maximum Series Fuse	20 A		
Power Temp Coef.	-0.26% / °C		
Voltage Temp Coef.	-136 mV / °C		
Current Temp Coef.	5.7 mA / °C		

Operating Condition And Mechanical Data	
Temperature	-40° F to +185° F (-40° C to +85° C)
Impact Resistance	1 inch (25 mm) diameter hail at 52 mph (23 m/s)
Appearance	Class A
Solar Cells	72 Monocrystalline IBC cells
Tempered Glass	High-transmission tempered anti-reflective
Junction Box	IP-68, MC4 Compatible
Weight	40.5 lbs (18.4 kg)
Max. Load	Wind: 75 psf, 3600 Pa, 367 kg/m <sup>2</sup> front & back Snow: 125 psf, 6000 Pa, 612 kg/m <sup>2</sup> front
Frame	Class 2 silver anodized

Tests And Certifications - Pending	
Standard Tests	UL1703
Quality Management Certs	ISO 9001:2015, ISO 14001:2015
EHS Compliance	RoHS, OHSAS 18001:2007, lead free, Recycle Scheme, REACH SVHC-163
Sustainability	Cradle to Cradle Certified™ Silver. "Declare." listed.
Ammonia Test	IEC 62716
Desert Test	10.1109/PVSC.2013.6744437
Salt Spray Test	IEC 61701 (maximum severity)
PID Test	1500 V: IEC 62804, PVEL 600 hr duration
Available Listings	UL

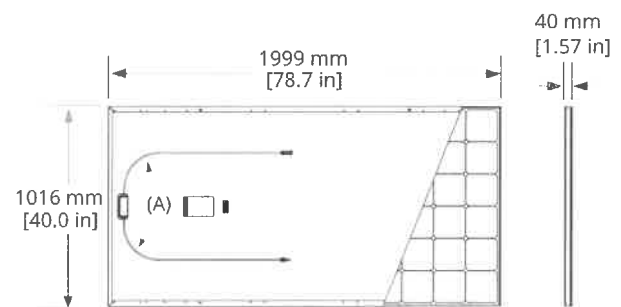

FRAME PROFILE

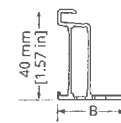

(A) Cable Length: 1320 mm [52 in]

(B) Long Side: 30 mm [1.2 in]

Short Side: 22 mm [0.9 in]

Please read the safety and installation guide

<sup>1</sup> SunPower 450 W, 22.2% efficient, compared to a Conventional Panel on same-sized arrays (310 W, 16% efficient; approx. 2.0 m<sup>2</sup>; 49% more energy per watt (based on PV Syst panel files for avg US climate), 0.5%/yr slower degradation rate (Jordan, et al. "Robust PV Degradation Methodology and Application." PVSC 2018).

<sup>2</sup> Based on search of datasheet values from websites of top 10 manufacturers per IHS, as of January 29/18.

<sup>3</sup> #1 ranking "Fraunhofer PV Durability Initiative for Solar Modules" Part 3: "PV Tech Power Magazine" 2015; Campbell, Z. et al. "SunPower Module Degradation Rate" SunPower white paper, 2013.

<sup>4</sup> SunPower is rated #1 on Silicon Valley Toxic Coalition's Solar Scorecard.

<sup>5</sup> A-Series panels additionally contribute to LEED Materials and Resources credit categories. Standard Test Conditions (1000 W/m<sup>2</sup> irradiance, AM 1.5, 25° C), NREL calibration. Standard: SOHS current, LACS FF and Voltage.

See [www.sunpower.com/company](http://www.sunpower.com/company) for more reference information.

For more details, see extended datasheet [www.sunpower.com/sites/default/files/specifications](http://www.sunpower.com/sites/default/files/specifications) included in this datasheet are subject to change without notice.

©2018 SunPower Corporation. All rights reserved. SUNPOWER, the SUNPOWER logo, and MAX200 are trademarks or registered trademarks of SunPower Corporation.

# SUNPOWER®

1-800-SUNPOWER

532365 Rev A / LTR\_US

[sunpower.com](http://sunpower.com)



**PANELCLAW®**

**clawFR 10 Degree 5 Degree and Dual Tilt  
Component Cut Sheets**



# Component Cut Sheet

## 10 Degree and Dual Tilt "Module Connector"

REVISION				
REV.	ECO#	DESCRIPTION	DATE	APPROVED
A	C00548	INITIAL RELEASE	21-JAN-19	JA
B	C00619	UPDATED PARTS, UPDATED BALLAST RAIL TO RAIL	29-MAY-20	JA
C	C00650	ADDED -03, -04, -08	13-JAN-21	JA

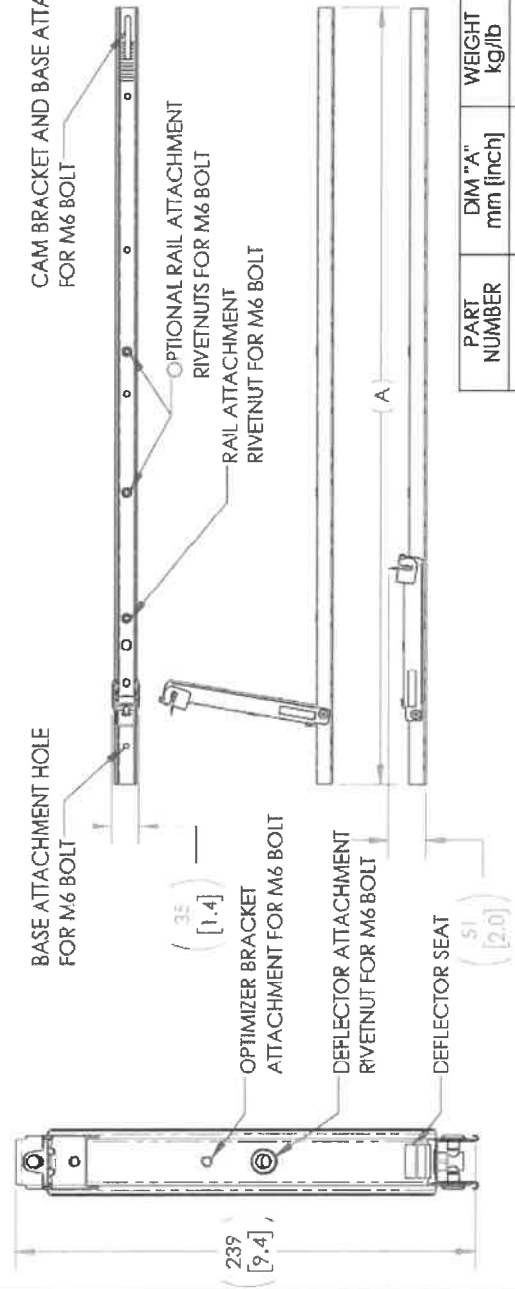

PART NUMBER	DIM "A" mm [inch]	WEIGHT kg/lb	MODULE WIDTH mm
C-500050701	1100.0[43.31]	0.63/1.39	990 - 1030
C-500050702	1140.0[44.88]	0.64/1.42	1031 - 1070
C-500050703	1180.0[46.46]	0.66/1.46	1071 - 1110
C-500050704	1220.0[48.03]	0.68/1.49	1111 - 1150
C-500050708	1380.0[54.33]	0.74/1.64	1270 - 1310

**PANELCLAW**  
 PROPRIETARY AND CONFIDENTIAL  
 THE INFORMATION CONTAINED IN THIS DRAWING IS THE SOLE PROPERTY OF PANELCLAW. ANY REPRODUCTION IN PART OR AS A WHOLE WITHOUT THE WRITTEN PERMISSION OF PANELCLAW IS PROHIBITED.  
 PanelClaw, Inc.  
 1000 Osgood St., Suite 2023,  
 North Andover, MA 01845  
 Phone: 078.688.5100  
 Fax: 078.688.5100  
 www.panelclaw.com

<b>MODULE CONNECTOR, 10 DEGREE, CFR</b>		REV	<b>C</b>
SIZE	<b>A</b>	DWG. NO.	<b>C5000507XX</b>
SCALE: NONE	WT SEE TABLE	kg/lb	SHEET 1 OF 1





# Component Cut Sheet

## 5 Degree "Module Connector"

REVISION				
REV.	ECO#	DESCRIPTION	DATE	APPROVED
A	C00583	INITIAL RELEASE	02-JUL-19	JA
B	C00619	PART UPDATED	29-MAY-20	JA
C	C00650	ADDED -03, -04, -08	11-JAN-21	JA

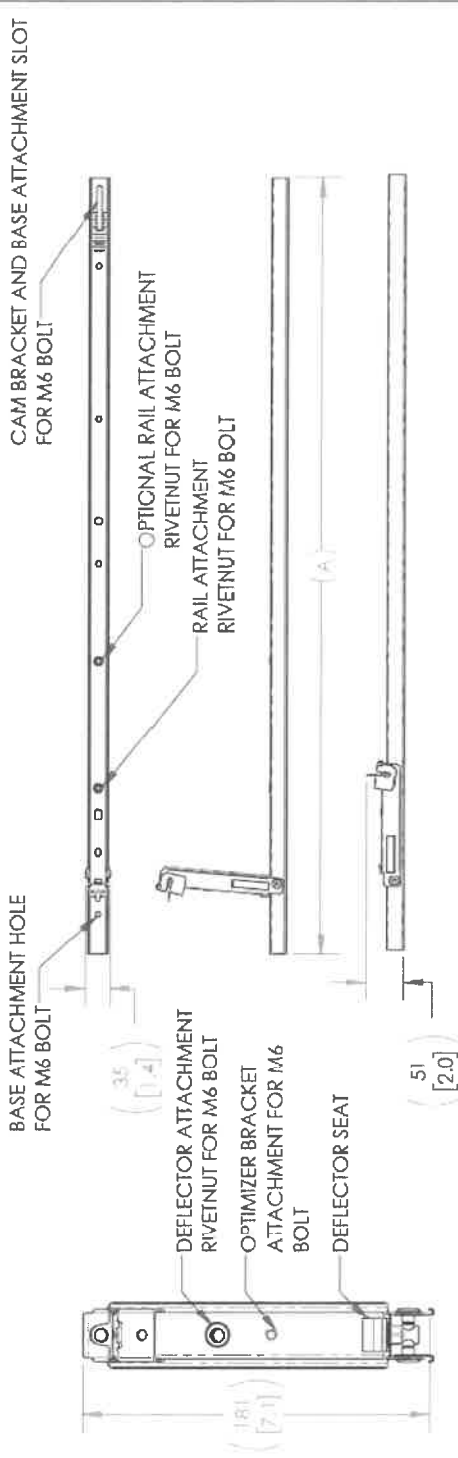

PART NUMBER	DIM "A" mm [inch]	WEIGHT kg/lb	MODULE WIDTH mm
C-500052301	1100.0[43.31]	0.59[1.30]	990 - 1090
C-500052302	1140.0[44.88]	0.61[1.34]	1031 - 1070
C-500052303	1180.0[46.46]	0.62[1.38]	1071 - 1110
C-500052304	1220.0[48.03]	0.64[1.41]	1111 - 1150
C-500052308	1380.0[54.33]	0.71[1.56]	1270 - 1310

**PANELCLAW**<sup>®</sup>
  
**MODULE CONNECTOR, 5 DEGREE, CFR**

PROPRIETARY AND CONFIDENTIAL THE INFORMATION CONTAINED IN THIS DRAWING IS THE SOLE PROPERTY OF PANELCLAW AND IS NOT TO BE REPRODUCED OR TRANSMITTED IN ANY FORM OR BY ANY MEANS, IN PAST OR AS A WHOLE WITHOUT THE WRITTEN PERMISSION OF PANELCLAW IS PROHIBITED.		Panelclaw, Inc. 1800 Oyster Point Dr., Ste. 2023, North Andover, MA 01845 Phone: 978.688.4800 Fax: 978.688.8100 <a href="http://www.panelclaw.com">www.panelclaw.com</a>
MATERIAL STEEL W/ ZAM COATING		REV <b>C</b>
SIZE <b>A</b>	DWG. NO. <b>C5000523XX</b>	WT. SEE TABLE kg/lb SHEET 1 OF 1
DIMENSIONS ARE IN mm [INCHES]		





# Component Cut Sheet

## Dual Tilt "Base"

REVISION		DESCRIPTION	DATE	APPROVED
REV.	ECO#	INITIAL RELEASE	21-JAN-19	JA
A	C00548			

3X RIVETNUTS FOR M6 BOLT

PANELCLAW LOGO

UL 2703 TEST LAB LOGO

UL 2703 SYSTEM RATING

MA CONNECTOR HOLES FOR M6 BOLT

98 (3.9)

353 (13.9)

OPTIONAL SLOT FOR ROOF PROTECTION PAD

ROOF PROTECTION PAD

4X SHIM PAD ATTACHMENT HOLE

VENDOR CODE, DATE CODE, PART NUMBER AND REVISION CODE

ORIENTATION MARKER

55 (2.2)

60 (2.4)

CLAWFR DUAL TILT BASE 27MM [1.07]

C-500050201  
BASE, 01, CFR

  

		<b>PANELCLAW</b> <small>PanelClaw, Inc.          1600 Osgood St., Suite 20723          North Andover, MA 01845          Phone: 978.689.1000          Fax: 978.689.5100          www.panelclaw.com</small>	<b>PART NUMBER</b> 500050201	<b>WEIGHT</b> kg/lb 0.37/0.81
<b>PROPRIETARY AND CONFIDENTIAL</b> THE INFORMATION CONTAINED IN THIS DRAWING IS THE SOLE PROPERTY OF PANELCLAW. ANY REPRODUCTION IN PART OR AS A WHOLE WITHOUT THE PERMISSION OF PANELCLAW IS PROHIBITED.		<b>BASE, 01, CFR</b>		
<b>MATERIAL</b> STEEL W/ZAM COATING; TPV (thermoplastic Vulcanizate)		<b>SIZE</b> A	<b>DWG. NO.</b> C-500050201	<b>REV</b> A
<b>DIMENSIONS ARE IN: mm (INCHES)</b>		<b>SCALE: NONE</b>	<b>WT SEE TABLE</b>	<b>SHEET 1 OF 3</b>



# Component Cut Sheet

5 Degree (all spacing options) and 10 Degree 11.4" row gap spacing option "Base"

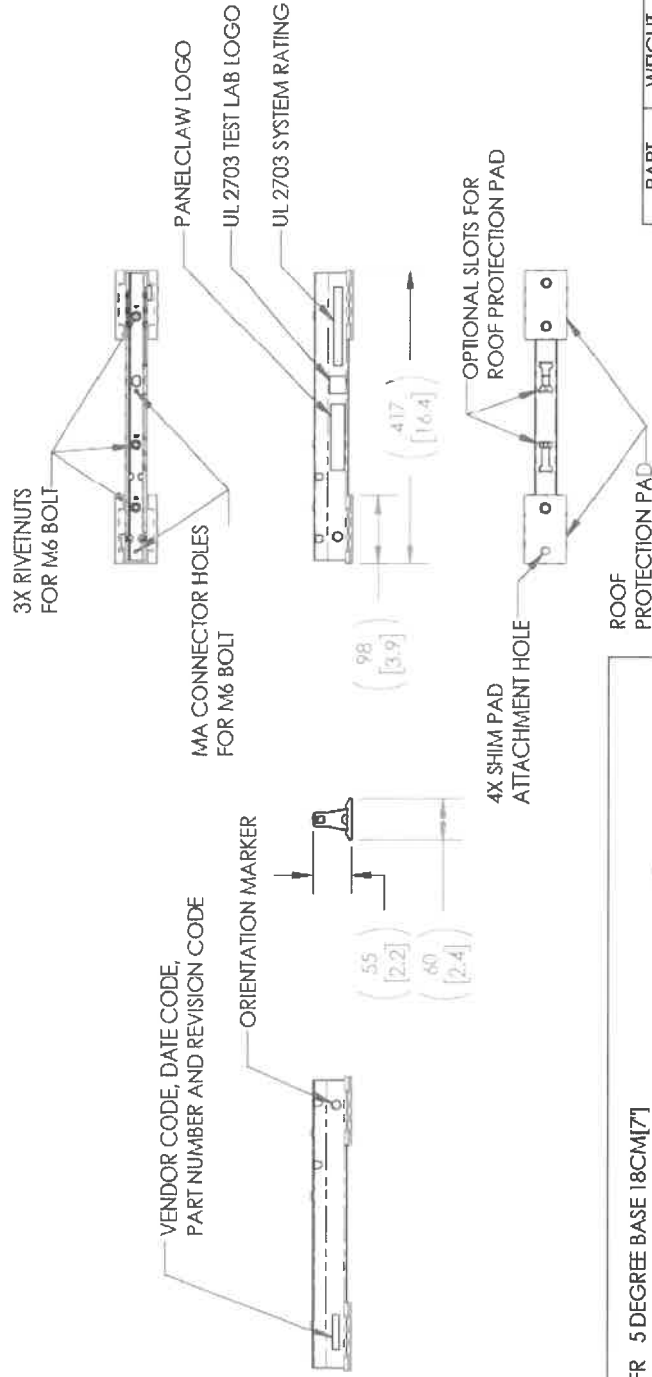

CLAWFR 5 DEGREE BASE 18CM[7"]  
 CLAWFR 5 DEGREE BASE 28CM[11"]  
 CLAWFR 10 DEGREE BASE 29CM[11"]

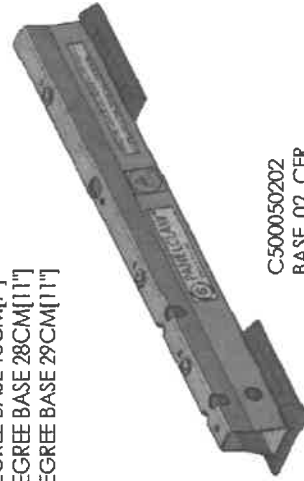

C500050202  
 BASE, 02, CFR

PART NUMBER	500050202	WEIGHT kg/lb	0.42/0.93
-------------	-----------	--------------	-----------

**PANELCLAW**  
 PanelClaw, Inc.  
 1000 Oswood St., Suite 202Z,  
 North Andover, MA 01845  
 Phone: 978.889.5100  
 Fax: 978.889.5100  
 www.panelclaw.com

**PROPRIETARY AND CONFIDENTIAL**  
 THE INFORMATION CONTAINED IN THIS DRAWING IS THE SOLE PROPERTY OF PANELCLAW. ANY REPRODUCTION IN PART OR AS A WHOLE WITHOUT THE WRITTEN PERMISSION OF PANELCLAW IS PROHIBITED.

**MATERIAL**  
 STEEL W/IAM COATING;  
 IPV (thermoplastic  
 Vulcanizate)

<b>BASE, 02, CFR</b>	
SIZE	DWG. NO.
<b>A</b>	<b>C500050202</b>
SCALE: NONE	REV
WT. SEE TABLE	<b>A</b>

DIMENSIONS ARE IN mm (INCHES)  
 SHEET 2 OF 3



# Component Cut Sheet

10 Degree (13.9 and 17.4 row gap spacing options)  
"Base"

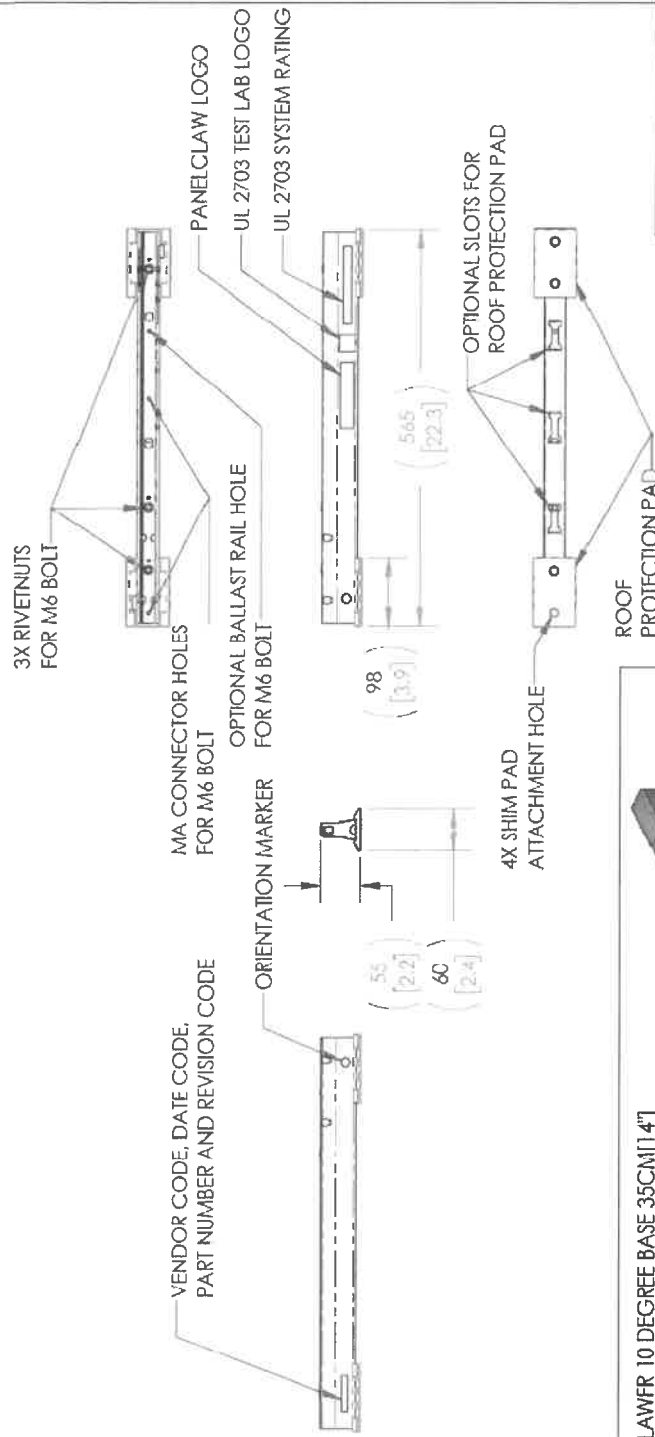

CLAWFR 10 DEGREE BASE 35CM [1'4"]  
CLAWFR 10 DEGREE BASE 44CM [1'7"]

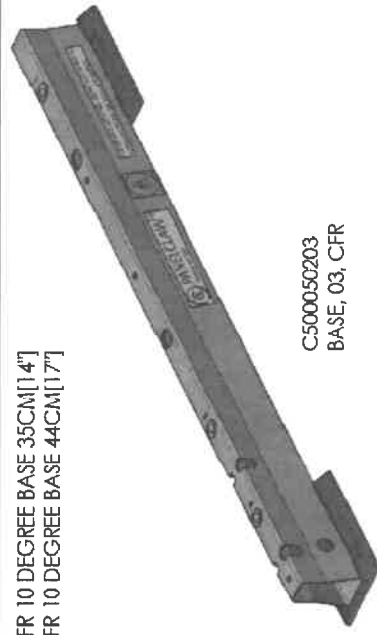

C500050203  
BASE, 03, CFR

PART NUMBER	500050203	WEIGHT kg/lb	0.55/1.21
-------------	-----------	--------------	-----------

**PANELCLAW**  
PanelClaw, Inc.  
1000 Oswood St., Suite 2022,  
North Andover, MA 01845  
Tel: 978.688.5100  
Fax: 978.688.5100  
www.panelclaw.com

PROPRIETARY AND CONFIDENTIAL  
THE INFORMATION CONTAINED IN THIS DRAWING IS THE SOLE PROPERTY OF PANELCLAW. ANY REPRODUCTION IN PART OR AS A WHOLE WITHOUT THE WRITTEN PERMISSION OF PANELCLAW IS PROHIBITED.

MATERIAL		STEEL W/ZAM COATING; IPV (thermoplastic vulcanizate)	
SCALE	NONE	WT	SEE TABLE kg/m <sup>2</sup>
SIZE	A	DWG. NO.	C500050203
BASE, 03, CFR		REV	A
DIMENSIONS ARE IN mm (INCHES)		SHEET 3 OF 3	



# Component Cut Sheet

## 10 Degree and Dual Tilt "Cam"

REVISION		DESCRIPTION	DATE	APPROVED
REV.	ECO#	INITIAL RELEASE		
A	C00548		21-JAN-19	JA

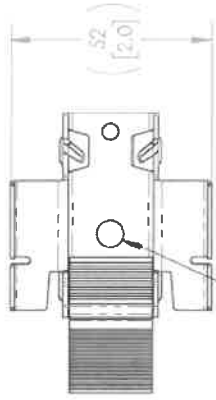

MODULE CONNECTOR AND BASE ATTACHMENT HOLE FOR M6 BOLT

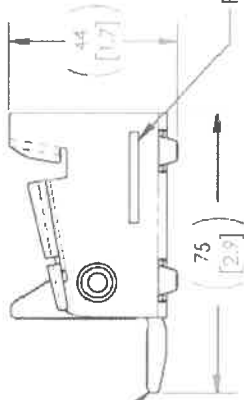

MODULE SEAT

PART NUMBER AND REVISION CODE



PROPRIETARY AND CONFIDENTIAL  
THE INFORMATION CONTAINED IN THIS DRAWING IS THE SOLE PROPERTY OF PANELCLAW. ANY REPRODUCTION IN PART OR AS A WHOLE WITHOUT THE WRITTEN PERMISSION OF PANELCLAW IS PROHIBITED.



**PANELCLAW**

Panelclaw, Inc.  
1000 Oswood St., Suite 2023,  
North Andover, MA 01845  
Phone: 978.688.1100  
Fax: 978.688.1100  
www.panelclaw.com

**CAM, 10 DEGREE, CFR**

MATERIAL  
STEEL W/IZAM COATING;  
ALUMINUM

SIZE	DWG. NO.	REV
A	C5000500	A

DIMENSIONS ARE IN: mm (INCHES)

SCALE: NONE W: 0.06/0.17 Hg/p

SHEET 1 OF 1





# Component Cut Sheet

## 5 Degree "Cam"

REVISION		DESCRIPTION	DATE	APPROVED
REV. A	ECO# C00583	INITIAL RELEASE	02-JUL-19	JA

MODULE CONNECTOR AND BASE ATTACHMENT HOLE  
FOR M6 BOLT

MODULE SEAT

PART NUMBER AND REVISION CODE

**PANELCLAW**

**CAM, 5 DEGREE, CFR**

1600 Osgood St., Suite 2023,  
North Andover, MA 01845  
Tel: 978.683.1000  
Fax: 978.683.1006  
www.panelclaw.com

---

**PROPRIETARY AND CONFIDENTIAL**  
THE INFORMATION CONTAINED IN THIS DRAWING IS THE SOLE PROPERTY OF PANELCLAW. ANY REPRODUCTION IN PART OR AS A WHOLE WITHOUT THE WRITTEN PERMISSION OF PANELCLAW IS PROHIBITED.

**MATERIAL**  
STEEL WIZAM COATING;  
ALUMINUM

SCALE: NONE    WT: 0.1170.24 kg/rb    SHEET 1 OF 1



# Component Cut Sheet

“Claw”

REVISION		DESCRIPTION	DATE	APPROVED
REV.	ECO #	INITIAL RELEASE		
A	C00548		21-JAN-19	JA

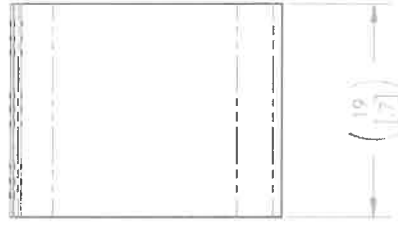
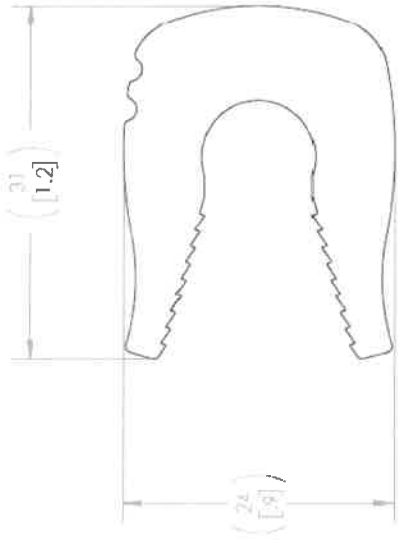

PROPERTY AND CONFIDENTIAL  
 THE INFORMATION CONTAINED IN THIS  
 DRAWING IS THE SOLE PROPERTY OF  
 PANELCLAW. ANY REPRODUCTION  
 OR USE OF THIS DRAWING AS A WHOLE WITHOUT THE  
 WRITTEN PERMISSION OF PANELCLAW  
 IS PROHIBITED.



PanelClaw, Inc.  
 1000 Oymod St., Suite 2022,  
 North Andover, MA 01845  
 Phone: 978.686.1100  
 Fax: 978.688.5100  
 www.panelclaw.com

## PANELCLAW

MATERIAL  
ALUMINIUM

CAM CLAW, CFR

SIZE DWG. NO.

A C2000673

REV

A

DIMENSIONS ARE IN mm (INCHES)

SCALE: NONE

WF 0.02/0.05 kg/yr

SHEET 1 OF 1



# Component Cut Sheet

## “Claw, CS”

For use with modules that have smaller flanges.

REVISION		DESCRIPTION	DATE	APPROVED
REV.	ECO#	INITIAL RELEASE	14-SEP-20	JA
A	C00629			

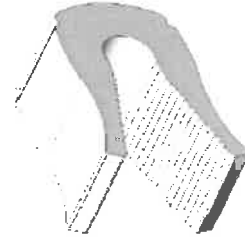
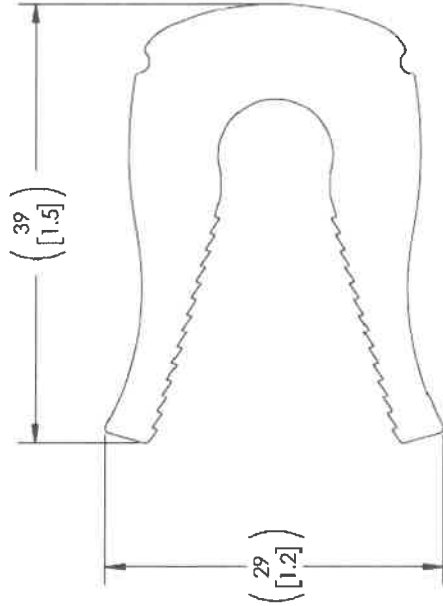

PROPRIETARY AND CONFIDENTIAL  
 THE INFORMATION CONTAINED IN THIS DRAWING IS THE SOLE PROPERTY OF PANELCLAW. ANY REPRODUCTION IN PART OR AS A WHOLE WITHOUT THE WRITTEN PERMISSION OF PANELCLAW IS PROHIBITED.



# PANELCLAW®

Panelclaw, Inc. 2020  
 1800 Wood St. Suite 100  
 North Andover, MA 01845  
 Phone: 978.688.4900  
 Fax: 978.688.1100  
 www.panelclaw.com

## CAM CLAW, CS, CFR

MATERIAL  
ALUMINUM

SIZE	DWG. NO.	REV
A	C2000815	A

SCALE: NONE	WT 0.03/0.06 kg/lb	SHEET 1 OF 1
-------------	--------------------	--------------



# Component Cut Sheet

## "M6X16 Bolt"

REVISION		DESCRIPTION	DATE	APPROVED
REV.	ECO#	INITIAL RELEASED	14-SEP-20	JA
A	C00629			

$(\phi 14)$   
[6]

10  
[4]

23  
[9]

M6-1.0 THREAD

<p><b>PROPRIETARY AND CONFIDENTIAL</b> THE INFORMATION CONTAINED IN THIS DRAWING IS THE SOLE PROPERTY OF PANELCLAW. ANY REPRODUCTION IN PART OR AS A WHOLE WITHOUT THE WRITTEN PERMISSION OF PANELCLAW IS PROHIBITED.</p> <p>MATERIAL STEEL</p>	<p style="text-align: center;"> <b>PANELCLAW®</b> BLT, HEX FLG, TRI, M6X16, ST, PATCH</p> <p>Panelclaw, Inc. 1800 Longwood St. Mableton, GA 30148 Phone: 770.683.4900 Fax: 770.683.1100 www.panelclaw.com</p>
<p>SIZE DWG. NO. REV</p> <p><b>A C2000697 A</b></p>	
<p>DIMENSIONS ARE IN mm (INCHES) SCALE NONE WT. 0.007/015 kg/lb</p>	
<p>SHEET 1 OF 1</p>	



# Component Cut Sheet

## 10 Degree "Deflector"

### REVISION

REV.	ECO#	DESCRIPTION	DATE	APPROVED
A	C00604	INITIAL RELEASE	07-FEB-20	JA
B	C00629	UPDATED ISO VIEWS	14-SEP-20	JA
C	C00635	ADDED -05, -06, -07	19-APR-21	JA

VENDOR CODE, DATE CODE, PART NUMBER, AND REVISION CODE

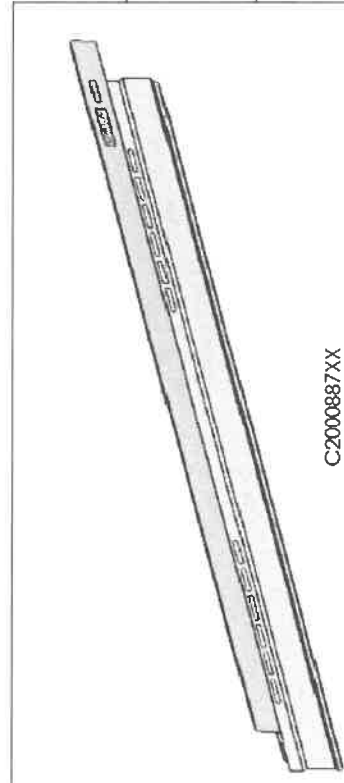
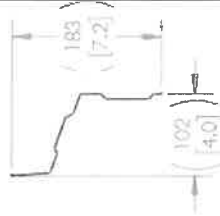
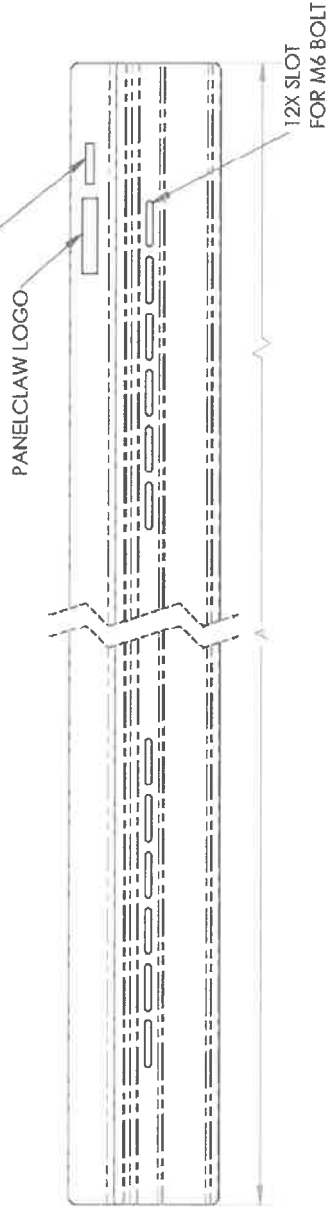

PART NUMBER	DIM "A" mm [in]	WEIGHT kg/lb
C200088701	1732 [68.2]	1.38 [3.03]
C200088702	2056 [81.0]	1.64 [3.61]
C200088703	2132 [83.9]	1.70 [3.74]
C200088704	2232 [87.9]	1.78 [3.92]
C200088705	2332 [91.8]	1.84 [4.10]
C200088706	2432 [95.8]	1.94 [4.28]
C200088707	2532 [99.7]	2.02 [4.46]

**PROPRIETARY AND CONFIDENTIAL**  
 THE INFORMATION CONTAINED IN THIS DRAWING IS THE SOLE PROPERTY OF PANELCLAW. ANY REPRODUCTION, STORAGE, OR TRANSMISSION OF THIS INFORMATION WITHOUT THE WRITTEN PERMISSION OF PANELCLAW IS PROHIBITED.



**PANELCLAW**

PanelClaw, Inc.  
 100 Osgood St., Suite 2022,  
 New Milford, CT 06458  
 Phone: 978.688.1000  
 Fax: 978.688.5100  
 www.panelclaw.com

**DEFLECTOR, 10D, CFR**

**MATERIAL**  
 STEEL W/ ZAM COATING

SIZE	DWG. NO.	REV
A	C2000887XX	C

SCALE	NOTE	WT	SEE TABLE	REQ'D	SHEET	1 OF 1



# Component Cut Sheet

## 5 Degree "Deflector"

REVISION	
REV.	ECO#
A	C00604
B	C00635

DESCRIPTION	DATE	APPROVED
INITIAL RELEASE	07-FEB-20	JA
ADDED -05, -06, -07	19-APR-21	JA

VENDOR CODE, DATE CODE, PART NUMBER, AND REVISION CODE

PANELCLAW LOGO

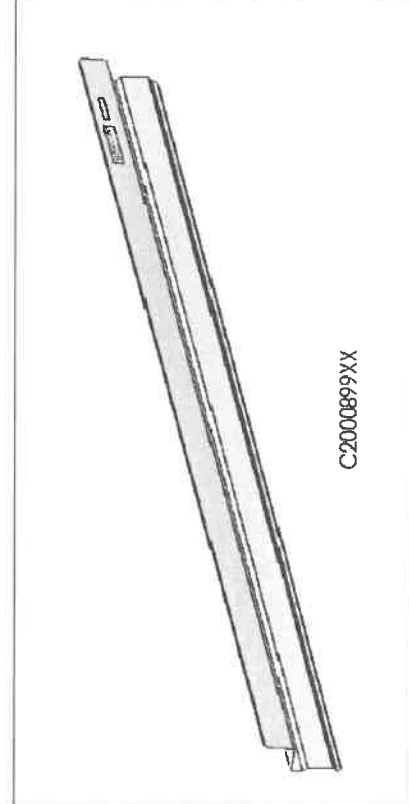
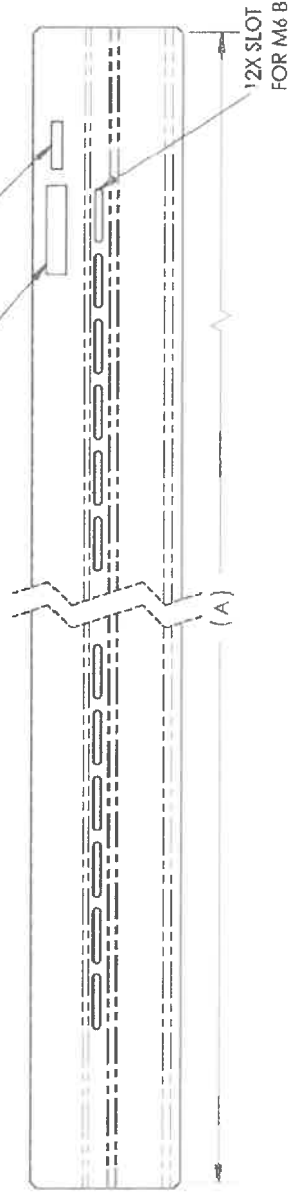

C2000899XX

PART NUMBER	DIM "A" mm [inch]	WEIGHT kg/lb
C200089901	1732 68.2	1.11 2.44
C200089902	2056 81.0	1.34 2.96
C200089903	2132 83.9	1.37 3.02
C200089904	2232 87.9	1.43 3.16
C200089905	2332 91.8	1.50 3.31
C200089906	2432 95.7	1.57 3.45
C200089907	2532 99.7	1.63 3.60

**PANELCLAW**  
 DEFLECTOR, 5D, CFR

**PROPRIETARY AND CONFIDENTIAL**  
 THE INFORMATION CONTAINED IN THIS DRAWING IS THE SOLE PROPERTY OF PANELCLAW. ANY REPRODUCTION IN PART OR AS A WHOLE WITHOUT THE WRITTEN PERMISSION OF PANELCLAW IS PROHIBITED.

**MATERIAL**  
 STEEL W/ ZAM COATING

PanelClaw, Inc.  
 1900 Oldgood St., Suite 2023,  
 North Andover, MA 01845  
 Phone: 978.888.8100  
 Fax: 978.888.8100  
 www.panelclaw.com

SCALE: NONE	WT SEE TABLE kg/lb	SHEET 1 OF 1
SIZE A	DWG. NO. C2000899XX	REV B



# Component Cut Sheet

## Universal "Roof Protection Pad"

REVISION		DESCRIPTION	DATE	APPROVED
REV.	ECO#	INITIAL RELEASE		
A	C00548		21-JAN-19	JA

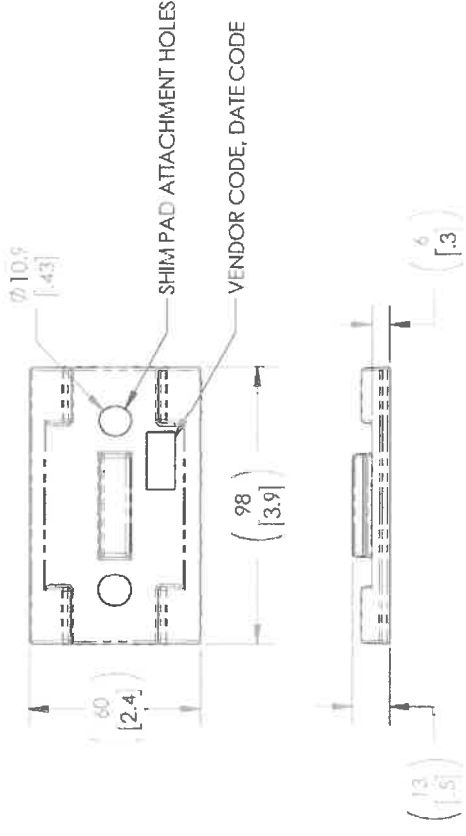

PROPRIETARY AND CONFIDENTIAL  
THE INFORMATION CONTAINED IN THIS DRAWING IS THE SOLE PROPERTY OF PANELCLAW. ANY REPRODUCTION OR TRANSMISSION OF THIS INFORMATION WITHOUT PERMISSION OF PANELCLAW IS PROHIBITED.

MATERIAL  
TPV (Thermoplastic Vulcanizate)

DIMENSIONS ARE IN mm (INCHES)



PanelClaw, Inc.  
1800 Osgood St., Suite 2023,  
Newport News, VA 23605  
Phone: 757.408.1000  
Fax: 757.633.5100  
www.panelclaw.com

### PANELCLAW

#### ROOF PROTECTION PAD, BASE, CFR

SIZE	DWG. NO.	REV
A	C2000678	A

SCALE: NONE	WT	0.04/0.08	13/15	SHEET 1 OF 1
-------------	----	-----------	-------	--------------



# Component Cut Sheet

## Universal "Rail"

REVISION		DESCRIPTION	DATE	APPROVED
REV. A	ECO# C00548	INITIAL RELEASE	21-JAN-19	JA
REV. B	ECO# C00575	UPDATED PART NAME	15-JUL-19	JA

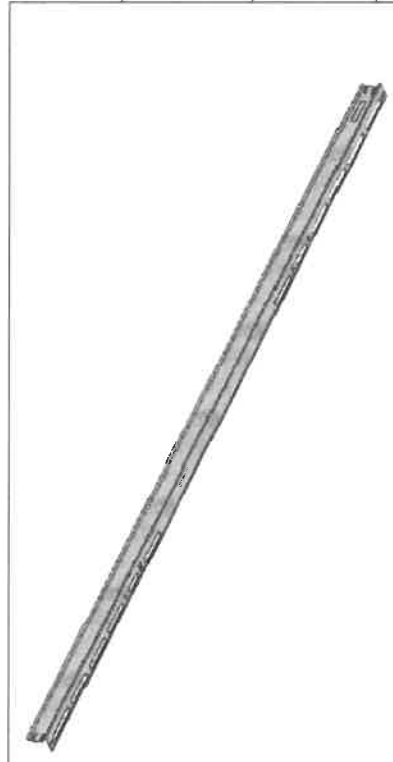
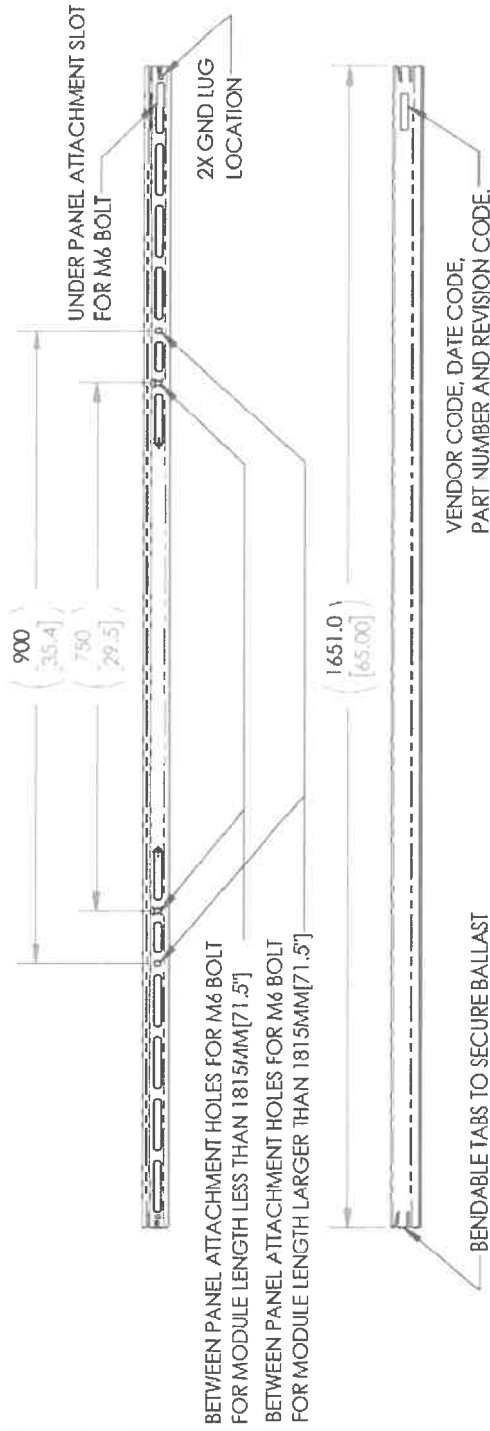

**PROPRIETARY AND CONFIDENTIAL**  
 THE INFORMATION CONTAINED IN THIS DRAWING IS THE SOLE PROPERTY OF PANELCLAW. ANY REPRODUCTION IN PART OR AS A WHOLE WITHOUT THE WRITTEN PERMISSION OF PANELCLAW IS PROHIBITED.

**MATERIAL**  
 STEEL W/JAM COATING

**DIMENSIONS ARE IN mm (INCHES)**

**PANELCLAW**

PanelClaw, Inc.  
 1800 Osgood St., Suite 2023,  
 North Andover, MA 01845  
 Phone: 978.885.1100  
 Fax: 978.885.1100  
 www.panelclaw.com

<b>RAIL, CFR</b>	
SIZE	DWG. NO.
<b>A</b>	<b>C2000695</b>
SCALE NONE	WT 0.797/1.75 kg/ft
SHEET 1 OF 1	





# Component Cut Sheet

## Universal "MA Strut"

REVISION		DESCRIPTION	DATE	APPROVED
REV.	ECO#	INITIAL RELEASE	10-MAY-21	JA
A	C00650			

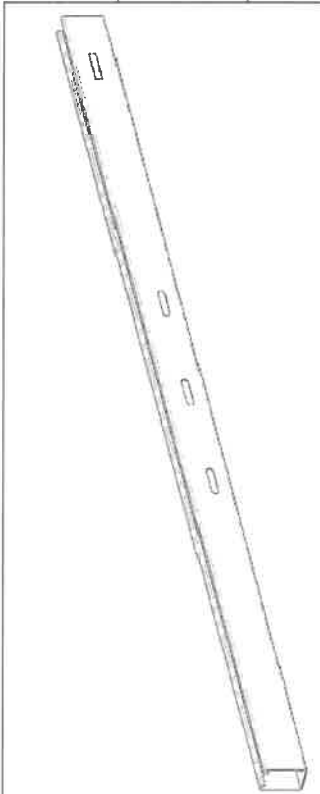
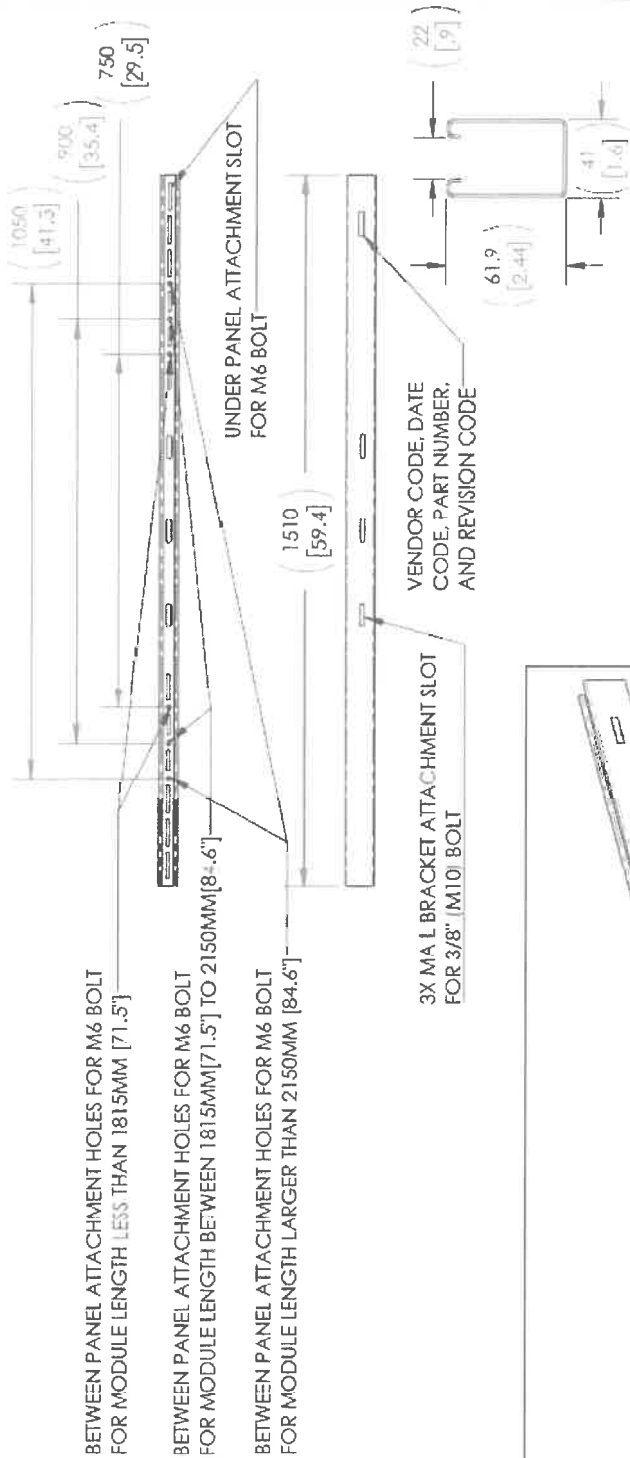

<b>PROPRIETARY AND CONFIDENTIAL</b> THE INFORMATION CONTAINED IN THIS DRAWING IS THE SOLE PROPERTY OF PANELCLAW. IT IS TO BE USED ONLY FOR THE PROJECT AND SITE SPECIFICALLY IDENTIFIED HEREIN. REPRODUCTION OR TRANSMISSION OF THIS DRAWING IN ANY MANNER WITHOUT THE WRITTEN PERMISSION OF PANELCLAW IS PROHIBITED.	 <b>PANELCLAW</b> 1800 Osgood St., Suite 202, Houston, TX 77058 Phone: 972.388.4800 Fax: 978.688.5100 www.panelclaw.com	
	<b>MA STRUT, 2500, CFR</b>	
<b>MATERIAL</b> STEEL W/ ZAM COATING	<b>SIZE</b> <b>A</b>	<b>DWG. NO.</b> <b>C2000930</b>
<b>SCALE:</b> NONE	<b>WT</b> 3.21/7.07 kg/lb	<b>REV</b> <b>A</b>
<b>DIMENSIONS ARE IN mm (INCHES)</b>		<b>SHEET 1 OF 1</b>



**For Questions or Feedback Contact [sales@panelclaw.com](mailto:sales@panelclaw.com)**

---



**YOTTA**  
ENERGY

# Value Beyond Power Conversion

DPI-208 & DPI-480

Yotta's Dual Power Inverter (DPI) is designed for three-phase grid connection (208V or 480V) and has dual applications: solar only or solar + energy storage. This unique feature delivers maximum flexibility and brings all the benefits of a microinverter at a price equivalent to string inverters. Rated at 1.8kW @ 480V and 1.728kW @ 208V, this four-port, three-phase microinverter can be used with up to four, high-capacity PV modules and is compatible with Yotta's SolarLEAF energy storage technology and high performance bi-facial solar modules.

A proven reliable solution in a competitive landscape, Yotta's DPI 208/480 is a four-port, three-phase, microinverter that competes head-to-head with string inverters paired with rapid shut-down devices (RSD) or optimizers. In addition to its low-cost and superior performance, there are several key differentiators that make it stand out in the US market and be a leading inverter technology for commercial and industrial solar applications.

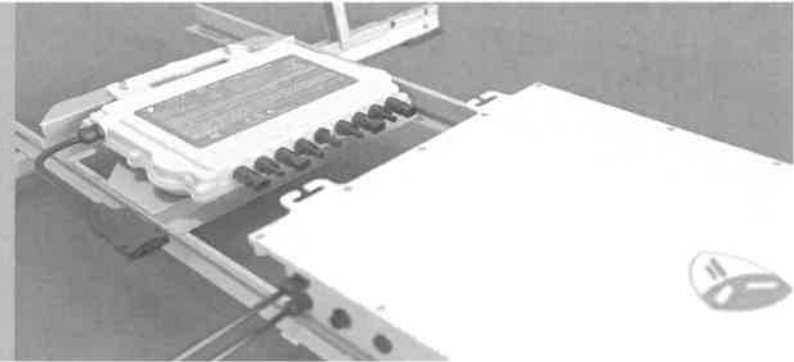

## Superior Safety

Yotta's commitment to built-in safety is highlighted in the DPI's best-in-class design.

- In contrast with string inverters which operate at dangerously high DC voltages on customers' roofs, Yotta's DPI inverters operate at a low DC voltage. Specifically, DC voltages will never exceed 60V, dramatically reducing arc fault risk and associated hazards.
- Compliant with Rule 21, the DPI has been well tested to ensure rapid shut-down whenever operating conditions stray from predictable thresholds.
- Ability to actively manage grid functions with UL 1741 SA (SB pending).
- The DPI 280/480 is grid interactive through its Reactive Power Control (RPC) feature to support grid power management.
- Fire departments, first-responders and anyone coming into contact with a PV system prefer microinverters' low fire risk potential.

## Streamlined System Design

Yotta's DPI is modeled in HelioScope for bankable energy yield simulator and financial calculator. With simplified design comes faster permit approvals, installation efficiency and resulting cost savings.

- Each DPI unit connects to up to 4x modules and up to 5x DPI units connect on an AC trunk at 208V (i.e. 20x modules per AC trunk). At 480V, this increases to 11x DPI units (i.e. 44x modules per AC trunk). Each trunk simply connects into a 30A 3P breaker at the AC panel.

- Maximizes the use of your rooftop area, enabling multi-faceted roof layouts vs. reduced system sizing.
- Eliminates additional DC cable runs.
- Replaces the need for separate power optimizers and module level rapid shutdown devices (RSD).
- Delivers three-phase 208V or 480V in small-to-large sized systems without a step-down transformer.
- Compatible with all leading 60-cell and 72-cell PV modules (up to 670W+) including Yottas YSM-450W and 540W bi-Facial panels.

## Simplified Deployment

While a streamlined system design path is prized in the office, time spent in the field on rooftops and job sites is frequently where project budgets fall apart. The DPI's design engineers kept this front-of-mind with the following value-adds.

- Electricians understand the language of AC electrical. Eliminating the need for specialized DC training and skills means more contractors will confidently quote and install a DPI AC-based system.
- DPI's four-port design enables installation up to 300% faster than other module level panel electronics (MLPE) and reducing the number of devices on the roof by at least 50%.
- AC balance-of-system (BOS) parts are universally available, enabling a quick run to the neighborhood electrical shop vs. waiting on shipping from a far-away solar distributor. Fewer installation errors associated with rooftop cable crimping and other points of DC failure.
- Microinverters eliminate labor-intensive string-inverter racking and mounting costs.
- Design changes in the field are simple as opposed to complex DC string systems.
- At less than 13 pounds per unit, no heavy moving equipment is required as compared with heavy string inverter placement and installation.

## Maximized Performance

PV system performance equates faster payback times, which equates increased return on investment and ultimately customer satisfaction. In other words, system performance is where the rubber meets the road.

- With module-level maximum power point tracking (MPPT), each module's output is generated independently, and is unaffected by shading, module mismatch or output loss in a neighboring module.
- Microinverters add value by powering up earlier in the day and shutting down later in the day than string inverter optimizers, expanding the production curve.
- The more complex the roof's module layout, the stronger DPI's value proposition becomes based on yield per square foot.
- Yotta's 25-year extended warranty more than doubles the typical string inverter warranty (10 years).



SAFETY  
PROTECTION  
RELAY



ADJUSTABLE  
POWER  
FACTOR



RAPID  
SHUTDOWN  
COMPLIANT



PLUG  
& PLAY  
&  
STORAGE  
READY



ADVANCED  
HEAT  
DISSIPATION  
TECHNOLOGY



REMOTE  
DIAGNOSIS

## Reliable & Easy to Maintain

The days of sending technicians to chase an elusive ground fault or error on a string system are a headache of the past. Enter the zero maintenance four-port microinverter with industry leading diagnostics.

- Module-level monitoring improves system reliability, long-term yield and makes troubleshooting a breeze.
- Microinverters eliminate the single point of failure risk inherent in string inverters. String inverter failures require immediate attention given that they have significant impact to system performance. Module-level failures are mere service calls with minimal production loss.
- Four-port design translates to as much as 50% fewer required units per system compared with other microinverter technologies.
- DPI's offers reliability superior to that of string inverters paired with optimizers or RSD devices.
- When required, a section of the array can be electrically isolated for maintenance, compared with string inverter systems. No heavy equipment to lift or replace.

## Future-Proof

Whether it's utilities ending Net Energy Metering (NEM), implementing Time-Of-Use (TOU) tariffs or markets opening up via demand response programs, the pairing of energy storage with solar will become the norm. Whether it makes economic sense today, or will tomorrow, Yotta DPI future-proofs your solar installation so that you can retrofit energy storage seamlessly at any point in the future.

- Optimized for integration with Yotta's SolarLEAF energy storage technology anywhere in the array. The DPI system is inherently storage-ready without requiring any additional complex electrical infrastructure. The SolarLEAF can be simply installed between the solar module and the DPI by disconnecting the MC4 connectors and then reconnecting them to the SolarLEAF. Simple!
- No modification to the AC system is required.

[www.yottaenergy.com](http://www.yottaenergy.com)

YOTTA ENERGY INC.  
2101 E. Saint Elmo Road, Suite 150  
Austin, TX 78744  
+1 (512) 856 7788



Yotta's **Dual Power Inverters (DPI-208 and DPI-480)** are native 3-phase microinverters that each support **four high capacity solar modules** and deliver outstanding **performance**. The internals are protected with silicone to **reduce stress** on the electronics, increase its **waterproof** properties, **dissipate heat**, and to provide **maximum system reliability**. Yotta's DPI-208 and DPI-480 are powerful **plug-and-play** MLPE inverters that install faster than any other solution in the market and comply with **rapid shutdown requirements**. Their design improves **thermal dissipation** while maximizing **power production**.

- DPI (Dual Power Inverter) designed to work with PV or Yotta's SolarLEAF energy storage technology
- Native 3-phase power output (208V or 480V)
- Low Voltage DC input (<60V)
- 4 Solar Module Input Channels, 2 MPPT's
- Continuous rated AC output power 1728VA @208V and 1800VA @480V
- Engineered for high-capacity PV modules
- Maximum input current 20A
- Integrated Safety Protection Relay
- Rapid Shutdown Compliant
- Adjustable Power Factor



208 OR  
480V  
OUTPUT VOLTAGE



ADJUSTABLE  
POWER  
FACTOR



### Yotta Vision Monitoring

- **Monitors and Analyzes** each solar module and microinverter
- Allows **Remote Access** to the solar array
- Displays **Performance Issues** and **Alerts** the user to events
- **Real Time Communication**
- **Graphs** system solar output over time to boost troubleshooting



# DPI-208 & DPI-480 3-Phase Microinverter Data Sheet

MODEL	DPI-208	DPI-480
<b>INPUT DATA (DC)</b>		
Peak Power Tracking Voltage	32V-45V	
Operating Voltage Range	26V-60V	
Maximum Input Voltage	60V	
Maximum Input Current	20A x 4	
Maximum Input Short Circuit Current	25A per input	
<b>OUTPUT DATA (AC)</b>		
Maximum Continuous Output Power	1728VA	1800VA
Nominal Output Voltage/Range <sup>(1)</sup>	208V/183V-229V	480V/422V-528V
Adjustable Output Voltage Range	166V-240V	385V-552V
Nominal Output Current	4.8Ax3	2.17Ax3
Maximum Output Fault Current (AC) and Duration	L-L:85.4Apk, 13.6ms of duration, 4.967Arms	L-L:35.1Apk, 13.9ms of duration, 2.199Arms
Grid Connections	208V 3-Phase (208Y/120V, 240 Delta, 240 Delta High Leg)	480V 3-Phase (480Y/277V, 480 Delta)
Nominal Output Frequency/Range <sup>(1)</sup>	60Hz/59.3Hz-60.5Hz	
Adjustable Output Frequency Range	55Hz-65Hz	
Power Factor	0.99/0.8 leading...0.8 lagging	
Maximum Units per 30A branch <sup>(2)</sup>	5	11
AC Bus Cable	AWG 10	
<b>EFFICIENCY</b>		
Peak Efficiency	96.5%	
Nominal MPPT Efficiency	99.5%	
Night Power Consumption	40mW	
<b>MECHANICAL DATA</b>		
Operating Ambient Temperature Range <sup>(3)</sup>	-40°F to +149°F(-40°C to +65°C)	
Storage Temperature Range	-40°F to +185°F(-40°C to +85°C)	
Dimensions (W x H x D)	14" x 9.5" x 1.8" (359mm X 242mm X 46mm)	
Weight	13 lbs (6kg)	
DC Connector Type	Stäubli MC4 PV-ADBP4-S2&ADSP4-S2	
Cooling	Natural Convection - No Fans	
Enclosure Environmental Rating	Type 6	
<b>FEATURES</b>		
Communication (Inverter To ECU) <sup>(4)</sup>	Encrypted ZigBee	
Isolation Design	High Frequency Transformers, Galvanically Isolated	
Energy Management	Yotta EMA (Web and App)	
Warranty	10 Years Standard ; 25 Years Optional	
<b>CERTIFICATE &amp; COMPLIANCE</b>		
Safety, EMC & Grid Compliances	UL-1741; CA Rule 21 (UL 1741 SA and UL 1741 SB); CSA C22.2 No. 107.1-16; FCC Part 15; ANSI C63.4; ICES-003; IEEE1547; NEC2014 & NEC2017 Section 690.11 DC Arc-Fault circuit; Protection NEC2014 & NEC2017 & NEC2020 Section 690.12 Rapid Shutdown of PV systems on Building	



Meets the standard requirements for Distributed Energy Resources (UL-1741) and identified with the CSA Listed Mark

(1) Nominal voltage/frequency range can be extended beyond nominal if required by the utility.  
 (2) Limits may vary. Refer to local requirements to define the number of microinverters per branch in your area  
 (3) Inverter may enter low power mode in environments with poor ventilation or limited heat dissipation  
 (4) Recommend no more than 80 inverters register to one ECU for stable communication. \*

## PC Dual - A440 Top Roof(SW) Douglas Comm Center, 111 OLIVIA STREET, KEY WEST, FL,

### Report

Project Name: Douglas Comm Center  
 Project Address: 111 OLIVIA STREET, KEY WEST, FL,  
 Prepared By: Bob Williams  
 bobw@saltservice.net



### System Metrics

Design: PC Dual - A440 Top Roof(SW)  
 Module DC Nameplate: 28.2 kW  
 Inverter AC Nameplate: 30.0 kW  
 Load Ratio: 0.94  
 Annual Production: 48.91 MWh  
 Performance Ratio: 85.4%  
 kWh/kWp: 1,736.9  
 Weather Dataset: TMY, 10km Grid (24.55,-81.85), NREL (prospector)  
 Simulator Version: 34dd91d93f-2d85c5c137-1646ec5f5a-c726c14e3e

### Project Location



### Monthly Production

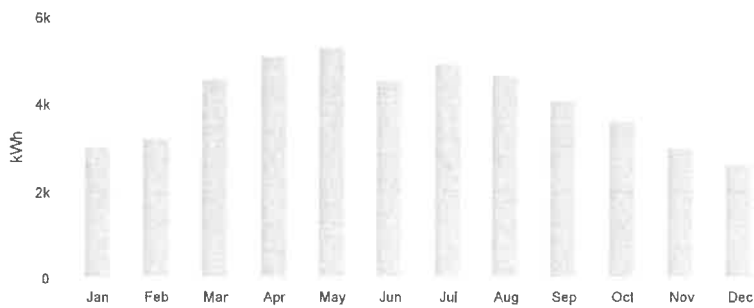

### Sources of System Loss

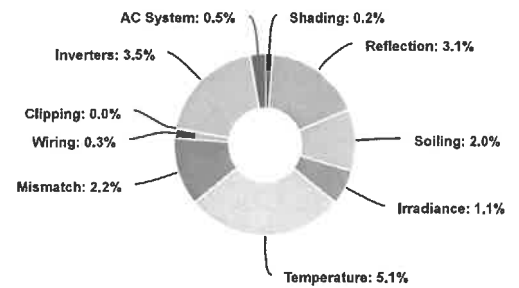

⚡ Annual Production			
	Description	Output	% Delta
Irradiance (kWh/m <sup>2</sup> )	Annual Global Horizontal Irradiance	2,047.1	
	POA Irradiance	2,034.4	-0.6%
	Shaded Irradiance	2,029.9	-0.2%
	Irradiance after Reflection	1,966.0	-3.1%
	Irradiance after Soiling	1,926.7	-2.0%
	<b>Total Collector Irradiance</b>	<b>1,926.7</b>	<b>0.0%</b>
Energy (kWh)	Nameplate	55,680.3	
	Output at Irradiance Levels	55,057.2	-1.1%
	Output at Cell Temperature Derate	52,239.4	-5.1%
	Output After Mismatch	51,099.7	-2.2%
	Optimal DC Output	50,938.9	-0.3%
	Constrained DC Output	50,938.9	0.0%
	Inverter Output	49,156.1	-3.5%
	<b>Energy to Grid</b>	<b>48,910.3</b>	<b>-0.5%</b>
Temperature Metrics			
	Avg. Operating Ambient Temp		25.5 °C
	Avg. Operating Cell Temp		35.1 °C
Simulation Metrics			
	Operating Hours	4660	
	Solved Hours	4660	

☁ Condition Set				
Description	Condition Set 2			
Weather Dataset	TMY, 10km Grid (24.55,-81.85), NREL (prospector)			
Solar Angle Location	Meteo Lat/Lng			
Transposition Model	Perez Model			
Temperature Model	Sandia Model			
	Rack Type	a	b	Temperature Delta
Temperature Model Parameters	Fixed Tilt	-3.56	-0.075	3°C
	Flush Mount	-2.81	-0.0455	0°C
	East-West	-3.56	-0.075	3°C
	Carport	-3.56	-0.075	3°C
Soiling (%)	J	F	M	A
	2	2	2	2
	M	A	M	J
	2	2	2	2
	J	J	A	S
	2	2	2	2
	O	N	D	
	2	2	2	2
Irradiation Variance	5%			
Cell Temperature Spread	4° C			
Module Binning Range	0% to 5%			
AC System Derate	0.50%			
Module Characterizations	Module	Uploaded By	Characterization	
	SPR-A440-COM (SunPower)	HelioScope	Sunpower_SPR_A440_COM_Preliminary.PAN, PAN	
Component Characterizations	Device	Uploaded By	Characterization	
	30K-3P-208V-N (Sol-Ark)	HelioScope	Spec Sheet	

📦 Components		
Component	Name	Count
Inverters	30K-3P-208V-N (Sol-Ark)	1 (30.0 kW)
Strings	10 AWG (Copper)	8 (550.0 ft)
Module	SunPower, SPR-A440-COM (440W)	64 (28.2 kW)

🔌 Wiring Zones						
Description	Combiner Poles	String Size	Stringing Strategy			
Wiring Zone	-	8-8	Along Racking			

🏠 Field Segments									
Description	Racking	Orientation	Tilt	Azimuth	Intrarow Spacing	Frame Size	Frames	Modules	Power
Field Segment 1	East-West	Landscape (Horizontal)	10°	236.2591°	0.2 ft	1x1	32	64	28.2 kW



Detailed Layout

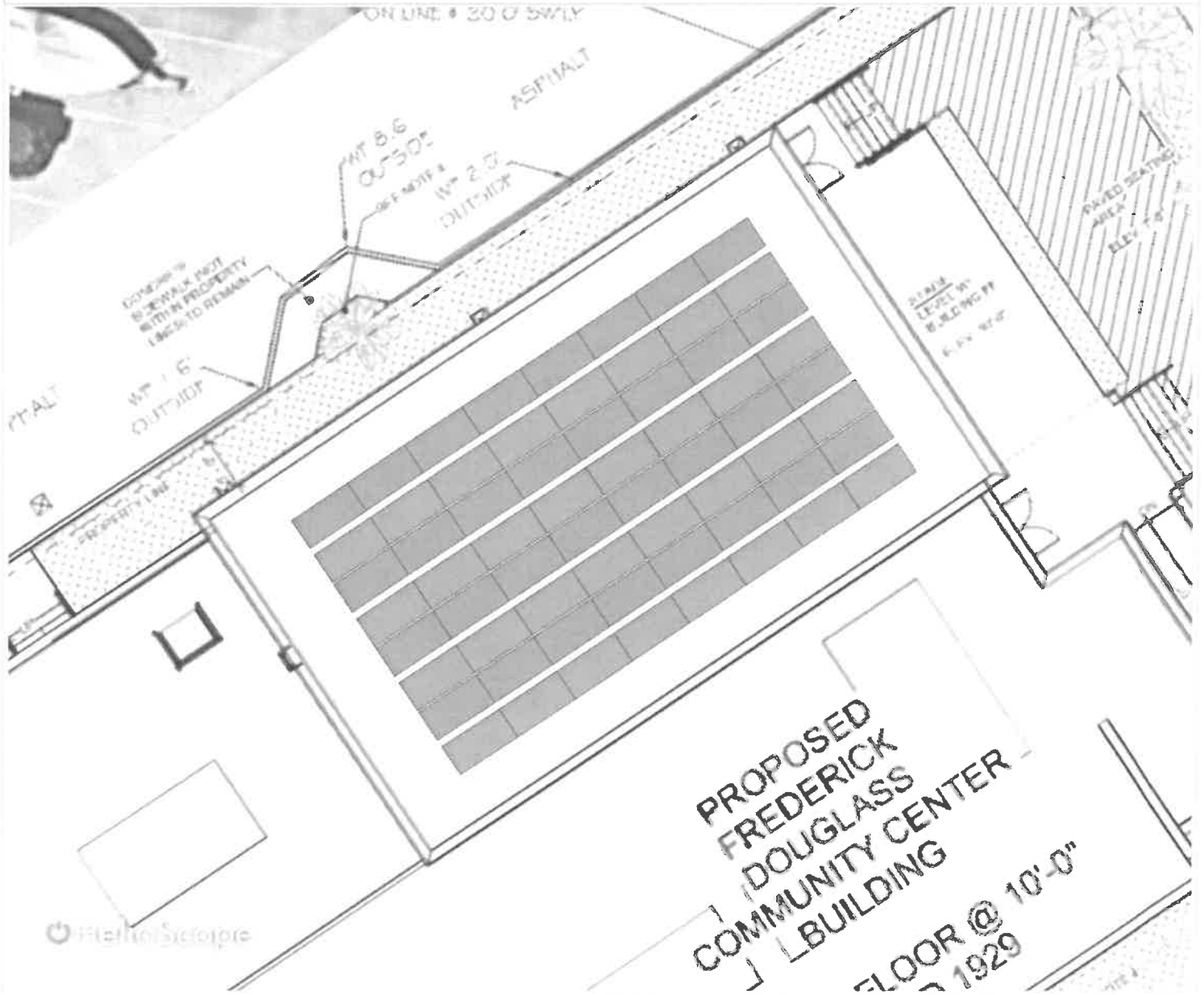

# Appendix 1



## System Operations and Maintenance Annual Service Plan Definition for: Frederick-Douglass Center

Salt Energy is happy to propose an Annual Service Plan for the Frederick-Douglass Center. SALT Energy offers 2 levels of service for your convenience.

O&M SERVICES		Remote Technical Support	Remote Monitoring and Detection	Monthly Reports	Remote Analysis & Warranty Diagnosis	Annual Preventive Maintenance Inspection	On-Site Services	Labor Discount	Travel Time Discount (off full labor rate)	Replacement Parts Discount (MSRP)	Annual Price for PV (28,160 W)
Level	Tier 1	X	X	X	Per Use	Per Use	Per Use	5%	40%	5%	\$ 1,975.00
	Tier 2	X	X	X	X	X	Per Use	10%	50%	10%	\$ 3,950.00

### **DEFINITIONS:**

#### ***Remote Technical Support***

Includes phone and email support for answering questions, providing standard product information, and performing initial diagnosis for issues that may come up in monitoring and reporting for covered systems. A recommendation for next steps will be provided which may include additional remote technical services and (or) a site visit. Such additional services would be billed at the specified discounted rates. Support for products and services not provided by SALT (unless specifically included on the contract) is not included and will be billed at the specified discounted rates also.

#### ***Remote Monitoring & Detection***

SALT will monitor\* the covered system for any warnings or alarms and will perform a remote check and if a problem is indicated, SALT will perform an initial diagnosis as part of technical support and notify the customer of the matter and recommended next steps.

#### ***Monthly Reports***

Each month, SALT will log into the system remotely and pull data and generate a summary report. Such reports shall include an overview of the system performance, component status and any relevant trends as provided by the installed equipment. Reports shall be emailed to the designated mailbox of the customer.

#### ***Remote Analysis & Diagnosis***

Once a problem or issue is detected, SALT will perform a deeper investigation of the situation to determine the root cause of the matter. This may include additional remote access to the system for the purposes of adjustment of settings, power off/on, resetting of equipment and extraction of additional data. SALT may work with the equipment manufacturer in a remote setting to further diagnose the issue. This may result in the requirement for a technical site visit to completely diagnose the issue before the manufacturer will allow a warranty claim.

#### ***Annual Preventive Maintenance Inspection***

SALT will provide an annual on-site visit by qualified technicians to inspect the PV system end to end. This includes inspection of all SALT provided equipment including Solar Modules, Inverters, PV Strings, Power Distribution Panels, Racking, Infrastructure, and electrical connections. A comprehensive written report will be provided within 2 weeks of the inspection. Such report will include all relevant findings, photos, tables and graphs where appropriate to document

the inspections performed. Recommendations for follow up work such as replacements or modifications will be included. Any additional services requested by the customer during the site visit that is not part of the inspection will be billed at the appropriate discounted labor rate. Any special equipment or services required for direct and safe access to supported systems for on-site work would be an additional cost. Additional inspections can optionally be provided within the same year if desired.

***On-Site Services***

Outside of the Annual Preventive Maintenance Inspection, SALT Energy can provide on site technical services for troubleshooting, warranty replacements, modifications, or additional preventive maintenance. Such services are considered ad-hoc and will be billed on a per use basis based at the discount level of the selected Tier of service. SALT requires direct and safe access to supported systems and equipment for on-site service. Any special equipment or services required for direct and safe access to supported systems for on-site work would be an additional cost, e.g. manlift, crane, material lifting equipment rentals.

***Discounts***

SALT provides Service Contract customers with discounted rates for labor, travel and replacement parts.

***Labor Rates***

Rates	Tier 1		Tier 2		
	Base Rate	Labor	Travel	Labor	Travel
Discount Amount	0%	5%	35%	10%	35%
Panel Washer / Labor	\$ 75.00	\$ 71.25	\$ 48.75	\$ 67.50	\$ 48.75
Service Technican	\$ 150.00	\$142.50	\$ 97.50	\$ 135.00	\$ 97.50
Service Engineer	\$ 200.00	\$190.00	\$ 130.00	\$ 180.00	\$ 130.00
PM/Supervisor	\$ 250.00	\$237.50	\$ 162.50	\$ 225.00	\$ 162.50

\* Internet connection and remote monitoring subscription required to be provided by customer