QUALIFICATIONS FOR ARCHITECTURAL SERVICES FOR CITY OF KEY WEST, RFQ #22-010

THE CITY OF KEY WEST FLORIDA



WILLIAM P. HORN ARCHITECT, P.A.

915 Eaton Street
Key West, FL 33040
(305) 296-8302
William Horn (contact)
william@wphornarchitect.com

In Association with

PEREZ ENGINEERING & DEVELOPMENT, INC., Civil Engineer
KEISTER WEBB STRUCTURAL ENGINEERS LLC, Structural Engineer
INNOVATIVE ENGINEERING GROUP, INC., MEP Engineer
LANDWISE DESIGN, INC., Landscape architect
TREPANIER & ASSOCIATES, INC., Land Use Planning Development Consultants
TRIFECTA CONSTRUCTION SOLUTIONS, Sustainability Consultant

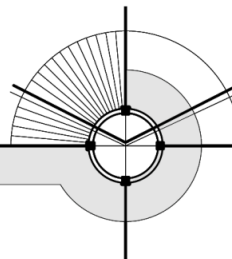
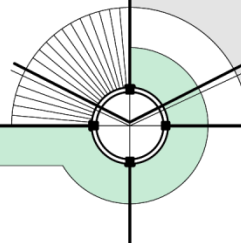

TABLE OF CONTENTS

1. COVER LETTER
2. INFORMATION PAGE
3. ORGANIZATION CHART
4. COMPANY INFORMATION
5. METHODOLOGY AND APPROACH
6. PERSONNEL
7. QUALIFICATIONS
 - TEAM EXPERIENCE AND HISTORY
 - GOVERNMENTAL PROJECT EXPERIENCE SUMMARY
 - OTHER PROJECT EXPERIENCE SUMMARY
 - CITY OF KEY WEST DEVELOPMENT REVIEW PROCESS EXPERIENCE
 - AWARDS AND RECOGNITION
 - LEED CREDENTIALS OF TEAM
8. REPRESENTATIVE ARCHITECTURAL EXPERIENCE AND CLIENT REFERENCE
 - PROJECT SPECIFIC EXPERIENCE
 - REFERENCES
9. SWORN STATEMENTS AND AFFIDAVITS
 - SWORN STATEMENTS AND AFFIDAVITS
 - LICENSES
 - INSURANCE



1. COVER LETTER

WILLIAM P. HORN ARCHITECT, PA.

915 EATON ST., KEY WEST, FL. 33040 TEL. 305-296-8302

WPHORNARCHITECT.COM

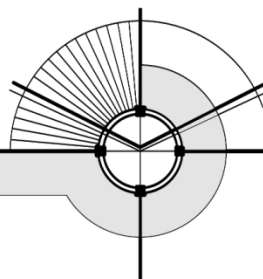

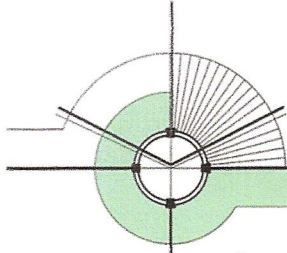

August 09, 2022

**City Clerk, City of Key West
1300 White Street
Key West, Florida 33040**

Re: Request for Qualifications for Architectural Services.

William P. Horn Architect, P.A., is pleased to respond to your request for qualifications for Architectural Services for City of Key West.

William P. Horn Architect, P.A. is a Key West based architectural firm that has been in business in the Florida Keys and Key West since October 1993. Our firm is located at 915 Eaton Street, Key West, Florida. Our team of architects, planners and engineers have worked together on numerous projects within Key West and the Florida Keys over the last twenty nine years. We have vast experience in working on governmental projects, commercial projects, residential projects, mixed use projects and historic preservation/restoration projects. We have worked on as many new building projects as we have on renovation/restoration projects.

William P. Horn Architect, P.A., presently has an annual contract with Monroe County, the Monroe County School District, the Key West Housing Authority, the City of Marathon and the City of Key West. We have specialized over the last twenty nine years in working with local Government agencies and enjoy working on the various size and types of projects that an annual contract provides. We hope that we can work with you on your projects.

Under our present annual contracts, we are currently working with the City of Key West on the Historic Seaport Common Area Enhancement Plan, building hardening projects (3 sites) and a new 10,000 SF homeless shelter (KOTS) on Stock Island. For Monroe County we just completed the temporary relocation of Public Works on Rockland Key and have just started a two story addition to the jail on Stock Island for new generators and storage. We are under construction for a 103 unit workforce housing project on Stock Island and designing five new affordable houses in Bahama Village for the Housing Authority. For the School Board we are just starting construction at Coral Shores for a small renovation to classrooms and restrooms, new stairways and ramps and first floor classroom renovations for the Big Pine Academy, a new softball field for the Key Largo School, spalling repairs to an office building on Trumbo Point and stair ceiling repairs at HOB school.

William P. Horn Architect, P.A., is a financially stable Key West based architectural firm that has not had any previous or pending litigation issues. Our team's present workload is such that we can make a full and immediate commitment to your new projects.

Your review of this proposal is appreciated and we look forward to the possibility of working on your future projects.

William P. Horn Architect, P.A.

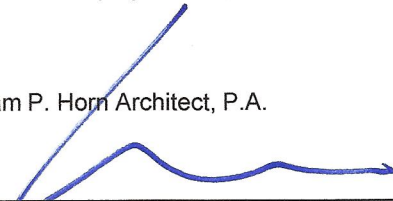

William P. Horn, R.A. NCARB, LEED AP, BD & C
Principal

2. INFORMATION PAGE

WILLIAM P. HORN ARCHITECT, PA.

915 EATON ST., KEY WEST, FL. 33040 TEL. 305-296-8302

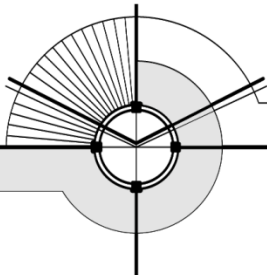
WPHORNARCHITECT.COM



INFORMATION PAGE

Architectural Services for City of Key West

Head Office:

William P. Horn Architect P.A.

915 Eaton St.

Key West, FL-33040

(305) 296-8302

www.wphornarchitect.com

William P. Horn is the sole Owner / Principal of the company named William P. Horn Architect, PA.

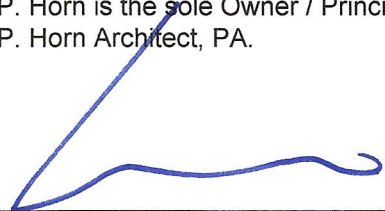

William P. Horn, R.A. NCARB, LEED AP, BD & C
Principal

William P. Horn – Principal Architect

william@wphornarchitect.com

Joseph Scarpelli– Project Architect

joe@wphornarchitect.com

Evelia Medina – Project Manager

evelia@wphornarchitect.com

3. ORGANIZATION CHART

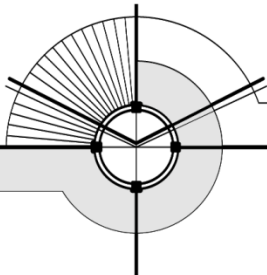

CITY OF KEY WEST

CITY OF KEY WEST STAFF

WILLIAM P. HORN, ARCHITECT, R.A.,
LEED AP, BD&C

PROJECT MANAGER
JOSEPH SCARPELLI, R.A.
MANAGER
EVELIA MEDINA

CIVIL ENGINEER
PEREZ ENGINEERING &
DEVELOPMENT, INC.

MECHANICAL / ELECTRICAL ENGINEER
INNOVATIVE ENG., GROUP

STRUCTURAL ENGINEER
KEISTER WEBB STRUCTURAL
ENGINEERS LLC

LANDSCAPE ARCHITECT
LANDWISE DESIGN, INC.

SUSTAINABILITY CONSULTANT
TRIFECTA CONSTRUCTION
SOLUTIONS

LAND USE PLANNING DEVELOPMENT
CONSULTANTS
TREPANIER & ASSOCIATES,
INC.

PRODUCTION STAFF

WILLIAM P. HORN ARCHITECT, PA.

915 EATON ST., KEY WEST, FL. 33040 TEL. 305-296-8302

WPHORNARCHITECT.COM

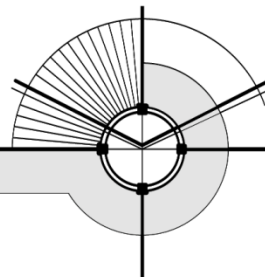

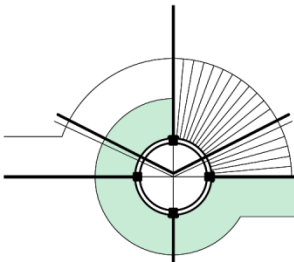

Prime Consultant

Architectural: William P. Horn Architect, PA

6 total staff members (3 Architects, 2 Intern Architects, 1 Administrative/Drafting)

Sub-Consultants

Civil Engineering: Perez Engineering & Development, Inc.

3 total staff members (1 Engineer, 1 Senior Designer, 1 Construction Inspector)

Structural Engineering: Keister Webb Structural Engineers

8 total staff members (5 Engineers, 1 Staff Engineer, 2 BIM (Revit) Technicians)

M.E.P. Engineering: Innovative Engineering Group, Inc.

6 persons (4 engineers, 1 draftsperson, 1 administrative)

Landscape Architect: Landwise Design, Inc.

2 persons (1 landscape architect, 1 draftsperson)

Planning: Trepanier & Associates, Inc.

4 persons (2 Planners, 2 Administrative)

Sustainability Consultant: Trifecta Construction Solutions

3 persons (2 professional consultants, 1 administrative)

List of key personnel that will work on this contract:

		<u>City of Residence</u>
Principal Architect:	William P. Horn, RA	Key Haven, FL
Project Architect:	Joe Scarpelli	Big Pine, FL
Project Manager:	Evelia Medina	Key West, FL
Intern Architect:	Joanna Walczak	Naples, FL
Administrative/Drafting:	Alma Horn	Key Haven, FL
Civil Engineer:	Allen Perez, P.E.	Key West, FL
Project Engineer:	Justin Henika, EIT	Key West, FL
Structural Engineer:	Mark J. Keister, P.E.	Jacksonville, FL
M.E.P. Engineer:	Sudhir Gupta, P.E.	Miami, FL
Landscape Architect:	Ladd Roberts, RLA	Jacksonville, FL
Planning:	Owen Trepanier	Key West, FL
Sustainability Consultant:	Jennifer Languell	Fort Myers, FL

4. COMPANY INFORMATION

WILLIAM P. HORN ARCHITECT, PA.

915 EATON ST., KEY WEST, FL. 33040 TEL. 305-296-8302

WPHORNARCHITECT.COM

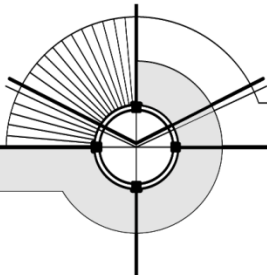

WILLIAM P. HORN ARCHITECT, P.A Firm Profile:

William P. Horn, Architect P.A. is a full service architectural firm that has been in business since 1993. We have successfully completed hundreds of projects throughout the Florida Keys. The firm has worked on many types of projects including commercial, governmental, residential, multi-family housing, affordable housing, master planning, sustainable and historic projects. The firm started out in 1993 as just two people, Bill Horn and his wife Alma and now is one the largest firms in Monroe County. The firm presently consists of six people.

William (Bill) Horn is the principal owner of the firm and has been working on projects within Monroe County and Key West since 1988. He is a registered architect in Florida, a LEED AP, BD&C and member of the NCARB. He has previously worked in New York and Philadelphia. Bill went to the University of Pennsylvania, Graduate School of Fine Arts to get his Master Degree in Architecture, 1988 and went to Clemson University, College of Architecture to get his Bachelor of Science Degree in Design, 1982. He is presently a member of the Key West Chamber of Commerce, Sunrise Rotary Club, US Green Building Council (National) and the past Chair of the Keys Branch of the US Green Building Council (South Florida). Bill was past president of Old Island Restoration Foundation and past chairman of the Historic Architectural Review Commission in Key West, Florida.

Frank Herdliska is an architect and has worked for the firm since 1995. He is a registered architect in Louisiana and received his bachelor of architecture from the University of Southwestern Louisiana. He has worked on numerous government projects within the last 25 years . He is past secretary and member of the USGBC, keys branch.

Evelia Medina has been with the firm since 2002. She is originally from Venezuela and is a registered architect in that country and received her Architectural Degree from the University Simon Bolivar, Caracas, Venezuela. She was a principal partner in her architectural firm prior to moving to Key West. Evelia is a LEED AP, BD&C.



Office Exterior

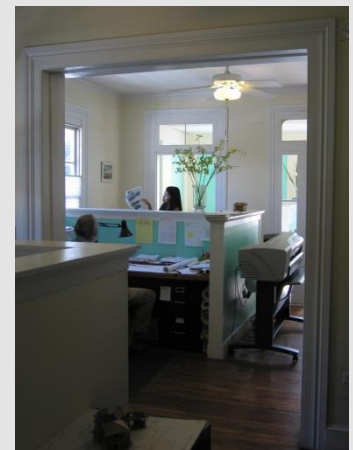

Office Interior

Services Provided :

- Site Analysis
- Site Planning
- Master Planning
- Historic Board approval process
- Planning Board approval process
- Park Projects
- Commercial Projects
- Governmental Projects
- Residential Projects
- New Construction
- Restoration/Renovation
- Preservation
- Sustainable Design

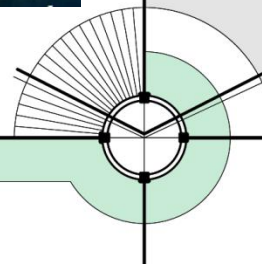

Joe Scarpelli is an Architectural Project Manager who has been working with the firm since 2017. Joe has a Bachelor of Science degree in Architectural Technology from New York Institute of Technology and is a registered architect in New York State and Florida. He has over eight years of experience in architecture and has exceptional experience/skills in construction and BIM (Building Information Modeling). He is presently a planning commissioner (Chairman) for Monroe County.

Joanna Walczak is an Interior Design Intern who joined in 2015. She has a Bachelor of Fine Arts Degree in Interior Design from the Japanese Academy of Information Technology in Warsaw, Poland, Bachelor of Economics and Management (Poland) and Bachelor of Business in Marketing (Ireland). Her previous work experience includes work in Architectural firm in Warsaw, Poland and in Stockholm, Sweden prior to moving to Key West.

Alma Horn has been with the firm since it started in 1993. She has a number of rolls, including drafting, payroll and book keeping. She has an interior design degree from Mexico, her home country.

William P. Horn, Architect P.A. provides full services for our clients, from initial site and design studies to final construction documents and specifications, bidding and construction administration. The firm provides architectural services for a variety of project types, from government work to developer projects to custom residential project. We provide services for renovation projects as well as new construction projects.

William P. Horn, Architect P.A. presently has an annual contract with the City of Key West, Monroe County School District, Key West Housing Authority, City of Marathon and Monroe County for architectural and engineering services.

Our goal is to provide solutions to our clients needs and be of services to them through the entire process. We strive to create unique solutions to each project that respond to the specific site parameters and to the individual needs of the clients.

Advantages of working with our firm:

1. Local Key West firm allows quick access for all phases of the project.
2. William Horn, the firms Principle/Owner will be directly involved in all projects.
3. We have 29 years of proven local client satisfaction.
4. Local expertise in construction solutions that work in the Florida Keys.
5. Firm has successfully completed hundreds of projects within the Florida Keys.



Garden View Apartments



Rex Welch Field Restrooms & Concessions



Catholic Charities Affordable Housing



Key West Chamber Of Commerce – Office Renovations



Roosevelt Gardens

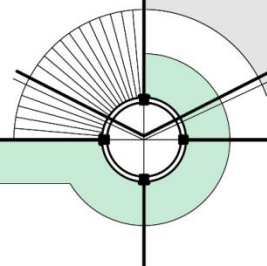

TEAM PROFILE AND HISTORY

Team History

The team of architects, planners and engineers have worked on numerous local governmental projects through out Monroe County. For over twenty nine years we have been providing Monroe County and Key West government agencies quality services and successfully completed projects.

William P. Horn Architect, P.A. is a Key West/Monroe County based Architectural firm that has been in the business since 1993 and will be providing full architectural services. The firm's principal, William P. Horn has been a registered architect in Florida since 1990 and has worked in Monroe County since 1988. He previously has worked in New York and Philadelphia. William Horn served on the Key West HARC Board for 4 years and was chairman for 3 years.

The firm is now one of the oldest architectural firms in Monroe County and has successfully completed hundreds of government and commercial projects throughout Monroe County and Key West.

William P. Horn Architect, P.A. presently has an annual contract with the City of Key West, the School District, the City of Marathon, the Housing Authority and Monroe County for architectural services.

William P. Horn Architect, P.A. is a local Key West firm and this allows us to be readily accessible to the client for meetings throughout all phases of the project. Also, since we are not a large out of town firm, the clients will be coordinating directly with William Horn (the principle of the firm).

Perez Engineering & Development, Inc., is a local professional civil engineering firm and will provide Civil Engineering Services. They have been in business in Key West since 1999. They have successfully managed and completed various types of multi-discipline contracts including continuing services contracts for municipal and state government, federal government and private industry. Their performance on past and current contracts confirms their ability to meet both schedule and budget requirements with a strong emphasis on quality.

Perez Engineering & Development, Inc. has a fairly diversified amount of professional experience which encompasses the design and preparation of construction documents, permitting, and construction services for a variety of roadway and land development projects. Their engineering design experience includes hydraulic and hydrologic computer modeling of storm water management systems; the design of potable and sanitary utility systems, pump stations, paving and grading design.

Keister Webb Structural Engineers LLC, is a Structural Engineering firm, located in Jacksonville, Florida and will be providing Structural Engineering services. Mark Keister, P.E. began his career as a structural engineer in 1983 in Atlanta, Georgia. Since then he has been providing consulting structural engineering service and expertise to architects and owners throughout the southeast. The firm has been working on projects within the Florida Keys for over 15 years and has worked on numerous projects for us over the last 12 years. Within the last 12 years we have worked on numerous projects including the Glenn Archer Gym Renovation, The May Sands Demolition/Renovation project, the Garden View Workforce Housing Project, Tavernier Old School Renovation and the New Nissan Showroom Building, the New Kots Building and the New Jail Addition.



Roosevelt Sands Affordable Housing



Grassy Key Fire Station



Dockmaster



Marathon City Hall

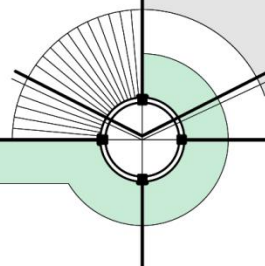

Innovative Engineering Group is a M.E.P. engineering firm who will be providing MEP engineering services. They have provided all of our mechanical, electrical, plumbing and fire sprinkler work since we started our company. The firm is based in Miami, Florida. They are very familiar with our local environment and regulations and have successfully produced numerous projects throughout South Florida. Sudhir Gupta, PE, LEED AP is the owner of the firm and he has an extensive experience in HVAC and Mechanical systems. Sudhir's firm is the M.E.P engineer for all of our projects.

Landwise Design, Inc. is a Jacksonville, Florida based landscape architectural firm that has worked successfully on numerous projects within Monroe County and will be providing Landscape Design Services. Ladd Roberts, the principal landscape architect of the firm provided landscape services for the redevelopment of Bernstein Park for Monroe County, The New Kots Building and Garden View Apartments Affordable Housing Project.

Trepanier & Associates, Inc. is a Key West Land Use Planner firm and will be providing planning Services. They have been in business since 2004. Owen Trepanier, the owner of the firm is a planner and has previously worked for the City of Key West as a planner. Owen is one of the most knowledgeable planners in Monroe County and the firm is the leading expert in the Key West and Monroe County permitting process. His firm was the planner who helped us get major development approvals for Roosevelt Sands, the New Kots Building and Garden View Apartments Affordable Housing Projects.

Trifecta Construction Solutions is a Ft. Myers, Florida based sustainability Engineering Consulting firm and will be providing Sustainability Services. They have been in business for over 16 years. The firm provides sustainability consulting for a variety of rating systems, including LEED Certification, Florida Green Building Coalition or Energy Star Ratings and Certifications. Dr. Jennifer Languell, the owner of the firm, is a nationally recognized leader in educating construction industries and developing sustainable projects. She is presently working with us on getting Florida Green Building Coalition Certification for the 37 unit Workforce Housing project for Catholic Charities in Key West, the New Kots Building and for the 103 unit Garden View Apartment Project.

The combined efforts of all team members will provide The City of Key West with the appropriate staff size, expertise and availability necessary to meet the needs of your projects in a timely and most cost effective manner.



Garden View Workforce Housing



Old Gymnasium Building Renovation



Bernstein Park Community Center & Fields



Stock Island Fire Station

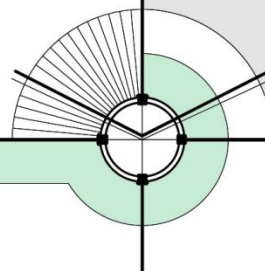

5. METHODOLOGY AND APPROACH

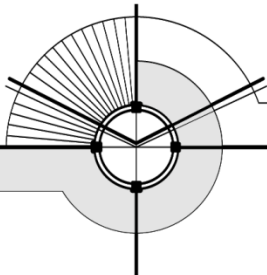

PROJECT METHODOLOGY AND APPROACH

The initial method and approach is an important part of each project. William P. Horn Architect, P.A., implements numerous reviews for each phase of each project to assure a quality project. We have developed a reputation of providing complete, accurate and detailed submittals for each phase of a project, such as Historic Board submittals, Variance and Planning Board submittals, and construction documents and specifications. The City staff in the planning and building department have complimented us on our submittals numerous times. William P. Horn Architect, P.A. has not had any lawsuits on any of the firms projects, which supports our efforts for good quality control.

PROJECT START

An important part of any project is listening to the clients needs and understanding the full scope of the project. During the initial meetings with the client William Horn, the principal architect on this team, attends the meetings to make sure he understands the full scope of the project and all the needs of the client. He maintains personal communication with the client throughout the entire project to assure consistency and quality.

Once the program for the project is understood and design work is started the team uses their vast experience with zoning and building codes and applies the knowledge to the project. It is important at this early stage, to assure that the project can be realized within the codes and find conflicts early. Preliminary construction costs are developed and discussed to clarify budget limitations. Sustainability goals are discussed and set for the project.

SCHEMATIC DESIGN PHASE

After the projects program, initial code review and preliminary budget is set, we move into the schematic design of the project. We explore numerous design options to assure that we have found the best quality design for the project. The quality of the design is important to the team. For new buildings or larger renovation projects we have been initiating our design in 3-D (Revit). A 3-D model is created on the computer that allows the design team and the client clearly understand the design, thus eliminating any misunderstanding of the design, this 3-D presentation is also used for submission to HARC and The Planning Board if required.

The design is reviewed by the project architect, the principal architect and the other team members to assure land use, handicap code, FEMA and building code compliance. Sustainability goals are reviewed and integrated into the design. Costs estimates are reviewed.

The project then gets submitted to the DRC, Tree Commission, Planning Board, HARC Board, City Commission and the State for review and approvals.



Public Workshops



Conceptual Design



Master Plan

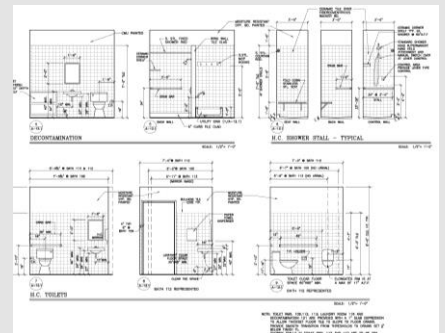

ADA Code Review

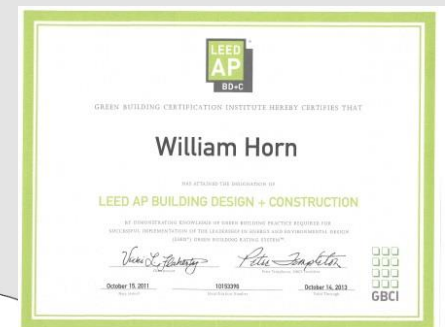

LEED Certification

WILLIAM P. HORN ARCHITECT, PA.

915 EATON ST., KEY WEST, FL. 33040 TEL. 305-296-8302

WPHORNARCHITECT.COM

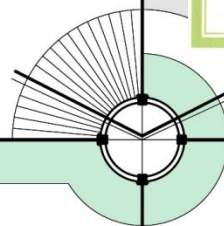

DESIGN DEVELOPMENT PHASE

Once the schematic design is developed and reviewed and all initial approvals are received from the Tree Commission, DRC, Planning Board, HARC Board, City Commission and State, the team moves into design development. The design is developed by all team members to assure that all systems coordinate properly. The project architect meets with each consultant to review the projects development and resolve any conflicts. The client is made aware of all aspects of the development of the project to assure that there are no surprises or mis-understanding. The principal architect, William p. Horn, reviews the project and then meets again with the client to finalize this part of the project. The construction cost estimate is updated again.

CONSTRUCTION DOCUMENTS PHASE

When the project is developed enough so that all systems of the building and site are coordinated and the clients needs have been met the team proceeds to develop the construction documents and specifications. The project architect conducts extensive coordination with all of the team members (structural, civil, MEP engineers, etc.) to assure that everyone is working with the latest information and that everything is coordinated. The client has the opportunity to review the drawings at the 50% and 90% level of completion. The principal architect meets weekly with the team and reviews the project for completeness and clarity.

When the construction documents are 100% complete the client and the team review the project once more to assure the completeness and quality of the project. A final construction cost estimate is completed.

BIDDING PHASE

William P. Horn Architect, P. A. and the team assist the client with the bidding process to assure the contractors clearly understand the project so that they can provide a quality bid. Many contractors have complemented our construction documents and specification as being complete and clear. We work hard to be available and answer any questions from the bidders or provide more clarification on any issue. The bids are reviewed and compared for consistency so that the client has accurate bids.

CONSTRUCTION PHASE

During construction the team can provide the client complete construction supervision to make sure the contractor completes the project as per plans and specifications. Inspections during construction are provided only by the teams registered architects or engineers. Since most of our team members are in Key West, we can quickly go out to the site to review the construction.

We have found that in order to maintain the quality of the project through the construction phase the architects, engineers and owner, must review the construction on a consistent basis. This consistent review is one of the most important parts of obtaining a quality project.



Catholic Charities Under Construction

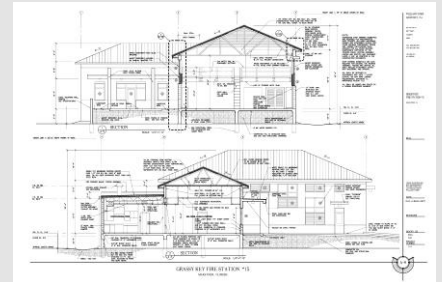

Construction Documents



Construction Supervision of Bernstein Park Community Center



Construction Supervision

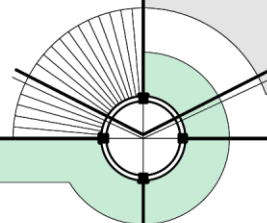

6. PERSONNEL

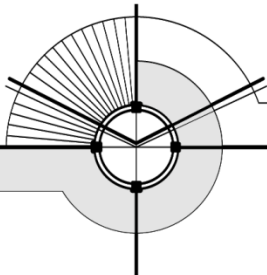

REGISTRATION

STATE OF FLORIDA: No. 13537
 N.C.A.R.B. (National Council of Architectural Registration Boards) No. 52247
 LEED AP (Accredited Professional), BD+C.

EDUCATION

THE UNIVERSITY OF PENNSYLVANIA, Graduate School of Fine Arts
 Master of Architecture - 1988
 CLEMSON UNIVERSITY, College of Architecture
 Bachelor of Science in Architecture – 1982

ASSOCIATIONS

U.S. GREEN BUILDING COUNCIL – National Member
 USGBC – South Florida Chapter, Keys Branch
 HARC- HISTORIC ARCHITECTURAL REVIEW BOARD- Past Chairman (three years)
 OLD ISLAND RESTORATION FOUNDATION – Past President, Member
 LEADERSHIP MONROE COUNTY (Class 1)
 SUNRISE ROTARY CLUB - Member
 KEY WEST CHAMBER OF COMMERCE - Member
 NATIONAL COUNCIL OF ARCHITECTURE REGISTRATION BOARD – MEMBER
 MONTESSORI CHILDRENS SCHOOL – PAST VICE PRESIDENT, BOARD MEMBER

William P. Horn, PA LEED AP

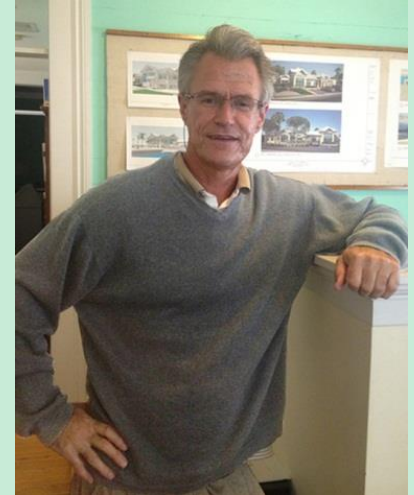

EXPERIENCE

1993 - PRESENT
WILLIAM P. HORN ARCHITECT, P.A.
 Principal
 Key West, Florida 33040

1988 – 1993
GONZALEZ ARCHITECTS
Project Manager
 Key West, Florida 33040
 Educational, Commercial,
 Affordable Housing.
 Residential and Planning

1986 - 1987
BOWER LEWIS
THROWER/ARCHITECTS
 Designer
 Philadelphia, Pennsylvania
 Institutional, commercial
 and residential projects.

1983 - 1986
HAROLD E. GEBHARD, AIA.
Project Architect
 Williston Park, New York
 Large scale renovations,
 commercial and residential
 projects.

1985 - 1986
**KELLER/SANGRIN ASSOCIATES/
 ARCHITECTS**
 Designer/draftsperson
 Massapequa, New York
 Custom residential projects

■ **Garden View Affordable Housing**
 Stock Island, FL.
 New 103 Unit
 Affordable Housing Project
 Client: City of Key West & Housing Authority
 of the City of Key West

■ **Roosevelt Sands Jr. Housing
 Complex & Club House**
 Key West, FL.
 New 44 Residential affordable apartment
 units and Club House
 Client: Housing Authority of the City of Key
 West

■ **Camp Sawyer Boy Scout Camp**
 West Summerland Key, FL.
 Designed Master Plan For Site
 New Toilet/Shower Building
 Registered to be LEED Silver Certified

■ **Henderson Building**
 Mixed Use Building with office use and 6
 workforce housing units.
 Big Pine, Florida
 Client: Ginger Henderson

■ **Bernstein Park**
 Total Renovation to Park and New
 Community Center and Maintenance Building
 Stock Island, FL.
 Client: Monroe County

■ **St. Bede's Village**
 Key West, FL.
 37 unit Affordable Housing complex with on
 site parking and landscape design. All units
 will be FGBC Certified.
 Client: Catholic Charities

■ **KOTS (Keys Overnight Temporary
 Shelter)**
 Stock Island, FL.
 Client: City of Key West

■ **Dockmaster**
 Garrison Bight, Key West, FL.
 Client: City of Key West

■ **Marathon City Hall**
 Marathon, FL.
 New 15,000 S.F. City Hall
 Client: City of Marathon

■ **Mosquito Control Facility**
 New Office Building, Maintenance Building +
 Sitework
 Big Coppitt Key, FL.
 Client: Mosquito Control Board

■ **The Basilica High School Project**
 Renovation of existing auditorium for new high
 school
 Key West, FL.
 Client: St. Mary's Basilica School

WILLIAM P. HORN ARCHITECT, PA.

915 EATON ST., KEY WEST, FL. 33040 TEL. 305-296-8302

WPHORNARCHITECT.COM

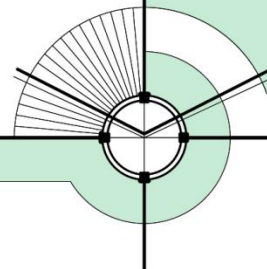

Joe Scarpelli, RA



REGISTRATION

State of New York: No. 041198
 State of Florida No. AR101614
 NCARB Certified

EDUCATION

New York Institute of Technology
 Bachelor of Science, Architectural Technology

Revit, AutoCAD, Photoshop, Sketch-Up
 Revit Architecture Intermediate Autodesk training course
 PSMJ Project Management Bootcamp

ASSOCIATIONS

Monroe County Planning Commission - Chairman
 USGBC – South Florida Chapter, Keys Branch.
 AIA

- **Mosquito Control Facility**
 New Office Building, Maintenance Building and Sitework
 Big Coppit Key, FL.
 Client: Mosquito Control Board
- **Juvenile Justice Building Renovations**
 Key West, FL.
 Client: Monroe County
- **Henderson Building**
 Mixed use building with office use and 6 workforce housing units.
 Big Pine, Florida
 Client: Ginger Henderson
- **Garden View Affordable Housing**
 Stock Island, FL.
 New 103 Unit Affordable Housing Project
 Client: City of Key West & Housing Authority of the City of Key West
- **Big Pine Academy**
 Classroom and Office Renovations
 Big Pine Key, FL.
 Client: Monroe County School District
- **Historic Seaport Common Area Enhancements**
 Key West, FL.
 Client: City of Key West
- **St. Bede's Village**
 Key West, FL.
 37 unit affordable housing complex with on site parking and landscape design. All units will be FGBC Certified.
 Client: Catholic Charities
- **725 Duval Street**
 New residential units in existing commercial building
 Key West, FL.
 Client: Joseph Cohen
- **Kosloske Residence**
 New 5,000 S.F. Residence
 Key Haven, FL.
 Client: Kosloske Family
- **Enchanted Island**
 New 6,000 S.F. Residence
 Raccoon Key, FL.
 Client: Sam Sappala
- **The Basilica High School Project**
 Renovation of existing auditorium for new high school
 Key West, FL.
 Client: St. Mary's Basilica School

EXPERIENCE

2017– PRESENT

WILLIAM P. HORN ARCHITECT, P.A.

Project Manager
 Key West, Florida
 Residential, Commercial, Hospitality and Governmental projects

2015-2017

K2M Design

Key West, Florida 33040
 Designer
 Residential, Commercial, Hospitality and Governmental projects

2012-2015

D'Asign Source

Architectural Project Manager/
 Construction Project Manager
 Marathon, Florida.
 Design, coordinate and produce 3D renderings for Architectural and Interior Design projects.

2011-2012

Deck Remodelers

Project Manager
 Sparta, NJ
 Manage, coordinate and budget the cost of construction of projects across Northern New Jersey

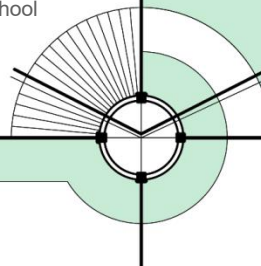

REGISTRATION

State of Louisiana: No. 2178

EDUCATION

The University of Southwestern Louisiana
Bachelor of Architecture - 1973.

ASSOCIATIONS

Vieux Carr'e Property Owners, Assoc.
New Orleans, La.
USGBC – South Florida Chapter, Keys Branch - Secretary

Frank I. Herdliska, RA

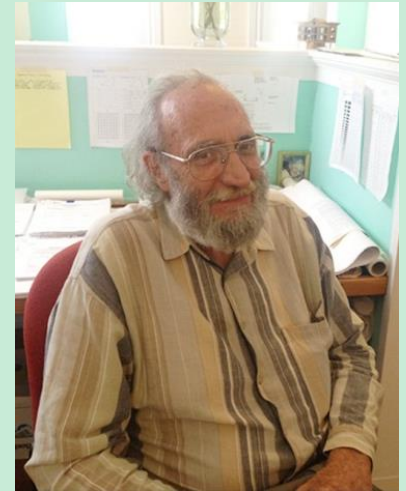

EXPERIENCE

2011– PRESENT

WILLIAM P. HORN ARCHITECT, P.A.

Key West, Florida 33040
Project Architect

2006 - 2011

MATHERS BRIERRE ARCHITECTS

New Orleans, LA.
Project Architect
Large scale
commercial and residential

1994 - 2006

WILLIAM P. HORN ARCHITECT, P.A.

Key West, FL.
Project Architect

1989- 1993

GONZALEZ ARCHITECTS

Key West, Florida
Project Architect
Educational, Commercial
Residential
and Planning Projects

1981- 1986

MATHERS BRIERRE ARCHITECTS

New Orleans, LA.
Project Architect
Large scale
commercial and residential

1974 - 1979

KESSELS - DIBOLL - KESSELS.

Designer/Draftsperson
New Orleans, Louisiana

- **Garden View Affordable Housing**
Stock Island, FL.
New 103 Unit
Affordable Housing Project
Client: City of Key West & Housing Authority of the City of Key West
- **Monroe County Fire Station No.8**
Stock Island, FL.
New 8,350 S.F. 2-Story Building
Client: Monroe County
- **Strunk Ace Hardware & Manley Deboer Lumber Yard**
Key West, FL.
New 72,000 S.F. Building Complex
- **Roosevelt Gardens**
Key West, FL.
Project included a Master Site Plan on the old fairgrounds lot (287,996 S.F., 6.6 acres) for an Affordable Housing Development of 96 residential units.
Client: Housing Authority of the City of Key West
- **Big Pine Fire Station**
Big Pine, FL.
New 9,000 S.F. Fire Station
Client: Monroe County
- **Dockmaster**
Garrison Bight, Key West, FL.
Client: City of Key West
- **Niles Sales & Service Renovation**
Key West, FL.
Renovation to an existing 34,500 S.F. car dealership
- **Waterfront Brewery**
Key West Bight, FL.
Renovation of
Previous Waterfront Market into a 18,500 S.F. Brewery and Restaurant
- **Marathon City Hall**
Marathon, FL.
New 15,000 S.F. City Hall
Client: City of Marathon
- **Grassy Key Fire Station**
Grassy Key, FL.
New 5,000 S.F. Fire Station Building
Client: City of Marathon
- **Bernstein Park**
Total Renovation to Park and New Community Center and and Maintenance Building
Stock Island, FL.
Client: Monroe County
- **Mosquito Control Facility New Office Building, Maintenance Building + Sitework**
Big Coppit Key, FL.
Client: Mosquito Control Board

WILLIAM P. HORN ARCHITECT, PA.

915 EATON ST., KEY WEST, FL. 33040 TEL. 305-296-8302

WPHORNARCHITECT.COM

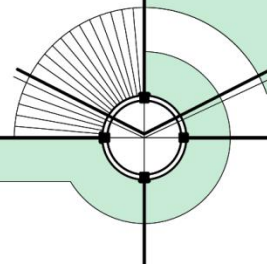

REGISTRATION

Partnership Venezuelans Engineer: 85.245
LEED AP (Accredited Professional), BD+C.

EDUCATION

Universidad Simon Bolivar., Caracas, Venezuela.
Architect Graduate – 1992.

Courses , Training and Formation
Autocad 2013, Autocad 3d & Render course,
Revit Architecture course,

ASSOCIATIONS

USGBC-South Florida Chapter, Keys Branch - Member

Evelia Medina, Leed AP



EXPERIENCE

2002 – PRESENT

WILLIAM P. HORN ARCHITECT, P.A.

Key West, Florida 33040
Architectural Office Manager
Residential, Commercial
and Governmental projects

1996 – 2001

MARAGALL & ASOCIADOS

Caracas, Venezuela
Architect
Project and Design of
Residential/Commercial Units

1994 - 1996

La Casa del Closet

Caracas, Venezuela
Architect –Designer
Design of closets & furniture
Installation supervision

1995 - 1999

SCR Remodelaciones

Caracas, Venezuela
Own Firm
Remodeling Projects,
Stores design

1992 - 1995

PROYECTOS ALIAS ARQUITECTURA

Caracas, Venezuela
Own Firm
Project development
Remodeling projects

■ **Higgs Beach Master Plan
And Visitors Center**

Key West, FL.
Designed master plan for a 19 acre
site on the Atlantic Ocean
Client: Monroe County

■ **Camp Sawyer Boy Scout Camp**

West Summerland Key, FL.
Designed Master Plan For Site
New Toilet/Shower Building
Registered to be LEED Silver Certified

■ **Poinciana Elementary School**

Key West, FL.
Design new soccer fields
Client: Monroe County School Board

■ **Roosevelt Sands
Affordable Housing**

Bahama Village, Key West, FL.
New 44 Unit Affordable Housing
Project
All Units Energy Star Certified

■ **Grassy Key Fire Station**

Grassy Key, FL.
New 5,000 S.F. Fire Station Building
Client: City of Marathon

■ **Garden View Affordable
Housing**

Stock Island, FL.
New 103 Unit
Affordable Housing Project
Client: City of Key West & Housing
Authority of the City of Key West

■ **Key West Chamber of Commerce**

Key West, FL.
New Office Renovation within
Historical "Old City Hall"

■ **Mosquito Control Facility**

New Office Building, Maintenance Building
+ Sitework
Big Coppit Key, FL.
Client: Mosquito Control Board

■ **St. Bede's Village**

Key West, FL.
37 unit Affordable Housing complex with on
site parking and landscape design. All units
will be FGBC Certified.
Client: Catholic Charities

■ **Bernstein Park**

Total Renovation to Park and New
Community Center
Stock Island, FL.
Client: Monroe County

■ **Monroe County Fire Station No.8**

Stock Island, FL.
New 8,350 S.F. 2-Story Building
Client: Monroe County

■ **Dockmaster**

Garrison Bight, Key West, FL.
Client: City of Key West

■ **Marathon City Hall**

Marathon, FL.
New 15,000 S.F. City Hall
Client: City of Marathon

WILLIAM P. HORN ARCHITECT, PA.

915 EATON ST., KEY WEST, FL. 33040 TEL. 305-296-8302

WPHORNARCHITECT.COM

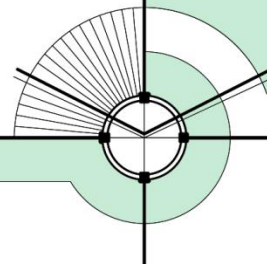

REGISTRATION

LEED Green Associate

EDUCATION

Polish-Japanese Academy Of Information Technology, Warsaw, Poland
Bachelor of Fine Arts in Interior Design
2008-2012

Letterkenny Institute of Technology, Ireland
Bachelor of Business in Marketing
2006-2007

Lazarski University, Warsaw, Poland
Bachelor of Economics and Management in International Trade
2004-2007

College Courses: ArchiCAD, Artlantis Studio, Adobe Photoshop,
Adobe Illustrator, Adobe InDesign
Additional: AutoCAD

Joanna Walczak, Leed Green Associate

EXPERIENCE

2022– PRESENT WILLIAM P. HORN ARCHITECT, P.A.

Designer
Key West, Florida 33040
Residential, Commercial
and Governmental projects

2021– 2022 CID DESIGN GROUP

Associate Interior Designer
Naples, Florida 34109
Multifamily and Hospitality
projects

2015– 2020 WILLIAM P. HORN ARCHITECT, P.A.

Architectural Designer
Key West, Florida 33040
Residential, Commercial
and Governmental projects

2013 LIVING DESIGN CONSULTING GROUP AB

Intern
Stockholm, Sweden
Hospitality and Residential projects
Purchase orders & invoicing
Revising BOQ and budgets
Changing and completing FF&E
specification sheets

2012-2013 ARCHIPLANER

Interior Designer
Warsaw, Poland
Residential Projects
Drawing plans, selection of vendors and
materials, meetings with client

- **Bernstein Park
Total Renovation to Park and New
Community Center**
Stock Island, FL.
Client: Monroe County
- **Mosquito Control Facility
New Office Building, Maintenance
Building + Sitework**
Big Coppit Key, FL.
Client: Mosquito Control Board
- **Crawl Key Fire Training Academy
New 5,000 S.F. Fire Training Academy**
Crawl Key, FL.
Client: Monroe County
- **Nissan Showroom
New 4,531 S.F. Nissan Showroom +
Sitework**
Key West, FL.
Client: Niles Sales + Service
- **Seven Fish Restaurant
New 5,500 S.F. Restaurant**
Key West, FL.
Client: Bob & Noreen Pollman
- **Old Gym Renovations
Police Athletic League**
Key West, FL.
Client: City of Key West
- **Two Ocean Inn
New 17 Unit Boutique Hotel**
Key West, FL.
Client: Soni Family
- **Key West Police Department
New Windows, Doors + Roof System**
Key West, FL.
Client: City of Key West
- **Affordable Housing Project
– 2700 Flagler Ave.
New 37 Units of Affordable Housing**
Key West, FL.
Client: Catholic Charities
- **Tavernier Old school Renovation to
Senior Center**
Tavernier, FL.
Client: Monroe County
- **Kosloske Residence**
New residence with water view.
Key Haven, FL.
Client: Kosloske Family
- **725 Duval Street**
New residential units in existing commercial
building
Key West, FL.
Client: Joseph Cohen

WILLIAM P. HORN ARCHITECT, PA.

915 EATON ST., KEY WEST, FL. 33040 TEL. 305-296-8302

WPHORNARCHITECT.COM

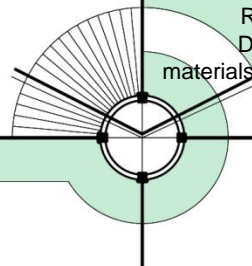

Alma Horn



EDUCATION

Universidad Autonoma de Ciudad Juarez, Chih., Mexico
Interior Designer 1978

- **Higgs Beach Master Plan And Visitors Center**
Key West, FL.
Designed master plan for a 19 acre site on the Atlantic Ocean
Client: Monroe County
- **Camp Sawyer Boy Scout Camp**
West Summerland Key, FL.
Designed Master Plan For Site
New Toilet/Shower Building
Registered to be LEED Silver Certified
- **Southern Cross Hotel Renovation and additions**
Key West, FL.
Major renovation/additions to create a 38 unit boutique hotel
- **Roosevelt Sands Affordable Housing**
Bahama Village, Key West, FL.
New 44 Unit
Affordable Housing Project
All Units Energy Star Certified
Client: Housing Authority of the City of Key West
- **Niles Sales & Service Renovation**
Key West, FL.
Renovation to an existing 34,500 s.f. car dealership
- **Strunk Ace Hardware & manley deboer lumber Yard**
Key West, FL.
New 72,000 s.f. Building Complex
- **American Caribbean Offices**
Marathon, FL.
New Real Estate Offices,
4,000 s.f.
- **Truman Hotel**
Key West, FL.
Mayor Renovation to 3 Existing Buildings and addition of new 3-story building (38 unit Hotel)

EXPERIENCE

1993 – PRESENT
WILLIAM P. HORN ARCHITECT, P.A.

Key West, Florida 33040
Administration/Drafting

1989 -1990
Gonzalez Architects

Key West, Florida
Drafting

1981 – 1982
Odette's Fixture & Display

El Paso, Texas
Drafting, Furniture Design.

1979 – 1981
Coloso, S.A.

Cd. Juarez, Chih., Mexico
Window Display

1978 - 1979
Javier Sandoval, Architect

Cd. Juarez, Chih., Mexico
Drafting

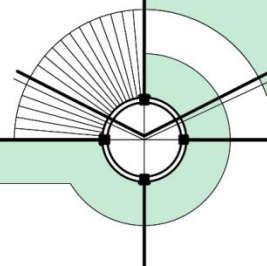

Allen E. Perez, P.E.
President

Mr. Perez has more than twenty-five (25) years of experience in roadway design, sanitary sewer systems, stormwater systems, potable water systems, and general civil engineering services. His experience includes the management and technical preparation of master plans, construction documents, permit submittals, and construction services for a wide variety of development activity. Mr. Perez has been providing professional engineering services, from his Key West office, for projects throughout the Florida Keys for over seventeen (17) years.

Mr. Perez has experience in providing Civil Engineering services for a variety of private and public sector clients. The following is a summary of some of his current and past public sector continuing services contracts:

- *City of Key West*
 - *General Storm Water and Wastewater Engineer*
 - *Professional Engineering Consulting Services*
- *Monroe County*
 - *General Airport Consultant*
 - *Architectural/Engineering Services for Small Projects*
- *Florida Keys Aqueduct Authority*
 - *General Engineering Services*
- *Monroe County Housing Authority*
 - *General Engineering Services*
- *Key West Housing Authority*
 - *General Engineering Services*
- *Monroe County School Board*
 - *General Engineering Services*
- *Florida Keys Community College*
 - *General Engineering Services*

Mr. Perez’s engineering design experience is fairly diversified and includes hydraulic and hydrologic computer modeling of storm water management systems; the design of potable and sanitary utility systems, pump stations, paving and grading design.

EDUCATION

University of South Florida, Bachelor of Science in Civil Engineering, 1992
University of South Florida, Master of Science in Civil Engineering, 1995

REGISTRATIONS

Registered Engineer – Florida No. 51468

HIGHLIGHTED PROJECT EXPERIENCE

GOVERNMENT & INSTITUTIONAL EXPERIENCE

Key West City Administration Complex
Key West Fire Station No. 2
Monroe County Public Works Facility
Monroe County Courthouse, Marathon
Key West City Hall
Stock Island Fire Station
Big Pine Key Fire Station
Higgs Beach Master Plan
Horace O’ Bryant School
Truman Waterfront Redevelopment
NAVFAC Key West
Marathon High School
FKCC Marine Technology Building
Poinciana Elementary School
Plantation Key Elementary School

PRIVATE CLIENTS

Keys Federal Credit Union
First State Bank
Capital Bank
Aids Help
Habitat for Humanity
Catholic Charities
Spottswood Companies, Inc.

Mark J. Keister, PE

Principal

EDUCATION

Bachelor of Science in Engineering
Duke University, 1981

Master of Science in Civil Engineering
Georgia Institute of Technology, 198338

PROFESSIONAL REGISTRATIONS

Licensed Professional Engineer in Alabama, Arkansas, Florida, Georgia, Kentucky, Louisiana, Maryland, Mississippi, North Carolina, Oklahoma, South Carolina, Tennessee, Texas, Virginia, Wisconsin

PROFESSIONAL MEMBERSHIPS

American Institute of Steel Construction
American Concrete Institute
American Society of Civil Engineers
Structural Engineering Certification Board
Florida Engineering Society



EXPERIENCE

Mr. Keister began his career as a structural engineer in 1983. He has since provided structural engineering services and expertise to architects and owners throughout the southeast. His projects include apartment complexes, educational facilities, dormitories, gymnasiums, family life centers, fitness centers, laboratories, hotels, churches, extended nursing care facilities, office buildings, hospitals, theaters, manufacturing plants, parking garages, historic restoration, manufacturing facilities and Central Utility Plants (CUPs).

His related project experience includes but is not limited to:

- Horace O'Bryant School Stairway: Key West, Florida
- Key Largo Elementary School US-1 Dugout and Ball Stop; Key Largo, Florida
- East Martello South Roof Repairs; Key West, Florida
- Elizabeth Bishop House Rehabilitation; Key West, Florida
- Monroe County Public Defender 316 Simonton St.; Key West, Florida
- Florida Keys Community College Chiller Building¹; Stock Island, Florida
- Key West City Hall at Glynn Archer¹; Key West, Florida
- Keys Energy Services, 1001 James Street¹; Key West, Florida

¹ Project designed and administered while employed by H.W. Keister Associates, Inc.

Kyle W. Binninger, PE

Project Engineer

EDUCATION

Bachelor of Science in Engineering
Florida Gulf Coast University, 2013

Master of Science in Civil Engineering
University of Florida, 2014

PROFESSIONAL REGISTRATIONS

Licensed Professional Engineer in Florida

PROFESSIONAL MEMBERSHIPS

American Institute of Steel Construction

International Concrete Repair Institute

American Concrete Institute



EXPERIENCE

Mr. Binninger began consulting on structures in 2015. He has served as a project engineer on projects for a wide variety of services including new designs, historical restoration and preservation, adaptive reuse projects, threshold projects and inspections, feasibility studies, concrete assessment and rehabilitation, construction management, and specialized medical services. He is involved in project design, scheduling, and communications while proactively ensuring projects are completed on time and on budget.

His related project experience includes but is not limited to:

- City of Jacksonville Beach Dune Walkover Replacement FY 21; Jacksonville Beach, Florida
- City of Jacksonville Beach Dune Walkover Replacement FY 22; Jacksonville Beach, Florida
- Ponte Vedra Inn & Club, St. John's House Concrete Restoration; Ponte Vedra Beach, Florida
- Global Home of the PGA TOUR¹; Ponte Vedra Beach, Florida
- Long Key State Park Day Use Restroom¹; Long Key, Florida
- Rowell's Marina Park Resrooms¹; Key Largo, Florida
- Monroe County Information Kiosks¹; Monroe County, Florida
- Suwannee National Wildlife Refuge HSR¹; Chiefland, Florida

¹ Project designed and administered while employed by H.W. Keister Associates, Inc.

INNOVATIVE ENGINEERING

5532 N.W. 72nd Ave.

Miami, Florida 33166

Electrical Engineer

Claudio Jofre, P.E.

Claudio Jofre has been involved in electrical engineering since 1953. His design and construction management experience includes electrical installations for residential, commercial, industrial and institutional projects, over head and underground high and low voltage power lines, transformer vaults, main switch gear, power and lighting, motors and controllers automation, fire alarm and security systems, telephones, television, energy management systems, standby and uninterrupted power systems among projects he has worked on are:

Miami Beach Convention Center, Miami, Fl.

Brickell Key, Claughton Island – A 22 story Condominium.

Florida Department of Transportation, Miami, Fl.- Palmetto Expressway new street lighting.

Homestead Air Force Base, Homestead, Fl. – Primary underground network.

Presidential Circle, Hollywood, FL. – Two 7 story office towers and atrium.

Professional Experience:

McDowell-Helmick Associates, Inc. – Miami, Fl.

1983-1989

Wilbur Smith and Associates – Miami, Fl.

1981-1983

Florida Engineering Services – Miami, Fl.
1980-1981

Aerocast, Inc. – Miami, Fl.
1979-1980

Claudio Jofre received his B.S. degree in Electrical Engineering from Santa Maria Technical University of Chile (1953) and is a registered engineer in the state of Florida.

INNOVATIVE ENGINEERING
5532 N.W. 72nd Ave.
Miami, Florida 33166

Plumbing and Fire Protection Engineer

Lorenzo Triana, P.E.

Since 1966, Lorenzo Triana has been involved in various phases of mechanical engineering. For the last 12 years he has dedicated his time to design of plumbing & fire protection. Notable among projects he has worked on are:

Veteran Administration Hospital – West Palm Beach, Fl. – a 400 bed facility and design of all hydraulics and sanitary systems, medical gases and fire sprinkler system for the building.

Pea Body Hotel – Orlando, Fl.; plumbing & fire protection for the 900 room, 28 story hotel.

Sawgrass Mill Mall – Ft. Lauderdale, Fl.; plumbing & fire protection for the world's largest shopping center.

Miami Arena – Miami, Fl.; plumbing & fire protection for a 15,000 seat completely closed stadium.

Vizcata Art Museum – Miami, Fl.; plumbing & fire protection for the renovation of a historic site.

Renovation of Water Treatment Plant – Punta Gorda, Fl. – Design of plumbing and instrumentation works.

Professional Experience:

Wolfberg Alvarez & Associates – Miami, Fl..	1989-1991
Lagomasino Vital Associates – Miami, Fl.	1986-1989
Dalla Rizza & Associates – Miami, Fl. 1983-1986	
Wolfberg Alvarez & Associates – Miami,	1980-1981

Lorenzo Triana received his B.S. in mechanical engineering from Santa Clara Central University of Cuba (1966) and has been registered in Florida since 1988.



education University of North Florida
Bachelors of History, 1991

University of Florida
Masters of Landscape Architecture, 1997

profile **Over 18 years experience delivering**

- Recreation Planning
- Landscape Architecture
- Public Facilitation and Consensus Building
- Project Management (Sub-Consultant Coordination)
- Excellent Client-Consultant Coordination
- Alert Attention to Detail

experience **Landwise Design, Inc. [2004-Present]**
Landwise Design is currently marketing in Northeast Florida, the Florida Keys and Coastal Florida. Mr. Roberts's vast design experience, leadership coordinating various design disciplines, attention to detail and overarching understanding of the design and construction process empower him to make Landwise Design, Inc. the right company for your project challenges.

HDR Engineering [2002-2004]
HDR Engineering purchased Landers-Atkins Planners to establish a planning and landscape architecture division within their Jacksonville office. Building upon an already extensive client base, this merger provided a broader scope of work to our planning department; including FDOT, the Better Jacksonville Plan and parks and recreation work throughout multiple counties.

Responsibilities included the project management of nearly six hundred thousand dollars worth [design fees] of annual parks and recreation projects, plus FDOT, commercial and private projects.

Landers-Atkins Planners [1997-2002]
Landers-Atkins Planners was a medium sized land planning and landscape architecture firm in northeast, Florida. Mr. Roberts was hired in 1997 and brought with him a backlog of established clients and projects to the firm. He quickly rose to project manager, facilitating residential, commercial, private and municipal projects.

projects **Project references available upon request.**

Owen John Trepanier



CAREER SUMMARY

President, Trepanier & Associates, Inc., Key West, FL **2004 to present**

Owen is responsible for marketing and project development for this regional land-use planning firm. Provide professional planning assistance and project management to clients for affordable housing, beneficial use, commercial & residential development, comprehensive planning, conditional use approvals, condominium conversions, development plan approvals, FEMA-related issues, historic redevelopment, senior housing, site planning, variances, and zoning changes & ordinance drafting.

Associate, The Craig Company, Key West, FL **2003 to 2004**

Provided technical planning assistance to company clients for new construction, redevelopment, condominium conversion, affordable housing, subdivisions, comprehensive planning and future land use map changes.

Senior Planner, The City of Key West, FL **2000 to 2003**

Interpreted and administered land development regulations. Authored technical analysis and recommendation reports for affordable housing, conditional uses, development plans, easements, ROGO beneficial use allocations, transient units & license transfers, subdivisions, vacations of public property, and variances.

Community Development Director, Village of Princeville, IL **1998 to 2000**

Coordinated development of the Village's Future Land Use Map. Developed a business enhancement loan subsidy program with TIF funds, created a community development assistance program revolving loan fund, and created a volunteer program of 200 individuals. Developed the \$2 million Princeville Heritage Center.

Peace Corps Fellow, Western Illinois University, Macomb, IL **1997 to 1999**

Collaborated on the writing of community and development program assessment reports. Performed strategic planning and visioning sessions for community planning processes.

Peace Corps Volunteer, Nandi District, Kenya **1995 to 1997**

Established working relationships between the community, government, nongovernmental organizations and The Peace Corps. Solicited and won grant funds for 50 small-scale reforestation, income generation and education projects.

Physical Science Lab Technician, US Geological Survey, Denver, CO **1994 to 1995**

Collaborated on the development of a paleo-environmental indicator database for Yucca Mountain Nevada Nuclear Repository Site.

EDUCATION

- Graduate Certificate, Community Development, Western Illinois University, 2002
- Master of Science, Regional Planning & Community Development, Western Illinois University, 2001
- Business Retention & Expansion, Illinois Institute for Rural Affairs, Macomb, Illinois, 1998
- Conflict Resolution, Illinois Institute for Rural Affairs, Macomb, Illinois, 1997
- Certificate, Community Development, CHP International, Naivasha, Kenya 1995
- Bachelor of Science, Geology, University of Colorado, Denver, 1994



Jennifer L. Languell, PhD



PROFILE

Dr. Jennifer Languell is a nationally recognized leader in educating construction industries about the benefits of green building and sustainable development. She has worked as a part of the development team on high performance, single-family housing, affordable high-rise residences, commercial projects and some of the largest and most sustainable land developments in the world. She has also worked with governments and municipalities that are moving toward sustainable and fiscally prudent operating and management practices. She has partnered with the City of Tallahassee, the Army Corps of Engineers and many others to analyze the life cycle and quantify sustainability. Dr. Languell frequently appears at national and international conferences, speaking to professionals and consumers in their own language about the environmental and cost benefits of building “green.”

Dr. Languell serves in leadership roles with many non-profit organizations that are involved with green building and sustainability. She is the Past President/Vice President of the Florida Green Building Coalition, a LEED Accredited Professional for the USGBC, a Class 1 Certified Energy Rater, a NAHB Verifier and Certified Green Professional, and a Certifying Agent with the Florida Green Building Coalition she currently is serving as a board member for Babcock Neighborhood Schools, which is the first project to achieve the new pilot program for Green Globes.

PROJECT HIGHLIGHTS

Progresso Point
Fort Lauderdale, FL
76 units, Affordable Housing Midrise
FGBC Certified

Babcock Neighborhood School
Babcock Ranch, FL
43,000 SF K-8 Phase 1
Green Globes Certified

Banyan Grove
Stock Island, FL
48 Units, Affordable Housing Quads
FGBC Platinum

Grande Living
Lakewood Ranch, FL
524,286 SF Assisted Living and
Memory Care Facility
FGBC Platinum

Warley Park
Sanford, FL
81 Units, Affordable Housing LowRise
FGBC Gold
NGBS Certification

Poinciana Royale
Key West, FL
50 units, Affordable Housing LowRise
FGBC Platinum

Coral Reef
Miami, FL
408 Units, Market Rate, Multi-Family
LowRise

City Place Doral
Doral, FL
1,274,154 Mixed Use retail and
MidRise Residential Project

Trifecta Construction Solutions

17893 Wayside Bend
Babcock Ranch FL, 33982
p: 239.229.3177
e: Jennifer@trifectaconstruction.com
w: trifectaconstruction.com

EDUCATION

University of Florida

Doctor of Philosophy

Civil Engineering – Specialty, Sustainable
Development and Green Building

QUALIFICATIONS

25 Years of experience

18 Years as the owner of Trifecta Construction
Solutions

CERTIFICATIONS



Florida Energy Rater #593
Certified Residential Contractor
License # CRC122049

7. QUALIFICATIONS

- TEAM EXPERIENCE AND HISTORY
- GOVERNMENTAL PROJECT EXPERIENCE SUMMARY
- OTHER PROJECT EXPERIENCE SUMMARY
- CITY OF KEY WEST DEVELOPMENT REVIEW PROCESS EXPERIENCE
- AWARDS AND RECOGNITION
- LEED CREDENTIALS OF TEAM

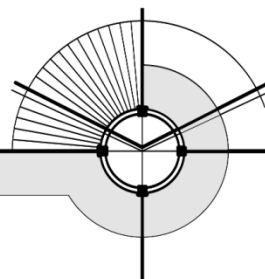

TEAM EXPERIENCE AND HISTORY

WILLIAM P. HORN ARCHITECT, P.A. and our team members are mostly a local team that specializes in working with local government agencies on their annual contract projects for architectural services.

We have had an annual contract with the City of Key West, Monroe County and the School Board for many years. We have also recently received an annual contract with the Key West Housing Authority and the City of Marathon.

Included in this section is a long list of successful projects completed under all of our annual contracts.

William P. Horn Architect, P.A. has also, within the last 29 years, completed many different types of projects (see list of projects within this section). We can offer this experience to the City.

Our team is very experienced in the City's approval process for projects within the Planning Department, HARC, Tree Commission or the Building Department.

William P. Horn has received numerous awards and recognitions and most of our team has LEED credentials.

Team Experience / History Summary:

William P. Horn Architect P.A. has worked with the following team Consultants for the length of time noted below :

MEP Engineer:	29 years
Civil Engineer:	20 years
Structural Engineer:	12 years
Planner:	17 years
Landscape Architect:	20 years
Sustainability Consultant:	10 years



Bernstein Park



North Key Largo Fire Station



Conch Key Fire Station



Roosevelt Sands Housing

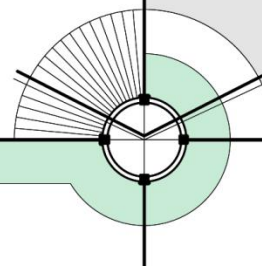

TEAM EXPERIENCE WORKING SUCCESSFULLY TOGETHER

WILLIAM P. HORN ARCHITECT, P.A. and his team members have worked together on many projects over the last 29 years.

MEP ENGINEERING: INNOVATIVE ENGINEERING GROUP, INC.

Innovative engineering group has been our MEP engineer on almost all of our projects for the last 29 years. They were the MEP engineer on Roosevelt Sands Housing and Community Center, Catholic Charities Workforce housing and Commons Building, 725 Duval street mixed use project, Seven Fish Restaurant and Bernstein Park/Community Center, Kots Homeless Shelter and Garden View Workforce Housing project.

CIVIL ENGINEERING: PEREZ ENGINEERING & DEVELOPMENT, INC.

Perez Engineering & Development has been our civil engineer on over 50 projects over the last 20 years. They were the civil engineers on Roosevelt Sands Housing project, Catholic Charities Workforce Housing project, 725 Duval street Mixed Use Housing project, Bernstein Park/Community Center, Kots Homeless Shelter and Garden View Workforce Housing project.

PLANNING: TREPANIER & ASSOCIATES, INC.

Trepanier & Associates has worked with us as a planner on over 30 projects over the last 17 years. They were the planners on Roosevelt Sands Affordable Housing. 725 Duval Street mixed use project, Dockmaster Building, Seven Fish Restaurant, Kots Homeless Shelter and Garden View Workforce Housing project.

STRUCTURAL ENGINEERING: KEISTER WEBB STRUCTURAL ENGINEERS, LLC

Keister Webb Structural Engineers has worked on over 12 projects with us over the last 12 years. They are presently working with us on Kots Homeless Shelter and MCSO Generator and Mark Keister was the Principal Engineer on Garden View and the Gym Renovations.

LANDSCAPE ARCHITECT: LANDWISE DESIGN, INC.

Landwise Design has been our Landscape Architect on over 15 projects over the last 20 years. They were the landscape architects on Catholic Charities workforce housing project, 725 Duval Street mixed use project, Henderson building mixed use project, Coral Hammock Housing and Community Center, Bernstein Park/Community Center, Kots Homeless Shelter and Garden View Workforce Housing project.

SUSTAINABILITY CONSULTANT: TRIFECTA CONSTRUCTION SOLUTIONS

Trifecta construction solutions has been our FGBC sustainability consultant since we started working on projects requiring FGBC certification. They were the sustainability consultants on Catholic Charities Workforce Housing Project and Common Buildings. 725 Duval Street mixed use project, Old Gym Renovations, Dockmaster Building, Bernstein Park/Community Center, Kots Homeless Shelter and Garden View Workforce Housing project.



Seven Fish Restaurant



Glynn Archer Gym



Camp Sawyer



Saint Bede's Workforce Housing

WILLIAM P. HORN ARCHITECT, PA.

915 EATON ST., KEY WEST, FL. 33040 TEL. 305-296-8302

WPHORNARCHITECT.COM

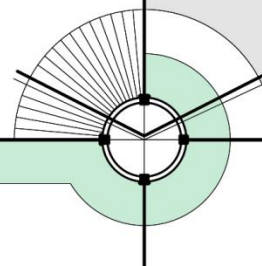

GOVERNMENTAL PROJECTS SUMMARY

WILLIAM P. HORN ARCHITECT, P.A. has worked with numerous government agencies on a variety of projects. The following list is a summary of local government agency's we are working with or have worked with.

MONROE COUNTY

- Key West Airport Fire Rescue Station.
- National Weather Station office relocation at airport.
- North Key Largo Fire Station.
- Big Pine Key Fire Station.
- Conch Key Fire Station.
- Stock Island Fire Station.
- Bernstein Park.
- Annual contract for architectural services from 1998-2003 and 2009 to present
 - West Martello Towers
new restroom facility for the West Martello Towers.
 - Government Center 63rd Street-roof Repairs:
Work included providing a new 4-ply built up flat roof in its entirety on an existing masonry building, spalling repairs, painting of exterior & interior, and minor hung ceiling revisions.
 - Marathon Library
Work included major concrete spalling repairs, stucco work, and exterior painting.
 - Islamorada Library
Work included a new metal roof over the original metal structure to the rear of the original library, and flashing into adjacent buildings.
 - Marathon Courthouse Roof
Work includes re-roofing existing building.
 - Marathon Animal Shelter Roof
Work includes re-roofing existing building.
 - Higgs Beach Park-Master plan
 - Provide Master plan for 19 acre Beach/Park.
 - Phase one Playground and Volleyball courts.
 - Fitness trail.
 - Lester Building
 - New roofing
 - Crawl Key Fire Training Facility
New 5,000 S.F. one story building.
 - Ellis Building
Work includes renovations to the interior.



North Key Largo Fire Station



Stock Island Fire Station



Bernstein Park



Crawl Key Fire Training Facility



Higgs Beach Park - Master plan

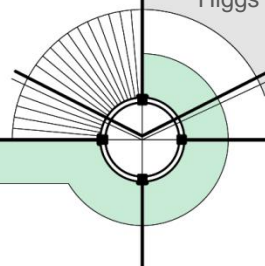

- Stock Island Jail Energy and Water Conservation Study
- Key West Library – Interior Renovations
- Public Works Temporary Relocation, Rockland Key
- New 2-story addition to jail, Stock Island

KEY WEST HOUSING AUTHORITY

- New 44 Unit Affordable Housing Project in Bahama Village, Roosevelt Sands Housing Project
- New 96 Unit Affordable Project in New Town, Roosevelt Gardens Housing Project
- New 18 Unit Affordable Housing Project in Stock Island, Palm Duplex
- Two story office addition, Kennedy Drive, Key West, Fl.
- Renovations to a historic 5 unit housing project, 629 Caroline Street, Key West, Fl.
- New 103 unit workforce housing project (Garden View Apartments), North Stock Island

CITY OF MARATHON

- New 5,000 S.F. Fire Station, Grassy Key, Florida
- Master Plan for Boot Key Harbor Marina, Marathon, Fl.
- New 14,000 S.F. City Hall, Marathon.

CITY OF KEY WEST

- Caroline Street Corridor Roadway improvements
- Bight Retail Shop, Margaret Street Plaza, Key West, Fl.
- Annual contract for architectural services from 2012 to 2017:
 - New Dockmaster Office and transient restroom facility.
 - Police Department Building window Replacement and new roof.
 - Historic Seaport Common Area enhancement plan.
 - Historic Seaport Restroom renovations
 - Building 103 (Truman Annex), existing building analysis.
 - Ice House Building, structural repair analysis and roof replacement/ spalling repair.
 - Mallory Square restroom, renovations/ plumbing replacement.
 - Martin Luther King Community Center roof replacement, solar system design.
 - New homeless shelter (KOTS), North Stock Island
 - Building Hardening Projects

MOSQUITO CONTROL DISTRICT OF THE FLORIDA KEYS

- New Office and Garage/Storage Facility in Big Coppitt Key, Florida.



Roosevelt Sands Housing



Roosevelt Gardens Housing



Grassy Key Fire Station



Marathon City Hall



Dockmaster

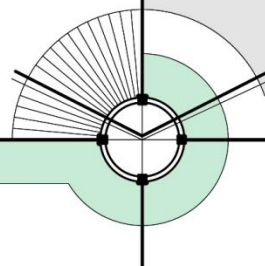

MONROE COUNTY SCHOOL DISTRICT

•Annual contract for architectural services from 2002 to 2010 and from 2016 to present (Lower and Upper Keys)

Worked on a variety of projects, including classroom and office modifications, handicap compliance, restroom facilities, historic structure reports, window replacements, covered walkways, parking lot layouts and ball field design and layouts.

Previous work includes work on:

- Poinciana Elementary School – new soccer fields and pavilion.
- Sugarloaf Elementary School – New athletic fields.
- Rex Weech Field - New restroom building.
- Poinciana Elementary School – Entry covered walkway.
- Key West High School - Renovations and additions to weight room building.
- Harris School - Historic Structures Report
- H.O.B. Middle School - Parking lot re-design and covered walkways
- Glynn Archer Elementary School - Courtyard re-design.
- Gerald Adams Elementary School - Covered walkway addition.
- Sugarloaf Elementary School - Toilet revisions & covered walkway addition.
- Plantation Key - Maintenance Facility concept design.
- Marathon High School - Parking/drive re-design study.
- Switlik Elementary School - Toilet revisions & media room renovation.
- May Sands, Reynolds and Glynn Archer Schools - Door and window replacement
- Big Pine Academy Lower Level Classroom Renovation
- Key West High School New Corridor



HOB Entry/Drop off and parking

WILLIAM P. HORN ARCHITECT, PA.

915 EATON ST., KEY WEST, FL. 33040 TEL. 305-296-8302



Rex Weech Field Restroom and Concessions



Poinciana Elementary School Entry Revisions

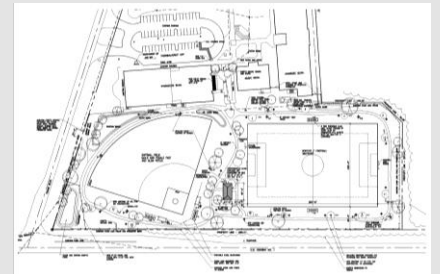

Sugarloaf Elementary School-Site Improvements



May Sands School Window/Door Replacements



Sugarloaf Elementary School New Athletic fields

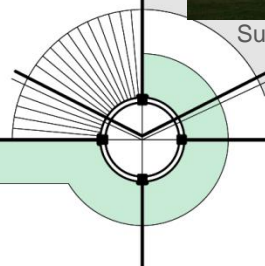

WILLIAM P. HORN ARCHITECT, P.A. has completed a variety of commercial, mix use and residential projects. Work has included both new projects and renovations of existing buildings. Projects have been as small as a commercial store front renovation or small house addition to large 80,000 S.F. commercial buildings or 96 unit housing projects. Below is a partial list of project types.

RETAIL PROJECTS

- Strunk Ace Hardware Store, 1101 Eaton Street
- Crazy Shirts, corner of Duval and Greene Street
- Walgreens (Old Strand Theatre), Duval Street
- Divers Direct, Simonton Street

OFFICE PROJECTS

- Key West Chamber of Commerce, Old City Hall
- National Weather Service, Key West Airport
- Island City Flying Service, Key West Airport
- Mosquito Control, Big Coppitt Key
- Marathon City Hall

COMMUNITY CENTER PROJECTS

- Meridian West Affordable Housing Commons Building, Stock Island
- Roosevelt Sands Affordable Housing Commons Building, Bahama Village
- Visitor/Nature Center, Higgs Beach
- Boy Scouts of America, Summerland Key
- Bernstein Park – new community center

RESTROOM PROJECTS

- West Martello Restrooms
- Boyscout toilet/shower building, Summerland Key
- Sugarloaf School Ballfield Restrooms
- Rex Weech Field Restroom Facility
- Bernstein Park Restroom Facility, Stock Island

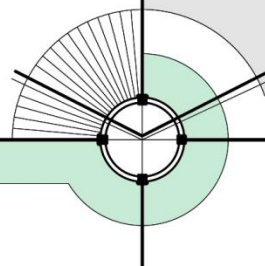

RESTAURANT PROJECTS

- Hardrock Café, Duval Street
- Finnigan’s Wake, Grinnell and James Street
- Chili’s Restaurant, North Roosevelt Blvd.
- Waterfront Brewery Restaurant, William Street
- Seven Fish, Truman Avenue

STORAGE/MAINTENANCE PROJECTS

- FKAAs Maintenance Facility, Rockland Key
- Boyd’s Campground Maintenance Facility, Stock Island
- Manley DeBoer Lumberyard

HISTORIC PROJECTS

- Old Stone Church, Simonton and Eaton Street roof repair, waterproofing, new doors
- Armory Building, White and Southard Street Office renovation, new stairs, air conditioning, exterior restoration
- Lewinsky Building, Duval Street Complete interior and exterior restoration
- Old Strand Theatre (Walgreens Retail Store), Duval Street Complete interior and exterior restoration, 2 new affordable housing units
- West Martello Towers, Higgs Beach Structural stabilization, brick re-pointing, new roof

MIXED USE PROJECTS

- Simonton Row, Simonton and Greene Street Housing, retail, office, vehicle maintenance and storage
- Handprint Fabric’s, Simonton and Day Street Housing, retail, office, warehouse
- Staples Avenue mixed use building Housing, office, retail, conch train storage

RESIDENTIAL PROJECTS

- Coral Hammock (55 new units) Stock Island
- 5 new residences at Sunset Key Island
- Multiple affordable housing projects see Key West Housing Authority work)
- Multiple single Family renovations, new construction and additions

(see website: www.wphornarchitect.com)

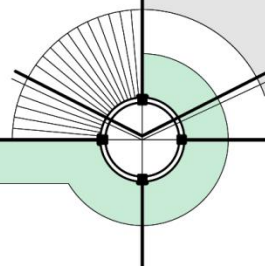

CITY OF KEY WEST DEVELOPMENT REVIEW PROCESS

WILLIAM P. HORN ARCHITECT, P.A. and his team members have a lot of experience with the City of Key West development review process. The team has been getting projects successfully approved for the last 25 years within Key West and Monroe County. We are very familiar with obtaining variances, Planning Board approvals, City Commission approvals, HARC approvals and Tree Commission approvals.

Owen Trepanier, our Planner for this project, was a planner for the City prior to starting his own Key West planning business. He is now one of the most experienced planner in Key West and Monroe County.

The Following is a partial list of some of our project approvals:

- KOTS Homeless Shelter
- DRC, Planning Board, Tree Commission, City Commission
- Garden View Workforce Housing
- DRC, Planning Board, Tree Commission, City Commission
- Roosevelt Sands Jr. Housing Complex & Community Center
44 unit Affordable Housing project in Key West for the Key West Housing Authority
- HARC, Tree Commission, DRC, Planning Board and City Commission
- Roosevelt Gardens
96 unit Affordable Housing project in Key West for the Key West Housing Authority
- DRC, Planning Board, City Commission and Tree Commission
- Catholic Charities
37 unit workforce Housing project with Commons Building in Key West
- DRC, Planning Board, City Commission, Tree Commission and Bpass
- 725 Duval Street Mixed Use Project
- HARC, DRC, Planning Board, City Commission and Bpass
- Dockmaster Building
- DRC, Planning Board and Tree Commission
- Old Gymnasium Building
- HARC
- Higgs Beach / Park Master Plan & Visitor / Nature Center
- DRC, Planning Board, City Commission and Tree Commission
- Seven Fish Restaurant
- HARC, DRC, Planning Board, City Commission, Tree Commission
- Strunk
- HARC, DRC, Planning Board, City Commission, Tree Commission



KOTS



Roosevelt Sands



Glynn Archer Gym



Saint Bede's Workforce Housing



Seven Fish Restaurant

WILLIAM P. HORN ARCHITECT, PA.

915 EATON ST., KEY WEST, FL. 33040 TEL. 305-296-8302

WPHORNARCHITECT.COM

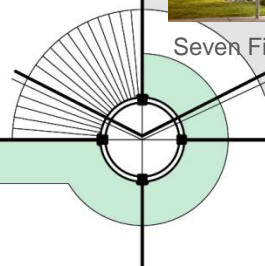

Awards and recognitions

Bill Horn has been repeatedly recognized by The Historic Florida Keys Foundation for the high quality of his design work in Key West's Old Town. The following is a partial list of awards presented to William P. Horn Architect, P.A.

Rehabilitation/New Construction of 1218 Duval Street, Key West, Florida

- Award of Excellence, 2022, The Historic Florida Keys Foundation

New Construction at 921 Truman Ave. New Seven Fish Restaurant, Key West, Florida

- Award of Excellence, 2017, The Historic Florida Keys Foundation

Green Achievement Award, Stock Island Fire Station, Florida

- FGBC Certified Green Commercial Building Highest Score, 2016

New Construction at 611 Truman Ave, Key West, Florida

- Award of Excellence, 2010, The Historic Florida Keys Foundation

Rehabilitation of 805-807 Truman Avenue, Key West, Florida

- Award of Excellence, 2008, The Historic Florida Keys Foundation

Rehabilitation of 800 Simonton Street, Key West, Florida

- Award of Excellence, 2008, The Historic Florida Keys Foundation

New Construction at 201 Virginia Street, Key West, Florida

- Award of Excellence, 2006, The Historic Florida Keys Foundation

Rehabilitation / New Construction of 120 Simonton Street, Key West, Florida

- Award of Excellence, 2003, The Historic Florida Keys Foundation

Rehabilitation of 829 Simonton Street, Key West, Florida

- Award of Excellence, 2003, The Historic Florida Keys Foundation

Rehabilitation of 314 Duval Street, Key West, Florida

- Award of Excellence, 2002, The Historic Florida Keys Foundation

New Construction at 1101 Eaton Street, Key West, Florida

- Award of Excellence, 2002 The Historic Florida Keys Foundation

Rehabilitation of 907 Frances Street, Key West, Florida

- Award of Excellence, 2002, The Historic Florida Keys Foundation

Façade Rehabilitation of the Lewinsky Building, Key West, Florida

- Award of Excellence, 1999, The Historic Florida Keys Foundation

New Construction at 201 Simonton Street, Key West, Florida

- Award of Excellence, 1999 The Historic Florida Keys Foundation

New Construction at 724 Eaton Street, Key West, Florida

- Award of Excellence, 1997 The Historic Florida Keys Foundation

Rehabilitation of 723 Catherine Street, Key West, Florida

- Award of Excellence, 1997, The Historic Florida Keys Foundation

Rehabilitation of 1205 -1207 Olivia Street, Key West, Florida

- Award of Excellence, 1996, The Historic Florida Keys Foundation



Seven Fish Restaurant



Stock Island Fire Station



Truman Hotel, 611 Truman Avenue



Simonton Row, 120 Simonton St.



Strunk ACE Hardware, 1101 Eaton St.

WILLIAM P. HORN ARCHITECT, PA.

915 EATON ST., KEY WEST, FL. 33040 TEL. 305-296-8302

WPHORNARCHITECT.COM

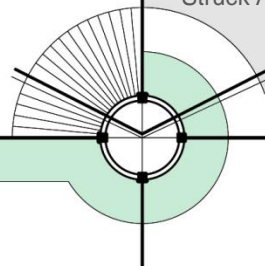

LEED CREDENTIALS OF TEAM

WILLIAM P. HORN ARCHITECT, P.A.

The firm is a National Member of USGBC.
 William P. Horn, R.A. is a LEED AP BD+C and is a member and past Chair of the Keys Branch of the USGBC, Florida Chapter.
 Evelia Medina is a LEED AP BD+C.
 Joanna Walczak is a LEED Green Associate.

Innovative Engineering Group, Inc.
 Sudhir Gupta, PE is a LEED BD+C.

Keister Webb Structural Engineers LLC
 Laney S. Stoddard, PE is a LEED AP

Trifecta Construction Solutions
 Dr Jennifer Languell, PhD is Accredited Professional for the USGBC, Class 1 Certified Energy Rater, NAHB Verifier and a certified Green Professional and a Certifying Agent with the Florida Green Building Coalition (and past President of FGBC).

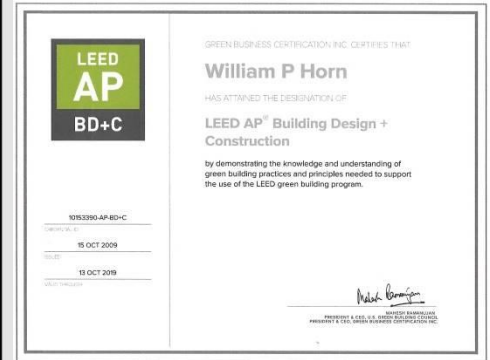
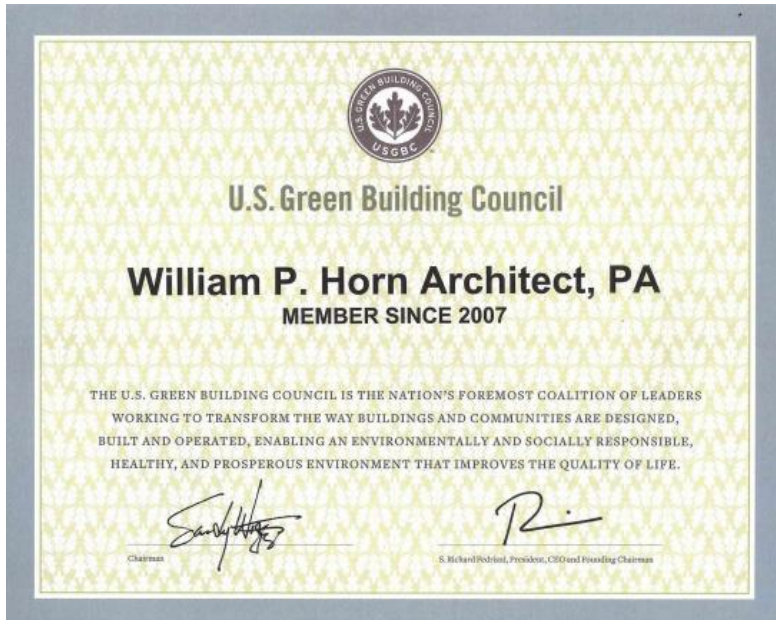

WILLIAM P. HORN ARCHITECT, PA.

915 EATON ST., KEY WEST, FL. 33040 TEL. 305-296-8302

WPHORNARCHITECT.COM

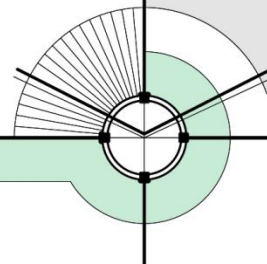

8. REPRESENTATIVE ARCHITECTURAL EXPERIENCE AND CLIENT REFERENCE

- PROJECT SPECIFIC EXPERIENCE
- REFERENCES

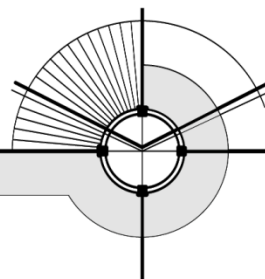



TRANSIENT RESTROOMS / DOCKMASTER OFFICES

Project Scope

New 3,300 S.F. One story office & restroom facility. Work includes revising main parking lot, new road entryway.

Scope of Services:

Complete architectural/Engineering (Design, Construction Documents, Bidding and Construction Supervision).

**Dockmaster Offices
Transient Restrooms and
Site Revisions**

City Marina
Garrison Bight
1801 N. Roosevelt Blvd.
Key West, FL. 33040



Client

City of Key West

Contact

Karen Olsen
Deputy Director of Ports and Marina Services
201 William St.
Key West, FL. 33040
(305) 809-3803

Design Fee: \$103,704.00

Construction Cost: \$ 1,939,649.93

Final Completion Date: July 2019

Contractor: Pedro Falcon Contractors, Inc.

Key Personnel

- Principal Architect:
William P. Horn, R.A.
- Intern Architect:
Evelia Medina
- Civil Engineer:
Allen Perez, P.E.
- Structural Engineer:
Serge Mashtakov, P.E.
- MEP Engineer:
Sudhir Gupta, P.E.
- Planner:
Owen Trepanier
- Sustainability Consultant:
Jennifer Languell, Ph. D



WILLIAM P. HORN ARCHITECT, PA.

915 EATON ST., KEY WEST, FL. 33040 TEL. 305-296-8302

WPHORNARCHITECT.COM

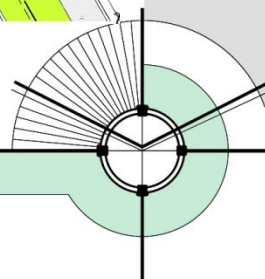



Glenn Archer Gym Renovations

1300 White Street
Key West, FL.

Client:
The City of Key West

Contact:
Steven McAlearney
Port and Marina Services Director
201 William Street
Key West, FL 33041
(305) 809-3792

Design Fee: \$115,174.00

Construction Cost: \$2,067,508.53

Completion Date: July 2019

Contractor:
Pedro Falcon Contractors, Inc.

Project Scope:

Exterior and interior renovations to a historic Gym Building behind Key West City Hall. Work includes re-roofing, new windows and doors, concrete spalling repair, new floors, mezzanine, new restroom and showers, new a/c, electric and plumbing.

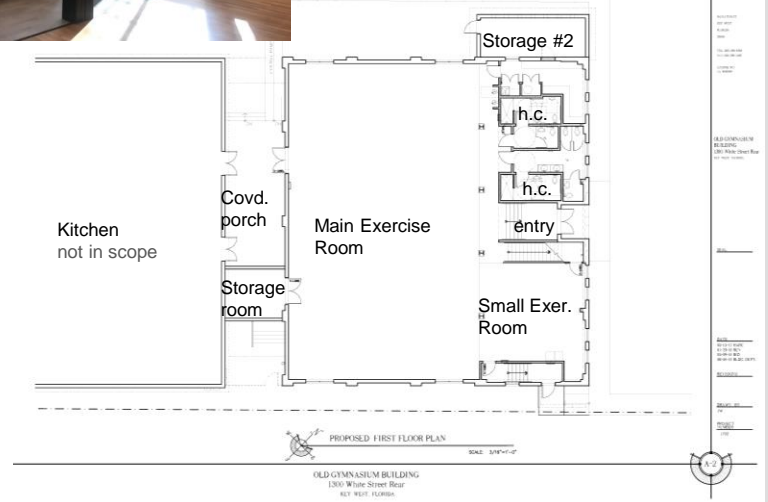
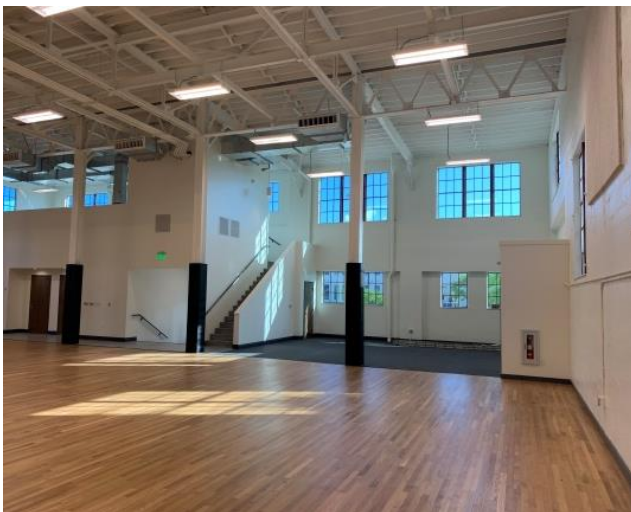

Key Personnel

- Principal Architect:**
William P. Horn, R.A.
- Intern Architect:**
Joanna Walczak
- Civil Engineer:**
Allen Perez, P.E.
- Structural Engineer:**
Mark Keister
- MEP Engineer:**
Don Austin, P.E.
- Sustainability Consultant:**
Jennifer Languell, Ph. D

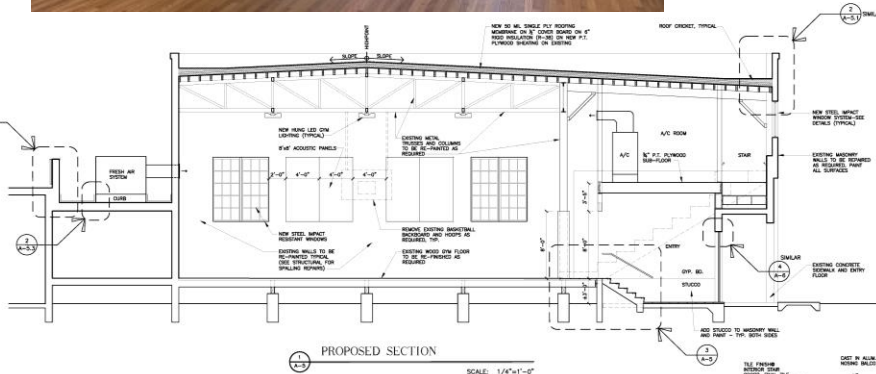

WILLIAM P. HORN ARCHITECT, PA.

915 EATON ST., KEY WEST, FL. 33040 TEL. 305-296-8302

WPHORNARCHITECT.COM

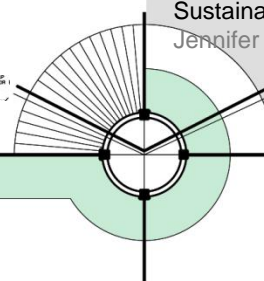



Roosevelt Sands Jr. Housing Complex & Club House

Key West, FL.



CLUBHOUSE

Client

Key West Housing Authority

Contact

Randy Sterling
Executive Director
1400 Kennedy Drive
Key West, FL 33040
(305) 296-5621

Completion Date: 2012

Scope of Services:

Complete architectural/Engineering (Design, Construction Documents, Bidding and Construction Supervision).

Key Personnel:

Principal Architect: William P. Horn, R.A.
Intern Architect: Evelia Medina
MEP Engineer: Sudhir Gupta, P.E.
Civil Engineer: Allen Perez, P.E.
Structural Engineer: Paul Semmes, P.E.

Design Fee:

\$247,000.00 (Architectural and Engineering)

Construction Award: \$4,060,108.00

Contractor:

Siltek Group, Inc.
Mike Marti, Project Manager
1232 North University Dr.
Plantation, FL 33322
Phone: 954-370-1368

Project has all Residential Units receiving Energy Star Certification. A/C system is 20% more efficient than typical systems, Energy Star rated doors, windows, appliances, light fixtures, hot water heater and A/C system.



WILLIAM P. HORN ARCHITECT, PA.

915 EATON ST., KEY WEST, FL. 33040 TEL. 305-296-8302

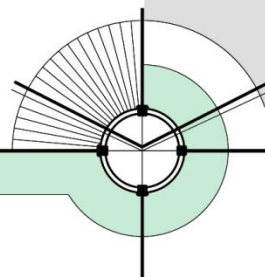

WPHORNARCHITECT.COM

Monroe County Fire Station No.8

Stock Island, FL.



Client

Monroe County

Contact

Kevin Wilson, Assistant County Administrator
1100 Simonton St.
Key West, FL. 33040
(305) 797-1547

Scope of Services: Complete architectural/Engineering (Design, Construction Documents, Bidding and Construction Supervision).

Design Fee: \$185,364.00

Construction Costs: \$3,241,396.47

Contractor: Burke Construction Group, Inc.

Key Personnel:

Principal Architect:

William P. Horn, R.A.

Project Architect:

Frank Herdliska, R.A.

Intern Architect:

Evelia Medina

Structural Engineer:

Thomas Timmins, P.E.

MEP Engineer:

Sudhir Gupta, P.E.

Civil Engineer:

Allen Perez, P.E.

Landscape Architect:

Liz Newland

Sustainability Consultant:

Jennifer Languell, Ph. D



PERSPECTIVE VIEW

Project Scope

New 8,350 S.F. two story Fire Station located in Stock Island, FL. Project is registered to be Florida Green Building Coalition (FCBC) certified.

It will be Monroe County's first Green Certified Building.



Sustainable features

Cisterns to collect roof rainwater run off for Irrigation use. Energy efficient building envelope to reduce energy use. Low flow plumbing fixtures. Low VOC paints & sealants. Native landscaping.

WILLIAM P. HORN ARCHITECT, PA.

915 EATON ST., KEY WEST, FL. 33040 TEL. 305-296-8302

WPHORNARCHITECT.COM

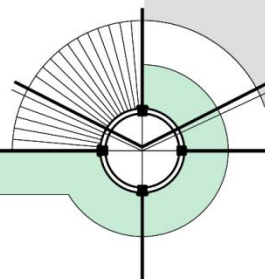



Rendering

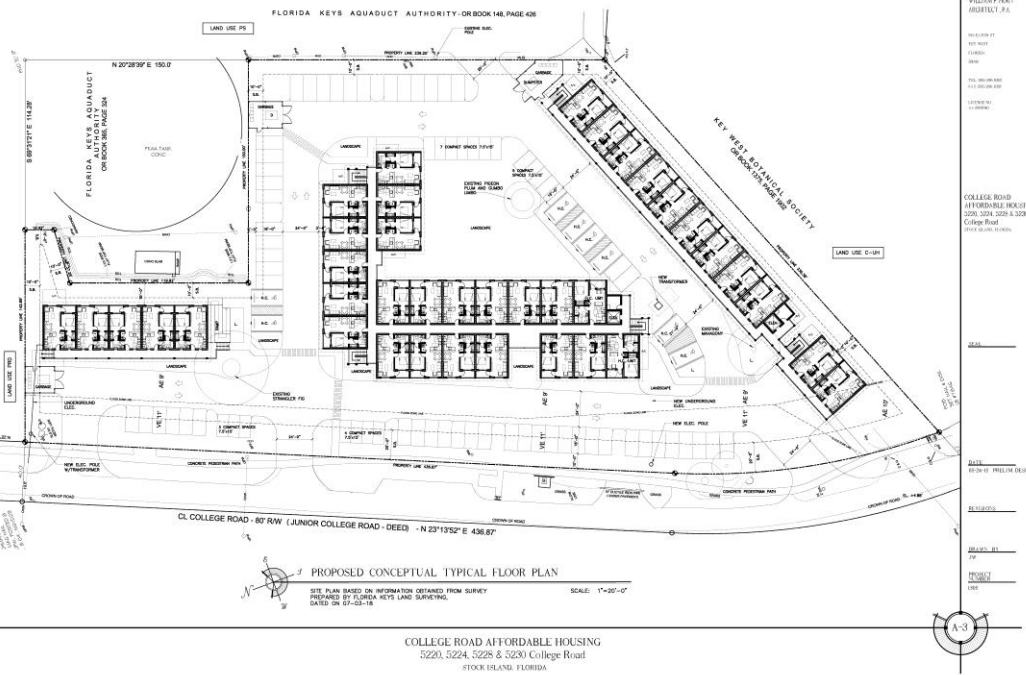

Rendering

Garden View Apartments

5220, 5224, 5228 & 5230 College Road
Stock Island, Florida

Client:

City of Key West and the Housing Authority of the City of Key West

Contact:

Steven McAlearney
Port and Marina Services Director
201 William Street
Key West, FL 33041
(305) 809-3792

Design Fee: \$30,400.00 (Design Study)

Project Scope:

Under our annual contract we designed a conceptual plan and rendering of fitting in 104 Housing Units within the site. After we did this we were awarded the RFQ to complete the project.

Scope of Services:

Architectural and Engineering services.

Key Personnel

Principal Architect:

William P. Horn, R.A.

Project Architects:

Frank Herdliska, R.A.

Joshep Scarpelli R.A.

Intern Architect:

Evelia Medina

Civil Engineer :

Allen Perez, P.E.

MEP Engineer:

Sudhir Gupta, P.E.

Structural Engineer:

Mark Keister

Landscape Architect:

Ladd Roberts, RLA

Sustainability Consultant:

Jennifer Languell

WILLIAM P. HORN ARCHITECT, PA.

915 EATON ST., KEY WEST, FL. 33040 TEL. 305-296-8302

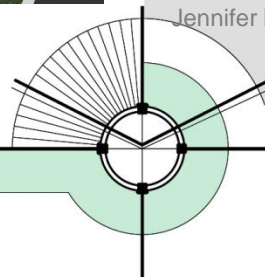

WPHORNARCHITECT.COM

Key West Police Station

1600 N. Roosevelt Blvd.
Key West, FL 33040



Client:

City of Key West

Contact:

Doug Bradshaw,
Project Manager
3140 Flagler Avenue
Key West, FL 33040
(305) 809-3792

Completion Date: Est. May 2014

Key Personnel:

Principal Architect:
William P. Horn, R.A.
Project Architect:
Frank Herdliska, R.A.
Structural Engineer:
Garland Wilson, P.E.

Design Fee: \$9,710.00

Construction Award: \$261,029.00

Contractor:

E.L.C.I. Construction Group, Inc.
Moises Bichadchi
626 NE 124th Street
North Miami, FL 33161
(305) 891-7990

Project Scope:

Replaced all exterior windows to prevent water intrusion.

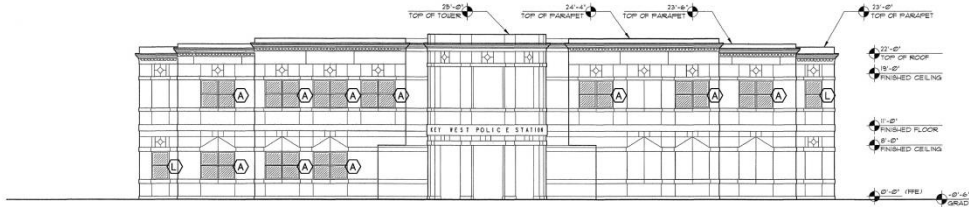

1 FRONT ELEVATION (NORTH WEST)
SCALE: 1/8" = 1'-0"

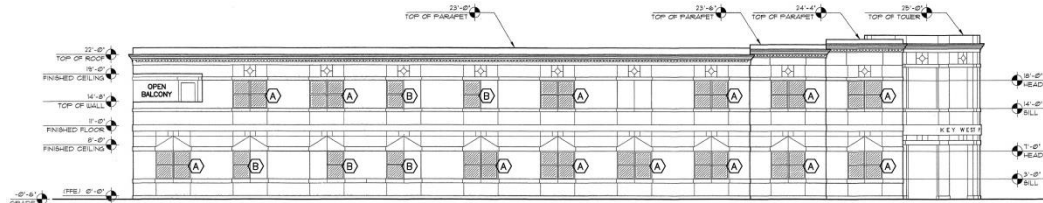

2 SIDE ELEVATION (NORTH EAST)
SCALE: 1/8" = 1'-0"

Project Scope

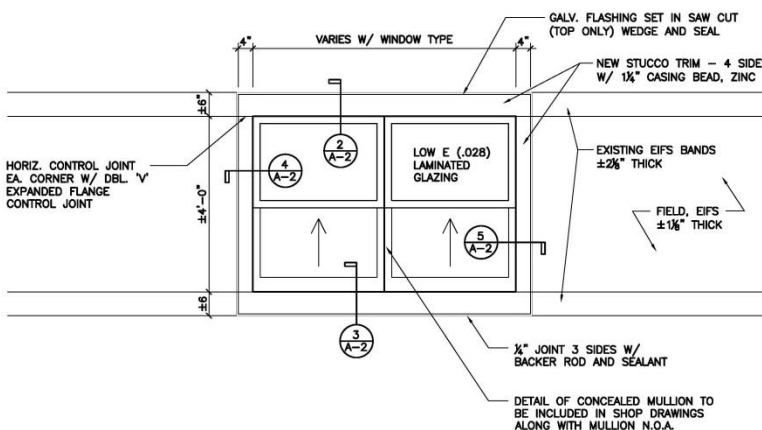

5 WINDOW ELEVATION
SCALE: 1/2" = 1'-0"

WILLIAM P. HORN ARCHITECT, PA.

915 EATON ST., KEY WEST, FL. 33040 TEL. 305-296-8302

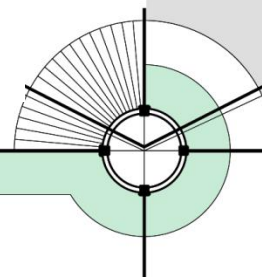

WPHORNARCHITECT.COM

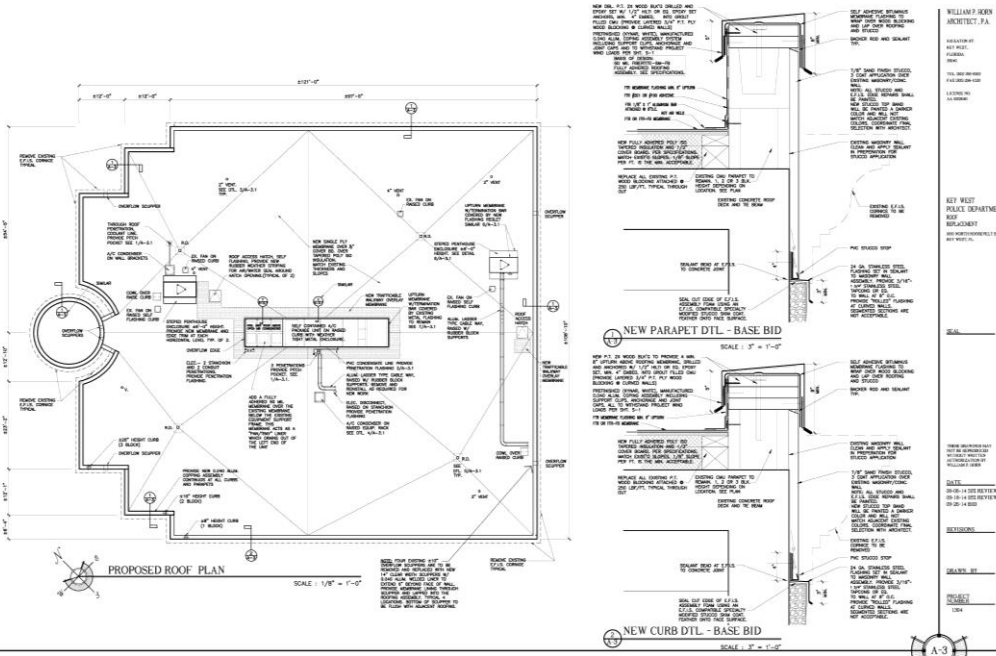

KEY WEST POLICE DEPARTMENT - ROOF REPLACEMENT
KEY WEST, FLORIDA

POLICE STATION ROOF PLAN AND DETAILS

Key West Police Station – Roof Replacement
1600 N. Roosevelt Blvd.
Key West, FL 33040



Client:
City of Key West

Contact:
Janet Muccino,
Project Manager
3140 Flagler Avenue
Key West, FL 33040
(305) 809-3867

Completion Date: 2015

Key Personnel:
Principal Architect:
William P. Horn, R.A.
Project Architect:
Frank Herdliska, R.A.
Structural Engineer:
Tom Timmins, P.E.

Design Fee: \$38,775.00
Construction Award: \$194,437.00

Contractor:
E.L.C.I. Construction Group, Inc.
Moises Bichadchi
626 NE 124th Street
North Miami, FL. 33161
(305) 891-7990

Project Scope:
Roof replacement.

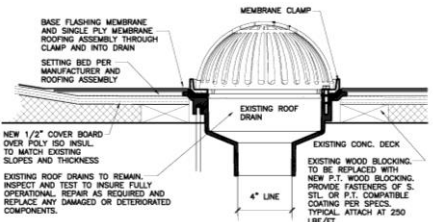

ROOF DRAIN DTL.
SCALE: 3" = 1'-0"

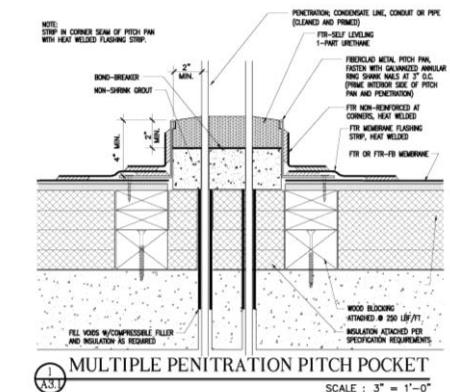

MULTIPLE PENETRATION PITCH POCKET
SCALE: 3" = 1'-0"

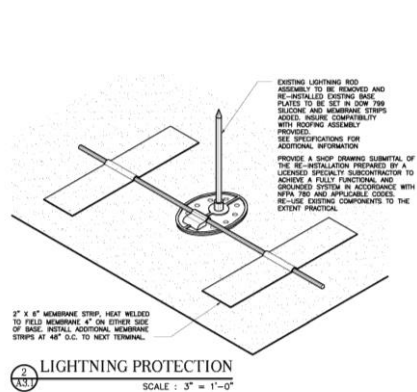

LIGHTNING PROTECTION
SCALE: 3" = 1'-0"

WILLIAM P. HORN ARCHITECT, PA.

915 EATON ST., KEY WEST, FL. 33040 TEL. 305-296-8302

WPHORNARCHITECT.COM

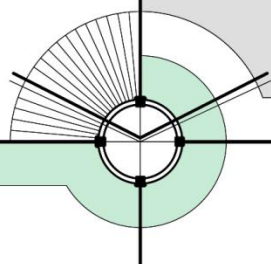



COMMUNITY CENTER

Project Scope:

Project included Master Planning a 6.6 acre site in Stock Island into a multi-use Public Park. Buildings included a 11,231 S.F. Community Center (with meeting rooms, offices, restrooms, food service and storage areas) and a 1,047 S.F. Maintenance Building.



INTERIOR PHOTO



COMMUNITY CENTER

Bernstein Park and Community Center

Stock Island, FL.



Client:

Monroe County

Contact:

Kevin Wilson, Assistant County Administrator
1100 Simonton Street
Key West, FL 33040
(305) 797-1547

Design Fee: \$531,946.00

Construction Costs: \$7,858,081.37

Contractor: Burke Construction Group, Inc.



INTERIOR PHOTO

Key Personnel :

Principal Architect:

William P. Horn, R.A.

Project Architect:

Frank Herdliska, R.A.

Intern Architect:

Kristen Argalas

MEP Engineer:

Sudhir Gupta, P.E.

Civil Engineer:

Allen Perez, P.E.

Landscape Engineer:

Ladd Roberts

Sustainability Consultant:

Jennifer Languell Ph. D.

WILLIAM P. HORN ARCHITECT, PA.

915 EATON ST., KEY WEST, FL. 33040 TEL. 305-296-8302

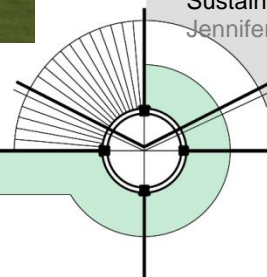

WPHORNARCHITECT.COM

Higgs Beach / Park Master Plan / Visitor Nature Center

Stock Island, FL.



Client:

Monroe County

Contact

Kevin Wilson, Division Director
Public Work and Engineering.
1100 Simonton St.
Key West, Fl. 33040
(305) 797-1547

Design Fee: \$121,500.00 (Master Plan & Planning approvals)

Cost Estimates: \$6,000,000.00

Contractor: N/A



HIGGS BEACH PARK – MASTER PLAN

Project Scope:

- Provided master planning services for a 17 acre oceanfront property including new playground, fitness trail, dog park, volley ball and pickle ball courts.
- Designed new 1,800 SQ. FT. Visitor/Nature center as part of the overseas heritage trail
- Building design to be able to be LEED or FGBC Silver or Gold Certified (depending on funding)



VISITOR NATURE CENTER 1,800 S.F.



VISITOR NATURE CENTER 1,800 S.F.

Key Personnel :

- Principal Architect:
William P. Horn, R.A.
- Project Architect:
Frank Herdliska, R.A.
- Intern Architect:
Evelia Medina
- Civil Engineer:
Allen Perez, P.E.
- Landscape Engineer:
Ladd Roberts
- Planner:
Barbara Mitchell

WILLIAM P. HORN ARCHITECT, PA.

915 EATON ST., KEY WEST, FL. 33040 TEL. 305-296-8302

WPHORNARCHITECT.COM

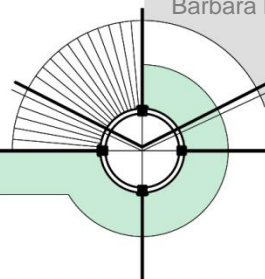



Higgs Beach – Playground Area Phase I

Clarence Higgs Beach,
Key West, FL

Client :

Monroe County

Contact

Kevin Wilson, Division Director
Public Work and Engineering.
1100 Simonton St.
Key West, FL 33040
(305) 797-1547

Design Fee: \$11,000.00

Construction Award: \$218,350.00

Contractor:

D.L. Porter Construction, Inc.
Vice-President: Marshall White
6574 Palmer Park Circle
Sarasota, FL 34238
(941) 929-9400

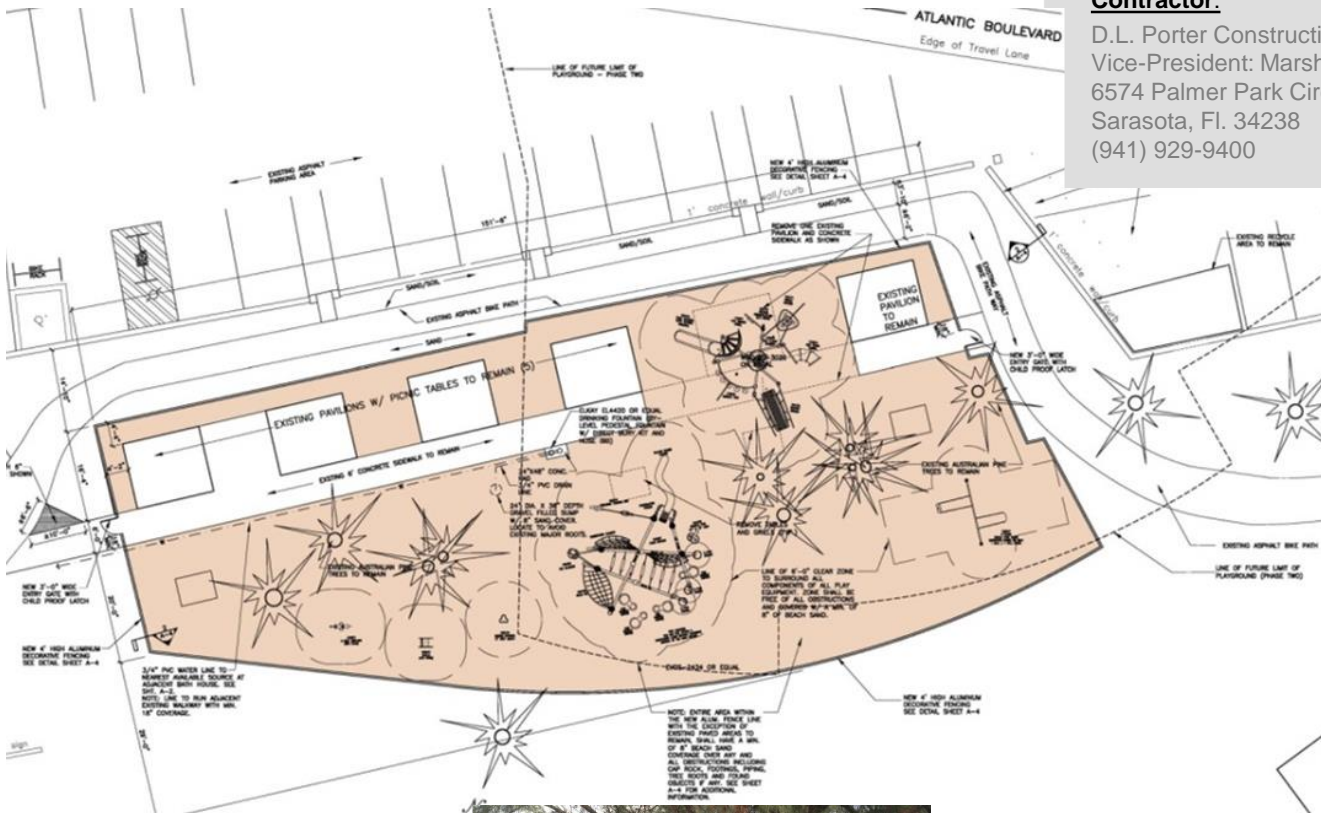

Project Scope:

Added beach front playground to beach side of road prior to road being moved to the north. Once road is moved the final playground will be created.



Key Personnel :

Principal Architect:
William P. Horn, R.A.
Project Architect:
Frank Herdliska, R.A.
Intern Architect:
Evelia Medina

WILLIAM P. HORN ARCHITECT, PA.

915 EATON ST., KEY WEST, FL. 33040 TEL. 305-296-8302

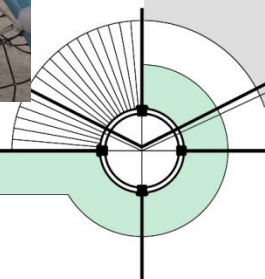

WPHORNARCHITECT.COM

West Martello Towers

New Brick Masonry Restroom Facility



Client :

Monroe County

Contact

Kevin Wilson, Division Director
Public Work and Engineering.
1100 Simonton St.
Key West, FL 33040
(305) 797-1547

Design Fee: \$12,311.50

Construction Award: \$159,865.00

Contractor:

D.L. Porter Construction, Inc.
Vice-President: Marshall White
6574 Palmer Park Circle
Sarasota, FL 34238
(941) 929-9400



Key Personnel :

Principal Architect:
William P. Horn, R.A.
Project Architect:
Frank Herdliska, R.A.
Intern Architect:
Evelia Medina
Structural Engineer:
Garland Wilson, P.E.

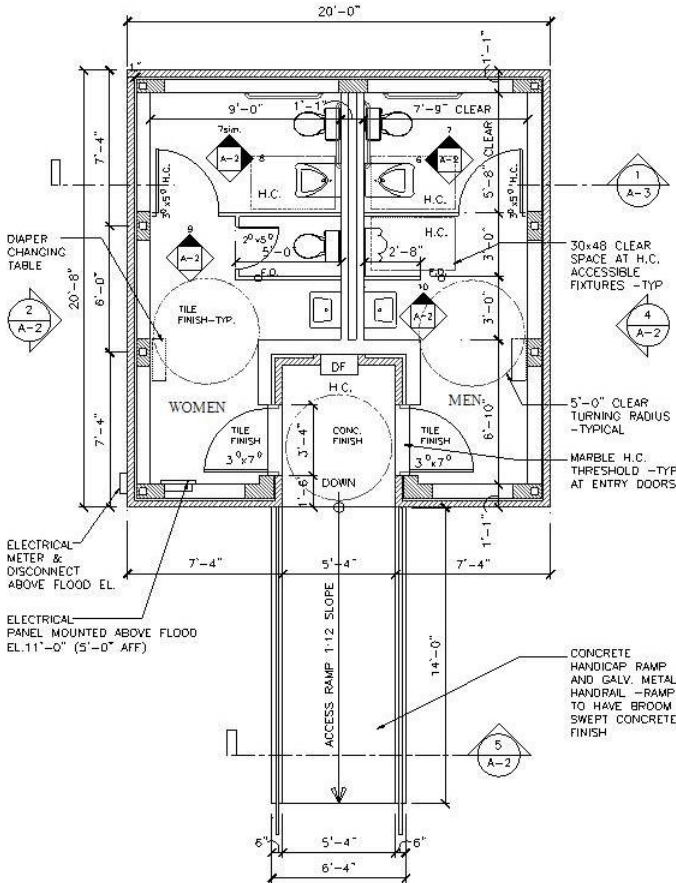

Work included re-roofing structure, and structure stabilization of vaults, arches, and brickwork.

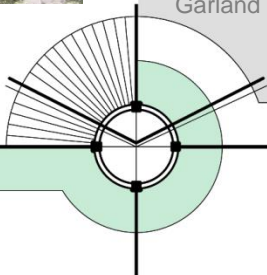

REFERENCES:

CITY OF KEY WEST

Steven McAlearney, Port and Marina Services Director (past Director of Engineering)
(305) 809-3792
201 William Street
Key West, FL 33040
Projects: Old Gymnasium Building Renovation, KOTS Homeless Shelter

Karen Olsen, Deputy Director of Ports and Marina Services
(305) 809-3803
200 William Street
Key West, FL 33040
Projects: Dock Master Building, Historic Seaport Restroom Renovations

MONROE COUNTY SCHOOL DISTRICT

Douglas Pryor, Facilities Planner
1310 United Street
Key West, FL 33040
(305) 293-1400, Ext. 53465
Projects: Big Pine Academy Classroom Renovations

FLORIDA KEYS MOSQUITO CONTROL DISTRICT

Andrea L. Leal, Executive Director
503 107TH Street Gulf
Marathon, FL 33050
(305) 292-7190
Projects: Mosquito Control Maintenance Building, Big Coppitt Key

KEY WEST HOUSING AUTHORITY OF THE CITY OF KEY WEST, FLORIDA

Randy Sterling, Executive Director
1400 Kennedy Drive
Key West, FL 33040
(305) 296-5621
Projects: 103 unit Garden View Workforce Housing (Under Construction)

MONROE COUNTY

Kevin Wilson, Assistant County Administrator
1100 Simonton St.
Key West, FL 33040
(305) 453-8797
Projects: Public Works Temporary Relocation to Rockland Key (Construction Just Completed), Jail Generator / Storage Building Addition, Bernstein Park and Community Center, Stock Island Fire Station

WILLIAM P. HORN ARCHITECT, PA.

915 EATON ST., KEY WEST, FL. 33040 TEL. 305-296-8302



Old Gymnasium Building Renovation



Dock Master Building



Big Pine Academy Classrooms



Mosquito Control Building



Garden View Workforce Housing

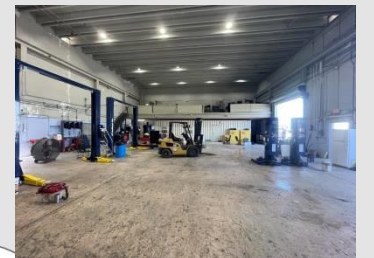

Public Works Temp. Relocation

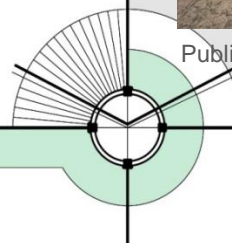

WILLIAMPHORNARCHITECTPA.COM

9. SWORN STATEMENTS AND AFFIDAVITS

- SWORN STATEMENTS AND AFFIDAVITS
- LICENSES
- INSURANCE

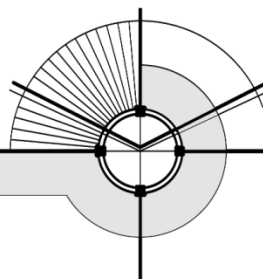

ANTI-KICKBACK AFFIDAVIT

STATE OF FLORIDA

SS:

COUNTY OF MONROE

I the undersigned hereby duly sworn, depose and say that no portion of the sum herein response will be paid to any employee of the City of Key West as a commission, kickback, reward or gift, directly or indirectly by me or any member of my firm or by an officer of the corporation.

BY: _____
WILLIAM P. HORN

sworn and prescribed before me this 29th day of Aug, 2022

NOTARY PUBLIC, State of Florida

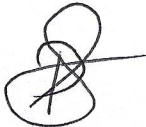

My commission expires: 11/22/25

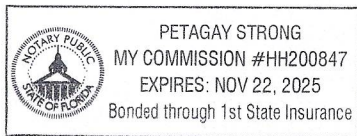

SWORN STATEMENT PURSUANT TO SECTION 287.133(3)(A)
FLORIDA STATUTES, ON PUBLIC ENTITY CRIMES

THIS FORM MUST BE SIGNED AND SWORN TO IN THE PRESENCE OF A NOTARY PUBLIC OR OTHER OFFICIAL AUTHORIZED TO ADMINISTER OATHS,

1. This sworn statement is submitted for WILLIAM P. HORN, PRINCIPAL
(print individual's name and title)

by WILLIAM P. HORN ARCHITECT, P.A.
(print name of entity submitting sworn statement)

whose business address is 915 EATON ST., 1224 WEST, FL. 33040

and (if applicable) its Federal Employer Identification Number (FEIN) is

65-0562195

(if the entity has no FEIN, include the Social Security Number of the individual signing this sworn statement): _____

2. I understand that a "public entity crime" as defined in Paragraph 287.133(1)(g), Florida Statutes, means a violation of any state or federal law by a person with respect to and directly related to the transaction of business with any public entity or with an agency or political subdivision of any other state or of the United States, including, but not limited to, any bid or contract for goods or services to be provided to any public entity or an agency or political subdivision of any other state or of the United States and involving antitrust, fraud, theft, bribery, collusion, racketeering, conspiracy, or material misrepresentation.
3. I understand that "conviction" as defined in Paragraph 287.133(1)(g), Florida Statutes, means a finding of guilt or a conviction of a public entity crime, with or without an adjudication of guilt, in any federal or state trial court of record relating to charges brought by indictment or information after July 01, 1989, as a result of a jury verdict, nonjury trial, or entry of a plea of guilty or nolo contendere.
4. I understand that an "affiliate" as defined in Paragraph 287.133(1)(a), Florida Statutes, means:
- a. A predecessor or successor of a person convicted of a public entity crime: or
 - b. An entity under the control of any natural person who is active in the management of the entity and who has been convicted of a public entity crime.

The term "affiliate" includes those officers, directors, executives, partners, shareholders, employees, members and agent who are active in the management of a n affiliate. The ownership by one person of shares constituting a controlling interest in another person, or a pooling of equipment of income among persons when not for fair market value under an arm's length agreement, shall be a prima facie case that one person controls another person. A person who knowingly enters into a joint venture with a person who has been convicted of a public entity crime in Florida during the preceding 36 months shall be considered an affiliate.

5. I understand that a "person" as defined in Paragraph 287.133(1)(e), Florida Statute means any natural person or entity organized under the laws of any state or of the United States with the legal power to enter into a binding contract and which bids or applies to bid on contracts for the provision of goods or services let by a public entity, or which otherwise transacts or applies to transact business with a public entity. The term "person" includes those officers, directors, executives, partners, shareholders, employees, members, and agents who are active in management of an entity.
6. Based on information and belief, the statement which I have marked below is true in relation to the entity submitting this sworn statement (indicate which statement applies).

Neither the entity submitting this sworn statement, or any of its officers, directors, executives, partners, shareholders, employees, members, or agents who are active in the management of the entity, nor any affiliate of the entity has been charged with and convicted of a public entity crime subsequent to July, 1989.

The entity submitting this sworn statement, or one or more of its officers, directors, executives, partners, shareholders, employees, members, or agents who are active in the management of the entity or an affiliate of the entity has been charged with and convicted of a public entity crime subsequent to July 01, 1989.

The entity submitting this sworn statement, or one or more of its officers, directors, executives, partners, shareholders, employees, members, or agents who are active in the management of the entity or an affiliate of the entity has been charged with and convicted of a public entity crime subsequent to July 01, 1989. However, there has been a subsequent proceeding before a Hearing Officer of the State of Florida, Division of Administrative Hearings and the Final Order entered by the Hearing Officer determined that it was not in the public interest to place the entity submitting this sworn statement on the convicted vendor list (attach a copy of the final order).

I UNDERSTAND THAT THE SUBMISSION OF THIS FORM TO THE CONTRACTING OFFICER FOR THE PUBLIC ENTITY IDENTIFIED IN PARAGRAPH ONE (1) ABOVE IS FOR THAT PUBLIC ENTITY ONLY AND, THAT THIS FORM IS VALID THROUGH DECEMBER 31 OF THE CALENDAR YEAR IN WHICH IT IS FILED. I ALSO UNDERSTAND THAT I AM REQUIRED TO INFORM THE PUBLIC ENTITY PRIOR TO ENTERING INTO A CONTRACT IN EXCESS OF THE THRESHOLD AMOUNT PROVIDED IN SECTION 287.017, FLORIDA STATUTES, FOR THE CATEGORY TWO OF ANY CHANGE IN THE INFORMATION CONTAINED IN THIS FORM.

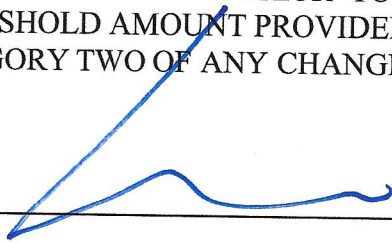

(SIGNATURE)

8/29/22

(DATE)

STATE OF Florida

COUNTY OF Monroe

PERSONALLY APPEARED BEFORE ME, the undersigned authority
William Horn who, after first being sworn by me,
(name of individual)

affixed his/her signature in the space provided above on this

29th day of Aug, 2022

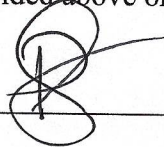

NOTARY PUBLIC

My commission expires: 11/22/25

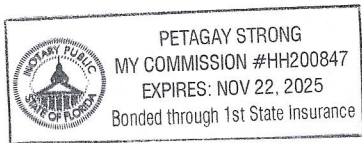

EQUAL BENEFITS FOR DOMESTIC PARTNERS AFFIDAVIT

STATE OF _____)

: SS

COUNTY OF _____)

I, the undersigned hereby duly sworn, depose and say that the firm of _____

WILLIAM P. HORN ARCHITECT, P.A.

provides benefits to domestic partners of its employees on the same basis as it provides benefits to employees' spouses, per City of Key West Code of Ordinances Sec. 2-799.

By: _____

WILLIAM P. HORN

Sworn and subscribed before me this 29th day of August 2022.

NOTARY PUBLIC, State of Florida at Large

My Commission Expires: 11/22/25

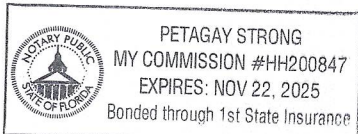

CONE OF SILENCE AFFIDAVIT

Pursuant to City of Key West Code of Ordinances Section 2-773 (attached below)

STATE OF _____)
: SS

COUNTY OF _____)

I the undersigned hereby duly sworn depose and say that all owner(s), partners, officers, directors, employees and agents representing the firm of WILLIAM P. HORN ARCHITECT, P.A. have read and understand the limitations and procedures regarding communications concerning City of Key West issued competitive solicitations pursuant to City of Key West Ordinance Section 2-773 Cone of Silence (attached). Sworn and subscribed before me this

29 day of AUGUST, 2022

WILLIAM P. HORN

NOTARY PUBLIC, State of Florida at Large

My Commission Expires: 11/22/25

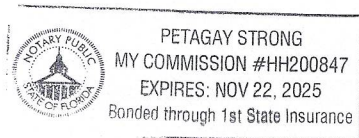

CITY OF KEY WEST INDEMNIFICATION FORM

PROPOSER agrees to protect, defend, indemnify, save and hold harmless The City of Key West, all its Departments, Agencies, Boards, Commissions, officers, City's Consultant, agents, servants and employees, including volunteers, from and against any and all claims, debts, demands, expense and liability arising out of injury or death to any person or the damage, loss of destruction of any property which may occur or in any way grow out of any act or omission of the PROPOSER, its agents, servants, and employees, or any and all costs, expense and/or attorney fees incurred by the City as a result of any claim, demands, and/or causes of action except of those claims, demands, and/or causes of action arising out of the negligence of The City of Key West, all its Departments, Agencies, Boards, Commissions, officers, agents, servants and employees. The PROPOSER agrees to investigate, handle, respond to, provide defense for and defend any such claims, demand, or suit at its sole expense and agrees to bear all other costs and expenses related thereto, even if it (claims, etc.) is groundless, false or fraudulent. The City of Key West does not waive any of its sovereign immunity rights, including but not limited to, those expressed in Section 768.28, Florida Statutes.

These indemnifications shall survive the term of this agreement. In the event that any action or proceeding is brought against the City of Key West by reason of such claim or demand, PROPOSER shall, upon written notice from the City of Key West, resist and defend such action or proceeding by counsel satisfactory to the City of Key West.

The indemnification provided above shall obligate PROPOSER to defend at its own expense to and through appellate, supplemental or bankruptcy proceeding, or to provide for such defense, at the City of Key West's option, any and all claims of liability and all suits and actions of every name and description covered above which may be brought against the City of Key West whether performed by PROPOSER, or persons employed or utilized by PROPOSER.

The PROPOSER's obligation under this provision shall not be limited in any way by the agreed upon Contract Price as shown in this agreement, or the PROPOSER's limit of or lack of sufficient insurance protection.

COMPANY SEAL

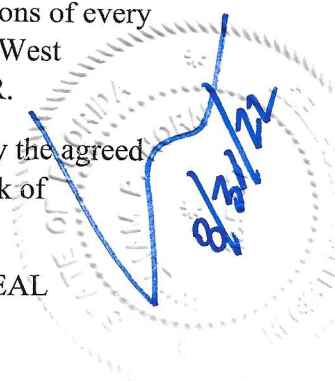

PROPOSER:

Address

WILLIAM P. HORN ARCHITECT, PA
915 BAYTON ST., KEY WEST, FL. 33640

Signature

[Handwritten Signature]

WILLIAM P. HORN

Print Name

AUGUST 31, 2022

Date

Title

PRINCIPAL

NOTARY FOR THE PROPOSER

STATE OF Florida

COUNTY OF Monroe

The foregoing instrument was acknowledged before me this 30th day of August, 2022. By William Horn (Name of officer or agent, title of officer or agent) Name of corporation acknowledging) personally known to me or has produced _____ as identification.

Nikita L. Stange

Signature of Notary



Nikita L. Stange
Notary Public
State of Florida
Comm# HH149093
Expires 7/5/2025

Return Completed form with Print, Type or Stamp Name of Notary

Supporting documents to: City of Key West Purchasing

Title or Rank

22 | RFQ #22-010

General Architectural Services

RFQ # 22-010 GENERAL ARCHITECTURAL SERVICES

RFI Addendum #1

Date: 2022.08.18

1. Could you please clarify if the City is seeking a team of professional services (including engineering, landscape architecture, surveying, etc.), or if firms should submit just for architectural services? Since the RFQ mentions to *"identify each proposed sub-consultant along with sub-consultant's type of professional services and identify sub-consultant(s) team members by name, job classification, and qualifications"*.

This RFQ is for architectural services. All firms responding need to list/identify the sub-consultants necessary to provide complete architectural services as described.

2. Can you please advise if this RFQ is replacing/renewing a previous contract and if so, what firm is the incumbent.

The last contract for general architectural services ran from 2017 to August 1st, 2022, the architecture firms included were Bender & Associates Architects, William P. Horn Architect, Saltz Michelson Architects, Inc., AMEC Foster Wheeler, PFB Architects, Rodriguez and Quiroga, K2M Design, and Hayes Cummings.

RECEIVED ADDENDUM #1

William P. Horn
8/29/22

CITY OF KEY WEST, FLORIDA

Business Tax Receipt

This Document is a business tax receipt
Holder must meet all City zoning and use provisions.
P.O. Box 1409, Key West, Florida 33040 (305) 809-3955

Business Name HORN, WILLIAM
Location Addr 915 EATON ST
Lic NBR/Class 6982 STATE LICENSED PROFESSIONAL
Issued Date 8/16/2022 **Expiration Date: September 30, 2023**

ATTORNEY, PHYSICIAN OR OTHER STATE LICENSED
PROFESSIONAL

Comments: ARCHITECT

Restrictions: DBPR #AR0013537 (2/28/23)

HORN, WILLIAM
915 EATON ST

This document must be prominently displayed.

KEY WEST, FL 33040

HORN, WILLIAM P

Ron DeSantis, Governor

Halsey Beshears, Secretary

**STATE OF FLORIDA
DEPARTMENT OF BUSINESS AND PROFESSIONAL REGULATION
BOARD OF ARCHITECTURE & INTERIOR DESIGN**

LICENSE NUMBER: AR0013537

EXPIRATION DATE: FEBRUARY 28, 2023

THE ARCHITECT HEREIN IS LICENSED UNDER THE
PROVISIONS OF CHAPTER 481, FLORIDA STATUTES

HORN, WILLIAM P
WILLIAM P HORN ARCHITECT PA
915 EATON STREET
KEY WEST FL 33040

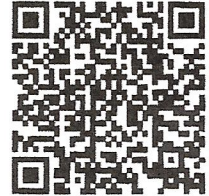

ISSUED: 11/30/2020

Always verify licenses online at MyFloridaLicense.com

Do not alter this document in any form.

This is your license. It is unlawful for anyone other than the licensee to use this document.

CERTIFICATE OF LIABILITY INSURANCE

DATE (MM/DD/YYYY)
8/17/2022

THIS CERTIFICATE IS ISSUED AS A MATTER OF INFORMATION ONLY AND CONFERS NO RIGHTS UPON THE CERTIFICATE HOLDER. THIS CERTIFICATE DOES NOT AFFIRMATIVELY OR NEGATIVELY AMEND, EXTEND OR ALTER THE COVERAGE AFFORDED BY THE POLICIES BELOW. THIS CERTIFICATE OF INSURANCE DOES NOT CONSTITUTE A CONTRACT BETWEEN THE ISSUING INSURER(S), AUTHORIZED REPRESENTATIVE OR PRODUCER, AND THE CERTIFICATE HOLDER.

IMPORTANT: If the certificate holder is an ADDITIONAL INSURED, the policy(ies) must have ADDITIONAL INSURED provisions or be endorsed. If SUBROGATION IS WAIVED, subject to the terms and conditions of the policy, certain policies may require an endorsement. A statement on this certificate does not confer any rights to the certificate holder in lieu of such endorsement(s).

PRODUCER USI Insurance Services, LLC 2502 N Rocky Point Drive Suite 400 Tampa, FL 33607	CONTACT NAME: Jackie Berrios PHONE (A/C, No, Ext): 813 321-7500 E-MAIL ADDRESS: Jackie.Berrios@usi.com	FAX (A/C, No): 813 321-7525
	INSURER(S) AFFORDING COVERAGE INSURER A : Aspen American Insurance Company	
INSURED William P. Horn, Architect, P.A. 915 Eaton Street Key West, FL 33040	INSURER B : INSURER C : INSURER D : INSURER E : INSURER F :	

COVERAGES **CERTIFICATE NUMBER:** **REVISION NUMBER:**

THIS IS TO CERTIFY THAT THE POLICIES OF INSURANCE LISTED BELOW HAVE BEEN ISSUED TO THE INSURED NAMED ABOVE FOR THE POLICY PERIOD INDICATED. NOTWITHSTANDING ANY REQUIREMENT, TERM OR CONDITION OF ANY CONTRACT OR OTHER DOCUMENT WITH RESPECT TO WHICH THIS CERTIFICATE MAY BE ISSUED OR MAY PERTAIN, THE INSURANCE AFFORDED BY THE POLICIES DESCRIBED HEREIN IS SUBJECT TO ALL THE TERMS, EXCLUSIONS AND CONDITIONS OF SUCH POLICIES. LIMITS SHOWN MAY HAVE BEEN REDUCED BY PAID CLAIMS.

INSR LTR	TYPE OF INSURANCE	ADDL INSR	SUBR WVD	POLICY NUMBER	POLICY EFF (MM/DD/YYYY)	POLICY EXP (MM/DD/YYYY)	LIMITS	
	COMMERCIAL GENERAL LIABILITY <input type="checkbox"/> CLAIMS-MADE <input type="checkbox"/> OCCUR GEN'L AGGREGATE LIMIT APPLIES PER: <input type="checkbox"/> POLICY <input type="checkbox"/> PRO-JECT <input type="checkbox"/> LOC OTHER:						EACH OCCURRENCE \$ DAMAGE TO RENTED PREMISES (Ea occurrence) \$ MED EXP (Any one person) \$ PERSONAL & ADV INJURY \$ GENERAL AGGREGATE \$ PRODUCTS - COMP/OP AGG \$ \$	
	AUTOMOBILE LIABILITY <input type="checkbox"/> ANY AUTO OWNED AUTOS ONLY <input type="checkbox"/> HIRED AUTOS ONLY <input type="checkbox"/> SCHEDULED AUTOS NON-OWNED AUTOS ONLY						COMBINED SINGLE LIMIT (Ea accident) \$ BODILY INJURY (Per person) \$ BODILY INJURY (Per accident) \$ PROPERTY DAMAGE (Per accident) \$ \$	
	UMBRELLA LIAB <input type="checkbox"/> OCCUR EXCESS LIAB <input type="checkbox"/> CLAIMS-MADE DED RETENTION \$						EACH OCCURRENCE \$ AGGREGATE \$ \$	
	WORKERS COMPENSATION AND EMPLOYERS' LIABILITY ANY PROPRIETOR/PARTNER/EXECUTIVE OFFICER/MEMBER EXCLUDED? (Mandatory in NH) If yes, describe under DESCRIPTION OF OPERATIONS below						<input type="checkbox"/> PER STATUTE <input type="checkbox"/> OTH-ER E.L. EACH ACCIDENT \$ E.L. DISEASE - EA EMPLOYEE \$ E.L. DISEASE - POLICY LIMIT \$	
A	Professional Liability			AAAE10004104	08/20/2022	08/20/2023	\$2,000,000 per claim \$2,000,000 annl aggr.	

DESCRIPTION OF OPERATIONS / LOCATIONS / VEHICLES (ACORD 101, Additional Remarks Schedule, may be attached if more space is required)
Professional Liability coverage is written on a claims-made basis.

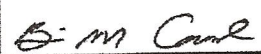
CERTIFICATE HOLDER City of Key West 1300 White Street Key West, FL 33040	CANCELLATION SHOULD ANY OF THE ABOVE DESCRIBED POLICIES BE CANCELLED BEFORE THE EXPIRATION DATE THEREOF, NOTICE WILL BE DELIVERED IN ACCORDANCE WITH THE POLICY PROVISIONS. AUTHORIZED REPRESENTATIVE 
--	--



CERTIFICATE OF LIABILITY INSURANCE

DATE (MM/DD/YYYY)
08/23/2022

THIS CERTIFICATE IS ISSUED AS A MATTER OF INFORMATION ONLY AND CONFERS NO RIGHTS UPON THE CERTIFICATE HOLDER. THIS CERTIFICATE DOES NOT AFFIRMATIVELY OR NEGATIVELY AMEND, EXTEND OR ALTER THE COVERAGE AFFORDED BY THE POLICIES BELOW. THIS CERTIFICATE OF INSURANCE DOES NOT CONSTITUTE A CONTRACT BETWEEN THE ISSUING INSURER(S), AUTHORIZED REPRESENTATIVE OR PRODUCER, AND THE CERTIFICATE HOLDER.

IMPORTANT: If the certificate holder is an **ADDITIONAL INSURED**, the policy(ies) must have **ADDITIONAL INSURED** provisions or be endorsed. If **SUBROGATION IS WAIVED**, subject to the terms and conditions of the policy, certain policies may require an endorsement. A statement on this certificate does not confer rights to the certificate holder in lieu of such endorsement(s).

PRODUCER The Fullers, Inc 1432 Kennedy Drive Key West, FL 33040 Norman Fuller 305-294-6677	CONTACT NAME: Norman Fuller PHONE (A/C, No, Ext): 305-294-6677 FAX (A/C, No): 305-294-3025 E-MAIL ADDRESS:
	INSURER(S) AFFORDING COVERAGE INSURER A: First Community Insurance Co. NAIC # 13990 INSURER B: Retail First Insurance Company INSURER C: INSURER D: INSURER E: INSURER F:

COVERAGES **CERTIFICATE NUMBER:** **REVISION NUMBER:**

THIS IS TO CERTIFY THAT THE POLICIES OF INSURANCE LISTED BELOW HAVE BEEN ISSUED TO THE INSURED NAMED ABOVE FOR THE POLICY PERIOD INDICATED. NOTWITHSTANDING ANY REQUIREMENT, TERM OR CONDITION OF ANY CONTRACT OR OTHER DOCUMENT WITH RESPECT TO WHICH THIS CERTIFICATE MAY BE ISSUED OR MAY PERTAIN, THE INSURANCE AFFORDED BY THE POLICIES DESCRIBED HEREIN IS SUBJECT TO ALL THE TERMS, EXCLUSIONS AND CONDITIONS OF SUCH POLICIES. LIMITS SHOWN MAY HAVE BEEN REDUCED BY PAID CLAIMS.

INSR LTR	TYPE OF INSURANCE	ADDL SUBR INSD WVD	POLICY NUMBER	POLICY EFF (MM/DD/YYYY)	POLICY EXP (MM/DD/YYYY)	LIMITS
A	COMMERCIAL GENERAL LIABILITY		09 0004962995 8 17	09/21/2021	09/21/2022	EACH OCCURRENCE \$ 2,000,000
	<input type="checkbox"/> CLAIMS-MADE <input type="checkbox"/> OCCUR <input checked="" type="checkbox"/> Business Owners GEN'L AGGREGATE LIMIT APPLIES PER: <input checked="" type="checkbox"/> POLICY <input type="checkbox"/> PRO-JECT <input type="checkbox"/> LOC OTHER:	DAMAGE TO RENTED PREMISES (Ea occurrence) \$ 50,000 MED EXP (Any one person) \$ 5,000 PERSONAL & ADV INJURY \$ 2,000,000 GENERAL AGGREGATE \$ 4,000,000 PRODUCTS - COMPI/OP AGG \$ 2,000,000				
	AUTOMOBILE LIABILITY					COMBINED SINGLE LIMIT (Ea accident) \$ BODILY INJURY (Per person) \$ BODILY INJURY (Per accident) \$ PROPERTY DAMAGE (Per accident) \$
	UMBRELLA LIAB OCCUR EXCESS LIAB CLAIMS-MADE					EACH OCCURRENCE \$ AGGREGATE \$
B	WORKERS COMPENSATION AND EMPLOYERS' LIABILITY		520-40146	01/01/2022	01/01/2023	PER STATUTE <input checked="" type="checkbox"/> OTH-ER E.L. EACH ACCIDENT \$ 1,000,000 E.L. DISEASE - EA EMPLOYEE \$ 1,000,000 E.L. DISEASE - POLICY LIMIT \$ 1,000,000

DESCRIPTION OF OPERATIONS / LOCATIONS / VEHICLES (ACORD 101, Additional Remarks Schedule, may be attached if more space is required)

CERTIFICATE HOLDER City of Key West PO Box 1409 Key West, FL 33040	CITYKEY	CANCELLATION SHOULD ANY OF THE ABOVE DESCRIBED POLICIES BE CANCELLED BEFORE THE EXPIRATION DATE THEREOF, NOTICE WILL BE DELIVERED IN ACCORDANCE WITH THE POLICY PROVISIONS.
		AUTHORIZED REPRESENTATIVE Norman Fuller

